

DENON

Hi-Fi Integrated Stereo Amplifier

SERVICE MANUAL

MODEL PMA-2000R

INTEGRATED STEREO AMPLIFIER

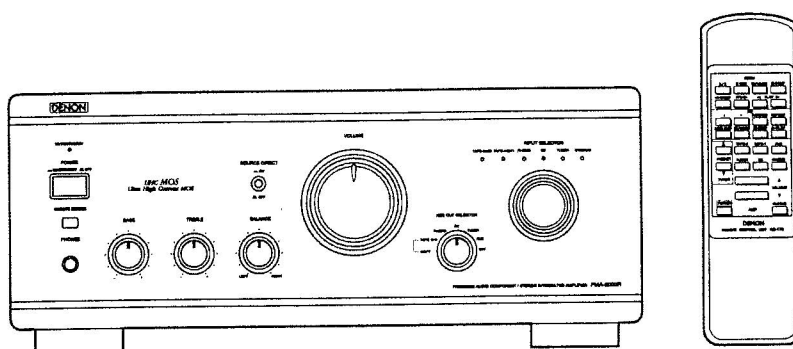

— TABLE OF CONTENTS —

OPERATING INSTRUCTIONS	2-8
SPECIFICATIONS	9
REMOVAL OF EACH SECTION	10,11
METHOD OF ADJUSTMENTS	12
BLOCK AND LEVEL DIAGRAM	13
SEMICONDUCTORS	14,15
PRINTED WIRING BOARD	16,17
NOTE FOR PARTS LIST	18
PARTS LIST OF P.W.BOARD	19-21
EXPLODED VIEW	22
PARTS LIST OF EXPLODED VIEW	23
WIRING DIAGRAM	24
SCHEMATIC DIAGRAM	25,26

• Some illustration using in this service manual is slightly different from the actual set.

NIPPON COLUMBIA CO., LTD.

OPERATING INSTRUCTIONS

— TABLE OF CONTENTS —

1	DESIGNATIONS AND FUNCTIONS OF PANEL CONTROLS	8, 9
2	CONNECTIONS	9, 10
3	OPERATION	11
4	REMOTE CONTROL OPERATION	12, 13
5	TROUBLESHOOTING	14
6	SPECIFICATIONS	15

Please check to make sure the following items are included with the main unit in the carton:

(1)	Operating instructions	1
(2)	Remote Control Unit (RC-176)	1
(3)	Batteries R6P (AA)	2
(4)	AC Power Cord	1

— INDEX —

1	FUNCIÓNES Y DENOMINACIONES DE LOS CONTROLES DE PANEL	40, 41
2	CONEXIONES	41, 42
3	OPERACION	43
4	OPERACION A CONTROL REMOTO	44, 45
5	ANTES DE SOLICITAR REPARACIONES	46
6	ESPECIFICACIONES	47

Por favor verifique asegurándose de que los siguientes artículos son empacados en la caja pero separados de la unidad principal.

(1)	Manual de instrucciones	1
(2)	Unidad de control remoto (RC-176)	1
(3)	Pilas R6P (AA)	2
(4)	Cable de corriente CA	1

— INHALT —

1	BEZEICHNUNGEN UND FUNKTIONEN DER BEDIENUNGSELEMENTE	16, 17
2	ANSCHLÜSSE	17, 18
3	BETRIEB	19
4	FERNBEDIENUNG	20, 21
5	FEHLERSUCHE	22
6	TECHNISCHE DATEN	23

Bitte überprüfen Sie, ob die folgenden Teile vollständig in der Verpackung enthalten sind:

(1)	Bedienungsanleitung	1
(2)	Fernbedienung (RC-176)	1
(3)	Batterien vom Typ R6P (AA)	2
(4)	AC-Netzkaabel	1

— TABLE DES MATIERES —

1	NOMENCLATURE ET FONCTIONS DES COMMANDES DE PANNEAU	24, 25
2	CONNEXIONS	25, 26
3	FONCTIONNEMENT	27
4	UTILISATION DE LA TELECOMMANDE	28, 29
5	DEPISTAGE DES PANNES	30
6	SPECIFICATIONS	31

Veuillez contrôler que les articles suivants sont bien joints à l'appareil principal dans le carton:

(1)	Mode d'emploi	1
(2)	Unité de télécommande (RC-176)	1
(3)	Piles R6P (AA)	2
(4)	Cordon électrique AC	1

— INDICE —

1	DESIGNAZIONE E FUNZIONAMENTO DEI CONTROLLI DEL PANNELLO	32, 33
2	CONNESSIONI	33, 34
3	FUNZIONAMENTO	35
4	FUNZIONAMENTO DEL TELECOMANDO	36, 37
5	LOCALIZZAZIONE DEI GUASTI	38
6	SPECIFICAZIONI	39

Controllare che le parti seguenti si trovino imballate con l'apparecchio nella scatola di spedizione.

(1)	Libretto delle istruzioni	1
(2)	Telecomando (RC-176)	1
(3)	Batterie R6P (AA)	2
(4)	Filo di alimentazione CA	1

CAUTION

RISK OF ELECTRIC SHOCK

DO NOT OPEN

CAUTION: TO REDUCE THE RISK OF ELECTRIC SHOCK, DO NOT REMOVE COVER (OR BACK). NO USER SERVICEABLE PARTS INSIDE. REFER SERVICE-ING TO QUALIFIED SERVICE PERSONNEL.

The lightning flash with arrowhead symbol, within an equilateral triangle, is intended to alert the user to the presence of uninsulated "dangerous voltage" within the product's enclosure that may be of sufficient magnitude to constitute a risk of electric shock to persons.

The exclamation point within an equilateral triangle is intended to alert the user to the presence of important operating and maintenance (servicing) instructions in the literature accompanying the appliance.

WARNING: TO REDUCE THE RISK OF FIRE OR ELECTRIC SHOCK, DO NOT EXPOSE THIS APPLIANCE TO RAIN OR MOISTURE.

● FOR U.S.A. & CANADA MODEL ONLY

CAUTION

TO PREVENT ELECTRIC SHOCK DO NOT USE THIS (POLARIZED)/PLUG WITH ANY EXTENSION CORD, RECEPTACLE OR OTHER OUTLET EXPOSURE

● POUR LE MODELE CANADIEN UNIQUEMENT

ATTENTION

POUR PREVENIR LES CHOC ELECTRIQUES NE PAS UTILISER CETTE FICHE POLARISEE AVEC UN PROLONGATEUR UNE PRISE DE COURANT OU UNE AUTRE SORTIE DE COURANT SAUF SI LES LAMES PEUVENT ETRE INSEREES A FOND SANS EN LAISSER AUCUNE PARTIE A DECOUVERT

● DECLARATION OF CONFORMITY

We declare under our sole responsibility that this product, in which the declaration recites, is in conformity with the following standards: EN60065, EN55013, EN55020, EN60555-2 and EN60555-3. Following the provisions of 73/23/EEC, 89/336/EEC and 93/68/EEC Directives.

● ÜBEREINSTIMMUNGSERKLÄRUNG

Wir erklären unter unserer Verantwortung, daß dieses Produkt, auf das diese Erklärung bezieht, den folgenden Standards entspricht: EN60065, EN55013, EN55020, EN60555-2 und EN60555-3. Entsprechend den Bestimmungen der Direktive 73/23/EEC, 89/336/EEC und 93/68/EEC.

● DECLARATION DE CONFORMITE

Nous déclarons sous notre seule responsabilité que l'appareil, auquel se réfère cette déclaration, est conforme aux standards suivants: EN60065, EN55013, EN55020, EN60555-2 et EN60555-3. D'après les dispositions de la Directive 73/23/EEC, 89/336/EEC et 93/68/EEC.

● DICHIARAZIONE DI CONFORMITA

Dichiaro con piena responsabilità che questo prodotto, al quale la nostra dichiarazione si riferisce, è conforme alle seguenti normative: EN60065, EN55013, EN55020, EN60555-2 e EN60555-3. In conformità con le condizioni delle direttive 73/23/EEC, 89/336/EEC e 93/68/EEC. QUESTO PRODOTTO E' CONFORME AL D.M. 28/09/95 N. 549

● DECLARACIÓN DE CONFORMIDAD

Declaramos bajo nuestra exclusiva responsabilidad que este producto al que se refiere esta declaración, está conforme con los siguientes estándares: EN60065, EN55013, EN55020, EN60555-2 y EN60555-3. Siguiendo las provisiones de las Directivas 73/23/EEC, 89/336/EEC y 93/68/EEC.

● EENVORMIGHEIDSVERKLARING

Wij verklaaren uitdrukkelijk op onze verantwoordelijkheid dat dit product, waarop deze verklaring betrekking heeft, in overeenstemming is met de volgende normen: EN60065, EN55013, EN55020, EN60555-2 en EN60555-3. Volgens de bepalingen van de Richtlijnen 73/23/EEC, 89/336/EEC en 93/68/EEC.

● ÖVERENSÄMMELSEINTYG

Härmed intygats, helt på eget ansvar att denna produkt, vilken detta intyg avser, uppfyller följande standarder: EN60065, EN55013, EN55020, EN60555-2 och EN60555-3. Enligt bestämmelserna i direktiv 73/23/EEC, 89/336/EEC och 93/68/EEC.

● DECLARAÇÃO DE CONFORMIDADE

Declaramos sob a nossa responsabilidade que este produto, ao qual esta declaração se refere, está em conformidade com as seguintes normas: EN60065, EN55013, EN55020, EN60555-2 e EN60555-3. De acordo com o estabelecido nas Directivas 73/23/EEC, 89/336/EEC e 93/68/EEC.



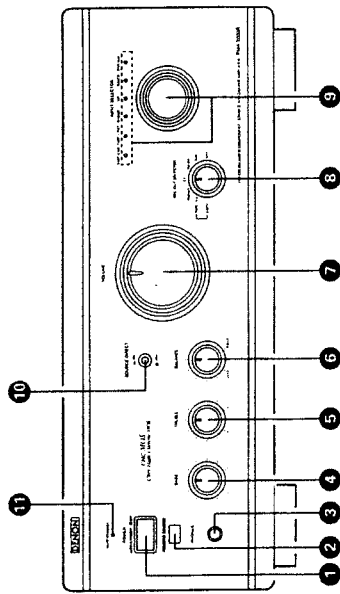

FRONT PANEL
FRONTPLATTE
PANNÉAU AVANT
PANNELLO ANTERIORE

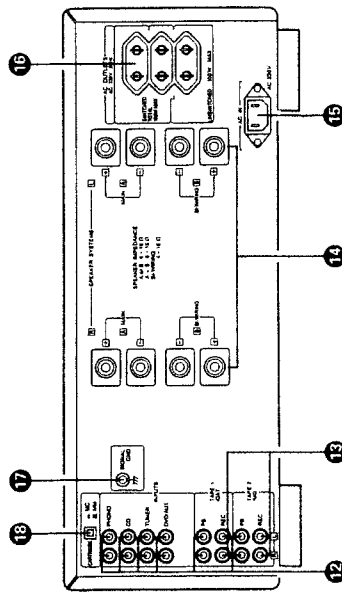

REAR PANEL
RÜCKWAND
PANNÉAU ARRIERE
PANNELLO POSTERIORE

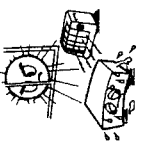

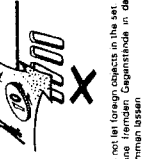
NOTE ON USE / HINWEISE ZUM GEBRAUCH / OBSERVATIONS RELATIVES A L'UTILISATION
NOTE SULL'USO / NOTAS SOBRE EL USO / ALVORENS TE GEBRUIKEN / OBSERVERA
OBSERVAÇÕES QUANTO AO USO

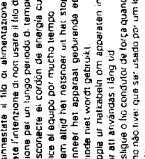
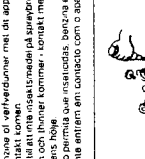
 <ul style="list-style-type: none"> • Avoid high temperatures. Allow for sufficient heat dissipation when installed on a rack. • Bechtien Sie die eine ausreichende Luftzirkulation gewährleisten wird, wenn das Gerät auf ein Regal gestellt wird. • Tenir compte d'une dissipation de chaleur suffisante lors de l'installation sur une armoire. • Evitare di esporre l'unità a temperature alte. • Assicurarsi che ci sia un'adeguata dissipazione di calore quando installata l'unità in un rack. • Evite altas temperaturas. • Permitir la suficiente dispersión del calor cuando está instalado en la consola. • Zorg voor voldoende afvoer van warmte het apparaat op een rek wordt geplaatst. • Ungvik høge temperaturer. • Se a temperatura adequada quando instalar o equipamento for instalado numa prateleira. • Conceder suficiente dispersión de calor cuando o equipamento for instalado numa prateleira. 	 <ul style="list-style-type: none"> • Keep the set free from moisture, water and dust. • Halten Sie das Gerät von Feuchtigkeit, Wasser und Staub fern. • Pluie de l'eau ou de la poussière sur le matériel est à proscrire. • Tenete l'unità lontana dall'umidità, dall'acqua e dalla polvere. • Mantenga el equipo libre de humedad, agua y polvo. • Laat geen vochtigheid, water of stof in het apparaat vallen. • Utsätt inte apparaten för fukt, vatten och damm. • Mantenha o aparelho livre de qualquer umidade, água ou pó. 	 <ul style="list-style-type: none"> • Do not let foreign objects in the set. • Keine fremden Gegenstände in das Gerät lassen. • Ne pas laisser des objets étrangers dans l'appareil. • E' importante che nessun oggetto è inserito all'interno dell'unità. • Keine fremden Gegenstände ins Gerät einlegen. • Let geen vreemde voorwerpen in of op het apparaal vallen. • Se til utlånnele foremler inte tilnges i apparaten. • Não permita que objetos estranhos no aparelho. • No debe permitir que objetos extraños no aparato.
 <ul style="list-style-type: none"> • Hold the power cord carefully. • Greifen Sie vorsichtig mit dem Netzstecker am Steckplatz des Gerätes an. • Manipuler le cordon d'alimentation avec précaution. • Maneggiare il filo di alimentazione con cautela. • Maneggiare il filo di alimentazione con cura. • Agite per la presa quando collegare il cavo alla presa. • De la fuerza cuando conecte el cable de energía a la toma. • Sustinga el enchufe cuando desconecte el cordón de energía. • Håll strömkabeln försiktigt. • Mantenha o cabo de energia com cuidado. • Håll strömlinjen försiktigt när du uttagar strömkabeln från uttaget. • Segure a tomada ao desconectar o fio. 	 <ul style="list-style-type: none"> • Unplug the power cord when not using the set for long periods of time. • Wenn das Gerät eine längere Zeit nicht verwendet werden soll, ziehen Sie das Netzkabel vom Netzstecker. • Débranchez le cordon d'alimentation lorsque l'appareil n'est pas utilisé pendant de longues périodes. • Disconnetta il filo di alimentazione quando non usate il filo di alimentazione per lunghi periodi. • Niem aliqd het netzezet, en het stopcontact van het apparaat loskoppelen een lange tijd. • Koppla ur nätströmlin om apparaten inte kommer att användas i lång tid. • Desligue o fio condutor de força quando o aparelho não for usado por um longo período. 	 <ul style="list-style-type: none"> • Never disassemble or modify the set in any way. • Das Gerät darf nicht zerlegt werden. • Ne jamais démonter ou modifier l'appareil d'une manière ou d'une autre. • Never disassemble or modify the set in any way. • Nunca desarme o modifique el equipo de ninguna manera. • Never disassemble or modify the set in any way. • Ta me jar apparaten och lösak inte bygg till den. • Não permita que o aparelho seja desmontado ou modificado de alguma forma. • No debe desarmar o modificar de alguna forma.

SAFETY INSTRUCTIONS

1. Read instructions - All the safety and operating instructions should be read before the appliance is operated.
2. Retain instructions - The safety and operating instructions should be retained for future reference.
3. Head Warnings - All warnings on the appliance and in the operating instructions should be adhered to.
4. Follow instructions - All operating and use instructions should be followed.
5. Water and Moisture - The appliance should not be used near water - for example, near a bathtub, washbowl, swimming pool, and the like.
6. Carts and Stands - The appliance should be used only with a cart or stand that is recommended by the manufacturer.
- 6A. An appliance and cart combination should be moved with care. Quick stops, excessive force, and uneven surfaces may cause the appliance and cart combination to overturn.
7. Wall or Ceiling Mounting - The appliance should be mounted to a wall or ceiling only as recommended by the manufacturer.
8. Ventilation - The appliance should be situated so that its location or position does not interfere with its proper ventilation. For example, the appliance should not be situated on a bed, sofa, rug, or similar surface that may block the ventilation openings or placed in a built-in installation, such as a bookcase or cabinet that may impede the flow of air through the ventilation openings.
9. Heat - The appliance should be situated away from heat sources such as radiators, heat registers, stoves, or other appliances including amplifiers that produce heat.
10. Power Sources - The appliance should be connected to a power supply only of the type described in the operating instructions or as marked on the appliance.
11. Grounding or Polarization - Precautions should be taken so that the grounding or polarization means of an appliance is not defeated.
12. Power-Cord Protection - Power-supply cords should be protected so that they are not likely to be walked on or run over by items placed upon or against them, paying particular attention to cords at plugs, convenience receptacles, and the point where they exit from the appliance.
14. Cleaning - The appliance should be cleaned only as recommended by the manufacturer.
15. Power Lines - An outdoor antenna should be located away from power lines.
16. Outdoor Antenna Grounding - If an outside antenna is connected to the receiver, be sure the antenna system is grounded so as to provide some protection against voltage surges and built-up static charges. Article 810 of the National Electrical Code, ANSI/NFPA 70, provides information with regard to proper grounding of the mast and supporting structure, grounding of the lead-in wire to an antenna-discharge unit, size of grounding conductors, location of antenna-discharge unit, connection to grounding electrodes, and requirements for the grounding electrode. See Figure A.
17. Nonuse Periods - The power cord of the appliance should be unplugged from the outlet when left unused for a long period of time.
18. Object and Liquid Entry - Care should be taken so that objects do not fall and liquids are not spilled into the enclosure through openings.
19. Damage Requiring Service - The appliance should be serviced by qualified service personnel when:
 - A. The power-supply cord or the plug has been damaged, or
 - B. Objects have fallen, or liquid has been spilled into the appliance, or
 - C. The appliance has been exposed to rain, or
 - D. The appliance does not appear to operate normally, or exhibits a marked change in performance, or
 - E. The appliance has been dropped, or the enclosure damaged.
20. Servicing - The user should not attempt to service the appliance beyond that described in the operating instructions. All other servicing should be referred to qualified service personnel.

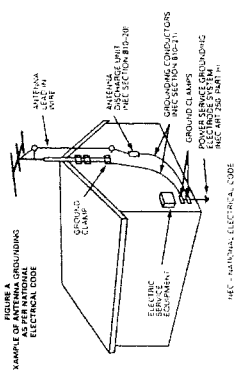

NOTA:
 1. Mantenga siempre activado el interruptor de alimentación (POWER) en la unidad principal.
 2. Encienda y apague el equipo desde la unidad de control remoto.
 3. Cuando la unidad vaya a estar fuera de uso por un periodo prolongado de tiempo, desconecte el cable de alimentación.

PRECAUCIONES:
 Si solo el LED MUTE/STANDBY (silenciamiento/estado de esta encendido) se apaga o si la alimentación de la sede desconecta desde la unidad de control remoto, asegure cada conexión de alimentación desde la unidad de control remoto.
OPMERKING:
 1. Zorg er altijd voor dat de stroomvoorziening (POWER) van het hoofdapparaat in de ingeschakelde stand staat.
 2. Zet de stroom in en uit met de afstandsbediening.
 3. Trek de stroom uit het apparaat, indien het apparaat gedurende een lange periode niet te gebruiken.

WAARSCHUWING:
 Als alleen MUTE/STANDBY (LED) (silencio/stand-by) of de afstandsbediening niet werkt, controleer de aansluitingen van de voedingskabel op de afstandsbediening.
OBSERVERA:
 1. Ut alltid strömmanter (POWER) på huvudenheten vara påslagen.
 2. Stäng av och påslätt apparaten med hjälp av fjärrkontrollen.
 3. Koppla loss strömkabeln om apparaten inte skall användas under lång tid.

VARNING:
 Om endast MUTE/STANDBY-LED (tystläge/standby) eller avlägsnadenheten inte fungerar, kontrollera anslutningarna för strömkabeln till fjärrkontrollen igen.
NOTA:
 1. Mantiene o interruptor de Corrente (POWER) na unidade principal sempre ligado.
 2. Desligue e ligue o aparelho a partir da unidade de controle remoto.
 3. Desligue o fio de força elétrica, quando não utilizar o aparelho por longo tempo.

CAUTELA:
 Se apenas o led de MUTE/STANDBY, o aparelho, o aparelho que se conecta esta designada a partir da unidade de controle remoto, e que o controle a partir da unidade de controle remoto.
PRECAUCIONES A TOMAR DURANTE LA INSTALACION:
 Para que el cable se deslice, debe por lo menos 10 cm de espacio entre las partes superior, posterior y laterales de esta unidad y la pared u otras componentes.
VOORZORGSAANBEVELINGEN VOOR INSTALLATIE:
 Laat voor een goede werkmethode minstens 10 cm ruimte tussen de boven-, achter- en zijwanden van de kast en de muur of andere elementen.
OBSERVERA VID INSTALLATIONEN:
 För god värmeväxling, bör du lämna ett utrymme på minst 10 cm mellan bak- botten och på sidorna av apparaten och väggen eller andra komponenter.
PRECAUCOES DE INSTALACAO:
 Para a desobstrução do calor, deixar pelo menos 10 cm de espaço entre o topo, a parte de trás e os lados desta unidade e a parede ou outros componentes.

NOTA:
 1. Siempre mantener el interruptor de la corriente (POWER) en la unidad principal encendida.
 2. Accender e apagar el equipo desde la unidad de control remoto.
 3. Cuando el equipo vaya a estar fuera de uso por un periodo prolongado de tiempo, desconecte el cable de alimentación.
PRECAUCIONES:
 Si solo el LED MUTE/STANDBY (silencio/estado de esta encendido) se apaga o si la alimentación de la sede desconecta desde la unidad de control remoto, asegure cada conexión de alimentación desde la unidad de control remoto.
OPMERKING:
 1. Zorg er altijd voor dat de stroomvoorziening (POWER) van het hoofdapparaat in de ingeschakelde stand staat.
 2. Zet de stroom in en uit met de afstandsbediening.
 3. Trek de stroom uit het apparaat, indien het apparaat gedurende een lange periode niet te gebruiken.
WAARSCHUWING:
 Als alleen MUTE/STANDBY (LED) (silencio/stand-by) of de afstandsbediening niet werkt, controleer de aansluitingen van de voedingskabel op de afstandsbediening.
OBSERVERA:
 1. Ut alltid strömmanter (POWER) på huvudenheten vara påslagen.
 2. Stäng av och påslätt apparaten med hjälp av fjärrkontrollen.
 3. Koppla loss strömkabeln om apparaten inte skall användas under lång tid.
VARNING:
 Om endast MUTE/STANDBY-LED (tystläge/standby) eller avlägsnadenheten inte fungerar, kontrollera anslutningarna för strömkabeln till fjärrkontrollen igen.
NOTA:
 1. Mantiene o interruptor de Corrente (POWER) na unidade principal sempre ligado.
 2. Desligue e ligue o aparelho a partir da unidade de controle remoto.
 3. Desligue o fio de força elétrica, quando não utilizar o aparelho por longo tempo.

CAUTION:
 If only the MUTE/STANDBY LED is lit, this means that the power is turned off from the remote control unit. Turn the power on from the remote control unit.
HINWEIS:
 1. Wenn nur das MUTE/STANDBY-LED leuchtet, bedeutet dies, daß der Strom vom Fernbedienungsgerät aus ausgeschaltet worden ist. Schalten Sie den Strom vom Fernbedienungsgerät aus ein.
REMARQUE:
 1. Si seul l'indicateur MUTE/STANDBY est allumé, cela signifie que l'alimentation a été coupée depuis la télécommande. Mettre sous tension avec la télécommande.
ATTENTION:
 Si seul l'indicateur MUTE/STANDBY est allumé, cela signifie que l'alimentation a été coupée depuis la télécommande. Mettre sous tension avec la télécommande.

NOTA:
 1. Siempre mantener el interruptor de la corriente (POWER) en la unidad principal encendida.
 2. Accender e apagar el equipo desde la unidad de control remoto.
 3. Cuando el equipo vaya a estar fuera de uso por un periodo prolongado de tiempo, desconecte el cable de alimentación.
PRECAUCIONES:
 Si solo el LED MUTE/STANDBY (silencio/estado de esta encendido) se apaga o si la alimentación de la sede desconecta desde la unidad de control remoto, asegure cada conexión de alimentación desde la unidad de control remoto.
OPMERKING:
 1. Zorg er altijd voor dat de stroomvoorziening (POWER) van het hoofdapparaat in de ingeschakelde stand staat.
 2. Zet de stroom in en uit met de afstandsbediening.
 3. Trek de stroom uit het apparaat, indien het apparaat gedurende een lange periode niet te gebruiken.
WAARSCHUWING:
 Als alleen MUTE/STANDBY (LED) (silencio/stand-by) of de afstandsbediening niet werkt, controleer de aansluitingen van de voedingskabel op de afstandsbediening.
OBSERVERA:
 1. Ut alltid strömmanter (POWER) på huvudenheten vara påslagen.
 2. Stäng av och påslätt apparaten med hjälp av fjärrkontrollen.
 3. Koppla loss strömkabeln om apparaten inte skall användas under lång tid.
VARNING:
 Om endast MUTE/STANDBY-LED (tystläge/standby) eller avlägsnadenheten inte fungerar, kontrollera anslutningarna för strömkabeln till fjärrkontrollen igen.
NOTA:
 1. Mantiene o interruptor de Corrente (POWER) na unidade principal sempre ligado.
 2. Desligue e ligue o aparelho a partir da unidade de controle remoto.
 3. Desligue o fio de força elétrica, quando não utilizar o aparelho por longo tempo.

PRECAUCIONES A TOMAR DURANTE LA INSTALACION:
 Para que el cable se deslice, debe por lo menos 10 cm de espacio entre las partes superior, posterior y laterales de esta unidad y la pared u otras componentes.
VOORZORGSAANBEVELINGEN VOOR INSTALLATIE:
 Laat voor een goede werkmethode minstens 10 cm ruimte tussen de boven-, achter- en zijwanden van de kast en de muur of andere elementen.
OBSERVERA VID INSTALLATIONEN:
 För god värmeväxling, bör du lämna ett utrymme på minst 10 cm mellan bak- botten och på sidorna av apparaten och väggen eller andra komponenter.
PRECAUCOES DE INSTALACAO:
 Para a desobstrução do calor, deixar pelo menos 10 cm de espaço entre o topo, a parte de trás e os lados desta unidade e a parede ou outros componentes.

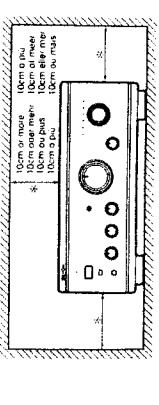
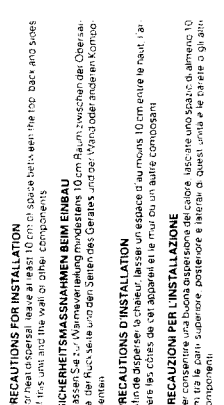

Cautions on Connections

- Do not plug in the power cord until all connections are completed.
- Be sure to connect the left and right channels properly.
- Insert the plugs securely. Incomplete connections can result in noise.
- Use the SWITCHED AC OUTLETS to plug in audio components. Do not use them for hair drivers or other appliances.

- Note that plugging the pin plug cords next to power cords or near power transformers may result in humming or other noise.
- The PHONO input jacks have an extremely high sensitivity. To avoid turning up the volume when no pin plug cords are connected. Doing so may damage the amplifier. Therefore, if the speaker's terminal pin plug cords are not connected, insert the included short-circuit pin plug.

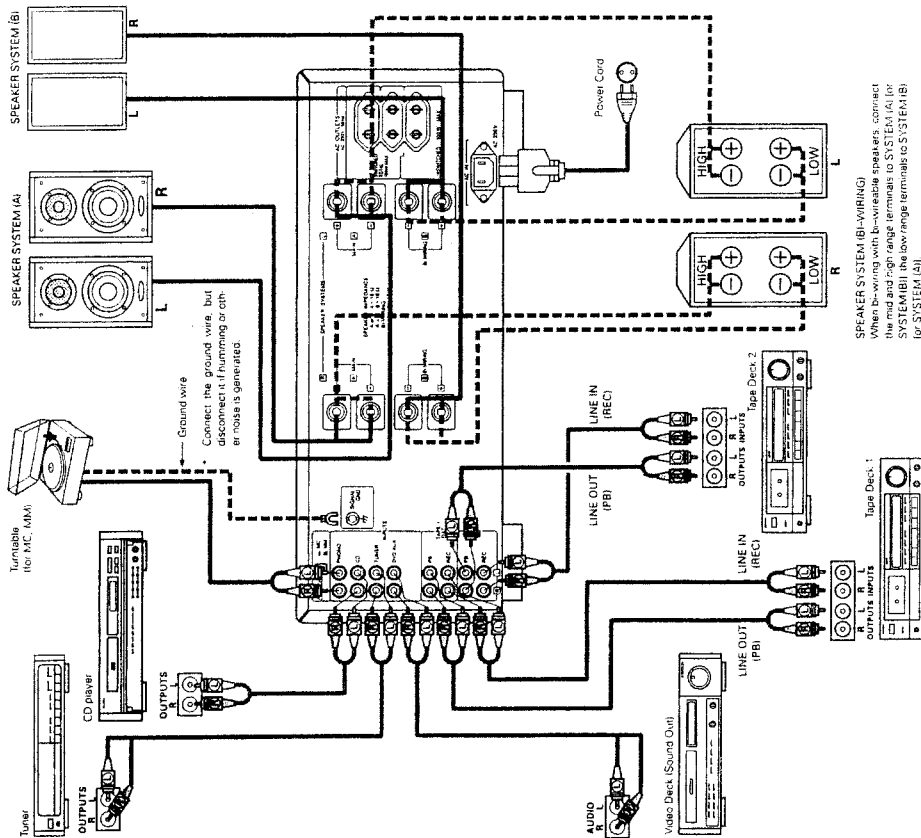

SPEAKER SYSTEM (B)-WIRING
When bi-wiring with bi-wireable speakers, connect the mid and high range terminals to SYSTEM (A), or SYSTEM (B), the low range terminals to SYSTEM (B) or SYSTEM (A).

3 OPERATION (Refer to Page 5)

PREPARATION

1. CHECKING CONNECTIONS

- Make sure that all the connections are proper by referring to the rear panel.
- Check the polarity (positive and negative) of connections, and the direction of stereo separation (right cord to right channel terminal, and left cord to left channel terminal).
- Check the direction of pin cord connection.

2. SETTING OF EACH KNOB

- Turn the volume control knob 7 counter-clockwise to minimum position.
- Set the tape knob 4, 5, 6 to center position.
- Set SOURCE DIRECT 10 to "OFF (■)".

After checking the above items, turn on the power; the amplifier is set in the ready mode in a few seconds.

PLAYING A RECORD

1. Set the CARTRIDGE selection switch 11 "MC (■)" or "MM (■)".
2. Set the INPUT SELECTOR switch 9 to "PHONO".
3. Operate the turntable and play the record.
4. Turn the volume 7 and tone controls 4, 5, 6 to yield an appropriate volume and sound quality.

PLAYBACK OF CD PLAYER

1. Set the INPUT SELECTOR switch 9 to "CD".
2. Operate the CD player.
3. Turn the volume 7 and tone controls 4, 5, 6 to yield an appropriate volume and sound quality.

RECEPTION OF RADIO PROGRAMS

1. Set the INPUT SELECTOR switch 9 to "TUNER".
2. Operate the tuner to receive a radio program.
3. Turn the volume 7 and tone controls 4, 5, 6 to yield an appropriate volume and sound quality.

CONNECTIONS OF AUDIO EQUIPMENT TO AUX TERMINALS

1. Set the INPUT SELECTOR switch 9 to "DVD/AUX" position.
2. Operate the Audio equipment Systems.
3. Turn the volume 7 and tone controls 4, 5, 6 to yield an appropriate volume and sound quality.

PLAYBACK WITH TAPE DECK

1. Set the INPUT SELECTOR switch 9 to "TAPE-1/DAT" or "TAPE-2/MD".
2. Operate the Tape Deck.
3. Turn the volume 7 and tone controls 4, 5, 6 to yield an appropriate volume and sound quality.

RECORDING WITH TAPE DECK

1. Set the REC OUT SELECTOR switch 8 to the program source you wish to record.
 2. Start the playback of the program source.
 3. Start recording with the component connected to "TAPE-1/DAT" or "TAPE-2/MD".
- In the PMA-2000R, the REC OUT signal and the speaker (head-phones) signal are output via separate circuits so that knobs and switches related to the tone and volume have no effect whatsoever on the sound that is recorded. Also, since the recording function is selected by the REC OUT SELECTOR switch 8, the free program source can be played through the speakers (or headphones) even during recording.

MONITORING THE RECORDING

A recording in progress can be monitored if a tape deck with three individual heads for recording and playback is used. A tape deck in which a common head is used for both recording and playback cannot be used to monitor recording. When a recording is being made using TAPE-1/DAT, selecting TAPE-1/DAT with the INPUT SELECTOR will engage the RECORDING MONITOR and permit a check of the recording condition.

COPYING FROM ONE TAPE TO ANOTHER

To copy from TAPE-1/DAT to TAPE-2/MD, set the REC OUT SELECTOR switch 8 to "TAPE-1 ▶ 2".

NOTE:
Copying is not possible from TAPE-2/MD to TAPE-1/DAT.

NOTE:

- This amplifier has a full memory back-up system. When the power is turned on, INPUT SELECTOR 9 are set to the last mode set before the power was turned off.

1 DESIGNATIONS AND FUNCTIONS OF PANEL CONTROLS (Refer to Page 6)

- 1 POWER Switch**
When the power switch is turned ON (I), the MUTE / STANDBY LED (1) lights.
When the power switch is turned ON, power is supplied to the unit. It takes a few seconds after the power is turned on for the unit to warm up. This is due to the built-in muting circuit that eliminates noise during the on/off operation.
- 2 REMOTE SENSOR (Remote Control Sensor)**
This sensor receives the infra-red light transmitted from the wireless remote control unit.
For remote control, point the wireless remote control unit towards the sensor.
- 3 PHONES (Headphone Jack)**
This jack is used to plug in the headphones.
(The SPEAKER output is turned off when the headphones are plugged in.)
To prevent hearing loss, do not raise the volume level excessively when using headphones.
- 4 BASS (Bass Control)**
This knob is used to control the bass quality of the sound. When the knob is set at the center position, the frequency characteristics are balanced in the range below 1000 Hz. The bass is emphasized as the knob is moved off center to the right (R), and reduced as it is moved to the left (L).
- 5 TREBLE (Treble Control)**
This knob is used to control the treble quality of the sound. When the knob is set at the center position, the frequency characteristics are balanced in the range above 1000 Hz. The treble is emphasized as the knob is moved off center to the right (R), and reduced as it is moved to the left (L).
- 6 BALANCE (Balance Control)**
This knob is used to adjust the balance between the left and right channels. When it is set to the center position, the amplitude of the amplifier is equal on both sides. If there is a difference in the left and right channel output voltages for a cartridge, move the knob to the left and the right to adjust it. If the volume on the right side is too low, turn the knob to the right (R). If the volume on the left side is too low, turn the knob to the left (L). This will achieve an even balance on the left and right sides.
- 7 VOLUME (Volume Control)**
This knob controls the overall volume level.
Turn the knob to the right (R) to raise the volume and to the left (L) to lower it.
- 8 REC. OUT SELECTOR (Recording Output Selector)**
Use this to select the output source for recording onto a tape deck, etc.
You can copy TAPE-1/DAT source to the tape deck connected to the TAPE-2/IMD terminals.
 - **OFF:** In this position, the recording output is turned off. For higher quality playback sound, we recommend keeping this selector at this position when not recording.

12 INPUTS terminals

These are input terminals for CD players, turntables, AM/FM tuners, tape decks or other playback components.

NOTE:
The PHONO input terminals are equipped with a short pin-plug. Remove this plug to connect a record player. Store the removed short pin-plug in a safe place so as not to lose it.

13 TAPE REC (recording output) terminals

These are recording output terminals for connection to tape decks.

14 SPEAKER SYSTEMS terminals

Connect the speaker systems here.

15 AC IN connector

Connect the included AC power cord here.
Do not use any other cord than the provided AC power cord.

16 AC OUTLETS

- AC outlets are used for connecting amplifier component units, such as tuner, turntable, tape deck, etc.
- **SWITCHED:** Total capacity: 100 W.
These outlets are turned ON/OFF when main power switch is turned on/off.
- **UNSWITCHED:** Capacity: 100 W.
This outlet is always ON, whether power switch is on or off.

17 SIGNAL GND (ground) terminal

Connect the turntable's ground wire here.

NOTE:
This terminal is used to reduce noise when a turntable, etc., is connected.
It does not provide complete grounding.

18 CARTRIDGE (Cartridge Selection Switch)

This switch is set according to the type of player cartridge to be used.
Set this switch to MM (I) or MC (II) according to the type of cartridge used on your turntable.

2 CONNECTIONS

Connecting the speakers

- **Speaker impedance**
 - When using speaker systems A and B separately, speakers with an impedance of 4 to 16 Ω/ohms can be connected.
 - When using speaker systems with bi-wireable speaker, speakers with an impedance of 4 to 16 Ω/ohms can be connected.
 - Note that when using two sets of speaker systems together (A + B), using speakers with an impedance other than between 8 to 16 Ω/ohms can result in damage.
- **Note** that this unit is not equipped with a switch for selecting the speaker system. The A and B speaker output terminals are connected in parallel.
- The protective circuit may be activated if speakers with other impedances are connected.
- Be sure to connect the cords between the speaker terminals and speaker systems with the same polarities (⊕ to ⊕, ⊖ to ⊖). If not, the central sound will be weak and the position of the different instruments will not be clear, diminishing the stereo effect.
- When connecting the speakers, be sure that the core wires of the speaker cords do not stick out from the terminals and touch other terminals, each other or the rear panel.
- Connecting the speaker cords
 - 1 Peel off the sheathing from the end of the cord
 - 2 Twist the core wires.
 - 3 Turn the speaker terminal counterclockwise to loosen it.
 - 4 Insert the core wires entirely, then turn the terminal clockwise to tighten it.

CAUTION

Protective Circuit
This circuit is equipped with a high speed protective circuit. This circuit protects the internal circuitry from damage due to large currents flowing when the speaker jacks are not completely connected or when an output is generated by a short circuit. This protective circuit's operation cuts off the output to the speakers. In such a case, be sure to turn the power to the set off and check the connections to the speakers. Then turn the power on again. After muting for several seconds, the set will operate normally.

NOTE:
NEVER touch the speaker terminals when the power is on. Doing so could result in electric shocks.

5 TROUBLESHOOTING

Check the following before assuming there is a problem with the set.

1. Are all connections proper?
 2. Is the set being operated as described in the operating instructions?
 3. Are the speakers and input components being operated properly?
- If the set does not seem to be operating properly, check the points listed below. If these points do not apply, the set may be damaged. Turn off the power immediately and contact your store of purchase.

Symptom	Cause	Measures	Page	
MUTE/STANDBY LED does not light and no sound is produced when POWER switch is turned on.	<ul style="list-style-type: none"> • Power cord is not connected 	<ul style="list-style-type: none"> • Check that the cord is plugged in. 	10	
MUTE/STANDBY LED lights but no sound is produced	<ul style="list-style-type: none"> • Speaker cords not properly connected. • INPUT SELECTOR not set to proper position. • VOLUME control turned down 	<ul style="list-style-type: none"> • Connect securely. • Set to the proper position. • Set to an appropriate level. 	9, 10 8, 11	
Sound is not produced from one side only	<ul style="list-style-type: none"> • Speaker cords not properly connected. • Input cords not properly connected. • Left/right balance improperly adjusted. 	<ul style="list-style-type: none"> • Connect securely. • Connect securely. • Adjust the BALANCE control. 	9, 10 10 8, 11	
Volume level is different when listening to tuner and records.	<ul style="list-style-type: none"> • Tuner and record outputs different 	<ul style="list-style-type: none"> • Adjust the tuner output to the turntable's output (if the tuner is equipped with an output control). 	—	
Positions of instruments inverted for stereo sources	<ul style="list-style-type: none"> • Left and right speakers or input cords inverted 	<ul style="list-style-type: none"> • Check the left/right connections 	9, 10	
Booming sound produced when playing records	<ul style="list-style-type: none"> • Turntable's ground wire not connected. • Input cords not properly connected to PHONO terminals. • Influence from a TV or VCR near the turntable 	<ul style="list-style-type: none"> • Connect securely • Connect securely. • Change the position of installation. 	10 10	
Howling produced when volume is turned up while playing records.	<ul style="list-style-type: none"> • Turntable and speaker systems are too close • Floor is soft and vibrates easily 	<ul style="list-style-type: none"> • Move speaker systems as far away as possible. • Use cushions to absorb the vibrations transmitted from the floor to the speakers. If the turntable does not include insulators, use audio insulators, available in stores. 	— —	
Sound is distorted.	<ul style="list-style-type: none"> • Stylus pressure is too light. • Dirt on tip of stylus • Defective cartridge 	<ul style="list-style-type: none"> • Apply proper pressure. • Check the tip of the stylus • Replace the cartridge. 	— — —	
Remote control unit	This unit does not operate properly when remote control unit is used.	<ul style="list-style-type: none"> • Batteries dead. • Remote control unit too far from this unit. • Obstacle between this unit and remote control unit. • Different button is being pressed. • Ⓜ and Ⓝ ends of battery inserted in reverse 	<ul style="list-style-type: none"> • Replace with new batteries • Move closer. • Remove obstacle • Press the proper button. • Insert batteries properly 	12 12 12
				12
				12

4 REMOTE CONTROL OPERATION

The accessory Remote Control Unit is used to control the amplifier from a convenient distance.

(1) Inserting the Dry Cell Batteries

1. Remove the battery cover on the Remote Control Unit.

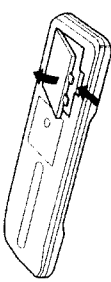

2. Insert two dry cell batteries as shown in the diagram on the battery supply unit.

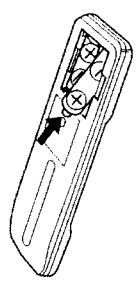

3. Replace the battery cover.

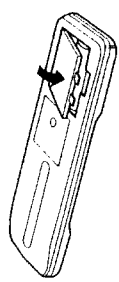

(2) Directions for use

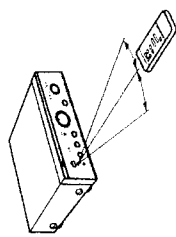

- Notes on Battery Usage**
- RC-176 uses the size R6P (AA) dry cell batteries.
 - The batteries will need to be replaced approximately once a year. This will depend upon how often the Remote Control Unit is used.
 - If in less than a year from the time new batteries were inserted, the Remote Control Unit fails to operate the Amplifier from a near-by position, it is time to replace the batteries.
 - Insert the batteries properly, following the polarity diagram inside the battery compartment.
 - Batteries are prone to damage and leakage. Therefore:
 - Do not mix new batteries with used ones.
 - Do not mix different types of batteries.
 - Do not jumper opposite poles of the batteries, expose them to heat, break them open, nor expose them to open fire.
 - If the batteries have leaked, remove any traces of battery fluid from the battery compartment, wiping thoroughly with a dry cloth. Then insert new batteries.

- Operate the Remote Control Unit while pointing it towards the Remote Control Sensor on the Amplifier as shown in the diagram on the left.
- The Remote Control Unit can be used at distances up to about 6 meters in a straight line from the amplifier. This distance will decrease if there are obstructions blocking the infra-red light transmission or if the Remote Control Unit is not directed straight at the amplifier.
- Do not press the operating buttons on the Amplifier and the Remote Control Unit at the same time. This will cause misoperation.
- Operation of the Remote Control Unit will become less effective or erratic if the infrared Remote Control Sensor on the Amplifier is exposed to strong light or if there are obstructions between the Remote Control Unit and the sensor.
- In case you operate a VCR, TV or other components by remote control, do not operate buttons on two different remote control units at the same time. This will cause misoperation.

Besides being able to operate the PMA-2000R integrated-amplifier with this Remote Control Unit, you can also operate a DENON cassette deck and CD player from this handy full-system Remote Control Unit.

Remote control section
Full-system Remote Control Unit
The full-system Remote Control Unit operates all major functions of the Amplifier, such as function switching, volume control. But that's not all! The same control pad can also control the major functions of a DENON CD player and cassette deck and tuner when combined with the PMA-2000R to create a remarkably ergonomic and versatile DENON system with all the quality sound reproduction that the devoted audiophile expects.

Remote Control Unit RC-176 supplied with the PMA-2000R

1 POWER button
This button can be used to turn on and off the power of the amplifier. LED ① will go out when the power is switched off. However, the power for the amplifier turned on and off if it is in the power standby mode and the power cord is plugged in.

This button will not function if there is a power failure, if the power cord is not plugged in, or when using an audio tuner.
This button can be used when the MUTE/STANDBY LED ② is lit.

2 MUTING button
Pressing this switch will activate the muting condition and no signals will be output to the speakers.

Other buttons
Other buttons are exclusively for the PMA-2000R, and function in the same way as the corresponding buttons on the set.

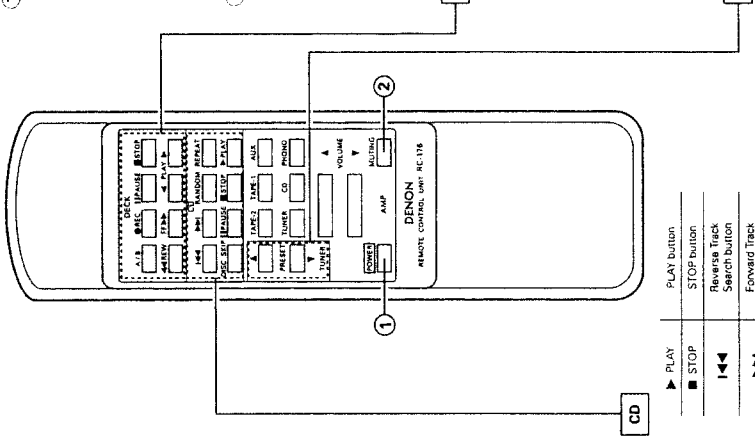

- ▶ PLAY button
- ◀ PLAY (REV) button
- STOP button
- ◀◀ REW button
- ▶▶ FF button
- REC button
- || PAUSE button
- A/B W-DECK button
- ▶ PLAY button
- ▶ PLAY (REV) button
- STOP button
- ◀◀ REW button
- ▶▶ FF button
- REC button
- || PAUSE button
- A/B DECK button
- SELECT button

- ▶ PLAY button
- STOP button
- ◀◀ REVERSE TRACK Search button
- ▶▶ FORWARD TRACK Search button
- RANDOM button
- REPEAT button
- DISC SKIP button
- || PAUSE button

PRESET buttons
Press this button to move up or down among the preset station numbers.

- The RC-176 Remote Control Unit can control CD players and cassette decks manufactured by DENON.
- Note that operation may not be possible for some models.
- Buttons are conveniently separated into groups, each group controlling one specific component. The groups are AMP, FUNCTION, CD, DECK and TUNER etc.

For details on operating other components, refer to the operating instructions for the CD player and/or cassette deck.

CAUTION:

- If the power is turned off with the Remote Control Unit, the set is switched to the power stand-by state. If you are absent for a long period of time, unplug the power cord.
- Only the MUTE/STANDBY LED ② lights red when in the power stand-by mode.
- You may experience erratic operation of the Remote Control Unit if it is operated in fluorescent light and direct sunlight. In particular, if this light strikes the Remote Control Sensor on the Amplifier. However, this is not a malfunction, and if this should happen, simply protect the sensor against such light.

REMOVAL OF EACH SECTION

(Do reverse manner when assembling.)

1. Top Cover

Remove 10 screws **A** , 4 screws **B** and detach the Top Cover in the arrow direction.

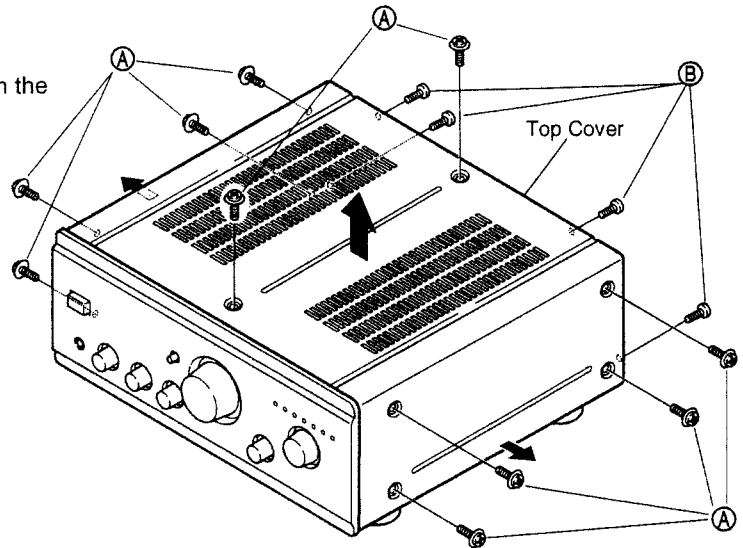

2. Front Panel

- 1) Remove 8 screws **C** .
- 2) Pull out the knob **D** and remove the nut, then detach the panel in the arrow direction.

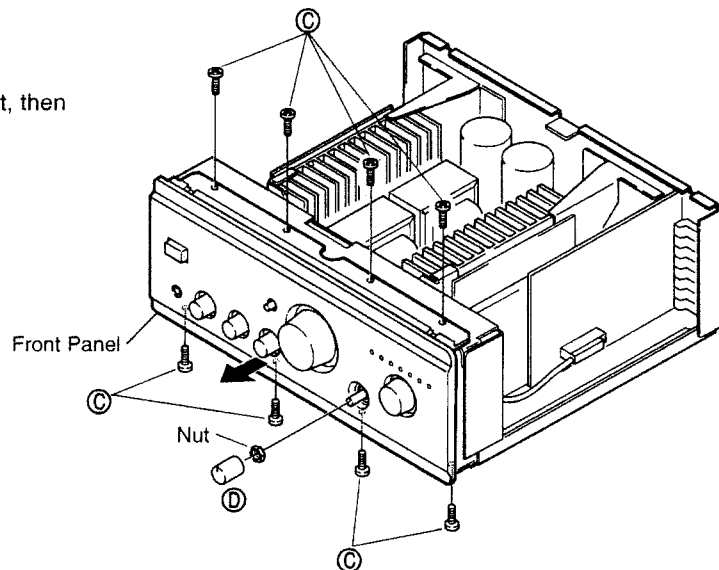

3. Bottom Plate

Remove 20 screws **E** and detach it in the arrow direction.

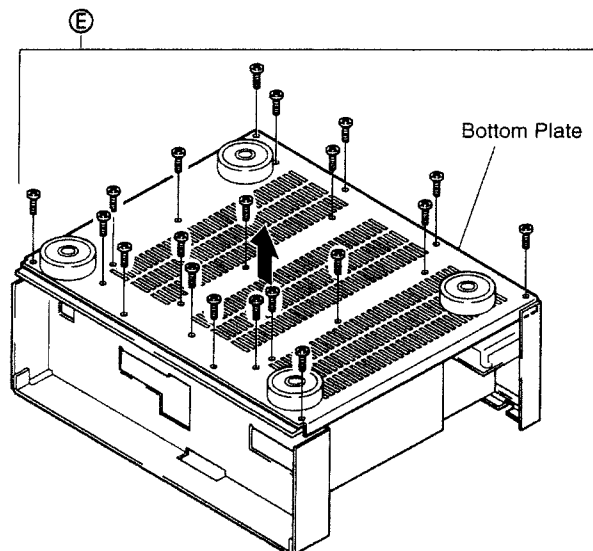

SPECIFICATIONS

● POWER AMPLIFIER SECTION

Rated Output Power:

Both channel driven (8 Ω /ohms Load)	80 W + 80 W
20 Hz to 20 kHz, T.H.D. 0.07% (4 Ω /ohms Load)	160 W + 160 W

Total Harmonic Distortion:

(-3 dB at rated output, 8 Ω /ohms) (1 kHz)	0.01%
--	-------

● PRE AMPLIFIER SECTION

Rated Output:

(Recout Terminal)	150 mV
-------------------	--------

Input Sensitivity / Input Impedance:

The value in parentheses () refers to the input impedance when SOURCE DIRECT is ON.

PHONO:	MM: 2.5 m / 47 k Ω /ohms MC: 200 μ V / 100 Ω /ohms
CD, TUNER, DVD/AUX, TAPE-1 / DAT, TAPE-2 / MD	150 mV / 47 k Ω /ohms (150 mV / 13 k Ω /ohms)

RIAA Deviation:

PHONO:	20 Hz ~ 20 kHz
--------	----------------

Within ± 0.3 dB

Maximum Input:

PHONO	MM: 130 mV / 1 kHz MC: 10 mV / 1 kHz
-------	---

● OVERALL CHARACTERISTICS

SN Ratio (IHF A Network):

PHONO	MM: 91 dB (at 5 mV input)
(input terminals short-circuited)	MC: 76 dB (at 0.5 mV input)
SOURCE-DIRECT: ON	CD, TUNER, DVD/AUX TAPE-1/DAT, TAPE-2/MD: 110 dB

Tone Control Adjustable Range:

BASS:	100 Hz \pm 8 dB
TREBLE:	10 kHz \pm 8 dB

● OTHERS

Power Supply: AC 230 V, 50 Hz

AC Outlets:

Switched \times 2:	100 W (Total)
Unswitched \times 1:	100 W

Power Consumption:

310 W (IEC)
Dimensions: 434(W) \times 180(H) \times 478(D) mm (17-3/32" \times 7-5/64" \times 18-13/16")

Dimensions:

Net Weight:

20.0 kg (44 lbs 1 oz)

● REMOTE CONTROL UNIT (RC-176)

Remote control system: Infrared pulse system

Power supply: 3V DC, Two size R6P ("AA")
dry cell batteries

External dimensions: 55(W) \times 194(H) \times 18(D) mm
(2-11/64" \times 7-41/64" \times 18-45/64")

Weight:

100 g (Approx. 3.5 oz)
(including batteries)

* Maximum dimensions include controls, jacks, and covers.
(W) = width, (H) = height, (D) = depth

● For improvement purposes, specifications and functions are subject to change without advanced notice.

METHOD OF ADJUSTMENTS

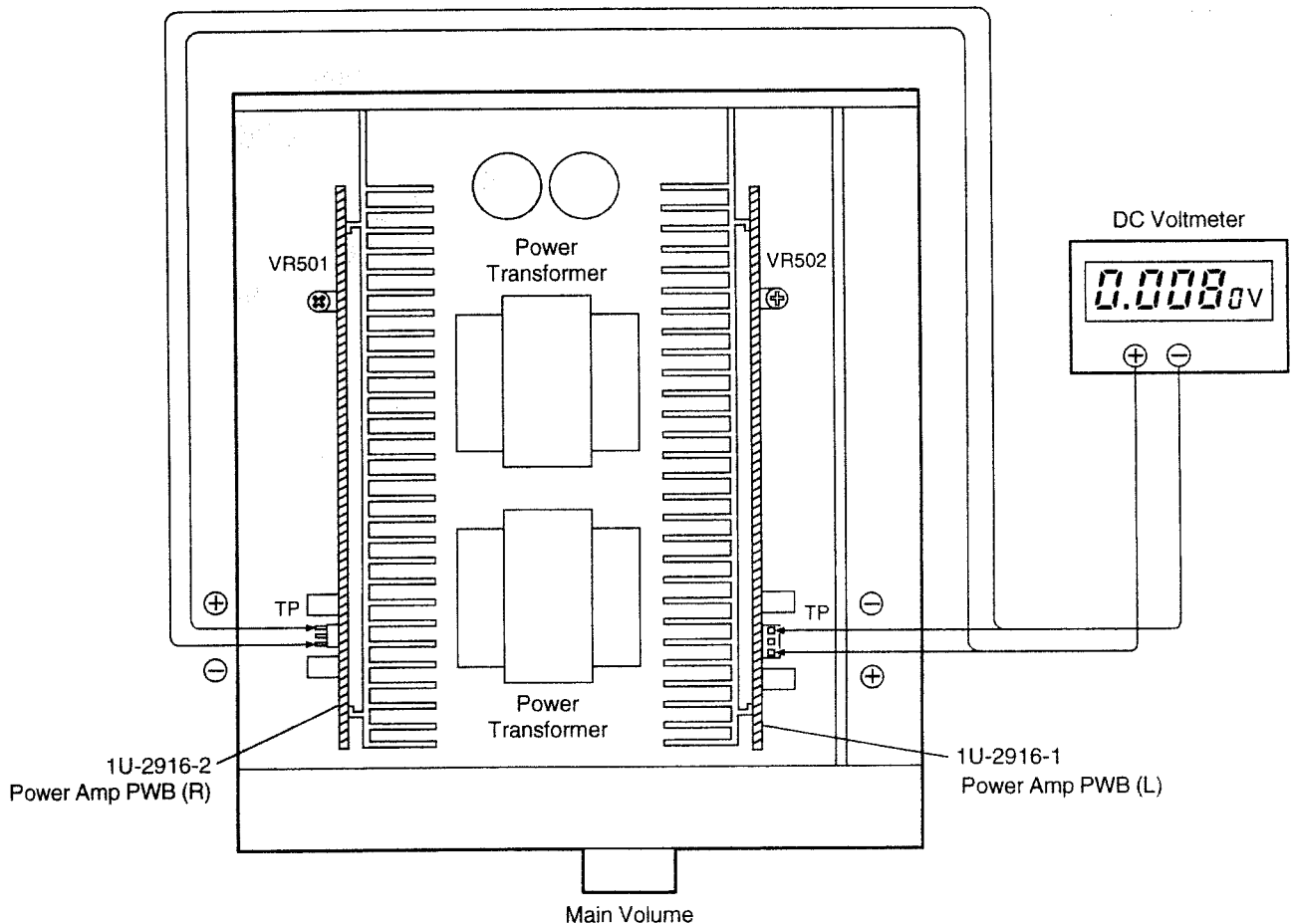

IDLING CURRENT

● Setup

1. Lay the unit at an ordinary position away from a direct current from an air condition or fan. Do the adjustment at a temperature between 15°C (59°F) and 30°C (86°F).
2. Set controls as follows.

POWER SWITCH	→ OFF (■)
VOLUME CONTROL	→ fully counterclockwise in the minimum position (⤴). (Main Volume and Semifixed resistors [VR501, 502]).
SPEAKER Terminals	→ Open: do not connect the speakers, dummy load etc.

● Adjustment

1. Remove top cover. And then connect DC Voltmeter to test points of 1U-2916-1(Lch) and 1U-2916-2(Rch) Power Amp Printing Wiring Board.
2. Connect power cord to AC 230V (within the range 218 ~ 242V permissible) wall outlet, and turn POWER switch "ON" (■). Within 10 seconds turn VR501 (L ch) and VR502 (Rch) clockwise so that the DC Voltmeter reads 8 ± 0.5 mV.
3. Then after 2 minutes warmup adjust VR501 and VR502 so that the DC Voltmeter reads 10 ± 0.5 mV.
4. And after 10 minutes warmup adjust VR501 and VR502 so that the DC Voltmeter reads 10 ± 0.5 mV.

4. Rear Panel

- 1) Remove 4 screws ⑥, 8 screws ⑦ and 2 screws ⑧.
- 2) By lifting the right and left Heat Sink Ass'y to release hook in 2 places.
- 3) Detach the Rear Panel in the arrow direction.

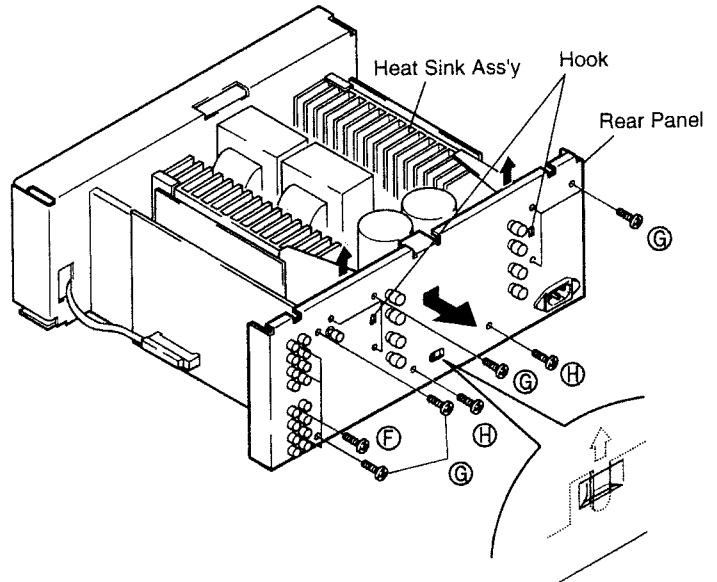

5. Heat Sink Ass'y

- Remove 2 screws ⑩ and detach the Heat Sink Ass'y in the arrow direction.

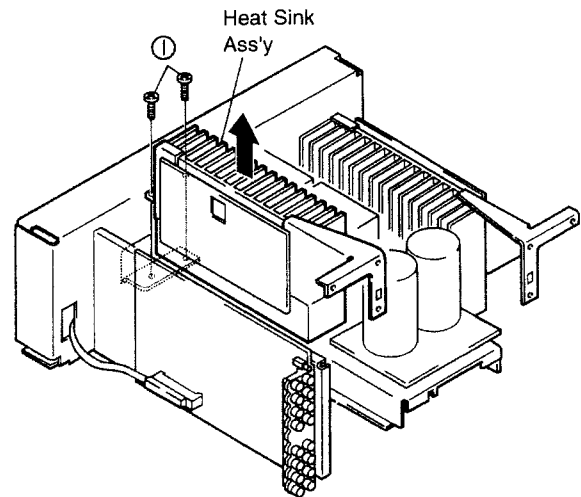

SEMICONDUCTORS

● IC's

HD404304A13P (IC101)

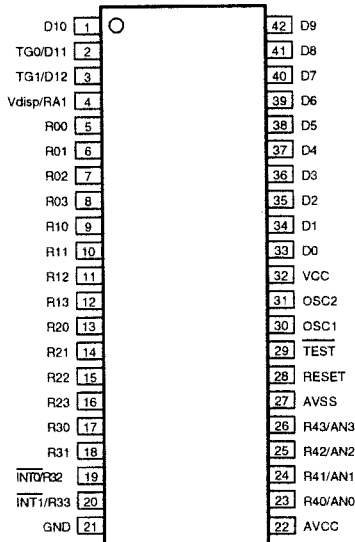

HD404304A13P Terminal Function

Pin No.	Symbol	I/O	Active	Function
1	D10	O	H	MUTE/STANDBY LED Indication
2	TG0/D11	O	H	Not used
3	TG1/D12	O	L	Power control (remote power ON/OFF)
4	Vdisp/RA1	I		Not used
5	R00	O		Not used
6	R01	O	L	Muting control (power ON/OFF, function shift, muting)
7	R02	O		Not used
8	R03	O		Not used
9	R10	O	H	Key output
10	R11	O	H	Key output
11	R12	O		Not used
12	R13	O		Not used
13	R20	I		Key Input
14	R21	I		
15	R22	I		
16	R23	I		Not used
17	R30	O	H	
18	R31	O	H	
19	INT0/R32	I		Detection input for power stop
20	INT1/R33	I		Decode input for remote control signal
21	GND			GND
22	AVCC			Avcc (Vcc)
23	R40/AN0			Not used
24	R41/AN1	I		Not used
25	R42/AN2	I		Not used
26	R43/AN3	I		Judgement port for prior use model
27	AVSS			Avss (GND)
28	RESET			Connect to external M51954AL
29	TEST			Vcc
30	OSC1			Control to external crystal oscillator (4MHz)
31	OSC2			
32	VCC			Vcc
33	D0	O		Not used
34	D1	O		Not used
35	D2	O	H	Mutual Reset
36	D3	O	H	
37	D4	O		Mutual Reset
38	D5	O	H	
39	D6	O	H	
40	D7	O		
41	D8	O	H	Mutual Reset
42	D9	O	H	

LB1639 (IC102)

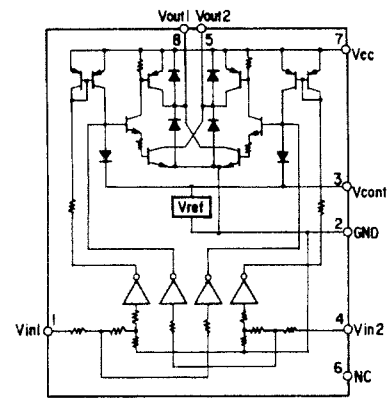
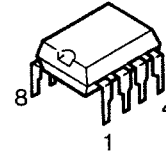

M51954AL (IC603)

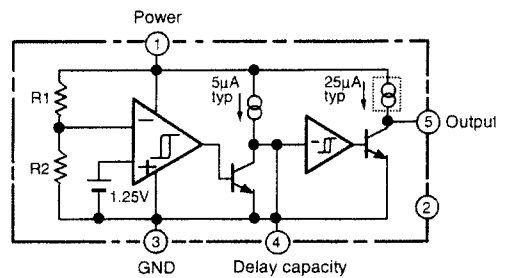
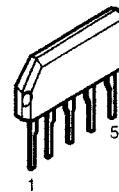

BLOCK AND LEVEL DIAGRAM

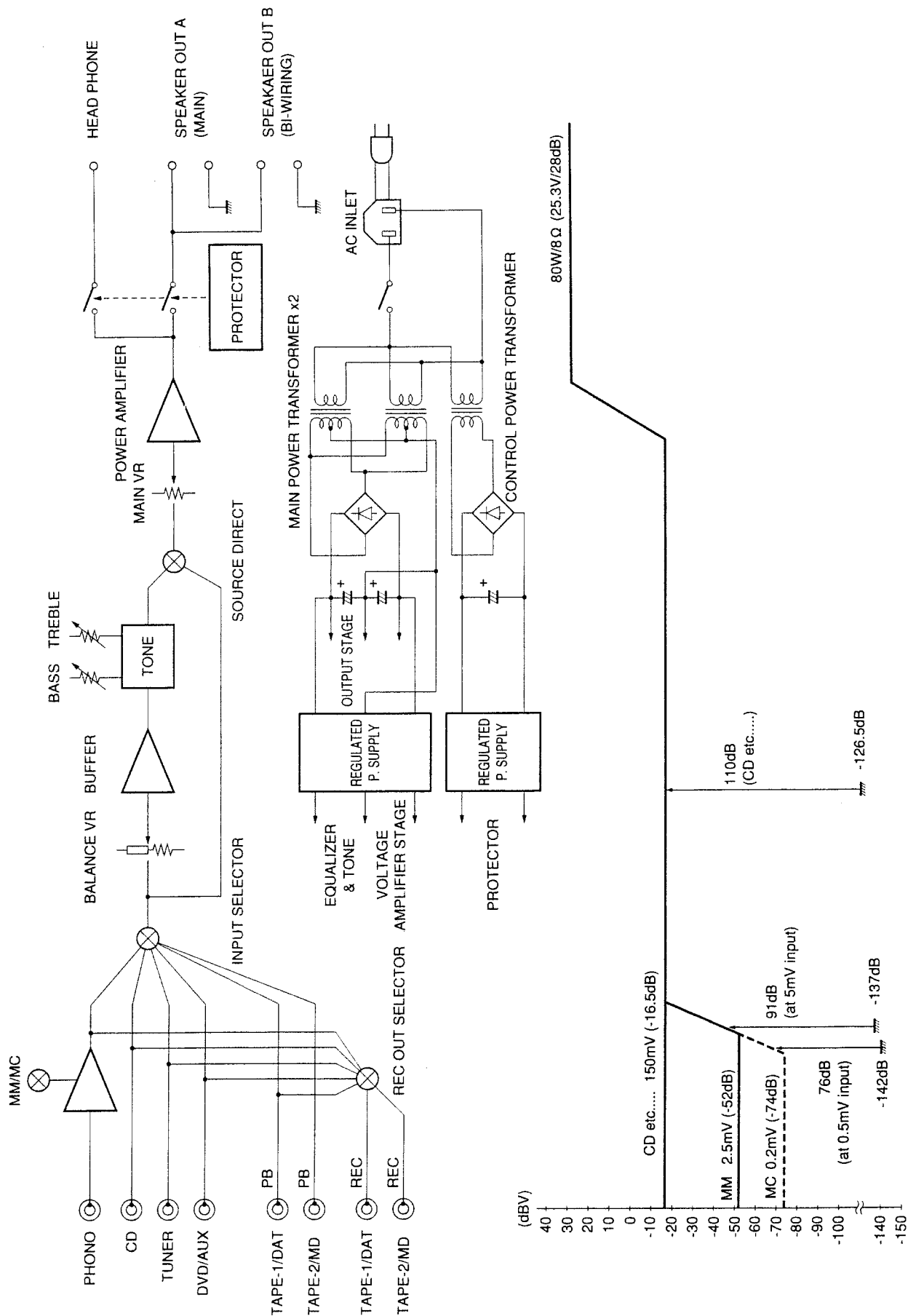

**SBX1610-52 (Remote Control Receiver)
(RH101)**

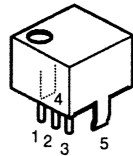

- 1. Vcc
- 2. Output
- 3. GND
- 4. Case Fin
- 5. Case Fin

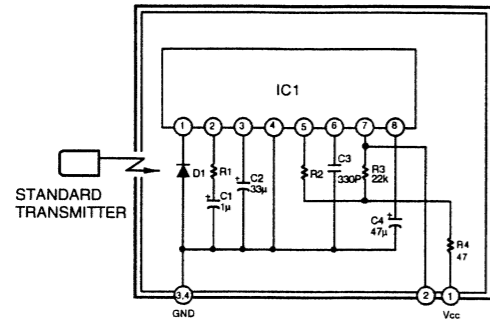

- IC1 : CX20106A Chip
- D1 : PIN Photodiode Chip
- C1, C2, C4 : Aluminum Electrolytic Capacitor
- C3 : SL Characteristic $\pm 5\%$
- R1 : Gain control resistor
- R2 : fo control resistor (Using $\pm 1\%$)
- R (Other than above items) : $\pm 5\%$

**2SB1186A(D)
2SD1763A(D)**

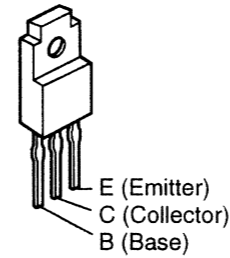

2SK184C(GR)/(BL)

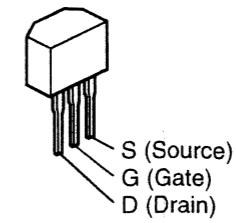

2SK369(BL)/(GR)-C

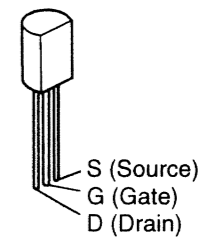

**NJM2068DDC (IC201)
BA4558(IC701)**

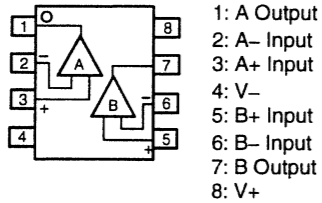
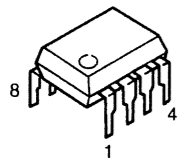

- 1: A Output
- 2: A- Input
- 3: A+ Input
- 4: V-
- 5: B+ Input
- 6: B- Input
- 7: B Output
- 8: V+

NJM7806FA(S) (IC602)

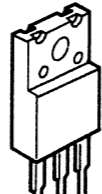

- 1: Output
- 2: GND
- 3: Input

2SK373(Y)

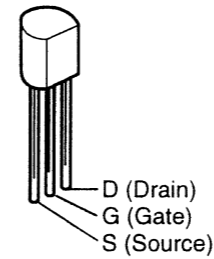

2SC3421(O/Y)

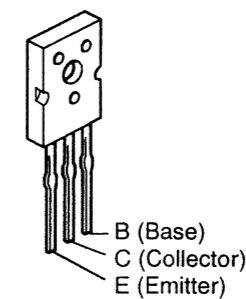

2SK851

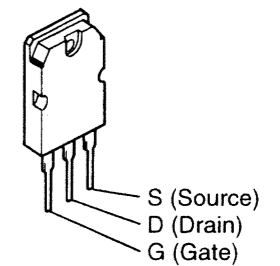

TRANSISTORS

**2SA933(S)
2SC1740(S)**

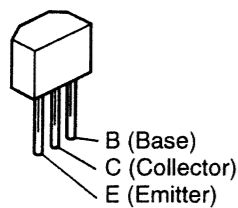

**2SA988(E/F)
2SC1841(E/F)
2SD1111**

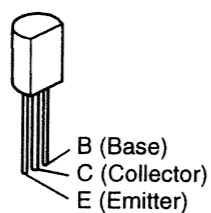

**2SB1328(P)
2SD2004(P)**

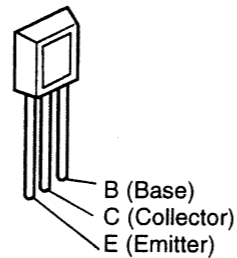

DIODES

1SS252

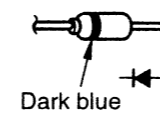

1SR35-200A

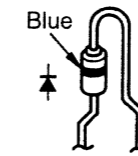

**HZS6B-1
HZS12A-1
MTZJ7.5A
MTZJ16A
MTZJ18A
MTZJ27A**

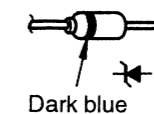

**RU-4Z (J8)
(D802-805)**

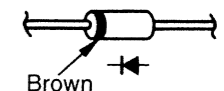

**DTA144ES
DTC123JS
DTC143ZS**

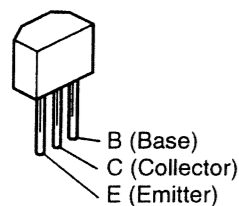

DTA144ES

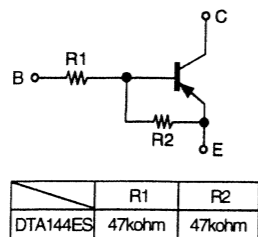

**DTC123JS
DTC143ZS**

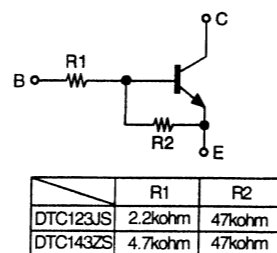

**SLR-56VC (LED)
(LD001,101~106)**

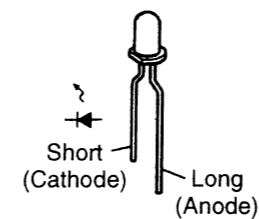

**D5FB20 (4001)
(D801)**

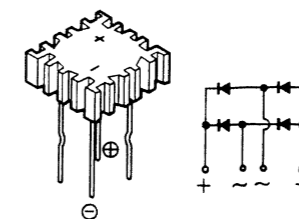

**SFOR3G42 (Thyristor)
(SC601)**

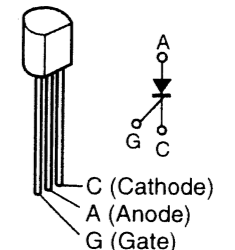

PRINTED WIRING BOARD

1 2 3 4 5 6 7 8

1U-2916C POWER AMP UNIT ASS'Y

A

1U-2916C POWER AMP UNIT ASS'Y	
-1	Power Amp (L) Unit
-2	Power Amp (R) Unit
-3	Control Unit
-4	P LED Unit
-5	Source Direct Switch Unit
-6	Power Switch Unit
-8	AC Outlet Unit
-9	Main VR Unit

B

C

D

E

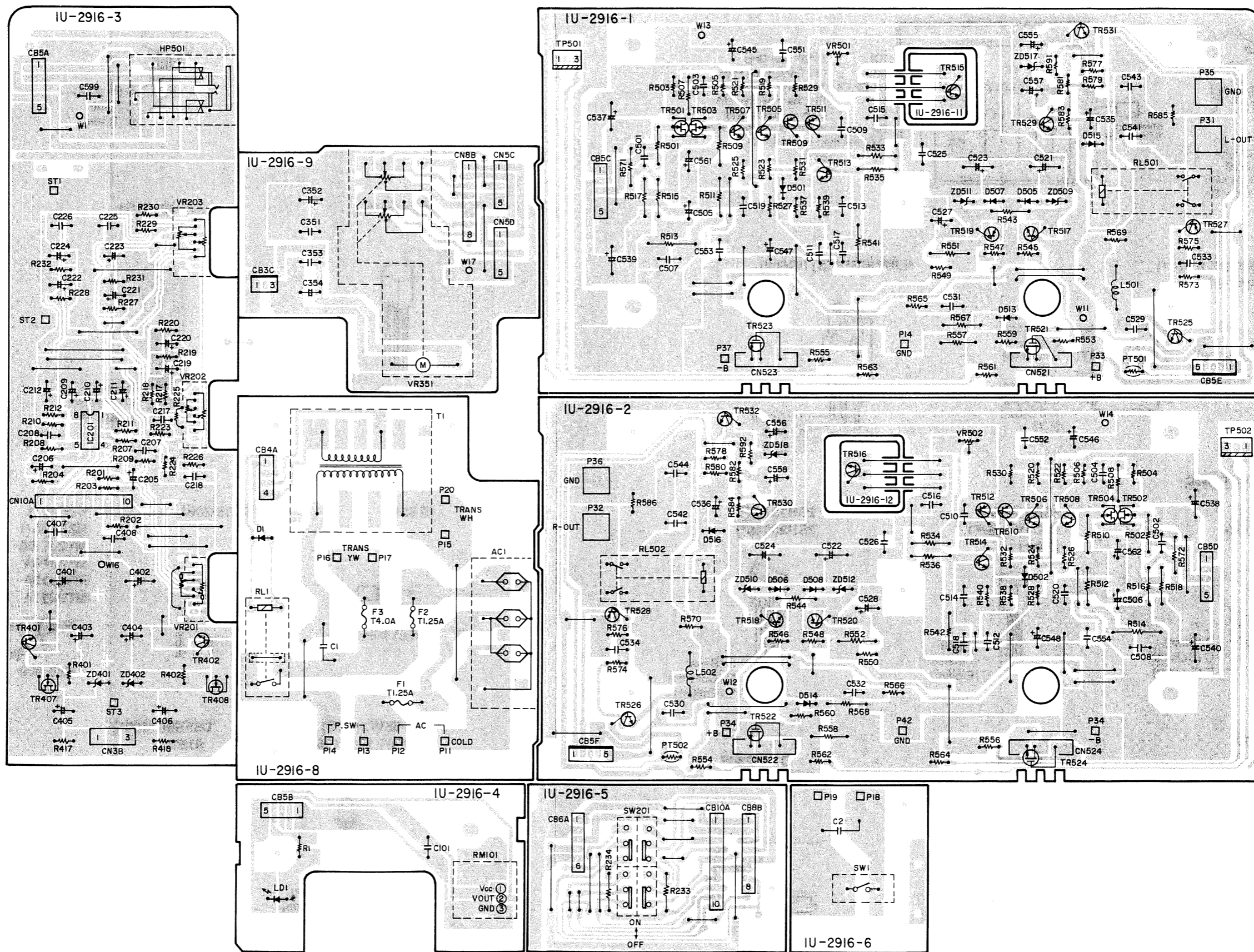

1 2 3 4 5 6 7 8

1U-2917C INPUT UNIT ASS'Y

1U-2917C INPUT UNIT ASS'Y	
-1	Input Unit
-2	Protector Unit
-3	Power Supply Unit
-5	Function SW Unit

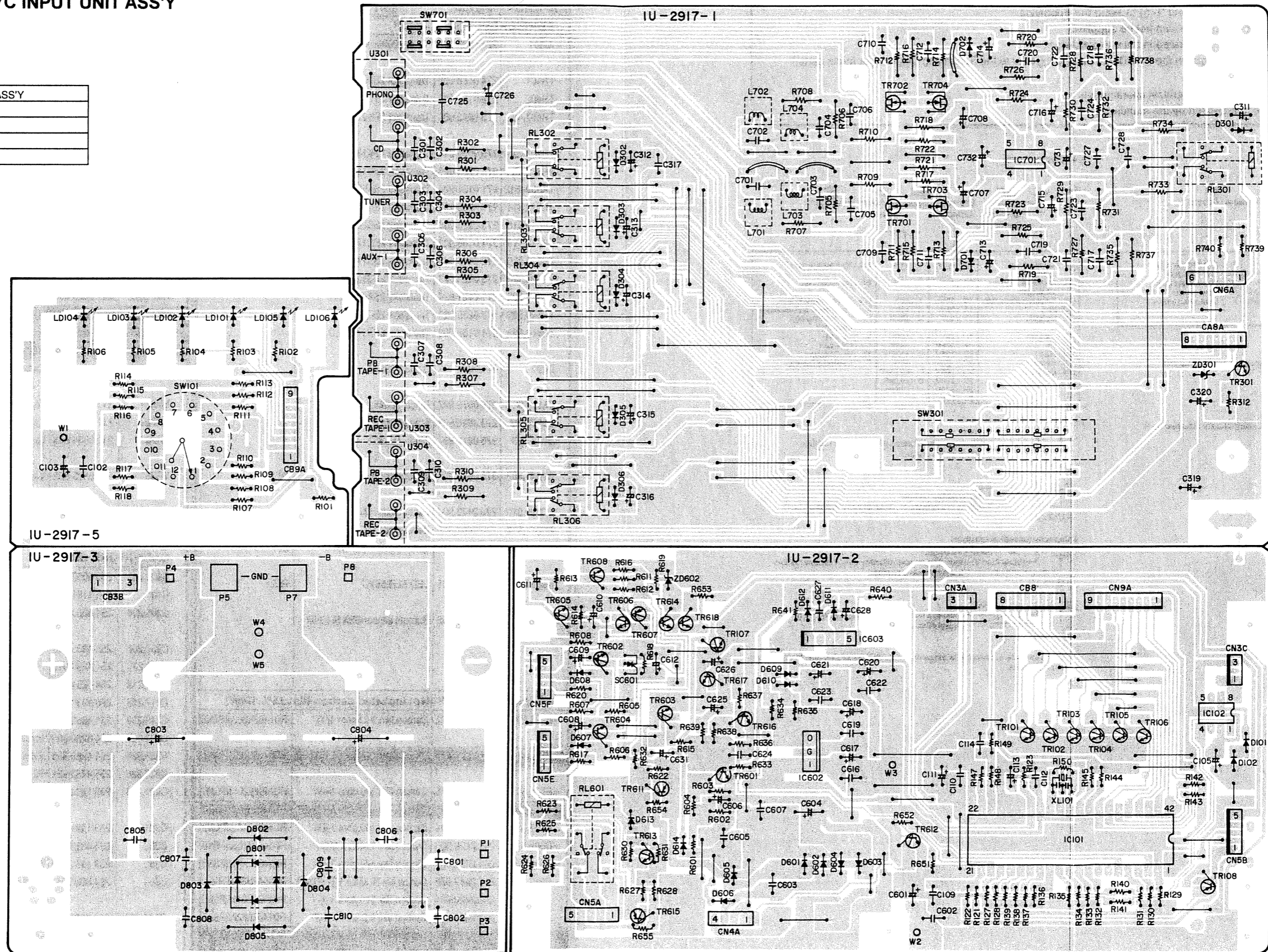

A
B
C
D
E

NOTE FOR PARTS LIST

- Part indicated with the mark "◎" are not always in stock and possibly to take a long period of time for supplying, or in some case supplying of part may be refused.
 - When ordering of part, clearly indicate "1" and "1" (i) to avoid mis-supplying.
 - Ordering part without stating its part number can not be supplied.
 - Part indicated with the mark "★" is not illustrated in the exploded view.
 - Not including Carbon Film ±5%, 1/4W Type in the P.W.Board parts list. (Refer to the Schematic Diagram for those parts.)
- WARNING:**
Parts marked with this symbol Δ have critical characteristics.
Use ONLY replacement parts recommended by the manufacturer.

● **Resistors**

Ex.: RN 14K 2E 182 G ER
Type Shape Power Resist- Allowable ER
and per- ance error Others
formance

RD : Carbon	2B : 1/8W	F : ±1%	P : Pulse-resistant type
RC : Composition	2E : 1/4W	G : ±2%	NL : Low noise type
RS : Metal oxide film	2H : 1/2W	J : ±5%	NB : Non-burning type
RW : Winding	3A : 1W	K : ±10%	FR : Fuse-resistor
RN : Metal film	3D : 2W	M : ±20%	F : Lead wire forming
RK : Metal mixture	3F : 3W		
	3H : 5W		

* **Resistance**

$\overset{1}{\text{---}}\overset{8}{\text{---}}\overset{2}{\text{---}}$ ⇒ 1800 ohm = 1.8 kohm
Indicates number of zeros after effective number.
2-digit effective number.

• Units: ohm

$\overset{1}{\text{---}}\overset{R}{\text{---}}\overset{2}{\text{---}}$ ⇒ 1.2 ohm
1-digit effective number.
2-digit effective number, decimal point indicated by R.

• Units: ohm

● **Capacitors**

Ex.: CE 04W 1H 2R2 M BP
Type Shape Dielectric Capacity Allowable BP
and per- strength error Others
formance

CE : Aluminum foil electrolytic	0J : 6.3V	F : ±1%	HS : High stability type
CA : Aluminum solid electrolytic	1A : 10V	G : ±2%	BP : Non-polar type
CS : Tantalum electrolytic	1C : 16V	J : ±5%	HR : Ripple-resistant type
CQ : Film	1E : 25V	K : ±10%	DL : For change and discharge
CK : Ceramic	1V : 35V	M : ±20%	HF : For assuring high frequency
CC : Ceramic	1H : 50V	Z : +80%	U : UL part
CP : Oil	2A : 100V	-20%	C : CSA part
CM : Mica	2B : 125V	P : +100%	W : UL-CSA type
CF : Metallized	2C : 160V	-0%	F : Lead wire forming
CH : Metallized	2D : 200V	C : ±0.25pF	
	2E : 250V	D : ±0.5pF	
	2H : 500V	= : Others	
	2J : 630V		

* **Capacity (electrolyte only)**

$\overset{2}{\text{---}}\overset{2}{\text{---}}\overset{2}{\text{---}}$ ⇒ 2200μF
Indicates number of zeros after effective number.
2-digit effective number.

• Units: μF.

$\overset{2}{\text{---}}\overset{R}{\text{---}}\overset{2}{\text{---}}$ ⇒ 2.2μF
1-digit effective number.
2-digit effective number, decimal point indicated by R.

• Units: μF.

* **Capacity (except electrolyte)**

$\overset{2}{\text{---}}\overset{2}{\text{---}}\overset{2}{\text{---}}$ ⇒ 2200pF=0.0022μF
(More than 2) — Indicates number of zeros after effective number.
2-digit effective number.

• Units: μF.

$\overset{2}{\text{---}}\overset{2}{\text{---}}\overset{1}{\text{---}}$ ⇒ 220pF
(0 or 1) — Indicates number of zeros after effective number.
2-digit effective number.

• Units: pF.

• When the dielectric strength is indicated in AC, "AC" is included after the dielectric strength value.

PARTS LIST OF PRINTED WIRING BOARD UNIT ASS'Y
1U-2916C POWER AMP P.W.B. UNIT ASS'Y

Ref. No.	Part No.	Part Name	Remarks
SEMICONDUCTORS GROUP			
IC201	263 0609 002	IC NJM2068DDC	
TR401	274 0158 003	Transistor 2SD1763A(D)	
TR402	272 0115 008	Transistor 2SB1186A(D)	
TR407,408	275 0042 905	Transistor 2SK373(Y)	
TR501-504	275 0055 015	Transistor 2SK184C (GR)/(BL)	
TR505-508	273 0235 923	Transistor 2SC1841(E/F)	
TR509-512	271 0131 924	Transistor 2SA988(E/F)	
TR513,514	273 0235 923	Transistor 2SC1841(E/F)	
TR515,516	273 0323 000	Transistor 2SC3421 (O/Y)	
TR517,518	274 0158 003	Transistor 2SD1763A(D)	
TR519,520	272 0115 008	Transistor 2SB1186A(D)	
TR525,526	273 0235 923	Transistor 2SC1841(E/F)	
TR527,528	271 0131 924	Transistor 2SA988(E/F)	
TR529,530	273 0235 923	Transistor 2SC1841(E/F)	
TR531,532	274 0158 003	Transistor 2SD1763A(D)	
D001	276 0616 907	Diode 1SS252	
D501,502	276 0616 907	Diode 1SS252	
D505-508	276 0616 907	Diode 1SS252	
D513-516	276 0616 907	Diode 1SS252	
ZD401,402	276 0645 907	Zener diode MTZJ18A	18V
ZD509,510	276 0473 904	Zener diode HZS12A-1	12V
ZD511,512	276 0462 902	Zener diode HZS6B-1	6V
ZD517,518	276 0645 949	Zener diode MTZJ27A	27V
LD001	393 9557 906	LED SLR-56VC	RED
RM101	499 0150 008	Remote sensor SBX1610-52	
RESISTORS GROUP (Not included carbon film ±5% 1/4W)			
R233,234	241 2423 972	Carbon film 3.6 kohm 1/4W	RD14B2E362J(PSNB)
R417,418	241 2377 947	Carbon film 100 ohm 1/4W(NB)	RD14B2E101JNBS
R501,502	241 2420 975	Carbon film 200 ohm 1/4W	RD14B2E201J(PSNB)
R503-506	241 2381 946	Carbon film 4.7 kohm 1/4W(NB)	RD14B2E472JNBS
R507,508	241 2420 904	Carbon film 100 ohm 1/4W	RD14B2E101J(PSNB)
R509,510	241 2429 963	Carbon film 1 Mohm 1/4W	RD14B2E105J(PSNB)
R511,512	241 2421 961	Carbon film 470 ohm 1/4W	RD14B2E471J(PSNB)
R513,514	241 2447 068	Carbon film 39 kohm 1/2W(RMG)	RD05A2H393J(RMG)
R515,516	241 2420 991	Carbon film 240 ohm 1/4W	RD14B2E241J(PSNB)
R517,518	241 2424 968	Carbon film 8.2 kohm 1/4W	RD14B2E822J(PSNB)
R519-522	241 2315 963	Carbon film 330 ohm 1/4W(FR)	RD14B2E331GFRS
R523-526	241 2376 922	Carbon film 33 ohm 1/4W(NB)	RD14B2E330JNBS

Ref. No.	Part No.	Part Name	Remarks
R527,528	241 2380 918	Carbon film 1.3 kohm 1/4W(NB)	RD14B2E132JNBS
R529,530	241 2377 921	Carbon film 82 ohm 1/4W(NB)	RD14B2E820JNBS
R531,532	244 2068 048	Metal oxide 15 kohm 1W	RS14B3A15JNBS(RSFSV)
R533,534	241 2424 926	Carbon film 5.6 kohm 1/4W	RD14B2E562J(PSNB)
R535,536	241 2422 928	Carbon film 820 ohm 1/4W	RD14B2E821J(PSNB)
R537-540	241 2371 980	Carbon film 160 ohm 1/4W(FR)	RD14B2E161GFRS
R541,542	241 2429 963	Carbon film 1 Mohm 1/4W	RD14B2E105J(PSNB)
R543,544	241 2423 969	Carbon film 3.3 kohm 1/4W	RD14B2E332J(PSNB)
R545,546	244 2068 036	Metal oxide 390 ohm 1W	RS14B3A391JNBS(RSFSV)
R547,548	244 2068 019	Metal oxide 200 ohm 1W	RS14B3A201JNBS(RSFSV)
R549,550	244 2068 035	Metal oxide 390 ohm 1W	RS14B3A391JNBS(RSFSV)
R553-556	241 2376 964	Carbon film 47 ohm 1/4W(NB)	RD14B2E470JNBS
R557,558	243 2061 000	Wire wound 0.1 ohm 3W	RW99-3F0R1K
R559,560	241 2380 963	Carbon film 2.2 kohm 1/4W(NB)	RD14B2E222JNBS
R569,570	244 2029 003	Metal oxide 0.22 ohm 2W	RS14B3DR22JNBSF
R571,572	241 2429 963	Carbon film 1 Mohm 1/4W	RD14B2E105J(PSNB)
R577,578	244 2061 932	Metal oxide 3.3 kohm 1W	RS14B3A332JNBS(S)
R585,586	244 2067 007	Metal oxide 10 ohm 2W	RS14B3D100JNBS(RSFL)
R591,592	244 2051 990	Metal oxide 4.7 kohm 1W	RS14B3A472JNBS(S)
R598,599	241 2429 963	Carbon film 1 Mohm 1/4W	RD14B2E105J(PSNB)
VR201	211 0798 103	Variable resistor 100 kohm	BALANCE
VR202	211 0834 012	Variable resistor 10 kohm	TREBLE
VR203	211 0834 009	Variable resistor 30 kohm	BASS
VR351	211 0873 002	Variable resistor 30 kohm	VOLUME
VR501,502	211 8005 021	Semi fixed resistor 4.7 kohm	V06QB472
CAPACITORS GROUP			
C001,002	253 8003 713	Ceramic 4700pF/400V(AC)	CK45E2GAC472MC
C101	253 1181 904	Ceramic 0.01μF/50V	CK45F1H103Z
C205,206	254 4260 977	Electrolytic 4.7μF/50V	CE04W1H4R7M
C207,208	255 4235 918	Film 100pF/100V	CQ93P2A101J(NH)
C209,210	254 4260 948	Electrolytic 1μF/50V	CE04W1H010M
C211,212	254 4254 941	Electrolytic 100μF/16V	CE04W1C101M
C217,218	256 1034 911	Metallized 0.033μF/50V	CF93A1H333J
C219,220	254 4260 919	Electrolytic 0.22μF/50V	CE04W1HR22M
C221,222	254 4260 906	Electrolytic 0.1μF/50V	CE04W1H0R1M
C223,224	254 4260 935	Electrolytic 0.47μF/50V	CE04W1HR47M
C225,226	255 4232 924	Film 39pF/100V	CQ93P2A390J(NH)
C227,228	255 1264 966	Film 0.0033μF/50V	CQ93M1H332J(B)
C351	253 1181 917	Ceramic 0.022μF/50V	CK45F1H223Z
C352	254 4313 963	Electrolytic 1μF/50V	CE04W1H010M(ASF)
C353	253 1181 917	Ceramic 0.022μF/50V	CK45F1H223Z
C354	254 3055 918	Electrolytic 10μF/35V	CE04D1V100MBP
C401,402	254 4356 742	Electrolytic 470μF/50V	CE04W1H471(ARS)
C403,404	254 4356 713	Electrolytic 100μF/50V	CE04W1H101MC(ARS)
C405,406	254 4415 010	Electrolytic 22μF/100V	CE04W2A220M(ARS)

Ref. No.	Part No.	Part Name	Remarks	Ref. No.	Part No.	Part Name	Remarks
C545-548	254 4415 023	Electrolytic 47 μ F/100V	CE04W2A470M(ARS)		001 0166 099	Vinyl wire	
C551-554	255 4235 057	Film 0.1 μ F/100V	CQ93P2A104J(NH)		415 0309 026	P.V.C. tube	PT501,502 (L=20)
C555-558	254 4313 921	Electrolytic 22 μ F/50V	CE04W1H220M(ASF)		513 1873 062	Fuse label (1.25A)	F001,002
C561,562	254 4356 713	Electrolytic 100 μ F/50V	CE04W1H101MC(ARS)		513 1873 059	Fuse label (4A)	F003
OTHER PARTS GROUP							
Δ F001,002	206 1015 016	Fuse 1.25A					
Δ F003	206 1015 087	Fuse 4A					
	202 0040 909	Fuse clip	F001-003				
Δ RL001	214 0142 004	Relay (TV-5)					
RL501,502	214 0129 001	Relay (DH2TU)					
Δ SW001	212 1030 009	Power switch (TV-5)					
SW201	212 1157 005	1P push switchi					
Δ T001	233 6058 009	Power trans (mini-E2)					
L501,502	235 0053 019	Inductor 1 μ H					
HP501	204 8480 004	Head phone jack (SW)					
CN521-524	205 0915 062	6P BB connector					
CB3C	205 0343 032	3P connector base (KR-PH)					
CB5A	205 0233 058	5P EH connector base					
CB5B	205 0279 054	5P PH SID connector base					
CB5C	205 0233 058	5P EH connector base					
CB5D	203 8468 010	5P EH-SCN connector cord					
CB5E,5F	205 0343 058	5P connector base (KR-PH)					
CB6A	205 0233 061	6P EH connector base					
CB8B	204 2785 006	8P EH-SCN connector cord					
CB10A	204 2786 005	10P EH-SCN connector cord					
CN3B	205 0653 036	3P VH connector base					
CN4A	205 0233 045	4P EH connector base					
CN5C	203 8468 007	5P EH-SCN connector cord					
CN5D	205 0277 056	5P EH connector base (RD)					
CN8B	205 0233 087	8P EH connector base					
CN10A	205 0275 003	10P EH connector base					
TP501,502	205 0154 030	3P NH connector base					
P52	203 0629 019	1P contact Ass'y					
W16	203 0641 039	1P contact Ass'y					
P31,32	205 0864 003	M3 screw terminal					
P35,36	205 0864 003	M3 screw terminal					
	415 0299 000	Condenser cover	C001,002				
	205 0452 017	Style pin					
				PT501,502	279 0034 041	Posistor PTH9M04BD222TS2F333	

1U-2917C INPUT P.W.B. UNIT ASS'Y

Ref. No.	Part No.	Part Name	Remarks
SEMICONDUCTORS GROUP			
IC101	262 1579 303	IC HD404304A13P	
IC102	263 0476 002	IC LB1639	
IC602	263 0793 002	IC NJM7806FA(S)	+6V
IC603	263 0535 008	IC M51954AL	
IC701	263 0322 004	IC BA4558	
TR101-106	269 0160 905	Transistor DTC143ZSA	
TR107	269 0051 904	Transistor DTC123JS(2.2K-47K)	
TR108	269 0093 904	Transistor DTA144ES(47K-47K)	
TR301	274 0151 903	Transistor 2SD2004(P)	
TR601-606	27 30303 910	Transistor 2SC1740S(S)	
TR607	271 0192 905	Transistor 2SA933S(S)	
TR608	273 0303 910	Transistor 2SC1740S(S)	
TR611	272 0107 906	Transistor 2SB1328(P)	
TR612-614	273 0303 910	Transistor 2SC1740S(S)	
TR615	271 0192 905	Transistor 2SA933S(S)	
TR616,617	273 0303 910	Transistor 2SC1740S(S)	
TR618	274 0111 901	Transistor 2SD1111	
TR701-704	275 0038 045	Transistor 2SK369 (BL)/(GR)-C	
D101,102	276 0616 907	Diode 1SS252	
D301-306	276 0616 907	Diode 1SS252	
D601-606	276 0553 905	Diode 1SR35-200A	
D609	276 0616 907	Diode 1SS252	
D610-612	276 0616 907	Diode 1SS252	
D613	276 0616 907	Diode 1SS252	
D614	276 0616 907	Diode 1SS252	
D701,702	276 0616 907	Diode 1SS252	
D801	276 0356 005	Diode D5FB20 (4001)	
D802-805	276 0574 706	Diode RU4Z(J8)	
ZD301	276 0644 995	Zener diode MTZJ16A	16V
ZD602	276 0644 911	Zener diode MTZJ7.5A	7.5V
LD101-106	393 9557 906	LED SLR-56VC	Red
SC601	279 0038 908	SCR SF0R3G42	

Ref. No.	Part No.	Part Name	Remarks
RESISTORS GROUP (Not included carbon film $\pm 5\%$ 1/4W)			
R301-310	241 2428 948	Carbon film 330 kohm 1/4W	RD14B2E334J(PSNB)
Δ R312	241 2378 920	Carbon film 220 ohm 1/4W(NB)	RD14B2E221JNBS
Δ R623-626	244 2052 960	Metal oxide 220 ohm 1W	RS14B3A221JNBS(S)
Δ R634,635	241 2387 940	Carbon film 4.7 ohm 1/4W(NB)	RD14B2E4R7JNBS
Δ R654	244 2055 983	Metal oxide 82 ohm 1W	RS14B3A820JNBS(S)
R705,706	241 2420 904	Carbon film 100 ohm 1/4W	RD14B2E101J(PSNB)
R707,708	241 2426 940	Carbon film 47 kohm 1/4W	D14B2E473J(PSNB)
R709,710	241 2417 962	Carbon film 10 ohm 1/4W	D14B2E100J(PSNB)
R711-714	241 2423 956	Carbon film 3 kohm 1/4W	D14B2E302J(PSNB)
R715,716	241 2420 975	Carbon film 200 ohm 1/4W	RD14B2E201J(PSNB)
R717,718	241 2423 914	Carbon film 2 kohm 1/4W	RD14B2E202J(PSNB)
R719,720	241 2419 986	Carbon film 82 ohm 1/4W	RD14B2E820J(PSNB)
R721,722	241 2422 928	Carbon film 820 ohm 1/4W	RD14B2E821J(PSNB)
R725,726	241 2426 940	Carbon film 47 kohm 1/4W	RD14B2E473J(PSNB)
R727,728	241 2423 985	Carbon film 3.9 kohm 1/4W	RD14B2E392J(PSNB)
R729,730	241 2418 945	Carbon film 22 ohm 1/4W	RD14B2E220J(PSNB)
R731,732	241 2420 988	Carbon film 220 ohm 1/4W	RD14B2E221J(PSNB)
R733,734	241 2421 961	Carbon film 470 ohm 1/4W	RD14B2E471J(PSNB)
R735,736	241 2429 918	Carbon film 620 kohm 1/4W	RD14B2E624J(PSNB)
R737,738	241 2417 920	Carbon film 6.8 ohm 1/4W	RD14B2E6R8J(PSNB)
Δ R739,740	241 2313 985	Carbon film 4.7 ohm 1/4W(FR)	RD14B2E4R7JFRS
R987-989	241 2429 918	Carbon film 620 kohm 1/4W	RD14B2E624J(PSNB)
CAPACITORS GROUP			
C105	254 4252 930	Electrolytic 100 μ F/10V	CE04W1A101M
C109	253 1180 921	Ceramic 1000pF/50V	CK45B1H102K
C110	253 1181 917	Ceramic 0.022 μ F/50V	CK45F1H223Z
C111	254 4252 930	Electrolytic 100 μ F/10V	CE04W1A101M
C112	253 1181 917	Ceramic 0.022 μ F/50V	CK45F1H223Z
C113	254 4252 930	Electrolytic 100 μ F/10V	CE04W1A101M
C114	253 1179 987	Ceramic 470pF/50V	CK45B1H471K
C311,312	254 4313 947	Electrolytic 4.7 μ F/50V	CE04W1H4R7M(ASF)
C313-316	254 4260 977	Electrolytic 4.7 μ F/50V	CE04W1H4R7M
C317	255 4235 934	Film 0.01 μ F/100V	CQ93P2A103J(NH)
C318	254 4260 977	Electrolytic 4.7 μ F/50V	CE04W1H4R7M
C319	254 4356 713	Electrolytic 100 μ F/50V	CE04W1H101MC(ARS)
C320	254 4356 726	Electrolytic 22 μ F/50V	CE04W1H220MC(ARS)
C603	255 4235 057	Film 0.1 μ F/100V	CQ93P2A104J(NH)
C604	254 4256 790	Electrolytic 2200 μ F/16V	CE04W1E222MC
C605	255 4235 057	Film 0.1 μ F/100V	CQ93P2A104J(NH)
C606	254 4252 930	Electrolytic 100 μ F/10V	CE04W1A101M
C607	255 4235 976	Film 0.015 μ F/100V	CQ93P2A153J(NH)
C608,609	254 4260 948	Electrolytic 1 μ F/50V	CE04W1H010M
C610	254 4250 945	Electrolytic 330 μ F/6.3V	CE04W0J331M

Ref. No.	Part No.	Part Name	Remarks	Ref. No.	Part No.	Part Name	Remarks
C611	254 4252 943	Electrolytic 220μF/10V	CE04W1A221M	CN6A	205 0233 061	6P EH connector base	
C612	254 4252 927	Electrolytic 47μF/10V	CE04W1A470M	CN8A	205 0343 087	8P connector base (KR-PH)	
C616	253 1181 917	Ceramic 0.022μF/50V	CK45F1H223Z	CN9A	205 0343 090	9P connector base (KR-PH)	
C617	254 4260 980	Electrolytic 10μF/50V	CE04W1H100M				
C618	254 4252 930	Electrolytic 100μF/10V	CE04W1A101M	CB8A	205 0343 087	8P connector base (KR-PH)	
C619	253 1181 917	Ceramic 0.022μF/50V	CK45F1H223Z	CB9A	205 0279 096	9P SID connector base	
C620	254 4250 945	Electrolytic 330μF/6.3V	CE04W0J331M				
C621	254 4254 789	Electrolytic 1000μF/16V	CE04W1C102MC	P005	205 0864 003	M3 screw terminal	
C622-624	253 1181 917	Ceramic 0.022μF/50V	CK45F1H223Z	P007	205 0864 003	M3 screw terminal	
C625	254 4260 935	Electrolytic 0.47μF/50V	CE04W1HR47M		001 0185 025	Vinyl wire	
C626	254 4260 948	Electrolytic 1μF/50V	CE04W1H010M				
C627	256 1034 982	Metallized 0.12μF/50V	CF93A1H124J				
C628	254 4260 922	Electrolytic 0.33μF/50V	CE04W1HR33M				
C703,704	255 4237 961	Film 150pF/100V	CQ93P2A151J(NH)				
C705,706	255 4232 937	Film 1000pF/100V	CQ93P2A102J(NH)				
C707,708	254 4313 950	Electrolytic 100μF/50V	CE04W1H101M(ASF)				
C711,712	255 4232 995	Film 3300pF/100V	CQ93P2A332J(NH)				
C713,714	254 4313 950	Electrolytic 100μF/50V	E04W1H101M(ASF)				
C715,716	254 4313 918	Electrolytic 10μF/50V	E04W1H100M(ASF)				
C717,718	255 4237 945	Film 1200pF/100V	CQ93P2A122J(NH)				
C719,720	255 4236 713	Film 0.068μF/100V	CQ93P2A683J(NH)				
C721,722	255 4237 958	Film 0.018μF/100V	CQ93P2A183J(NH)				
C723,724	255 4232 937	Film 1000pF/100V	CQ93P2A102J(NH)				
C727,728	255 4235 743	Film 0.022μF/100V	CQ93P2A223J(NH)				
C731,732	254 4368 934	Electrolytic 100μF/25V	E04W1E101M(ASF)				
C801,802	256 1042 903	Metallized 0.1μF/250V	CF93A2E104K				
C805,806	255 4235 057	Film 0.1μF/100V	CQ93P2A104J(NH)				
OTHER PARTS GROUP							
XL101	399 0191 903	Resonator CST4.00MGW	4MHz				
RL301-306	214 0127 003	Relay (RY-12W)					
RL601	214 0127 003	Relay (RY-12W)					
SW101	2120332 009	Rotary switch					
SW301	212 4331 006	Slide switch (4-6) remote					
SW701	212 4728 004	1P push switch					
U301-304	204 8530 006	4P pin jack					
	203 0629 019	1P contact Ass'y					
CN3B	205 0653 036	3P VH connector base					
CN3C	205 0343 032	3P connector base (KR-PH)					
CN4A	205 0233 045	4P EH connector base					
CN5A	205 0233 058	5P EH connector base					
CN5B	205 0343 058	5P connector base (KR-PH)					
CN5E,5F	205 0343 058	5P connector base (KR-PH)					

EXPLODED VIEW

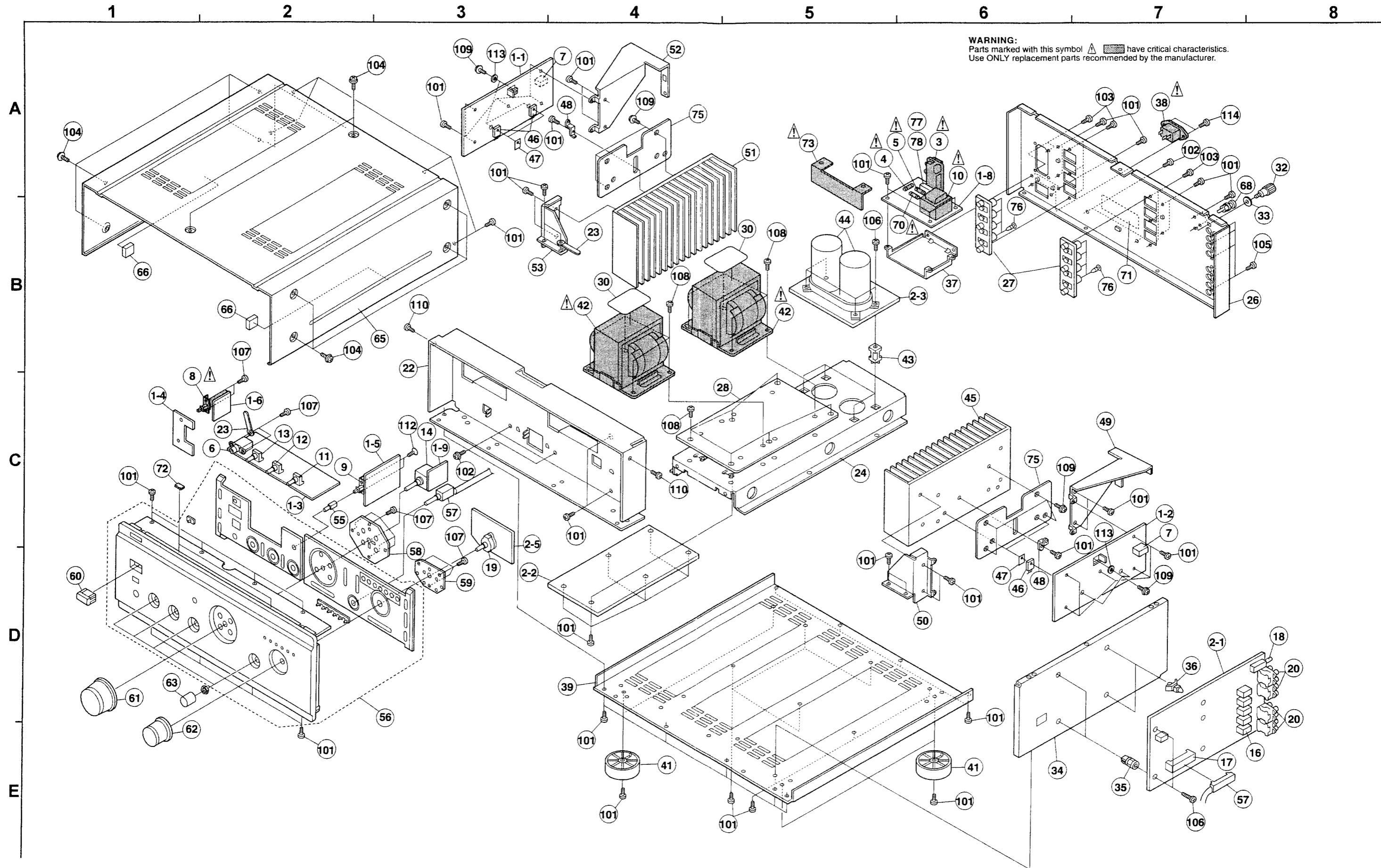

PARTS LIST OF EXPLODED VIEW

Ref. No.	Part No.	Part Name	Remarks	Q'ty	Ref. No.	Part No.	Part Name	Remarks	Q'ty
1	1U- 2916 C	Power amp unit Ass'y		1s	45	417 0534 114	Power radiator (R)		1
1-1	1U- 2916 C-1	Power amp unit (L)		(1)	46	275 0095 004	Transistor 2SK851	TR521-524	4
1-2	1U- 2916 C-2	Power amp unit (R)		(1)	47	415 0234 007	Insulating sheet	TR521-524	4
1-3	1U- 2916 C-3	Control unit		(1)	48	412 4127 001	PWB bracket (B)		2
1-4	1U- 2916 C-4	P LED unit		(1)	49	412 4116 203	Radiator bracket (R)		1
1-5	1U- 2916 C-5	S direct switch unit		(1)	50	412 4114 001	Radiator bracket (B)		1
1-6	1U- 2916 C-6	P switch unit		(1)	51	417 0534 101	Power radiator (L)		1
1-8	1U- 2916 C-8	AC outlet unit		(1)	52	412 4115 204	Radiator bracket (L)		1
1-9	1U- 2916 C-9	Main VR unit		(1)	53	412 4113 002	Radiator bracket (A)		1
2	1U- 2917 C	Input unit Ass'y		1s	54	445 8004 007	Wire clamber		34
2-1	1U- 2917 C-1	Input unit		(1)	55	113 1356 062	Push knob (MARU)	SOURCE DIRECT	1
2-2	1U- 2917 C-2	Protector unit		(1)	56	144 2510 225	Front panel Ass'y		1
2-3	1U- 2917 C-3	Power supply unit		(1)	57	212 4799 004	Rotary remote switch	REC OUT SELECTOR	1
2-5	1U- 2917 C-5	F sw unit		(1)	58	441 1780 119	Plate (M)	VOLUME	1
3	203 3975 003	AC outlet (E2)		1	59	441 1781 008	Plate (F)	INPUT SELECTOR	1
4,5	206 1015 016	Fuse (1.25A)	F001,002	2	60	113 9213 039	Power knob Ass'y		1
6	204 8480 004	Head phone jack (SW)	HP501	1	61	112 0780 005	Knob (M) Ass'y	VOLUME	1
7	214 0129 001	Relay (DH2TU)	RL501,502	2	62	112 9125 108	Knob (F) Ass'y	INPUT SELECTOR	1
8	212 1030 009	Power switch (TV-5)	SW001	1	63	112 0787 008	Knob (MARU) Ass'y	BASS, TREBLE, BALANCE, REC OUT SELECTOR	4
9	212 1157 005	1P push switch	SW201 (SOURCE DIRECT)	1	65	102 0574 104	Top cover		1
10	233 8058 009	Power trans (mini-E2)	T001	1	66	461 9036 005	Spacer (15x15xT5)	Top cover	2
11	211 0798 103	Variable resistor 100 kohm	VR201 (BALANCE)	1	68	209 0012 006	Short pin		2
12	211 0834 012	Variable resistor 10 kohm	VR202 (TREBLE)	1	70	206 1015 087	Fuse (4A)	F003	1
13	211 0834 009	Variable resistor 30 kohm	VR203 (BASS)	1	71	513 1581 008	Serial No. sheet		1
14	211 0873 002	Variable resistor 30 kohm	VR351 (VOLUME)	1	72	461 0867 008	Arm cushion		2
16	214 0127 003	Relay (RY-12W)	RL301-306,601	7	73	414 0793 008	Cover (AC)		1
17	212 4331 006	Slide switch (4-6) remote	SW301	1	75	417 0540 001	CU plate		2
18	212 4728 004	1P push switch	SW701(MM/MC)	1	76	477 0096 007	Push rivet		8
19	212 0332 009	Rotary switch	SW101 (INPUT SELECTOR)	1	77	461 0550 085	Rubber pad		1
20	204 8530 006	4P pin jack	U301-304	4	78	415 0680 017	Spacer		1
22	411 1341 007	Front chassis		1	WIRES				
23	445 0048 016	Cord holder	L=50	2	203 4871 083	3P KR-KR ribbon cable	CN3C to CB3C		1
24	411 1346 109	Trans chassis		1	203 5161 006	3P VH-VH connector cord	CN3B to CB3B		1
26	105 1196 124	Back panel		1	203 6473 010	4P EH-EH connector cord			1
27	205 1014 205	4P terminal Ass'y	SPEAKER	2	203 8465 000	5P EH-EH connector cord	CN5A to CB5B		1
28	412 4141 003	Trans bracket		1	203 8342 055	5P KR-KR ribbon cable			1
30	513 1606 006	Power trans label (A)		2	203 8342 039	5P KR-KR ribbon cable			1
32	205 0071 016	GND terminal Ass'y		1	203 8342 039	5P KR-KR ribbon cable			1
33	477 0018 001	Washer (P-87)		1	204 0519 009	6P EH-EH connector cord	CN6A to CB6A		1
34	414 0765 007	Shield plate		1	204 2547 095	8P KR-KR ribbon cable	CN8A to CB8A		1
35	443 9015 002	P.W. spacer (H=8)		2	204 2550 040	9P KR-KR ribbon cable	CN9A to CB9A		1
36	415 9016 019	P.W. holder (H=8)		2	001 0202 005	Vinyl wire			1
37	412 4112 100	PWB bracket (A)		1	001 0202 018	Vinyl wire			1
38	203 3970 008	AC inlet		1	001 0202 021	Vinyl wire			1
39	105 1197 204	Bottom cover		1	001 0202 034	Vinyl wire			1
41	104 0173 213	Foot Ass'y		4					
42	233 8211 008	Power trans (E2)		2					
43	415 9032 006	P.C.B. holder (T)		4					
44	254 6204 009	Electrolytic 12000µF71V		1					

Ref. No.	Part No.	Part Name	Remarks	Q'ty
	001 0166 086	Vinyl wire	Black	2
	001 0197 055	Vinyl wire	Red	1
	001 0197 068	Vinyl wire	Blue	1
	001 0203 004	Vinyl wire (3C)	3C twist wire	2
	415 0695 015	UL tube	SP terminal wire	2
	415 0767 001	UL tube (16) BK		1
	415 0767 024	UL tube (16) BK		1
	203 0530 014	1P contact Ass'y		1
SCREWS				
101	473 7002 021	Screw 3x8 (S)-B	CBTS(S)-B	86
102	477 0263 005	3P swelling screw		4
103	473 7508 017	Screw 3x10 (P)-B	CBTS(P)-B	8
104	477 0263 018	3P swelling screw		10
105	477 0064 107	Fixing screw		4
106	473 7501 014	Screw 3x14 (P)-Z	CBTS(P)-Z	6
107	473 7500 015	Screw 3x8 (P)-Z	CBTS(P)-Z	11
108	473 7007 000	Screw 4x8 (S)-B	CBTS(S)-B	14
109	473 8007 038	Cup screw 3x14		14
110	473 7003 004	Screw 3x8 (S)-Z	CFTS(S)-Z	2
111	470 0009 022	Screw 3x6 (SW.S)	CPS(SW.S)-Z	6
112	473 7500 028	Screw 3x8 (P)-Z	CFTS (P)-Z	2
113	475 1003 006	3W		2
114	473 7003 017	Screw 3x8 (S)-B	CFTS (S)-B	2
PACKING & ACCESSORIES				
151	504 9102 029	Stylen paper	700x900	1
152	505 9102 019	Poly cover	900x455	1
153	505 8006 019	Envelope		1
154	503 1221 002	Cushion Ass'y		1
155	501 1554 058	Carton case		1
157	511 2946 002	Inst. manual		1
158	515 0671 300	S.S. list (EX)		1
160	206 2147 006	AC cord with connector		1
161	513 1389 006	Control card base		1
162	513 1349 004	Thermal carbon film		1
163	499 0277 004	Remote controller	RC-176	1

WIRING DIAGRAM

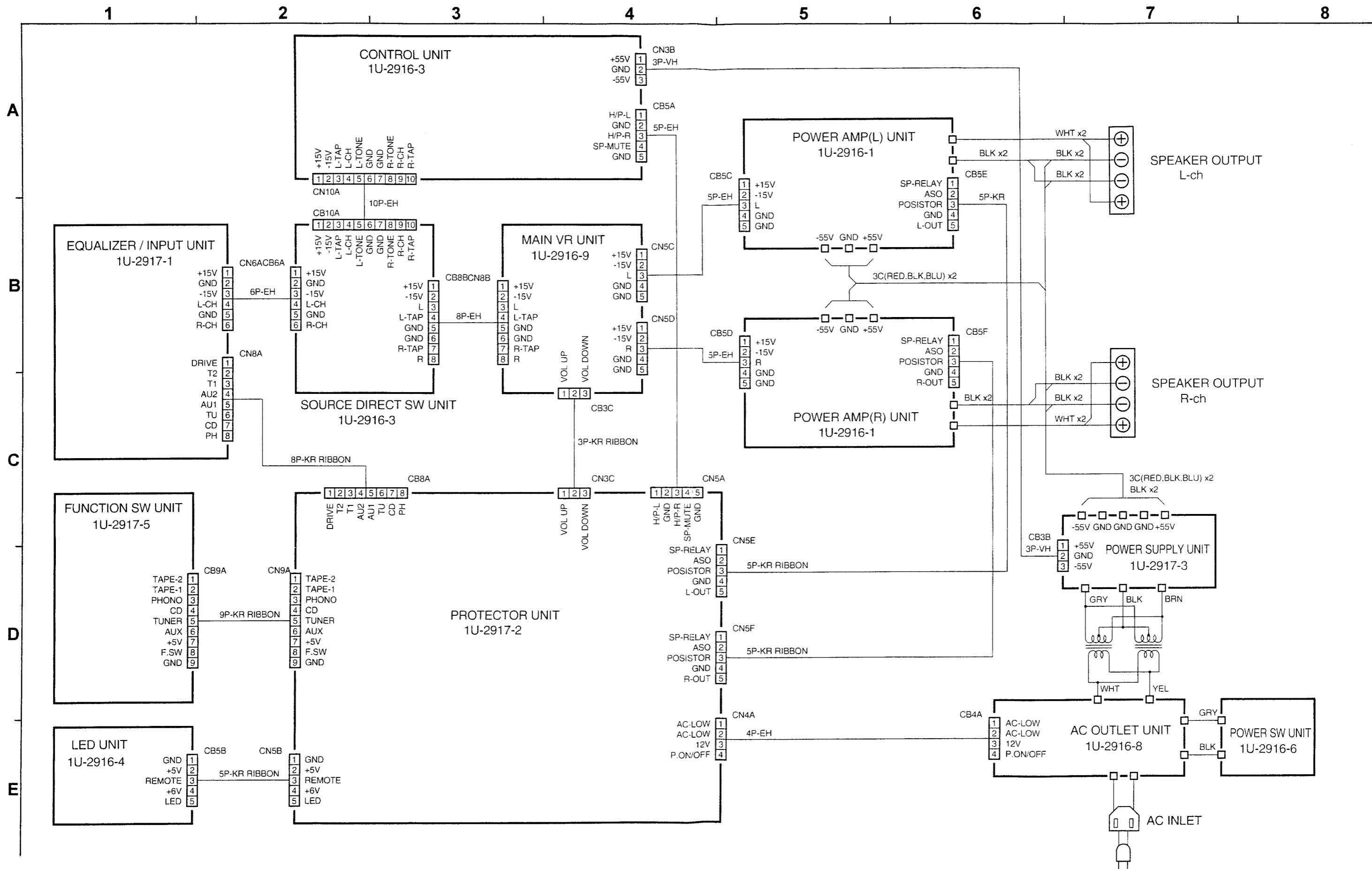

6 7 8 9 10 11

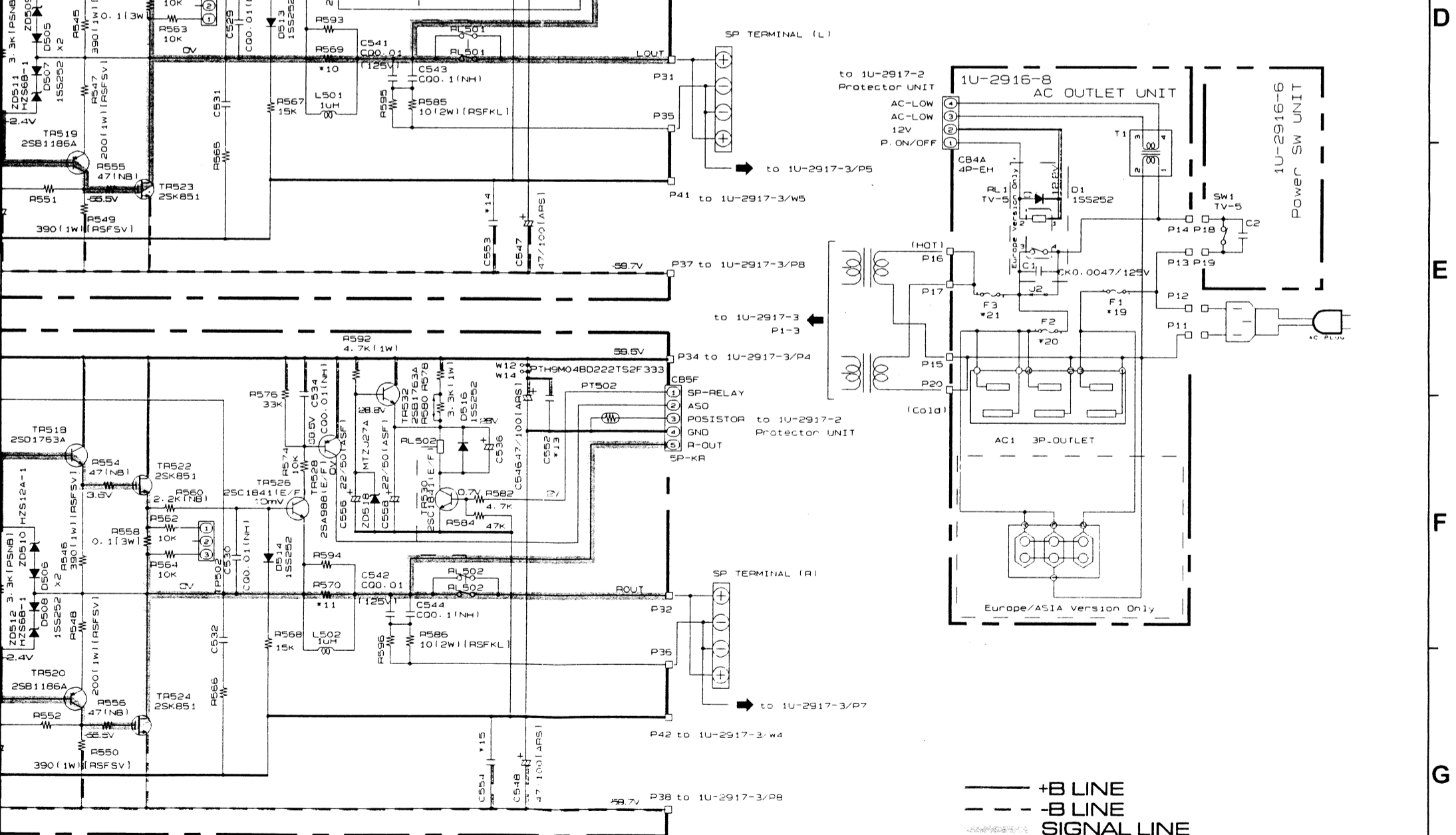
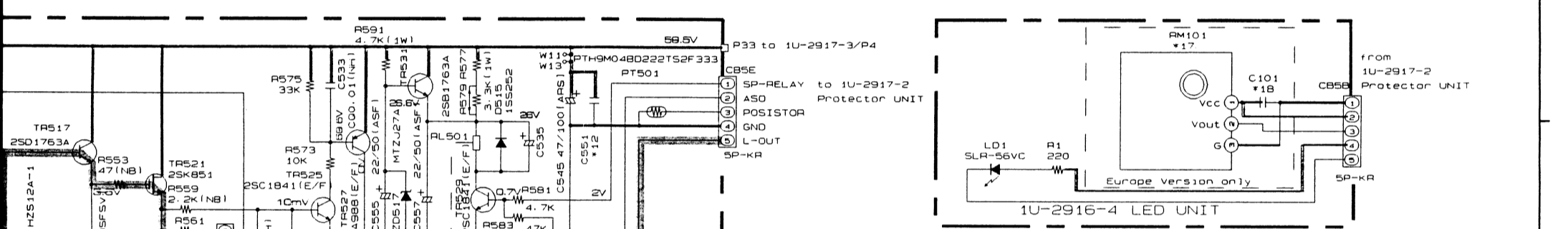
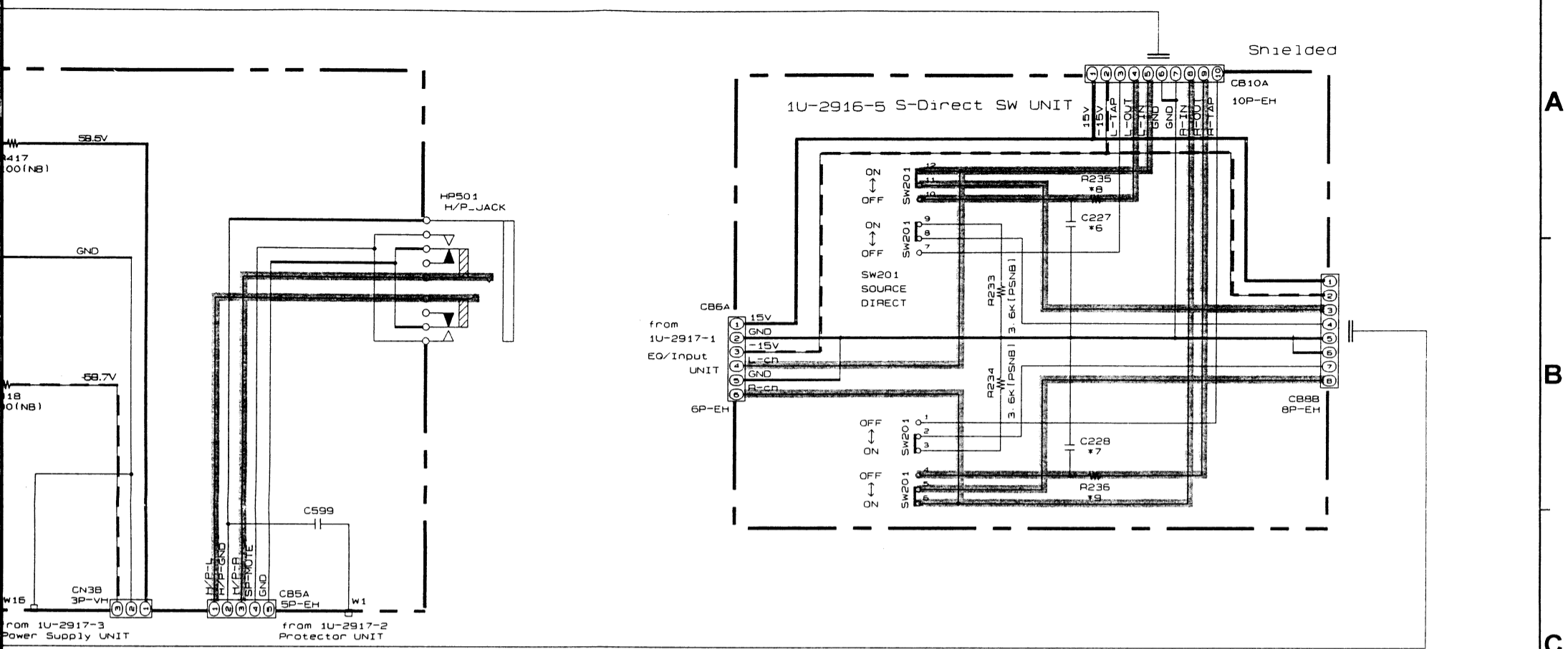

*16 C341	*17 RM101	*18 C101	*19, 20 F1, 2	*21 F3
1uF [50v]	-	-	5A	10A
1uF [63v]	-	-	1.25A	4A
1uF [63v]	-	-	5A	10A
-	SBX1610-52	CKO.012	1.25A	4A

NOTES
 ALL RESISTANCE VALUES IN OHM. k=1,000 OHM, M=1,000,000 OHM
 ALL CAPACITANCE VALUES IN MICRO FARAD. P=MICRO-MICRO FARAD
 EACH VOLTAGE AND CURRENT ARE MEASURED AT NO SIGNAL INPUT CONDITION.
 CIRCUIT AND PARTS ARE SUBJECT TO CHANGE WITHOUT PRIOR NOTICE.

WARNING:
 Parts marked with this symbol have critical characteristics. Use ONLY replacement parts recommended by the manufacturer.

CAUTION:
 Before returning the unit to the customer, make sure you make either (1) a leakage current check or (2) a line to chassis resistance check. If the leakage current exceeds 0.5 milliamps, or if the resistance from chassis to either side of the power cord is less than 240 kohms, the unit is defective.

WARNING:
 DO NOT return the unit to the customer until the problem is located and corrected.

— +B LINE
 - - -B LINE
 ——— SIGNAL LINE

A
 B
 C
 D
 E
 F
 G
 H

SCHEMATIC DIAGRAM

1
2
3
4
5
A
B
C
D
E
F
G
H

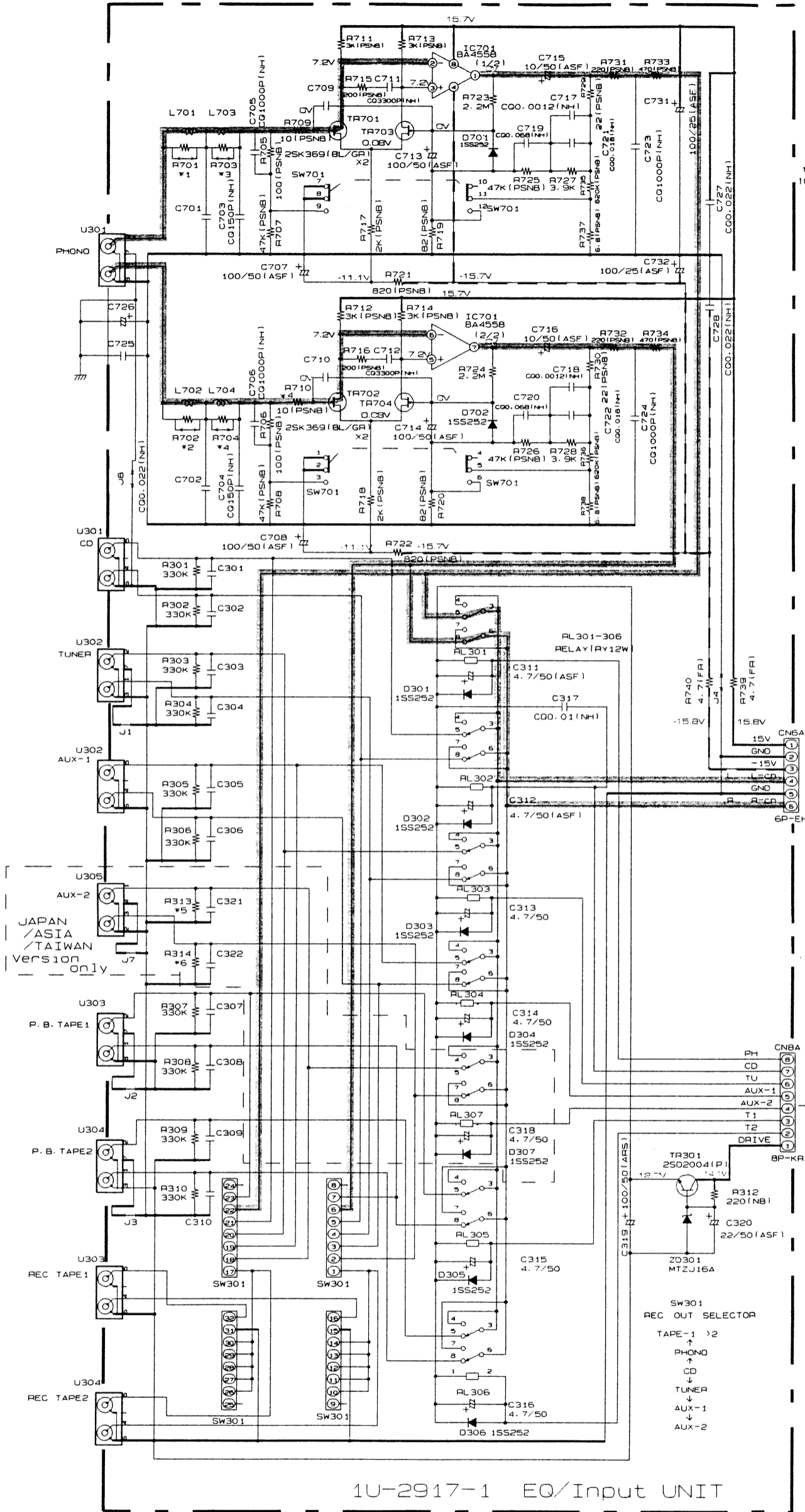

PARTS No.	*1-4	*5, 6	*7, 8	*9	*10	*11, 12, 13	*14, 15	*16, 17
JAPAN	R701-704	R313, 314	J5, 6	J101	R612	C616, 619, 622	C801, 802	C805, 806
ASIA	JW	330kOhm	-	JW	47kOhm	-	COO. 01 (125V)	COO. 01 (125V)
TAIWAN	JW	330kOhm	-	JW	47kOhm	-	CF0. 1 (250V)	COO. 1 (100V)
EUROPE	JW	JW	-	-	15kOhm	CK0. 022Z	CF0. 1 (250V)	COO. 1 (100V)

NOTES
 ALL RESISTANCE VALUES IN OHM. k=1,000 OHM, M=1,000,000 OHM
 ALL CAPACITANCE VALUES IN MICRO FARAD. P=MICRO-MICRO FARAD
 EACH VOLTAGE AND CURRENT ARE MEASURED AT NO SIGNAL INPUT CONDITION.
 CIRCUIT AND PARTS ARE SUBJECT TO CHANGE WITHOUT PRIOR NOTICE.

WARNING:
 Parts marked with this symbol have critical characteristics. Use ONLY replacement parts recommended by the manufacturer.

CAUTION:
 Before returning the unit to the customer, make sure you make either (1) a leakage current check or (2) a line to chassis resistance check. If the leakage current exceeds 0.5 milliamps, or if the resistance from chassis to either side of the power cord is less than 240 kohms, the unit is defective.

WARNING:
 DO NOT return the unit to the customer until the problem is located and corrected.

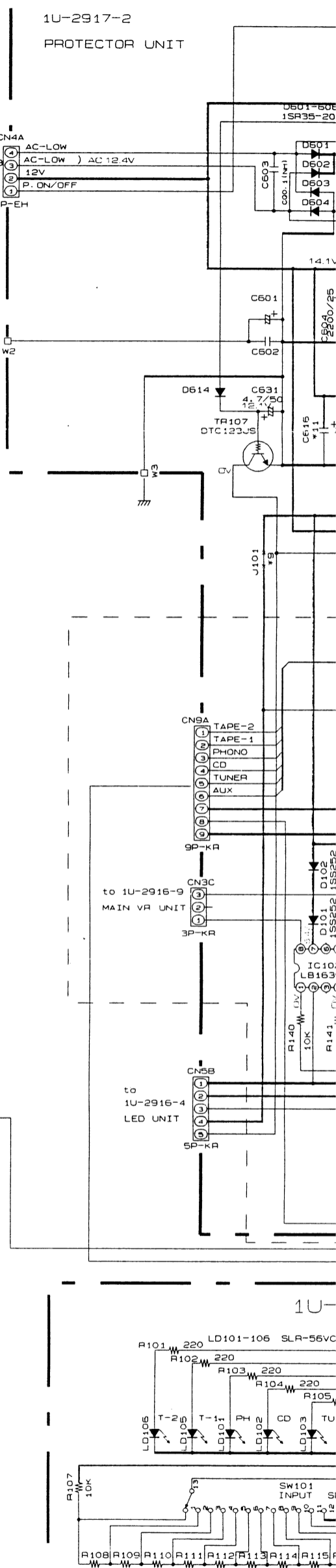

Function SW UNIT for EUROPE

SCHEMATIC DIAGRAM

1
2
3
4
5
A
B
C
D
E
F
G
H

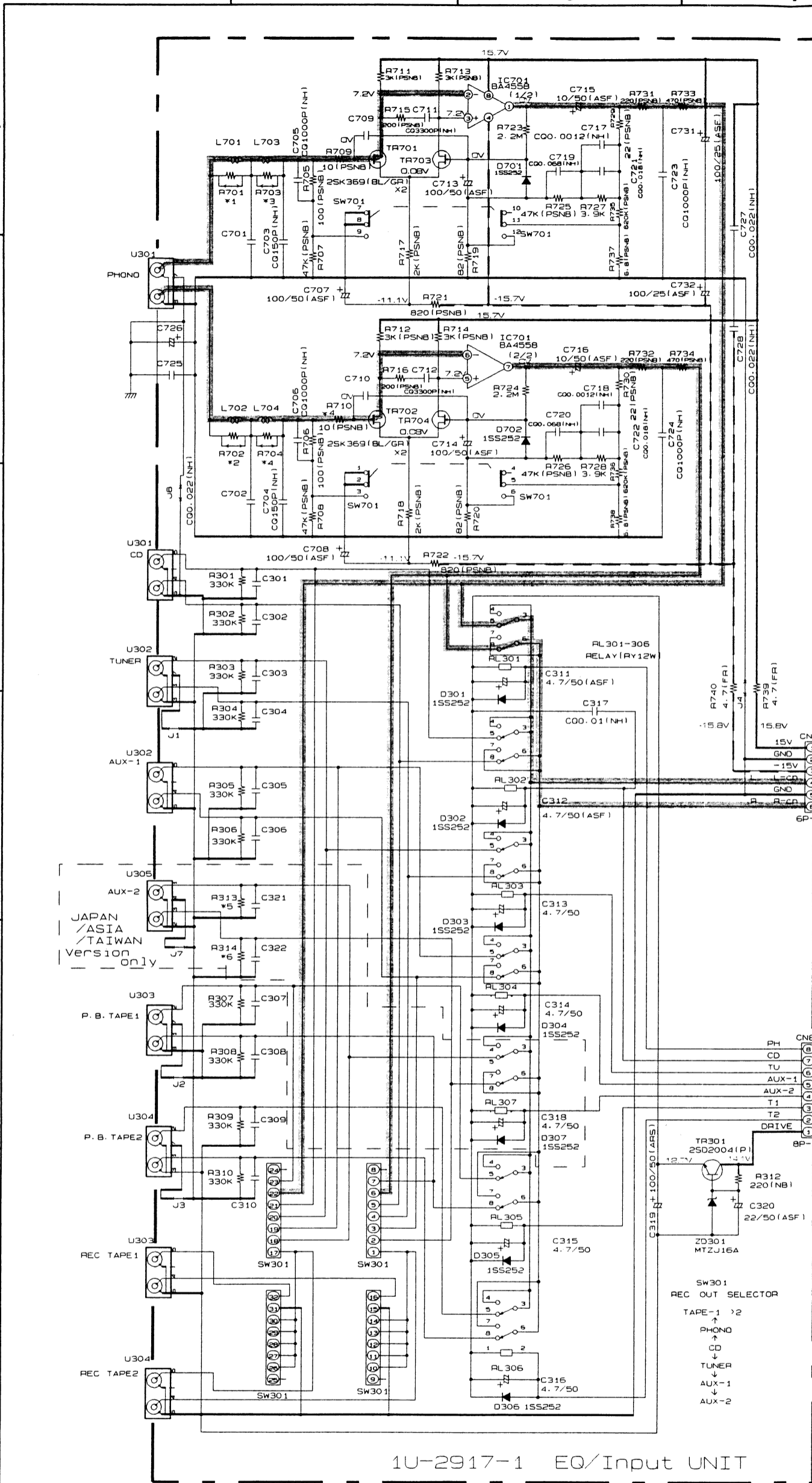

PARTS No.	*1-4	*5, 6	*7, 8	*9	*10	*11, 12, 13	*14, 15	*16, 17
R701-704	R313-314	J5, 6	J101	R612	C616, 619, 622	C801, 802	C805, 806	
JW	330kOhm	-	JW	47kOhm	-	COO. 01 (125V)	COO. 01 (125V)	
ASIA	JW	330kOhm	-	JW	47kOhm	CF0. 1 (250V)	COO. 1 (100V)	
TAIWAN	JW	330kOhm	-	JW	47kOhm	CF0. 1 (250V)	COO. 1 (100V)	
EUROPE	JW	JW	-	-	15kOhm	CF0. 1 (250V)	COO. 1 (100V)	

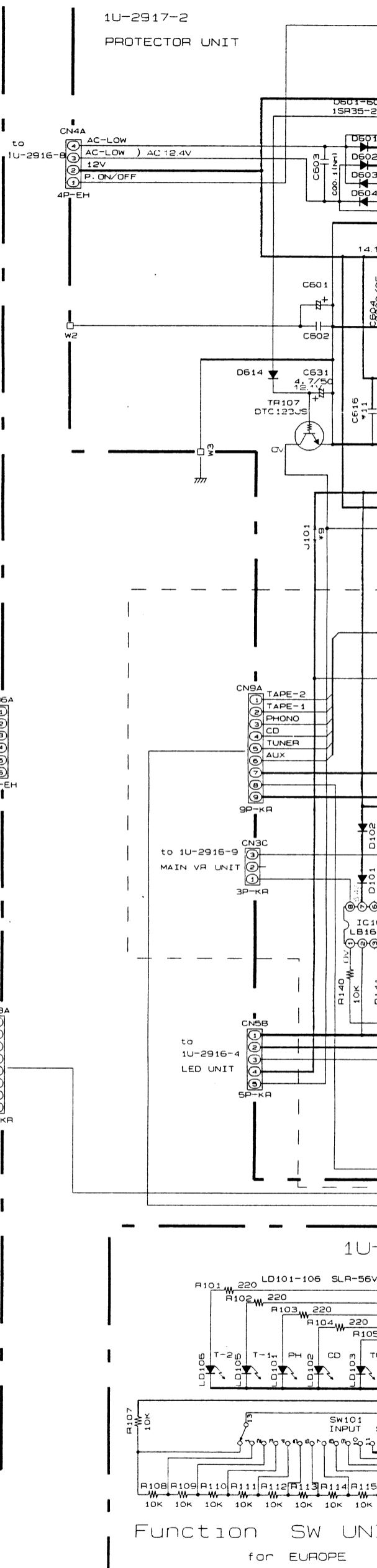

Function SW UNIT for EUROPE

NOTES
 ALL RESISTANCE VALUES IN OHM. k=1,000 OHM, M=1,000,000 OHM
 ALL CAPACITANCE VALUES IN MICRO FARAD. P=MICRO-MICRO FARAD
 EACH VOLTAGE AND CURRENT ARE MEASURED AT NO SIGNAL INPUT CONDITION.
 CIRCUIT AND PARTS ARE SUBJECT TO CHANGE WITHOUT PRIOR NOTICE.

WARNING:
 Parts marked with this symbol have critical characteristics. Use ONLY replacement parts recommended by the manufacturer.

CAUTION:
 Before returning the unit to the customer, make sure you make either (1) a leakage current check or (2) a line to chassis resistance check. If the leakage current exceeds 0.5 millamps, or if the resistance from chassis to either side of the power cord is less than 240 kohms, the unit is defective.

WARNING:
 DO NOT return the unit to the customer until the problem is located and corrected.

1U-2917-2
PROTECTOR UNIT

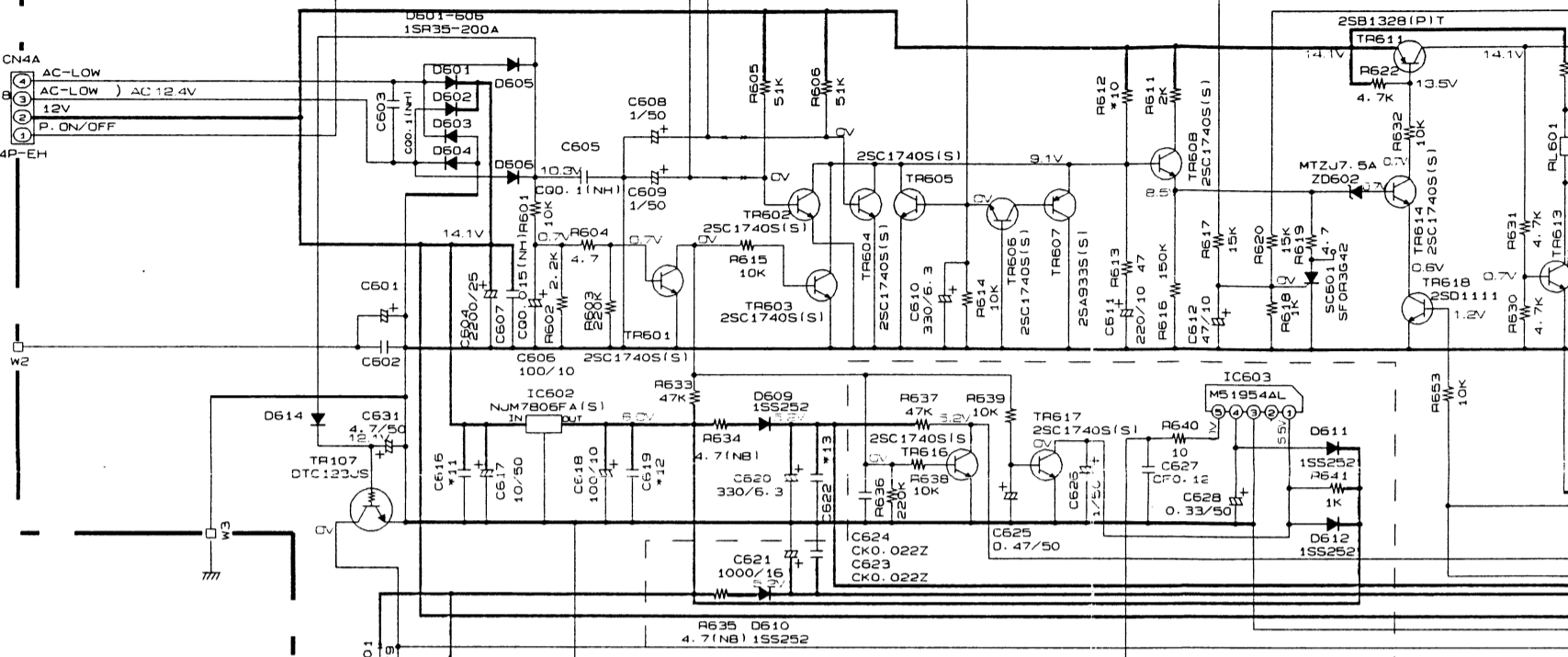

Europe Version Only
[J101 CUT]

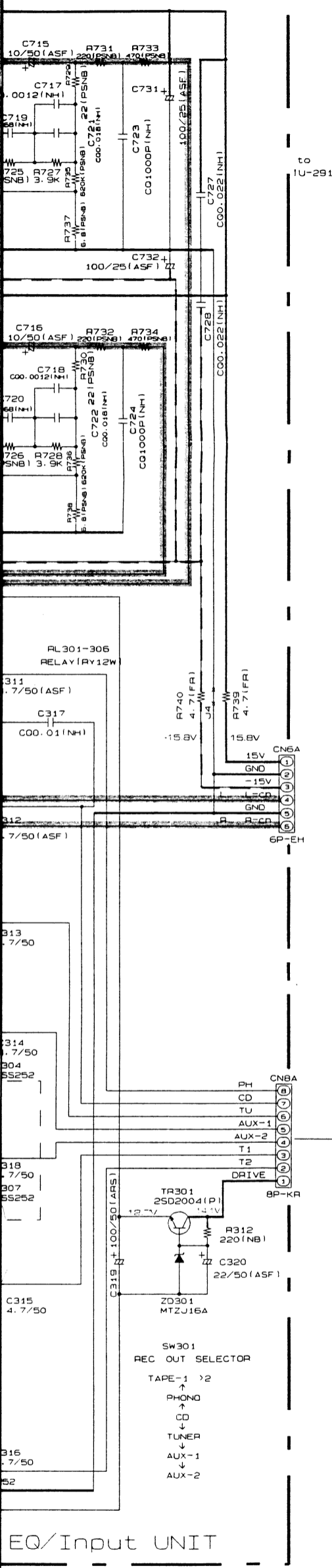
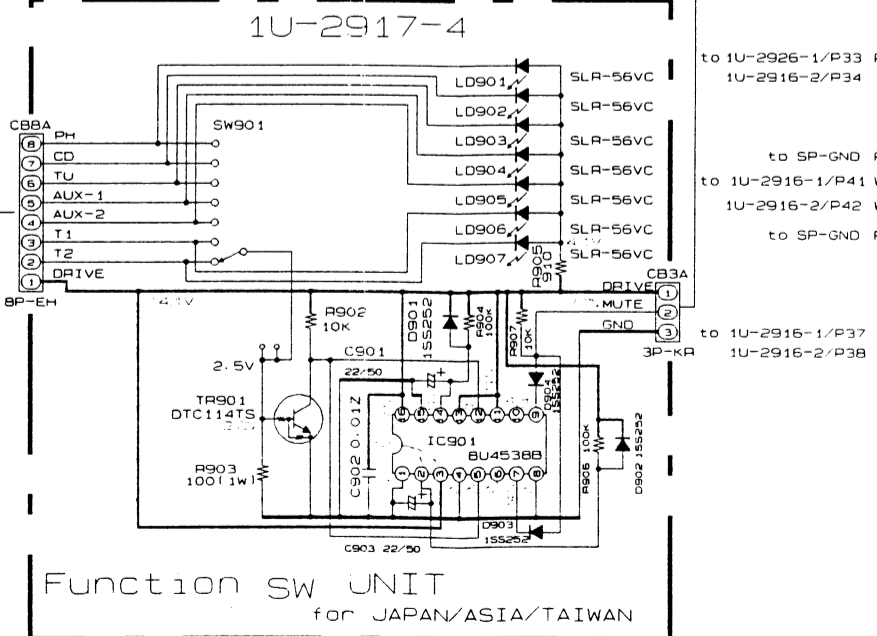
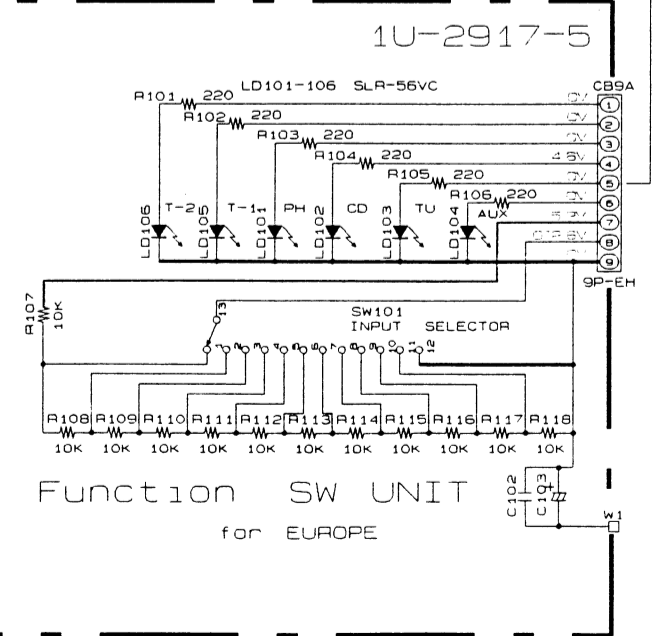
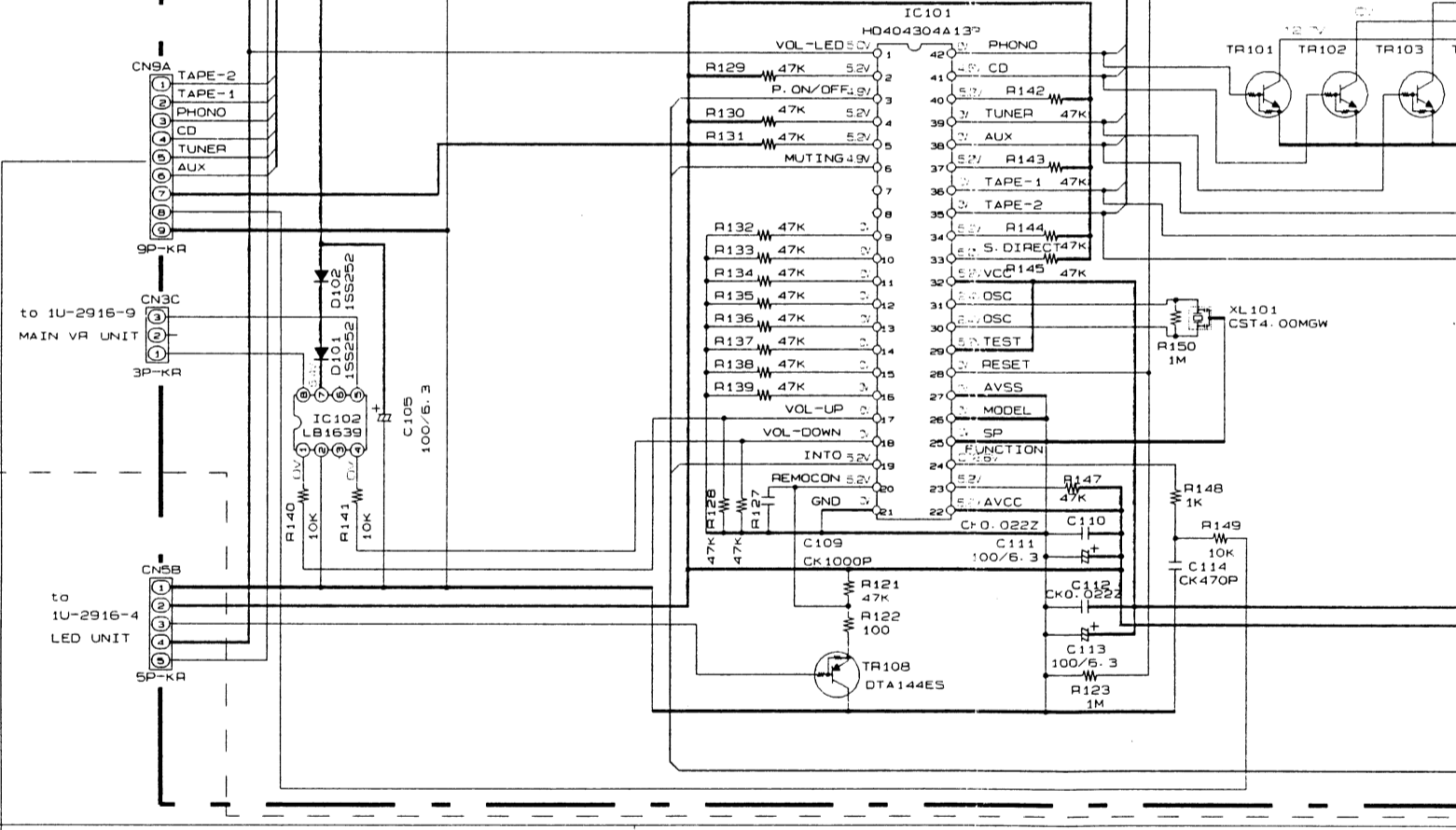

*11. 12. 13	*14. 15	*16. 17
C615. 619. 622	C801. 802	C805. 806
-	C00. 01 (125V)	C00. 01 (125V)
-	CF0. 1 (250V)	C00. 1 (100V)
-	CF0. 1 (250V)	C00. 1 (100V)
CK0. 022Z	CF0. 1 (250V)	C00. 1 (100V)

with this symbol have critical characteristics. Replacement parts recommended by the manufacturer.

When returning the unit to the customer, make sure you make either (1) a continuity check or (2) a line to chassis resistance check. If the leakage current exceeds 0.5 milliamps, or if the resistance from chassis to either side of the power cord is less than 240 kohms, the unit is defective.

Do not return the unit to the customer until the problem is located and corrected.

