

DENON

Hi-Fi Stereo Power Amplifier

SERVICE MANUAL MODEL POA-1500

STEREO POWER AMPLIFIER



CONTENTS

SPECIFICATIONS	1
DESCRIPTION OF PARTS AND THEIR FUNCTION	2
CONNECTIONS	3
TROUBLE SHOOTING	4
METHOD OF ADJUSTMENT	5,6
SEMICONDUCTORS	6
PRINTED WIRING BOARD PATTERNS AND PARTS LIST	
CONTROL & P.S. UNIT (ETC0627D/C/B)	7, 8
POWER AMP & POWER SOURCE UNIT (PUS0021L)	9,10
CONNECTION DIAGRAM	11
WIRING DIAGRAM	12
EXPLODED VIEW	13

NIPPON COLUMBIA CO., LTD.

SPECIFICATIONS

POWER AMPLIFIER

Rated Output Power: (when both channel are used)

20 Hz to 20 kHz 150 W + 150 W (Speaker impedance 8 ohm)
 20 Hz to 20 kHz (Speaker impedance 4 ohm) U.S.A. and MULTI
 1 kHz 150 W + 150 W (IEC) (Subject to change by temperature test)
 150 Watts per channel minimum RMS, both channel driven at 8 ohm from
 20 Hz ~ 20 kHz no more than 0.005% total harmonic distortion. (U.S.A.)

Total Higher Harmonic Distortion: 0.002% (at the rated output provided/-3 dB) speaker impedance assumed to be 8 ohm

Cross Modulation Distortion: 7 kHz/60 Hz: 1/4, less than 0.0015% (at the time of operation with the power amplification equivalent to the rated output) speaker impedance assumed to be 8 ohm

Output Frequency Bandwidth: 5 Hz ~ 80 kHz (IHF)
 (IHF, T.H.D 0.015%), speaker impedance assumed to be 8 ohm

Transmission Characteristic: 1 Hz ~ 300 kHz $\begin{matrix} +0 \\ -3 \end{matrix}$ dB (at an output of 1 W)

Input Level: 1 V (NORMAL)

1.41 V (HIGH CUT FILTER IN)

Input Impedance:

18 k ohm (NORMAL IN)
 25 k ohm (HIGH CUT FILTER IN)

Output Impedance: 0.1 ohm (1 kHz)

SN Ratio (IHF "A"): 123 dB

Hi Cut Filter: 40 kHz 6 dB/oct (FILTER IN)

Subsonic Filter: 16 Hz 6 dB/oct

Slew Rate: ± 400 V/ μ sec

PEAK LEVEL METER OPERATION CHARACTERISTIC

Type of Indication: Peak output level indication

Range of Indication: -50 dB ~ +5 dB

0 dB = 200 W/8 ohm

Frequency Response: 10 Hz ~ 100 kHz ± 3 dB impedance assumed to be 8 ohm

OUTPUT TERMINALS

SPEAKERS: A or B Load 8 - 16 ohm (IEC)
 A + B Load 16 ohm (IEC)

SPEAKERS: A or B Load 4 ohm to 16 ohm, U.S.A. and MULTI
 A + B Load 8 - 16 ohm

SELF-DIAGNOSTIC FUNCTION

Abnormal temperature detection and problem indication
 Left-channel and right-channel abnormal output level check and indication

OTHERS

Power Source: AC 120 V, 60 Hz
 or AC 110/120/220/240 V, 50 Hz
 or AC 220 V, 50 Hz
 or AC 240 V, 50 Hz

Power Consumption: 300 W (IEC)
 380 W (U.S.A. and MULTI)

Dimensions: 470 x 168 x 418 (including control knobs, and stand)

Weight: 20 kg

* POA-1500 design and specifications are subject to change without notice.

NOTE: The following codes correspond to the appropriate models.
 E3 for U.S.A., EC for Canada, E2 for Europe, and E1 for Hong Kong, Singapore.
 This Service Manual is prepared based on E3.

DESCRIPTION OF PARTS AND THEIR FUNCTION

FRONT PANEL VIEW

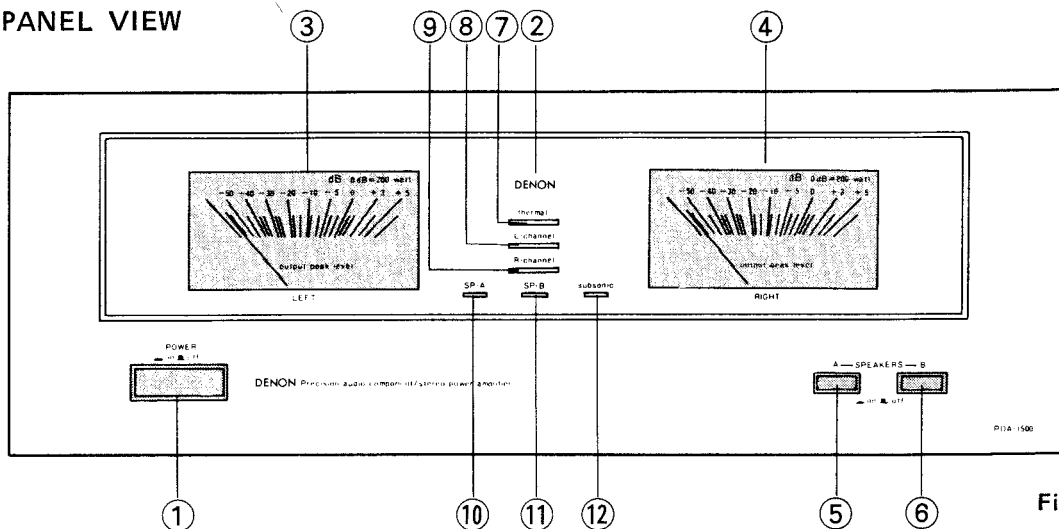

Fig. 1

- ① POWER (power switch)
- ② POWER SOURCE INDICATOR (power supply pilot lamp)
- ③ ④ OUTPUT PEAK LEVEL (peak output meter)
- ⑤ ⑥ SPEAKERS (speaker selector switches)
 - SPEAKERS-A, ● SPEAKERS-B
- ⑦ ⑧ ⑨ SELF-DIAGNOSIS (self-diagnostic result indicators lamps)
 - ⑦ Thermal protector lamp
 - ⑧ Left-channel output level indicator lamp
 - ⑨ Right-channel output level indicator lamp
- ⑩ ⑪ SPEAKERS-A/B INDICATOR LAMPS
- ⑫ SUBSONIC ON INDICATOR LAMP

BACK PANEL VIEW

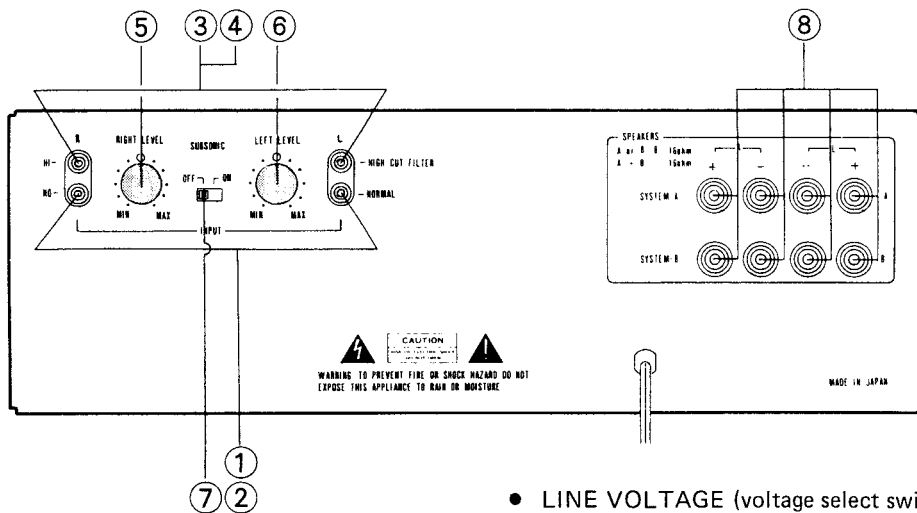

Fig. 2

- ① ② INPUTS (normal)
 - ① INPUT for the right-channel
 - ② INPUT for the left-channel
- ③ ④ INPUTS (for the high-frequency cutoff filters)
 - ③ INPUT for the right-channel
 - ④ INPUT for the left-channel
- ⑤ RIGHT LEVEL (right-channel input level control)
- ⑥ LEFT LEVEL (left-channel input level control)
- ⑦ SUBSONIC (subsonic-filter switch)
- ⑧ SPEAKER (speaker connecting terminals)
- LINE VOLTAGE (voltage select switch) (NOT INCLUDED IN SYSTEMS FOR EUROPE OR CANADA, U.S.A. USE)

* It is possible to change the voltage by turning the VOLTAGE SELECTOR on the back panel using a screw driver.

* Do not twist the VOLTAGE SELECTOR with abnormal force.

* If the voltage switch is not easy, contact your local DENON dealer.

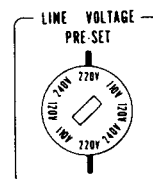
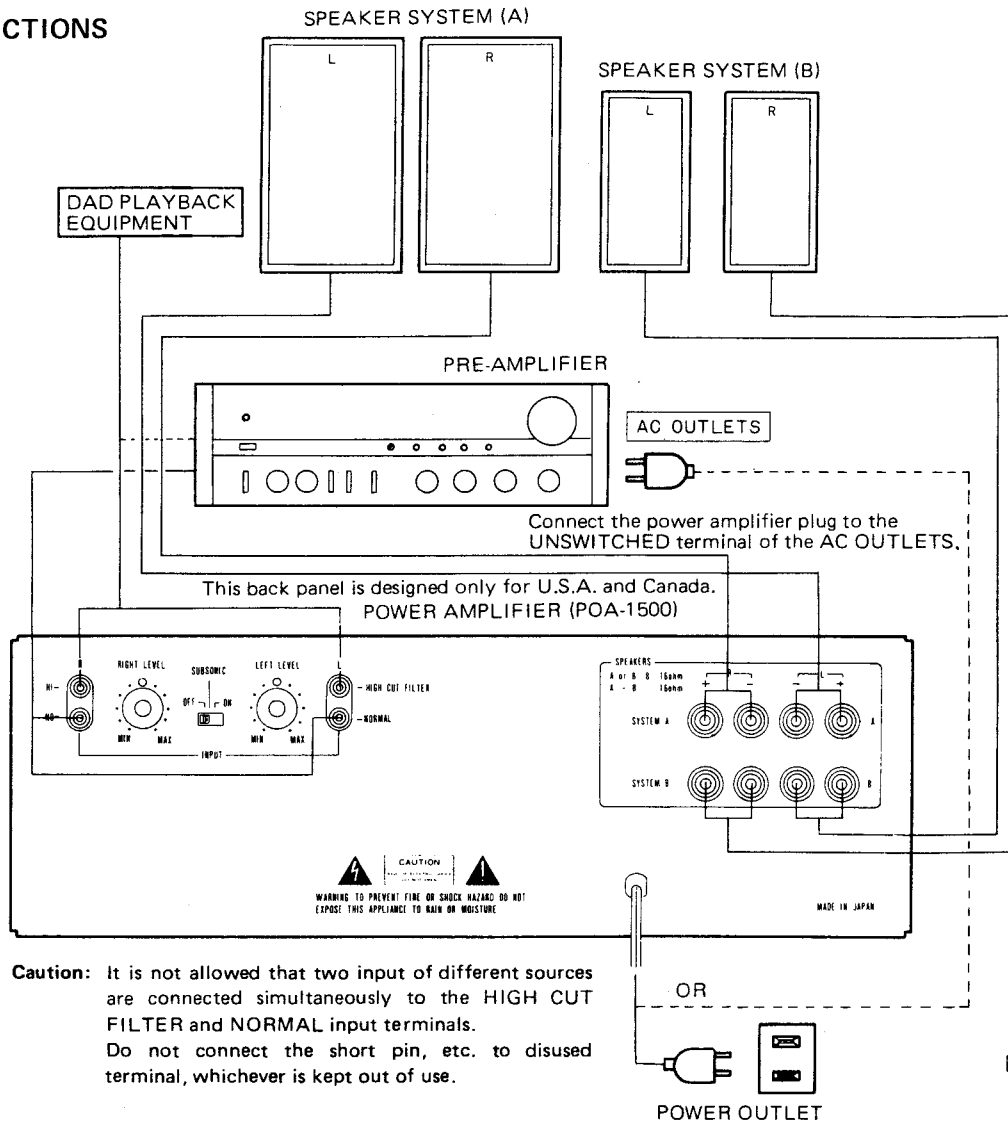

Fig. 3

CONNECTIONS



Caution: It is not allowed that two input of different sources are connected simultaneously to the HIGH CUT FILTER and NORMAL input terminals. Do not connect the short pin, etc. to disused terminal, whichever is kept out of use.

Fig. 4

PRECAUTIONS ON CONNECTION

- Do not insert the power cord into the socket before all the connections are completed.
- After confirming the right and left channels, connect L with L and R with R.
- Firmly insert the plug. An imperfect connection may cause noise.
- If a pin plug and power cord are bundled together or if a pin cord is placed near a power transformer, hum or noise may result.

BLOCK DIAGRAM

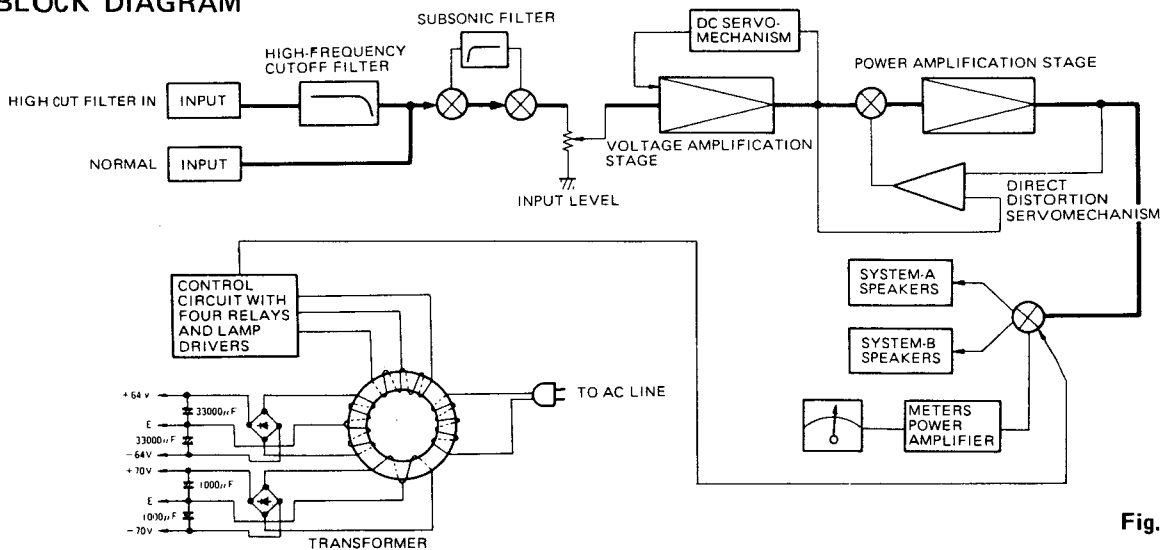

Fig. 5

TROUBLE SHOOTING

Before troubleshooting, be sure your audio system is really in trouble or not.

1. Check all connections for correctness.
2. See that your audio system is being operated according to the instruction manual.
3. Check that the speakers and pre-amplifier are working properly.

In case the POA-1500 fails to provide normal performance, check it referring to the following troubleshooting chart.

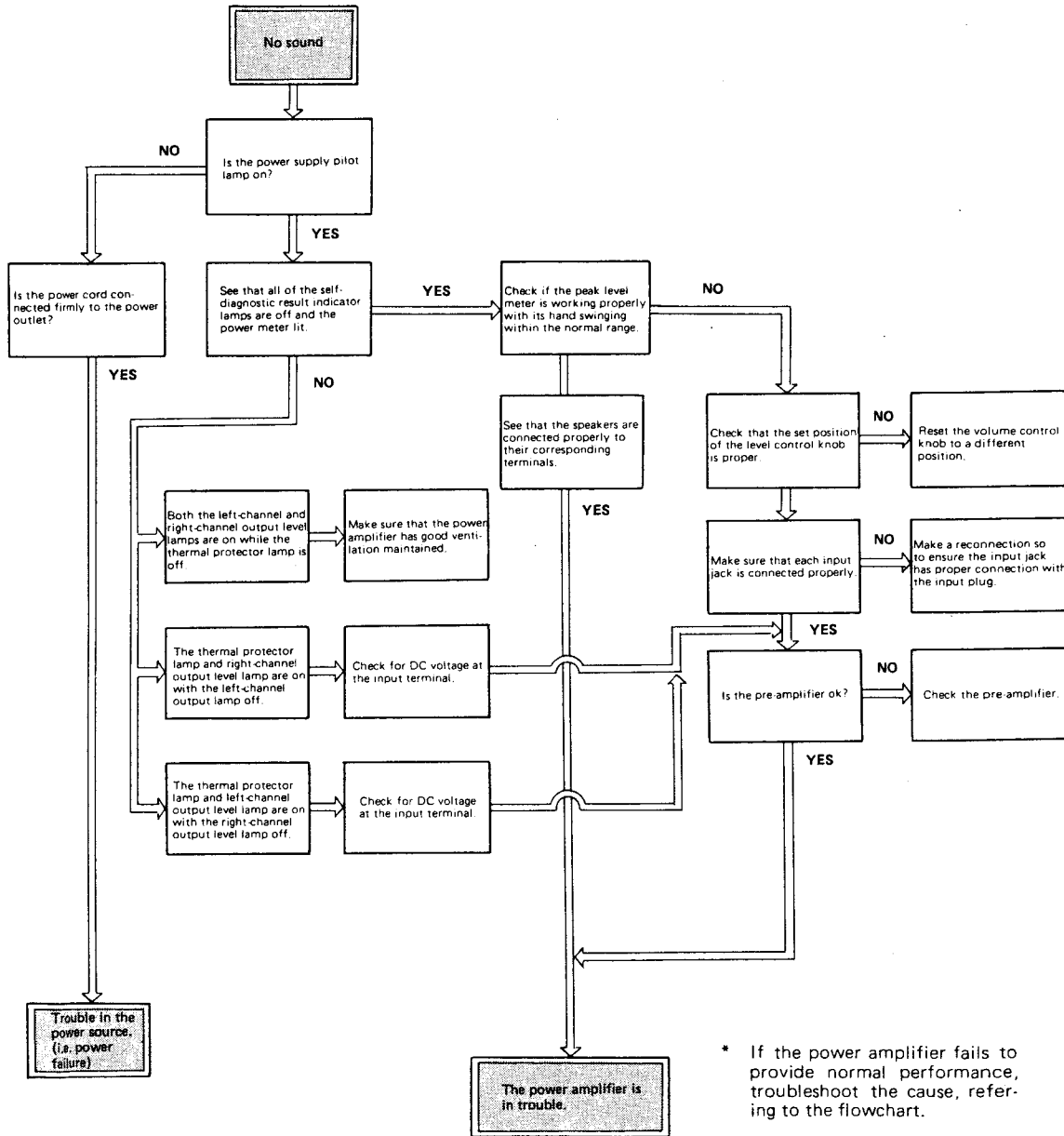

* If the power amplifier fails to provide normal performance, troubleshoot the cause, referring to the flowchart.

Fig. 6

METHOD OF ADJUSTMENT

IDLING CURRENT

- 1 Connect digital voltmeter to TP1 (Rch) terminal of PUS0021L-1 and TP2 (Lch) terminal of PUS0021L-2.
- 2 Turn power "on", after 2 to 3 minutes warming up, adjust VR1 (Rch) and VR2 (Lch) so that the digital voltmeter indicates $15 \pm 1\text{mV}$.

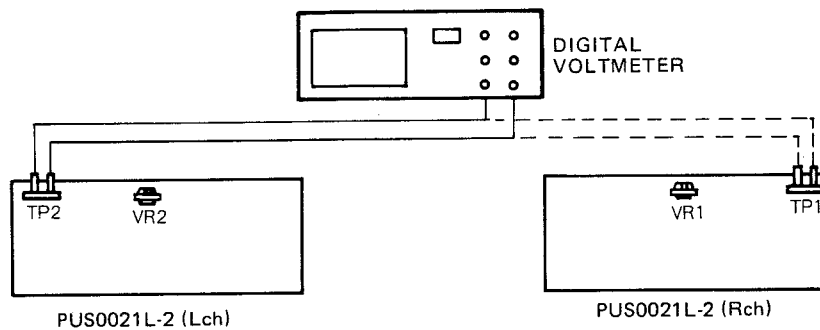

Fig. 7

NEUTRAL POINT

- 1 Connect digital voltmeter to speaker terminals "A".
- 2 Turn power switch "on".
- 3 Set main volume control on rear panel to MAX.
- 4 See to it that the digital voltmeter indicates less than 100mV.

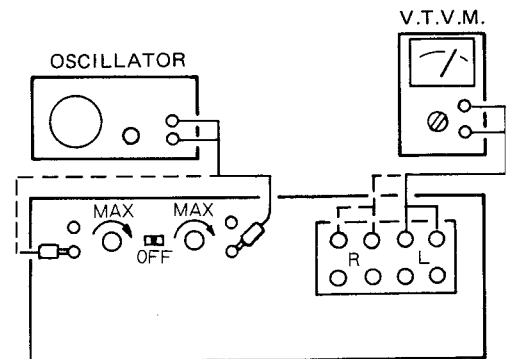

Fig. 8

METER ADJUSTMENT

- 1 Connect oscillator to input terminals "NORMAL".
- 2 Connect V.T.V.M. to speaker terminals "A".
- 3 Turn power switch "on" and set main volume control to MAX.
- 4 Set the oscillator frequency to 1 kHz, and adjust the oscillator output level so that the speaker output level to 40 V.
- 5 Adjust VR3 (L ch), VR4 (Rch) on ETC027-1 so that the meter indicates 0 dB.
- 6 Set ATT. to -10 dB, and check meter indicates $-10 \text{ dB} \pm 1.5 \text{ dB}$.
- 7 Set ATT. to -20 dB, and check meter indicates $-20 \text{ dB} \pm 2 \text{ dB}$.

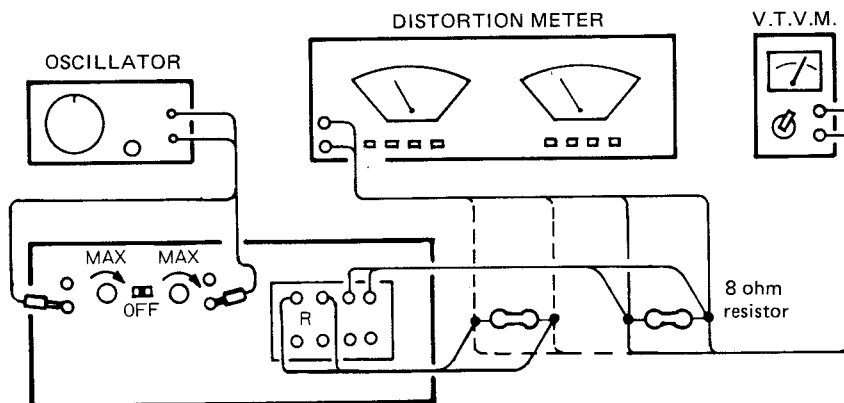
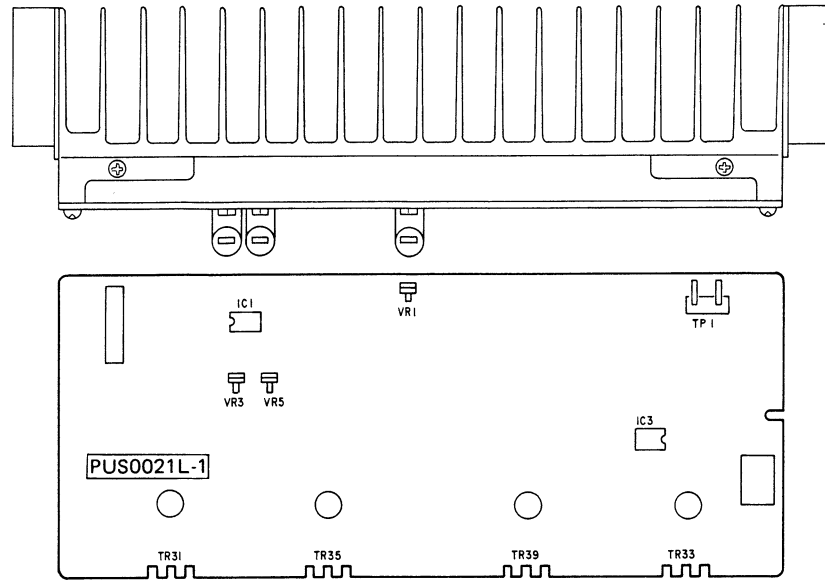

Fig. 9

DISTORTION

- 1 Connect oscillator to input terminals "NORMAL". (at the same time input L and R ch)
- 2 Connect 8 ohm dummy load to speaker terminals "A" and apply distortion meter with V.T.V.M.
- 3 Turn power switch "on".
- 4 Set main volume control to MAX.
- 5 Set the oscillator frequency to 1 kHz, and adjust oscillator output level so that the speaker output level $24.5\text{V}/75\text{W}$.
- 6 Adjust VR3 (Rch) and VR4 (Lch) for minimum distortion.
- 7 Set the oscillator output level to 20 kHz, and adjust oscillator output level so that the speaker output level $24.5\text{V}/75\text{W}$.
- 8 Adjust VR5 (Rch) and VR6 (Lch) for minimum distortion.

PUS0021L-1 P.A & P.S UNIT For Rch.



PUS0021L-2 P.A & P.S UNIT For Lch.

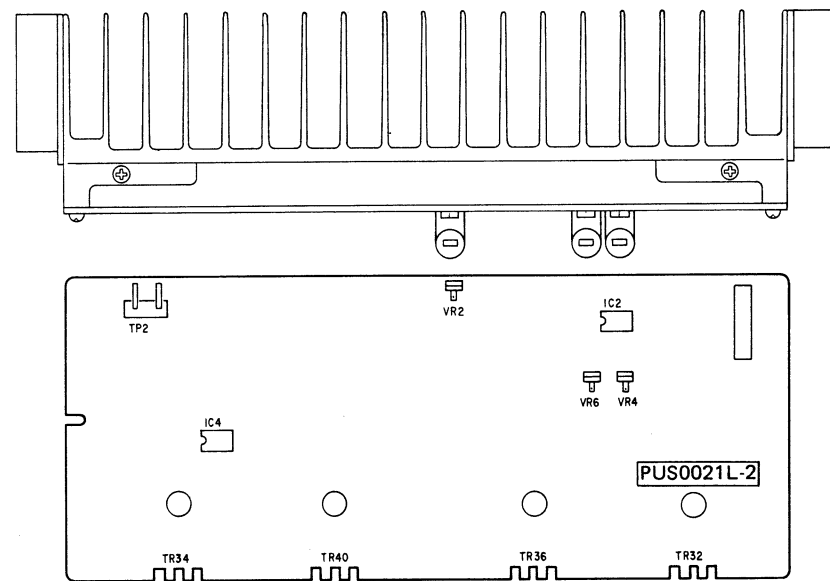

ETC0627D CONTROL UNIT

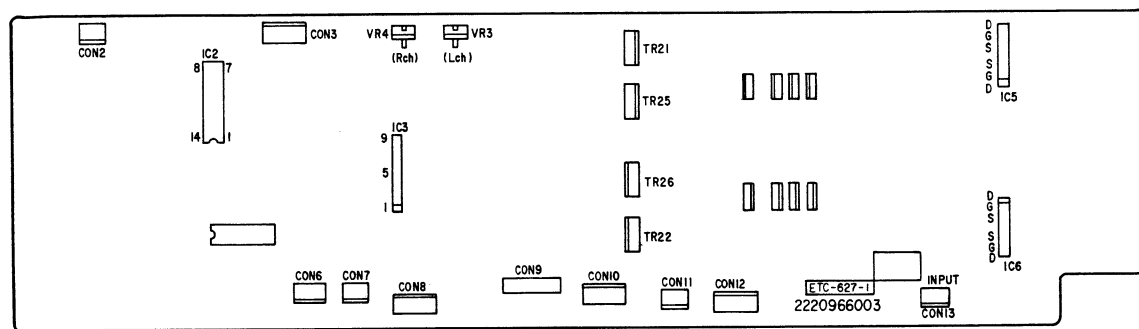

SEMICONDUCTORS

• IC

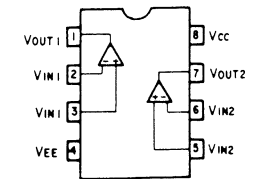
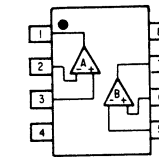
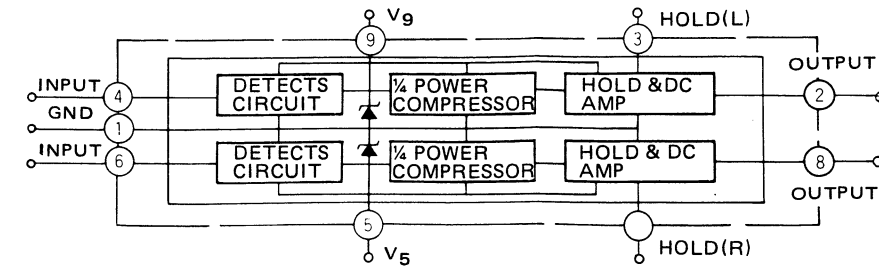
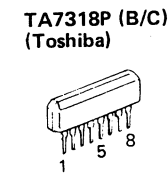
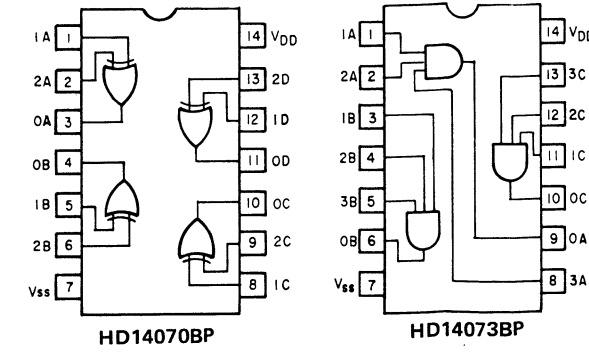
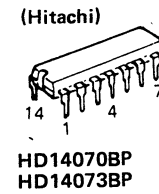

• TRANSISTORS (include FET)

2SC1815(BL)(Y)
2SC1841(F)/(E)
2SA1015(Y)



2SC2238(Y)
2SA968(Y)
2SC2238B(Y)



2SA1294LB(O)/(Y)
2SC3263LB(O)/(Y)



FET
2SK270A(BL)/(V)

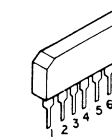

2SC1941(L)
2SA916(L)

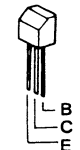

• DIODES (include LED, Thermistor)

HZ7B-3
HZ-15-2



MZ-303A
MZ-304B



1S2076(A)



KB-265



KB-462



ID2C-1



STV-1H

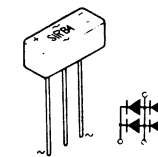

UB-152

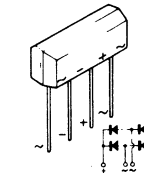

SLP271E(Green)
SLP471E(Yellow)

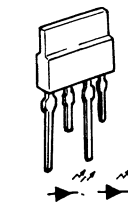

PRINTED WIRING BOARD PATTERNS AND PARTS LIST

ETC0627D CONTROL & P.S UNIT

NOTE: The pattern ETC-627-6 is for E3 model. E2 model is omitted resistors F2, F3, F6, F7 and jumpers F4, F5, and added fuses to F1 through F7 and label.

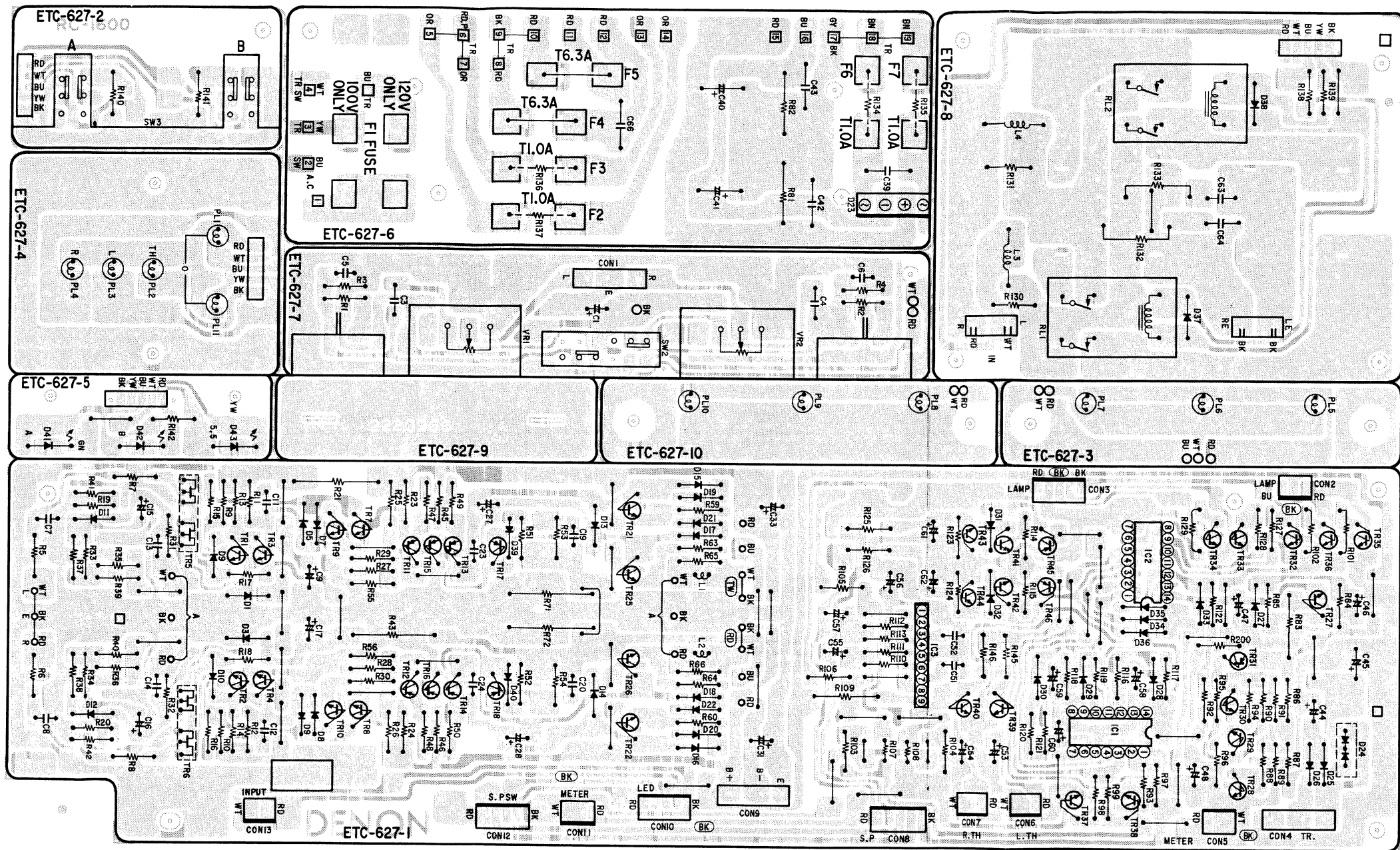

ETC0627B CONTROL & P.S UNIT (For E2)

Except those listed below all other parts are same as ETC0627D.

Ref. No.	Part No.	Parts Name & Descriptions	Remarks
RESISTORS			
R134 ~137	2440005029	1 ohm ±5% 1W Metal Oxide (NB)	Delete
CAPACITORS			
C063, 064	2554177005	0.022μF ±5% Plastic Film	Change
OTHER PARTS			
F002, 003, 006, 007	2090008120	0.6 Jumper Wire	Used 48
	2020022008	Fuse Holder	Used 14
	4150187002	Fuse Cover	
	2061015090	Fuse (5 A) (SEMCO)	
	2061015029	Fuse (1 AT)	Used 2

Ref. No.	Part No.	Part Name & Descriptions	Remarks
F004 ~005	2061036011	Fuse (6.3 A) Used 2	Add
	5130815018	Fuse Label	Add
	5130817003	Voltage Label	Add
	5130814006	Voltage Label	Add

ETC0627C CONTROL & P.S UNIT (For E1)

Except those listed below all other parts are same as ETC0627D.

Ref. No.	Part No.	Part Name Descriptions	Remarks
OTHER PARTS			
	2090003 120	0.6 Jumper Wire Used 48	Change

ETC0627D CONTROL & P.S UNIT PARTS LIST

Ref. No.	Part No.	Part Name & Descriptions
SEMICONDUCTORS		
IC001	2620461001	HD14070BP(HITACHI) IC
IC002	2620306001	HD14073BP(HITACHI) IC
IC003	2630071009	TA7318P(TOSHIBA) IC
TR001 ~004	2730198015	2SC1815(BL) TRANSISTOR
TR005	2750036034	2SK270A(GR/BL/V) FET
TR006	2750036034	2SK270A(GR/BL/V) FET
TR007 ~010	2730235020	2SC1841(E/F) TRANSISTOR
TR011 ~016	2710110000	2SA916(L) TRANSISTOR
TR017	2730205005	2SC1941(L) TRANSISTOR
TR018	2730205005	2SC1941(L) TRANSISTOR
TR021	2730259006	2SC2238B(Y) TRANSISTOR
TR022	2730259006	2SC2238B(Y) TRANSISTOR
TR025	2710151001	2SA968B(Y) TRANSISTOR
TR026	2710151001	2SA968B(Y) TRANSISTOR
TR027	2730198002	2SC1815(Y) TRANSISTOR
TR028	2730198015	2SC1815(BL) TRANSISTOR
~030		
TR031	2710102005	2SA1015(Y) TRANSISTOR
TR032 ~044	2730198015	2SC1815(BL) TRANSISTOR
TR045	2710102005	2SA1015(Y) TRANSISTOR
TR046	2710102005	2SA1015(Y) TRANSISTOR
D001	2760253001	HZ15-2 ZENER
D003	2760253001	HZ15-2 ZENER
D005	2760049008	1S2076 DIODE
~008		
D009	2760244007	MZ303A ZENER
D010	2760244007	MZ303A ZENER
D011	2760049008	1S2076 DIODE
D012	2760049008	1S2076 DIODE
D013	2760216019	KB-265 DIODE
D014	2760216019	KB-265 DIODE
D015	2760049008	1S2076 DIODE
~018		
D019	2760210015	MZ304B ZENER
~022		
D023	2760333002	UB-152 DIODE
D024	2760151006	1D2C-1 DIODE
D025	2760049011	1S2076A DIODE
D026	2760049011	1S2076A DIODE
D027	2760254000	HZ7B-3 ZENER
D028	2760049008	1S2076 DIODE
~040		
D041	3939155023	SLP-271E(GREEN) LED
D042	3939155023	SLP-271E(GREEN) LED
D043	3939155036	SLP-471E(YELLOW) LED
RESISTORS (not included Carbon Film ±5%, ¼W Type)		
VR001	2110228107	VARIABLE RESISTOR 100 kohm R LEVEL
VR002	2110228107	VARIABLE RESISTOR 100 kohm L LEVEL
VR003	2116014043	SEMI FIXED RESISTOR 500 ohm
VR004	2116014043	SEMI FIXED RESISTOR 500 ohm
R009 ~012	2412316092	3.3 kohm ±2% ¼W CARBON FILM (FR)
R021	2440105026	3.9 kohm ±5% 2W METAL OXIDE (NB)
R023 ~026	2412321003	1 kohm ±5% ¼W CARBON FILM (NB)
R043	2440105026	3.9 kohm ±5% 2W METAL OXIDE (NB)
R045	2412314023	470 ohm ±5% ¼W CARBON FILM (NB)

Ref. No.	Part No.	Part Name & Descriptions	
R046	2412314023	470 ohm	±5% ¼W CARBON FILM (NB)
R047 ~050	2412321016	22 ohm	±5% ¼W CARBON FILM (NB)
R051 ~054	2412321003	1 kohm	±5% ¼W CARBON FILM (NB)
R055	2412314036	750 ohm	±5% ¼W CARBON FILM (NB)
R056	2412314036	750 ohm	±5% ¼W CARBON FILM (NB)
R059	2412321016	22 ohm	±5% ¼W CARBON FILM (NB)
R060	2412321016	22 ohm	±5% ¼W CARBON FILM (NB)
R063	2412321016	22 ohm	±5% ¼W CARBON FILM (NB)
R064	2412321016	22 ohm	±5% ¼W CARBON FILM (NB)
R083	2440041025	1 kohm	±5% 1W METAL OXIDE (NB)
R109	2440039024	680 ohm	±5% 1W METAL OXIDE (NB)
R132	2440021029	22 ohm	±5% 1W METAL OXIDE (NB)
R133	2440021029	22 ohm	±5% 1W METAL OXIDE (NB)
R134 ~137	2440005029	1 ohm	±5% 1W METAL OXIDE (NB)
R140 ~142	2410187003	1.2 kohm	±5% ½W CARBON FILM

CAPACITORS (not included Ceramic ±5%, 50V Type)

C001	2544146004	1µF	50V ELECTROLYTIC
C003	2544145005	0.47µF	50V ELECTROLYTIC
C004	2544145005	0.47µF	50V ELECTROLYTIC
C005 ~008	2554131009	270pF	±5% 50V PLASTIC FILM
C009	2544138009	47µF	25V ELECTROLYTIC
C011	2554163006	0.0056µF	±5% 50V PLASTIC FILM
C012	2554163006	0.0056µF	±5% 50V PLASTIC FILM
C013	2521003005	3pF	±0.25pF 50V MICA
C014	2521003005	3pF	±0.25pF 50V MICA
C015	2543016083	22µF ±20%	50V ELECTROLYTIC (B.P)
C016	2543016083	22µF ±20%	50V ELECTROLYTIC (B.P)
C017	2544138009	47µF	25V ELECTROLYTIC
C019	2554145008	0.001µF	±5% 50V PLASTIC FILM
C020	2554145008	0.001µF	±5% 50V PLASTIC FILM
C023	2521081027	3pF	±0.5pF 500V MICA
C024	2521081027	3pF	±0.5pF 500V MICA
C027	2544181014	10µF	±20% 100V ELECTROLYTIC
C028	2544181014	10µF	±20% 100V ELECTROLYTIC
C031	2544181014	10µF	±20% 100V ELECTROLYTIC
C033	2544181014	10µF	±20% 100V ELECTROLYTIC
C039	2561017019	0.01µF	±10% 630V METALIZED
C040	2546070000	1000µF	±20% 80V ELECTROLYTIC
C041	2546070000	1000µF	±20% 80V ELECTROLYTIC
C042	2561016007	0.068µF	±10% 400V METALIZED
C043	2561016007	0.068µF	±10% 400V METALIZED
C044	2544060038	0.47µF	100V ELECTROLYTIC
C045	2544159017	1000µF	35V ELECTROLYTIC
C046	2544146004	1µF	50V ELECTROLYTIC
C047	2544146004	1µF	50V ELECTROLYTIC
C048	2544140000	4.7µF	35V ELECTROLYTIC
C051	2551212025	0.01µF	±5% 50V PLASTIC FILM
C052	2551212025	0.01µF	±5% 50V PLASTIC FILM
C053 ~055	2544146004	1µF	50V ELECTROLYTIC

Ref. No.	Part No.	Part Name & Descriptions	
C056	2544145005	0.47µF	50V ELECTROLYTIC
C057 ~060	2544146004	1µF	50V ELECTROLYTIC
C061	2544130007	100µF	10V ELECTROLYTIC
C062	2544130007	100µF	10V ELECTROLYTIC
C063	2561017035	0.022µF	±10% 630V METALIZED
C064	2561017035	0.022µF	±10% 630V METALIZED
C066	2561017019	0.01µF	±10% 630V METALIZED

COILS

L001	2350008006	INDUCTOR 22µH
L002	2350008006	INDUCTOR 22µH
L003	2350007007	INDUCTOR 1µH
L004	2350007007	INDUCTOR 1µH

SWITCHES

SW002	2124311107	SLIDE SWITCH
SW003	2124449008	2P PUSH SWITCH

PILOT LAMPS

PL001 ~010	3930083013	PILOT LAMP 28V 0.04A USED 10
---------------	------------	------------------------------

OTHER PARTS

F001	2220966100	P.W. BOARD
	2090008120	0.6 JUMPER WIRE USED 50
	2050134908	TERMINAL PIN USED 25
	2090008146	JUMPER P=5mm USED 4
	2090008104	JUMPER P=15mm USED 2
	2020022008	FUSE HOLDER USED 2
	4150187002	FUSE COVER USED 2
	2061035096	FUSE 10.0A
	2061044003	FUSE 15A (LEAD IN)
	2050184000	2P CONNECTOR BASE USED 2
	2050173008	8P TERMINAL
	2050075025	2P TERMINAL USED 2
	2050185054	5P WIRE HOLDER USED 4
	2140041008	RELAY USED 2
RL001 ~002	2050122033	3P CONNECTOR PIN ASS'Y USED 3
	2050133051	5P NH CONNECTOR BASE USED 4
	2050133035	3P NH CONNECTOR BASE USED 6
	2030226027	1P CONTACT ASS'Y
	2034197039	3P CONNECTOR CORD USED 2
	2034189034	3P CONNECTOR CORD USED 2
	2034179015	3P CONNECTOR CORD USED 2
	2036110001	4P CONNECTOR CORD USED 2
	2036110014	4P CONNECTOR CORD USED 2
	2038109036	5P CONNECTOR CORD USED 2
	2038117057	5P CONNECTOR CORD USED 2
	2038117060	5P CONNECTOR USED 2
	2034185012	3P CONNECTOR CORD USED 2

PUS0021J POWER AMP & POWER SOURCE UNIT

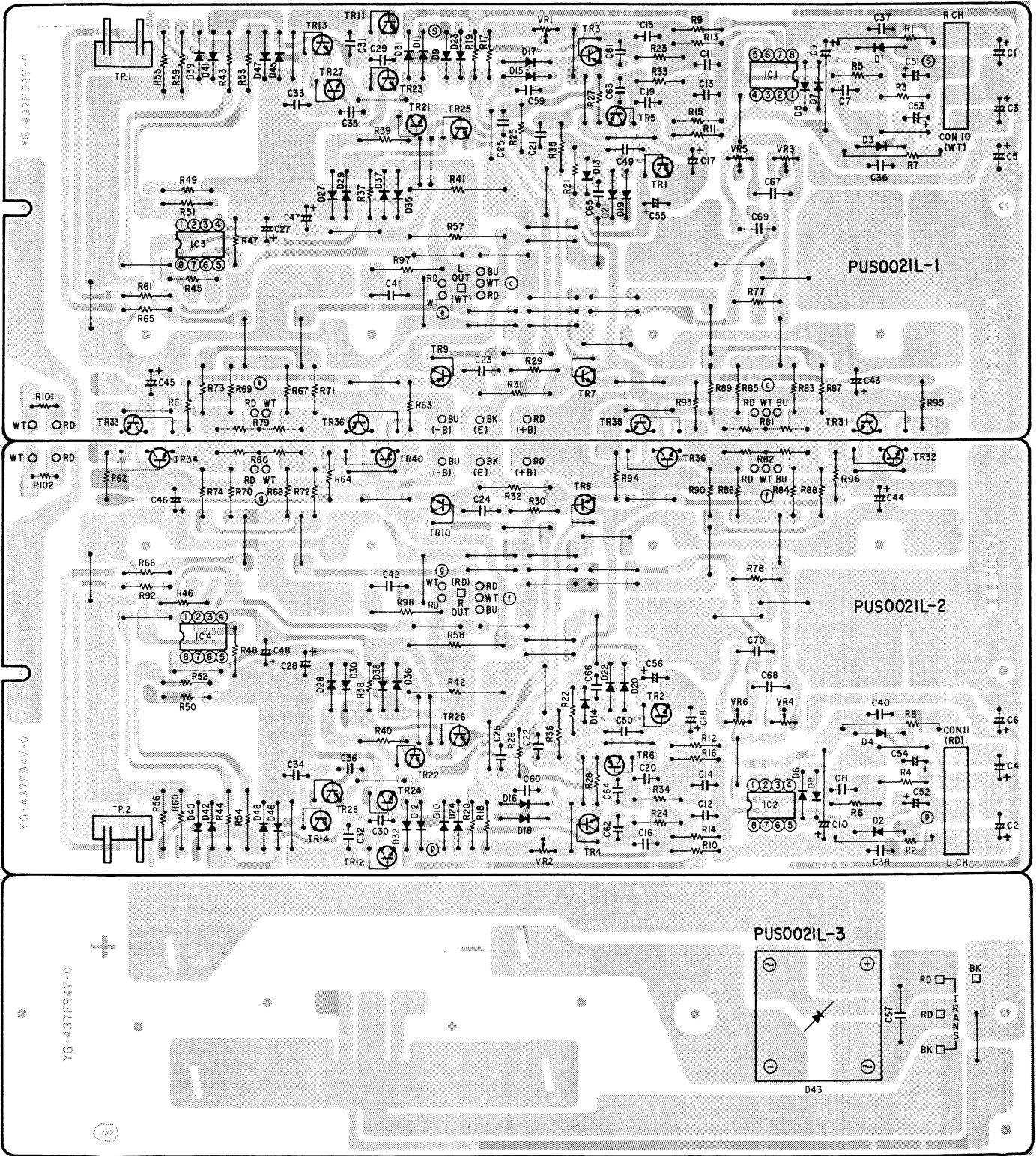

PUS0021J P.A & P.S. UNIT PARTS LIST

Ref. No.	Part No.	Part Name & Descriptions	
SEMICONDUCTORS			
IC001	2630244001	NJM082D(JRC)	IC
IC002	2630244001	NJM082D(JRC)	IC
IC003	2630229000	LA6458DS(SANYO)	IC
IC004	2630229000	LA6458DS(SANYO)	IC
TR001	2730198015	2SC1815(BL)	TRANSISTOR
TR002	2730198015	2SC1815(BL)	TRANSISTOR
TR003	2730205005	2SC1941(L)	TRANSISTOR
TR004	2730205005	2SC1941(L)	TRANSISTOR
TR005	2710110000	2SA916(L)	TRANSISTOR
TR006	2710110000	2SA916(L)	TRANSISTOR
TR007	2730199001	2SC2238(Y)	TRANSISTOR
TR008	2730199001	2SC2238(Y)	TRANSISTOR
TR009	2710104003	2SA968(Y)	TRANSISTOR
TR010	2710104003	2SA968(Y)	TRANSISTOR
TR011	2730198002	2SC1815(Y)	TRANSISTOR
TR012	2730198002	2SC1815(Y)	TRANSISTOR
TR013	2710102005	2SC1015(Y)	TRANSISTOR
TR014	2710102005	2SA1015(Y)	TRANSISTOR
TR021	2730198002	2SC1815(Y)	TRANSISTOR
TR022	2730198002	2SC1815(Y)	TRANSISTOR
TR023	2710102005	2SA1015(Y)	TRANSISTOR
TR024	2710102005	2SA1015(Y)	TRANSISTOR
TR025	2710102005	2SA1015(Y)	TRANSISTOR
TR026	2710102005	2SA1015(Y)	TRANSISTOR
TR027	2730198002	2SC1815(Y)	TRANSISTOR
TR028	2730198002	2SC1815(Y)	TRANSISTOR
D001	2760254000	HZ7B-3	ZENER
D002	2760254000	HZ7B-3	ZENER
D003	2760254000	HZ7B-3	ZENER
D004	2760254000	HZ7B-3	ZENER
D005	2760049008	1S2076	DIODE
D006	2760049008	1S2076	DIODE
D007	2760049008	1S2076	DIODE
D008	2760049008	1S2076	DIODE
D013	2760334001	STV-1H	DIODE
D014	2760334001	STV-1H	DIODE
D015	2760049008	1S2076	DIODE
~022			
D023	2760350001	S1R20F	DIODE
D024	2760350001	S1R20F	DIODE
D027	2760216019	KB-265	DIODE
030			
D031	2760350001	S1R20F	DIODE
D032	2760350001	S1R20F	DIODE
D035	2760254000	HZ7B-3	ZENER
~038			
D069	2760049011	1S2076A	DIODE
~0			
D045	2760337008	KB-462	DIODE
~048			
RESISTORS (not included Carbon Film ±5%, ¼W Type)			
VR001	2116014072	SEMI FIXED RESISTOR 10 kohm	
VR002	2116014072	SEMI FIXED RESISTOR 10 kohm	
VR003	2116014001	SEMI FIXED RESISTOR 100 ohm	
VR004	2116014001	SEMI FIXED RESISTOR 100 ohm	
VR005	2116014069	SEMI FIXED RESISTOR 200 ohm	
VR006	2116014069	SEMI FIXED RESISTOR 200 ohm	
R001	2440106025	4.7 kohm ±5% 2W	METAL OXIDE (NB)
R002	2440106025	4.7 kohm ±5% 2W	METAL OXIDE (NB)
R003	2412369007	820 ohm ±5% ¼W	CARBON FILM (NB)
R004	2412369007	820 ohm ±5% ¼W	CARBON FILM (NB)

Ref. No.	Part No.	Part Name & Descriptions	
R007	2440106025	4.7 kohm ±5% 2W	METAL OXIDE (NB)
R008	2440106025	4.7 kohm ±5% 2W	METAL OXIDE (NB)
R009	2412369052	2.2 kohm ±5% ¼W	CARBON FILM (NB)
~016			
R023	2412321003	1 kohm ±5% ¼W	CARBON FILM (NB)
R024	2412321003	1 kohm ±5% ¼W	CARBON FILM (NB)
R025	2412314007	100 ohm ±5% ¼W	CARBON FILM (NB)
R026	2412314007	100 ohm ±5% ¼W	CARBON FILM (NB)
R027	2412321003	1 kohm ±5% ¼W	CARBON FILM (NB)
R028	2412321003	1 kohm ±5% ¼W	CARBON FILM (NB)
R031	2440029021	100 ohm ±5% 1W	METAL OXIDE (NB)
R032	2440029021	100 ohm ±5% 1W	METAL OXIDE (NB)
R033	2412321003	1 kohm ±5% ¼W	CARBON FILM (NB)
R034	2412321003	1 kohm ±5% ¼W	CARBON FILM (NB)
R035	2412314007	100 ohm ±5% ¼W	CARBON FILM (NB)
R036	2412314007	100 ohm ±5% ¼W	CARBON FILM (NB)
R041	2440103028	2.7 kohm ±5% 2W	METAL OXIDE (NB)
R042	2440103028	2.7 kohm ±5% 2W	METAL OXIDE (NB)
R043	2412369078	4.7 kohm ±5% ¼W	CARBON FILM (NB)
R044	2412369078	4.7 kohm ±5% ¼W	CARBON FILM (NB)
R045	2412369052	2.2 kohm ±5% ¼W	CARBON FILM (NB)
R046	2412369052	2.2 kohm ±5% ¼W	CARBON FILM (NB)
R047	2412321003	1 kohm ±5% ¼W	CARBON FILM (NB)
~050			
R051	2412369052	2.2 kohm ±5% ¼W	CARBON FILM (NB)
R052	2412369052	2.2 kohm ±5% ¼W	CARBON FILM (NB)
R053	2412369078	4.7 kohm ±5% ¼W	CARBON FILM (NB)
R054	2412369078	4.7 kohm ±5% ¼W	CARBON FILM (NB)
R055	2410212004	13 kohm ±5% ½W	CARBON FILM
R056	2410212004	13 kohm ±5% ½W	CARBON FILM
R057	2440103028	2.7 kohm ±5% 2W	METAL OXIDE (NB)
R058	2440103028	2.7 kohm ±5% 2W	METAL OXIDE (NB)
R059	2410212004	13 kohm ±5% ½W	CARBON FILM
R060	2410212004	13 kohm ±5% ½W	CARBON FILM
R061	2412321032	4.7 ohm ±5% ¼W	CARBON FILM (NB)
~064			
R067	2412321016	22 ohm ±5% ¼W	CARBON FILM (NB)
~074			
R079	2432033038	0.18/0.18 ohm 2W	WIRE WOUND
~082			
R038	2412321016	22 ohm ±5% ¼W	CARBON FILM (NB)
~090			

Ref. No.	Part No.	Part Name & Descriptions	
R093	2412321032	4.7 ohm ±5% ¼W	CARBON FILM (NB)
~096			
R097	2440021029	22 ohm ±5% 1W	METAL OXIDE (NB)
R098	2440021029	22 ohm ±5% 1W	METAL OXIDE (NB)
R101	2760289004	PTH487A01BD222TS	POSISTOR
R102	2760289004	PTH487A01BD222TS	POSISTOR
R111	2412369007	820 ohm ±5% ¼W	CARBON FILM (NB)
R112	2412369007	820 ohm ±5% ¼W	CARBON FILM (NB)
CAPACITORS (not included Ceramic ±5%, 50V Type)			
C001	2544181014	10µF ±20%	100V ELECTROLYTIC
~004			
C007	2521022002	33pF ±5%	50V MICA
C008	2521022002	33pF ±5%	50V MICA
C009	2544180002	47µF ±20%	63V ELECTROLYTIC
C010	2544180002	47µF ±20%	63V ELECTROLYTIC
C011	2554137003	470pF ±5%	50V PLASTIC FILM
~016			
C017	2544181001	1µF ±20%	100V ELECTROLYTIC
C018	2544181001	1µF ±20%	100V ELECTROLYTIC
C019	2554137003	470pF ±5%	50V PLASTIC FILM
C020	2554137003	470pF ±5%	50V PLASTIC FILM
C021	2554149004	0.0015µF ±5%	50V PLASTIC FILM
C022	2554149004	0.0015µF ±5%	50V PLASTIC FILM
C023	2554084017	0.01µF ±5%	100V PLASTIC FILM
C024	2554084017	0.01µF ±5%	100V PLASTIC FILM
C025	2554149004	0.0015µF ±5%	50V PLASTIC FILM
C026	2554149004	0.0015µF ±5%	50V PLASTIC FILM
C027	2544181014	10µF ±20%	100V ELECTROLYTIC
C028	2544181014	10µF ±20%	100V ELECTROLYTIC
C029	2556115007	0.0047µF ±5%	50V PLASTIC FILM
C030	2556115007	0.0047µF ±5%	50V PLASTIC FILM
C035	2556115007	0.0047µF ±5%	50V PLASTIC FILM
C036	2556115007	0.0047µF ±5%	50V PLASTIC FILM
C037	2521079039	47pF ±10%	500V MICA
~040			
C041	2561017019	0.01µF ±10%	630V METALIZED
C042	2561017019	0.01µF ±10%	630V METALIZED
C043	2544181001	1µF ±20%	100V ELECTROLYTIC
~046			
C047	2544181014	10µF ±20%	100V ELECTROLYTIC
C048	2544181014	10µF ±20%	100V ELECTROLYTIC
C049	2561017019	0.01µF ±10%	630V METALIZED
C050	2561017019	0.01µF ±10%	630V METALIZED
C051	2544181001	1µF ±20%	100V ELECTROLYTIC
~056			
C059	2554137003	470pF ±5%	50V PLASTIC FILM
C060	2554137003	470pF ±5%	50V PLASTIC FILM
C061	2521079071	22pF ±10%	500V MICA
~064			
C065	2554137003	470pF ±5%	50V PLASTIC FILM
C066	2554137003	470pF ±5%	50V PLASTIC FILM
C067	2554177005	0.022µF ±5%	50V PLASTIC FILM
~070			

Ref. No.	Part No.	Part Name & Descriptions	
OTHER PARTS			
	2220874111	P.W. BOARD	
	2090008120	0.6 JUMPER WIRE USED 78	
	2050134908	TERMINAL PIN USED 6	
	2050075025	2P TERMINAL USED 2	
	2050122046	4P CONNECTOR PIN ASS'Y USED 2	
	EP-6071	BASE PIN USED 6	
	2034185025	3P CONNECTOR CORD	
	2034185038	3P CONNECTOR CORD	
	4410326008	HOLDER (RH-14) USED 4	
	4711304017	PAN SCREW 3x8 USED 4	
	4756006008	NUT M3 USED 4	

CONNECTION DIAGRAM (For E3 Model)

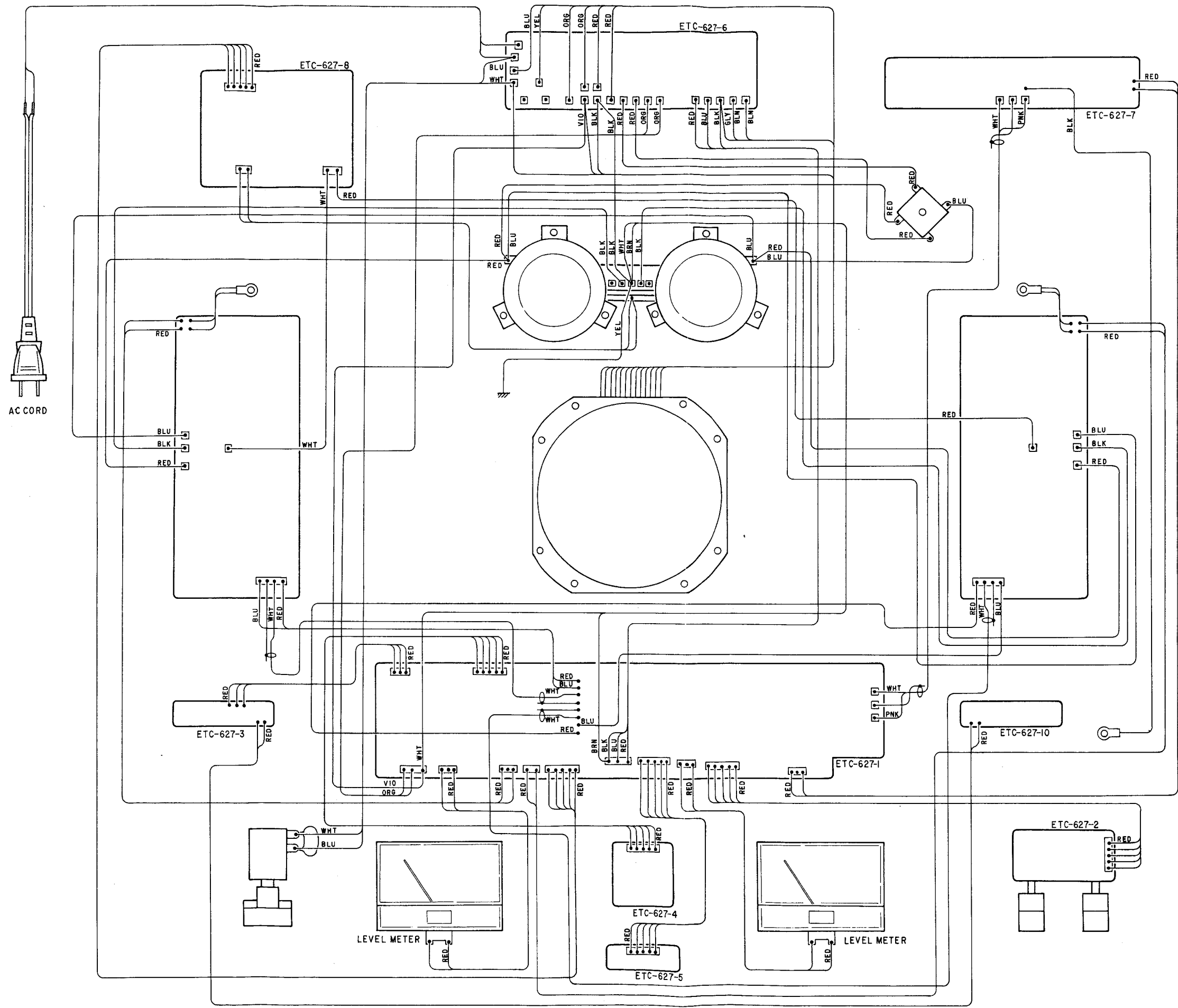

WIRING DIAGRAM

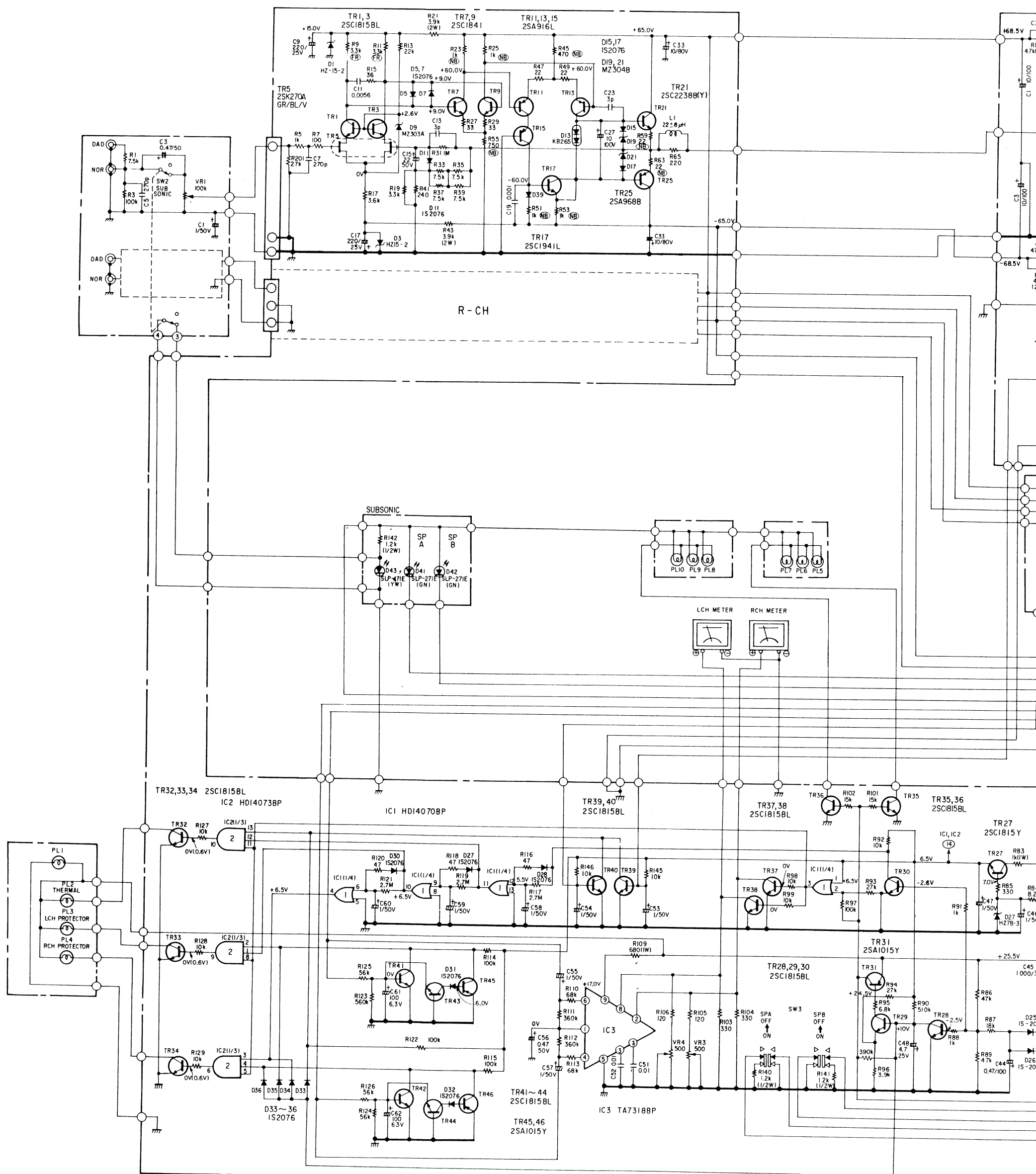

⚠ Means important safety item, which must be replaced, when necessary, by a part specified or meeting the specification by the manufacturer.

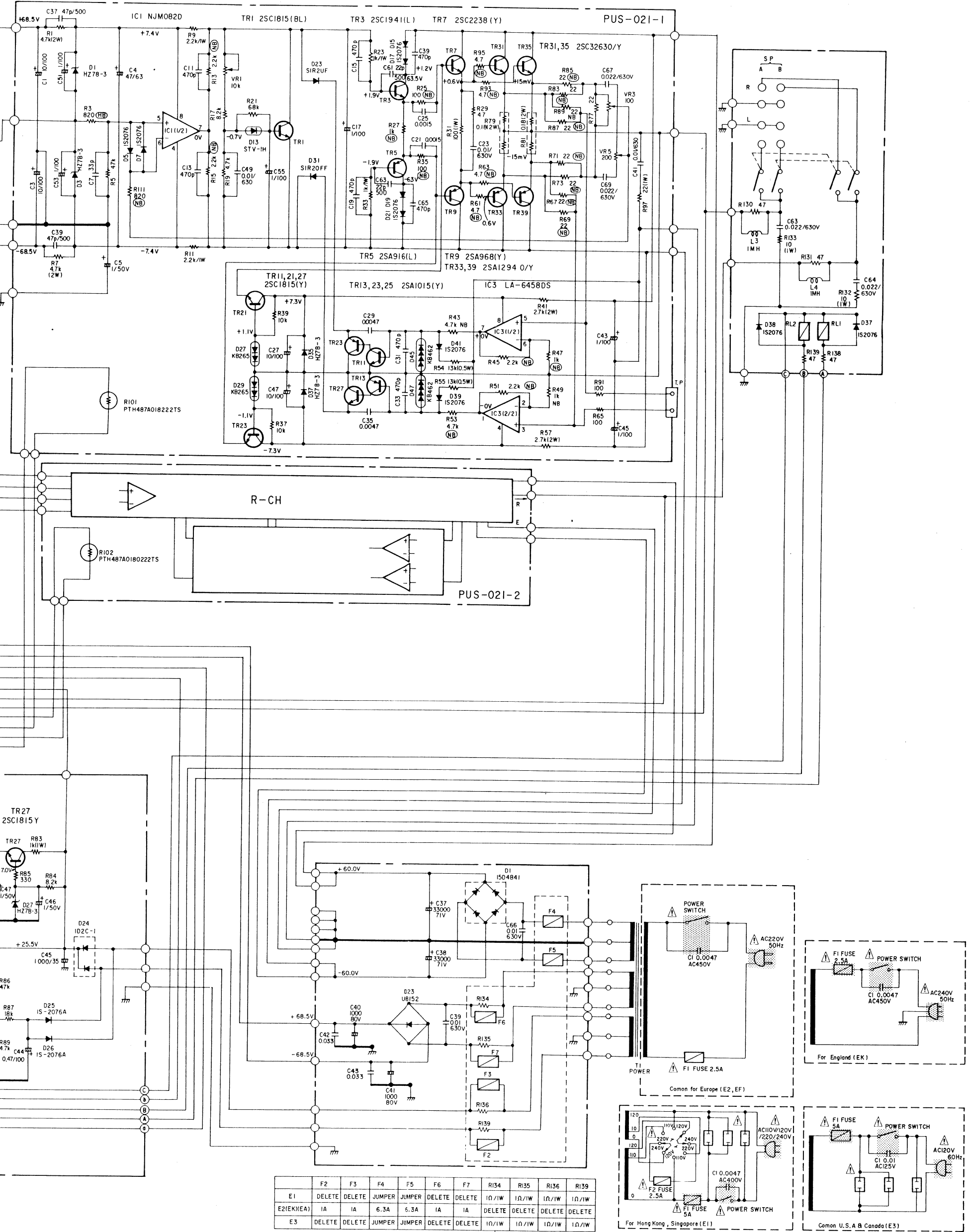

NOTES:
 ALL RESISTANCE VALUES IN OHM, K = 1,000 OHM,
 M = 1,000,000 OHM.
 ALL CAPACITANCE VALUES IN MICROFARAD, P = MICRO-MICRO FARAD.
 EVERY VOLTAGES AND CURRENTS IS MEASURED AT NO SIGNAL INPUT CONDITION.
 CIRCUIT AND PARTS ARE SUBJECT TO CHANGE WITHOUT PRIOR NOTICE.

EXPLODED VIEW OF CHASSIS AND CABINET (For E3 Model)

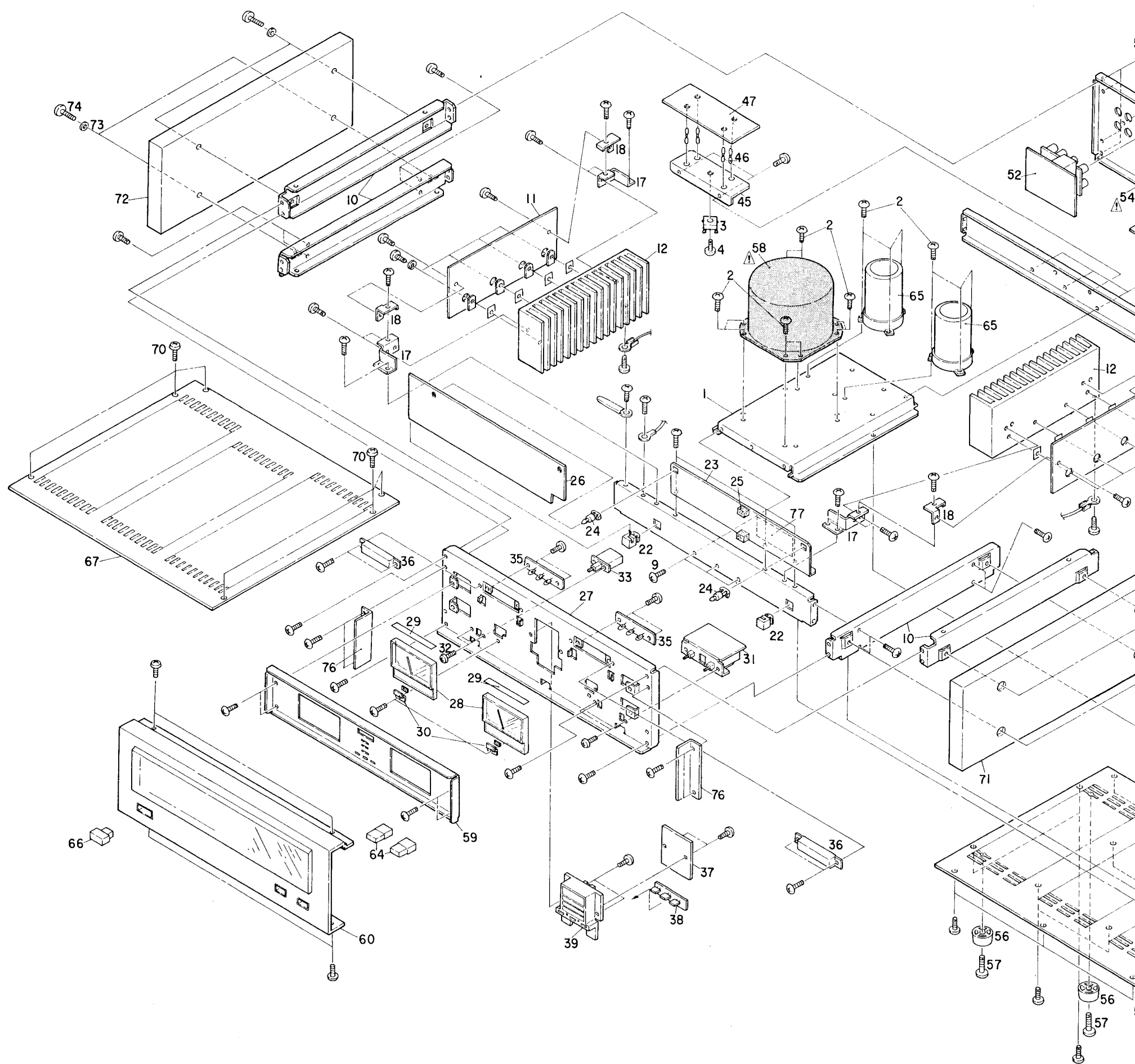

NOTE: 1. See addendum list below for the parts with asterisk (*) on the Ref No. and the other parts not included in the list.
 2. * Marked not included EXPLODED VIEW.
 3. This list is prepared base on E3.

EXPLODED VIEW PARTS LIST

Ref. No.	Part No.	Part Name & Descriptions
1	4110391207	TRANS CHASSIS
2	4730454032	TAPPING SCREW (2) 4x8 (BLACK)
3	2760257007	DIODE 15D4B41
4	4730360016	TAPPING SCREW (2) 3x20
5	-	-
*6	ETC0627D-9	BASE UNIT
7	4140314005	EARTH PLATE
8	4110392109	CHASSIS FRAME
9	4730354019	TAPPING SCREW (2) 3x8
10	4110393001	SIDE CHASSIS
*11	PUS0021L-1	POWER (L) UNIT
12	4170185000	POWER RADIATOR
13	2710164108	TRANSISTOR 2SA1294LB(O)/(Y)
14	2730278100	TRANSISTOR 2SC3263LB(O)/(Y)
15	4150234007	INSULATING SHEET
16	4700012022	PAN SCREW WITH S.W 3x12
17	4120871005	RADIATOR BRACKET (A)
18	4120872004	RADIATOR BRACKET (B)
19	4120873003	BRACKET (A)
20	4120874002	BRACKET (B)
*21	PUS0021L-2	POWER (R) UNIT
22	4150103002	P.C.B. HOLDER
23	4140315004	SHIELD PLATE
24	MD-5271	P.C.B. SUPPORT
25	4610121029	CUSHION
*26	ETC0627D-1	CONTROL UNIT
27	4110394000	FRONT CHASSIS

Ref. No.	Part No.	Part Name & Descriptions
28	2150058007	METER ASS'Y
29	1430245188	FILTER
30	4121415004	BRACKET
*31	ETC0627D-2	SP SW UNIT
32	4711303018	PAN SCREW 3x6
*33	2124405000	POWER SWITCH
*34	2558000042	PLASTIC FILM CAP. 0.01μF/160V
*35	ETC0627D-3	LAMP (3) UNIT
36	4140316003	REFLECTOR
*37	ETC0627D-4	LAMP (4) UNIT
*38	ETC0627D-5	LED UNIT
39	4410399006	LED HOLDER
40	1430321002	FILTER (DENON)
41	1430322001	FILTER (YELLOW)
42	1430322014	FILTER (ORANGE)
43	1430322027	FILTER (GREEN)
44	4770115001	PUSH RIVET
45	4121416100	BRACKET
46	4150228000	P.C.B. HOLDER
47	ETC0627D-6	P.S UNIT
*48	1050558103	BACK PANEL
*49	ETC0627D-7	INPUT UNIT
50	-	NUT M7
51	4730354035	TAPPING SCREW (2) 3x8 (BLACK)
*52	ETC0627D-8	SP UNIT
*53	2006029009	AC CORD
*54	4450020005	CORD BUSH

Ref. No.	Part No.	Part Name & Descriptions
55	1050559209	BUTTON COVER
56	1040027107	FOOT
57	4730460013	TAPPING SCREW (2) 4x20
*58	2330230001	POWER TRANS
59	1441136202	INSIDE PANEL
60	1441135106	FRONT PANEL
61	1430323000	WINDOW GLASS
62	1140073006	KNOB GUIDE (POWER)
63	1140074102	KNOB GUIDE (SP)
64	1130477104	PUSH KNOB ASS'Y (SP)
65	2546077003	CHEMICON 33000μF
66	1130476105	PUSH KNOB ASS'Y (POWER)
67	1020169205	TOP COVER
68	1220094044	SPACER (340x16)
69	1220094057	SPACER (240x16)
70	4770064107	FIXING SCREW
71	1011503003	WOOD BOARD (R)
72	1011504002	WOOD BOARD (L)
73	4751006016	WASHER φ5 (BLACK)
74	4734460035	TAPPING SCREW (TRANS) 4x20 (BLACK)
75	1120430106	KNOB ASS'Y (INPUT LEVEL)
76	4121477000	BRACKET
77	4610178098	RUBBER SHEET
78	2050141001	COMMON PLATE
79	4610157077	CUSHION

Ref. No.	Part No.	Part Name & Descriptions
80	4730460013	TAPPING SCREW (2) 4x20
81	1040027107	FOOT
82	EP-4	EP-4
83	4751006016	WASHER φ5 (BLACK)
84	4751006016	WASHER φ5 (BLACK)
85	4730460013	TAPPING SCREW (2) 4x20
*86	4450020005	CORD BUSH
*87	2034	2034
*88	2034	2034
89	4770	4770
90	4610	4610
91	4150	4150
92	1220	1220
100	5130	5130
101	5130	5130
102	4770	4770
PACKING		
a.	5040	5040
b.	5040	5040
c.	5030	5030
d.	5010	5010
e.	5050	5050
f.	5110	5110
g.	5150	5150
h.	5130	5130

means important safety item, which must be replaced, necessary, by a part specified or meeting the specification manufacturer.

DENON

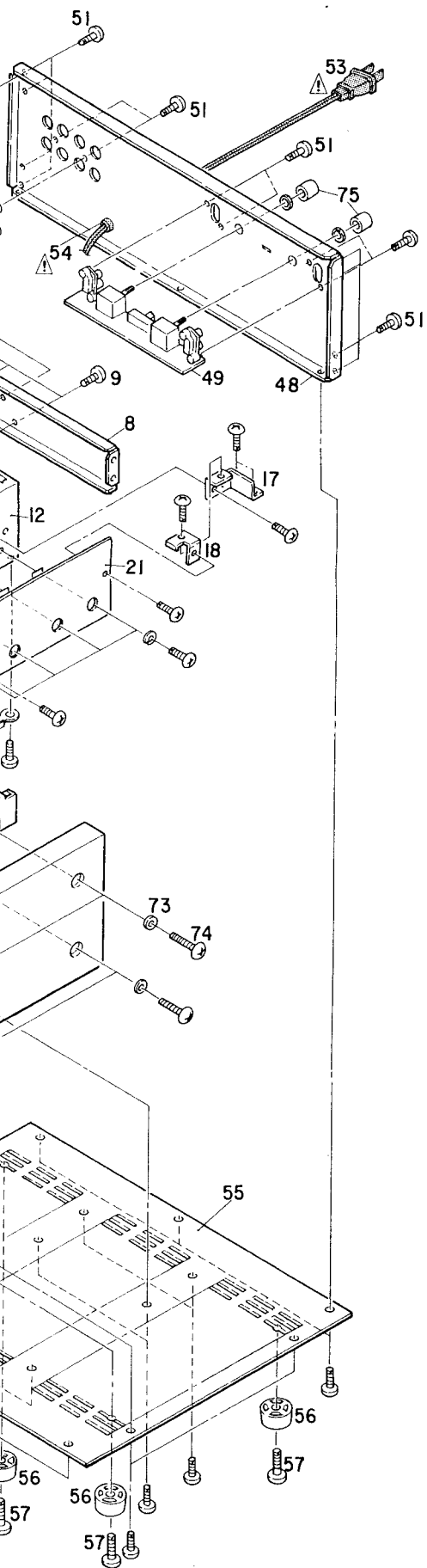

WARNING

1. Component parts

Parts marked with Δ and/or shading in this service manual have special characteristics important to safety. Be sure to use the specified parts for replacement.

2. Leakage current

Before returning the appliance to customer, test the leakage current when the power plug is connected. Use a calibrated (with an error of not more than 5%) leakage current tester and measure the leakage current from any exposed metal to the earth ground. Reverse the power plug polarity and test the above again.

Any current measured MUST NOT EXCEED 0.5 milliamps. Corrective measure must be taken if it exceeds the limit.

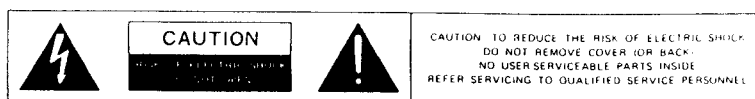

The lightning flash with arrowhead symbol within an equilateral triangle is intended to alert the user of the presence of uninsulated "dangerous voltage" within the product's enclosure that may be of sufficient magnitude to constitute a risk of electric shock to persons.



The exclamation point within an equilateral triangle is intended to alert the user of the presence of important operating and maintenance (servicing) instructions in the literature accompanying the appliance.

WARNING: TO PREVENT FIRE OR SHOCK HAZARD, DO NOT EXPOSE THIS APPLIANCE TO RAIN OR MOISTURE.

CAUTION: SAVE THIS BOX AND PACKING MATERIALS FOR RESHIPMENT IF NECESSARY, WHEN RETURNING THE UNIT, PLEASE PACK UNIT AS PACKING INSTRUCTIONS TO AVOID COSTLY SHIPPING DAMAGE. FOR YOUR OWN PROTECTION PLEASE PACK CAREFULLY AS SHIPPING DAMAGES ARE NOT COVERED BY WARRANTY.

NIPPON COLUMBIA CO., LTD.

No. 14-14, 4-CHOME AKASAKA,
MINATO-KU, TOKYO 107 JAPAN
TEL: 03-584-8111
TLX: JAPANOLA J22591
CABLE: NIPPONCOLUMBIA TOKYO

Printed in Japan

Part No.	Part Name & Descriptions
4730353010	TAPPING SCREW (2) 3x6
1430245191	FILTER (47x18)
EP-4772	CORD HOLDER (USED 3)
4752003005	SPRING WASHER ϕ 3
4751003005	WASHER ϕ 3
4734454038	TAPPING SCREW (TRANS) 4x8
4450033005	WIRE CLAMP BAND (USED 15)
2034193020	3P CONNECTOR CORD
2034193003	3P CONNECTOR CORD
4770224002	SP WASHER
4610178072	RUBBER SHEET
4150164041	SPACER (12x12)
1220007073	SPACER (420x16)
5130807000	RATING SHEET (PRA)
5130675054	SERIAL NO. PLATE
4770126016	RIVET
PACKING & ACCESSORIES (not included EXPLODED VIEW)	
5040055007	CABINET SHEET
5040077014	PROTECTOR SHEET
5030404008	CUSHION
5010924003	CARTON CASE
5050061007	ENVELOPE
5111145105	INST. MANUAL
5158053108	WARRANTY IN ENVELOPE
5130784000	INDICATION SHEET

ADDENDUM LIST

Ref. No.	Part Name & Descriptions	Part No.	
		E2 for Europe	E1 for Hong Kong
6	BASE UNIT	ETC0627B-9	ETC0627C-9
11	POWER (L) UNIT	PUS0021L-1	PUS0021L-1
21	POWER (R) UNIT	PUS0021L-2	PUS0021L-2
26	CONTROL UNIT	ETC0627B-1	ETC0627C-1
31	SP SW UNIT	ETC0627B-2	ETC0627C-2
Δ 33	POWER SWITCH	2124405013	2124405013
Δ 34	CAPACITOR (SPARK KILLER)	2568023006 (0.01 μ F/250V)	2568023006 (0.01 μ F/160V)
35	LAMP (3) UNIT	ETC0627B-3	ETC0627C-3
37	LAMP (4) UNIT	ETC0627B-4	ETC0627C-4
38	LED UNIT	ETC0627B-5	ETC0627C-5
48	BACK PANEL	1050567000	1050570000
49	INPUT UNIT	ETC0627B-7	ETC0627C-7
52	SP UNIT	ETC0627B-8	ETC0627C-8
Δ 53	AC CORD	2062016001	2006031026
Δ 54	CORD BUSH	4450020005	4450020005
Δ 58	POWER TRANS.	2335435005	2335440003
Δ 103	VOLTAGE SEL SW	—	2120186006
104	PAN SCREW 3x6 (BLACK)	—	4711303034
105	FUSE HOLDER	—	2020013101
106	PAN SCREW 3x8 (BLACK)	—	4711304033
107	NUT M3	—	4756006008
108	FUSE (6.3A)	—	2061036011
109	FUSE LABEL (T6.3A)	—	5130654091
110	PRESET LABEL	—	5150290008