

DENON

Stereo Power Amplifier

SERVICE MANUAL MODEL POA-3000RG

STEREO POWER AMPLIFIER

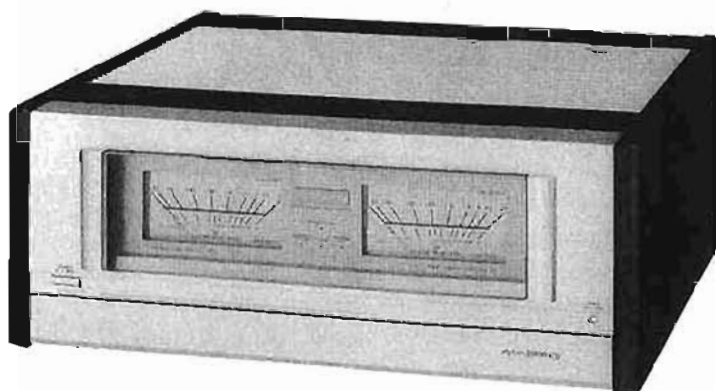

NOTE: This Service Manual is prepared based on Asla Version.

CONTENTS

OPERATING INSTRUCTIONS	2 - 10
REMOVAL OF EACH SECTION	11
METHOD OF ADJUSTMENTS	12
SEMICONDUCTORS	13
NOTE FOR PARTS LIST	14
PRINTED WIRING BOARD PARTS LIST	14 - 16
PRINTED WIRING BOARD PATTERNS	
KU-9191 POWER AMP UNIT	17
KU-9192 INPUT UNIT	18
KU-9193 CONTROL UNIT	19
PARTS LIST OF EXPLODED VIEW	20
EXPLODED VIEW OF CHASSIS AND CABINET	21
WIRING DIAGRAM	22
SCHEMATIC DIAGRAM	23, 24

NIPPON COLUMBIA CO., LTD.

NOTE ON USE

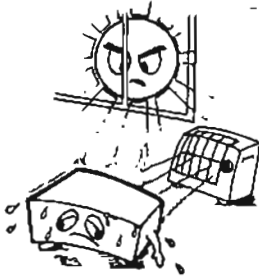

Be careful of high temperatures

- Do not place the set in a location where it will be exposed to direct sunlight or near a heating appliance.

Caution on rack/cabinet installation

- Avoid installing the set in a closed-type rack.
- When installing in a rack or cabinet, provide a sufficiently large ventilation opening to promote heat radiation.

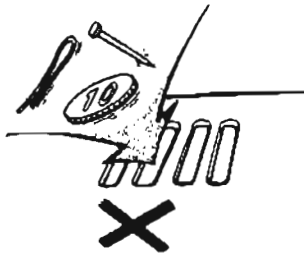

Do not allow foreign matter into the equipment

- Be especially careful of needles, hair pins, and coins getting into the set.



Caution on humidity, water, and dust

- Do not place the set in a location where there is high humidity or a lot of dust.
- Flower vases or other items containing water should not be placed on top of the set.



Care of the case

- Avoid the use of pesticides near the set as well as wiping the case with benzine, thinner or other solvents since they may cause a change in quality or color. Use a soft cloth when wiping away dirt and follow the instructions carefully when using chemically treated cloths.



Care with the power cord

- When removing the plug from the receptacle, do not pull the power cord; be sure to hold the plug when removing it.

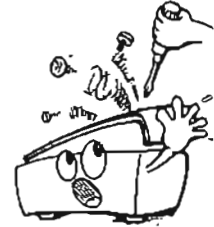

Do not open the case

- Opening the top cover or the bottom plate of the case and inserting your hand is dangerous. Do not open the case.

If some trouble arises with the performance of the set, remove the power plug soon and contact the store where the set was purchased or a nearby dealer.



During your absence

- When not using the set for an extended period such as when taking a trip, be sure to disconnect the plug from the receptacle.

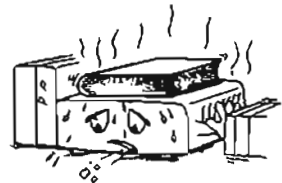

For sets with ventilation holes

Do not block the ventilation holes of the set





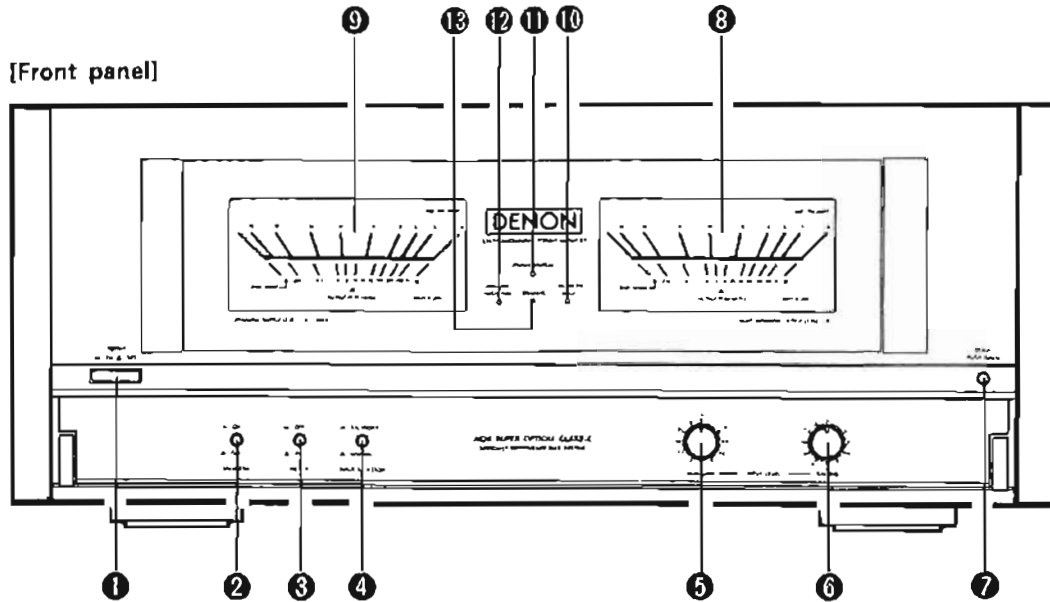

- Blocking of the ventilation holes will lead to damage of the set.
- The ventilation holes are very important for heat radiation from within the set. Care must be taken since placing an object against the holes will result in an extreme rise of temperature within the set.

Please check to make sure the following items are included with the main unit in the carton:

- ① Operating Instructions 1

NAMES AND FUNCTIONS OF THE PARTS



- 1 POWER (Power Switch)**
Press this switch to the ON () position to supply the power. The PROTECTOR/PEAK indicator **11** will flash for several seconds, then each of the indicators will light up and the amplifier will be in the operating condition. Pressing the POWER switch again will switch OFF () the power.
- 2 SPEAKERS (Speakers Switch)**
Setting this switch ON () will provide output to both A and B speaker terminals. Setting the switch to OFF () will switch off the A and B speaker terminals.
- 3 METER (Meter Switch)**
Setting this switch to ON () activates the output peak level meters **8** and **9**. Setting the switch to OFF () switches off the meter illumination and the meters are inoperative.
- 4 INPUT SELECTOR (Input Selection Switch)**
This switch selects either a balanced input (CANNON connectors) or a normal input (pin jacks).
- 5 MONAURAL INPUT LEVEL (Monaural Input Level Control)**
This control is used for adjusting the monaural input level at the time of monaural operation.
- 6 STEREO INPUT LEVEL (Stereo Input Level Control)**
This control is used for adjusting the stereo input level at the time of stereo operation.
- 7 DOOR (Door Open Button)**
Press this button to open the door. Be sure to use this button to open the door. To close the door, raise the right edge of the door until it locks. Functions **2** through **6** are provided inside the door.

- 8 and 9 OUTPUT PEAK LEVEL (Output Peak Level Meters)**
These meters indicate the peak output level of the left and right channels. The watts scale indicates the output for an 8-ohm speaker load. The digital scale provides a display with 200 W output as 0 dB. Both scales operate at the time of monaural operation, but the watts output will be twice the indicated value of one meter (for example, for a meter indication of 100 W, there will be a monaural output of 200 W).
- 10 BALANCED INPUT (Balanced Input Indicator)**
When the INPUT SELECTOR **4** is set to BALANCED (), this indicator lights up to show that the balanced input (CANNON connector) has been selected.
- 11 PROTECTOR/PEAK (Muting Protector/Peak Level Indicator)**
 - PROTECTOR (Protector Indicator)
This amplifier is equipped with a variety of protection circuits. While these protection circuits are activated, this protector indicator flashes and the speaker output is muted.
 - (1) The muting function will operate and this indicator will flash for several seconds after the power switch is pressed and for 1 to 2 seconds when the INPUT SELECTOR **4** is switched. The amplifier will return to normal operation when the flashing stops.
 - (2) This indicator will flash at times such as when the offset voltage of the power amplifier strays from the specified range, when the temperature in the amplifier rises abnormally, when the speaker terminals are short-circuited, or when the connected speaker impedance is extremely low.

At the same time, the speaker output will be muted and the meter illumination and other indicators will all go off. If this should happen, quickly switch off the power and check the items in the figure on Page 10.

• **PEAK (Peak Indicator)**

When speakers of very low impedance are used, this indicator may light up depending on the output level. If the output level becomes higher, the protection circuit will operate and the amplifier may enter the condition of Step (2) above. To enjoy program sources with a high sound quality, adjust the volume to a level at which this PEAK indicator does not light up.

⑫ **MONAURAL OPERATION (Monaural Operation Indicator)**

This indicator will light up when the OPERATION switch ② of the back panel is set to the "MONAURAL" position.

⑬ **SPEAKERS (Speaker Indicator)**

This indicator will light up when the SPEAKER switch ① is at the ON (—) position.

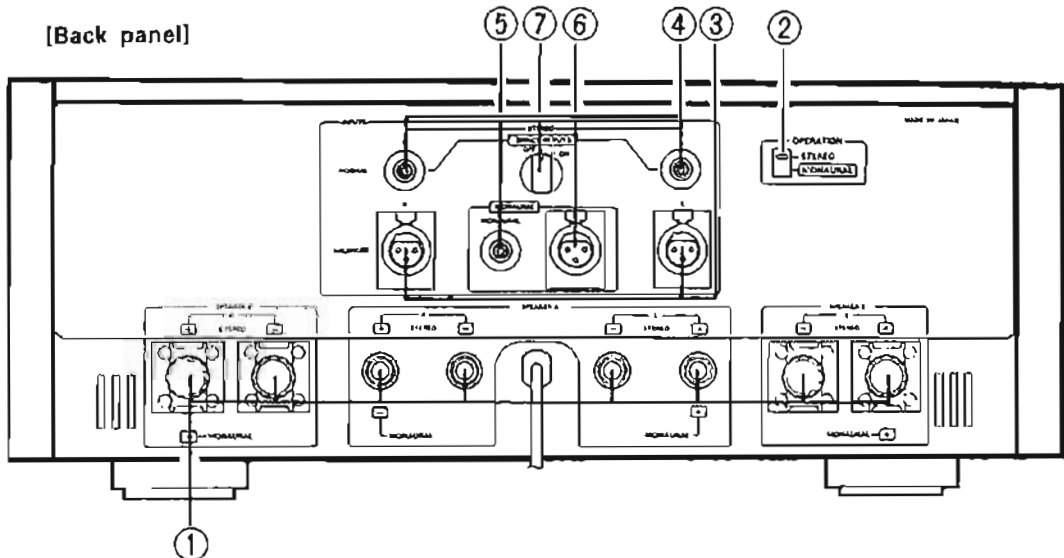

① **SPEAKER-A/B (Speaker A/B connection terminals)**

Connect the cords from the speakers. Two systems (A/B) can be used in parallel. The speakers can be switched on and off by the SPEAKER switch ② inside the front panel door. Make sure that you connect the speaker systems and the speaker terminals with the same polarities matching, (+) & (+), and (-) & (-).

NOTE: The speaker connection method differs depending on whether operation is stereo or monaural. Make the connections according to the CONNECTIONS section on Pages 6 and 7.

② **OPERATION (Operation Switch)**

This switch is used to select stereo or monaural operation. When set to the monaural side, the MONAURAL OPERATION indicator ⑫ on the front panel will light up.

NOTE: Monaural operation

In this unit, the amplifiers of the left and right channels are connected in a bridge (BTL) configuration which permits them to be switched into a monaural power amplifier using the amplifiers as an inverted polarity amplifier. When this is done, two units become necessary, one for the left channel and one for the right channel. (See Page 7.)

• **"STEREO"**

The switch is set to this position at the time of shipping. Using the stereo input jacks ③ and ④, and the stereo input level control ⑦ in the front panel door permits this amplifier to be used as a stereo power amplifier.

• **"MONAURAL"**

Using the monaural input jacks ⑤ and ⑥, and the monaural input level control ⑧ in the front panel door permits this amplifier to be used as a monaural power amplifier.

NOTE:

- Change the position of the switches using the tip of a narrow flat-bladed screwdriver. Be sure that the power of the set has been switched off when doing so.
- Note that the speaker connection method differs depending on whether operation is stereo or monaural. (See Pages 6 and 7.)

- ③ **BALANCED STEREO INPUTS (Balanced Stereo Input Jacks)**
 These are balanced input jacks (CANNON connectors) used at the time of stereo operation.
 To use these, set the INPUT SELECTOR ④ in the front panel door to the BALANCED (—) position.
- ④ **NORMAL STEREO INPUTS (Normal Stereo Input Jacks)**
 These are unbalanced input jacks (pin jacks) used at the time of stereo operation.
 To use these, set the INPUT SELECTOR ④ in the front panel door to the NORMAL (■) position.
- ⑤ **NORMAL MONAURAL INPUT (Normal Monaural Input Jack)**
 This is an unbalanced input jack (pin jack) used at the time of monaural operation.
 To use this jack, set the INPUT SELECTOR ④ in the front panel door to the NORMAL (■) position.
- ⑥ **BALANCED MONAURAL INPUT (Balanced Monaural Input Jack)**
 This is a balanced input jack (CANNON connector) used at the time of monaural operation.
 To use this jack, set the INPUT SELECTOR ④ in the front panel door to the BALANCED (—) position.

- ⑦ **DIRECT INPUTS (Direct Input Switch)**
 This switch is normally used in the OFF position. When set to ON, the stereo normal input bypasses the input selector and the input level control and is input directly to the power amplifier to permit playback of even higher quality.

NOTE:

- This switch is only effective for the normal input jacks (pin plugs) used at the time of stereo operation. Set this switch to the OFF position when using the input level control and the balanced inputs, and during monaural operation.
- Be sure that the power has been switched off before disconnecting or connecting the input connection cords.

{For multiple voltage model only}

LINE VOLTAGE (Line Voltage Selection Switch)

- The desired voltage may be set with the VOLTAGE SELECTOR knob on the rear panel, using a screwdriver.
- Do not twist the VOLTAGE SELECTOR knob with excessive force as this may cause damage.
- If the VOLTAGE SELECTOR knob does not turn smoothly, please contact a qualified serviceman.
- Be sure that the AC plug is disconnected from the power outlet when changing the setting.

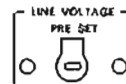

Setup precautions

- When installing into a rack or shelves, etc., be sure that the shelf strength is sufficiently strong enough to support the weight of this unit.
- Because of the heat given off, do not place other AV components directly on top of this unit, rather, leave a space of at least 15 cm. Also, avoid installation into a doored rack.
- Set the unit so that hum or other noise is not produced in conjunction with other AV components.
- Avoid applications where this unit will be used in conjunction with a selection device that selects combinations of a number of amplifiers and speakers. When using this unit in monaural operation, be especially careful since this unit operates with the negative (-) output of the speaker is separated from ground. Accidental short-circuiting will be the cause of damage.

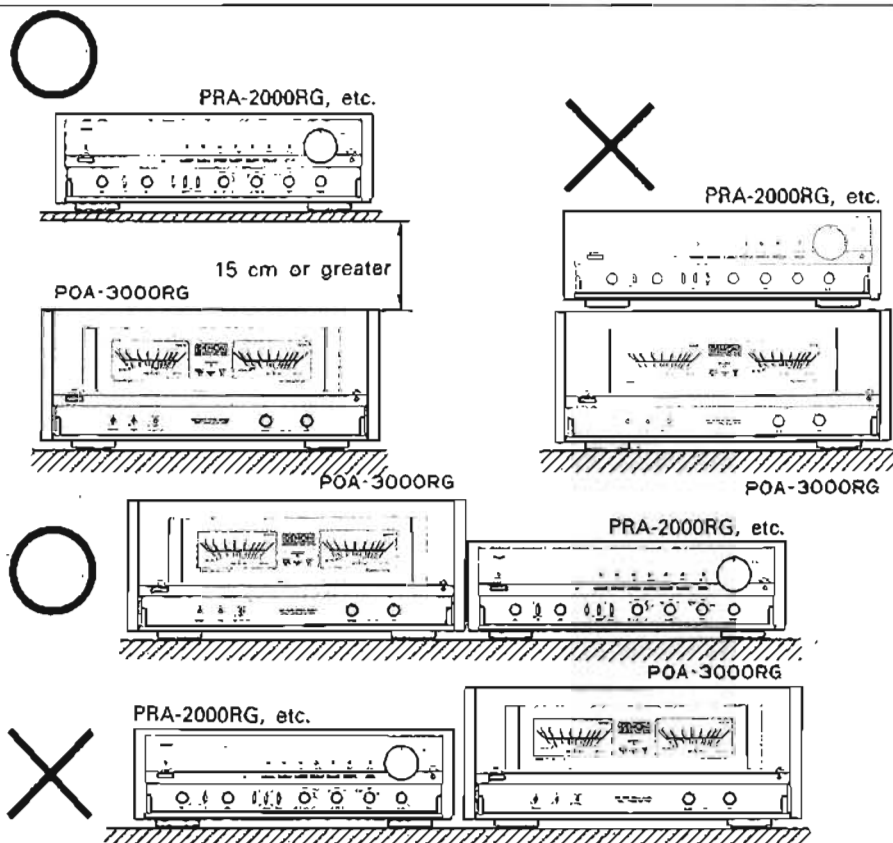

CONNECTIONS

[When used for stereo operation]

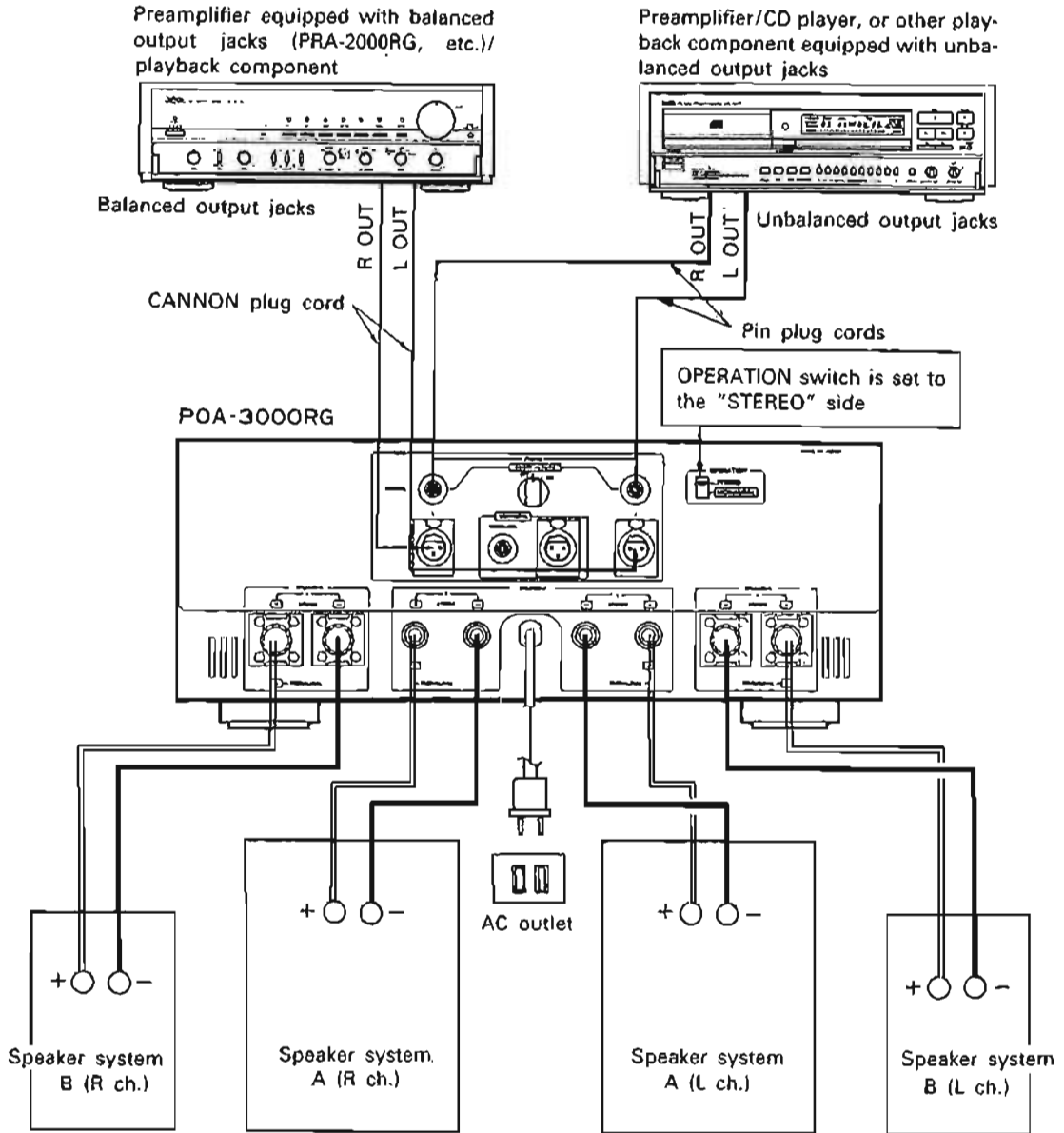

Connection precautions

- Do not plug the power cord into the AC outlet until all connections have been completed.
- Check the left and right channels, then carefully connect L & L, and R & R.
- Insert the plugs securely. Incomplete connections will lead to noise generation.
- Note that bundling pin plug cords together with power cords, or setting pin plug cords close to power transformers will lead to hum or noise.

Speaker impedance

- When one set of either A or B speakers is connected, speakers with a speaker impedance of 4 ohms or greater can be connected.
- When both sets of A, and B speakers are connected, speakers with a speaker impedance of 8 ohms or greater can be connected for each set.
- Note that when speakers of impedances less than those noted above are connected, the protection circuit may be activated or damage may be caused.

[When used for monaural operation]

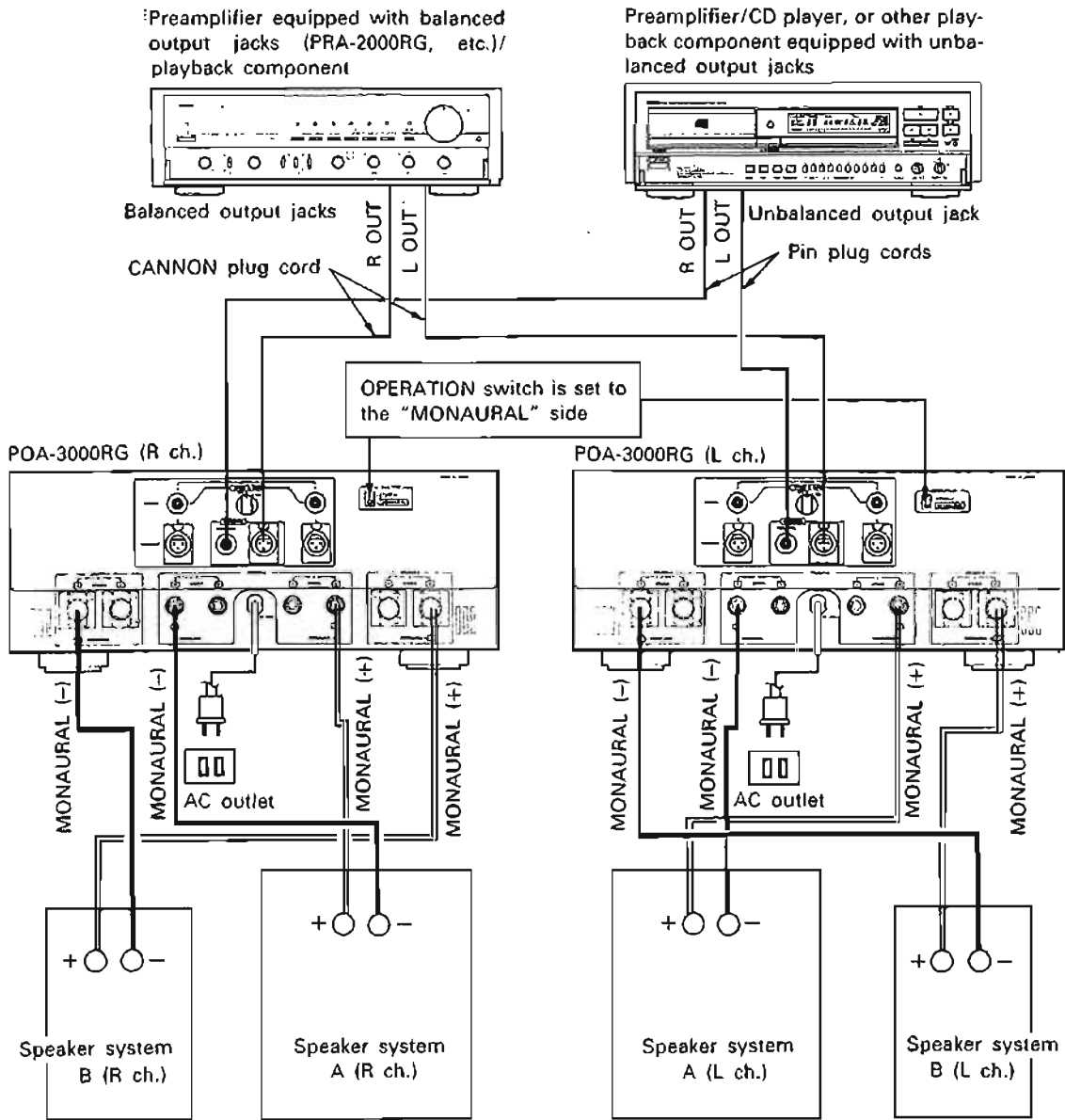

Speaker system connections

- Speaker terminal A uses a Johnson terminal, the type used in measuring instruments, which can accept banana plugs. Use the accompanying terminal cap for protection of the terminal and for preventing contact of speaker wires that may be protruding.
- Speaker terminal B has a large contact area and can accept extremely thick speaker cables.
- Use terminals A and B with cables used in a parallel output.

NOTE:

- Be sure to switch off the power before changing the position of the OPERATION switch.
- The speaker connection method differs with stereo operation and monaural operation.
- Set the DIRECT INPUTS switch to OFF when using the input level control and a balanced input, as well as during monaural operation.
- Be sure that the AC plug is disconnected from the power outlet when changing the setting of the LINE VOLTAGE switch. (for multiple voltage model only)

BLOCK DIAGRAM

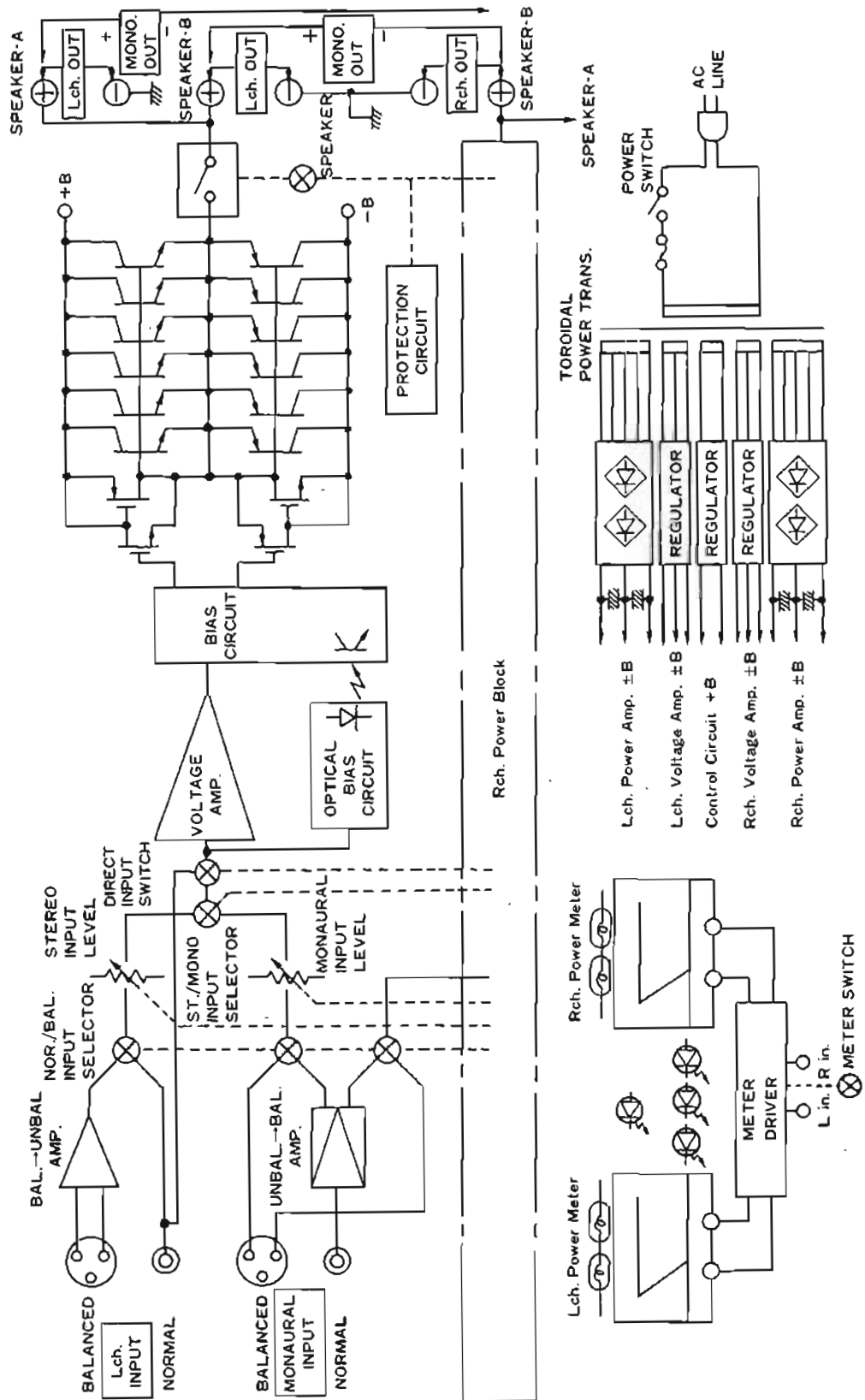

SPECIFICATIONS

POWER AMPLIFIER SECTION

- **Rated output power:**
 - STEREO: Continuous 250 W per channel min. both channel driven, into 8 ohms from 20 Hz to 20 kHz with no more than 0.05% total harmonic distortion.
400 W + 400 W (4 ohm load, T.H.D.: 0.1%)
 - MONAURAL: Continuous 500 W min. monaural channel driven, into 8 ohms from 20 Hz to 20 kHz with no more than 0.05% total harmonic distortion.
800 W (4 ohm load, T.H.D.: 0.1%)
- **Dynamic power:**
 - STEREO: 900 W + 900 W (2 ohm load)
1200 W + 1200 W (1 ohm load)
 - MONAURAL: 1500 W (2 ohm load)
1600 W (1 ohm load)
- **Total harmonic distortion:**
 - STEREO: 0.005% (20 Hz ~ 20 kHz, 8 ohm load, rated output -3 dB)
 - MONAURAL: 0.008% (20 Hz ~ 20 kHz, 8 ohm load, rated output -3 dB)
- **Intermodulation distortion:** 0.003% or less (7 kHz/60 Hz = 1/4, 8 ohm load, at an amplitude output equivalent to the rated output)
- **Power bandwidth:** STEREO/MONAURAL: 5 Hz ~ 50 kHz
(T.H.D.: 0.05%, 8 ohm load, rated output -3 dB)
- **Frequency response:** STEREO: 1 Hz ~ 100 kHz (8 ohm load, at 1 W output)
- **Input sensitivity:** STEREO: NORMAL ... 1 V
BALANCED ... 1 V
MONAURAL: NORMAL ... 0.7 V
BALANCED ... 1.4 V
- **Input impedance:** STEREO: NORMAL ... 20k ohms
BALANCED ... 10k ohms
MONAURAL: NORMAL ... 20k ohms
BALANCED ... 40k ohms
- **Output impedance:** 0.08 ohms (1 kHz)/STEREO
- **S/N ratio ("A" curve weighting):** STEREO: NORMAL ... 121 dB
BALANCED ... 112 dB
MONAURAL: NORMAL ... 108 dB
BALANCED ... 121 dB
- **Speaker output terminals:** A or B: 4 ohms or greater
A + B: 8 ohms or greater

LEVEL METER CHARACTERISTICS

- **Indication method:** Peak value indication output level meter
- **Indication range:** -50 dB to +5 dB
0 dB = 200 W/8 ohms (STEREO setting)
(Twice the watt indication value at the MONAURAL setting)
- **Frequency response:** 10 Hz ~ 100 kHz \pm 3% (at 1 W output)

GENERAL

- **Power supply:** AC110, 220 V, 50/60 Hz [Asia (multiple)], AC120 V, 60 Hz (U.S.A.)
- **Power consumption:** 650 W [Asia (multiple)], 700 W (U.S.A.)
- **Dimensions:** 495 mm (19-31/64") W x 200 mm (7-7/8") H x 490 mm (19-19/64") D
(including controls and height of feet)
- **Weight:** 35 kg (77 lbs 4 oz)

* Specifications and design are subject to change without notice for the purpose of improvement.

TROUBLESHOOTING

1. Have all connections been made PROPERLY?
2. Have you followed all operational instructions correctly?
3. Check speaker and the trutable systems for proper operation.

When your unit does not seem to be operating correctly, first check the items in the following table. If the symptom does not correspond to any of the problems as shown below, turn off the power sources immediately and contact your DENON dealer.

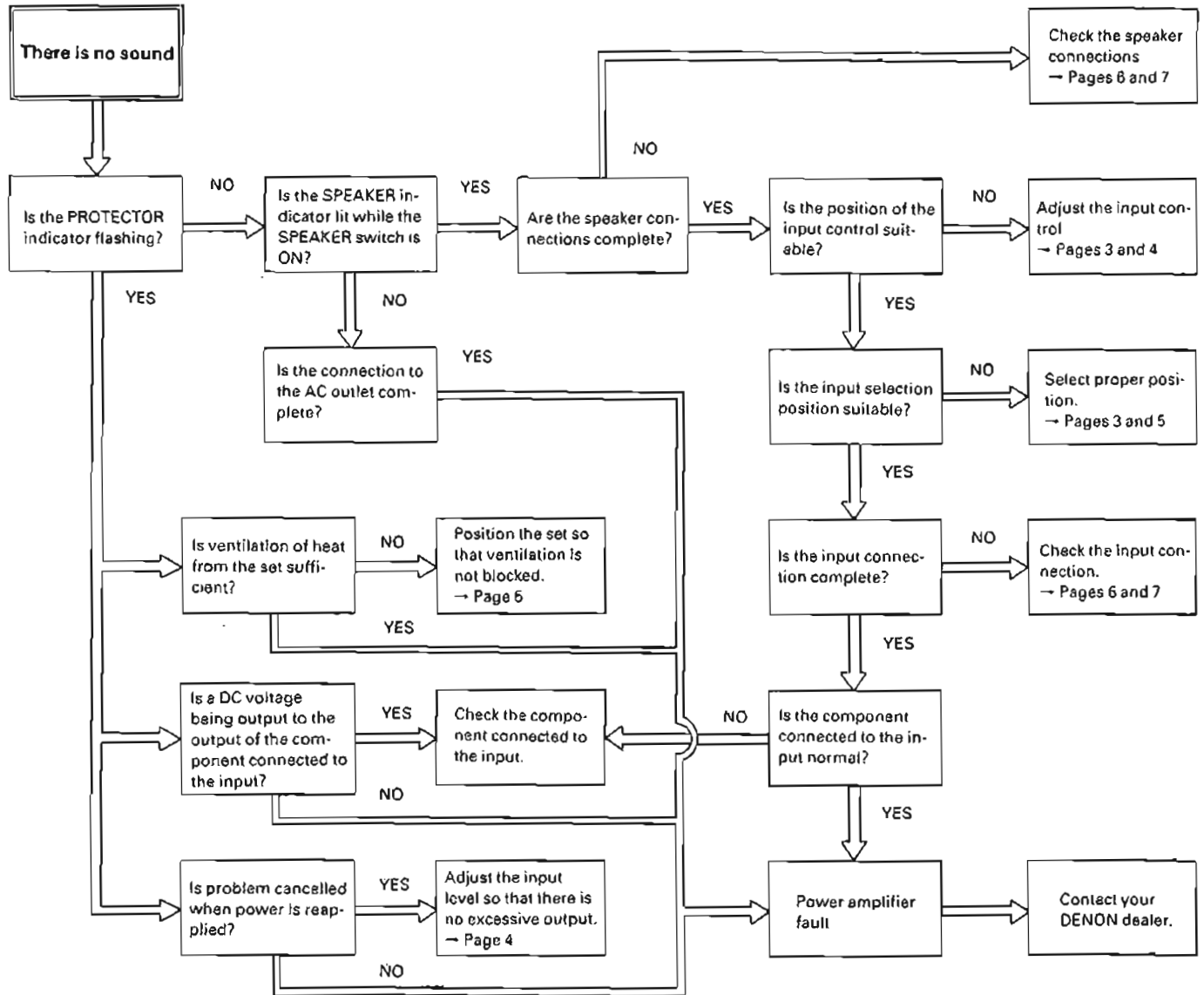

REMOVAL OF EACH SECTION

1. TOP COVER AND OTHERS

- (1) Remove 8 screws (B) and pull off Side Plates.
- (2) Remove 8 screws (A) and lift up the Top Cover.
- (3) Remove 4 screws (C) and 4 stands, and remove 21 screws (D). Then pull down Bottom Plate.

Note: Reattach the 4 stands to the main body if necessary.

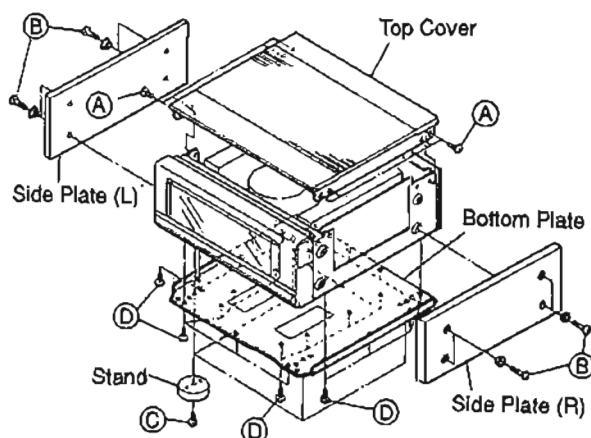

2. FRONT PANEL

- (1) Detach Top Cover, Side Plates and Bottom Plate. (Refer to the previous Figure.)
- (2) Remove 5 screws (E) and detach the Front Panel.
- (3) Pull off the knob after unfastening BSS screw.

Note: Pull the Front Panel straight forward not to break the Main Switch Button.

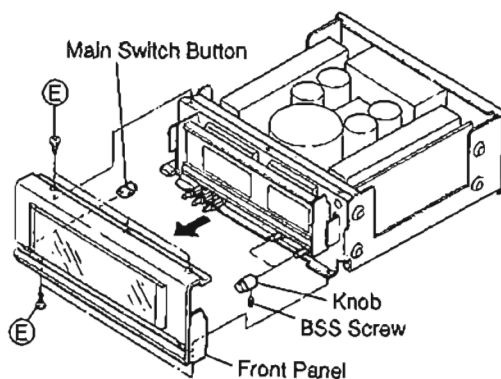

3. FRONT CHASSIS

- (1) Pull off the Main Switch Button, then remove 6 screws (F) and remove Shield Cover.
- (2) Remove 5 screws (G) and detach the Front Chassis.
- (3) Pull off individual connectors and remove 4 screws (H). Then detach the Control P.W.Board.

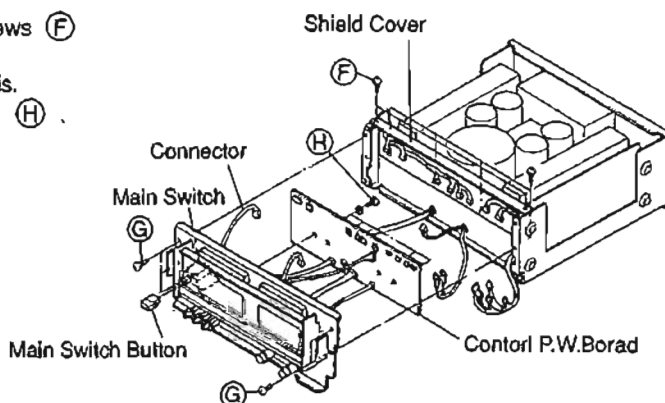

4. REAR PANEL

- (1) Remove 7 screws (K) and pull off the Rear Panel.
- (2) Remove the Shield Cover with 2 screws (M).
- (3) Pull off the individual connectors from the Rear Panel.

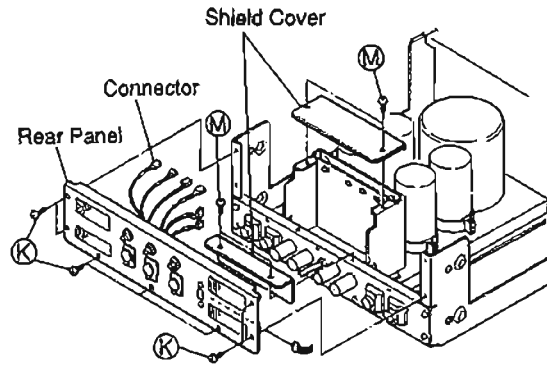

5. POWER AMPLIFIER P.W.BOARD

- (1) Pull off the individual connectors and remove 2 screws (I) each on Cord Clamps at the upper part of Heatsink.
- (2) Remove 4 screws (J) each on right and left points and detach the Power Amplifier P.W.Board.

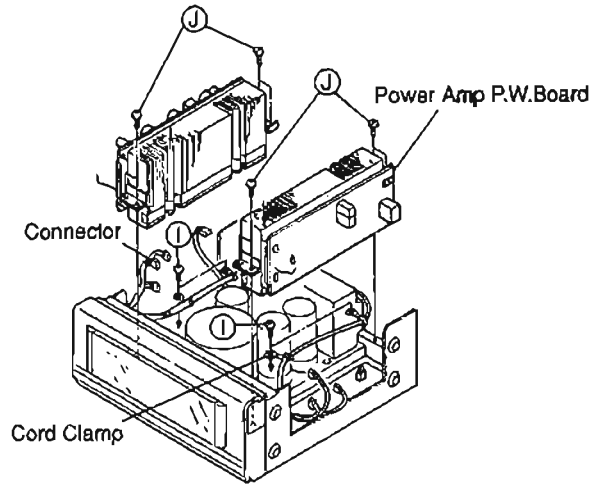

6. INPUT P.W.BOARD

- (1) Remove 4 screws (N) and pull off individual connectors. Then detach the Input Unit.
- (2) Remove 2 upper screws (O) and remove Bottom P.W.Board Holder. Then the P.W.Board can be detached.
- (3) Remove 3 screws (P) and detach AC Relay Unit.
- (4) Pull off individual connectors and remove 4 screws (Q). Then the Input P.W.Board can be detached.

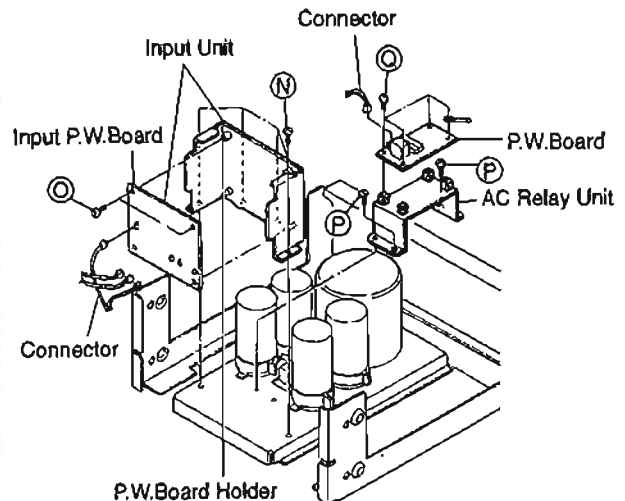

METHOD OF ADJUSTMENTS

● IDLE CURRENT ADJUSTMENT

1. REQUIREMENTS FOR ADJUSTMENT

- Digital Voltmeter
- Low Frequency Oscillator

2. SETUP

- (1) Keep the unit away from direct wind blown by an air-conditioner and an electric fan, and keep the unit under normal conditions. Adjust the range of ambient temperature to 15°-30°C. (59°F-86°F) under normal humidity.
- (2) Set the following switches as follows:
 - POWER (Power switch) to OFF ()
 - INPUT LEVEL (Level control) to 10 (counterclockwise)
 - REAR SPEAKERS (Speaker terminal) to no load (Speakers, dummy, etc. disconnected)
 - REAR DIRECT INPUTS (Direct input switch) to OFF

3. ADJUSTMENT

- (1) Take off the right and left Side Covers and the Top Cover, and set VR301, VR302 of KU-9191 (Power Amplifier P.W.Board) to the center, and VR303, VR304 to the position fully counterclockwise to the end.
- (2) Connect a DC Voltmeter to Test Points (TP).
- (3) Connect Power Code to AC wall outlet and turn Power switch ON ().
- (4) After Power is ON, turn VR301, VR302 clockwise to adjust the voltage at Test Points as 5 ± 0.5 mV DC.
- (5) After 10 min. from pre-adjustment, turn VR301, VR302 to set the voltage as 7 ± 1 mV DC.
- (6) Input 1 kHz, 40 mV rms sine waveform from NORMAL INPUT (STEREO) terminals.
- (7) Turn INPUT LEVEL (STEREO) knob to maximum (clockwise), and confirm that the voltage at Test Points increases at this moment.
- (8) Turn VR303, VR304 and set the voltage as 10 ± 1 mV DC.
- (9) After 10 min., turn VR303, VR304, and set the voltage as 15 ± 1 mV DC.

Note: The voltage value at TP indicates the absolute value of voltage in between TP.

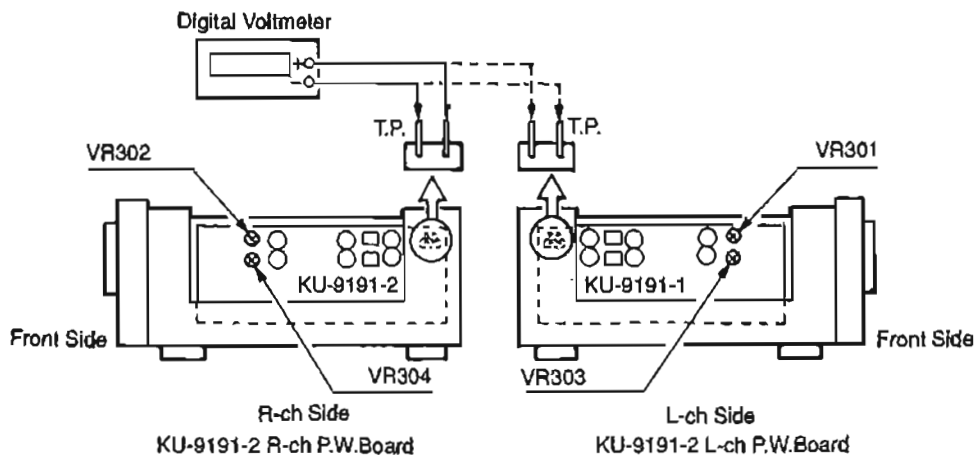

● CONFIRMATION OF CENTER POINT VOLTAGE

- (1) Connect a digital voltmeter to SPEAKER terminals.
- (2) Turn Power ON for the unit.
- (3) Turn Front Panel "INPUT LEVEL (STEREO)" Volume to maximum (0).
- (4) Confirm that the voltage at the digital voltmeter is in the range of ± 100 mV. (For L, R both channels)

● METER ADJUSTMENT

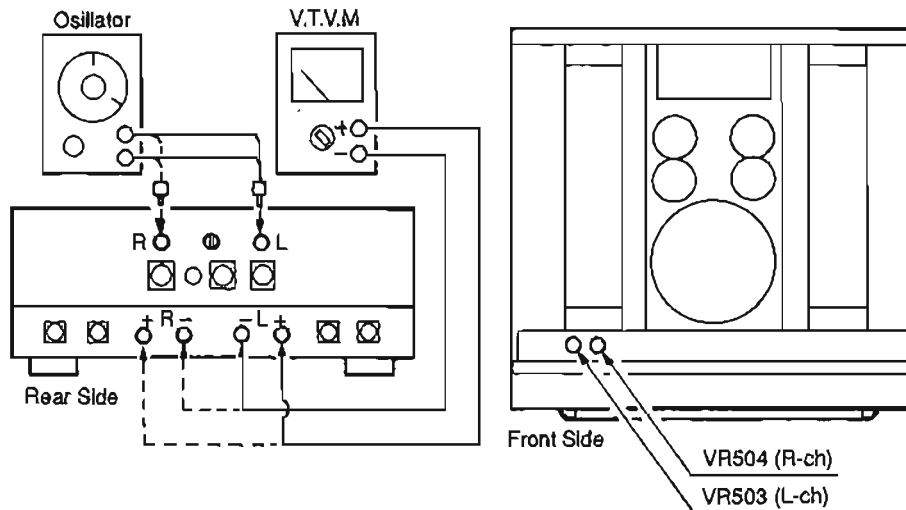

- (1) Connect an oscillator to "NORMAL" INPUT (STEREO) terminal.
- (2) Connect a V.T.V.M. to SPEAKER terminal.
- (3) Turn Power ON, and turn "INPUT LEVEL (STEREO)" Volume to maximum (0).
- (4) Adjust output of the oscillator (oscillating frequency: 1 kHz), and set the output voltage of the unit at 12.65 V.
- (5) Adjust VR503: Lch (VR504: Rch), and set the position of the meter indicator at -10 dB.
- (6) Increase output of the oscillator by 10 dB, and confirm that the meter reads $0 \text{ dB} \pm 2.0 \text{ dB}$.
- (7) Decrease output of the oscillator by 20 dB, and confirm that the meter reads $-20 \text{ dB} \pm 5 \text{ dB}$.

SEMICONDUCTORS

● IC's

NJM78M12FA

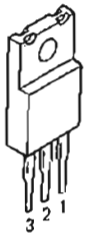

1:Output
2:GND
3:Input

NJM78L24A



1:Output
2:GND
3:Input

TLP521-1(BL)

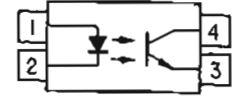

M5238P

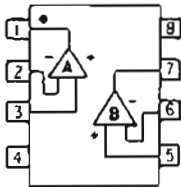
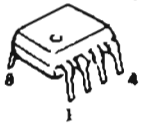

NJM2082L

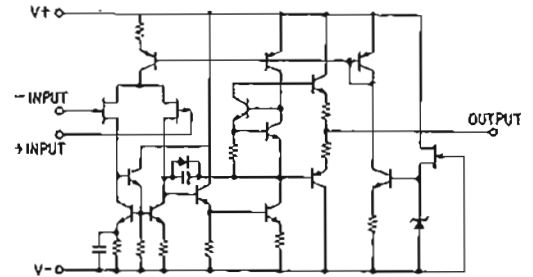
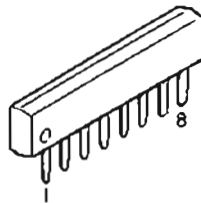

TA-7318P

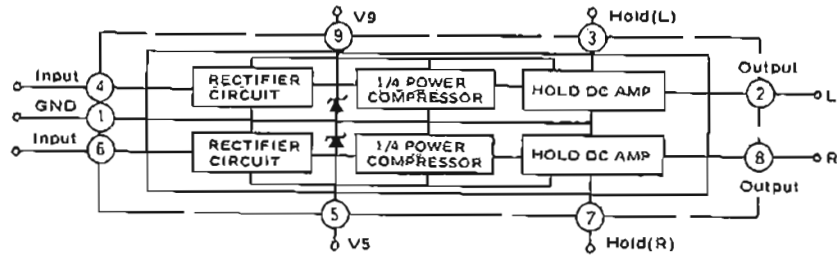
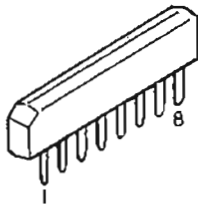

● Transistors

**2SA1015(GR)
2SC1815(BL)**

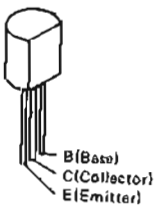

B(Base)
C(Collector)
E(Emitter)

**2SA1145(O)/(Y)
2SA1321
2SC2655(Y)
2SB647A(C)
2SC3334(TYPE-6)
2SC4208A
2SD667A(C)
2SC2705(O)/(Y)**

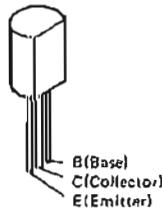

B(Base)
C(Collector)
E(Emitter)

2SC2458(BL)

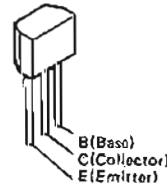

B(Base)
C(Collector)
E(Emitter)

**RN1202(10k-10k)
RN1205(2.2k-47k)
RN2202(10k-10k)**

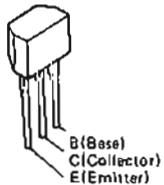

B(Base)
C(Collector)
E(Emitter)

RN1202

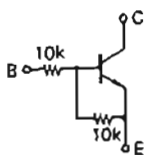

RN2202

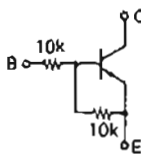

RN1205

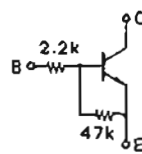

2SA1360(O/Y)
2SC3423(O/Y)

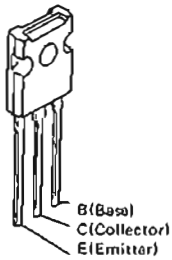

2SB1156(P/Q)

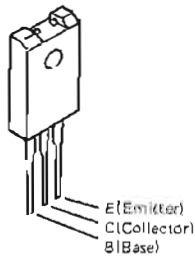

2SA1306 O/Y
2SC3298 O/Y

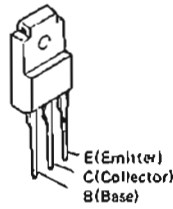

2SJ115
2SK405

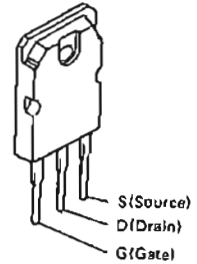

2SA1492LB O/P/Y
2SC3858LB O/P/Y

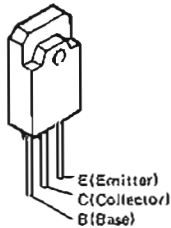

2SA1006(Q)/(P)
2SC2336(Q)/(P)

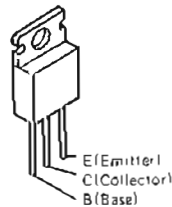

2SK184C(GR)/(BL)

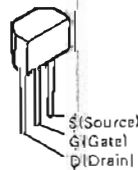

2SJ78
2SK215

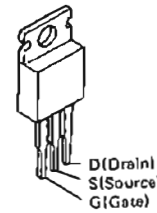

2SK373(Y)
2SK381(C)

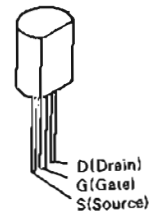

● Diodes (Including LED)

1S2076A

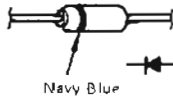

HZ3B-2
HZ6B-2
HZ9B-2
HZ16-2
HZ18-2
HZS24-2

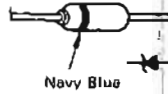

D1NK20
UTZJ24B-T77
UTZJ39A-T77
UTZJ39C-T77

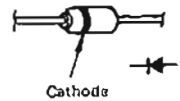

1SR139-200T-32

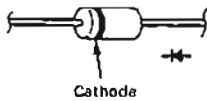

S2K20F

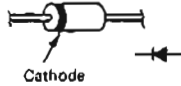

1SS82

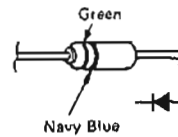

TLR112

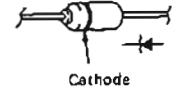

SFOR1A42

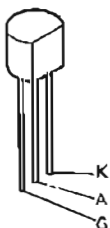

PTH487A01BD222TS

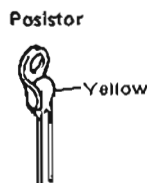

SEL-4214S(RD)
SEL-4414E(GN)
SEL-4914A(OG)

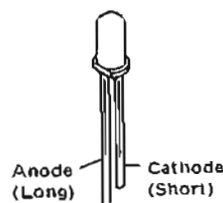

15D4B41

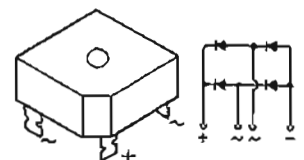

NOTE FOR PARTS LIST

- Part indicated with the mark "⊙" are not always in stock and possibly to take a long period of time for supplying, or in some case supplying of part may be refused.
 - When ordering of part, clearly indicate "1" and "1" (!) to avoid mis-supplying.
 - Ordering part without stating its part number can not be supplied.
 - Part indicated with the mark "★" is not illustrated in the exploded view.
 - Not including Carbon Film ±5%, 1/4W Type in the P.W.Board parts list, except parts for non-burning (N.B.), audio equipment. (Refer to the Schematic Diagram for those parts.)
- WARNING:**
Parts marked with this symbol  have critical characteristics.
Use ONLY replacement parts recommended by the manufacturer.

● Resistors

Ex.: RN 14K 2E 182 G FR
 Type Shape and performance Power Resistance Allowable error Others

RD : Carbon	2B : 1/8W	F : ±1%	P : Pulse-resistant type
RC : Fixed	2E : 1/4W	G : ±2%	NL : Low noise type
RS : Metallic film	2H : 1/2W	J : ±5%	NB : Non-burning type
RW : Winding	3A : 1W	K : ±10%	FR : Fuse resistor
RN : Metal film	3D : 2W	M : ±70%	F : Lead wire forming
RK : Metal mixture	3F : 3W		PSNS : } Audio Equipment
	3H : 5W		RMA : }

Resistance
 1 8 2 ⊙ 1800Ω = 1.8kΩ
 ————— Indicates number of zeros after effective number
 ————— 2-digit effective number, decimal point indicated by R.
 • Units: Ω

● Capacitors

Ex.: CE 04W 1H 2R2 M BP
 Type Shape and performance Dielectric strength Capacity Allowable error Others

CE : Aluminum foil electrolyte	0J : 6.3V	F : ±1%	HS : High stability type
CA : Aluminum solid electrolyte	1A : 10V	G : ±2%	BP : Non-polar type
CS : Tantalum electrolyte	1C : 16V	J : ±5%	HR : Ripple-resistant type
CO : Film	1E : 25V	K : ±10%	DL : For charge and discharge
CK : Ceramic	1V : 35V	M : ±20%	HF : For assuring high frequency
CC : Ceramic	1H : 60V	Z : +80%	U : UL part
CP : Oil	2A : 100V	-20%	C : CSA part
CM : Mica	2B : 125V	P : +100%	W : UL-CSA type
CF : Metallized	2C : 160V	-0%	F : Lead wire forming
CF : Metallized	2D : 200V	C : ±0.25pF	
	2E : 250V	D : ±0.5pF	
	2H : 500V	-	
	2J : 630V		

Capacity
 2 R 2 ⊙ 2.2μF
 ————— 1-digit effective number, decimal point indicated by R.
 ————— 2-digit effective number, decimal point indicated by R.

- Units: μF, (for P, pF (pμF))
- When the dielectric strength is indicated in AC, "AC" is included after the dielectric strength value.

PRINTED WIRING BOARD PARTS LIST
KU-9191D POWER AMP UNIT

Ref. No.	Part No.	Part Name	Remarks
SEMICONDUCTORS GROUP			
IC301-304	263 0897 001	NJM2082L	IC OP-AMP
IC305,306	262 0874 009	TLP521-1(BL)	IC Photo Coupler
TR301-304	275 0055 015	2SK184C(GR)/(BL)	FET
TR305-308	273 0333 003	2SC3423(O/Y)	Transistor
TR209-316	271 0202 002	2SA1360(O/Y)	Transistor
TR317-320	273 0333 003	2SC3423(O/Y)	Transistor
TR321,322	273 0380 001	2SC4208A	Transistor
TR323	271 0196 008	2SA1306 O/Y	Transistor
TR324	273 0324 009	2SC3298 O/Y	Transistor
TR325-334	275 0042 002	2SK373(Y)	FET
TR335,336	271 0201 003	2SA1321	Transistor
TR337,338	273 0291 006	2SC2336A(Q)/(P)	Transistor
TR339,340	271 0176 002	2SA1006A(Q)/(P)	Transistor
TR341-344	275 0042 002	2SK373(Y)	FET
TR345,346	275 0069 001	2SK215	FET
TR347,348	275 0068 002	2SJ78	FET
TR377,378	273 0332 004	2SC3334	Transistor
TR379,380	269 0067 901	RN1205(2.2k-47k)	D. Transistor
TR381,382	273 0317 906	2SC2458(BL)	Transistor
TR383,384	271 0196 008	2SA1306 O/Y	Transistor
D305-308	276 0256 901	HZ16-2	Zener
D309,310	276 0049 011	1S2076A	Diode
D311-314	276 0568 903	UTZJ24B-T77	Diode
D315-318	276 0049 011	1S2076A	Diode
D319-326	276 0569 902	UTZJ39A-T77	Diode
D327-334	276 0348 000	S2K20F	Diode
D335-346	276 0049 914	1S2076A	Diode
D347-350	276 0566 002	DINK20	Diode
D351,352	276 0565 003	1SS82	Diode
D353-360	276 0049 011	1S2076A	Diode
D361-364	276 0256 901	HZ16-2	Diode
D365,366	276 0049 011	1S2076A	Diode
P301,302	276 0289 004	PTH487A01BD222TS	Posistor
RESISTORS GROUP (not Included Carbon Film $\pm 5\%$, 1/4W type.)			
(Carbon Film Resistor)			
R303,304	241 2426 940	RD14B2E473J(PSNB)	47k Ω , 1/4W, (*)
R305,306	241 2424 968	RD14B2E822J(PSNB)	8.2k Ω , 1/4W, (*)
R316,318	241 2412 051	RD14-3D333J(RMA)	33k Ω , 2W, (*)
R317,318	241 2412 064	RD14-3D105J(RMA)	1M Ω , 2W, (*)
R319-322	241 2379 903	RD14B2E471JNBS	470 Ω , 1/4W, (N.B)
R323-326	241 2377 989	RD14B2E151JNBS	150 Ω , 1/4W, (N.B)
R329,330	241 2377 934	RD14B2E910JNBS	91 Ω , 1/4W, (N.B)
R331-334	241 2378 904	RD14B2E181JNBS	180 Ω , 1/4W, (N.B)
R335,336	241 2423 024	RD14B2E222J(PSNB)	2.2k Ω , 1/4W, (*)
R337,338	241 2426 940	RD14B2E473J(PSNB)	47k Ω , 1/4W, (*)
R345,346	241 2369 078	RD14B2E472JNBF	4.7k Ω , 1/4W, (N.B)
R347-350	241 2387 908	RD14B2E010JNBS	1 Ω , 1/4W, (N.B)
R359-362	241 2429 963	RD14B2E105J(PSNB)	1M Ω , 1/4W, (*)
R443-446	241 2377 947	RD14B2E101JNBS	100 Ω , 1/4W, (N.B)
R447,448	241 2376 977	RD14B2E510JNBS	51 Ω , 1/4W, (N.B)
R449,450	241 2379 903	RD14B2E471JNBS	470 Ω , 1/4W, (N.B)
R451,452	241 0229 000	RD14B2H683J	68k Ω , 1/2W
R457-460	241 2412 048	RD14-3D4R7J(RMA)	4.7 Ω , 2W, (*)

Ref. No.	Part No.	Part Name	Remarks
(Wirewound Resistor)			
R395-404	243 2082 005	RW99-3FOR1K	0.1 Ω , 3W
R405,406	243 0028 003	RW99-3FR22K	0.22 Ω , 3W
R407-416	243 2082 005	RW99-3FOR1K	0.1 Ω , 3W
R417,418	243 0028 003	RW99-3FR22K	0.22 Ω , 3W
(Metal Oxide Film Resistor)			
R301,302	244 2051 974	RS14B3A102JST(S)	1k Ω , 1W
R307-310	244 2051 990	RS14B3A472JST(S)	4.7k Ω , 1W
R313,314	244 2052 986	RS14B3A751JST(S)	750 Ω , 1W
R327,328	244 2052 915	RS14B3A182JST(S)	1.8k Ω , 1W
R339,340	244 2057 004	RS14B3D221JFRF	220 Ω , 2W (Fusible)
R355-358	244 2051 961	RS14B3A101JST(S)	100 Ω , 1W
R363-366	244 0030 023	RS14B3A120JNBF	120 Ω , 1W, (N.B)
R367-370	244 2043 937	RS14B3A100JST(S)	10 Ω , 1W
R371-394	244 0013 024	RS14B3A4R71NBF	4.7 Ω , 1W, (N.B)
R419-428	244 2056 005	RS14B3A103JNBF (RSM)	10k Ω , 1W, (N.B)
R431-440	244 2056 005	RS14B3A103JNBF (RSM)	10k Ω , 1W, (N.B)
R453-456	244 0078 014	RS14B3D220JNBF	22 Ω , 2W, (N.B)
R483-490	244 0107 024	RS14B3D562JNBF	5.6k Ω , 2W, (N.B)
R491-494	244 2051 961	RS14B3A101JST(S)	100 Ω , 1W
(Semi-Fixed Resistor)			
VR301,302	EP- 5462 H13	Solid Volume (103)	
VR303,304	EP- 5462 H21	Solid Volume (224)	
CAPACITORS GROUP			
(Electrolytic Capacitor)			
C305,306	254 3060 000	CE04W1H220MBP (AWF)	22 μ F/50V (Bypolar)
C319-322	254 4291 742	CE04W2A101MC(AWF)	100 μ F/100V
C327,328	254 4263 987	CE04W1A100M(SME)	10 μ F/100V
C329,330	254 4291 700	CE04W2A100MC(AWF)	10 μ F/100V
C331,332	254 4291 700	CE04W2A100MC(AWF)	10 μ F/100V
C335-338	254 4291 742	CE04W2A101MC(AWF)	100 μ F/100V
C339-346	254 4291 742	CE04W2A101MC(AWF)	100 μ F/100V
C353-356	254 4263 990	CE04W2A220M(SME)	22 μ F/100V
C357,358	254 4264 012	CE04W2A470M(SME)	47 μ F/100V
C365,366	254 4291 742	CE04W2A101MC(AWF)	100 μ F/100V
C369,370	254 4291 742	CE04W2A101MC(AWF)	100 μ F/100V
C375,376	254 4254 909	CE04W1C100M(SME)	10 μ F/16V
C377-380	254 4263 987	CE04W2A100M(SME)	10 μ F/100V
C389-392	254 4260 980	CE04W1H100M(SME)	10 μ F/50V
(Plastic Film Capacitor)			
C301,302	255 4217 981	CQ09P1H221J	220PF/50V
C303,304	255 4216 021	CQ09P1H682J	6800pF/50V

* Mark parts are for Audio Equipment Application resistor.

KU-9192D INPUT UNIT

Ref. No.	Part No.	Part Name	Remarks
C309,310	255 6163 059	CQ09S2E220J	22pF/250V
C311,312	255 4219 947	CQ09P1H102J	1000PF/50V
C313,314	255 4217 907	CQ09P1H101J	100pF/50V
C315,316	255 6152 099	CQ09S2E100J	10pF/250V
C317,318	255 4214 078	CQ09P1H101J	100pF/50V
C333,334	255 4199 973	CQ92M1H103J(MRZ)	0.01μF/50V
C349-352	255 6164 045	CQ09S2E101JF	100pF/250V
C359,360	255 4199 973	CQ92M1H103J(MRZ)	0.01μF/50V
C373,374	255 4199 973	CQ92M1H103J(MRZ)	0.01μF/50V
C381-384	255 4199 966	CQ92M1H102J(MRZ)	1000pF/50V
C393,394	255 6152 028	CQ09S2E240J	24pF/250V
(Metalized Capacitor)			
C323-326	256 1033 718	CF93B2A105KC(GU)	1μF/100V
C361,362	256 1046 006	CF93B2J103K(UA)	0.01μF/630V
C363,364	256 1046 019	CF93B2J223K(UA)	0.022μF/630V
RELAYS, INDUCTORS			
L301-304	235 0053 006	Inductor (1mH)	
RL301,302	214 0041 008	Relay	SP Relay
OTHER PARTS GROUP			
	417 0253 026	Radiator	4
	470 0012 022	Tapping Screw 3x12 with Washer	4
F301-304	206 1062 001	SSFR-5A-N1-F006	Fuses 5A 4
	412 9248 105	Common Plate	Cu 0.81 8
	205 0075 025	2P Terminal	2
	205 0452 017	Styrene Pin	6
	205 0190 036	3P NH Conn. Base	CN209,210, 113,114 4
	205 0233 032	3P EH Conn. Base	CN005 1
	205 0277 030	3P EH Conn. Base (RED)	CN006 1
	205 0233 045	4P EH Conn. Base	CN009 1
	205 0277 043	4P EH Conn. Base (RED)	CN010 1

Ref. No.	Part No.	Part Name	Remarks
SEMICONDUCTORS GROUP			
IC201	262 0679 000	M5238P	IC
TR201-204	275 0055 015	2SK184C(GR)/(BL)	FET
TR205,206	272 0053 005	2SB847A(C)	Transistor
TR207,208	274 0060 007	2SD667A(C)	Transistor
TR209-212	275 0055 015	2SK184C(GR)/(BL)	FET
TR213,214	271 0102 924	2SA1015(GR)	Transistor
TR215	273 0281 003	2SC2705(O)/(Y)	Transistor
TR216	275 0043 946	2SK381(C)	FET
TR217,218	271 0168 007	2SA1145(O)/(Y)	Transistor
TR219,220	273 0281 003	2SC2705(O)/(Y)	Transistor
D105	276 0049 011	1S2076A	Diode
D201,202	276 0299 939	HZ3B-2	Zener Diode
D203,204	393 9454 009	TLR112	Zener LED
D205	276 0567 904	UTZJ39C-T77	Zener Diode
D206,207	276 0249 002	HZ18-2	Zener Diode
D208,209	276 0481 019	HZS24-2	Zener Diode
D211-214	276 0481 019	HZS24-2	Zener Diode
D215	276 0049 011	1S2076A	Diode
RESISTORS GROUP (not Included Carbon Film ±5%, 1/4W type.)			
(Carbon Film Resistor)			
R201,202	241 2423 930	RD14B2E242J(PSNB)	2.4kΩ, 1/4W, (*)
R203,204	241 2423 943	RD14B2E272J(PSNB)	2.7kΩ, 1/4W, (*)
R205-208	241 2424 900	RD14B2E472J(PSNB)	4.7kΩ, 1/4W, (*)
R209,210	241 2425 051	RD14B2E203J(PSNB)	20kΩ, 1/4W, (*)
R211,212	241 2424 900	RD14B2E472J(PSNB)	4.7kΩ, 1/4W, (*)
R213,214	241 2427 020	RD14B2E104J(PSNB)	100kΩ, 1/4W, (*)
R215,216	241 2415 003	RD14B2E512J(PSNB)	5.1kΩ, 1/4W, (*)
△ R217,218	241 2378 968	RD14B2E391JNBST	390Ω, 1/4W, (N.B)
R219,220	241 2427 020	RD14B2E104J(PSNB)	100kΩ, 1/4W, (*)
△ R221,222	241 2378 933	RD14B2E241JNBST	240Ω, 1/4W, (N.B)
R223,224	241 2430 062	RD14B2H221J(RMA)	220Ω, 1/2W, (*)
R225	241 2425 967	RD14B2E223J(PSNB)	22kΩ, 1/4W, (*)
R226	241 2422 041	RD14B2E102J(PSNB)	1kΩ, 1/4W, (*)
△ R227,228	241 2377 963	RD14B2E121JNBST	120Ω, 1/4W, (N.B)
△ R229,230	241 2380 992	RD14B2E302JNBST	30kΩ, 1/4W, (N.B)
R231	241 2427 910	RD14B2E913J(PSNB)	91kΩ, 1/4W, (*)
△ R232	241 2377 963	RD14B2E121JNBST	120Ω, 1/4W, (N.B)
R233-235	241 2424 081	RD14B2E103J(PSNB)	10kΩ, 1/4W, (*)
△ R236	241 2378 933	RD14B2E241JNBST	240Ω, 1/4W, (N.B)
△ R238	241 2378 933	RD14B2E241JNBST	240Ω, 1/4W, (N.B)
R241,242	241 2430 062	RDA4B2H221J(RMA)	220Ω, 1/2W, (*)
R243-245	241 2424 081	RD14B2E103J(PSNB)	10kΩ, 1/4W, (*)
(Metal Oxide Film Resistor)			
△ R239,240	244 0101 020	RS14B3D182JNBF	18kΩ, 2W, (N.B)
CAPACITORS GROUP			
(Electrolytic Capacitor)			
C213,214	254 3071 701	CE04W2A100MBPC (AWF)	10μF/100V
C220	254 4291 700	CE04W2A100MC(AWF)	10μF/100V
C223,224	254 4356 027	CE04W1H220M(ARS)	22μF/50V

* Mark parts are for Audio Equipment Application resistor.

KU-9193D CONTROL UNIT

Ref. No.	Part No.	Part Name	Remarks
(Plastic Film Capacitor)			
C105-108	255 4228 967	CQ92P2A103J	0.01μF/100V
C207,208	255 4217 907	CQ09P1H101J	100pF/50V
C209,210	255 4199 986	CQ92M1H102J(MRZ)	1000PF/50V
C215,216	255 6154 000	CQ09S2E050F	5pF/250V
C217,218	255 4217 907	CQ09P1H101J	100pF/50V
C219	255 4217 949	CQ09P1H151J(PDH)	150PF/50V
C225	255 4217 907	CQ09P1H101J	100pF/50V
(Metalized Capacitor)			
C201,202	256 1033 035	CF93B2A474K(GU)	0.47μF/100V
C203,204	256 1035 091	CF93A1H105J	1μF/50V
C228	256 1033 035	CF93B2A474K(GU)	0.47μF/100V
RELAYS, SWITCHES			
RL101-104	214 0120 000	Relay (TV-8)	DIRECT INPUT
RL201,202	214 9005 100	Relay (BSA-H-12S)	
SW801	212 3633 006	Rotary Switch	
OTHER PARTS GROUP			Q'ty
CN016	205 0278 039	3P EH Conn. Base (BLK)	1
CN017	205 0190 036	3P NH Conn. Base	1
CN101,102	205 0233 032	3P EH Conn. Base	2
CN103,104	205 0190 036	3P NH Conn. Base	2
CN105	205 0278 039	3P EH Conn. Base (BLK)	1
CN106	205 0190 036	3P NH Conn. Base	1
CN107	205 0277 030	3P EH Conn. Base (RED)	1
CN108	205 0276 031	3P EH Conn. Base (BLU)	1
CN109,110	205 0190 036	3P NH Conn. Base	2
CN111	205 0296 037	3P EH Conn. Base (YEL)	1
CN201	205 0233 032	3P EH Conn. Base	1
CN202	205 0277 030	3P EH Conn. Base (RED)	1
CN209,210	205 0190 036	3P NH Conn. Base	2

Ref. No.	Part No.	Part Name	Remarks
SEMICONDUCTORS GROUP			
IC501	263 0696 905	NJM78L24AT	IC
IC502	263 0571 004	NJM78M12FA	IC
IC503	263 0071 009	TA-7318P	IC
TR501	271 0102 021	2SA1015(GR)	Transistor
TR502	272 0111 002	2SB1156(P/O)	Transistor
TR503	275 0043 946	2SK381(C)	FET
TR504-506	273 0198 015	2SC1815(BL)	Transistor
TR507	273 0212 904	2SC2655(Y)	Transistor
TR508,509	273 0198 015	2SC1815(BL)	Transistor
TR510	269 0026 900	RN2202(10k-10k)	D. Transistor
TR511	273 0198 015	2SC1815(BL)	Transistor
TR512	269 0026 900	RN2202(10k-10k)	D. Transistor
TR513	269 0025 008	RN1202(10k-10k)	D. Transistor
TR514	273 0198 015	2SC1815 (BL)	Transistor
TR515	273 0212 904	2SC2655(Y)	Transistor
TR516	271 0102 021	2SA1015(GR)	Transistor
TR517-519	273 0198 015	2SC1815(BL)	Transistor
TR520	271 0102 021	2SA1015(GR)	Transistor
TR521-525	273 0198 015	2SC1815(BL)	Transistor
TR526	269 0025 008	RN1202(10k-10k)	D. Transistor
TR527,528	273 0198 015	2SC1815(BL)	Transistor
TR529	269 0025 008	RN1202(10k-10k)	D. Transistor
TR530,531	273 0198 015	2SC1815(BL)	Transistor
TR533-538	273 0198 015	2SC1815(BL)	Transistor
TR539,540	271 0102 021	2S1015(GR)	Transistor
TR541-541	269 0025 008	RN1202(10k-10k)	D. Transistor
TR545,546	269 0026 900	RN2202(10k-10k)	D. Transistor
TR547	273 0198 015	2SC1815(BL)	Transistor
D001	276 0049 011	1S2076A	Diode
D500	276 0049 011	1S2076A	Diode
D501-508	276 0348 000	S2K20F	Diode
D507	276 0552 906	1SR139-200T-32	Diode
D508-510	276 0218 936	HZ9B-2	Zener Diode
D511	276 0173 932	HZ8B-2	Zener Diode
D520,521	276 0049 011	1S2076A	Diode
D523-525	276 0049 011	1S2076A	Diode
D527,528	276 0049 011	1S2076A	Diode
D530-537	276 0049 011	1S2076A	Diode
D539,540	276 0049 011	1S2076A	Diode
D541	279 0016 001	SF0R1A42	Diode
LE501	393 9408 903	SEL-4214S	LED(RED)
LE502,503	393 9408 929	SEL-4914A	LED(ORG)
LE504	393 9408 916	SEL-4414E	LED(GRN)
RESISTORS GROUP (not included Carbon Film ±5%, 1/4W type.)			
(Carbon Film Resistor)			
▲ R503	241 2376 964	RD14B2E470JNBST	47Ω, 1/4W, (N.B)
(Wirewound Resistor)			
R001,002	243 2079 021	RW78A4A330K=(UL)	33Ω, 10W
(Metal Oxide Film Resistor)			
R501,502	244 2043 982	RS14B3AR22JST(S)	0.22Ω, 1W

Ref. No.	Part No.	Part Name	Remarks	
△ R519	244 0066 026	RS14B3D2R2JNBF	2.2Ω, 2W. (N.B)	
R577	244 2051 929	RS14B3A821JST(S)	820Ω, 1W	
(Thermistors)				
R575,576	279 0006 011	112101-2		
(Variable, Semi-Fixed Resistor)				
VR501,502	211 9094 002	V1820V20SA503	50kΩ Variable Resistor INPUT VOL.	
VR503,504	211 6014 056	V09QB202	2kΩ Semi-Fixed Resistor METER APJ.	
CAPACITORS GROUP				
(Ceramic Capacitor)				
△ C001	253 8011 006	CK45F2EAC103ZC	0.01μF/250V AC	
C501	253 8011 006	CK45F2EAC103ZC	0.01μF/250V AC	
C534	253 1024 003	CK45F1H103Z	0.01μF/50V	
(Electrolytic Capacitor)				
C502-504	254 4258 798	CE04W1V102MC	1000μF/35V	
C505-508	254 4260 948	CE04W1H010M(SME)	1μF/50V	
C509	254 4256 774	CE04W1E471MC(SME)	470μF/25V	
C510	254 4260 906	CE04W1H0R1M(SME)	0.1μF/50V	
C511	254 4254 941	CE04W1C101M(SME)	100μF/16V	
C512	254 4254 938	CE04W1C470M(SME)	47μF/16V	
C513-516	254 4254 909	CE04W1C100M(SME)	10μF/16V	
C517	254 4254 051	CE04W1C221M(SME)	220μF/16V	
C518	254 4260 948	CE04W1H010M(SME)	1μF/50V	
C519-522	254 4254 909	CE04W1C100M(SME)	10μF/16V	
C523,524	254 4250 929	CE04W0J101M(SME)	100μF/6.3V	
C525,526	254 4260 948	CE04W1H010M(SME)	1μF/50V	
C529,530	254 4256 910	CE04W1E220M(SME)	22μF/25V	
C531	254 4260 935	CE04W1HR47M(SME)	0.47μF/50V	
C533	254 4254 006	CE04W1C100M(SME)	10μF/16V	
C535	254 4260 058	CE04W1H2R2M(SME)	2.2μF/50V	
(Plastic Film Capacitor (Mylar))				
C527,528	255 1250 909	CQ93M1H223J(B)	0.022μF/50V	
RELAYS, SWITCHES				
RL001	214 0115 002	Relay	AC Relay	
RL501	214 9005 100	Relay (BSR-H-12S)	MOND/ST	
△ SW001	212 2609 002	Power Switch (S0DF)	POWER	
SW501	212 2612 002	3P Push Switch	INPUT/SPEAKER	
SW502	212 2611 003	Slide Switch	MONO/ST	
OTHER PARTS GROUP				Q'ty
	EP-5870	Fuse Holder	for F001	2
△ F001	206 1054 019	Fuse 20A TLC		1

Ref. No.	Part No.	Part Name	Remarks	Q'ty
	205 0190 036	3P NH Conn. Base	CN003,109, 110	3
	205 0154 027	2P NH Conn. Base	CN007,008	2
	205 0154 030	3P NH Conn. Base	CN001,003, 017	3
	205 0277 030	3P NH Conn. Base (RED)	CN107	1
	205 0276 031	3P EH Conn. Base (BLU)	CN108	1
	205 0296 037	3P EH Conn. Base (YEL)	CN111	1
	205 0234 031	3P EH Side Conn. Base	CN005	1
	205 0587 034	3P EH Side Conn. Base (BLK)	CN016	1
	205 0588 033	3P EH Side Conn. Base (RED)	CN006	1
	205 0280 030	3P EH Side Conn. Base (BLU)	CN105,015	2
	205 0234 044	4P EH Side Conn. Base	CN009	1
	205 0588 046	4P EH Side Conn. Base (RED)	CN010	1
	203 0226 014	1P Contact Ass'y		2

KU-9193E CONTROL UNIT (for U.S.A.)

[Same as KU-9193D (for Asia) except the followings]

Ref. No.	Part No.	Part Name	Remarks	Q'ty
Capacitors (Ceramic)				
C001	253 8014 003	CK45F2GAC103M	0.01μF/400V AC CHANGE	1
OTHER PARTS GROUP				
F001	206 1051 038	FUSE 20A	CHANGE	1

PRINTED WIRING BOARD PATTERNS

KU-9191 POWER AMP UNIT

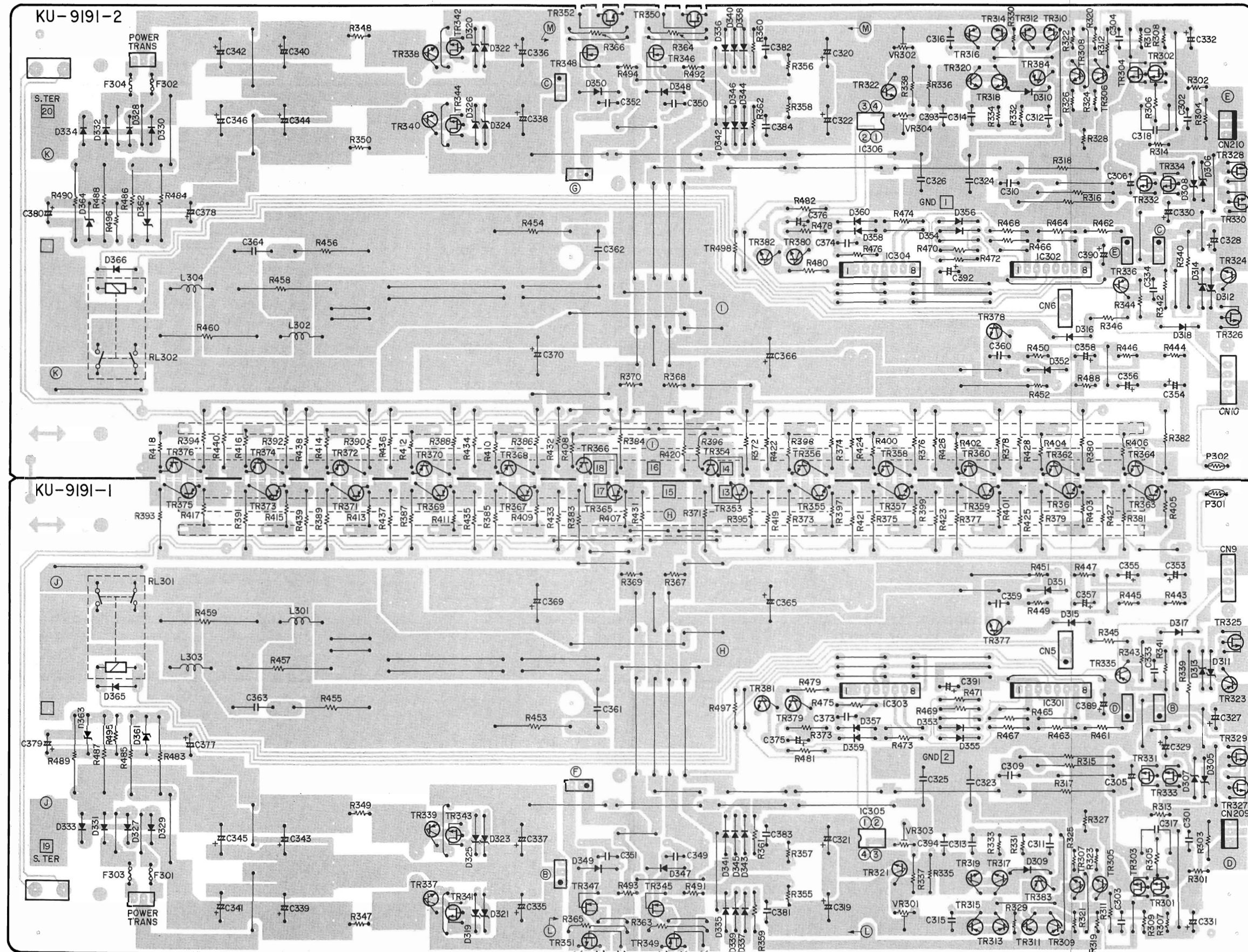

KU-9192 INPUT UNIT

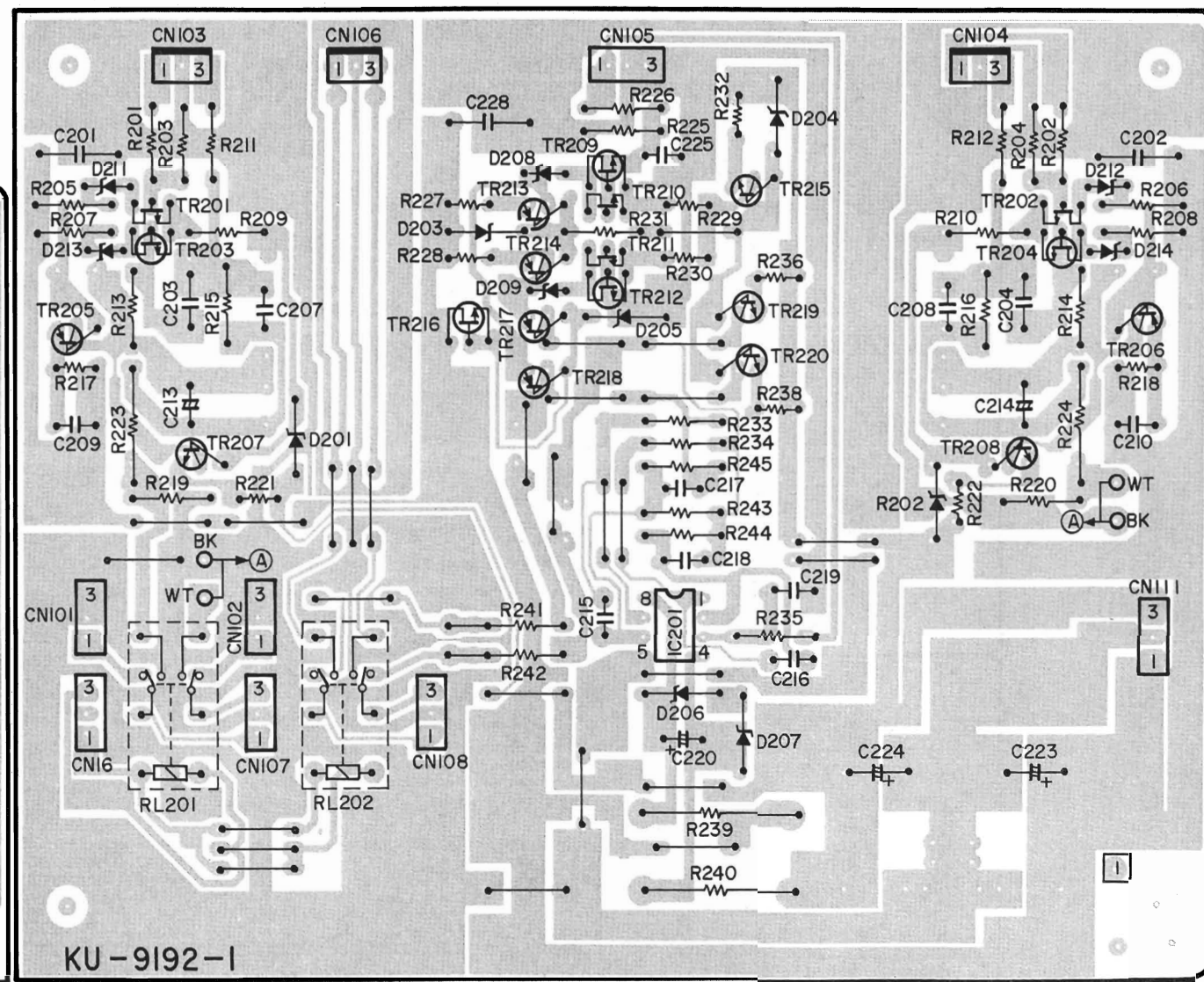
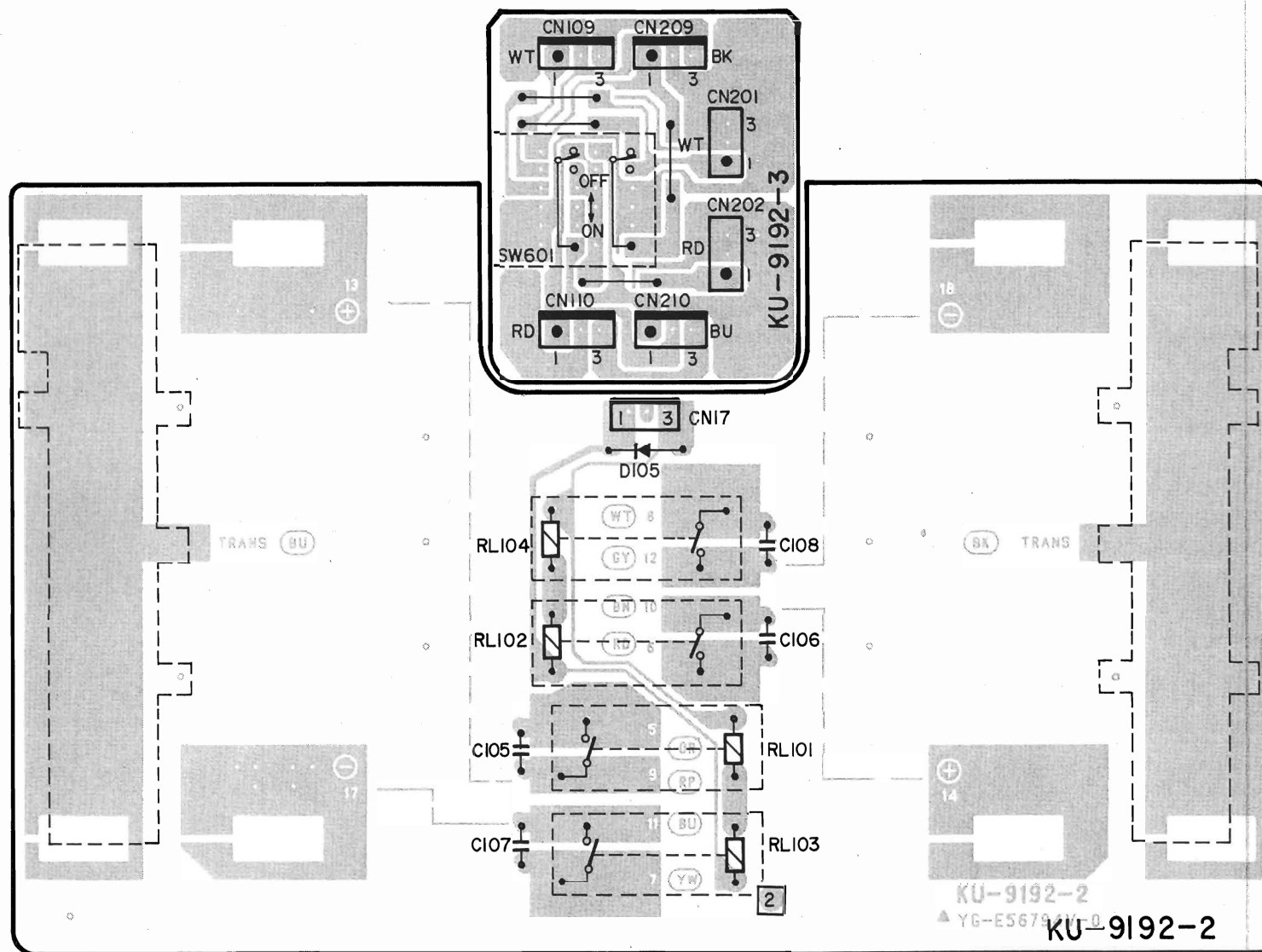

KU-9193 CONTROL UNIT

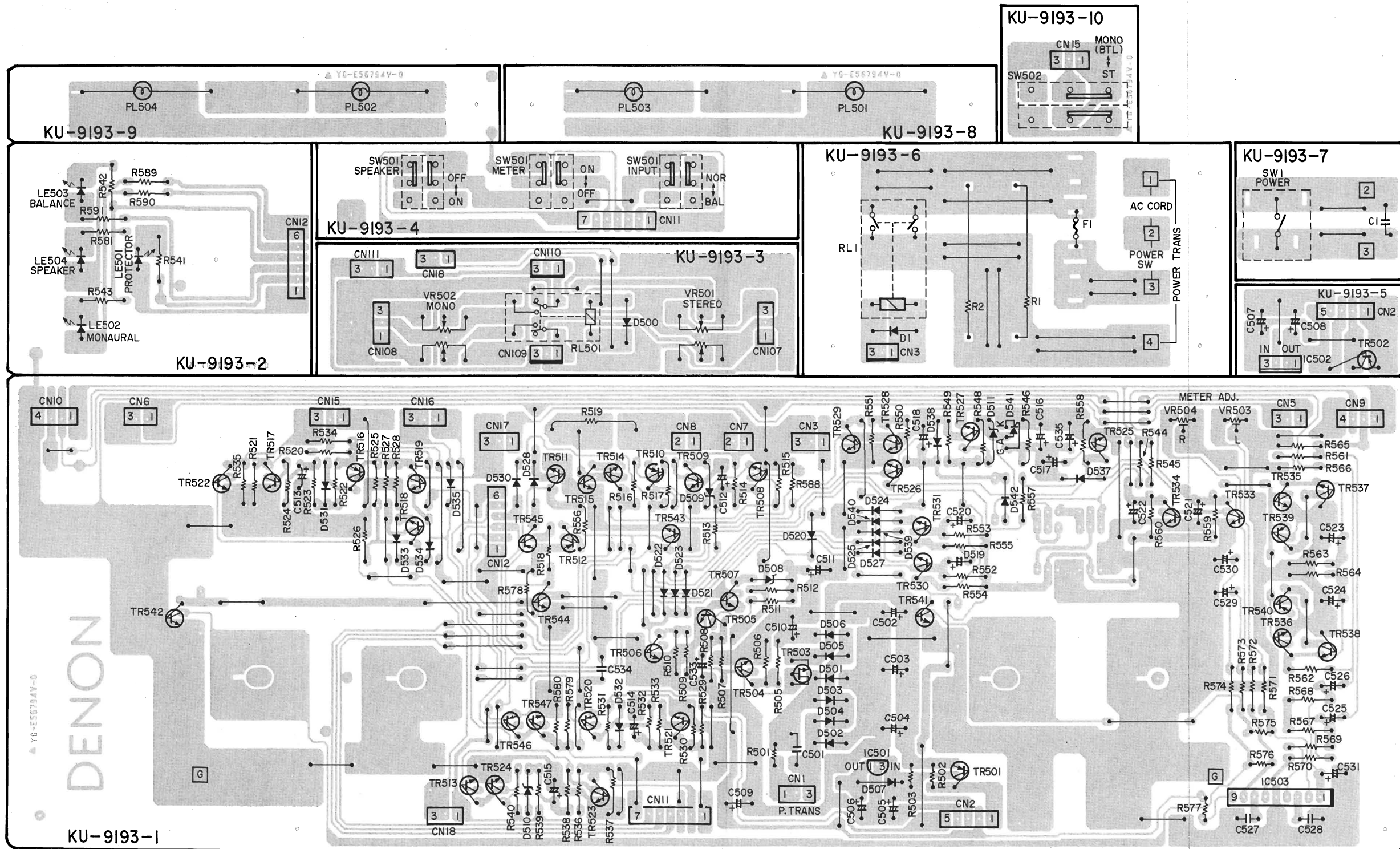

PARTS LIST OF EXPLODED VIEW (for POA-3000RG Asia)

Ref. No.	Part No.	Part Name	Remarks	Q'ty	Ref. No.	Part No.	Part Name	Remarks	Q'ty
1	101 9078 006	Side Board (L)	Wood T19	1	67	417 9052 008	CU Plate (F)		1
2	101 9077 007	Side Board (R)	Wood T19	1	68	461 0114 023	Cushion	T8x20x20	4
3	146 9086 004	Screw Cup		8	69	412 9244 002	Earth Plate (VR)		1
4	144 9110 000	Ventilator		2	71	411 9077 001	Side Chassis (R)		1
5	101 9076 008	Top W. Board (B)	Wood T13.5	1	72	411 9078 000	Side Chassis (L)		1
6	101 9075 009	Top W. Board (F)	Wood T13.5	1	73	417 9053 007	Power Radiator		1
7	412 9246 000	Top Support (L)		1	74	412 9243 003	Radi Support (R)		2
8	412 9245 001	Top Support (R)		1	75	412 9242 004	Radi Support (F)		2
9	122 9006 004	Spacer	T0.5x11x420	2	76	412 9062 019	P.W.B. Support Bracket		4
11	461 9026 002	Spacer		4	77	417 9051 009	CU Plate (P)		4
13	GEN 7163	F. Panel Sub Ass'y		1	78	415 0234 007	Insulating Sheet		28
14	113 9237 002	P. Knob (P) Ass'y		1	79	275 0071 002	2SJ115	FET	2
15	113 1179 113	Push Knob		3	80	275 0070 003	2SK405	TR349, 350	2
16	112 9072 109	Knob Ass'y		2	81	273 0355 007	2SC3858LB O/P/Y	FET	2
17	144 9120 003	Blind Plate (R)		1	82	271 0221 009	2SA1492LB O/P/Y	TR351,352	12
18	144 9121 002	Blind Plate (L)		1	83	411 9075 100	Front Frame	TR353-364	12
19	GEN 7161	Inside P. Sub Ass'y		1	85	See add. list	Back Frame	TR365-376	1
20	144 9117 003	Inside ESC Bar		1	86	205 0586 019	1P Terminal (BK)		1
21	415 9051 003	Blind Sheet		1	87	205 0586 006	1P Terminal (RD)		2
22	144 9116 004	F.P ESC Bar		2	88	205 0438 031	1P Terminal (BK)		2
23	122 0039 012	Spacer		2	89	205 0438 028	1P Terminal (RD)		2
24	144 1163 026	Side Plate (L)		1	90	See add. list	Cord Bush		1
25	412 9261 001	Bracket (L)		1	91	See add. list	AC Cord with Plug		1
26	144 1162 030	Side Plate (R)		1	92	411 9074 101	Trans Chassis		1
27	412 9260 002	Bracket (R)		1	93	254 6157 004	CE68W==223M	C109-112	4
28	483 9045 005	Spring Plate		1	94	412 9270 005	Earth Terminal	2200µF/90V	2
29	463 0182 080	Spring		1	95	276 0257 007	15D4B41	D101-104	4
30	113 9236 003	Door Knob		1	96	See add. list	Power Trans	Bridge Diode	1
31	421 0261 004	Mini Damper		1	97				1
32	425 0140 101	Bearing		2	98	414 9088 002	Damp Plate		4
33	401 0140 202	Hinge (L)		1	99	461 0420 005	Rubber Ring		4
34	401 0139 103	Hinge (R)		1	100	393 0043 008	Pilot Lamp	PL501-504	4
35	144 9118 002	Door		1	101	125 9004 018	UL Tube		1
36	See add. list	Back Panel		1	102	462 0036 007	Terminal Cap (BLK)		2
37	204 9801 006	1P Pin Jack		3	103	462 0036 010	Terminal Cap (RED)		2
38	205 0416 008	3P Cannon Connector		3	104	414 9078 009	Dust CAP-SDC		3
40	112 9083 004	Knob Ass'y	Direct SW	1	105	See add. list	Control Unit		1
41	412 9267 005	Earth Plate		1	106	See add. list	Input Unit		1
42	414 9081 009	Shield Cover (IN)		1	107	See add. list	Power Amp Unit		1
43	412 9241 005	P.S. Bracket		1	108	214 0115 002	Relay	RL001	1
44	415 9032 006	P.C.B. Holder (T)		4	109	212 2612 002	3P Push Switch	AC Relay	1
45	412 9240 006	P.W.B. Bracket (Input)		1	110	212 2611 003	Slide Switch (SDKG)	SW501 Input/	1
46	443 9015 002	P.W.B. Spacer		2	111	212 2609 002	Power Switch (SDDF)	Speaker	1
47	412 2741 007	P.W.B. Holder (H=8)		4	112	See add. list	Fuse 20A TLC	SW502	1
48	414 9080 000	Shield Cover (SP)		1	113	211 9094 002	V1820V20SA503	Mono/ST	1
49	104 0034 008	Stopper		2	114	278 0289 004	PTH487A018D222TS	SW001	1
50	414 9079 008	Shield Cover (M)		1	115	272 0111 002	2SB1156 (P/Q)	Power	1
51	445 0048 003	Cord Holder (L76)		4	116	263 0571 004	NJM78M12FA	F-001	1
52	See add. list	Cord Holder (L50)		3	117	445 8004 007	Wire Clamper	VR501,502	2
53	125 9010 028	Vinyl Tube		1	118			Input Vol. 50kΩ	2
54	104 9028 002	Foot Ass'y		5	119	122 9006 075	Spacer	P301,302	2
56	105 9156 001	Bottom Cover		1				Posistor	1
57	415 9021 017	Spacer	T0.5x120x50	2				TR502	1
58	415 9052 015	Spacer	T1.5x19x13	2				IC502	1
59	412 9262 000	F.P. Support		2					25
60	412 9263 009	Side Bracket		2					
61	412 9256 003	Bracket		2					
62	414 0348 107	Reflector		2					
63	414 0342 103	Reflector		2					
64	411 9073 005	Front Chassis		1				T0.8x5x72	2
65	143 9113 004	Filter		2				(Black)	
66	215 9001 000	Meter Ass'y		2					

ADDENDUM LIST

Ref. No.	Part No.	Part Name	Remarks	Q'ty
SCREWS & NUTS				
201	477 0064 107	Fixing Screw		
202	473 7500 044	Tapping Screw (P) (BLACK) 3x8		6
203	473 7007 000	Tapping Screw (S) (BLACK) 4x8		12
204	473 7501 014	Tapping Screw (P) 3x14		2
205	473 7007 026	Tapping Screw (S) (BLACK) 4x16		9
206	See add. list	Tapping Screw (S) (BLACK) 3x8		55
207	473 8007 025	3x8 Cup Screw		24
208	473 8007 038	3x14 Cup Screw		28
209	475 3202 009	4 TWB		4
210	473 8007 009	3x12 Cup Screw		6
211	475 2006 002	6 SW		4
212	475 6012 005	6N		4
213	473 7012 008	Tapping Screw (S) 3x10		6
214	471 1301 010	3x4 CPS		18
216	471 2302 050	3x5 CFS-N		4
218	471 3102 013	2x5 CBS-Z		2
217	473 7003 017	Tapping Screw (S) (BLACK) 3x8		3
218	473 0305 013	Tapping Screw (I) 3x10		8
219	473 7007 042	Tapping Screw (S) (BLACK) 4x25		8
220	475 3800 003	9 TWA		2
221	475 2005 003	5 SW		4
222	See add. list	Nut-W 3N		8
PACKING & ACCESSORIES (not Included Exploded View)				
⊙ 301	513 9177 003	Notice Sheet		1
⊙ 302	504 0063 060	Styrene Paper	T0.5x460x60	1
⊙ 303	504 9102 032	Styrene Paper	T0.5x350 x250	1
⊙ 304	504 0055 036	Cabinet Sheet	T0.5x1200 x1200	1
305	503 9209 000	Cushion Ass'y (UX)		1
306	503 9205 004	Cushion (F)		1
307	503 9210 002	Cushion Ass'y (TX)		1
308	501 9179 053	Carton Case		1
309	505 8023 076	Envelope		1
310	511 9285 009	Inst. Manual		1

Ref. No.	Part Name	Part No.	
		Asia	U.S.A.
⚠	Voltage Sel. Switch	212 3634 005	—
⊙ 36	Back Panel	105 9165 005	105 9169 001
	Fuse Holder	202 0013 101	—
	Fuse Label	513 0815 021	—
⚠	Fuse 10.0A	206 1035 096	—
⊙ 52	Cord Holder (L50)	445 0048 016(3)	445 0048 016(2)
⊙ 85	Back Frame	411 9088 003	411 9090 004
⚠ 90	Cord Bush	445 0071 009	445 0045 006
⚠ 91	AC Cord with Plug	206 2083 005	206 2035 008
⚠ 96	Power Trans.	233 9614 000	233 9619 005
⊙ 105	Control Unit	KU-9193D	KU-9193E
⊙ 106	Input Unit	KU-9192D	KU-9192E
⊙ 107	Power Amp Unit	KU-9191D	KU-9191E
112	Fuse 20A TLC (F-001)	206 1054 019	—
	Fuse 20A	—	206 1051 038
206	3x8 CBTS(S)-B	473 7002 021(55)	473 7002 021(51)
222	NUT-W	SC-10822(8)	SC-10822(7)
	Preset Label	515 8030 008	—
	Dangerous Mark	—	513 8266 009
	DAI Warranty Home	—	515 0418 301
	Indication Sheet	—	513 0784 000

EXPLODED VIEW OF CHASSIS AND CABINET

WARNING:

Parts marked with this symbol  have critical characteristics. Use ONLY replacement parts recommended by the manufacturer.

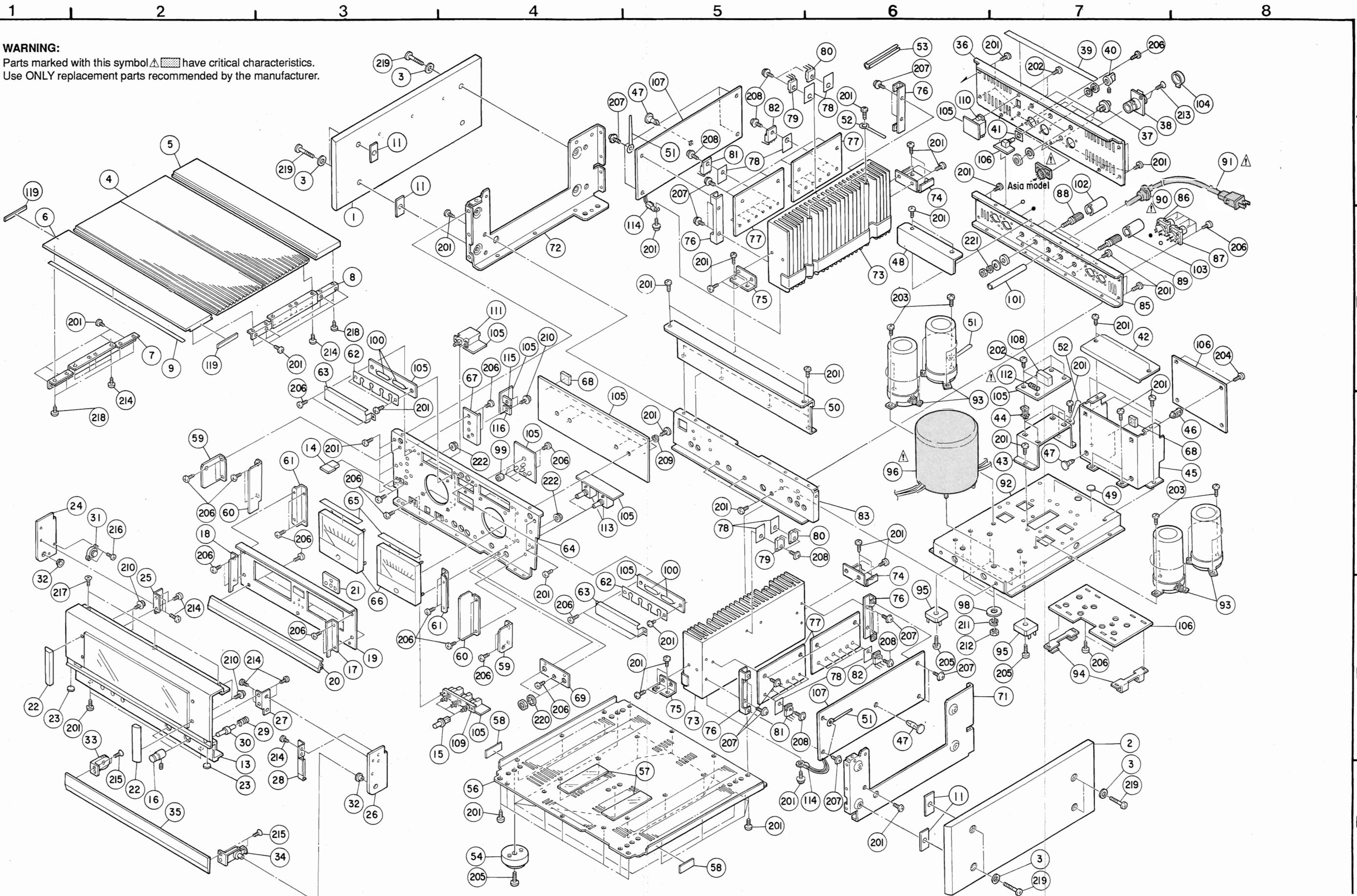

A
B
C
D
E

WIRING DIAGRAM

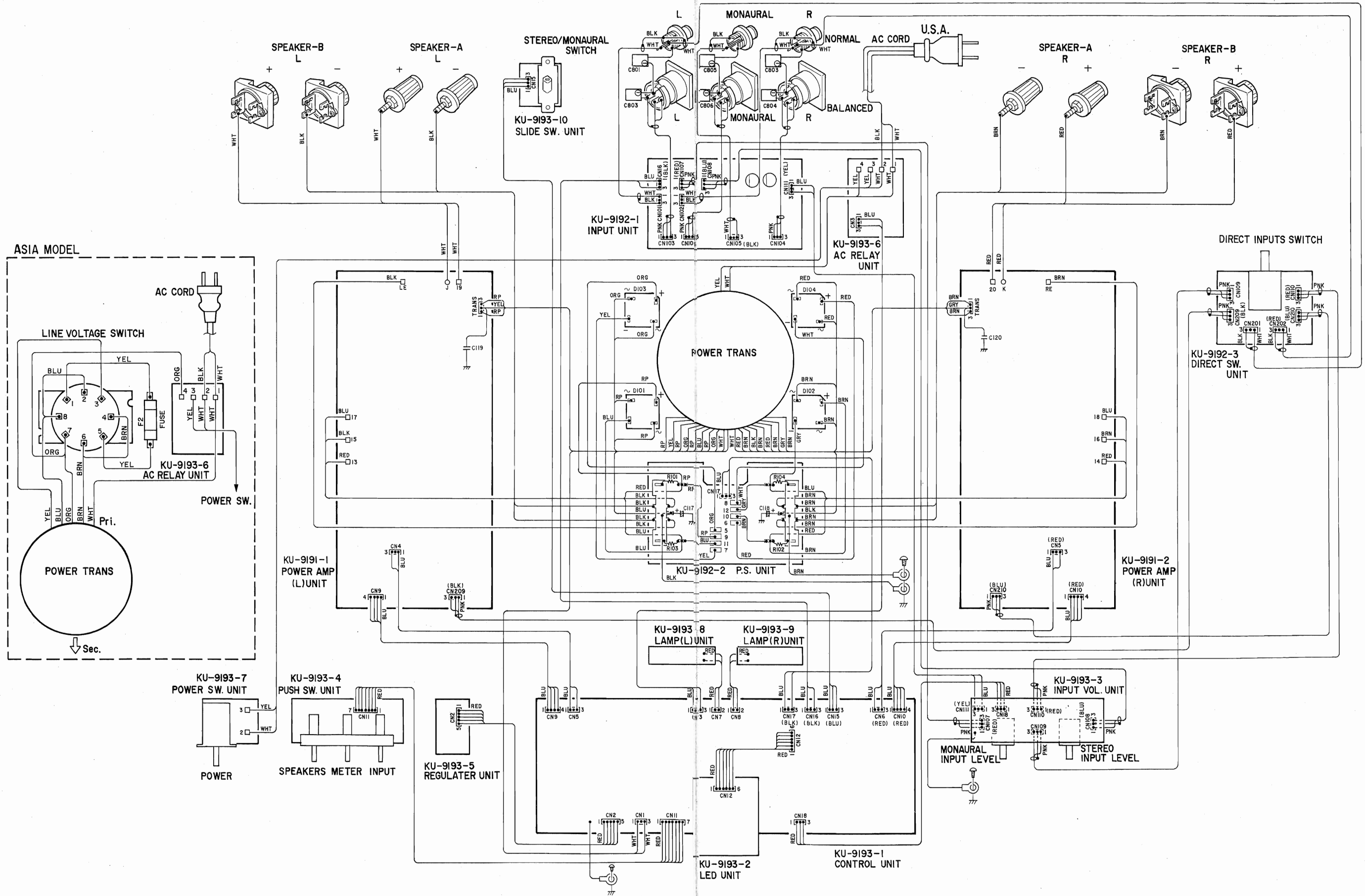

6 7 8 9 10 11

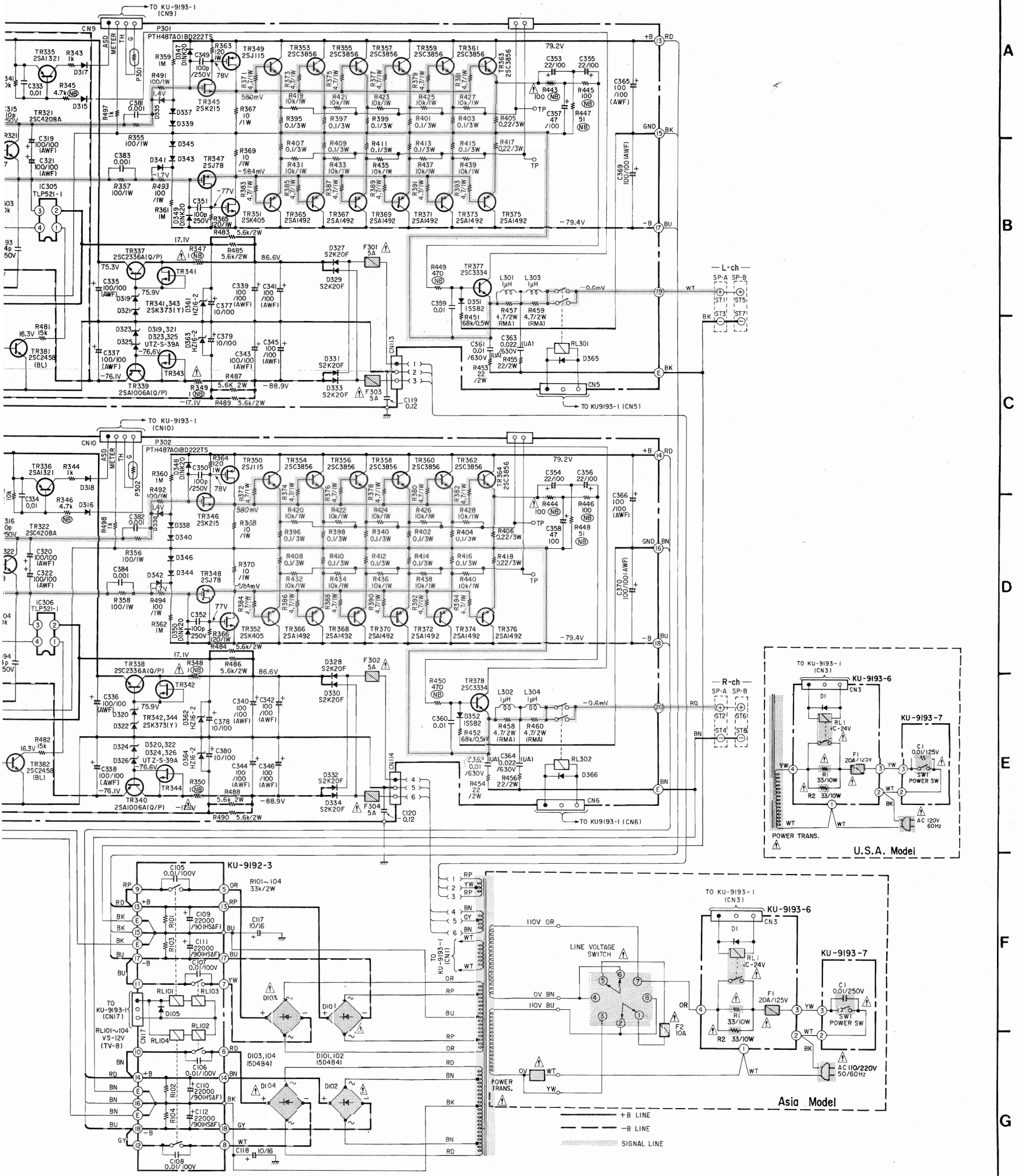

WARNING:
Parts marked with this symbol have critical characteristics.
Use ONLY replacement parts recommended by the manufacturer.

CAUTION:
Before returning the unit to the customer, make sure you make either (1) a leakage current check or (2) a line to chassis resistance check. If the leakage current exceeds 0.5 millamps, or if the resistance from chassis to either side of the power cord is less than 240 kohms, the unit is defective.

WARNING:
DO NOT return the unit to the customer until the problem is located and corrected.

RES IN OHM. k=1,000 OHM, M=1,000,000 OHM
UES IN MICRO FARAD. P=MICRO-MICRO FARAD
RRENT ARE MEASURED AT NO SIGNAL INPUT CONDITION.
RE SUBJECT TO CHANGE WITHOUT PRIOR NOTICE.

A
B
C
D
E
F
G
H

SCHEMATIC DIAGRAM

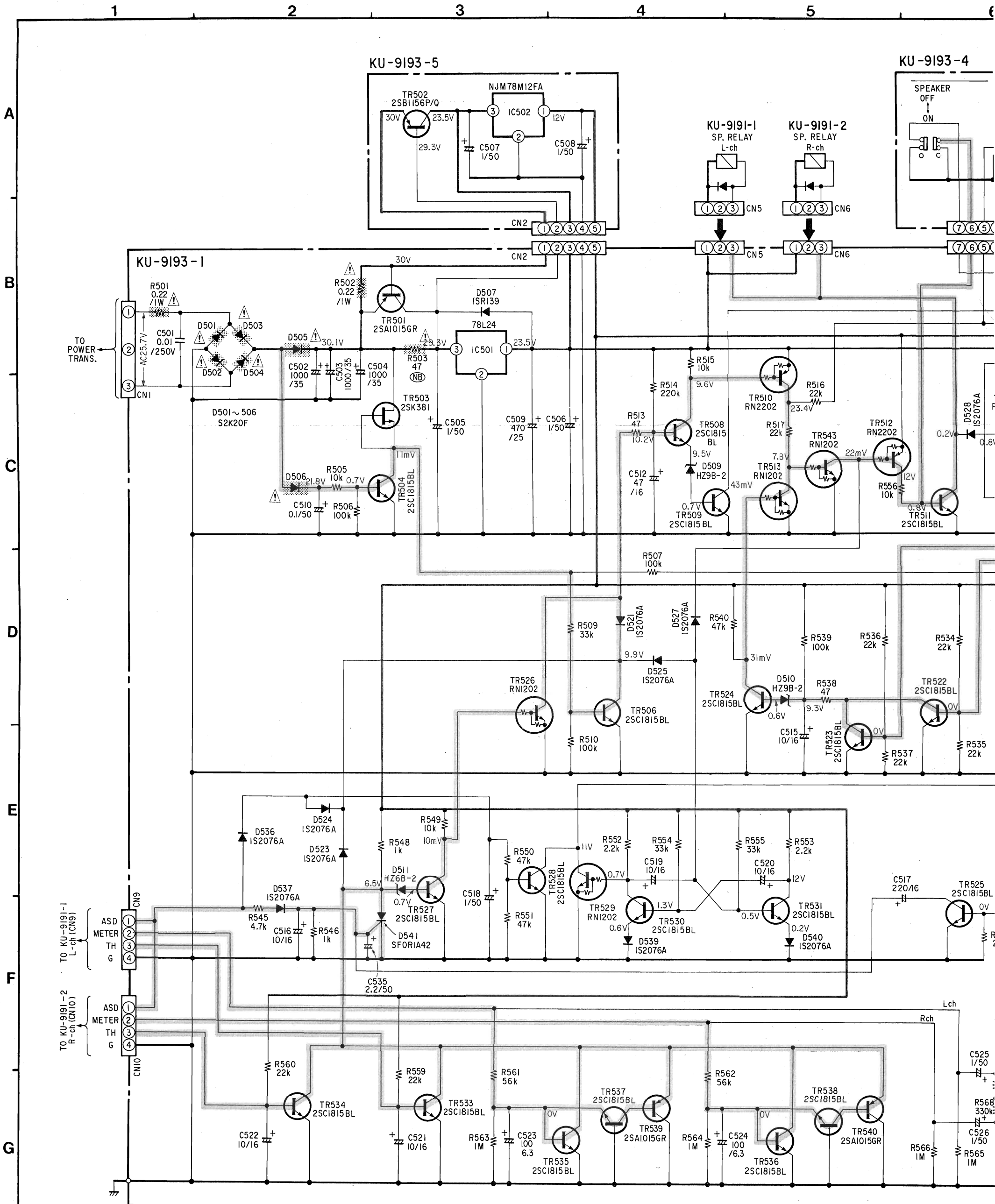

WARNING:
Parts marked with this symbol have critical characteristics.
Use ONLY replacement parts recommended by the manufacturer.

CAUTION:
Before returning the unit to the customer, make sure you make either (1) a leakage current check or (2) a line to chassis resistance check. If the leakage current exceeds 0.5 milliamps, or if the resistance from chassis to either side of the power cord is less than 240 kohms, the unit is defective.

WARNING:
DO NOT return the unit to the customer until the problem is located and corrected.

NOTES
ALL RESISTANCE VALUES IN OHM. k=1,000 OHM, M=1,000,000
ALL CAPACITANCE VALUES IN MICRO FARAD. P=MICRO-MICRO
EACH VOLTAGE AND CURRENT ARE MEASURED AT NO SIGNAL
CIRCUIT AND PARTS ARE SUBJECT TO CHANGE WITHOUT PI

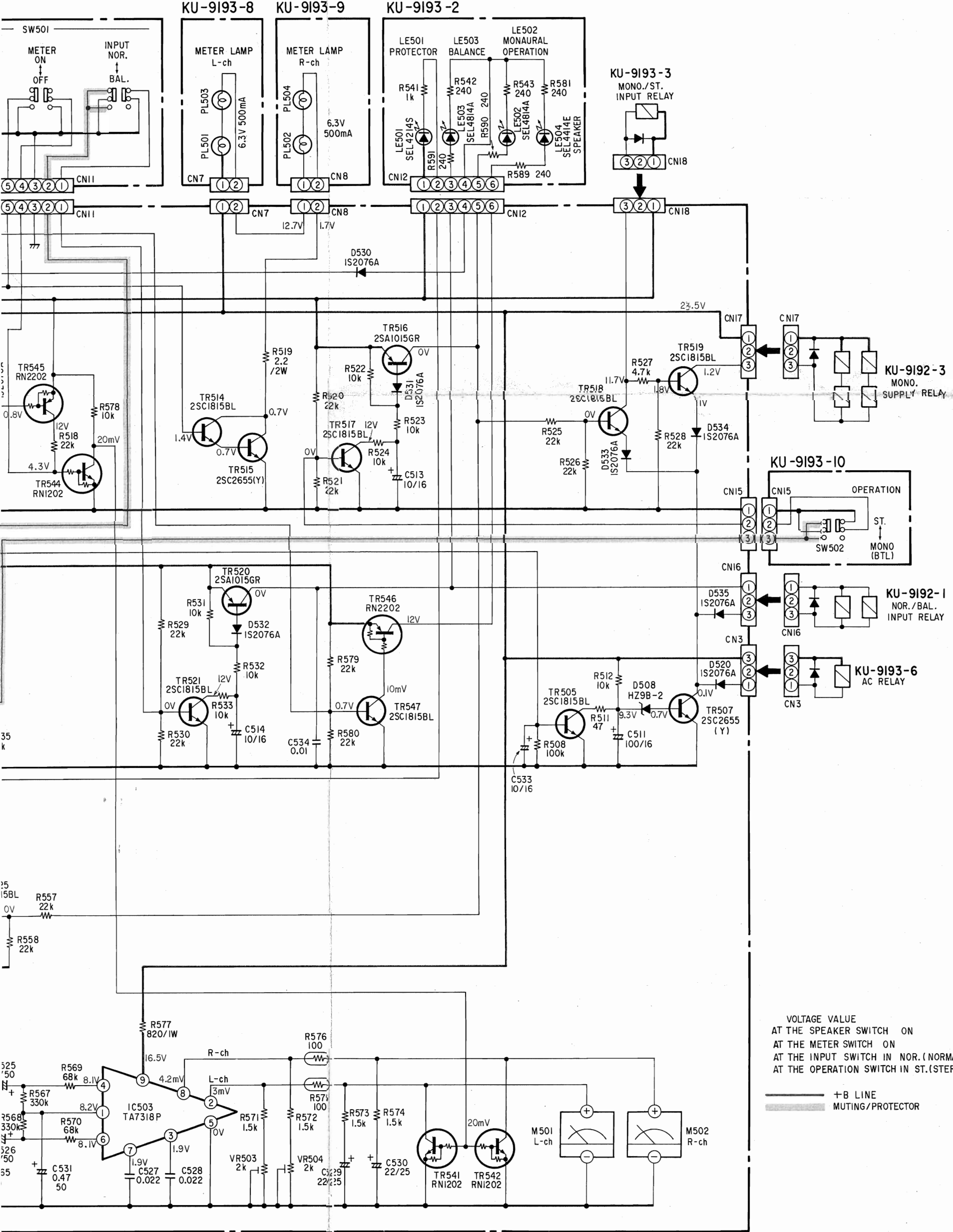

VOLTAGE VALUE
 AT THE SPEAKER SWITCH ON
 AT THE METER SWITCH ON
 AT THE INPUT SWITCH IN NOR.(NORMAL)
 AT THE OPERATION SWITCH IN ST.(STEREO)

— +B LINE
 ▬ MUTING/PROTECTOR

0,000 OHM
 MICRO FARAD
 SIGNAL INPUT CONDITION.
 JT PRIOR NOTICE.