

SERVICE MANUAL

MODEL	JP	E3	E2	EK	E2A	E1C	E1K	EUT
S-52	✓	✓	✓					
S-52 DAB				✓				

WIRELESS NETWORK CD MUSIC SYSTEM

MODEL	JP	E3	E2	EK	E2A	E1C	E2K	EUT
S-32		✓	✓					

WIRELESS NETWORK MUSIC SYSTEM

注意

サービスをおこなう前に、このサービスマニュアルを必ずお読みください。本機は、火災、感電、けがなどに対する安全性を確保するために、さまざまな配慮をおこなっており、また法的には「電気用品安全法」にもとづき、所定の許可を得て製造されております。従ってサービスをおこなう際は、これらの安全性が維持されるよう、このサービスマニュアルに記載されている注意事項を必ずお守りください。

• For purposes of improvement, specifications and design are subject to change without notice.

• 本機の仕様は性能改良のため、予告なく変更することがあります。
• 補修用性能部品の保有期間は、製造打切後8年です。

• Please use this service manual with referring to the operating instructions without fail.

• 修理の際は、必ず取扱説明書を参照の上、作業を行ってください。

• Some illustrations using in this service manual are slightly different from the actual set.

• 本文中に使用しているイラストは、説明の都合上現物と多少異なる場合があります。

DENON

Denon Brand Company, D&M Holdings Inc.

SAFETY PRECAUTIONS

The following check should be performed for the continued protection of the customer and service technician

LEAKAGE CURRENT CHECK

Before returning the unit to the customer, make sure you make either (1) a leakage current check or (2) a line to chassis resistance check. If the leakage current exceeds 0.5 milliamps, or if the resistance from chassis to either side of the power cord is less than 460 kohms, the unit is defective.

LASER RADIATION

Do not stare into beam or view directly with optical instruments, class 3A laser product

CAUTION Please heed the points listed below during servicing and inspection.

◎ Heed the cautions!

Spots requiring particular attention when servicing, such as the cabinet, parts, chassis, etc., have cautions indicated on labels or seals. Be sure to heed these cautions and the cautions indicated in the handling instructions.

◎ Caution concerning electric shock!

- (1) An AC voltage is impressed on this set, so touching internal metal parts when the set is energized could cause electric shock. Take care to avoid electric shock, by for example using an isolating transformer and gloves when servicing while the set is energized, unplugging the power cord when replacing parts, etc.
- (2) There are high voltage parts inside. Handle with extra care when the set is energized.

◎ Caution concerning disassembly and assembly!

Though great care is taken when manufacturing parts from sheet metal, there may in some rare cases be burrs on the edges of parts which could cause injury if fingers are moved across them. Use gloves to protect your hands.

◎ Only use designated parts!

The set's parts have specific safety properties (fire resistance, voltage resistance, etc.). For replacement parts, be sure to use parts which have the same properties. In particular, for the important safety parts that are marked  on wiring diagrams and parts lists, be sure to use the designated parts.

◎ Be sure to mount parts and arrange the wires as they were originally!

For safety reasons, some parts use tape, tubes or other insulating materials, and some parts are mounted away from the surface of printed circuit boards. Care is also taken with the positions of the wires inside and clamps are used to keep wires away from heating and high voltage parts, so be sure to set everything back as it was originally.

◎ Inspect for safety after servicing!



Check that all screws, parts and wires removed or disconnected for servicing have been put back in their original positions, inspect that no parts around the area that has been serviced have been negatively affected, conduct an insulation check on the external metal connectors and between the blades of the power plug, and otherwise check that safety is ensured.

(Insulation check procedure)

Unplug the power cord from the power outlet, disconnect the antenna, plugs, etc., and turn the power switch on. Using a 500V insulation resistance tester, check that the insulation resistance between the terminals of the power plug and the externally exposed metal parts (antenna terminal, headphones terminal, microphone terminal, input terminal, etc.) is 1MΩ or greater. If it is less, the set must be inspected and repaired.

CAUTION Concerning important safety parts

Many of the electric and structural parts used in the set have special safety properties. In most cases these properties are difficult to distinguish by sight, and using replacement parts with higher ratings (rated power and withstand voltage) does not necessarily guarantee that safety performance will be preserved. Parts with safety properties are indicated as shown below on the wiring diagrams and parts lists in this service manual. Be sure to replace them with parts with the designated part number.

- (1) Schematic diagrams Indicated by the  mark
- (2) Parts lists Indicated by the  mark

Using parts other than the designated parts could result in electric shock, fires or other dangerous situations.

注意 サービス、点検時にはつぎのことにご注意ください。

◎ 注意事項をお守りください！

サービスのとき特に注意を要する箇所についてはキャビネット、部品、シャーシなどにラベルや捺印で注意事項を表示しています。これらの注意書きおよび取扱説明書などの注意事項を必ずお守りください。

◎ 感電に注意！

- (1) このセットは、交流電圧が印加されていますので通電時に内部金属部に触れると感電することがあります。従って通電サービス時には、絶縁トランスの使用や手袋の着用、部品交換には、電源プラグを抜くなどで感電にご注意ください。
- (2) 内部には高電圧の部分がありますので、通電時の取扱には十分ご注意ください。

◎ 分解、組み立て作業時のご注意！

板金部品の端面の『バリ』は、部品製造時に充分管理をしておりますが、板金端面は鋭利となっている箇所がありますので、部品端面に触れたまま指を動かすとまれに怪我をする場合がありますので十分注意して作業して下さい。手の保護のために手袋を着用してください。

◎ 指定部品の使用！

セットの部品は難燃性や耐電圧など安全上の特性を持ったものとなっております。従って交換部品は、使用されていたものと同じ特性の部品を使用してください。特に配線図、部品表に  印で指定されている安全上重要な部品は必ず指定のものをご使用ください。

◎ 部品の取付けや配線の引きまわしは、元どりに！

安全上、テープやチューブなどの絶縁材料を使用したり、プリント基板から浮かして取付けた部品があります。また内部配線は引きまわしやクランパーによって発熱部品や高圧部品に接近しないように配慮されていますので、これらは必ず元どりにしてください。

◎ サービス後は安全点検を！



サービスのために取り外したねじ、部品、配線などが元どりになっているか、またサービスした箇所の周辺を劣化させてしまったところがないかなどを点検し、外部金属端子部と、電源プラグの刃の間の絶縁チェックをおこなうなど、安全性が確保されていることを確認してください。

(絶縁チェックの方法)

電源コンセントから電源プラグを抜き、アンテナやプラグなどを外し、電源スイッチを入れます。500V 絶縁抵抗計を用いて、電源プラグのそれぞれの端子と外部露出金属部〔アンテナ端子、ヘッドホン端子マイク端子、入力端子など〕との間で、絶縁抵抗値が 1 MΩ 以上であること、この値以下のときはセットの点検修理が必要ですよ。

注意 安全上重要な部品について

本機に使用している多くの電気部品、および機構部品は安全上、特別な特性を持っています。この特性はほとんどの場合、外観では判別つきにくく、またもの部品のより高い定格（定格電圧、耐圧）を持ったものを使用しても安全性が維持されることは、限りません。安全上の特性を持った部品は、このサービスマニュアルの配線図、部品表に基づきのように表示していますので必ず指定されている部品番号のものを使用願います。

- (1) 配線図…  マークで表示しています。
- (2) 部品表…  マークで表示しています。
指定された部品と異なるものを使用した場合には、感電、火災などの危険を生じる恐れがあります。

DIMENSION

S-52/S-32

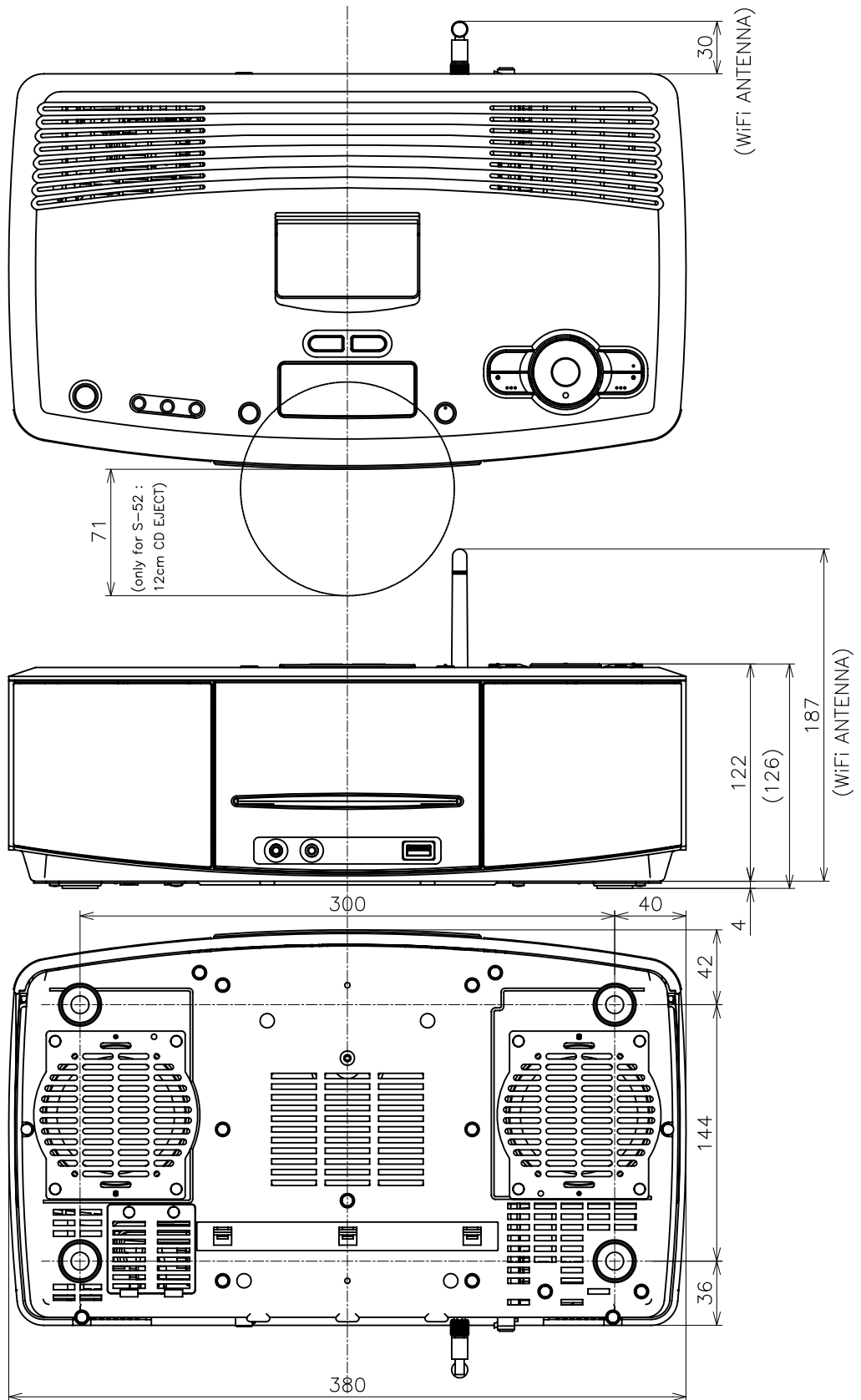

WIRE ARRANGEMENT

If wire bundles are untied or moved to perform adjustment or parts replacement etc., be sure to rearrange them neatly as they were originally bundled or placed afterward. Otherwise, incorrect arrangement can be a cause of noise generation.

1. MAIN UNIT

- ① a, Fasten the CX111 11P PH-PH CON.CORD and CX051 5P PH-PH CON.CORD to the circuit board with a style pin and clamp band. (S-52E3/E2/JP, S-32E3/E2)
- ① b, Fasten the CX111 11P PH-PH CON.CORD and CX051 5P PH-PH CON.CORD, CX081 8P PH-PH SHIELD CORD to the circuit board with a style pin and clamp band. (S-52DABEK)
- ② Fasten the 9P PH-PN SHIELD CORD to the circuit board with a style pin, and arrange the wire along the SIDE BRACKET.

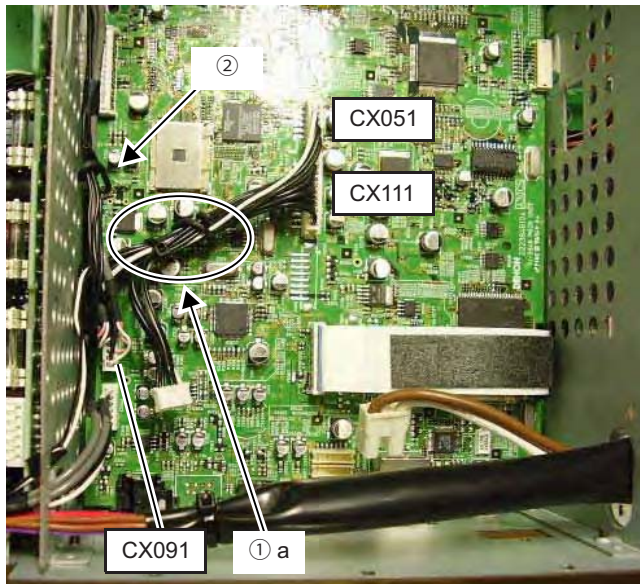

S-52E3/E2/JP, S-32E3/E2

ワイヤー整形図

調整や部品の交換等により、ワイヤー類の結束をはずしたり移動させた場合には、それらの作業が完了した時点でワイヤーの整形をおこなってください。正しく整形されてないとノイズ発生の原因となることがあります。

1. MAIN UNIT 部

- ① a, CX111 11P PH-PH CON.CORD と CX051 5P PH-PH CON.CORD をスタイルピンとクランプバンドで基板に固定する。(S-52E3/E2/JP, S-32E3/E2)
- ① b, CX111 11P PH-PH CON.CORD と CX051 5P PH-PH CON.CORD と CX081 8P PH-PH SHIELD CORD をスタイルピンとクランプバンドで基板に固定する。(S-52DABEK)
- ② CX091 9P PH-PN SHIELD CORD をスタイルピンで固定し、サイドブラケットに沿わせるようにワイヤーを整形する。

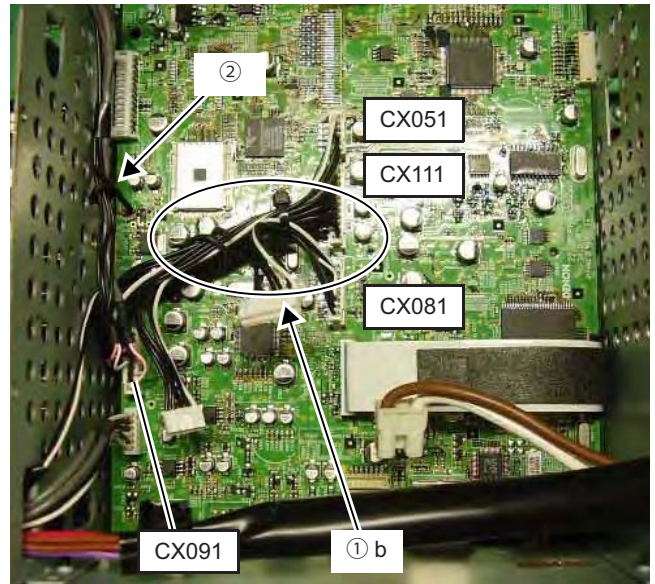

S-52DABEK

- ③ Fasten the CY064 6P ZH-ZH CON.CORD to the circuit board with a style pin.

- ③ CY064 6P ZH-ZH CON.CORD をスタイルピンで固定する。

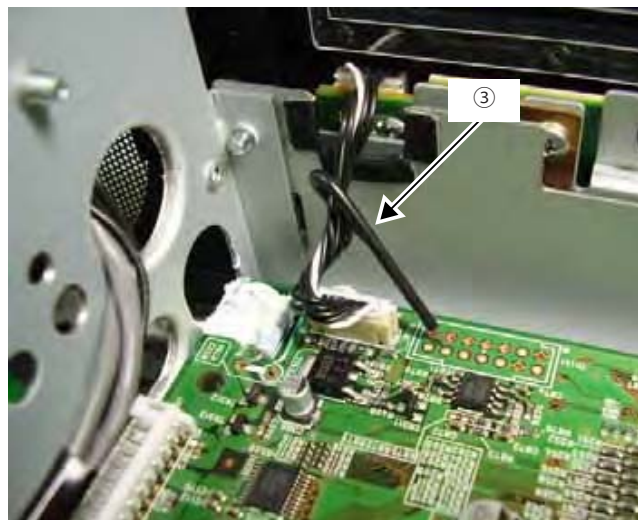

2. SIDE BRACKET(R)

- ④ Fasten the CY091 9P PH- PH SHIELD CORD on the H/P PORTBLE IN UNIT to the SIDE BRACKET (R) with a cord holder.

2. SIDE BRACKET(R) 部

- ④ H/P PORTBLE IN UNIT の CY091 9P PH- PH SHIELD CORD をコードホルダーで SIDE BRACKET (R) に固定する。

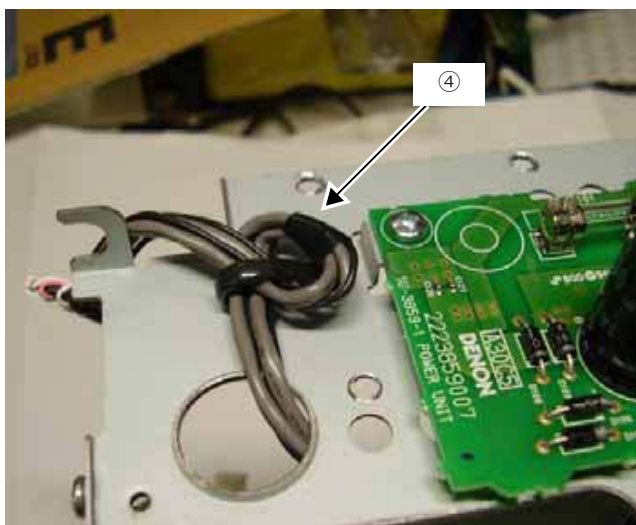

3. SIDE BRACKET(L)

- ⑤ Fasten the CY051 5P PH- PH CON. CORD on the USB TERM. UNIT to the SIDE BRACKET (L) with a cord holder.(S-52)
- ⑥ Fasten the CY051 5P PH- PH CON. CORD on the USB-TERM. UNIT to the SIDE BRACKET (L) with a clamp band.(S-52)

3. SIDE BRACKET(L) 部

- ⑤ USB TERM. UNIT の CY051 5P PH- PH CON. CORD をコードホルダーで SIDE BRACKET (L) に固定する。(S-52)
- ⑥ 同 5P PH- PH CON. CORD をクランプバンドで SIDE BRACKET (L) に固定する。(S-52)

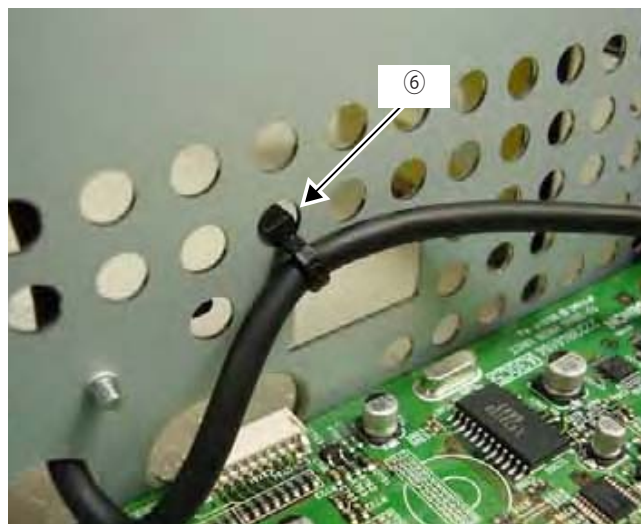
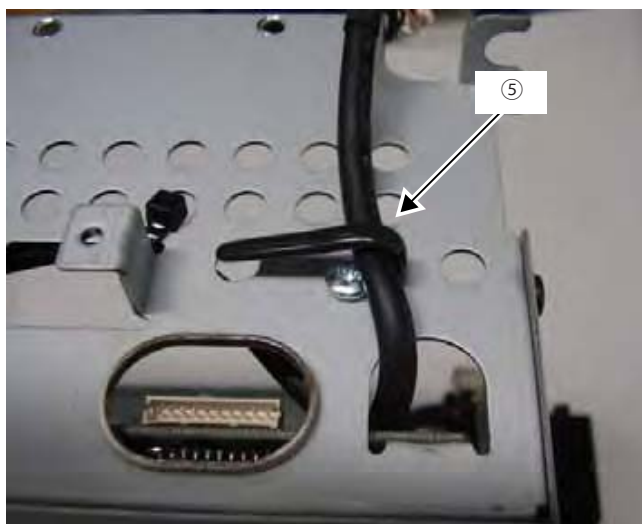

4. FERRITE CLAMP102010N

- ⑦ Coil and lock the primary side code of the power transformer with FERRITE CLAMP opened, then paste the EMIFILTER CUSHION to outer.
- ⑧ Fasten the FERRITE CLAMP to the EMIFILTER CUSHION with a clamp band .

4. FERRITE CLAMP102010N 部

- ⑦ FERRITE CLAMP を開いた状態でパワートランスの一次側コードを一回巻き付けてロックし、EMIFILTER CUSHION を外周に貼る。
- ⑧ FERRITE CLAMP を TRANS SHIELD にクランプバンドで固定する。

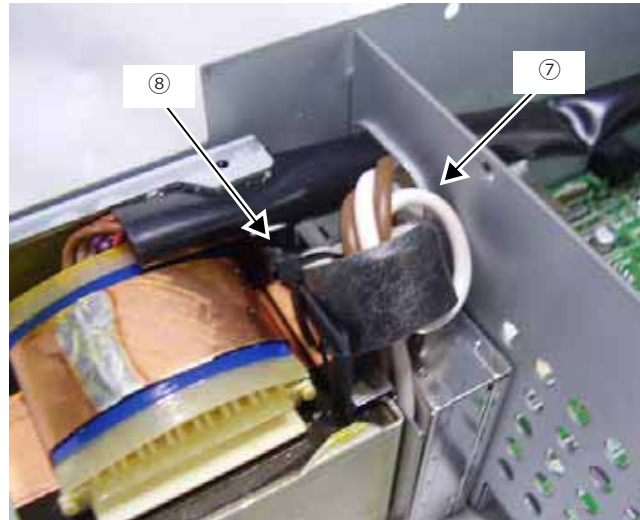

5. POWER UNIT & POWER AMP UNIT

- ⑨ Fasten the CY062 6P PH-PH SHIELD CORD and CX032 3P ZH-SAN CON.CORD and CY061 6P PH-PH CON.CORD and CX021 1P SAN EH CON.CORD and CX063 secondary side code of Power trans with a style pin.
- ⑩ Fasten the CY041 4P PH-PH CON. CORD with a style pin.

5. POWER UNIT & POWER AMP UNIT 部

- ⑨ CY062 6P PH-PH SHIELD CORD と CX032 3P ZH-SAN CON.CORD と CY061 6P PH-PH CON.CORD と CX021 1P SAN EH CON.CORD と CX063 パワートランス 2次側コード をスタイルピンで固定する。
- ⑩ CY041 4P PH-PH CON. CORD をスタイルピンで固定する。

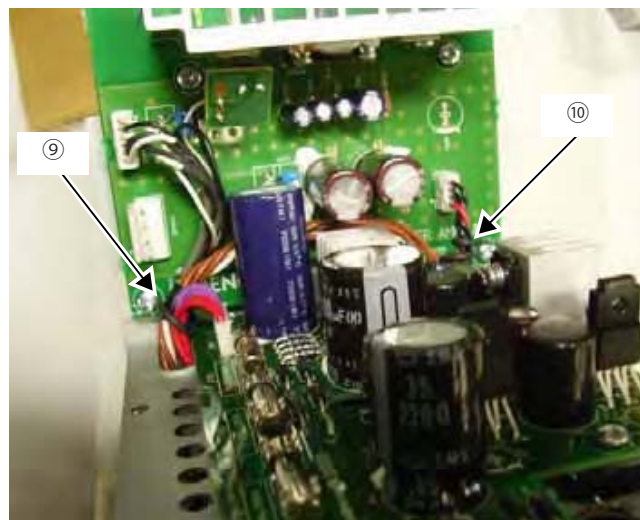

DISASSEMBLY

(Follow the procedure below in reverse order when reassembling.)

1. BOTTOM COVER & SPEAKER BLOCK

- (1) Remove the 2 screws 107 on the bottom side.
- (2) Detach the COVER PLATE in the direction of the arrow.
- (3) Disconnect the 4P VH CON.CORD from the [CY042] on the POWER AMP UNIT.

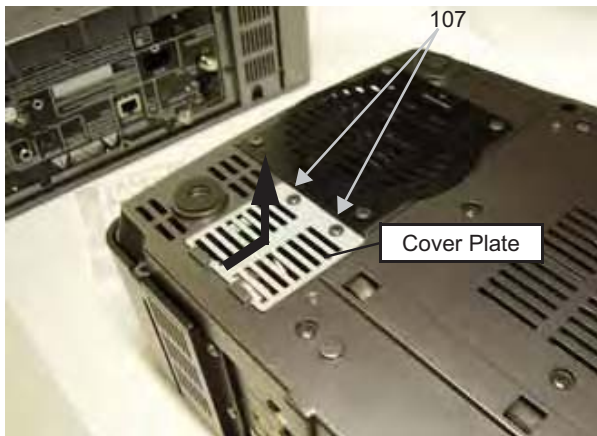

- (4) Remove the 8 screws 106 and 6 screws 111, the 2 screws 108 on the bottom side.
- (5) Detach the BOTTOM COVER & the SPEAKER BLOCK in the direction of the arrow.

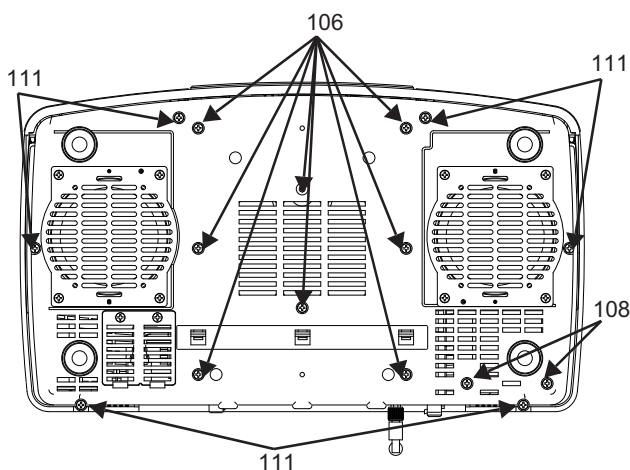

各部のはずしかた

(組み立てるときは、逆の順序でおこなってください。)

1. BOTTOM COVER & SPEAKER BLOCK

- (1) 底面側からの 107 のねじ 2 本をはずす。
- (2) COVER PLATE を矢印方向にずらしてはずす。
- (3) POWER AMP UNIT の [CY042] から 4P VH CON.CORD をはずす。



- (4) 底面側からの 106 のねじ 8 本と 111 のねじ 6 本と 108 のねじ 2 本をはずす。
- (5) BOTTOM COVER & SPEAKER BLOCK を矢印方向にはずす。



2. SPEAKER UNIT

- (1) Remove the 4 screws 109 fixing the SPEAKER BOX. (Both left and right)

2. SPEAKER UNIT

- (1) SPEAKER BOX を固定している、109 のねじ 4 本をはずす。(左右同じ)

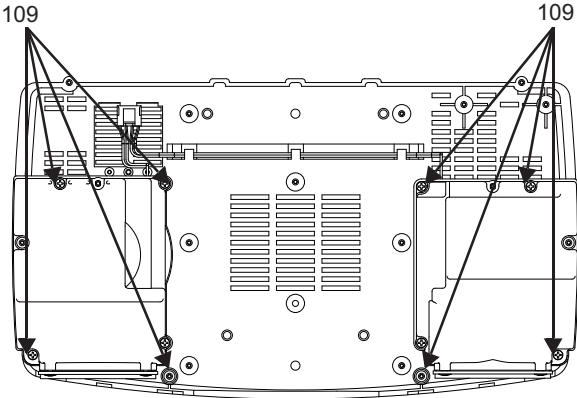

- (2) Remove the wire soldered to the SPEAKER terminal. (Both left and right)
- (3) Remove the 4 screws 112 fixing the speaker, then detach the SPEAKER in the direction of the arrow. (Both left and right)

- (2) SPEAKER 端子に半田付けしてあるワイヤーをはずす。(左右同じ)
- (3) SPEAKER を固定している、112 のねじ 4 本をはずしてから矢印方向にはずす。(左右同じ)

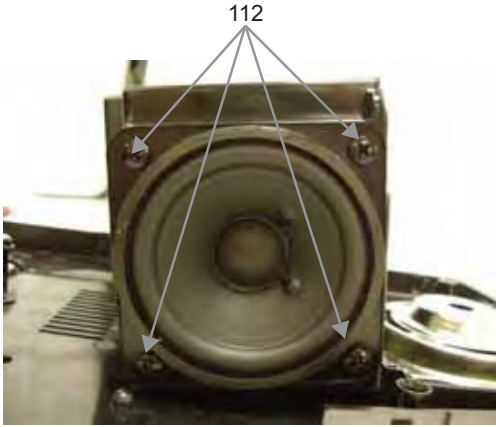

3A.CD MECHA BLOCK(S-52)

(1) Remove the 7 screws 105 and the 1 screw 104.

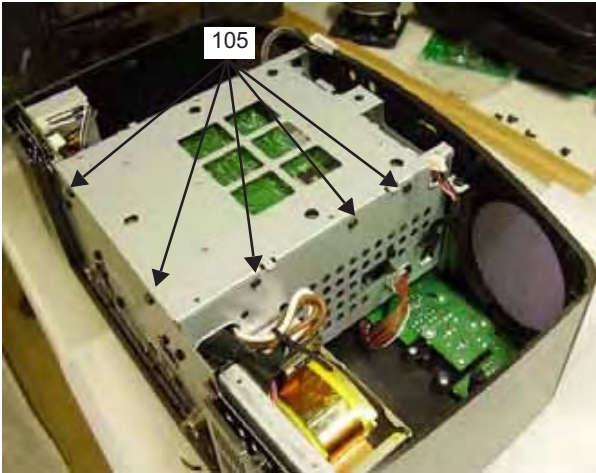

- (2) Remove the 4 screws 104.
- (3) Disconnect the 9P PH-PH SHIELD CORD from the [CY091] on the H/P PORTABLE IN UNIT.
- (4) Disconnect the 5P PH-PH CON.CORD from the [CY051] on the USB TERM. UNIT.

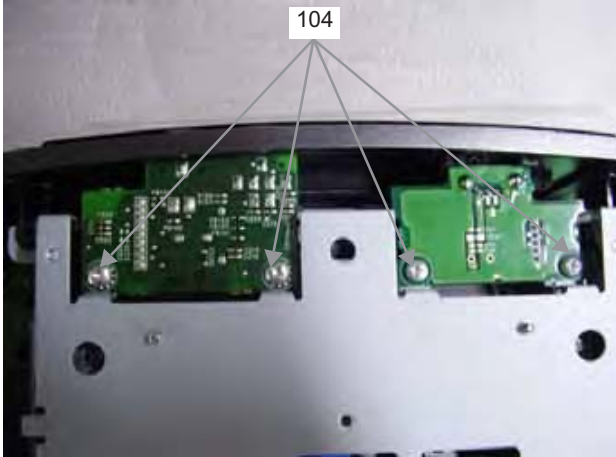

3A.CD MECHA BLOCK(S-52)

(1) 105 のねじ 7 本 と 104 のねじ 1 本 をはずす。

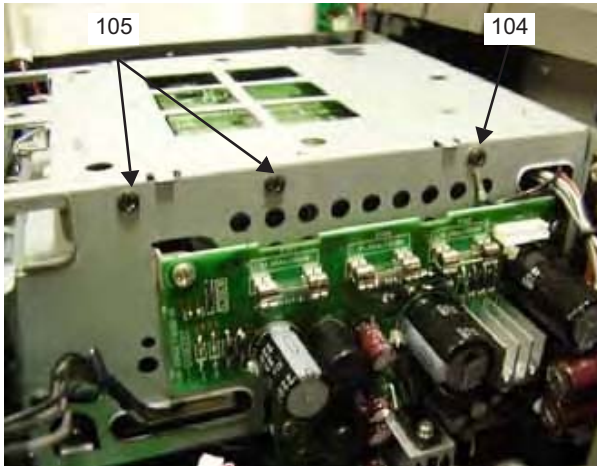

- (2) 104 のねじ 4 本 をはずす。
- (3) H/P PORTABLE IN UNIT の [CY091] から 9P PH-PH SHIELD CORD をはずす。
- (4) USB TERM. UNIT の [CY051] から 5P PH-PH CON. CORD をはずす。

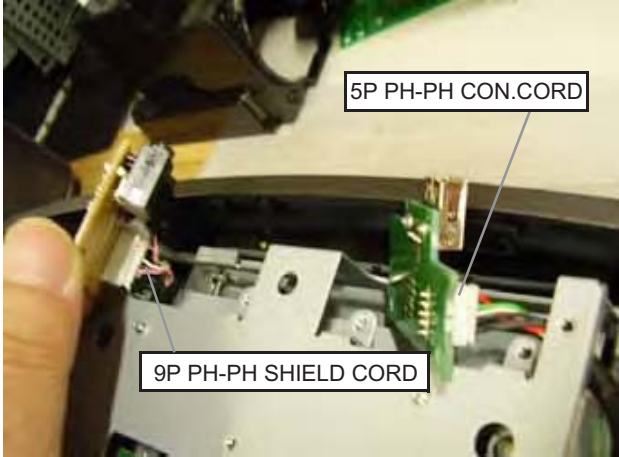

(5) Disconnect the 9P/5P PH-PH CON.CORD in the direction of each the arrow.

(5) 9P/5P PH-PH CON. CORD をそれぞれ矢印方向に引き出す。



(6) Lift up the CD MECHA BLOCK as shown in the photo and disconnect the 30P FFC(1.0) from the the [CX151] on the MAIN UNIT.

(6) CD MECHA BLOCK を図のように持ち上げて MAIN UNIT の [CX151] から、30P FFC(1.0) をはずす

(7) Disconnect the 6P PH-PH CON.CORD from the the [CY061] on CD MECHA UNIT.

(7) CD MECHA UNIT の [CY061] から、6P PH-PH CON.CORD をはずす。

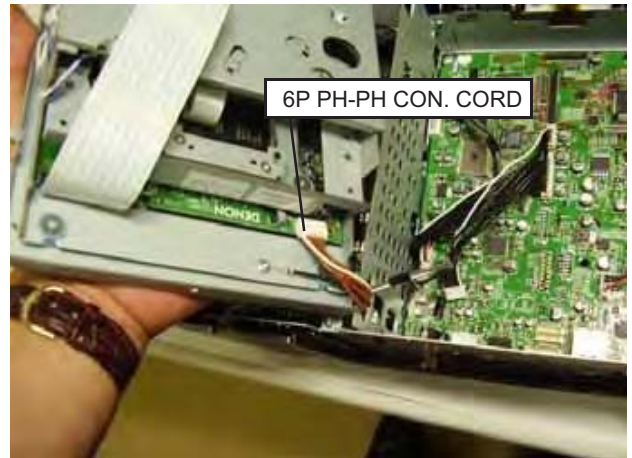

3B.MAIN CHASSIS(S-32)

(1) Remove the 8 screws 105.

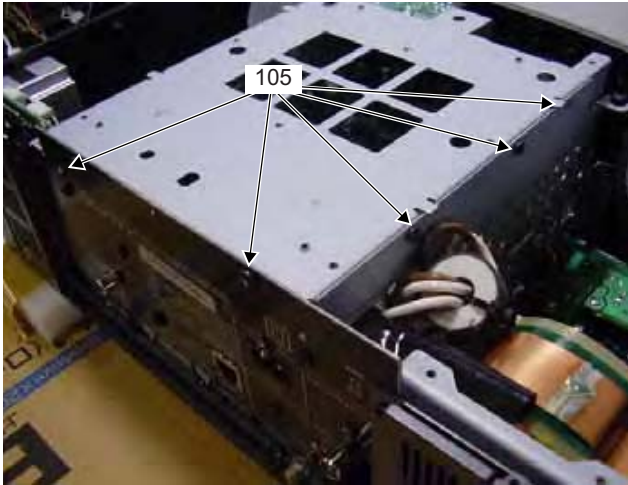

3B.MAIN CHASSIS(S-32)

(1) 105 のねじ 8 本をはずす。

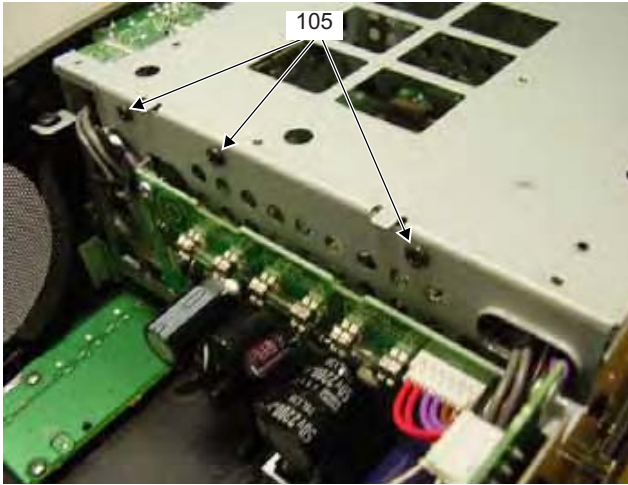

(2) Remove the 2 screws 104.
(3) Disconnect the 9P PH-PH SHIELD CORD from the [CY091] on the H/P PORTABLE IN UNIT.

(2) 104 のねじ 2 本をはずす。
(3) H/P PORTABLE IN UNIT の [CY091] から 9P PH-PH SHIELD CORD をはずす。

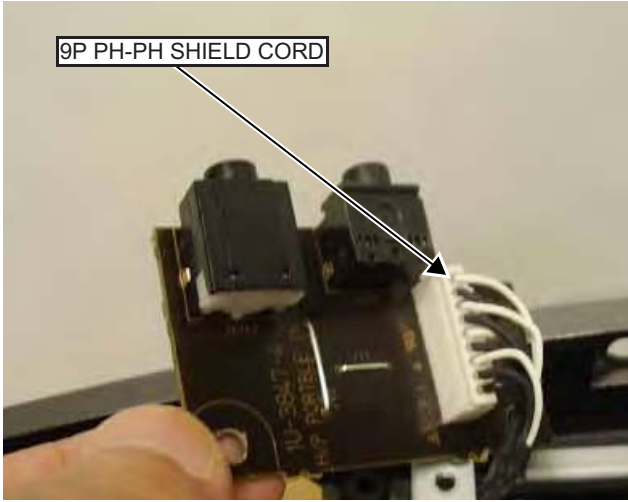
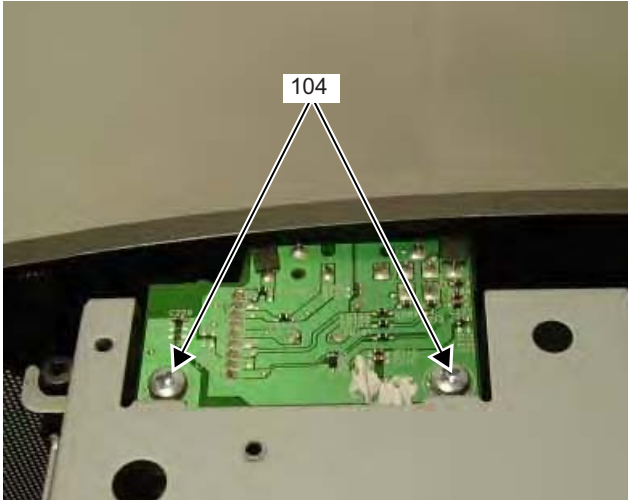

- (4) Disconnect the 9P PH-PH SHIELD CORD in the direction of the arrow A.
- (5) Disconnect the MAIN CHASSIS in the direction of the arrow B.

- (4) 9P PH-PH SHIELD CORD を矢印 A 方向に引き出す。
- (5) MAIN CHASSIS を矢印 B 方向にはずす。

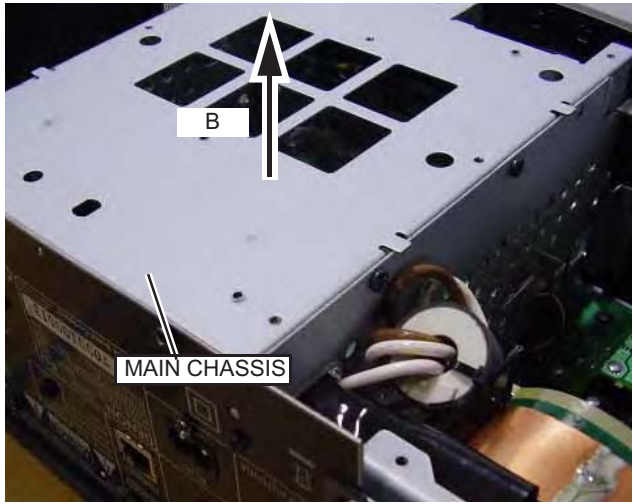
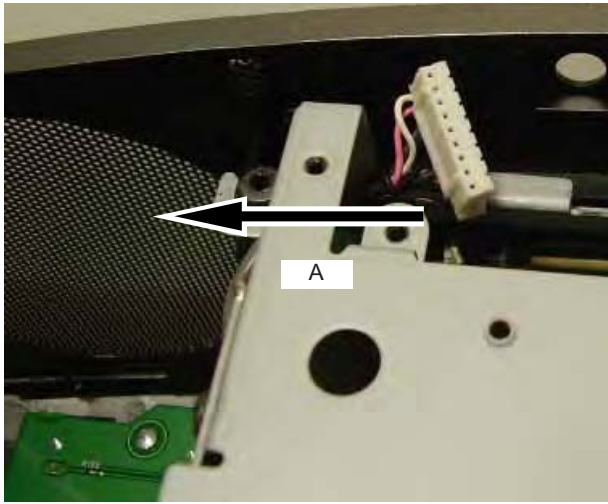

4. 1U-3851 CD ROM UNIT(S-52)

- (1) Remove each 2 screws D and E, then detach the MAIN CHASSIS and the MECHA BRACKET in the direction of the arrow.

4. 1U-3851 CD ROM UNIT(S-52)

- (1) D のねじ 2 本と E のねじ 2 本をはずしてから、MAIN CHASSIS と MECHA BRACKET を矢印方向にはずす。

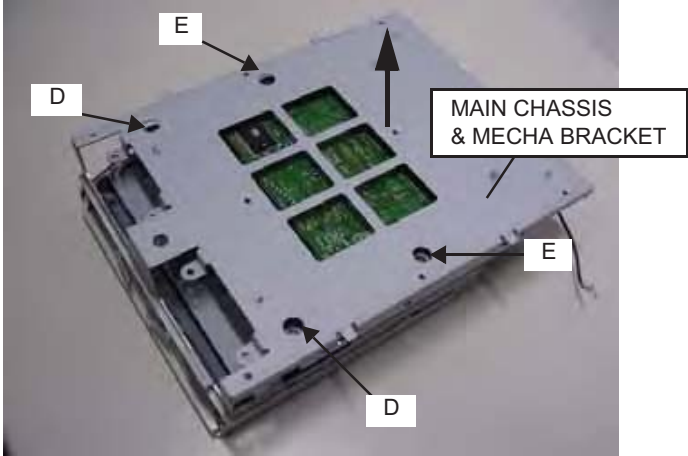

- (2) Move the Pick Up to the rear side and solder the short-circuit, then disconnect the FFC.

- (2) ピックアップを後方に移動し、半田付けショートを行ってから、FFC をはずす。

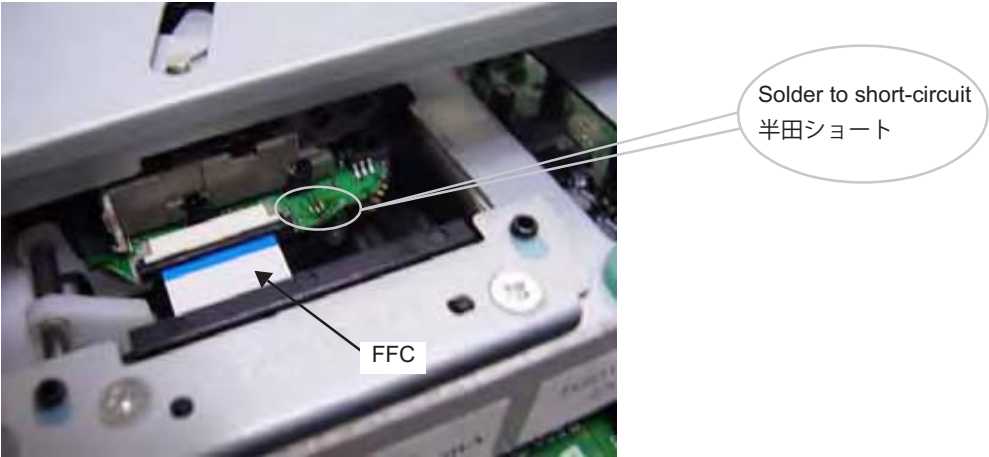

(3) Disconnect the 2P, 3P, 4P Wire and the FFC, then remove the 2 screws E.

(3) 2P、3P、4P ワイヤー及び FFC をはずし、E のねじ 2 本をはずす。

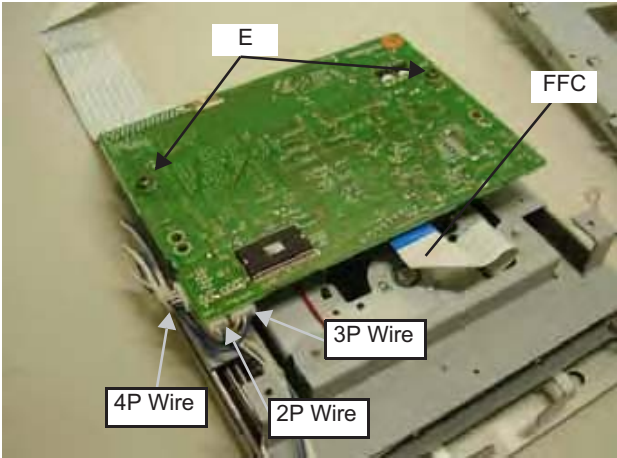

(4) Stand the CD ROM UNIT and disconnect the FFC.

(4) CD ROM UNIT を起こし、FFC をはずす。

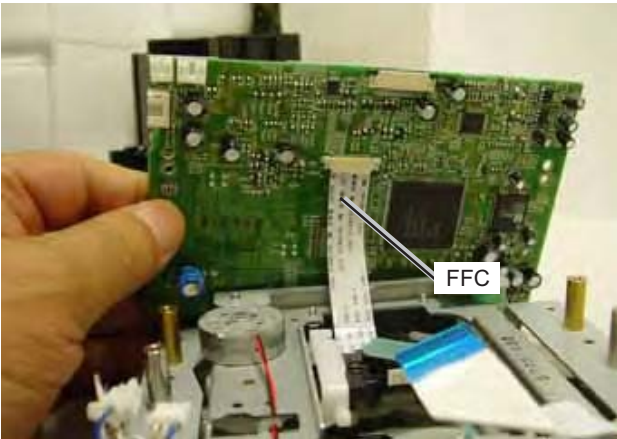

- (4) Disconnect the 16P FPC from the [CX161] on the MAIN UNIT.
- (5) Disconnect the 6P ZH-ZH CON.CORD from the [CX064] the MAIN UNIT.

- (4) MAIN UNITの [CX161] から 16P FPC をはずす。
- (5) MAIN UNITの [CX064] から 6P ZH-ZH CON.CORD をはずす。

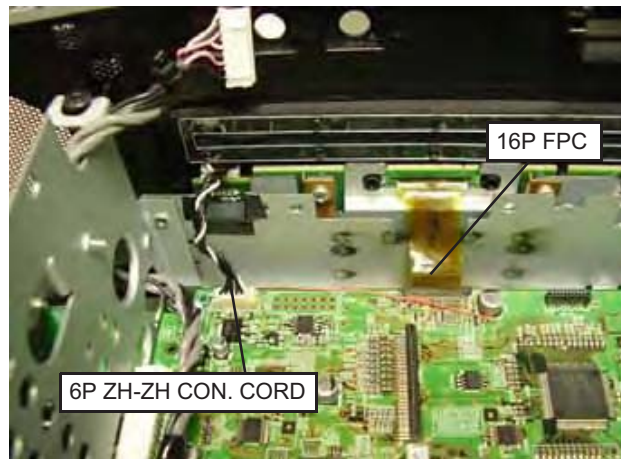

- (6) Detach the MAIN BLOCK in the direction of the arrow.

- (6) MAIN BLOCK を矢印方向にはずす。



**6A. 1U-3854 STANDBY TRANS UNIT
(for JP/E3/E2)**

(1) Remove the 1 screw 113 and the 1 screw 105 on the rear.

**6A. 1U-3854 STANDBY TRANS UNIT
(JP/E3/E2)**

(1) 113 のねじ 1 本と 105 のねじ 1 本をはずす。

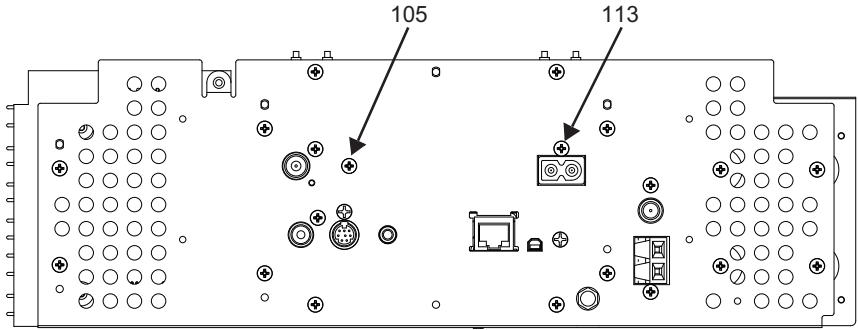

- (2) Disconnect the 5P PH-PH CON.CORD from the [CX051] on the STANDBY TRANS UNIT.
- (3) Disconnect the 2P Wire from the [CX121] on the STANDBY TRANS UNIT.
- (4) Detach the STANDBY TRANS UNIT in the direction of the arrow.

- (2) STANDBY TRANS UNIT の [CX051] から 5P PH-PH CON. CORD をはずす。
- (3) STANDBY TRANS UNIT の [CX121] から 2P ワイヤーをはずす。
- (4) STANDBY TRANS UNIT を矢印方向にはずす。

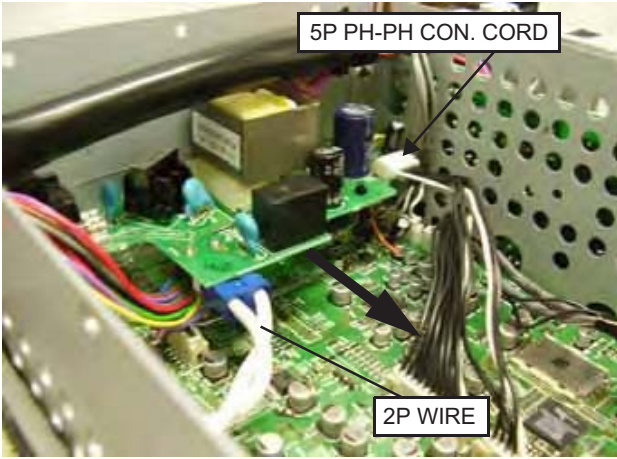

6B. 1U-3854 STANDBY TRANS UNIT(for EK)

- (1) Disconnect the 8P PH-PH SHIELD CORD from the [CY081] on 1U-3847-2.
- (2) Remove the 2 side screws 117, then detach the DAB SUB ASS'Y.

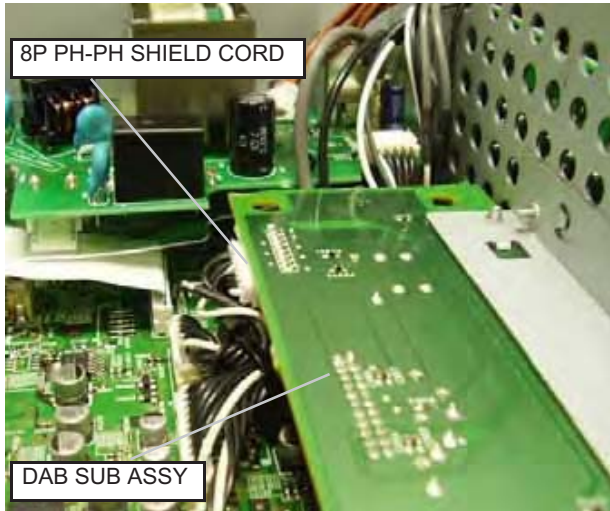

6B. 1U-3854 STANDBY TRANS UNIT (EK)

- (1) 1U-3847-2 の [CY081] から 8P PH-PH SHIELD CORD をはずす。
- (2) 側面の 117 のねじ 2 本をはずし、DAB SUB ASS'Y をはずす。



- (3) Remove the 2 screws 113 and the 1 screw 105 on the rear.
- (4) Disconnect the 5P PH-PH CON. CORD from the [CX051] on the STANDBY TRANS UNIT.
- (5) Disconnect the 2P Wire from the [CX121] on the STANDBY TRANS UNIT.
- (6) Detach the STANDBY TRANS UNIT in the direction of the arrow.

- (3) 後面側から、113 のねじ 2 本と 105 のねじ 1 本をはずす。
- (4) STANDBY TRANS UNIT の [CX051] から 5P PH-PH CON. CORD をはずす。
- (5) STANDBY TRANS UNIT の [CX121] から 2P ワイヤーをはずす。
- (6) STANDBY TRANS UNIT を矢印方向にはずす。

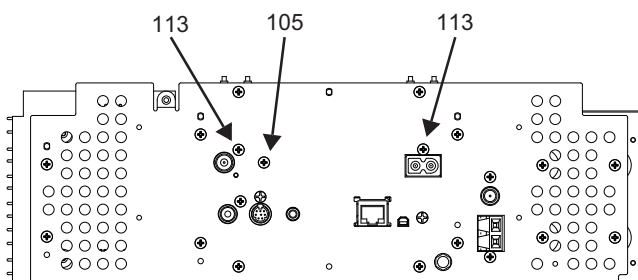

7. POWER TRANS

- (1) Remove the 4 screws 105 on the rear.

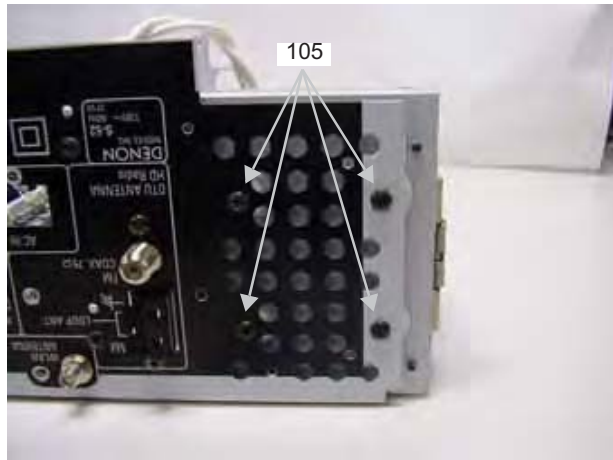

7. POWER TRANS

- (1) 後面側から、105 のねじ 4 本をはずす。

8. 1U-3847-1 POWER AMP UNIT

- (1) Disconnect the 6P PH-PH SHIELD CORD from the [CY062] on the POWER AMP UNIT.
- (2) Disconnect the 1P SIN EH CONN CORD from the [CY021] on the POWER AMP UNIT.
- (3) Disconnect the 4P PH-PH CON.CORD from the [CY041] on the POWER AMP UNIT.
- (4) Disconnect the 3P ZH-SAN CON.CORD from the the [CX303] on the MAIN UNIT and pull out in the direction of the arrow.

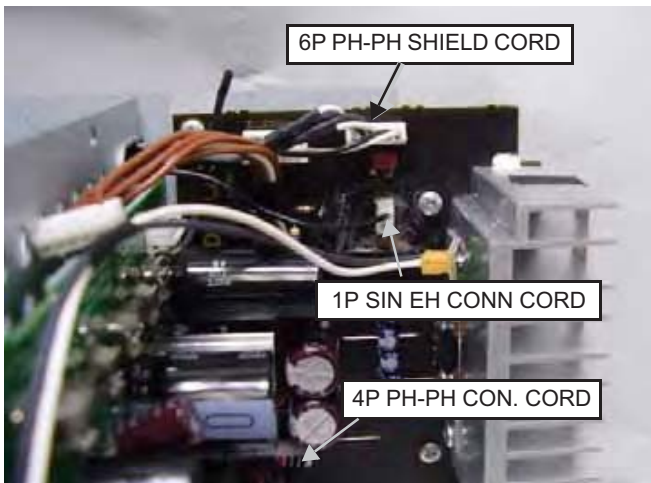

8. 1U-3847-1 POWER AMP UNIT

- (1) POWER AMP UNIT の [CY062] から 6P PH-PH SHIELD CORD をはずす。
- (2) POWER AMP UNIT の [CX021] から 1P SIN EH CONN CORD をはずす。
- (3) POWER AMP UNIT の [CY041] から 4P PH-PH CON.CORD をはずす。
- (4) MAIN UNIT の [CX303] から 3P ZH-SAN CON.CORD をはずし、矢印方向に引き抜く。



- (5) Remove the 2 inside screws 104 and the 2 rear screws 105.

- (5) 内側の 104 のねじ 2 本と、後面側から 105 のねじ 2 本をはずす。

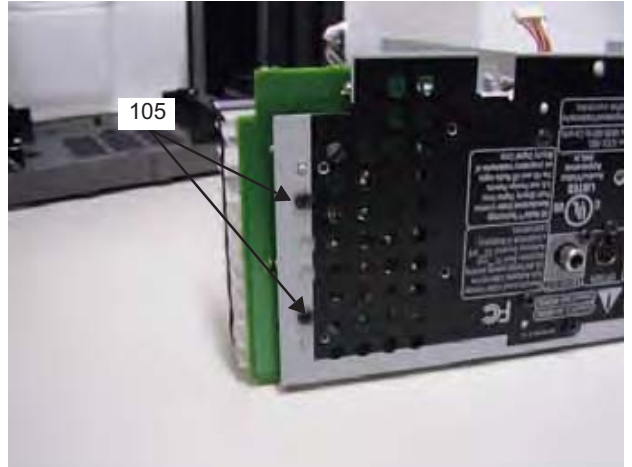
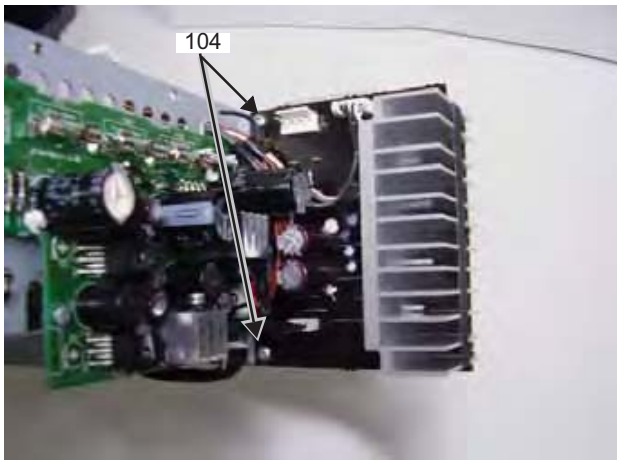

9. 1U-3859-1 POWER UNIT

- (1) Disconnect the 11P PH-PH CON.CORD from the [CY111] on the POWER UNIT.
- (2) Disconnect the 6P PH-PH CON.CORD from the [CY061] on the POWER UNIT.
- (3) Remove the 4 screws 104.

9. 1U-3859-1 POWER UNIT

- (1) POWER UNIT の [CY111] から 11P PH-PH CON.CORD をはずす。
- (2) POWER UNIT の [CY061] から 6P PH-PH CON.CORD をはずす。
- (3) 104 のねじ 4 本をはずす。

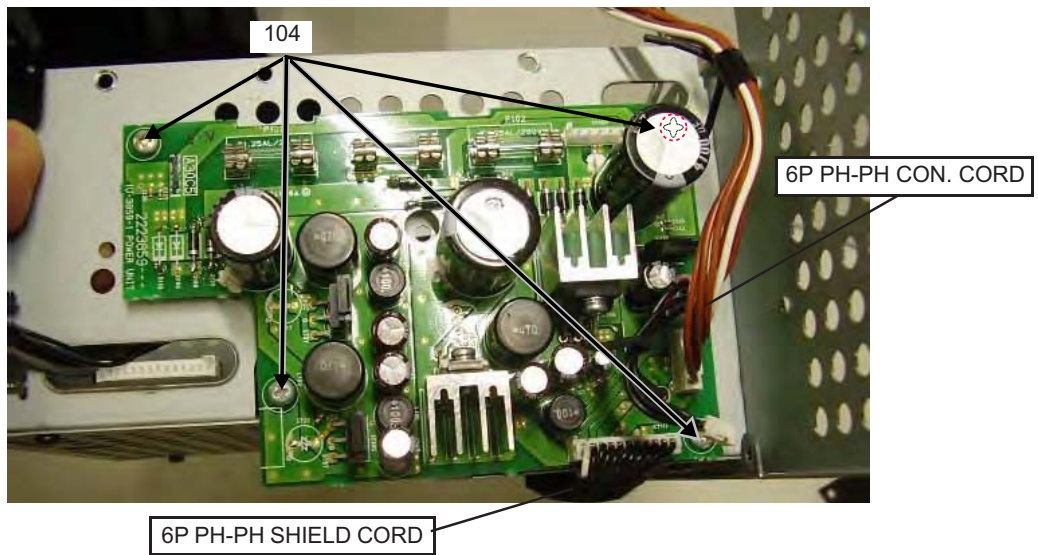

10. 1U-3846 MAIN UNIT

- (1) Remove the 2 screws 104 where the code holder outside of the side bracket is fixed.

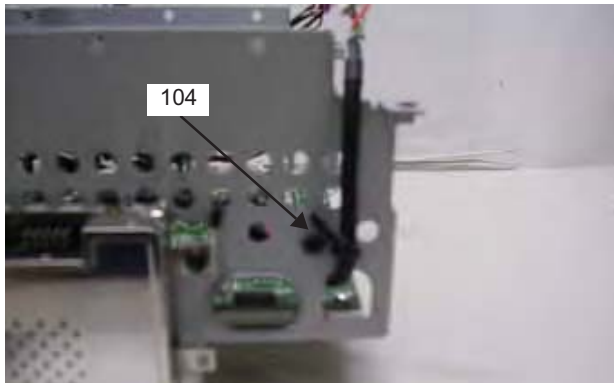

10. 1U-3846 MAIN UNIT

- (1) サイドブラケット外側のコードホルダーを固定している 104 のねじ 2 本をはずす。

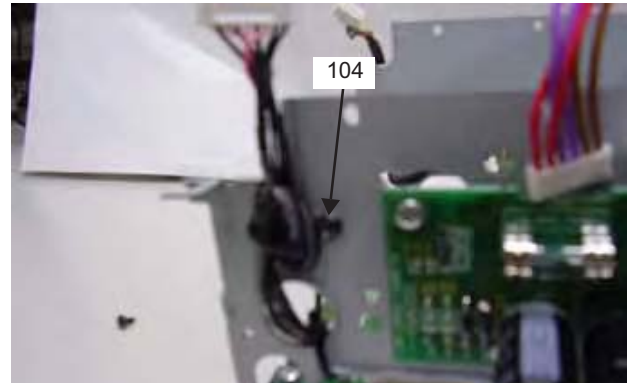

- (2) Cut off the 1 WIRE CLAMPER and remove.(S-52 only)
- (3) Disconnect the 16P CON.CORD from the [CX161] on the MAIN UNIT.(S-52E3 only)
- (4) Disconnect the 15P FFC CABLE from the [CX151] on the MAIN UNIT.(S-52JP/E2/EK,S-32E2/E3)
- (5) Disconnect the 6P PH-PH CON.CORD from the [CX062] on the MAIN UNIT.
- (6) Disconnect the 9P PH-PH CON.CORD from the [CX091] on the MAIN UNIT.
- (7) Disconnect the 3P ZH-SAN CON.CORD from the [CX303] on the MAIN UNIT.
- (8) Disconnect the 5P PH-PH CON.CORD from the [CX051] on the MAIN UNIT.
- (9) Disconnect the 5P PH-PH CON.CORD from the [CX054] on the MAIN UNIT.(S-52 only)
- (10) Disconnect 8P PH-PH CON.CORD from the [CX081] on the MAIN UNIT.(EK only)
- (11) Disconnect 11P PH-PH CON.CORD from the [CX111] on the MAIN UNIT.

- (2) WIRE CLAMPER 1 箇所をカットし、取り除く。(S-52 のみ)
- (3) MAIN UNIT の [CX161] から 16P CON.CORD をはずす。(S-52E3 のみ)
- (4) MAIN UNIT の [CX151] から 15P FFC CABLE をはずす。(S-52JP/E2/EK,S-32E2/E3)
- (5) MAIN UNIT の [CX062] から 6P PH-PH CON.CORD をはずす。
- (6) MAIN UNIT の [CX091] から 9P PH-PH CON.CORD をはずす。
- (7) MAIN UNIT の [CX303] から 3P ZH-SAN CON.CORD をはずす。
- (8) MAIN UNIT の [CX051] から 5P PH-PH CON.CORD をはずす。
- (9) MAIN UNIT の [CX054] から 5P PH-PH CON.CORD をはずす。(S-52 のみ)
- (10) MAIN UNIT の [CX081] から 8P PH-PH CON.CORD をはずす。(EK のみ)
- (11) MAIN UNIT の [CX111] から 11P PH-PH CON.CORD をはずす。

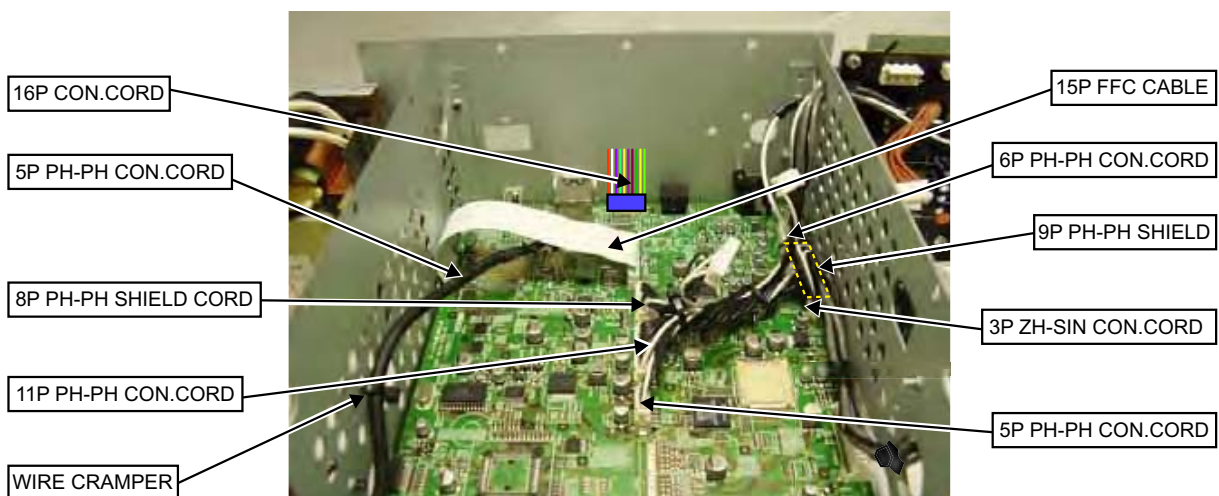

(12) Disconnect the 1P SAN EH CON.CORD from CX021 on the Power Amp Unit, then pull out in the direction of the arrow.

(12) POWER AMP UNIT の [CX021] から 1P SAN EH CON. CORD をはずし、矢印方向に引き抜く。

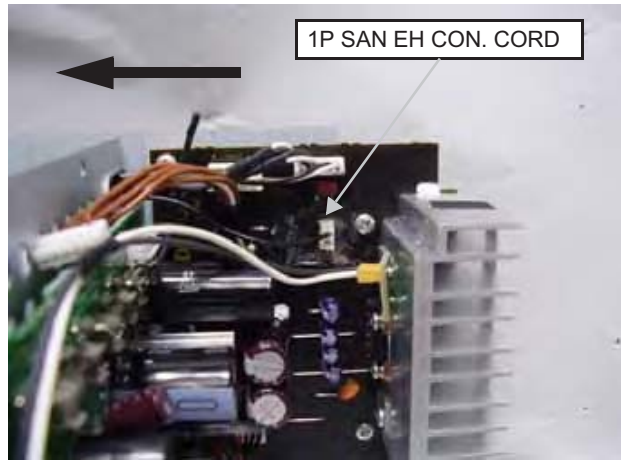

(13A) Remove the 4 screws 105 and the 1 screw 113. (E3 only)

(13A) 105 のねじ 4 本と 113 のねじ 1 本をはずす。(E3 のみ)

(13B) Remove the 3 screws 105 and the 1 screw 113. (JP/E2/EK only)

(13B) 105 のねじ 3 本と 113 のねじ 1 本をはずす。(JP/E2/EK のみ)

(14) Remove the WASHER 114 and the NUT 115.

(14) 114 のワッシャーと 115 のナットをはずす。

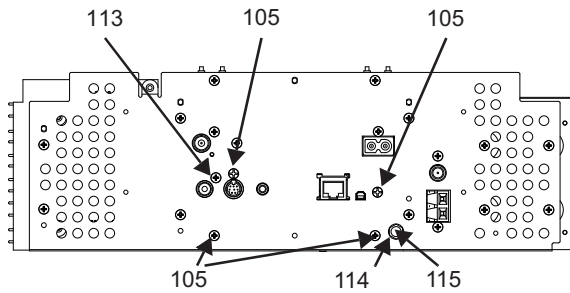

E3

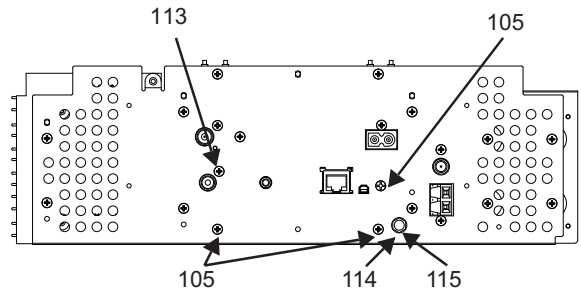

JP/E2/EK

- (15) Remove the 6 screws 105 and the 2 screws 104, the 2 washers 118.
- (16) Disconnect the 15P FFC CABLE from the AM FM TUNER.(S-52JP/E2/EK,S-32E2/E3)
- (17) Disconnect the 9P PH-PH SHIELD CORD from the [CX063] on the POWER UNIT.
- (18) Detach the TOP BRACKET in the direction of the arrow.

- (15) 105 のねじ 6 本と、104 のねじ 2 本、118 の 3W2 枚をはずす。
- (16) AM FM TUNER から、15P FFC CABLE をはずす。(S-52JP/E2/EK、S-32E2/E3)
- (17) POWER UNIT の [CX063] から 9P PH-PH SHIELD CORD をはずす。
- (18) TOP BRACKET を矢印方向へはずす。

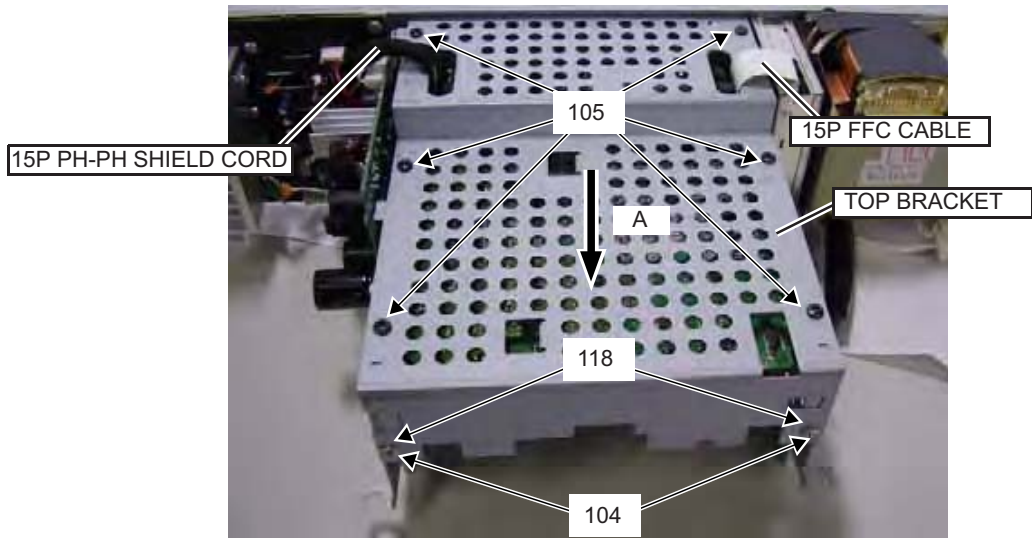

- (19) Remove the 3 screws 104.
- (20) Lift up the front of MAIN UNIT and detach it in the direction of the arrow.

- (19) 104 のねじ 3 本をはずす。
- (20) MAIN UNIT の前側を持ち上げ、矢印方向に引き抜く。

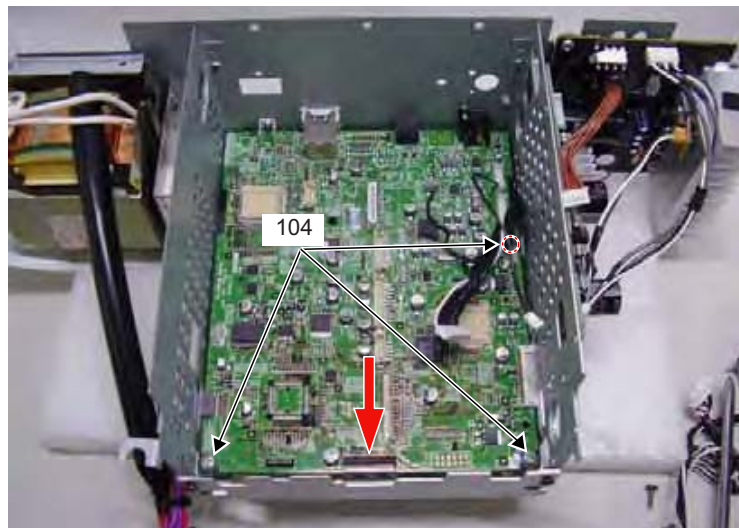

11.ROTARY KNOB

- (1) The SNAP FIT is bent from the back of the CABINET in the direction of the arrow ① .
- (2) The ROTARY KNOB RING is rotated in the direction of the arrow ② and detach.
- (3) Detach the ROTARY KNOB in the direction of the arrow ③ .

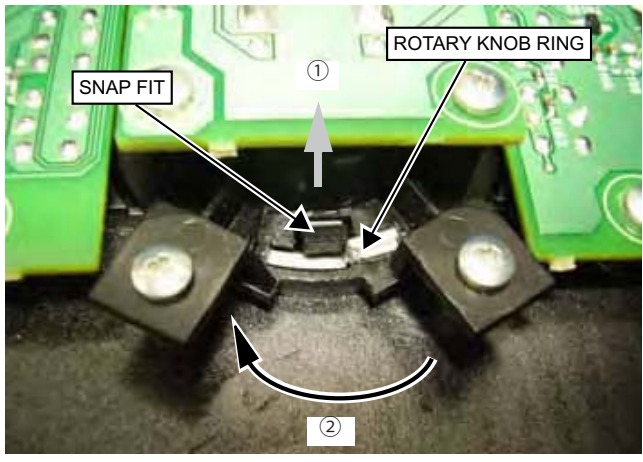

11.ROTARY KNOB

- (1) CABINET 裏側面より、SNAP FIT を矢印①方向にたわませる。
- (2) ROTARY KNOB RING を矢印②方向に回転させて、表面側より抜き取る。
- (3) ROTARY KNOB を矢印③方向に抜き取る。

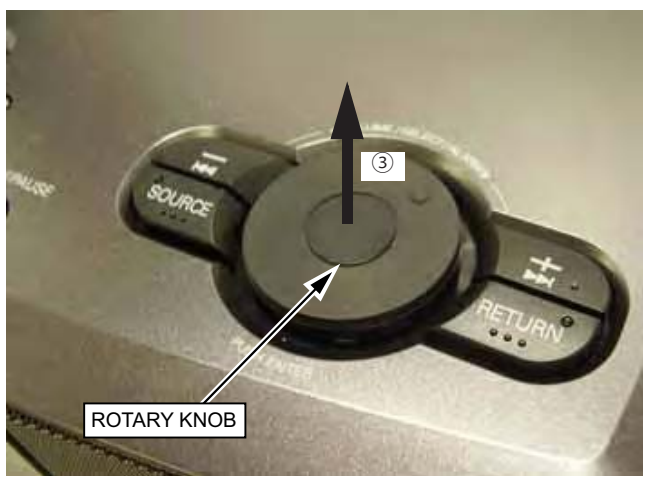

DIAGNOSTICS OF OPTICAL PICKUP AND REPLACING TRAVERSE UNIT

Make failure diagnostics of the Optical Pickup as follows.
 If the laser drive current (lop) becomes more than 1.5 times of the initial value, the Optical Pickup should be replaced.
 The laser drive current initial value is checked by "lop checked Method" of next page.
 In case of replacing the Pickup, change the whole part of the Traverse Unit.
 No mechanical adjustment is necessary after the replacement.

光ピックアップの故障診断とトラバースユニットの交換

次の順序で故障診断を行ってください。
 レーザー駆動電流 lop 値が初期値の 1.5 倍以上になっている場合は光ピックアップ交換の目安となります。
 レーザー駆動電流初期値は、次ページ "lop 値の確認方法" で確認できます。
 ピックアップ交換の場合は、トラバースユニット単位での交換となります。メカの調整は不要です。

**レーザー駆動電流初期値:
 Laser drive current initial value:**

Display (The display part of 13 digits)												
1	2	3	4	5	6	7	8	9	10	11	12	13
T	2	1	-	m	m	m	m	-	n	n	n	n

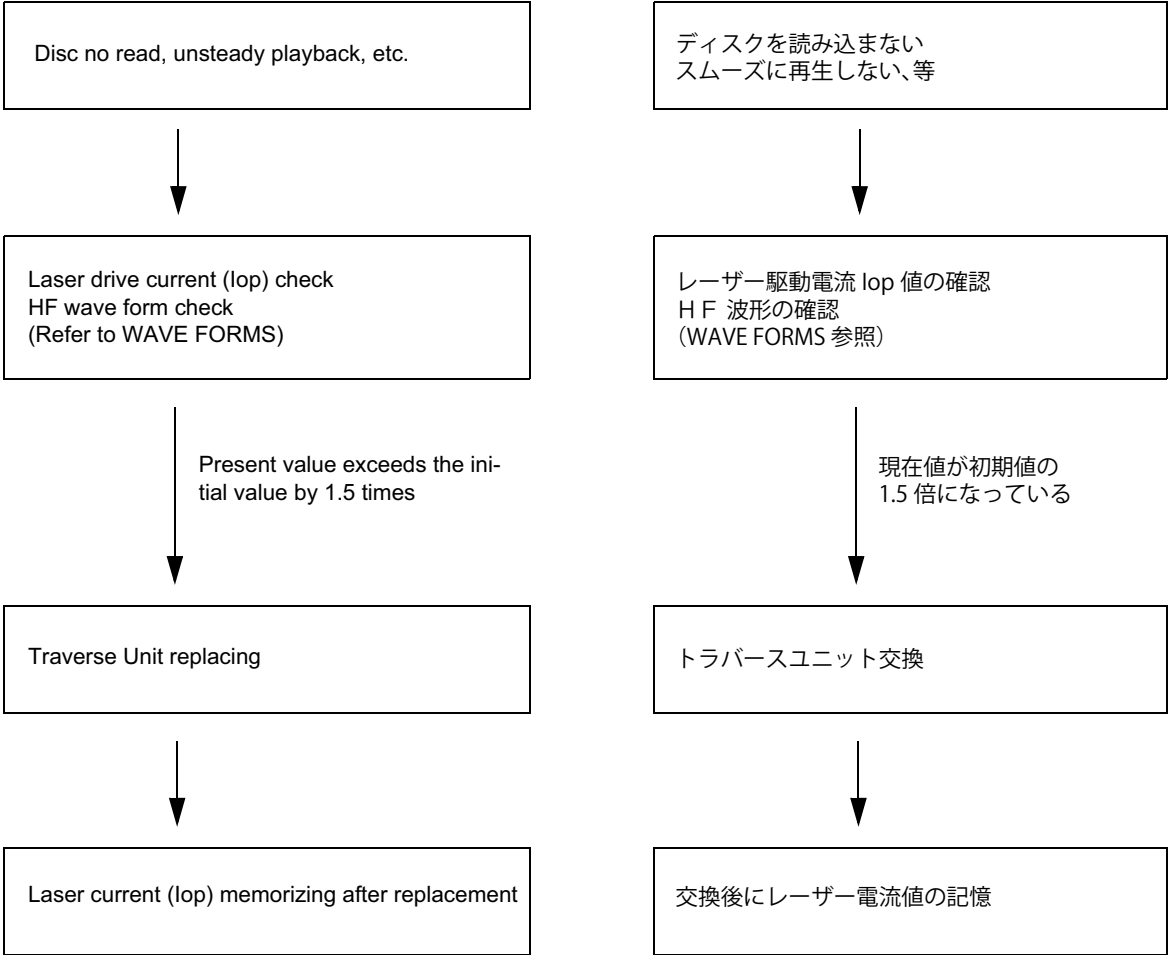

1. lop checked Method

Select the laser ON/OFF (CD) mode of the test mode, and check the lop value of CD laser.
(See page 32 for test mode.)

Display (The display part of 13 digits)												
1	2	3	4	5	6	7	8	9	10	11	12	13
T	2		L	a	s	e	r	O	n	O	f	f

1.1. CD Laser current check

- Press the ◀◀ or ▶▶ button to display the laser current value, and then select T21.
- Check the current value of lop (nnnn).

Display (The display part of 13 digits)												
1	2	3	4	5	6	7	8	9	10	11	12	13
T	2	1	—	m	m	m	m	—	n	n	n	n

(— : Off, CD laser, Initial value: mm.mm [mA],
Current value: nn.nn [mA])

2. Note for Handling the Laser Pick-Up

The protection for the damage of laser diode.
If you want to change the optical device unit from any other units, you must keep the following.

- It should be done at the desk already took measures the static electricity in care of removing the OPU's (Optical device unit) connector cable.
- Workers should be put on the "Earth Band".
- It should be done to add the solder to the short land to prevent the broken Laser diode before removing the 24P FFC cable.
- Don't touch OPU's connector parts carelessly.

3. Replacement of the Laser Pick-up (Traverse Unit)

Check the lop (Laser drive current)
If the present lop (current) value exceeds +150% of the initial value, replace the Traverse unit (Laser Pick-up) with a new one.

1. lop 値の確認方法

レーザー駆動電流を確認する場合は、テストモードのレーザー ON/OFF (CD) モードを選択して、CD レーザーの lop 値を確認します。
(詳細は 32 ページ、テストモード参照)

表示 (13 桁の表示部)												
1	2	3	4	5	6	7	8	9	10	11	12	13
T	2		L	a	s	e	r	O	n	O	f	f

1.1. CD レーザー電流確認

- レーザー電流値を表示する場合は、◀◀ ボタンまたは ▶▶ ボタンを押し、T21 を選択します。
- 現在の lop 値 (nnnn) を確認します。

表示 (13 桁の表示部)												
1	2	3	4	5	6	7	8	9	10	11	12	13
T	2	1	—	m	m	m	m	—	n	n	n	n

(— : 消灯、CD レーザー、初期値 : mm.mm[mA],
現在値 : nn.nn[mA])

2. レーザーピックアップの取扱注意

レーザーダイオードの破壊防止。
光素子ユニットを交換するときは、以下を遵守してください。

- 光素子ユニットの接続ケーブルをはずすときは、静電対策を行ったデスク上で作業してください。
- 作業者は、リストストラップを使用してください。
- レーザーダイオードの破壊防止のため、24P FFC ケーブルをはずす前にランドを半田付けショートしてください。
- 光素子ユニットのコネクタ部に触れないでください。

3. レーザーピックアップ (トラバースユニット) の交換

lop (レーザー駆動電流) をチェックします。
現在の lop 値が初期値の 150% を越えている場合、トラバースユニット (レーザーピックアップ) を交換してください。

4. Rewriting the default value of the laser current

To rewrite the default value of the laser current, press the ► button for at least 5 seconds while the CD laser current is displayed, then press the ◀◀ or ▶▶ button to select T23. (For details, see "Iop checked Method" on page 26.) If the ► button is pressed while T23 is displayed, the current value is displayed at "m m m m" and stored in the EEPROM.

Display (The display part of 13 digits)												
1	2	3	4	5	6	7	8	9	10	11	12	13
T	2	3	—	m	m	m	m	—	—	—	—	—

5. Resetting the accumulated laser on time

To clear the accumulated laser on time, press the ► button while the accumulated laser on time is displayed (TB1: For details, see "Test Mode" on page 32.) until " * " appears at the fourth position, the accumulated laser on time of CD is cleared. When TB1 is selected, "n n n n n n" is displayed as 0 so you can check.

Display (The display part of 13 digits)												
1	2	3	4	5	6	7	8	9	10	11	12	13
T	B	Y	—	—	—	n	n	n	n	n	n	n

(— : Off, n n n n n n: Hour [h])

4. レーザー電流初期値の書き換え方法

レーザー電流の初期値を書き換えるには、CD レーザー電流が表示されている時に ► ボタンを 5 秒以上押し、次に ◀◀ ボタンまたは ▶▶ ボタンを押して T23 を選択します。(詳細は 26 ページ、Iop 値の確認方法参照)

T23 表示時に ► ボタンを押すと、m m m m 部に現在値を表示し、EEPROM に保存します。

表示 (13 桁の表示部)												
1	2	3	4	5	6	7	8	9	10	11	12	13
T	2	3	—	m	m	m	m	—	—	—	—	—

5. レーザー ON 累積時間のリセット方法

レーザー ON 累積時間をクリアするには、レーザー ON 累積時間表示 (TB1) の時 (詳細は 32 ページ、テストモード参照) に ► ボタンを 4 桁目に ' * ' が表示されるまで押し、CD レーザー ON 累積時間をクリアします。

◀◀ ボタンまたは ▶▶ ボタンで TB1 を選択すると、n n n n n n 部が 0 表示となり確認できます。

表示 (13 桁の表示部)												
1	2	3	4	5	6	7	8	9	10	11	12	13
T	B	Y	—	—	—	n	n	n	n	n	n	n

(— : 消灯、n n n n n n : 時間 [h])

HOW TO REPLACE TRAVERSE UNIT (S-52,S-52ADB)

Caution: The optical pickup can be damaged easily by static electricity charged on human body. Take necessary anti-static measures when repairing around the optical pickup.

(Follow the procedure below in reverse order when reassembling.)

1. Top Cover disassembly

- (1) Remove screw A, then move the Top Cover as shown in the arrow ① direction. And detach left end of it as shown in the arrow direction.
- (2) Remove screw B, then move the Loading Unit as shown in the arrow ② direction. And detach it as shown in the arrow direction.

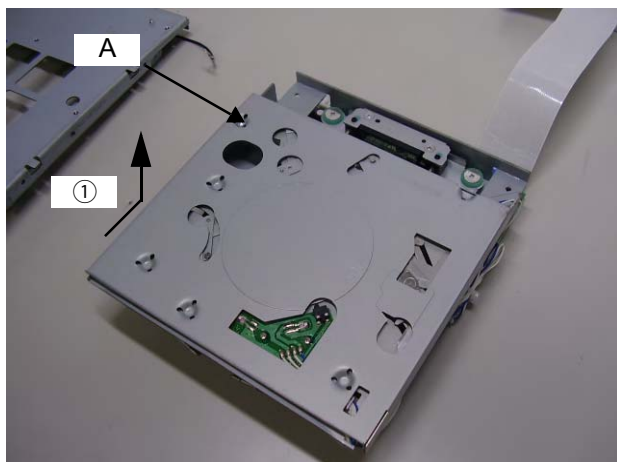

トラバースユニットの交換方法 (S-52,S-52DAB)

注意: 光ピックアップは、人体に帯電した静電気等で静電破壊することがあります。光ピックアップ周辺を修理する際は、必要な静電対策を行ってください。

(組み立てるときは、逆の順序でおこなってください。)

1. トップカバーのはずしかた

- (1) ねじ A をはずしてから、Top Cover を矢印①方向に移動し、左端を矢印方向に開く様にはずします。
- (2) ねじ B をはずしてから、Loading Unit を矢印②方向に移動し、はずします。



2. Traverse Unit disassembly

- (1) Solder the short-circuit.
- (2) Remove 4 screws C.
- (3) Disconnect FFC from the Pick Up.

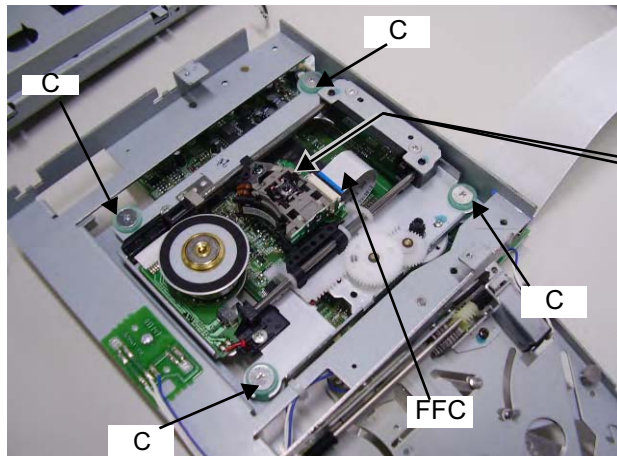

2. トラバースユニットのはずしかた

- (1) 半田付けショートをおこないます。
- (2) ねじC 4本をはずします。
- (3) ピックアップから FFC をはずします。

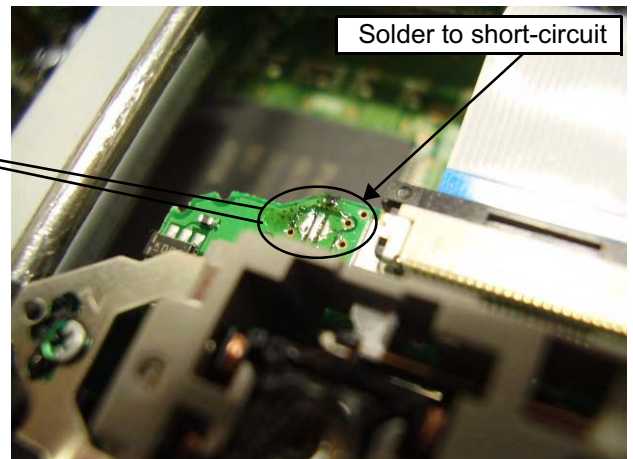

- (4) Lift the Traverse Assy and disconnect FFC.

- (4) Traverse Assy を持ち上げて、FFC をはずします。

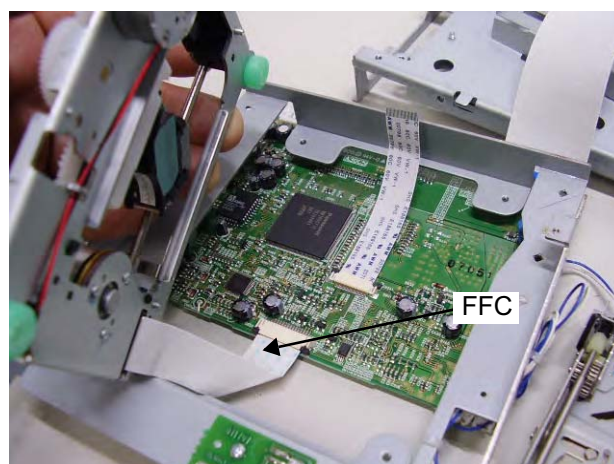

SERVICE MODE

1. Initial Setting Mode

1.1. Preparation

- (1) Equipment used None
- (2) Unit setting No spec other than the following procedure

1.2. Procedure

● SYSTEM

- ※ Initialize the backup data when μ com, peripheral parts of μ com, or Main P W B has been replaced in servicing
 - ※ All user setting will be lost and its factory setting will be restored when this initialization is made. Be sure to memorize your setting for restoring again after the initialization
- (1) Pressing the main unit's SNOOZE and the ►►| buttons simultaneously, plug the AC cord into a power outlet. The initialization mode is set. Then "INITIALIZE" is displayed on the display tube.
 - (2) Once the entire initialization procedure has been completed, the set is in the normal mode with the power turned on.

2. μ com Firm Check Mode

2.1. Preparation

- (1) Equipment used None
- (2) Unit setting No spec other than the following procedure

2.2. Procedure

- ※ Use this to display the version information, etc.

NOTE)The version information is displayed 1 minute after it turns on power supply

- To display the DAB version, press the SOURCE button before step (2) and select DAB using Jog (EK only)
 - To display the HD version, press the SOURCE button before step (2) and select FM or AM using Jog (E3 only)
- (1) When the STANDBY mode, the DIMMER and the |◀▶ buttons are simultaneously pressed. Afterwards, when the power supply of the set is turned on pressing the FUNCTION ON/OFF button, the system check mode is set.
 - (2) Press the SOURCE button and select SETUP using Jog to add the Version display mode at the head of the SETUP items. This will appear as "Version Display"
 - (3) Select Version Display and turn Jog to display. The information will be displayed in the following order each time you turn Jog: the system microcomputer versions → DSP → frontend → DM850Boot → DM850Image → DM850Config → DAB(EK only) → HD(E3 only)
 - (4) Unplug AC cord to clear this mode.

サービスモードについて

1. イニシャルモード

1.1. 準備

- (1) 使用機器：無
- (2) 本体設定：下記手順以外規定無。

1.2. 手順

● システム

- ※ サービスにて、マイコンやマイコン周辺部分やメイン基板を交換した場合は、バックアップデータの初期化を行う。
 - ※ 初期化を行うと設定した内容が工場出荷状態に戻るため、あらかじめ設定内容を控えておき初期化後に再設定する。
- (1) 本体 SNOOZE ボタンと ►►| ボタンを同時に押しながら、AC コードを接続するとイニシャルモードが設定され、"INITIALIZE" が表示される。
 - (2) 全ての初期化完了後、通常モードの電源 ON の状態になる。

2. マイコンファームチェックモード

2.1. 準備

- (1) 使用機器：無
- (2) 本体設定：下記手順以外規定無。

2.2. 手順

- ※ バージョン表示等をおこなう。

注)・DM850 のバージョンの表示は、電源を入れてから 1 分後に表示される。

- ・DAB のバージョン表示は (2) の操作の前に SOURCE ボタンを押し、Jog で DAB を選択してから行う。(EK のみ)
- ・HD のバージョン表示は (2) の操作の前に SOURCE ボタンを押し、Jog で FM または AM を選択してから行う。(E3 のみ)

- (1) 本体 DIMMER ボタン |◀▶ ボタンを同時に押し、AC コードを接続する。その後、FUNCTION ON/OFF ボタンを押してセットの電源を入れるとシステムチェックモードが設定される。
- (2) SOURCE ボタンを押し、Jog で SETUP を選択すると、SETUP 項目の先頭に Version 表示モードが追加され、"Version Display" と表示される。
- (3) Version Display を選択すると、Jog をまわす毎に、システムマイコンのバージョン → DSP → Frontend → DM850Boot → DM850Image → DM850Config → DAB(EK のみ) → HD(E3 のみ) の順に表示される。
- (4) AC コードを抜くことにより、システムチェックモードを解除する。

3. Heat Run Mode (S-52)

3.1. preparation

- (1) Equipment used CD
- (2) Unit setting No spec other than the following procedure

3.2. procedure

※ Perform heat run of the CD

- (1) Pressing the **▲** and DIMMER buttons simultaneously, plug the AC cord into a power outlet. This sets the heat run mode.
- (2) Check both the SOURCE LED and "RETURN LED" indicators light on the fluorescent display tube.
- (3) Press the **▶||** button after inserting a disk (or with a disk already inserted) to execute the heat run mode. All tracks on the disc will be played.

NOTE) ・If disc being used has less than 20 tracks, play all tracks. If disc has 21 or more tracks, skip to final track after playback of first track has finished.

- (4) Once playback is completed, eject and insert the disk and repeat the playback operation in step (3).
- (5) If there is an error while in the Heat run mode, the error is displayed and the stop mode is set with the status at that time.

NOTE) ・The buttons on the remote control unit will not work during the heat run mode.
(If the set's power is turned off pressing the FUNCTION ON/OFF button, the CD stops and the heat run mode is canceled.)

Error code	Error contents
0x0000	No error
0x0003	System Interface error
0x0500 0x0501	File Check error
0x0F01	Fatal error on CD ROM drive (Time out etc.)
0x0400 0x040E	CD ROM Drive error

3. ヒートランモード (S-52)

3.1. 準備

- (1) 使用機器：CD
- (2) 本体設定：下記設定以外規定無。

3.2. 手順

※ CD のヒートランをおこなう。

- (1) 本体の **▲** ボタンと DIMMER ボタンを同時に押しながら AC コードをコンセントへ接続すると、ヒートランモードが設定される。
- (2) SOURCE LED と RETURN LED が両方とも点灯することを確認する。
- (3) ディスクが挿入された状態 (挿入中も含む) で **▶||** ボタンを押してヒートランモードを実行し、ディスクに収録されている全ての曲を再生する。

注) ・使用ディスクが 20 トラック以内の時は全トラックを再生し、21 トラック以上の時は、1 トラックと最終トラックを再生する。

- (4) 再生終了後、ディスクをスロットから取り出し再び挿入、(3) の再生動作をおこなう。
- (5) ヒートランモード中にエラーが発生すると、エラーを表示し、その時の状態で停止する。

注) ・ヒートランモード中は、リモコンのボタンは動作しない。
(FUNCTION ON/OFF ボタンを押してセットの電源を OFF にすると、CD が停止し、ヒートランモードが解除される為。)

エラーコード	エラー内容
0x0000	正常終了
0x0003	システムインターフェースエラー
0x0500 - 0x0501	File Check エラー
0x0F01	CD ROM Drive で致命的な障害 (タイムアウト等)
0x0400 - 0x040E	CD ROM Drive エラー

4. Test mode (S-52)

4.1. Entering the test mode

To set the test mode, press the RETURN button before pressing the ►|| button in the heat run mode. Not insert the disc. (To set the heat run mode, connect the AC cord and press the FUNCTION ON/OFF button while pressing the ▲ and DIMMER buttons simultaneously to turn on the set power. When the Heat run mode is set, the SOURCE LED and RETURN LED indicators light.)

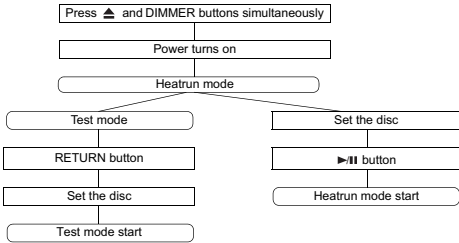

Display when test mode entered

Display
T E S T M O D E

4.2. Selecting the mode

The following modes are available

- (1) Laser on/off (CD) mode T2
- (2) Servo adjustment value display mode T3
- (3) Trace mode (error rate display) T7
- (4) Accumulated laser on time TB

① When the ►|| button is pressed after entering the test mode, the display switches in the order T2, T3, T7, TB, T2...

Display
T 2 L a s e r O n O f f
Display
T 3 S e r v o A d j
Display
T 7 T r a c e M o d e
Display
T B L a s e r O n T i m

4. テストモード (S-52)

4.1. テストモードの設定

テストモードの設定はヒートランモード時に►||ボタンを押す前に RETURN ボタンを押すことでおこなう。ディスクは挿入していないこと。(ヒートランモードの設定は ▲ ボタンと DIMMER ボタンを同時に押しながら、AC コードを接続し、FUNCTION ON/OFF ボタンを押してセットの電源を入れる。ヒートランモードになると SOURCE LED と RETURN LED が点灯する。)

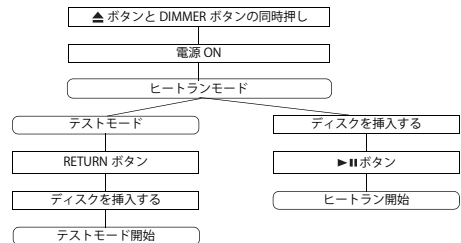

テストモード設定時の表示

表示
T E S T M O D E

4.2. モードの選択

モードには、次のモードがある。

- (1) レーザー ON/OFF(CD) モード : T2
- (2) サーボ調整値表示モード : T3
- (3) トレースモード (エラーレート表示) : T7
- (4) レーザー ON 累積時間 : TB

① テストモード中に►||ボタンを押すと、T2,T3,T7,TB,T2...の順に表示される。

表示
T 2 L a s e r O n O f f
表示
T 3 S e r v o A d j
表示
T 7 T r a c e M o d e
表示
T B L a s e r O n T i m

4.3. Setting the mode

With the mode selected, press the ►|| button to set that mode

- ① In the laser on/off (CD) mode, laser on/off control is executed and the laser current is displayed
To save the current laser current value, press and hold in the ►|| button for at least 5 seconds to turn off the "mmmm" section of the display, then press the ►|| button and select T23. When the ►|| button is pressed while T23 is displayed, the data is displayed in the "mmmm" section

For the CD laser

Display												
T	2	1	-	m	m	m	m	-	n	n	n	n

(- : Off, CD laser, Stored data mm mm [mA], Current value nn nn [mA])

- ② In the servo adjustment value display mode (See "Table 1 Servo adjustment value display mode details")

Display												
T	X	X	-	-	-	-	-	-	n	n	n	n

(XX : Selection mode, n : Adjustment value (HEX))

- ③ In the trace mode (error rate display), select the trace of the innermost circumference of 1 layer

Display												
T	7	1	F	F	F	F	F	F	F	F	F	F

(F : When address and error rate not set, F is displayed)

- ④ Displaying the accumulated laser on time (stored in the EEPROM)

Display												
T	B	1	-	-	n	n	n	n	n	n	n	n

(nnnnn : Time [h])
※ Fractions of hours are counted up one hour on the display

4.3. モードの確定

モードを選択してある状態で►||ボタンを押すとモードを確定する。

- ①レーザー ON/OFF(CD) モードの場合、レーザーの ON/OFF 制御を実行し、レーザー電流を表示する。
現在のレーザー電流値を保存する場合、►||ボタンを 5 秒以上押し続け、mmmm 部を非表示にし、►||ボタンを押して、T23 を選択する。T23 を表示時に►||ボタンを押すと、mmmm 部にデータが表示される。

CD レーザーの場合

表示												
T	2	1	-	m	m	m	m	-	n	n	n	n

(- : 消灯、C D レーザー、保存データ: mm.mm[mA], 現在値: nn.nn[mA])

- ②サーボ調整値表示モードの場合 (表 1 サーボ調整値表示モード詳細参照)

表示												
T	X	X	-	-	-	-	-	-	n	n	n	n

(X X : 選択モード、n : 調整値 (HEX))

- ③トレースモード (エラーレート表示) の場合は、1 層内周のトレースを選択する。

表示												
T	7	1	F	F	F	F	F	F	F	F	F	F

(F : アドレス及びエラーレートは未確定時、F を表示する。)

- ④レーザー ON 累積時間 (EEPROM に記憶) を表示する。

表示												
T	B	1	-	-	n	n	n	n	n	n	n	n

(nnnnn : 時間 [h])
※ 1 時間未満は切り上げて表示する。

4.4. Change within the mode

Changes within modes are made by pressing the ◀◀ and ▶▶ buttons while the mode is set

① In the laser on/off mode, laser on/off control is executed and the laser current is displayed

For the CD laser

Display												
T	2	1	—	m	m	m	m	—	n	n	n	n

(— : Off, CD laser, Stored data mm mm [mA], Current value nn nn [mA])

When there is no saved data

Display												
T	2	1	—	—	—	—	—	—	n	n	n	n

(— : Off, nn nn [mA])

To store the current value, press the ▶▶ button for " * " appears at the fourth position, then press the ◀◀ or ▶▶ button to select T23

If the ▶▶ button is pressed while T23 is displayed, the current value is displayed at "mmmm" and stored in the EEPROM

Display												
T	2	3	—	m	m	m	m	—	n	n	n	n

(— : Off, nn nn [mA])

If the current value is over 100 mA, the 4th and 9th digit sections are used

② In the servo adjustment value display mode (See "Table 1 Servo adjustment value display mode details")

Display												
T	X	X	—	n	n	n	n	n	n	n	n	n

(XX : Selection mode, n : Adjustment value (HEX))

For the adjustment values, 0's are added in front of the effective number of bytes

(Ex : If the value is 0x123 for 4 byte data, "00 00 01 23" is displayed)

③ In the trace mode (error rate display) (See "Table 2 Trace mode details")

Display												
T	Y	Y	F	F	F	F	F	F	F	F	F	F

(YY : Selection mode [71 to 94], F : When address and error rate not set, F is displayed)

④ In the accumulated laser on time display

Display												
T	B	1	—	n	n	n	n	n	n	n	n	n

(nnnnnn : Time [h]) ※ If the current value is over 100 mA, the 4th and 9th digit sections are used

To clear the accumulated laser on time, press the ▶▶ button while the accumulated laser on time is displayed (TB1) until " * " appears at the fourth position, then the accumulated laser on time of CD is cleared

When TB1 is selected, "nnnnnn" is displayed as 0 so you can check

4.4. モード内での変更

モードを確定してある状態で◀◀ボタンまたは▶▶ボタンを押すとモード内での変更をおこなう。

①レーザー ON/OFF モードの場合、レーザーの ON/OFF 制御を実行し、レーザー電流を表示する。

CD レーザーの場合

表示												
T	2	1	—	m	m	m	m	—	n	n	n	n

(— : 消灯、CD レーザー、保存データ: mm.mm[mA], 現在値: nn.nn[mA])

保存データなしの場合

表示												
T	2	1	—	—	—	—	—	—	n	n	n	n

(— : 消灯、nn.nn[mA])

現在値を保存するには、▶▶ボタンを4桁目に " * " が表示されるまで押し、次に◀◀ボタンまたは▶▶ボタンを押して T23 を選択する。T23 表示時に、▶▶ボタンを押すと、mmmm 部に現在値を表示し、EEPROM に保存される。

表示												
T	2	3	—	m	m	m	m	—	n	n	n	n

(— : 消灯、mm.mm[mA])

電流値が 100mA 以上の場合は、4桁、9桁部分を使用。

②サーボ調整値表示モードの場合 (表 1 サーボ調整値表示モード詳細 参照)

表示												
T	X	X	—	n	n	n	n	n	n	n	n	n

(XX : 選択モード、n : 調整値 (HEX))

調整値は、有効バイト数分先頭に 0 をつける。

(例 : 4 バイトデータで値が 0x123 の場合は "00 00 01 23")

③トレースモード (エラーレート表示) の場合 (表 2 トレースモード詳細 参照)

表示												
T	Y	Y	F	F	F	F	F	F	F	F	F	F

(YY : 選択モード [71 ~ 94], F : アドレス及びエラーレートは未確定時、F を表示する。)

④レーザー ON 累積時間を表示場合

表示												
T	B	1	—	n	n	n	n	n	n	n	n	n

(nnnnnn : 時間 [h]) ※ 1 時間未満は切り上げて表示する。

レーザー ON 累積時間をクリアする場合、レーザー ON 累積時間表示時 (TB1) のとき、▶▶ボタンを4桁目に " * " が表示されるまで押し、CD レーザー ON 累積時間をクリアする。TB1 を選択すると、nnnnnn が 0 表示になり確認できる。

4.5. Execution of trace mode (error rate display) (See "Table 2 - Trace mode details")

Trace will be performed if the ►|| button is pushed after choosing operation

Display												
T	Y	Y	m	m	m	m	m	l	l	l	l	l

(YY: selection mode [71 to 94], m: address [LBA][HEX], l: error rate [COUNT/SEC] [HEX])
 Note) CD Error rate of 75 frames is displayed (1 second)

The mode chosen when selection mode was changed into the trace execution and the ►|| button was pushed is performed from the beginning
 When the ►|| button is pushed without changing selection mode, the mode under selection is performed from the beginning (if the ►|| button is pushed, the address corresponding to the chosen mode will be searched again)

The pause mode is set after tracing is completed

4.6. Other operations

- ① When the RETURN button is pressed, the mode returns to the previously selected mode

(1) Test mode detailed table

Table 1 Servo adjustment value display mode details

XXX	Name	Size	Meaning	Remarks
T31	fbal0	16bits	CD layer focus balance adjustment value	FBAL range: 0x8000 < FBAL < 0x7FC0 (Center: 0x0000)
T32	tbal0	16bits	CD layer tracking balance adjustment value	TBAL range: 0x0000 < TBAL < 0x003F
T33	fcga0	16bits	CD layer focus Loop Gain adjustment value	1x for 0x100 [0x200 (2x) set to Typ (1x for 0x100, 2x for 0x200 Y/0x100 ratio calculation) Adjustment value 0x200 sets so that gain crossover reaches target
T34	tkga0	16bits	CD layer tracking Loop Gain adjustment value	1x for 0x100 [0x200 (2x) set to Typ (1x for 0x100, 2x for 0x200 Y/0x100 ratio calculation) Adjustment value 0x202 sets so that gain crossover reaches target
T39	Asofs	16bits	AS signal Offset value	Upper 10 bit is valid
T40	Envoffse	16bits	ENV signal Offset adjustment value	Upper 10 bit is valid
T41	Foffse	16bits	FE signal Offset adjustment value	Upper 10 bit is valid
T42	Teoffse	16bits	TE signal Offset adjustment value	Upper 10 bit is valid
T43	RFfc	8bits	RF signal frequency adjustment value	
T44	RFbst	8bits	RF signal Boost adjustment value	Adjustment range: 0x0000 ~ 0x001F 0x0000: 0dB 0x001F: 14dB
T45	RFgdl	8bits	RF signal low range group delay adjustment value	
T46	RFgdh	8bits	RF signal high range group delay adjustment value	

Table 2 Trace mode details

YY	Contents	Contents supplement
73	A display of C1 error detection number of the inner circumference of an address	CD C1 error detection number (x3)
77	A display of C1 error detection number of the central circumference of an address	CD C1 error detection number (x3)
81	A display of C1 error detection number of the outer circumference of an address	CD C1 error detection number (x3)

4.5. トレースモード (エラーレート表示) の実行 (表 2 トレースモード詳細 参照)

動作を選択した後、►|| ボタンを押すとトレースを実行する。

表示												
T	Y	Y	m	m	m	m	m	l	l	l	l	l

(Y Y: 選択モード [71 ~ 94], m: アドレス [PBA][HEX], l: エラーレート [COUNT/SEC] [HEX])
 注) : 表示するエラーレートは、75 フレーム (1 秒) 分の値。

トレース実行中に選択モードを変更し、►|| ボタンを押すと選択したモードを最初から実行する。
 選択モードを変更せずに ►|| ボタンを押した場合は、選択中のモードを最初から実行する。
 (►|| ボタンを押すと、選択しているモードに対応したアドレスを再度サーチする。)

トレース終了時は、PAUSE 状態になります。

4.6. その他の動作

- ① RETURN ボタンを押すと、前の選択モードに戻る。

(1) テストモード詳細一覧表

表 1 サーボ調整値表示モード詳細

XXX	名称	サイズ	意味	備考
T31	fbal0	16ビット	CD層フォーカスバランス調整値	FBALの範囲は 0x8000<FBAL<0x7FC0。(センター:0x0000)
T32	tbal0	16ビット	CD層トラッキングバランス調整値	TBALの範囲は 0x0000<TBAL<0x003F。
T33	fcga0	16ビット	CD層フォーカス Loop Gain 調整値	0x100 で 1 倍 (0x200 (2 倍) を Typ に設定する。) (0x100 で 1 倍、0x200 で 2 倍、1/0x100 の比率計算) 調整値 0x200 で Gain 交点が目標ターゲットになる様設定している。
T34	tkga0	16ビット	CD層トラッキング Loop Gain 調整値	0x100 で 1 倍 (0x200 (2 倍) を Typ に設定する。) (0x100 で 1 倍、0x200 で 2 倍、1/0x100 の比率計算) 調整値 0x202 で Gain 交点が目標ターゲットになる様設定している。
T39	Asofs	16ビット	AS 信号の Offset 値	上位 10bit が有効
T40	Envoffse	16ビット	ENV 信号の Offset 調整値	上位 10bit が有効
T41	Foffse	16ビット	FE 信号の Offset 調整値	上位 10bit が有効
T42	Teoffse	16ビット	TE 信号の Offset 調整値	上位 10bit が有効
T43	RFfc	8ビット	RF 信号の周波数調整値	
T44	RFbst	8ビット	RF 信号の Boost 調整値	調整範囲: 0x0000 ~ 0x001F 0x0000: 0dB 0x001F: 14dB
T45	RFgdl	8ビット	RF 信号の低域群遅延調整値	
T46	RFgdh	8ビット	RF 信号の高域群遅延調整値	

表 2 トレースモード詳細

YY	内容	補足説明
73	内周の C1 誤り検出数とアドレスの表示	CD 時は C1 誤り検出数。(x3)
77	中周の C1 誤り検出数とアドレスの表示	CD 時は C1 誤り検出数。(x3)
81	外周の C1 誤り検出数とアドレスの表示	CD 時は C1 誤り検出数。(x3)

5. Product Mode

5.1. Setting the product mode

※ The TUNER and AVAMP set to the product mode

- (1) Pressing the **◀◀** and SNOOZE buttons simultaneously, plug the AC cord into a power outlet This sets the product mode
- (2) After power supply turn on, the function is displayed
- (3) In the product mode
 - AUDYSSEY is turned OFF
 - Selecting DAB sets 227.36MHz (EK only)
 - Selecting XM displays "POWER CHECK" and 1kHz/ 20dBFS L+R is automatically detected for audio output
 - 1kHz/0dB (automatically becomes 1kHz/ 20dB), 1kHz/ 20dB, 1kHz/ 60dB and MUTE ON can be selected using the **▶▶** button (E3 only)
 - Pressing ALARM1 or ALARM2 outputs a BEEP tone Each time you have performed this operation, unplug the AC cord
- (4) Unplug AC cord to clear this mode

6. Version up Mode by DPMS

6.1. Setting the version up mode by DPMS

※ Version up by DPMS

- (1) Pressing and hold in the SLEEP and SOURCE buttons simultaneously, plug the AC cord into a power outlet This sets the DPMS version up mode
- (2) After power supply turn on, the function is displayed

7. Direct Version up Mode

7.1. Setting the direct version up mode

※ Versions are updated compulsorily using DPMS

- (1) Pressing the **◀◀** and ALARM SETTING buttons simultaneously, plug the AC cord into a power outlet This compulsorily sets the version up mode by DPMS
- (2) This is used when the system microcomputer fails during a version update or the system microcomputer does not start up

8. All segments is Turning on Mode

8.1. Setting the all segments is turning on mode

※ All segment of LCD and LED is turning on

- (1) Pressing the **▶▶** and ALARM SETTING buttons simultaneously, plug the AC cord into a power outlet This sets the all segments is turning on mode

9. EEPROM Check Mode

9.1. Setting the EEPROM check mode

※ Checking the EEPROM

- (1) Pressing the **▶▶** and SLEEP buttons simultaneously, plug the AC cord into a power outlet This sets the EEPROM mode

5. プロダクトモード

5.1. プロダクトモードの設定

※ TUNER,AVAMP をプロダクトモードにする。

- (1) 本体の **◀◀** ボタンと SNOOZE ボタンを同時に押しながら AC コードを接続すると、プロダクトモードが設定される。
- (2) 電源 ON 後はファンクション表示される。
- (3) プロダクトモードでは
 - AUDYSSEY を OFF にする。
 - DAB を選択すると 227.36MHz に設定する。(EK のみ)
 - XM を選択すると "POWER CHECK" を表示し、自動で 1kHz/20dB FS L+R を検出して音声出力する。
 - **▶▶** ボタンで 1kHz/0dB(自動で 1kHz/20dB になる)、1kHz/20dB、1kHz/60dB、MUTE ON を選択することができる。(E3 のみ)
 - ALARM1 または ALARM2 ボタンを押すと BEEP 音を出力する。尚、この操作を行った場合はその都度 AC コードを抜くこと。
- (4) AC コードを抜くことにより、プロダクトモードを解除する。

6. DPMS によるバージョンアップモード

6.1. DPMS によるバージョンアップモードの設定

※ DPMS を用いて、バージョンアップを行う。

- (1) 本体 SLEEP ボタンと SOURCE ボタンを同時に押しながら AC コードを接続すると、DPMS バージョンアップモードが設定される。
- (2) サーバー上に、セット内のバージョンよりも新しいバージョンが存在すれば、バージョンアップを開始する。

7. ダイレクトバージョンアップモード

7.1. ダイレクトバージョンアップモードの設定

※ DPMS を用いて、強制的にバージョンアップを行う。

- (1) 本体 **◀◀** ボタンと ALARM SETTING ボタン押しながら AC コードを接続すると、強制的に DPMS によるバージョンアップモードが設定される。
- (2) システムマイコンのバージョンアップを途中で失敗し、システムマイコンが起動しなくなった時に使用する。

8. 全点灯モード

8.1. 全点灯モードの設定

※ LCD 及び LED の全点灯を行う。

- (1) 本体 **▶▶** ボタンと ALARM SETTING ボタンを同時に押しながら AC コードを接続すると、全点灯モードが設定される。

9. EEPROM チェックモード

9.1. EEPROM チェックモードの設定

※ EEPROM のチェックを行う。

- (1) 本体 **▶▶** ボタンと SLEEP ボタンを同時に押しながら AC コードを接続すると、EEPROM のチェックモードが設定される。

TROUBLE SHOOTING

● **ADV-S52**

1. LCD doesn't display

(1) Check the Set up process of System μ-COM and BF(DSP)

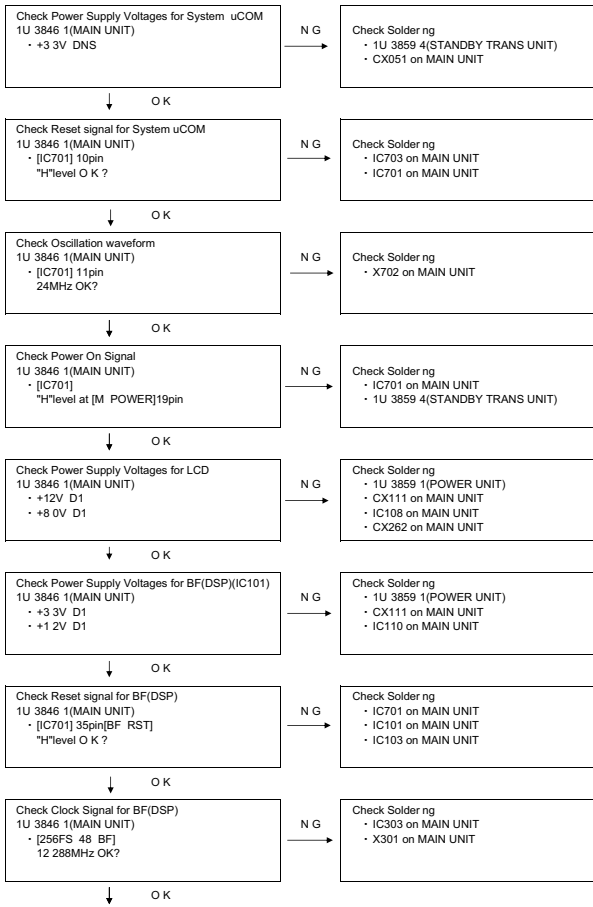

トラブルシューティング

● **ADV S52**

1. LCD表示せず

(1) システムμ-COMとBF(DSP)立ち上がりチェック工程

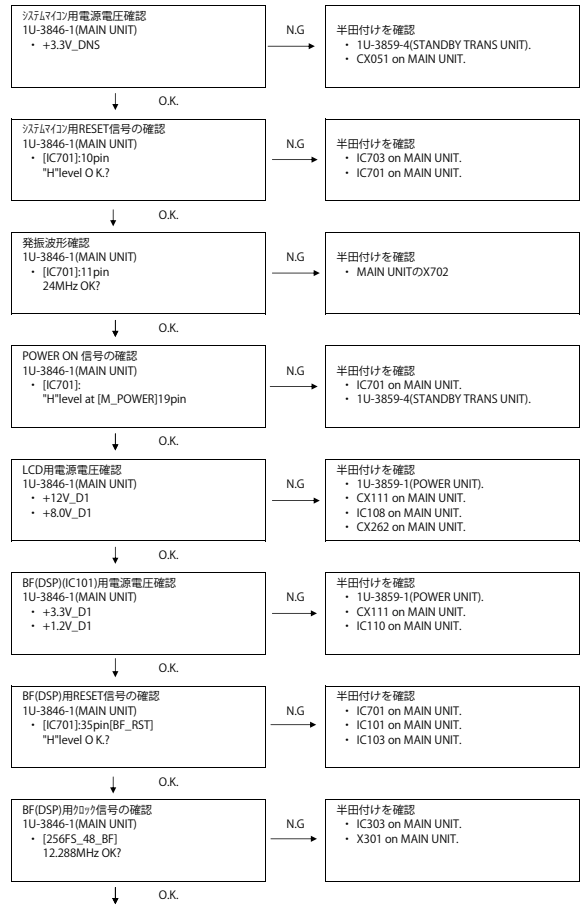

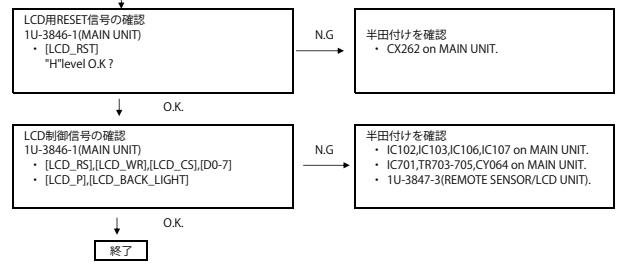
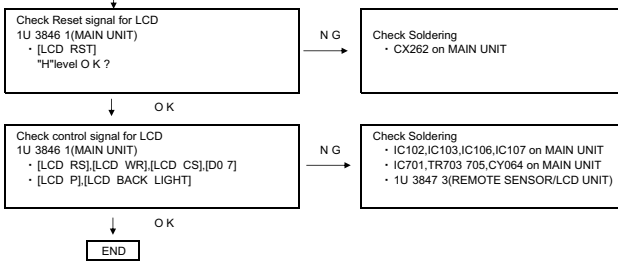

2. CD doesn't playback(S-52,S-52DAB only)

(1) Check the Set up process of BF(DSP) and FE Drive

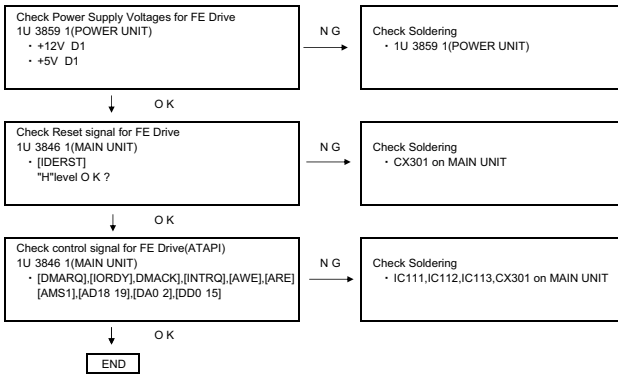

2. CD再生せず(S-52,S-52DABのみ)

(1) BF(DSP)とFEドライブ立ち上がりチェック工程

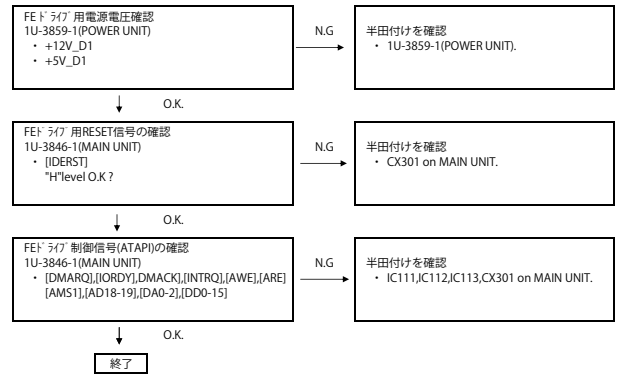

3. No Sound,Noise generated

(1) CD PLAY(S 52,S 52DAB only)

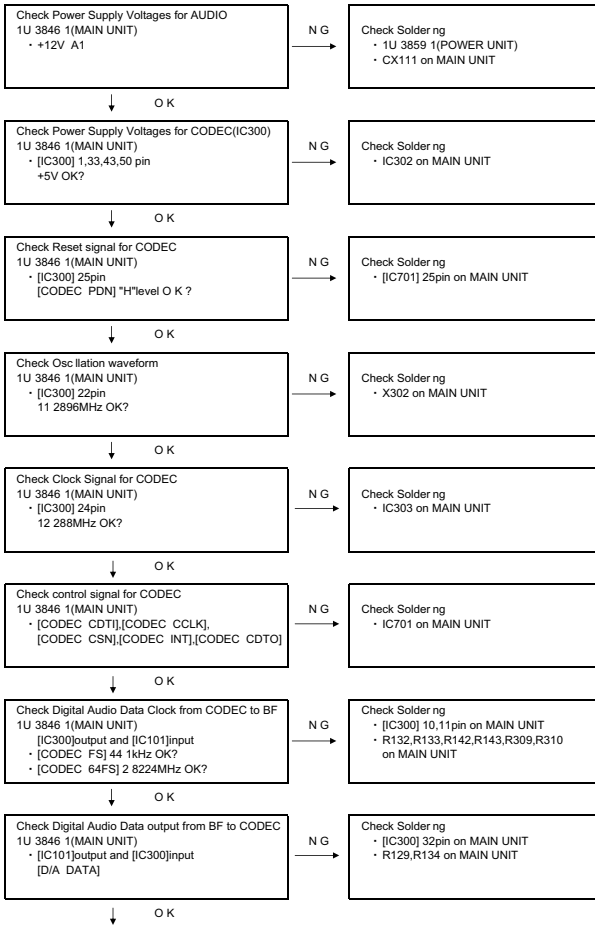

3. 音声出力せず、ノイズ発生

(1) CD 再生時(S-52,S-52DABのみ)

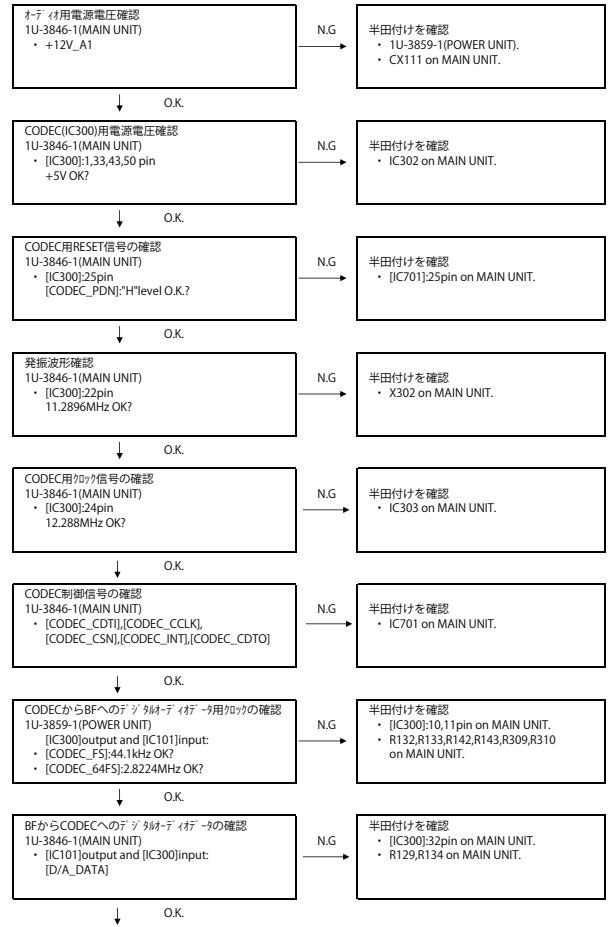

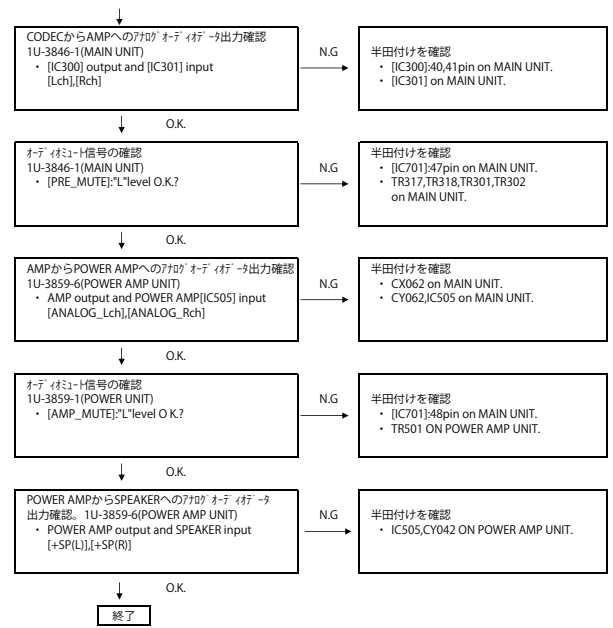
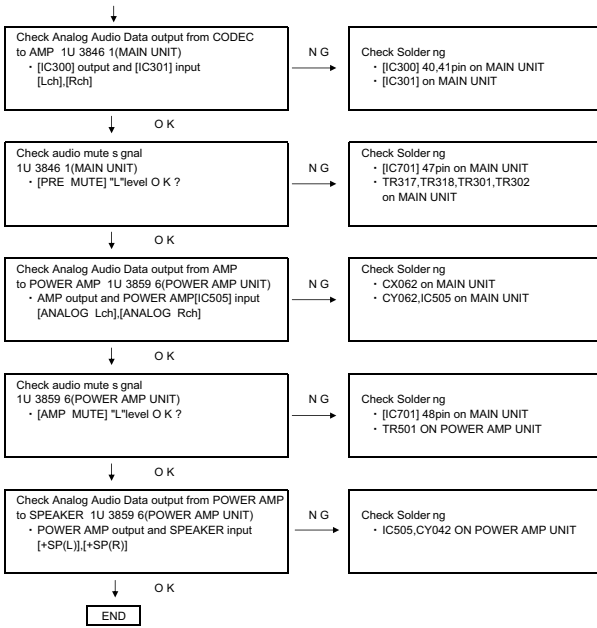

(2) AM/FM TUNER in(S 52E2JP,S 52DAB,S 32 only)

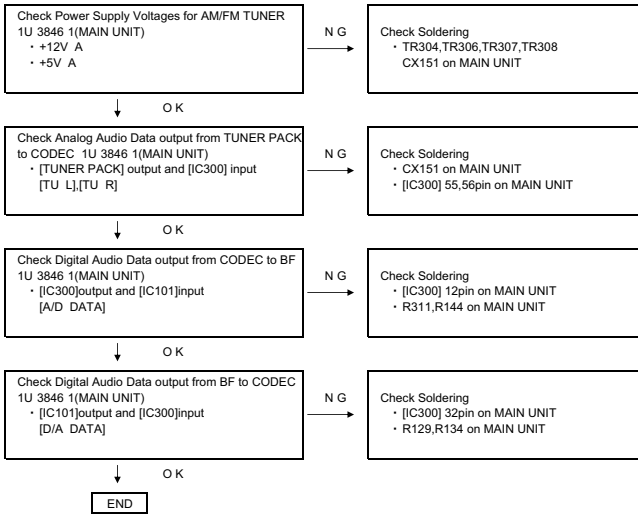

(3) Portable in(Front in)

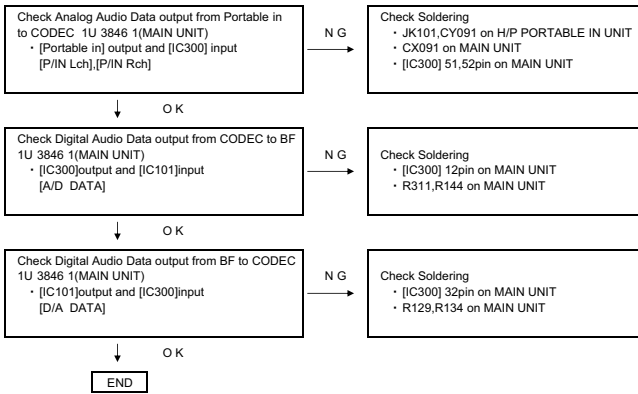

(2) AM/FM TUNER入力(S-52E2JP,S-52DAB,S-32のみ)

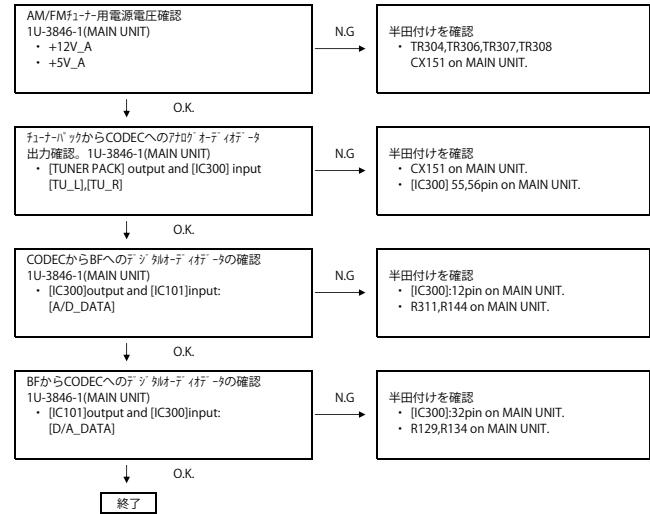

(3) Portable入力(Front入力)

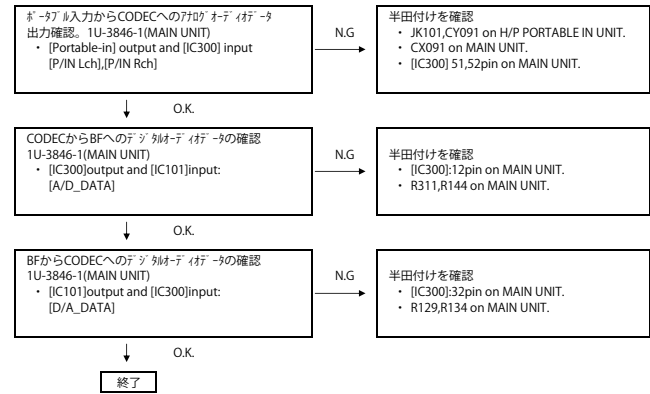

(4) IPOD IN

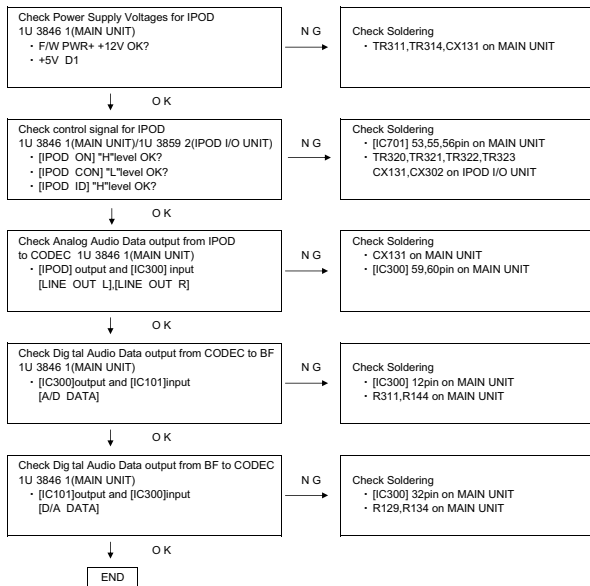

(4) IPOD入力

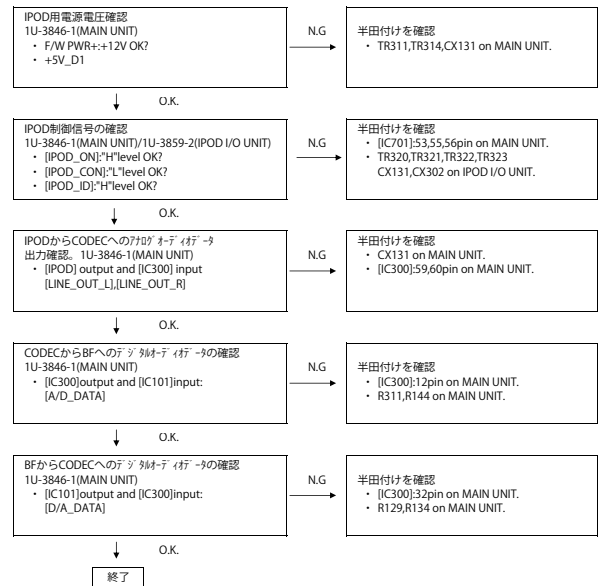

(5) HD RADIO in(S 52E3 only)

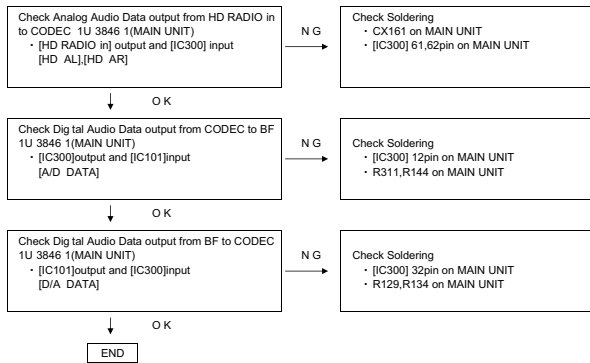

(5) HD RADIO入力(S-52E3のみ)

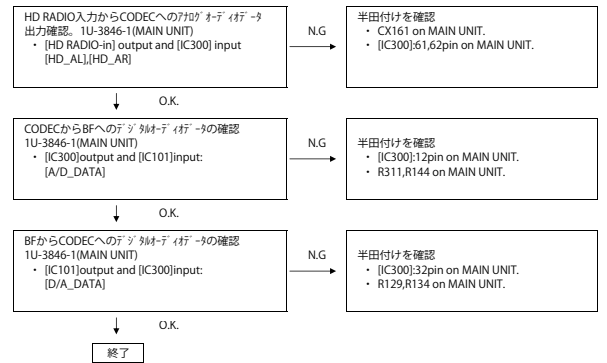

(6) XM RADIO In(S 52E3 only)

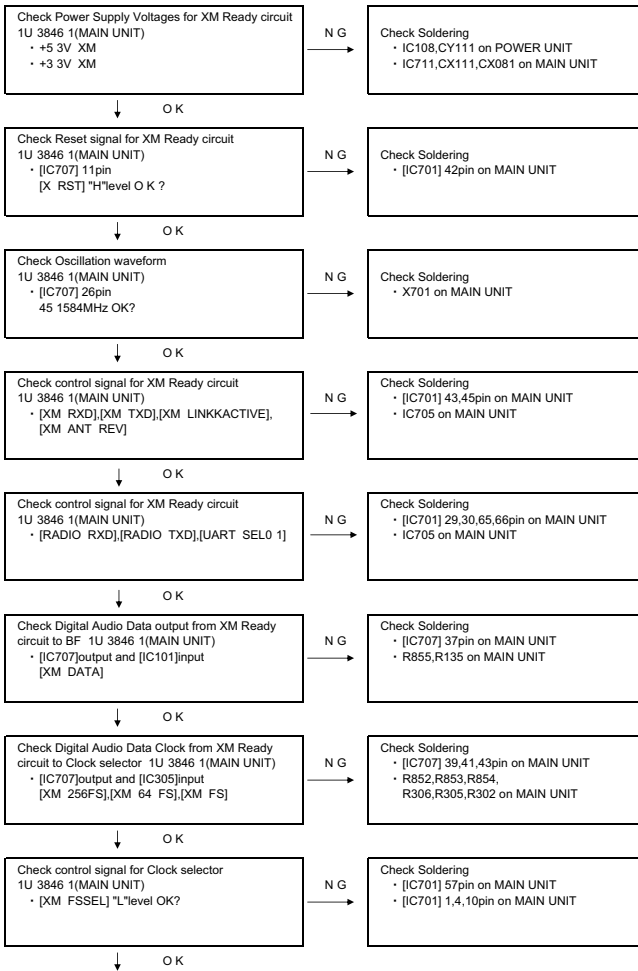

(6) XM RADIO入力(S-52E3のみ)

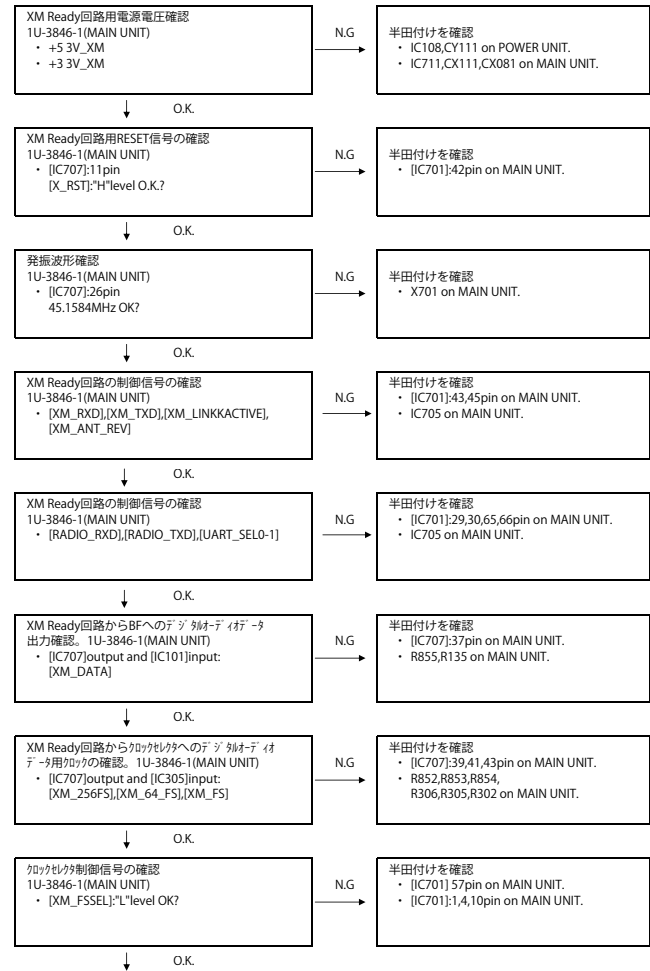

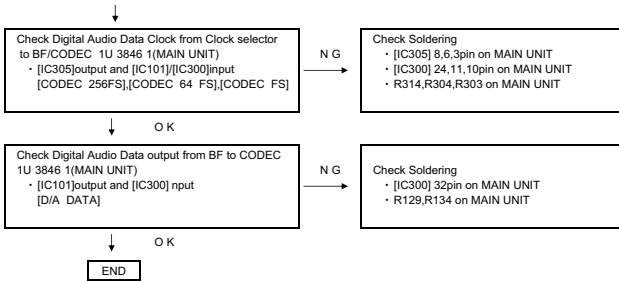

(7) DAB TUNER in(S-52DAB only)

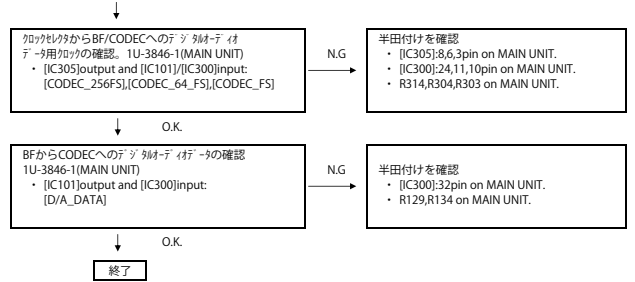
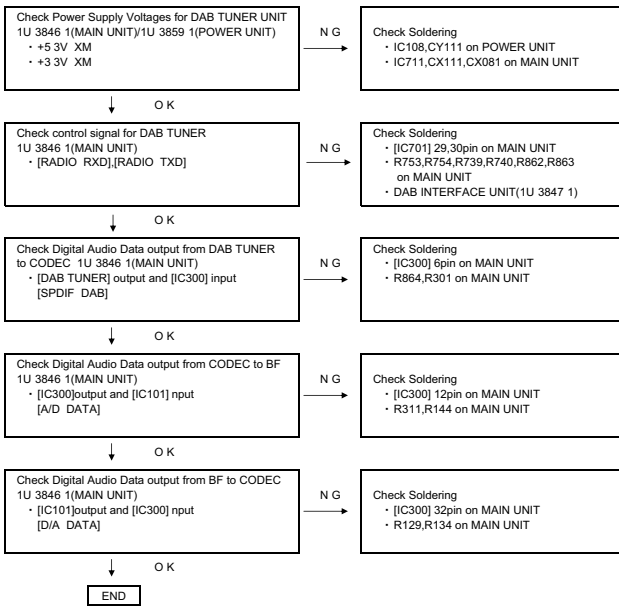

(7) DAB TUNER入力(S-52DABのみ)

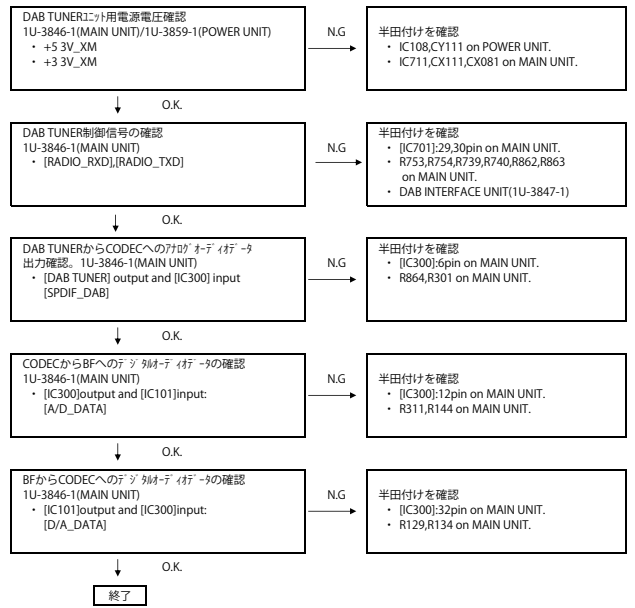

(8) ETHERNET in

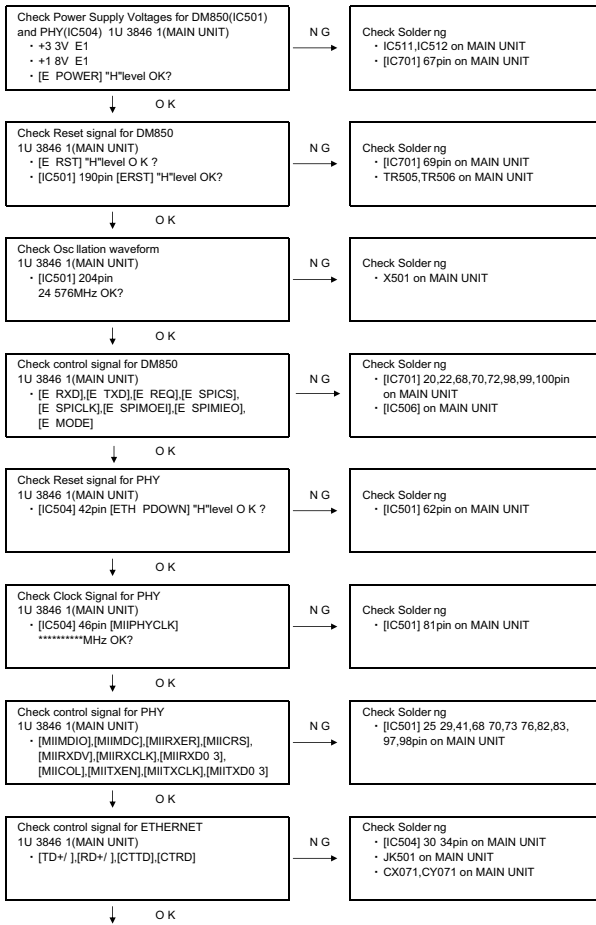

(8) ETHERNET入力

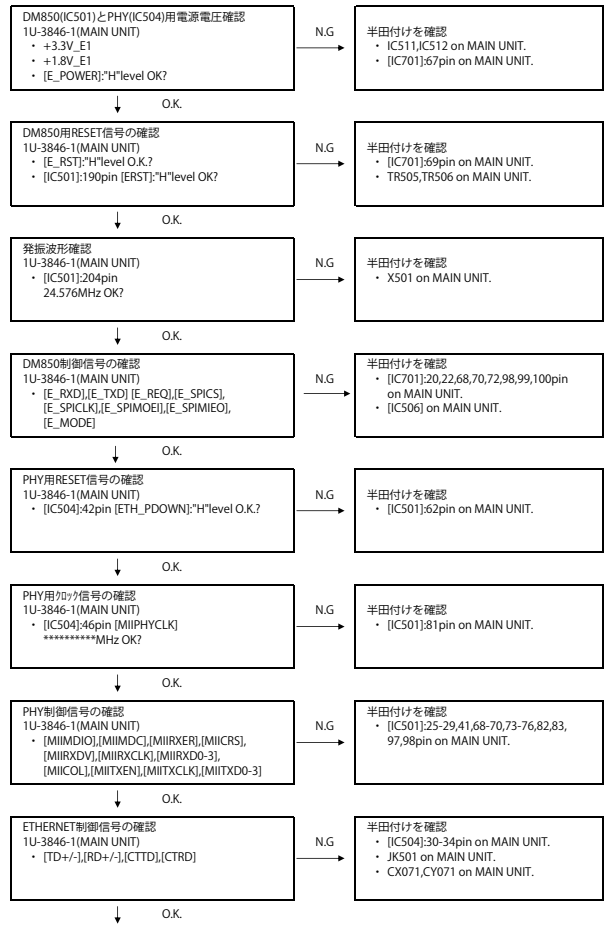

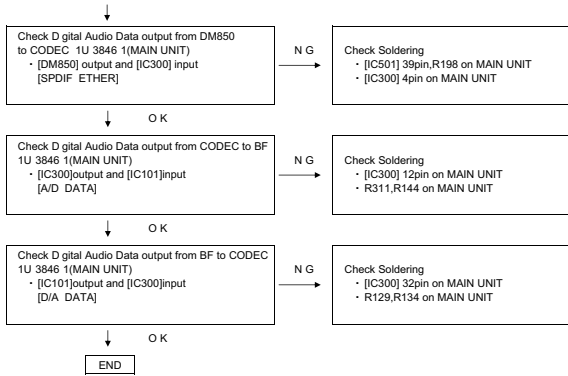

(9) USB in

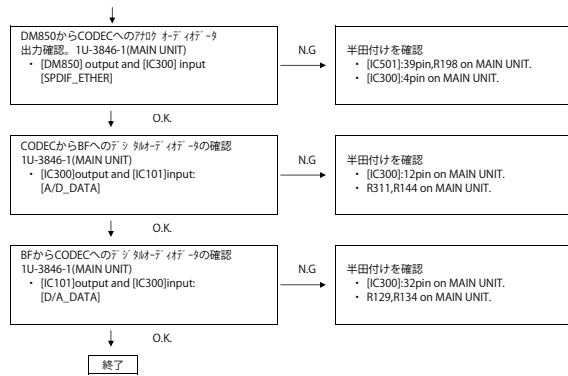
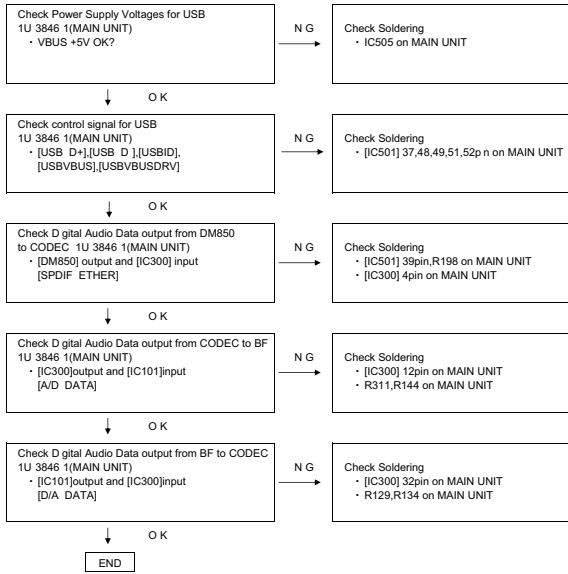

(9) USB入力

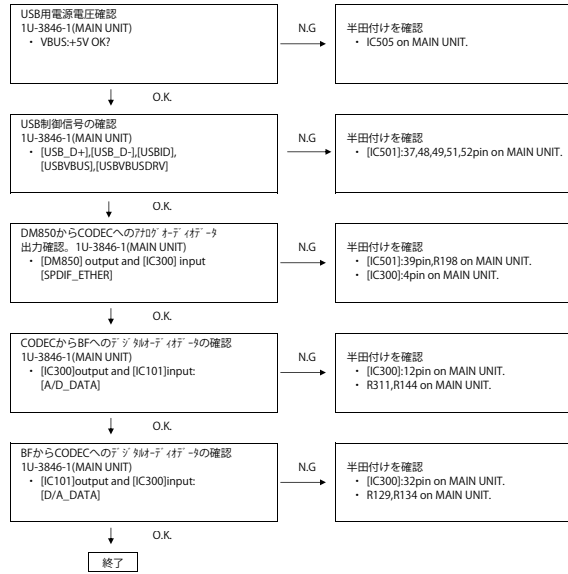

(10) WiFi in

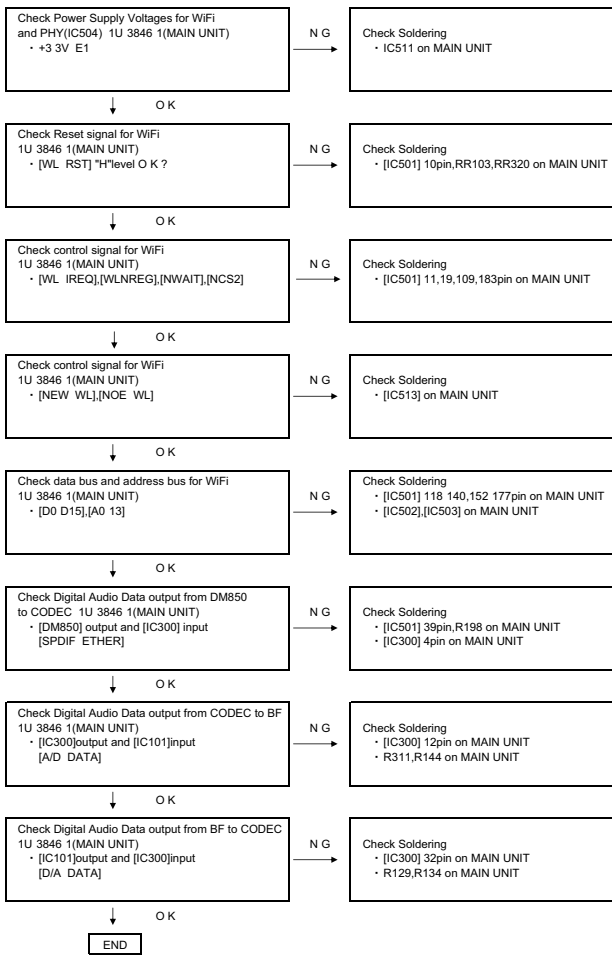

(10) WiFi入力

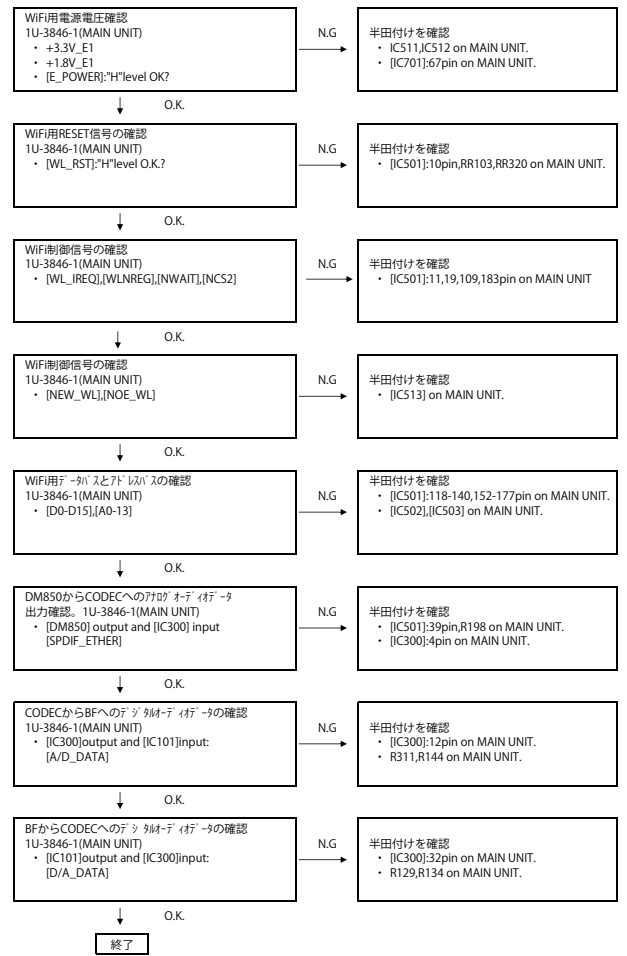

S52 SYSTEM PART BLOCK DIAGRAM

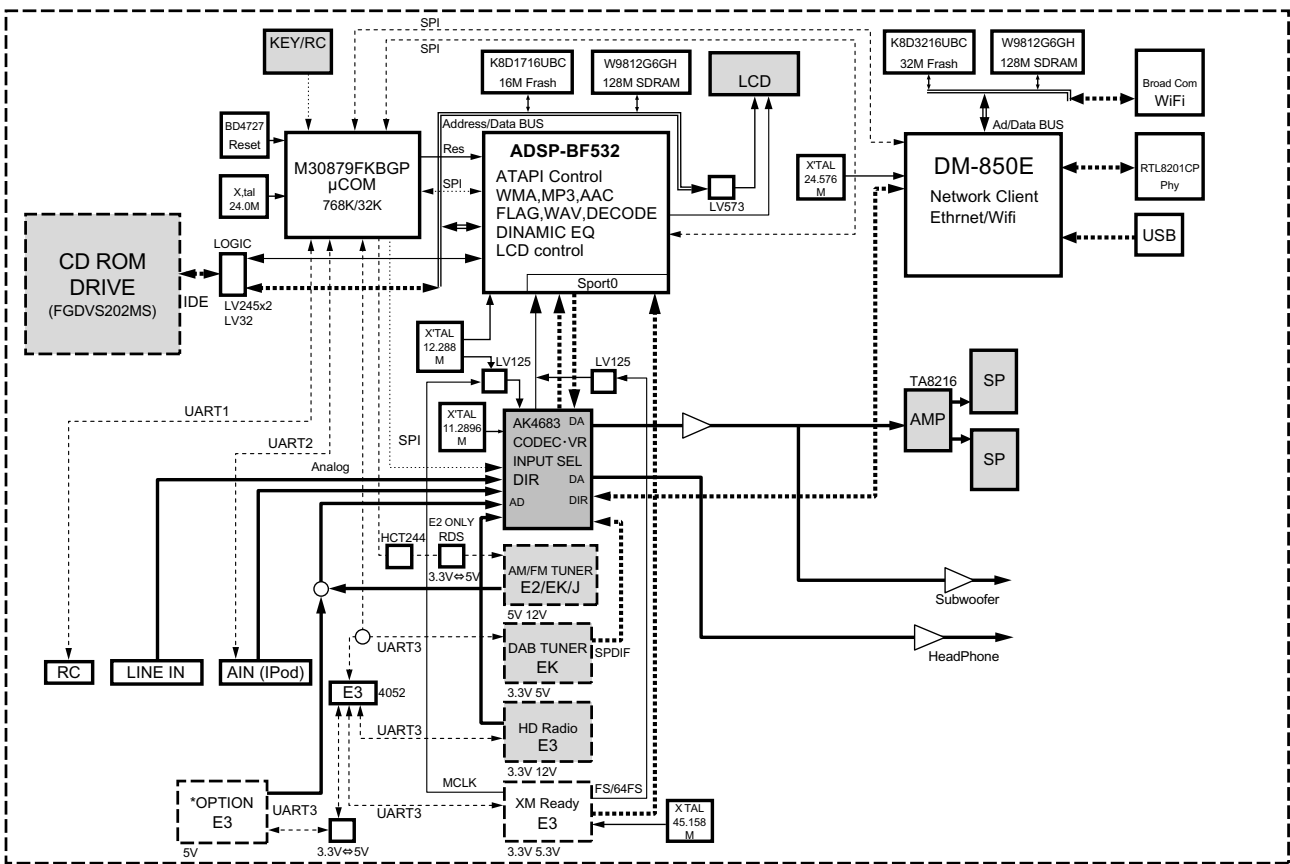

S32 SYSTEM PART BLOCK DIAGRAM

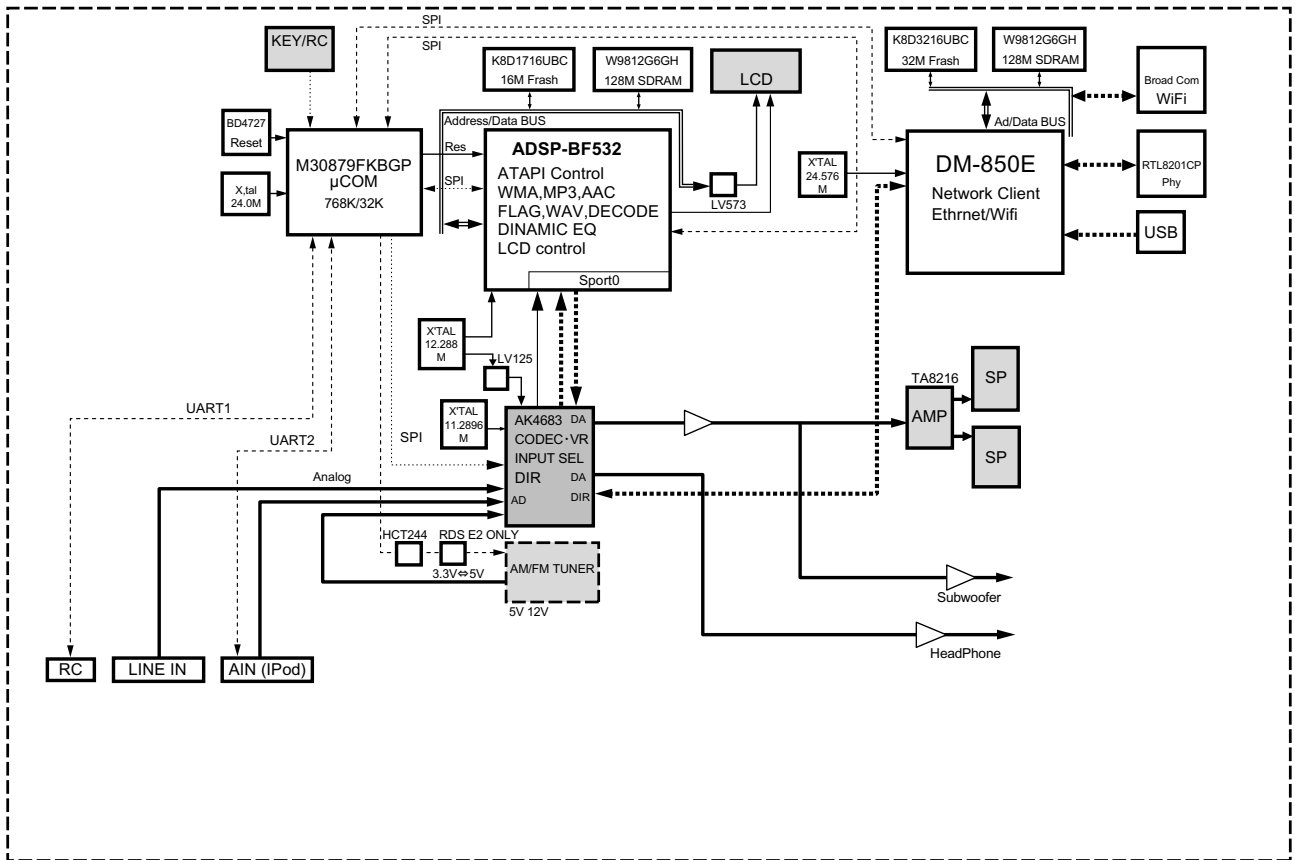

LEVEL DIAGRAM

DENON S52/S32 LEVEL DIAGRAM

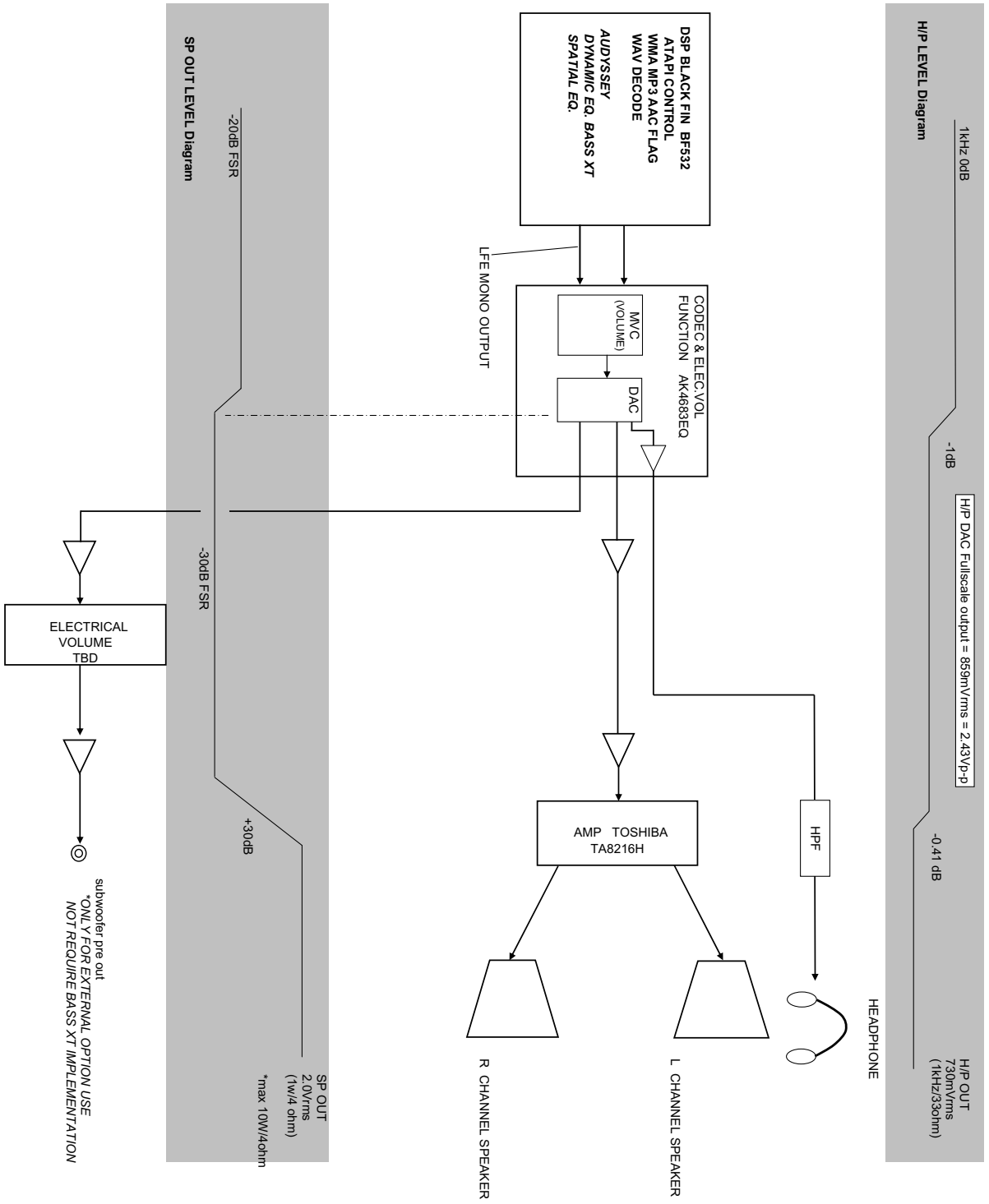

SEMICONDUCTORS

Only major semiconductors are shown, general semiconductors etc. are omitted to list.
 主な半導体を記載しています。汎用の半導体は記載を省略しています。

1. IC's

DM850E (IC502)

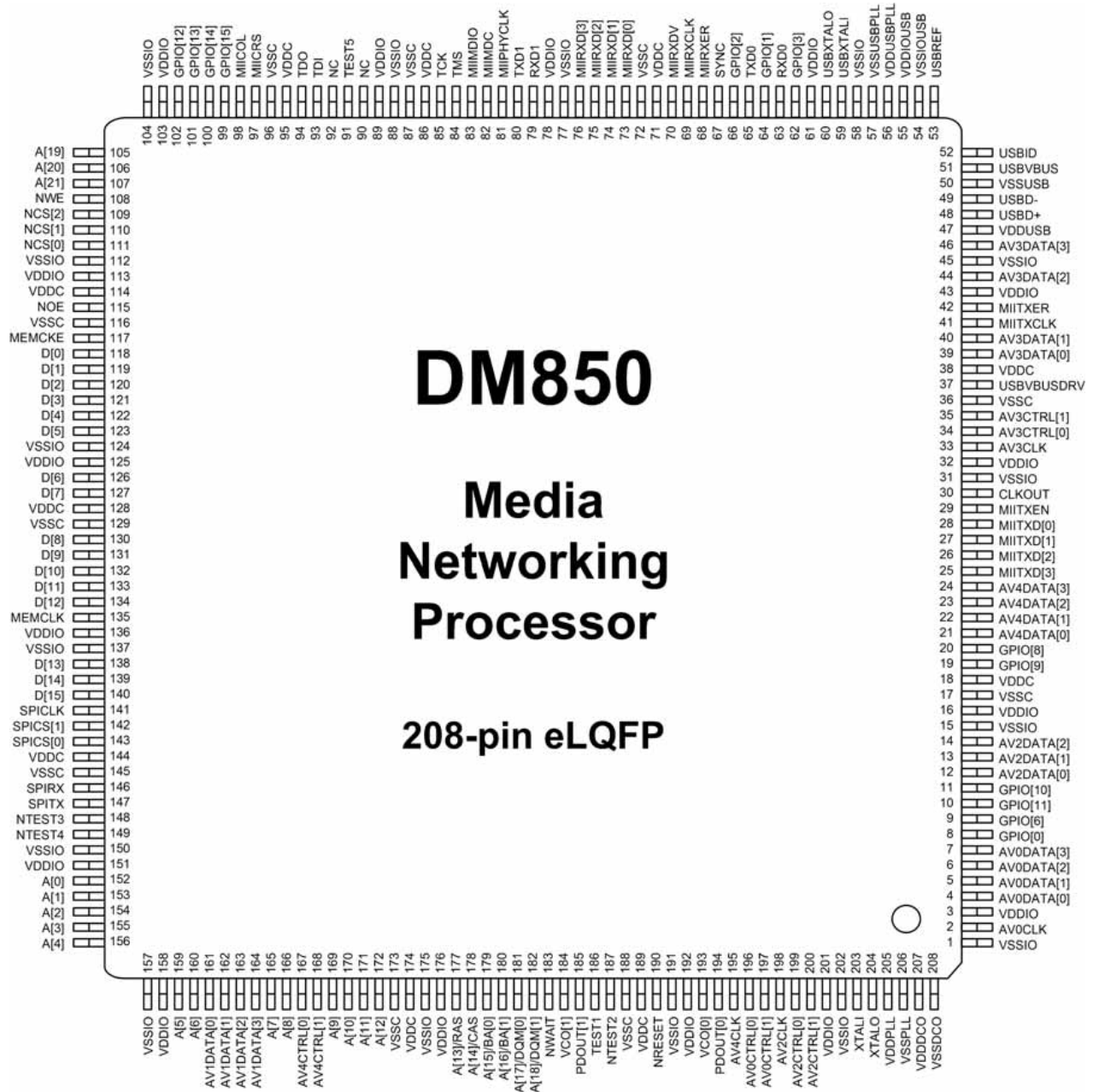

DM850E Pin Assignment by Pin Number

Pin	Name	Pin	Name	Pin	Name	Pin	Name
1	VSSIO	53	USBREF	105	A[19]	157	VSSIO
2	AV0CLK	54	VSSIOUSB	106	A[20]	158	VDDIO
3	VDDIO	55	VDDIOUSB	107	A[21]	159	A[5]
4	AV0DATA[0]	56	VDDUSBPLL	108	NWE	160	A[6]
5	AV0DATA[1]	57	VSSUSBPLL	109	NCS[2]	161	AV1DATA[0]
6	AV0DATA[2]	58	VSSIO	110	NCS[1]	162	AV1DATA[1]
7	AV0DATA[3]	59	USBXTALI	111	NCS[0]	163	AV1DATA[2]
8	GPIO[0]	60	USBXTALO	112	VSSIO	164	AV1DATA[3]
9	GPIO[6]	61	VDDIO	113	VDDIO	165	A[7]
10	GPIO[11]	62	GPIO[3]	114	VDDC	166	A[8]
11	GPIO[10]	63	RXD0	115	NOE	167	AV4CTRL[0]
12	AV2DATA[0]	64	GPIO[1]	116	VSSC	168	AV4CTRL[1]
13	AV2DATA[1]	65	TXD0	117	MEMCKE	169	A[9]
14	AV2DATA[2]	66	GPIO[2]	118	D[0]	170	A[10]
15	VSSIO	67	SYNC	119	D[1]	171	A[11]
16	VDDIO	68	MIIRXER	120	D[2]	172	A[12]
17	VSSC	69	MIIRXCLK	121	D[3]	173	VSSC
18	VDDC	70	MIIRXDV	122	D[4]	174	VDDC
19	GPIO[9]	71	VDDC	123	D[5]	175	VSSIO
20	GPIO[8]	72	VSSC	124	VSSIO	176	VDDIO
21	AV4DATA[0]	73	MIIRXD[0]	125	VDDIO	177	A[13]/RAS
22	AV4DATA[1]	74	MIIRXD[1]	126	D[6]	178	A[14]/CAS
23	AV4DATA[2]	75	MIIRXD[2]	127	D[7]	179	A[15]/BA[0]
24	AV4DATA[3]	76	MIIRXD[3]	128	VDDC	180	A[16]/BA[1]
25	MII TXD[3]	77	VSSIO	129	VSSC	181	A[17]/DQM[0]
26	MII TXD[2]	78	VDDIO	130	D[8]	182	A[18]/DQM[1]
27	MII TXD[1]	79	RXD1	131	D[9]	183	NWAIT
28	MII TXD[0]	80	TXD1	132	D[10]	184	VCO[1]
29	MII TXEN	81	MII PHYCLK	133	D[11]	185	PDOUT[1]
30	CLKOUT	82	MII DC	134	D[12]	186	TEST1
31	VSSIO	83	MII DIO	135	MEMCLK	187	NTEST2
32	VDDIO	84	TMS	136	VDDIO	188	VSSC
33	AV3CLK	85	TCK	137	VSSIO	189	VDDC
34	AV3CTRL[0]	86	VDDC	138	D[13]	190	NRESET
35	AV3CTRL[1]	87	VSSC	139	D[14]	191	VSSIO
36	VSSC	88	VSSIO	140	D[15]	192	VDDIO
37	USBVBSU DRV	89	VDDIO	141	SPICLK	193	VCO[0]
38	VDDC	90	NC	142	SPINCS[1]	194	PDOUT[0]
39	AV3DATA[0]	91	TEST5	143	SPINCS[0]	195	AV4CLK
40	AV3DATA[1]	92	NC	144	VDDC	196	AV0CTRL[0]
41	MII TXCLK	93	TDI	145	VSSC	197	AV0CTRL[1]
42	MII TXER	94	TDO	146	SPIMISO	198	AV2CLK
43	VDDIO	95	VDDC	147	SPIMOSI	199	AV2CTRL[0]
44	AV3DATA[2]	96	VSSC	148	NTEST3	200	AV2CTRL[1]
45	VSSIO	97	MII CRS	149	NTEST4	201	VDDIO
46	AV3DATA[3]	98	MII COL	150	VSSIO	202	VSSIO
47	VDDUSB	99	GPIO[15]	151	VDDIO	203	XTALI
48	USB D+	100	GPIO[14]	152	A[0]	204	XTALO
49	USB D-	101	GPIO[13]	153	A[1]	205	VDDPLL
50	VSSUSB	102	GPIO[12]	154	A[2]	206	VSSPLL
51	USBV BUS	103	VDDIO	155	A[3]	207	VDDDCO
52	USBID	104	VSSIO	156	A[4]	208	VSSDCO

ADSP-BF532 (IC101)

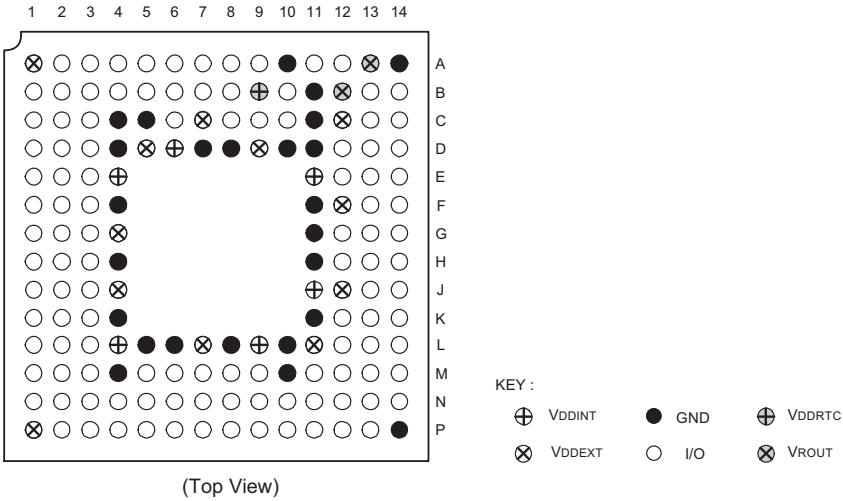

ADSP-BF532 Ball Number

Ball No.	Signal	Ball No.	Signal	Ball No.	Signal	Ball No.	Signal
A1	VDDEXT	C13	SMS	H1	DT0PRI	M3	TDI
A2	PF8	C14	SCAS	H2	DT0SEC	M4	GND
A3	PF9	D1	SCK	H3	TF50	M5	DATA12
A4	PF10	D2	PF0	H4	GND	M6	DATA9
A5	PF11	D3	MOSI	H11	GND	M7	DATA6
A6	PF14	D4	GND	H12	ABE1	M8	DATA3
A7	PPI2	D5	VDDEXT	H13	ABE0	M9	DATA0
A8	RTXO	D6	VDDINT	H14	AWE	M10	GND
A9	RTXI	D7	GND	J1	TSCLK0	M11	ADDR15
A10	GND	D8	GND	J2	DR0SEC	M12	ADDR9
A11	XTAL	D9	VDDEXT	J3	RF50	M13	ADDR10
A12	CLKIN	D10	GND	J4	VDDEXT	M14	ADDR11
A13	VROUT0	D11	GND	J11	VDDINT	N1	TRST
A14	GND	D12	SWE	J12	VDDEXT	N2	TMS
B1	PF4	D13	SRAS	J13	ADDR4	N3	TDO
B2	PF5	D14	BR	J14	ADDR1	N4	BMODE0
B3	PF6	E1	TFS1	K1	DR0PRI	N5	DATA13
B4	PF7	E2	MISO	K2	TMR2	N6	DATA10
B5	PF12	E3	DT1SEC	K3	TX	N7	DATA7
B6	PF13	E4	VDDINT	K4	GND	N8	DATA4
B7	PPI3	E11	VDDINT	K11	GND	N9	DATA1
B8	PPI1	E12	SA10	K12	ADDR7	N10	BGH
B9	VDDRTC	E13	ARDY	K13	ADDR5	N11	ADDR16
B10	NMI	E14	AMS0	K14	ADDR2	N12	ADDR14
B11	GND	F1	TSCLK1	L1	RSCLK0	N13	ADDR13
B12	VROUT1	F2	DT1PRI	L2	TMR0	N14	ADDR12
B13	SCKE	F3	DR1SEC	L3	RX	P1	VDDEXT
B14	CLKOUT	F4	GND	L4	VDDINT	P2	TCK
C1	PF1	F11	GND	L5	GND	P3	BMODE1
C2	PF2	F12	VDDEXT	L6	GND	P4	DATA15
C3	PF3	F13	AMS2	L7	VDDEXT	P5	DATA14
C4	GND	F14	AMS1	L8	GND	P6	DATA11
C5	GND	G1	RSCLK1	L9	VDDINT	P7	DATA8
C6	PF15	G2	RFS1	L10	GND	P8	DATA5
C7	VDDEXT	G3	DR1PRI	L11	VDDEXT	P9	DATA2
C8	PPI0	G4	VDDEXT	L12	ADDR8	P10	BG
C9	PPI_CLK	G11	GND	L13	ADDR6	P11	ADDR19
C10	RESET	G12	AMS3	L14	ADDR3	P12	ADDR18
C11	GND	G13	AOE	M1	TMR1	P13	ADDR17
C12	VDDEXT	G14	ARE	M2	EMU	P14	GND

M30879FKBGP (IC701)

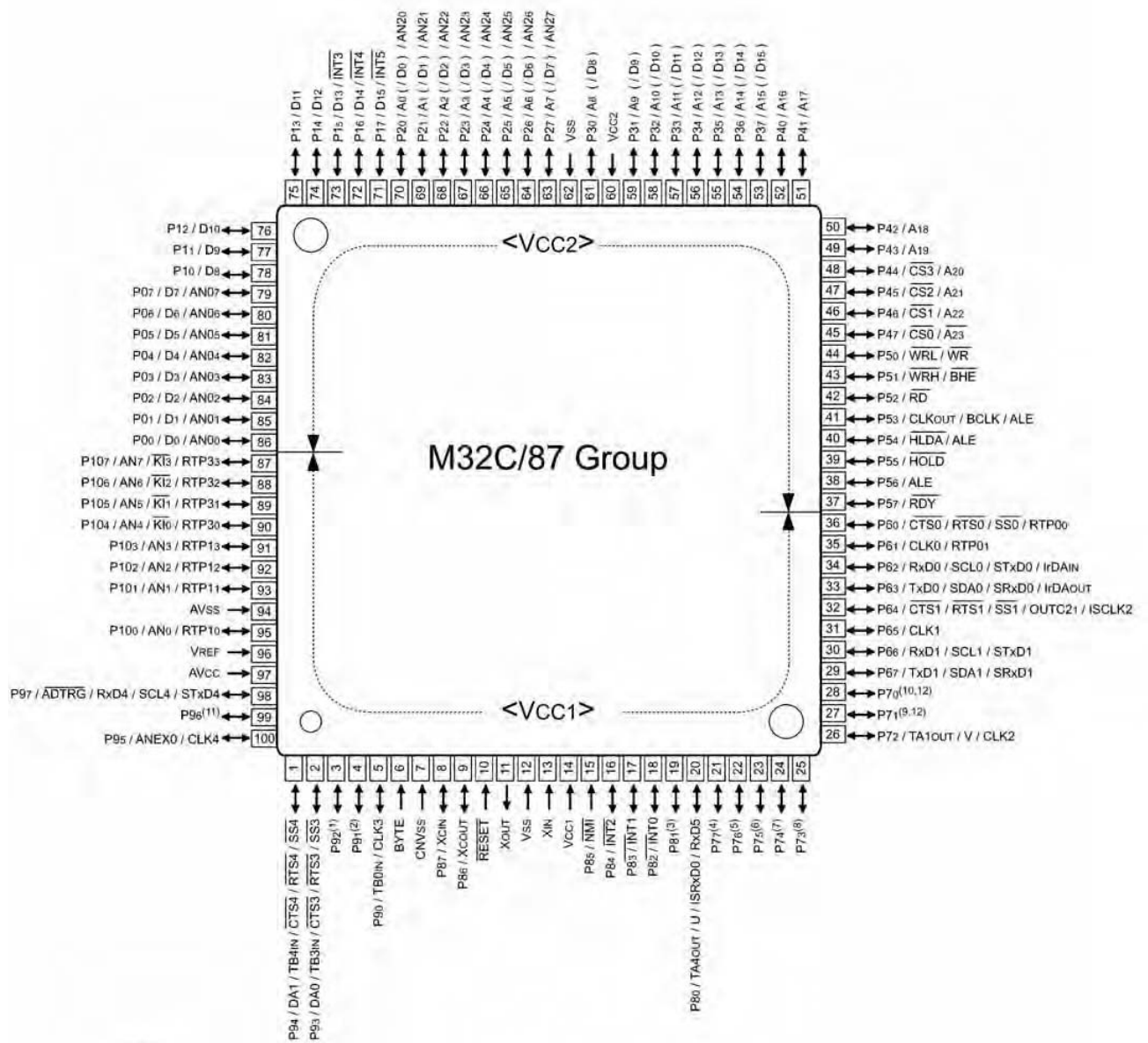

NOTES:

1. P92 / TB2IN / TxD3 / SDA3 / SRxD3 / OUTC20 / IEOUT / ISTxD2
2. P91 / TB1IN / RxD3 / SCL3 / STxD3 / IEIN / ISRxD2
3. P81 / TA4IN / \bar{D} / INPC15 / OUTC15 / CTSS / RTS5 / RTP23
4. P77 / TA3IN / CAN0IN / INPC14 / OUTC14 / ISCLK0 / CLK5 / RTP22
5. P76 / TA3OUT / CAN0OUT / INPC13 / OUTC13 / ISTxD0 / TxD5
6. P75 / TA2IN / \bar{W} / INPC12 / OUTC12 / ISRxD1 / RTP21
7. P74 / TA2OUT / \bar{W} / INPC11 / OUTC11 / ISCLK1 / RTP20
8. P73 / TA1IN / \bar{V} / CTS2 / RTS2 / SS2 / INPC10 / OUTC10 / ISTxD1
9. P71 / TA0IN / TB5IN / RxD2 / SCL2 / STxD2 / INPC17 / OUTC17 / OUTC22 / ISRxD2 / IEIN / RTP03
10. P70 / TA0OUT / TxD2 / SDA2 / SRxD2 / INPC16 / OUTC16 / OUTC20 / ISTxD2 / IEOUT / RTP02
11. P96 / ANEX1 / TxD4 / SDA4 / SRxD4
12. P70 and P71 are ports for the N-channel open drain output.

M30879FKBGP Pin Description

Classification	Symbol	I/O Type	Supply Voltage	Function
Power Supply	VCC1, VCC2 VSS	I I	—	Apply 3.0 to 5.5V to both VCC1 and VCC2 pins. Apply 0V to the VSS pin. $VCC1 \geq VCC2$
Analog Power Supply	AVCC AVSS	I I	VCC1	Supplies power to the A/D converter. Connect the AVCC pin to VCC1 and the AVSS pin to VSS
Reset Input	RESET	I	VCC1	The microcomputer is in a reset state when "L" is applied to the RESET pin
CNVSS	CNVSS	I	VCC1	Switches processor mode. Connect the CNVSS pin to VSS to start up in single-chip mode or to VCC1 to start up in microprocessor mode
Input to Switch External Data Bus Width	BYTE	I	VCC1	Switches data bus width in external memory space 3. The data bus is 16 bits wide when the BYTE pin is held "L" and 8 bits wide when it is held "H". Set to either. Connect the BYTE pin to VSS to use the microcomputer in single-chip mode
Bus Control Pins	D0 to D7	I/O	VCC2	Inputs and outputs data (D0 to D7) while accessing an external memory space with separate bus
	D8 to D15	I/O	VCC2	Inputs and outputs data (D8 to D15) while accessing an external memory space with 16-bit separate bus
	A0 to A22	O	VCC2	Outputs address bits A0 to A22
	A23	O	VCC2	Outputs inversed address bit A23
	A0/D0 to A7/D7	I/O	VCC2	Inputs and outputs data (D0 to D7) and outputs 8 low-order address bits (A0 to A7) by time-sharing while accessing an external memory space with multiplexed bus
	A8/D8 to A15/D15	I/O	VCC2	Inputs and outputs data (D8 to D15) and outputs 8 middle-order address bits (A8 to A15) by time-sharing while accessing an external memory space with 16-bit multiplexed bus
	CS0 to CS3	O	VCC2	Outputs CS0 to CS3 that are chip-select signals specifying an external space
	WRL / WR WRH / BHE RD	O	VCC2	Outputs WRL, WRH, (WR, BHE) and RD signals. WRL and WRH can be switched with WR and BHE by program. <ul style="list-style-type: none"> ■ WRL, WRH and RD selected: If external data bus is 16 bits wide, data is written to an even address in external memory space when \overline{WRL} is held "L". Data is written to an odd address when \overline{WRH} is held "L". Data is read when \overline{RD} is held "L". ■ WR, BHE and RD selected: Data is written to external memory space when \overline{WR} is held "L". Data in an external memory space is read when \overline{RD} is held "L". An odd address is accessed when \overline{BHE} is held "L". Select WR, BHE and RD for external 8-bit data bus
	ALE	O	VCC2	ALE is a signal latching the address
	HOLD	I	VCC2	The microcomputer is placed in a hold state while the \overline{HOLD} pin is held "L"
HLDA	O	VCC2	Outputs an "L" signal while the microcomputer is placed in a hold state	
RDY	I	VCC2	Bus is placed in a wait state while the RDY pin is held "L"	

I : Input O : Output I/O : Input and output

Classification	Symbol	I/O Type	Supply Voltage	Function
Reference Voltage Input	VREF	I	-	Supplies reference voltage to the A/D converter and D/A converter
A/D Converter	AN0 to AN7 AN00 to AN07 AN20 to AN27	I	VCC1	Analog input pins for the A/D converter
	ADTRG	I	VCC1	Input pin for an external A/D trigger
	ANEX0	I/O	VCC1	Extended analog input pin for the A/D converter and output pin in external op-amp connection mode
	ANEX1	I	VCC1	Extended analog input pin for the A/D converter
D/A Converter	DA0, DA1	O	VCC1	Output pin for the D/A converter
Intelligent I/O	INPC10 to INPC13	I	VCC1	Input pins for the time measurement function
	INPC14 to INPC17	I	VCC1	
	OUTC10 to OUTC13	O	VCC1	Output pins for the waveform generating function (OUTC16/OUTC20 and OUTC17/OUTC21 assigned to P70 and P71 are pins for the N-channel open drain output.)
	OUTC14 to OUTC17	O	VCC1	
	OUTC20 to OUTC22	O	VCC1	
	ISCLK0	I/O	VCC1	Inputs and outputs the clock for the intelligent I/O communication function
	ISCLK1,ISCLK2	I/O	VCC1	
	ISRxD0	I	VCC1	Inputs data for the intelligent I/O communication function
	ISRxD1,ISRxD2	I	VCC1	
	ISTxD0	O	VCC1	Outputs data for the intelligent I/O communication function (ISTxD2 assigned to P70 are pins for the N-channel open drain output.)
	ISTxD1,ISTxD2	O	VCC1	
	IEIN	I	VCC1	Inputs data for the intelligent I/O communication function
	IEOUT	O	VCC1	Outputs data for the intelligent I/O communication function (IEOUT assigned to P70 are pins for the N-channel open drain output.)
CAN	CAN0in,CAN1in	I	VCC1	Input pin for the CAN communication function
	CAN0out,CAN1out	O	VCC1	Output pin for the CAN communication function
	CAN1WU	I	VCC1	Input pin for the CAN1 wake-up interrupt
Real-Time Ports	RTP00 to RTP03 RTP10 to RTP13 RTP20 to RTP23 RTP30 to RTP33	O	VCC1	Output port working as the real-time ports (RTP02 and RTP03 are ports for the N-channel open drain output.)
I/O Ports	P00 to P07 P10 to P17 P20 to P27 P30 to P37 P40 to P47 P50 to P57	I/O	VCC2	8-bit I/O ports in CMOS. Each port can be programmed to input or output under the control of the direction register. An input port can be set, by program, for a pull-up resistor available or for no pull-up resistor available in 4-bit units
	P60 to P67 P70 to P77 P90 to P97 P100 to P107	I/O	VCC1	8-bit I/O ports having equivalent functions to P0 (P70 and P71 are ports for the N-channel open drain output.)
	P80 to P84 P86, P87	I/O	VCC1	I/O ports having equivalent functions to P0
	Input Port	P85	I	VCC1

I : Input O : Output I/O : Input and output

Classification	Symbol	I/O Type	Supply Voltage	Function
Key Input Interrupt	KI0 to KI3	I	VCC1	Input pins for the key input interrupt
IrDA	IrDAIN	I	VCC1	Input pin for IrDA serial data
	IrDAOUT	O	VCC1	Output pin for IrDA serial data
INT Interrupt Input	INT6 to INT8	I	VCC1	Input pins for the INT interrupt
Serial I/O	CTS6	I	VCC1/VCC2	Input pins for data transmission control
	RTS6	O	VCC1/VCC2	Output pins for data reception control
	CLK6	I/O	VCC1/VCC2	Inputs and outputs the transfer clock
	RXD6	I	VCC1/VCC2	Inputs serial data
	TXD6	O	VCC1/VCC2	Outputs serial data
Intelligent I/O	OUTC23 to OUTC27	O	VCC2	Output pins for the waveform generating function
A/D Converter	AN150 to AN157	I	VCC1	Analog input pins for the A/D converter
I/O Ports	P110 to P114 P120 to P127 P130 to P137	I/O	VCC2	I/O ports having equivalent functions to P0
	P140 to P146 P150 to P157	I/O	VCC1	I/O ports having equivalent functions to P0

I : Input O : Output I/O : Input and output

AK4683EQ (IC300)

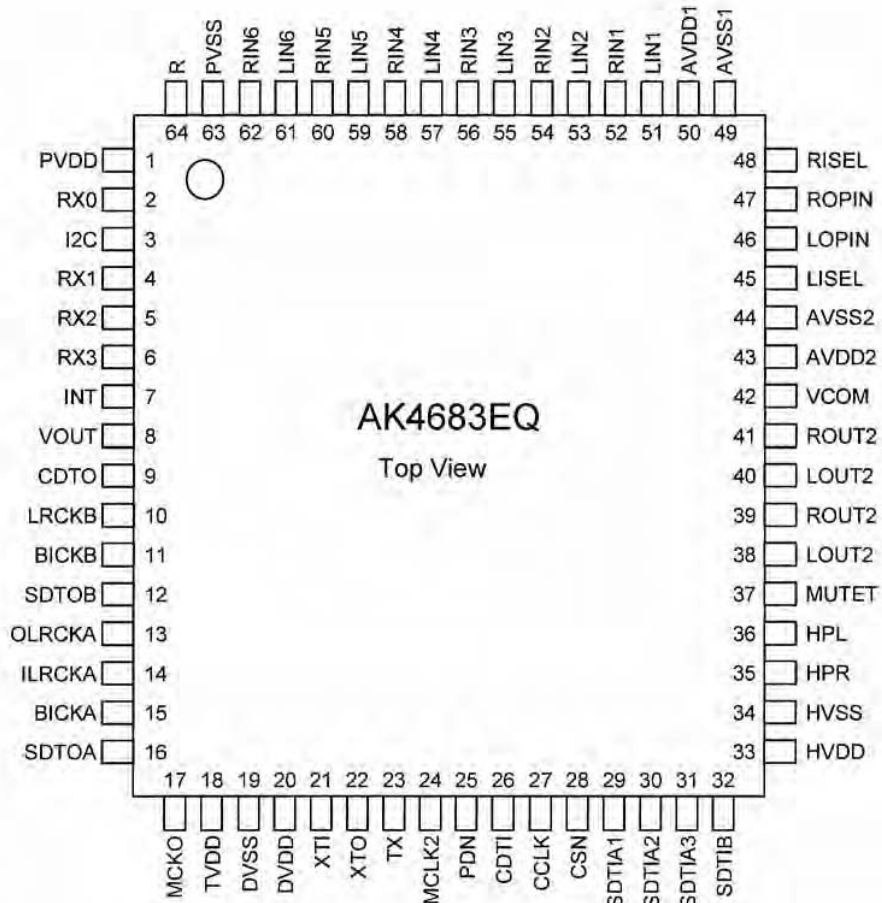

AK4683WQ Pin Function

No.	Pin Name	I/O	Function
1	PVDD	-	PLL Power supply Pin, 4.5V~5.5V
2	RX0	I	Receiver Channel 0 Pin (Internal biased pin. Internally biased at PVDD/2)
3	I2C	I	Control Mode Select Pin. “L”: 4-wire Serial, “H”: I ² C Bus
4	RX1	I	Receiver Channel 1 Pin
5	RX2	I	Receiver Channel 2 Pin
6	RX3	I	Receiver Channel 3 Pin
7	INT	O	Interrupt Pin
8	VOUT	O	V-bit Output Pin for Receiver Input
	DZF	O	Zero Input Detect Pin When the input data of DAC follow total 8192 LRCK cycles with “0” input data, this pin goes to “H”. And when RSTN1 bit is “0”, PWDA bit is “0”, this pin goes to “H”.
	OVF	O	Analog Input Overflow Detect Pin This pin goes to “H” if the analog input of Lch or Rch overflows.
9	CDTO	O	Control Data Output Pin in Serial Mode and I2C pin = “L”.
10	LRCKB	I/O	Channel Clock B Pin
11	BICKB	I/O	Audio Serial Data Clock B Pin
12	SDTOB	O	Audio Serial Data Output B Pin
13	OLRCKA	I/O	Output Channel Clock A Pin
14	ILRCKA	I/O	Input Channel Clock A Pin
15	BICKA	I/O	Audio Serial Data Clock A Pin
16	SDTOA	O	Audio Serial Data Output A Pin
17	MCKO	O	Master Clock Output Pin
18	TVDD	-	Output Buffer Power Supply Pin, 2.7V~5.5V
19	DVSS	-	Digital Ground Pin, 0V
20	DVDD	-	Digital Power Supply Pin, 4.5V~5.5V
21	XTI	I	X'tal Input Pin
22	XTO	O	X'tal Output Pin
23	TX	O	Transmit Channel Output pin When DIT bit = “0”, RX0~3 Through. When DIT bit = “1”, Internal DIT Output.
24	MCLK2	I	Master Clock Input Pin
25	PDN	I	Power-Down Mode & Reset Pin When “L”, the AK4683 is powered-down, all registers are reset. And then all digital output pins go “L”. The AK4683 must be reset once upon power-up.
26	CDTI	I	Control Data Input Pin in Serial Mode and I2C pin = “L”.
	SDA	I/O	Control Data Pin in Serial Mode and I2C pin = “H”.
27	CCLK	I	Control Data Clock Pin in Serial Mode and I2C pin = “L”
	SCL	I	Control Data Clock Pin in Serial Mode and I2C pin = “H”
28	CSN	I	Chip Select Pin in Serial Mode and I2C pin = “L”.
	TEST	I	This pin should be connected to DVSS in Serial Mode and I2C pin = “H”.
29	SDTIA1	I	Audio Serial Data Input A1 Pin
30	SDTIA2	I	Audio Serial Data Input A2 Pin
31	SDTIA3	I	Audio Serial Data Input A3 Pin
32	SDTIB	I	Audio Serial Data Input B Pin
33	HVDD	-	HP Power Supply Pin, 4.5V~5.5V
34	HVSS	-	HP Ground Pin, 0V
35	HPR	O	HP Rch Output Pin
36	HPL	O	HP Lch Output Pin
37	MUTET	-	HP Common Voltage Output Pin 1μF capacitor should be connected to HVSS externally.

No.	Pin Name	I/O	Function
38	LOUT2	O	DAC2 Lch Positive Analog Output Pin
39	ROUT2	O	DAC2 Rch Positive Analog Output Pin
40	LOUT1	O	DAC1 Lch Positive Analog Output Pin
41	ROUT1	O	DAC1 Rch Positive Analog Output Pin
42	VCOM	-	DAC/ADC Common Voltage Output Pin 2.2μF capacitor should be connected to AVSS2 externally.
43	AVDD2	-	DAC Power Supply Pin, 4.5V~5.5V
44	AVSS2	-	DAC Ground Pin, 0V
45	LISEL	O	Lch Feedback Resistor Output Pin
46	LOPIN	O	Lch Feedback Resistor Input Pin. 0.5 x AVDD1.
47	ROPIN	O	Rch Feedback Resistor Input Pin. 0.5 x AVDD1.
48	RISEL	O	Rch Feedback Resistor Output Pin
49	AVSS1	-	ADC Ground Pin, 0V
50	AVDD1	-	ADC Power Supply Pin, 4.5V~5.5V
51	LIN1	I	Lch Input 1 Pin
52	RIN1	I	Rch Input 1 Pin
53	LIN2	I	Lch Input 2 Pin
54	RIN2	I	Rch Input 2 Pin
55	LIN3	I	Lch Input 3 Pin
56	RIN3	I	Rch Input 3 Pin
57	LIN4	I	Lch Input 4 Pin
58	RIN4	I	Rch Input 4 Pin
59	LIN5	I	Lch Input 5 Pin
60	RIN5	I	Rch Input 5 Pin
61	LIN6	I	Lch Input 6 Pin
62	RIN6	I	Rch Input 6 Pin
63	PVSS	-	PLL Ground pin
64	R	-	External Resistor Pin 12kΩ +/-1% resistor should be connected to PVSS externally.

Note: All input pins except internal biased pin (RX0) and analog input pins (LIN1-6, RIN1-6) should not be left floating.

■ Handling of Unused Pin

The unused I/O pins should be processed appropriately as below.

Classification	Pin Name	Setting
Analog	RX0, LOUT1-2, ROUT1-2, LIN1-6, RIN1-6	These pins should be open.
Digital	INT, XTO, MCKO, VOUT/DZF/OVF, SDTOA-B, CDTO, TX	These pins should be open.
	RX1-3, CSN, CCLK, CDTI, XTI, MCLK2, OLRCKA, ILRCKA, BICKA, SDTIA1-3, LRCKB, BICKB, SDTIB	These pins should be connected to DVSS.

1U-3846 MAIN P.W.B. UNIT (2/2)

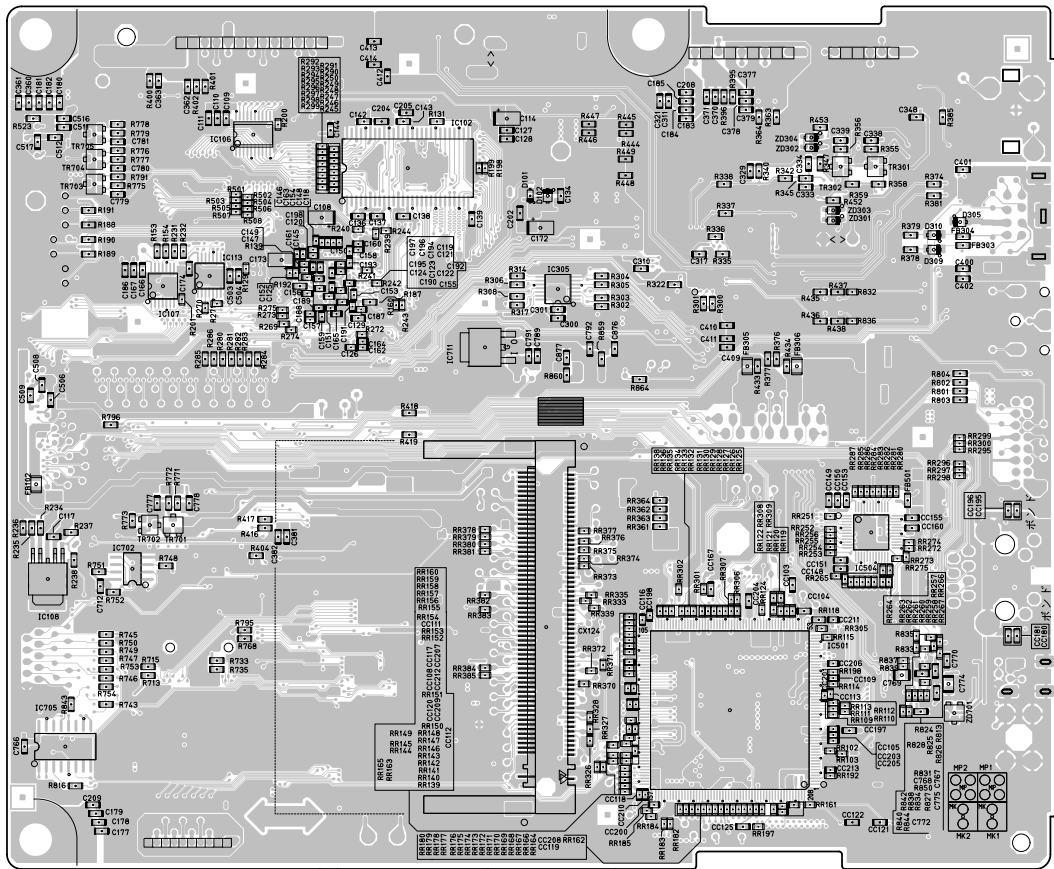

FOIL SIDE

1U-3847 VIDEO P.W.B. UNIT (1/2)

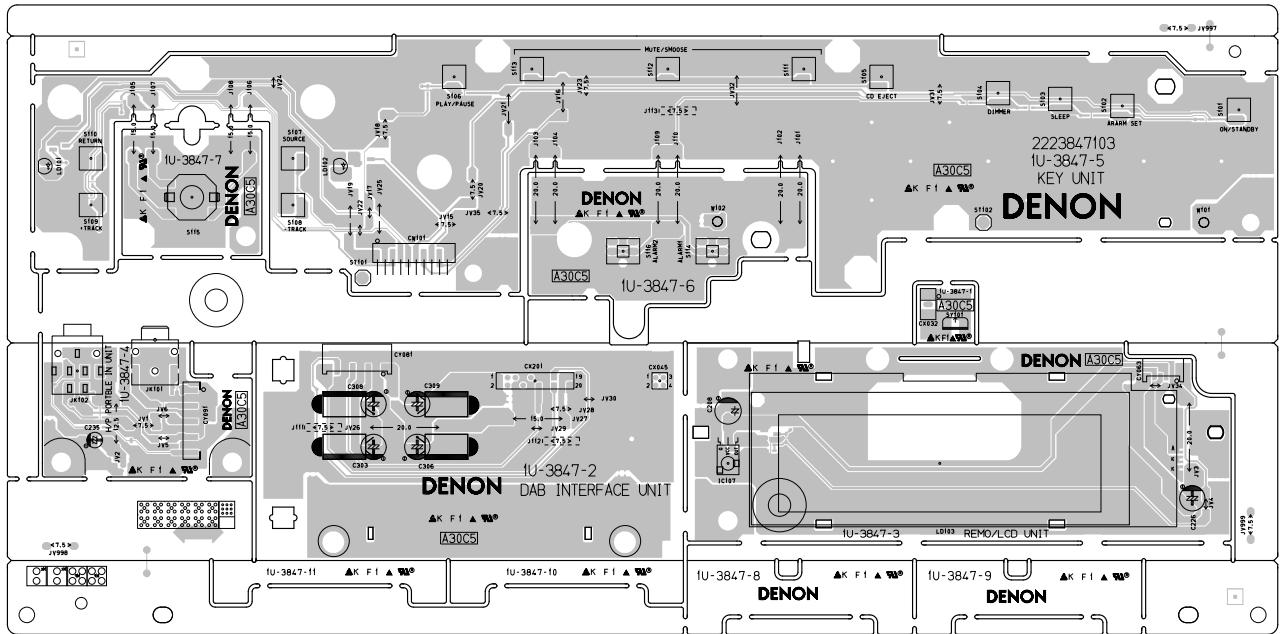

COMPONENT SIDE

1U-3847 VIDEO P.W.B. UNIT (2/2)

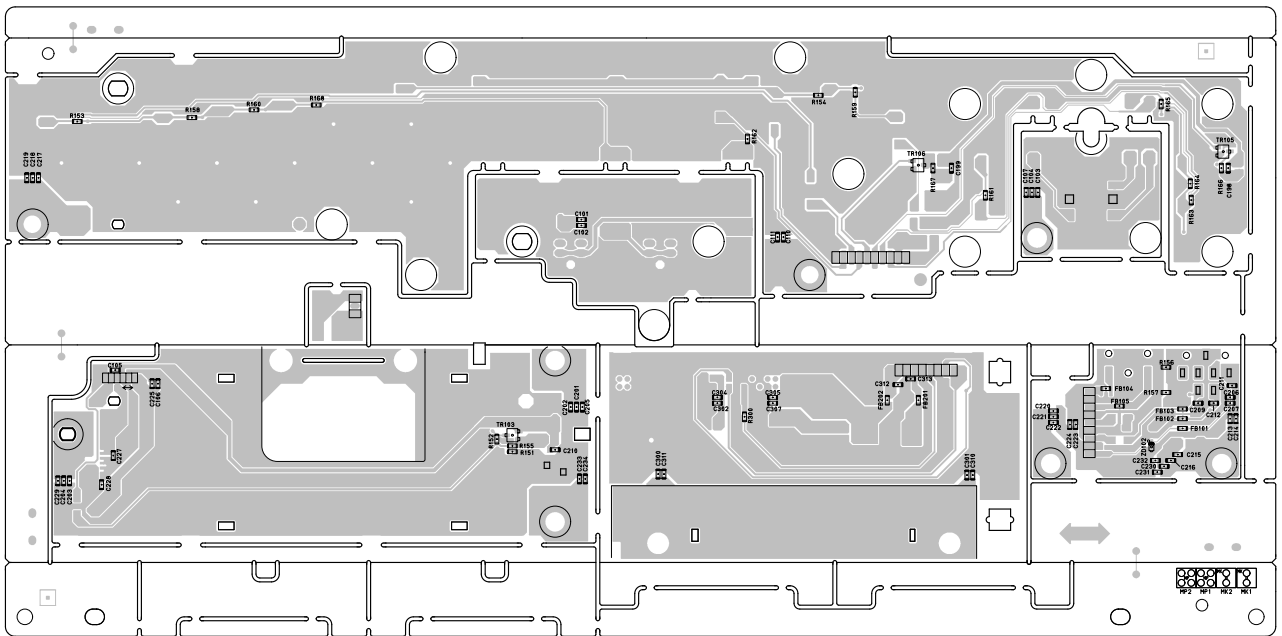

FOIL SIDE

1U-3851 L.PWR/DISP P.W.B. UNIT (1/2)

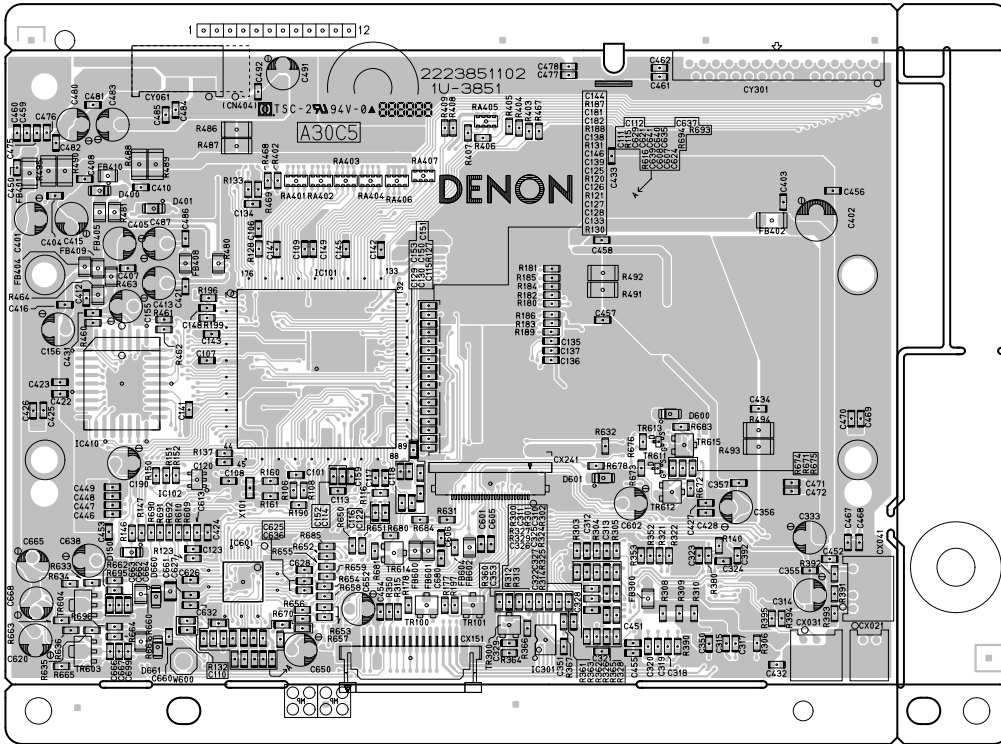

1U-3851 L.PWR/DISP P.W.B. UNIT (2/2)

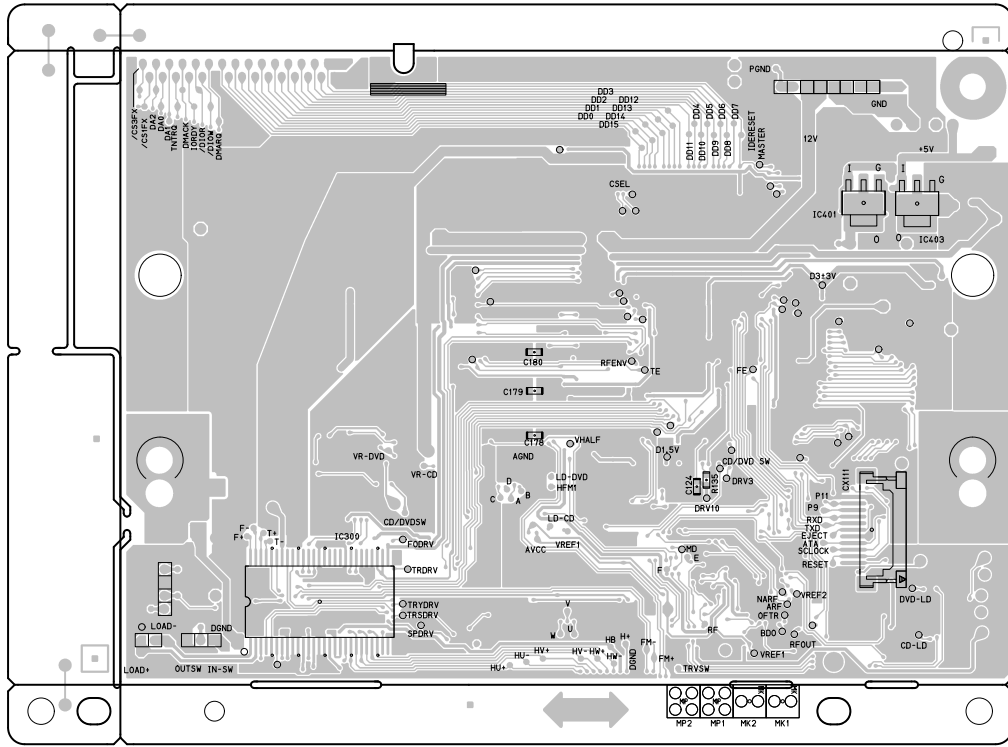

FOIL SIDE

1U-3859 D.AMP/SMPS P.W.B. UNIT (2/2)

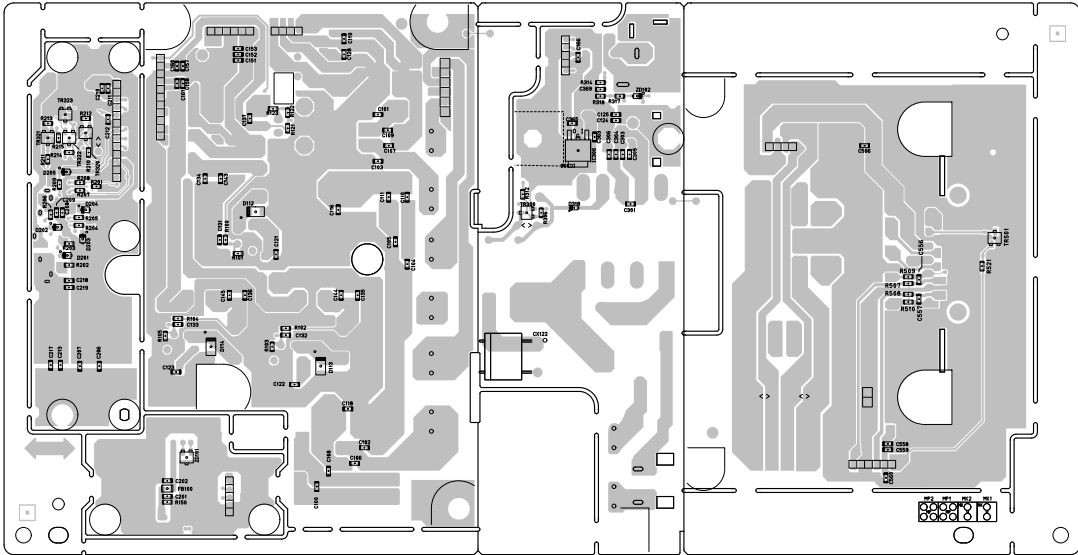

FOIL SIDE

NOTE FOR PARTS LIST

- Parts for which "nsp" is indicated on this table cannot be supplied.
- When ordering of part, clearly indicate "1" and "I" (i) to avoid mis supplying.
- Ordering part without stating its part number can not be supplied.
- Part indicated with the mark "★" is not illustrated in the exploded view.
- Not including General purpose Carbon Film Resistor in the P.W.Board parts list. (Refer to the Schematic Diagram for those parts.)
- Not including General purpose Carbon Chip Resistor in the P.W.Board parts list. (Refer to the Schematic Diagram for those parts.)

WARNING:
Parts marked with this symbol \triangle have critical characteristics.
Use ONLY replacement parts recommended by the manufacturer.

● Resistors

Ex.: RN 14K 2E 182 G FR

Type	Shape and performance	Power	Resistance	Allowable error	Others
RD : Carbon RC : Composition RS : Metal oxide film RW : Winding RN : Metal film RK : Metal mixture	2B : 1/8W 2E : 1/4W 2H : 1/2W 3A : 1W 3D : 2W 3F : 3W 3H : 5W	F : ±1% G : ±2% J : ±5% K : ±10% M : ±20%	P : Pulse-resistant type NL : Low noise type NB : Non-burning type FR : Fuse-resistor F : Lead wire forming		

*** Resistance**

1 8 2 ⇒ 1800 ohm = 1.8 kohm
Indicates number of zeros after effective number.
2-digit effective number.

• Units: ohm

1 R 2 ⇒ 1.2 ohm
1-digit effective number.
2-digit effective number, decimal point indicated by R.

• Units: ohm

● Capacitors

Ex.: CE 04W 1H 2R2 M BP

Type	Shape and performance	Dielectric strength	Capacity	Allowable error	Others
CE : Aluminum foil electrolytic CA : Aluminum solid electrolytic CS : Tantalum electrolytic CQ : Film CK : Ceramic CC : Ceramic CP : Oil CM : Mica CF : Metallized CH : Metallized	0J : 6.3V 1A : 10V 1C : 16V 1E : 25V 1V : 35V 2A : 100V 2B : 125V 2C : 160V 2D : 200V 2E : 250V 2H : 500V 2J : 630V	F : ±1% G : ±2% J : ±5% K : ±10% M : ±20% Z : +80%	HS : High stability type BP : Non-polar type HR : Ripple-resistant type DL : For change and discharge HF : For assuring high frequency U : UL part C : CSA part W : UL-CSA type F : Lead wire forming		

*** Capacity (electrolyte only)**

2 2 2 ⇒ 2200μF
Indicates number of zeros after effective number.
2-digit effective number.

• Units: μF.

2 R 2 ⇒ 2.2μF
1-digit effective number.
2-digit effective number, decimal point indicated by R.

• Units: μF.

*** Capacity (except electrolyte)**

2 2 2 ⇒ 2200pF=0.0022μF
Indicates number of zeros after effective number.
(More than 2) 2-digit effective number.

• Units: pF.

2 2 1 ⇒ 220pF
Indicates number of zeros after effective number.
(0 or 1) 2-digit effective number.

• Units: pF.

• When the dielectric strength is indicated in AC, "AC" is included after the dielectric strength value.

部品表について

- 部品表に "nsp" と記載されている部品は供給できません。
- 部品を発注する際は特に数字の "1" と英字の "I" との区別をはっきり記入してください。
- 部品番号を表示していない部品は供給できません。
- \triangle 印の部品は安全上重要な部品です。交換するときは、安全および性能維持のため必ず指定の部品をご使用ください。
- ★印のついている部品は分解図中には記載していません。
- 汎用カーボン抵抗器は記載していません。定数は回路図を参照願います。
- 汎用カーボンチップ抵抗器は記載していません。定数は回路図を参照願います。
- 部品表の抵抗器、コンデンサの品名記号の読み方は表を参照してください。

●抵抗器

例)

RN	14K	2E	182	G	FR
種類	形状特性	電力	抵抗値	許容差	その他
RD : カーボン RC : 固定体 RS : 金属系皮膜 RW : 巻線 RN : 金属皮膜 RK : 金属混合体	2B : 1/8 W 2E : 1/4 W 2H : 1/2 W 3A : 1 W 3D : 2 W 3F : 3 W 3H : 5 W	F : ±1% G : ±2% J : ±5% K : ±10% M : ±20%	P : 耐パルス形 NL : 低雑音形 NB : 不燃形 FR : ヒューズ抵抗 F : リード線成形		

*** 抵抗値**

1 8 2 ⇒ 1800Ω=1.8kΩ
有効数字につづく0の数を表わす。
2桁の有効数字を表わす。

1 R 2 ⇒ 1.2Ω
1桁の有効数字を表わす。
2桁の有効数字で小数点はRで表わす。
: 単位はΩ

●コンデンサ

例)

CE	04W	1H	2R2	M	BP
種類	形状特性	耐圧	容量	許容差	その他
CE : アルミ箔電解 CA : アルミ固体電解 CS : タンタル電解 CQ : フィルム CK : セラミック CP : オイル CM : マイカ CF : メタライズド CH : メタライズド	0J : 6.3 V 1A : 10 V 1C : 16 V 1E : 25 V 1V : 35 V 2A : 100 V 2B : 125 V 2C : 160 V 2D : 200 V 2E : 250 V 2H : 500 V 2J : 630 V	F : ±1% G : ±2% J : ±5% K : ±10% M : ±20% Z : +80% -20%	HS : 高安定形 BP : 無極性形 HR : 耐リップル形 DL : 充放電対策用 HF : 高周波保証用 U : UL 部品 C : CSA 部品 W : UL-CSA 部品 F : リード線成形		

*** 容量値**

● 電解コンデンサの場合

2 2 2 ⇒ 2200μF
有効数字につづく0の数を表わす。
2桁の有効数字を表わす。
: 単位はμF

2 R 2 ⇒ 2.2μF
1桁の有効数字を表わす。
2桁の有効数字で小数点はRで表わす。
: 単位はμF

● 電解コンデンサ以外の場合

2 2 2 ⇒ 2200pF=0.0022μF
有効数字につづく0の数を表わす。
(0の数以上の場合)
2桁の有効数字を表わす。
: 単位はpF

2 2 1 ⇒ 220pF
有効数字につづく0の数を表わす。
(0の数が0または1の場合)
2桁の有効数字を表わす。
: 単位はpF

● 耐圧を交流で表示する場合は、耐圧表示の次に「AC」を表示します。

PARTS LIST OF P.W.B. UNIT

- * 本表に "nsp" と記載されている部品は供給できません。
- * Parts for which "nsp" is indicated on this table cannot be supplied.
- * 本表に記載されている部品は、補修用部品のため製品に使用している部品とは一部、形状、寸法などが異なる場合があります。
- * The parts listed below are for maintenance only, might differ from the parts used in the unit in appearances or dimensions.

Note: The symbols in the column "Remarks" indicate the following destinations.
 E3 : U.S.A. & Canada model E2 : Europe model EK : U.K. model JP : Japan model

1U-3846 MAIN P.W.B. UNIT ASS'Y

Ref. No.	Part No.	Part Name	Remarks	Q'ty	New
SEMICONDUCTORS GROUP					
IC101	nsp	ADSP-BF532SBBCZC11			*
IC102	00D 262 3685 004	W9812G6GH-6			
IC103	00D GEN 8694 -00	DSP ROM ASSY (K8D1716UBC-PI07)	for S-52E2/DABEK,S-32E2		*
IC103	00D GEN 8694 -01	DSP ROM ASSY (K8D1716UBC-PI07)	for S-52JP		
IC103	00D GEN 8694 -02	DSP ROM ASSY (K8D1716UBC-PI07)	for S-52E3,S-32E3		
IC106	00D 262 2642 909	SN74LV573APWR +REF			
IC107	00D 262 2729 903	SN74LV02APW-EL2 +C			
IC108	00D 263 1236 908	BA00BCOWFP			
IC110	00D 262 3400 904	TPC6103			
IC111,112	00D 262 2640 901	SN74LV245APW-EL2	for S-52		
IC113	00D 262 2516 909	SN74LV32APW-EL2 +C	for S-52		
IC300	00D 262 3762 008	AK4683EQ			*
IC301	00D 263 0615 902	BA15218F-DXE2 +C			
IC302	00D 262 2977 933	BA50BC0FP-E2			
IC303	00D 262 1953 903	TC7WU04F +C			
IC304	00D 263 0615 902	BA15218F-DXE2 +C			
IC305	00D 262 2785 905	SN74LV125APWRG4 +C	for S-52E3		
IC306	00D 262 3360 905	LC72722PM-TLM	for S-52E2/DABEK,S-32E2		
IC307	00D 262 2953 902	SN74HCT244APW +C			
IC308	00D 262 2517 908	SN74LV08APW-EL2 +REF			
IC501	00D 262 3523 108	BCOIC-DM850E-CQL			
IC502	00D GEN 8695 -00	DM850 ROM ASSY (K8D3216UBC-PI07)	for S-52E2/DABEK		
IC502	00D GEN 8695 -01	DM850 ROM ASSY (K8D3216UBC-PI07)	for S-32E2		
IC502	00D GEN 8695 -02	DM850 ROM ASSY (K8D3216UBC-PI07)	for S-52JP		
IC502	00D GEN 8695 -04	DM850 ROM ASSY (K8D3216UBC-PI07)	for S-52E3		
IC502	00D GEN 8695 -05	DM850 ROM ASSY (K8D3216UBC-PI07)	for S-32E3		
IC503	00D 262 3685 004	W9812G6GH-6			
IC504	00D 262 3712 003	RTL8201CP			
IC505	00D 262 3522 905	MIC2025-1YM	for S-52		
IC506	00D 262 3412 905	TC74VHC14FT			
IC511	00D 263 1290 902	BA33DD0WHFP			
IC512	00D 263 1110 901	PQ070XZ01ZP +C			
IC513	00D 262 2516 909	SN74LV32APW-EL2 +C			
IC701	00D GEN 8693 -00	S52/S32 SYS ROM ASSY (M30879FKBGP)	for S-52E2/DABEK,S-32E2		*
IC701	00D GEN 8693 -01	S52/S32 SYS ROM ASSY (M30879FKBGP)	for S-52JP		
IC701	00D GEN 8693 -02	S52/S32 SYS ROM ASSY (M30879FKBGP)	for S-52E3,S-32E3		
IC702	00D 262 3707 908	BR25L640F-WE2			
IC703	235 010 0075 07S	BD4727G 2.7V RESET IC			
IC705	00D 262 2643 908	TC4052BF(TAPE)	for S-52E3		

ご注意:
 ファームウェアをアップデートするときは、SDIで最終バージョンを確認して下さい。サービス基板はアップデートして使用下さい。

NOTE:
 When update Firmware, please confirm a last version in SDI. Use the service board after updating it.

ご注意:
 ファームウェアをアップデートするときは、SDIで最終バージョンを確認して下さい。サービス基板はアップデートして使用下さい。

NOTE:
 When update Firmware, please confirm a last version in SDI. Use the service board after updating it.

Ref. No.	Part No.	Part Name	Remarks	Q'ty	New
IC707 IC708 IC711 IC871	00D 262 3742 905 00D 273 0492 902 00D 262 2977 946 00D 263 0673 902	F2621E-01 SP8K3FU6TB BA33BC0FP-E2 +REF BA10393F-E2 +C	for S-52E3 for S-52E3 for S-52E3/DABEK		
TR301,302 TR304,305 TR306 TR307 TR308	00D 273 0460 905 00D 269 0192 902 00D 269 0184 907 00D 271 0331 902 00D 269 0192 902	KTC2875-B-RTK/P KRC102S-RTK/P (10K-10K) KRA102S-RTK/P (10K-10K) 2SA2092QTL KRC102S-RTK/P (10K-10K)	for S-52E2/DABEK/JP,S-32E3/E2 for S-52E2/DABEK/JP,S-32E3/E2 for S-52E2/DABEK/JP,S-32E3/E2 for S-52E2/DABEK/JP,S-32E3/E2		
TR309 TR310 TR311 TR312 TR313	00D 273 0464 901 00D 273 0460 905 00D 269 0192 902 00D 269 0086 908 00D 273 0485 906	KTC3875S-GR-RTK/P KTC2875-B-RTK/P KRC102S-RTK/P (10K-10K) DTA114TKT96 +C KRC107S-RTK(10K-47K)	for S-52E2/DABEK,S-32E2 for S-52E3/E2/DABEK,S-32E3/E2 for S-52E3/E2/DABEK,S-32E3/E2 for S-52E3/E2/DABEK,S-32E3/E2		
TR314 TR315 TR316 TR317 TR318	00D 272 0127 902 00D 269 0184 907 00D 269 0192 902 00D 269 0192 902 00D 271 0331 902	2SB1182TL(R) KRA102S-RTK/P (10K-10K) KRC102S-RTK/P (10K-10K) KRC102S-RTK/P (10K-10K) 2SA2092QTL	for S-52E3/E2/DABEK,S-32E3/E2 for S-52E3 for S-52E3		
TR501,502 TR505 TR506 TR701 TR702	00D 269 0192 902 00D 269 0193 901 00D 269 0184 907 00D 269 0184 907 00D 269 0192 902	KRC102S-RTK/P (10K-10K) KRC104S-RTK/P (47K-47K) KRA102S-RTK/P (10K-10K) KRA102S-RTK/P (10K-10K) KRC102S-RTK/P (10K-10K)	for S-52E3 for S-52E3		
TR703-705 D101 D102 D305	00D 269 0192 902 00D 276 0750 902 00D 276 0794 900 00D 276 0794 900	KRC102S-RTK/P (10K-10K) RB521S-30TE61 +REF KDS160-RTK/P KDS160-RTK/P	for S-52E3		
D309,310 D701-703 ZD203 ZD501,502 ZD701	00D 276 0794 900 00D 276 0794 900 00D 276 0463 914 00D 276 0837 906 00D 276 0837 906	KDS160-RTK/P KDS160-RTK/P HZS6C-2TD NSAD500F-T1B-A NSAD500F-T1B-A	for S-52E3 for S-52E3 for S-52E3		
RESISTORS GROUP					
R370,371 R372,373 R403 R428,429 R806,807 R856,857	00D 235 0130 903 nsp 00D 244 2051 945 00D 235 0130 903 nsp 00D 235 0130 903	CHIP EMIFIL(11A121) +1608 CK73B1H332KT +1608 RS14B3A010JNBST(S) CHIP EMIFIL(11A121) +1608 RM73B20R0KT +3216 CHIP EMIFIL(11A121) +1608	for S-52E2/DABEK/JP,S-32E3/E2 for S-52E3 for S-52E3		
RR118 RR361 RR364 RR401	00D 247 2024 913 00D 247 2027 907 00D 247 2019 902 nsp	RM73B--6041DT(1608) RM73B--511FT +1608 RM73B--102FT +1608 RM73B20R0KT +3216	for S-52JP		
CAPACITORS GROUP					
C108 C109 C110	00D 257 2018 900 nsp nsp	CS77B1A100MT(NOJ) CK73F1E104ZT +1608 CK73F1H103ZT +1608			



Ref. No.	Part No.	Part Name	Remarks	Q'ty	New
C111	nsp	CK73B1H102KT +1608			
C112	nsp	CK73F1H103ZT +1608			
C113	nsp	CK73B1H102KT +1608			
C114	00D 257 2018 900	CS77B1A100MT(NOJ)			
C115	nsp	CK73F1E104ZT +1608			
C116	00D 254 4740 921	CE67W1C470MT(GV)			
C117	nsp	CK73F1E104ZT +1608			
C118-126	nsp	CK73B1H102KT +1005			
C127	nsp	CK73F1H103ZT +1608			
C128,129	nsp	CK73B1H102KT +1608			
C130	nsp	CC73CH1H470JT +1608			
C131-136	nsp	CK73F1E104ZT +1608			
C137	nsp	CK73F1H103ZT +1608			
C138	nsp	CK73F1E104ZT +1608			
C139	nsp	CK73F1H103ZT +1608			
C140	00D 254 4740 921	CE67W1C470MT(GV)			
C141,142	nsp	CK73F1E104ZT +1608			
C143	nsp	CK73F1H103ZT +1608			
C144	nsp	CK73F1E104ZT +1608			
C145-165	00D 257 5009 974	CK73F1C104ZT +1005			
C166	nsp	CK73F1E104ZT +1608			
C167	nsp	CK73F1H103ZT +1608			
C168-171	00D 254 4740 921	CE67W1C470MT(GV)			
C172,173	00D 257 2018 900	CS77B1A100MT(NOJ)			
C174	nsp	CK73F1E104ZT +1608	for S-52		
C175-177	nsp	CK73F1E104ZT +1608			
C178	nsp	CK73F1H103ZT +1608			
C179	nsp	CK73B1H102KT +1608			
C183	nsp	CK73F1E104ZT +1608			
C184	nsp	CK73F1H103ZT +1608			
C185,186	nsp	CK73B1H102KT +1608			
C187-198	nsp	CK73B1H102KT +1005			
C199,200	nsp	CK73B1H102KT +1608			
C201	nsp	CK73F1H103ZT +1608			
C203-205	nsp	CK73B1H102KT +1608			
C208,209	nsp	CC73CH1H330JT +1608			
C300	nsp	CK73F1E104ZT +1608	for S-52E3		
C301	nsp	CK73B1H102KT +1608	for S-52E3		
C302	nsp	CK73F1E104ZT +1608			
C303	00D 254 4740 921	CE67W1C470MT(GV)			
C304	nsp	CK73F1E104ZT +1608			
C305	00D 254 4740 976	CE67W1C100MT(GV)			
C306	nsp	CK73F1E104ZT +1608			
C307	00D 254 4740 976	CE67W1C100MT(GV)			
C308,309	00D 257 0503 967	CC73CH1H150JT +1608			
C310	00D 257 0508 988	CC73CH1H102JT +1608			
C311,312	nsp	CK73F1E104ZT +1608			
C313,314	nsp	CC73CH1H120JT +1608			
C315	00D 254 4740 921	CE67W1C470MT(GV)			
C316	00D 254 4742 903	CE67W1V4R7MT(GV)			
C317	nsp	CK73F1H103ZT +1608			
C318,319	nsp	CK73F1E104ZT +1608			
C320	00D 254 4743 957	CE67W1H2R2MT(GV)			
C321	nsp	CK73B1H102KT +1608			
C322	nsp	CK73F1E104ZT +1608			
C323	nsp	CK73B1H102KT +1608			
C324	00D 254 4739 916	CE67W1A470MT(GV)			

Ref. No.	Part No.	Part Name	Remarks	Q'ty	New
C325,326 C327	00D 254 4740 976 nsp	CE67W1C100MT(GV) CC73CH1H101JT +1608			
C328 C329,330 C331 C332 C333	nsp nsp nsp nsp nsp	CK73F1H103ZT +1608 CK73F1E104ZT +1608 CC73CH1H561JT +1608 CC73CH1E681JT +1608 CC73CH1H561JT +1608			
C334 C336,337 C338,339 C340,341 C342	nsp 00D 254 4740 934 nsp 00D 254 4740 976 00D 254 4740 976	CC73CH1E681JT +1608 CE67W1C101MT(GV) CK73B1H332KT +1608 CE67W1C100MT(GV) CE67W1C100MT(GV)	for S-52E3		
C343,344 C345,346 C347 C348 C349	00D 254 4743 957 00D 254 4740 976 nsp nsp nsp	CE67W1H2R2MT(GV) CE67W1C100MT(GV) CC73CH1H101JT +1608 CK73F1E104ZT +1608 CC73CH1H101JT +1608			
C350 C351-353 C355 C356 C357	nsp 00D 254 4740 976 nsp nsp nsp	CK73F1E104ZT +1608 CE67W1C100MT(GV) CK73B1H102KT +1608 CK73B1H103KT (1608) +1608 CC73CH1H221JT +1608			
C358 C359 C362 C363 C364,365	nsp nsp nsp nsp nsp	CK73B1E104KT +1608 CK73F1E104ZT +1608 CK73F1E104ZT +1608 CK73B1H102KT +1608 CK73F1E104ZT +1608			
C366 C367 C368,369 C372-374 C375	00D 254 4743 944 nsp 00D 254 4740 976 nsp nsp	CE67W1H010MT(GV) CK73F1E104ZT +1608 CE67W1C100MT(GV) CK73B1H102KT +1608 CK73F1H103ZT +1608	for S-52E3/E2/DABEK,S-32E3/E2		
C380,381 C382 C383 C384 C385	nsp nsp nsp nsp nsp	CK73F1E104ZT +1608 CK73F1H103ZT +1608 CK73B1H102KT +1608 CK73F1H103ZT +1608 CK73F1E104ZT +1608	for S-52E2/DABEK,S-32E2 for S-52E2/DABEK,S-32E2		
C386 C387 C388 C389 C390	nsp nsp nsp nsp nsp	CK73F1H103ZT +1608 CC73CH1H220JT +1608 CK73F1H103ZT +1608 CC73CH1H220JT +1608 CK73F1H103ZT +1608	for S-52E2/DABEK,S-32E2 for S-52E2/DABEK,S-32E2 for S-52E2/DABEK,S-32E2 for S-52E2/DABEK,S-32E2 for S-52E2/DABEK/JP,S-32E3/E2		
C391 C392-394 C395 C396 C397	nsp nsp 00D 254 4740 921 00D 254 4740 976 nsp	CC73CH1H561JT +1608 CK73F1H103ZT +1608 CE67W1C470MT(GV) CE67W1C100MT(GV) CK73F1H103ZT +1608	for S-52E2/DABEK,S-32E2 for S-52E2/DABEK/JP,S-32E3/E2 for S-52E2/DABEK,S-32E2 for S-52E2,DABEK,S-32E2 for S-52E2,DABEK,S-32E2		
C398 C399 C400 C401 C402	nsp nsp nsp nsp nsp	CC73CH1H331JT +1608 CK73F1H103ZT +1608 CK73F1E104ZT +1608 CK73F1H103ZT +1608 CK73B1H102KT +1608	for S-52E2,DABEK,S-32E2 for S-52E2,DABEK,S-32E2 for S-52E3 for S-52E3 for S-52E3		
C403 C404 C405 C406 C407	nsp nsp nsp nsp nsp	CK73F1E104ZT +1608 CK73B1H102KT +1608 CK73F1H103ZT +1608 CK73F1E104ZT +1608 CK73B1H102KT +1608			

Ref. No.	Part No.	Part Name	Remarks	Q'ty	New
C408	nsp	CK73F1H103ZT +1608			
C409	nsp	CK73F1E104ZT +1608			
C410	nsp	CK73B1H102KT +1608			
C411	nsp	CK73F1H103ZT +1608			
C412	nsp	CK73F1E104ZT +1608			
C413	nsp	CK73B1H102KT +1608			
C414,415	nsp	CK73F1H103ZT +1608			
C501	nsp	CK73F1H103ZT +1608			
C502	nsp	CK73B1H102KT +1608			
C503	nsp	CK73F1H103ZT +1608	for S-52		
C504	nsp	CK73B1H102KT +1608	for S-52		
C505	nsp	CK73F1E104ZT +1608			
C506-510	00D 257 0521 949	CK73B1A474KT			
C511-513	nsp	CK73F1E104ZT +1608			
C514-517	nsp	CK73B1H102KT +1608			
C700-702	nsp	CK73B1H102KT +1608			
C703,704	nsp	CK73F1E104ZT +1608			
C705,706	nsp	CK73B1H102KT +1608			
C707	nsp	CK73F1H103ZT +1608			
C708	00D 254 4739 916	CE67W1A470MT(GV)			
C709-711	nsp	CK73F1E104ZT +1608			
C712	nsp	CK73F1H103ZT +1608			
C714	00D 254 4739 916	CE67W1A470MT(GV)			
C716	nsp	CK73B1H102KT +1608			
C717-720	nsp	CK73F1E104ZT +1608			
C721,722	00D 254 4739 916	CE67W1A470MT(GV)			
C723,724	00D 254 4740 921	CE67W1C470MT(GV)			
C725	nsp	CK73F1E104ZT +1608			
C726	nsp	CK73B1H102KT +1608			
C727	00D 254 4739 916	CE67W1A470MT(GV)			
C728	nsp	CK73B1H102KT +1608			
C729,730	nsp	CK73F1H103ZT +1608			
C733	nsp	CK73B1H102KT +1608			
C736	nsp	CK73B1H102KT +1608			
C742,743	nsp	CK73F1E104ZT +1608			
C744	nsp	CK73B1H102KT +1608			
C747,748	00D 254 4740 976	CE67W1C100MT(GV)	for S-52E3		
C749	00D 235 0130 903	CHIP EMIFIL(11A121) +1608	for S-52E3		
C751	nsp	CK73B1H102KT +1608	for S-52E3		
C753	00D 257 0039 907	CK73B0J106MT	for S-52E3		
C755-758	nsp	CC73CH1H200JT +1608	for S-52E3		
C759,760	nsp	CK73B1E104KT +1608	for S-52E3		
C761	00D 254 4740 905	CE67W1C220MT(GV)	for S-52E3		
C762,763	nsp	CK73B1E104KT +1608	for S-52E3		
C764,765	nsp	CC73CH1H5R0CT +1608	for S-52E3		
C766	nsp	CK73F1E104ZT +1608	for S-52E3		
C767	nsp	CK73B1E104KT +1608	for S-52E3		
C768	nsp	CK73B1H102KT +1608	for S-52E3		
C769	00D 257 0039 907	CK73B0J106MT	for S-52E3		
C770,771	nsp	CK73B1E104KT +1608	for S-52E3		
C772,773	nsp	CK73B1H102KT +1608	for S-52E3		
C774	00D 257 0039 907	CK73B0J106MT	for S-52E3		
C775	nsp	CK73B1H102KT +1608	for S-52E3		
C777,778	nsp	CK73F1E104ZT +1608	for S-52E3		
C789	nsp	CK73F1E104ZT +1608	for S-52E3/DABEK		
C790	00D 254 4739 916	CE67W1A470MT(GV)	for S-52E3/DABEK		
C791,792	nsp	CK73F1E104ZT +1608	for S-52E3/DABEK		



Ref. No.	Part No.	Part Name	Remarks	Q'ty	New
C793	00D 254 4739 916	CE67W1A470MT(GV)	for S-52E3/DABEK		
C872-874	nsp	CK73F1E104ZT +1608			
C875	nsp	CK73F1E104ZT +1608	for S-52DABEK		
C876,877	nsp	CK73B1H102KT +1608	for S-52DABEK		
CC101	00D 257 0039 907	CK73B0J106MT			
CC102,103	nsp	CK73F1E104ZT +1608			
CC104	nsp	CK73F1H103ZT +1608			
CC105-108	00D 257 5009 974	CK73F1C104ZT +1005			
CC109-112	nsp	CK73B1H102KT +1005			
CC113-116	nsp	CK73B1A104KT +1005			
CC117-120	nsp	CK73B1H102KT +1005			
CC121,122	nsp	CC73CH1H120JT +1608			
CC123	00D 257 0039 907	CK73B0J106MT			
CC124	nsp	CK73B1H102KT +1608			
CC125	nsp	CK73F1E104ZT +1608			
CC126,127	nsp	CK73F1H103ZT +1608			
CC128,129	00D 257 0039 907	CK73B0J106MT			
CC130	nsp	CK73B1H102KT +1608			
CC131,132	00D 257 5009 974	CK73F1C104ZT +1005			
CC133,134	nsp	CK73B1H102KT +1005			
CC135	nsp	CK73F1E104ZT +1608			
CC136-141	00D 257 5009 974	CK73F1C104ZT +1005			
CC142,143	nsp	CK73B1H102KT +1005			
CC147	00D 257 0011 996	CK73B1E104KT +2125			
CC148-150	nsp	CK73F1E104ZT +1608			
CC151-153	nsp	CK73B1H102KT +1608			
CC154	00D 257 0039 907	CK73B0J106MT			
CC155	nsp	CK73F1E104ZT +1608			
CC156	00D 254 4738 904	CE67W0J101MT(GV)			
CC157,158	nsp	CK73F1E104ZT +1608			
CC159	00D 254 4740 905	CE67W1C220MT(GV)			
CC160	nsp	CK73F1E104ZT +1608			
CC161-164	nsp	RM73B--0R0KT +1608			
CC165	nsp	CK73F1E104ZT +1608	for S-52		
CC166	00D 254 4738 904	CE67W0J101MT(GV)	for S-52		
CC167,168	nsp	CK73F1E104ZT +1608	for S-52		
CC169	00D 257 0039 907	CK73B0J106MT	for S-52		
CC174	00D 254 4738 904	CE67W0J101MT(GV)			
CC175	nsp	CK73F1E104ZT +1608			
CC176	nsp	CK73B1H102KT +1608			
CC177	nsp	CK73B1A104KT +1005			
CC178,179	00D 254 4740 921	CE67W1C470MT(GV)			
CC180,181	nsp	RM73B--0R0KT +1608			
CC183	nsp	CK73B1H102KT +1608			
CC184	nsp	CC73CH1H101JT +1608			
CC185	nsp	CK73B1H102KT +1608			
CC187	nsp	CC73CH1H101JT +1608			
CC188	nsp	CK73F1E104ZT +1608			
CC189	nsp	CK73B1H102KT +1608			
CC190	00D 254 4740 921	CE67W1C470MT(GV)			
CC191	00D 257 0039 907	CK73B0J106MT			
CC192	nsp	CC73CH1H101JT +1608			
CC193,194	nsp	CK73B1E104KT +1608			
CC195,196	nsp	RM73B--0R0KT +1608			
CC197	nsp	CC73CH1H100DT +1608			
CC198-201	00D 257 5002 926	CC73CH1H100DT +1005			

Ref. No.	Part No.	Part Name	Remarks	Q'ty	New
CC202	nsp	CC73CH1H100DT +1608			
CC203	00D 257 5002 926	CC73CH1H100DT +1005			
CC204	nsp	CC73CH1H100DT +1608			
CC205-213	00D 257 5002 926	CC73CH1H100DT +1005			
OTHERS PARTS GROUP					
CX051	nsp	5P PH CON BASE(TAPE) +REF			
CX054	nsp	5P PH CON BASE(TAPE) +REF	for S-52		
CX062	nsp	6P CONN.BASE(KR-PH)			
CX071	nsp	7P ZH-ZR CON.BASE-T	for S-52E3/E2/DABEK,S-32E3/E2		
CX081	nsp	8P PH CON.BASE(TAPE)	for S-52DABEK		
CX091	nsp	9P CONN.BASE(KR-PH)			
CX101	nsp	10P ZR CON. BASE(L)			
CX111	nsp	11P PH CON.BASE(TAPE)			
CX124	nsp	MINI-PCI-CONNECTOR			*
CX131	nsp	13P KR CON BASE(L)			
CX151	nsp	15P FFC CON.BASE	for S-52E2/DABEK/JP,S-32E3/E2		
CX161	nsp	16P PHD BASE	for S-52E3		
CX262	nsp	26P FFC BASE(9639S)			*
CX301	nsp	30P-FFC-BASE(9610SC)	for S-52		
CX303	nsp	3P ZH-ZR CON.BASE-T			
CX109	nsp	10P FFC BASE(9610SA)	for S-32E3/E2		
CY064	nsp	6P ZH-ZR CON.BASE-T			
CY071	nsp	7P ZH-ZR CON.BASE-T	for S-52E3/E2/DABEK,S-32E3/E2		
FB101	00D 235 0158 901	CHIP BEADS(18PG121) +1608			
FB102-104	nsp	RM73B--OR0KT +2125			
FB303,304	00D 235 0130 903	CHIP EMIFIL(11A121) +1608	for S-52E3		
FB307,308	00D 235 0147 909	E.FIL(BLM21PG221SN1)+2125	for S-52E2/DABEK/JP,S-32E3/E2		
FB501-506	00D 235 0130 903	CHIP EMIFIL(11A121) +1608			
FB701,702	00D 235 0130 903	CHIP EMIFIL(11A121) +1608			
FB703,704	00D 235 0147 909	E.FIL(BLM21PG221SN1)+2125	for S-52E3		
JK011	00D 204 8604 000	1P PIN JACK(S-GND)			
JK012	00D 204 8637 006	MINI JACK (STEREO)			
JK071	00D 205 1362 009	XM/DT BUS CONNECTOR	for S-52E3		
JK081	00D 205 1135 003	8P MD BASE (F-S)	for S-52E3		
JK501	00D 205 1333 009	8P MODULAR			
ST301	nsp	STYLE PIN			
ST501,502	nsp	STYLE PIN			
W301	nsp	1P SIN-EH CON CORD			*
W701	nsp	M3 SCREW TERMINAL			
X301	00D 399 0988 909	X*TAL (12.288MHZ)			
X302	00D 399 1031 907	XTAL(11.2896M/SMT)			
X303	00D 399 1009 007	X-TAL(S-4.332-14)	for S-52E2/DABEK,S-32E2		
X501	00D 399 1030 908	HC-49/U03C24.576MHZ			
X701	00D 399 1055 909	FCX-02(45.1584MHZ)	for S-52E3		
X702	00D 399 1090 906	CSTCW24M0X51R-R0			
	nsp	7P ZH-ZH CON.CORD	for CX071:S-52E3/E2/DABEK,S-32E3/E2		*

1U-3847 POWER AMP/KEY P.W.B. UNIT ASS'Y

Ref. No.	Part No.	Part Name	Remarks	Q'ty	New
SEMICONDUCTORS GROUP					
IC107	00D 399 1126 003	GP1UE261XKVF			*
TR105,106	00D 269 0192 902	KRC102S RTK/P (10K 10K)			
ZD102	00D 276 0683 943	UDZS3.6B TE17			
LD101,102	00D 393 9663 007	SLR 343MG3F(GREEN)			
CAPACITORS GROUP					
C101	nsp	CK73F1E104ZT +1608			
C102	nsp	CK73B1H103KT (1608) +1608			
C103	nsp	CK73F1E104ZT +1608			
C104	nsp	CK73B1H103KT (1608) +1608			
C198,199	nsp	CK73F1E104ZT +1608			
C201	nsp	CK73F1E104ZT +1608			
C202	nsp	CK73B1H103KT (1608) +1608			
C203	nsp	CK73F1E104ZT +1608			
C204	nsp	CK73B1H103KT (1608) +1608			
C206	nsp	CK73F1E104ZT +1608			
C207	nsp	CK73B1H103KT (1608) +1608			
C208	00D 254 4816 907	CE04W0J101MTD(SRE)			*
C209 212	nsp	CK73F1H103ZT +1608			
C213	nsp	CK73F1E104ZT +1608			
C215	nsp	CK73F1E104ZT +1608			
C216	nsp	CK73B1H103KT (1608) +1608			
C217 220	nsp	CK73F1E104ZT +1608			
C225	nsp	CK73F1E104ZT +1608			
C227	nsp	CK73F1H103ZT +1608			
C228	nsp	CK73F1E104ZT +1608			
C235	00D 254 4733 909	CE04W1A100MT(SF)			
C300	nsp	CK73F1E104ZT +1608	for S 52DABEK		
C301	nsp	CK73F1H103ZT +1608	for S 52DABEK		
C302	nsp	CK73F1E104ZT +1608	for S 52DABEK		
C304,305	nsp	CK73F1H103ZT +1608	for S 52DABEK		
C307	nsp	CK73F1E104ZT +1608	for S 52DABEK		
C308,309	00D 254 4818 002	CE04W0J331M F11(KY)	for S 52DABEK		*
OTHERS PARTS GROUP					
CW101	nsp	10P ZH JB CON.CORD			*
CX032	nsp	3P ZH SAN CON.CORD			*
CX045	nsp	4P PWB HEADER	for S 52DABEK		*
CX201	nsp	20P PWB HEADER	for S 52DABEK		*
CY063	nsp	6P ZR CON.BASE (L)			
CY081	nsp	8P KR CON BASE(L)	for S 52DABEK		
CY091	nsp	9P CONN.BASE(KR PH)			
FB101 105	00D 235 0130 903	CHIP EMIFIL(11A121) +1608			
FB201,202	00D 235 0158 901	CHIP BEADS(18PG121) +1608	for S 52DABEK		
JK101	00D 204 8637 006	MINI JACK (STEREO)			

Ref. No.	Part No.	Part Name	Remarks	Q'ty	New
JK102	00D 204 8424 002	H/PHONE JACK			
S101-113	00D 212 5604 907	TACT SWITCH-TA(ALPS)			*
S114	00D 212 1209 005	PUSH SWITCH			*
S115	00D 212 0529 003	ROTARY ENCODER			*
S116	00D 212 1209 005	PUSH SWITCH			*
ST101,102	-	OPEN			
SY101	00D 279 0034 067	PTH9M04BB222TS2F333			
	nsp	PVC TUBE (L=5)	for SY101		

4

1U-3859 POWER /IPOD UNIT P.W.B. UNIT ASS'Y

Ref. No.	Part No.	Part Name	Remarks	Q'ty	New
SEMICONDUCTORS GROUP					
IC100 IC101 103 IC108 IC306	00D 263 1100 021 00D 263 1219 006 00D 263 1223 005 00D 262 2977 946	KIA7812API U/P BD9702T V5 PQ20RX11J00H BA33BC0FP E2 +REF	for S 52E3/DABEK		
IC505 TR300 TR302 TR320,321	00D 262 3763 007 00D 273 0464 901 00D 273 0464 901 00D 273 0460 905	TA8216HQ(5) KTC3875S GR RTK/P KTC3875S GR RTK/P KTC2875 B RTK/P			*
TR322 TR323 TR501 D100 111	00D 269 0184 907 00D 269 0192 902 00D 273 0460 905 00D 276 0772 003	KRA102S RTK/P (10K 10K) KRC102S RTK/P (10K 10K) KTC2875 B RTK/P 1N4004			
D112 114 D201 205 D208 D314 D315	00D 276 0857 902 00D 276 0794 900 00D 276 0772 003 00D 276 0750 902 00D 276 0401 905	RB050LA 40 KDS160 RTK/P 1N4004 RB521S 30TE61 +REF 1SS133T77 (TAPE)			*
D316 323 ZD101 ZD102	00D 276 0750 902 00D 276 0837 906 nsp	RB521S 30TE61 +REF NSAD500F T1B A RM73B 0R0KT +2125	for S 52		
RESISTORS GROUP					
R515,516 R102	00D 241 2171 907 00D 247 2024 913	RD14B2H4R7JT RM73B 6041DT (1608)	for S 52E3		
R102 R103 R103	00D 247 2009 983 00D 247 2021 903 00D 247 2008 997	RM73B 103JT +1608 RM73B 122FT +1608 RM73B 432JT +1608	for S 52E2/DABEK/JP,S 32E3/E2 for S 52E3 for S 52E2/DABEK/JP,S 32E3/E2		
CAPACITORS GROUP					
C100 111 C112 C114 C115	nsp 00D 254 6279 005 00D 254 4428 706 00D 254 4523 724	CK73F1H103ZT +1608 CE68W1H222M(SMHP25S) CE04W1V222MC (SMG) CE04W1V472MC SMG/RE3			*
C116 C118,119 C121 123 C124 127 C128	nsp nsp nsp nsp nsp	CK73F1H103ZT +1608 CK73F1H103ZT +1608 CK73B1H103KT (1608) +1608 CK73F1E104ZT +1608 CK73B1E104KT +1608			
C129 C130 C132 C134 136 C137	00D 254 4694 912 nsp 00D 247 2024 913 nsp nsp	CE04W1E221MT(RF0) CK73F1E104ZT +1608 RM73B 6041DT (1608) CK73B1H103KT (1608) +1608 CK73B1E104KT +1608	for S 52E3 for S 52E3/DABEK		
C138 140 C141 C142 C143 145 C146	00D 254 4708 905 00D 254 4536 915 nsp nsp nsp	CE04W1E221MT HB5(KY) CE04W1A470MT SMG/RE3 CK73F1E104ZT +1608 CK73B1E104KT +1608 CK73F1H103ZT +1608	for S 52E3/DABEK		

③
③
③
③

③

Ref. No.	Part No.	Part Name	Remarks	Q'ty	New
C147 149 C150 C200 C201 203 C206	00D 254 4708 905 nsp 00D 254 4533 934 nsp nsp	CE04W1E221MT HB5(KY) CK73F1H103ZT +1608 CE04W0J221MT SMG/RE3 CK73F1E104ZT +1608 CK73F1E104ZT +1608	for S 52 for S 52		
C207 C208 C209 C210 C211	nsp nsp nsp nsp nsp	CK73B1H102KT +1608 CK73F1E104ZT +1608 CK73B1H102KT +1608 CK73F1E104ZT +1608 CK73B1H102KT +1608			
C212,213 C301 C302 C303 306 C342	nsp nsp 00D 254 4539 705 nsp 00D 253 8022 710	CK73F1E104ZT +1608 CK73B1E104KT +1608 CE04W1C102MC SMG/RE3 CK73F1H103ZT +1608 CK45F2EAC222MC			
C346 C350 C362 C363 C365	00D 253 8022 710 00D 253 8022 710 00D 254 4718 995 nsp nsp	CK45F2EAC222MC CK45F2EAC222MC CE04W1C222MT(GR) CK73B1H102KT +1608 CK73F1E104ZT +1608	for S 52E2/DABEK/JP,S 32E2		
C366 C505 C554,555 C556,557 C564	00D 254 4717 912 00D 253 1201 907 00D 254 4718 940 00D 257 0508 920 00D 254 4718 940	CE04W1A470MT(GR) CK45F1H103ZT(H) CE04W1C101MT(GR) CC73CH1H511JT +1608 CE04W1C101MT(GR)			
C567 C568 C570 C571 573	00D 254 4717 941 00D 254 4569 717 00D 254 4569 717 00D 256 1058 971	CE04W1A331MT(GR) CE04W1E222MC(RA3) CE04W1E222MC(RA3) CF93A1H104JT (JL)			
OTHERS PARTS GROUP					
AS101 AS108	nsp nsp	RADIATOR RADIATOR	for S 52E3/DABEK		
CX021 CX041 CX051 CX063 ⚠ CX121	nsp nsp nsp nsp 00D 203 3905 002	2P EH CONNECTOR BASE 4P CONN.BASE(KR PH) 5P KR CON BASE(L) 6P EH CONNECTOR BASE YKE31 0149N	for S 52E3,S 32E3		
⚠ CX121 ⚠ CX122 CX131 CX302	00D 203 3905 015 nsp nsp 00D 205 1451 004	YKE31 0148N 2P VH CONN. BASE (L) 13P KR CON BASE(L) DOCK CON.(514S0117)	for S 52E2/DABEK/JP,S 32E2		
CY041 CY042 CY051 CY061 CY062	nsp nsp nsp nsp nsp	4P CONN.BASE(KR PH) 4P VH CON.BASE 5P CONN.BASE(KR PH) 6P CONN.BASE(KR PH) 6P CONN.BASE(KR PH)	for S 52 for S 52		
CY111	nsp	11P CON.BASE(KR PH)			
⚠ F100,101 ⚠ F102 ⚠ F103 ⚠ F103	052 010 0120 010 652 010 0220 02S 00D 206 1039 050 00D 206 1015 029	# FUSE T1.25AL/250V 021802.5MXP FUSE 1.6A T FUSE 1A T	for S 52E3,S 32E3 for S 52E2,S 32E3		

	Ref. No.	Part No.	Part Name	Remarks	Q'ty	New
⚠	F103	00D 206 1015 029	FUSE 1A T	for S 52DABEK		
⚠	F103	00D 206 1035 054	FUSE 1.6A (T)	for S 52JP		
	FB100	00D 235 0147 909	E.FIL(BLM21PG221SN1)+2125	for S 52		
⚠	FF100 103	nsp	FUSE CLIP(TAPE)			
⚠	FH100 103	nsp	FUSE CLIP(TAPE)			
	JK103	00D 204 8714 000	USB CONNECTOR(TOPYANG BLACK)	for S 52		
	JK203	00D 205 1344 001	1P F TERMINAL	for S 52DABEK		
	JK204	00M YJ0 7000 350	CO AX CABLE MINIJACK	for S 52DABEK		
	L100 102	00D 235 0193 005	LHL13TB470K			
⚠	L103 105	00D 235 0142 920	COIL LHL08TB100KT			
	L401	00D 235 0157 009	PLA10AN7720R7D2B			
⚠	RL201	00D 214 0224 003	RELAY(0JT SS 109LM)			
	ST101	nsp	STYLE PIN			
	ST102	nsp	STYLE PIN	for S 52		
	ST301	nsp	STYLE PIN	for S 52		
	ST502	nsp	STYLE PIN			
	SY101	nsp	HEAT SINK			
⚠	T200	00D 233 6613 004	POWER TRANS(SUB/E3)	for S 52E3,S 32E3		*
⚠	T200	00D 233 6565 000	POWER TRANS(SUB/E2)	for S 52E2/DABEK/S 32E2		
⚠	T200	00D 233 0719 001	POWER TRANS(SUB/J)	for S 52JP		
		nsp	3X16 CPTS(B) SW W			
		nsp	3X8 CPS(SW,W) ZNP			
		nsp	SHIELD CASE (A)	for S 52DABEK		
		nsp	SHIELD CASE (B)	for S 52DABEK		
⚠		nsp	FUSE COVER	for F103		
		nsp	FUSE LABEL	for F103:S 52E2/DABEK,S 32E2		
⚠		nsp	CONDENSER COVER	for C342		*
⚠		nsp	CONDENSER COVER	for C346		*
⚠		nsp	CONDENSER COVER	for S 52E2/DABEK/JP,S 32E2 :C350		*

EXPLODED VIEW

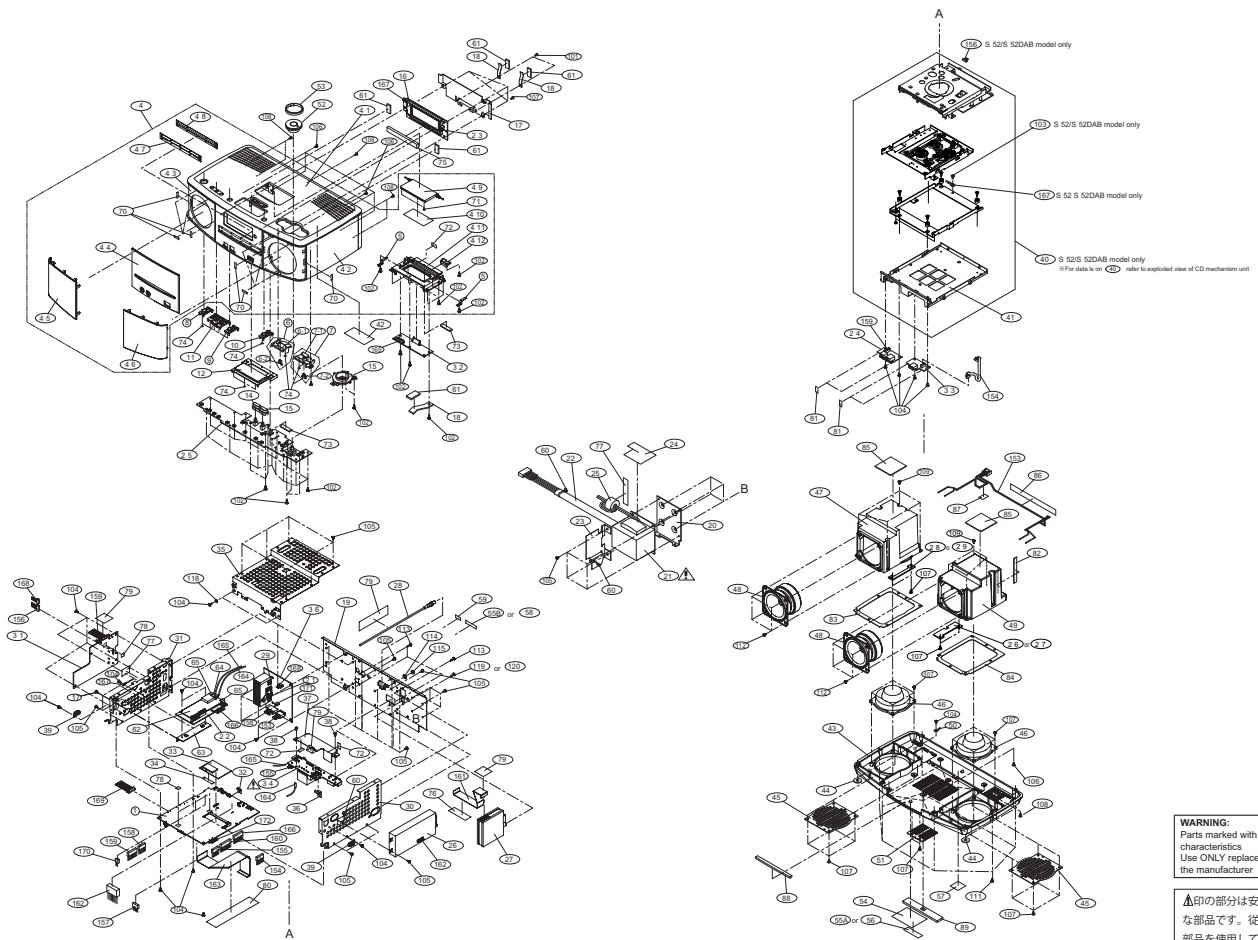

PARTS LIST OF EXPLODED VIEW

- * 本表に "nsp" と記載されている部品は供給できません。
- * Parts for which "nsp" is indicated on this table cannot be supplied.
- * 本表に "nsp" と記載されている基板 ASS'Y は供給できません。基板 ASS'Y の修理の際には基板部品表を確認のうえ、交換部品を発注してください。
- * P.W.B. ASS'Y for which "nsp" is indicated on this table cannot be supplied. When repairing the P.W.B. ASS'Y, check the board parts table and order replacement parts.
- * 本表に記載されている部品は、補修用部品のため製品に使用している部品とは一部、形状、寸法などが異なる場合があります。
- * The parts listed below are for maintenance only, might differ from the parts used in the unit in appearances or dimensions.

Note: The symbols in the column "Remarks" indicate the following destinations.
 E3 : U.S.A. & Canada model E2 : Europe model EK : U.K. model JP : Japan mode

Ref. No.	Part No.	Part Name	Remarks	Q'ty	New
1	00D1U 3846A	MAIN UNIT (E3)	for S 52E3	1	*
1	00D1U 3846B	MAIN UNIT (E2)	for S 52E2	1	*
1	00D1U 3846C	MAIN UNIT (EK)	for S 52DABEK	1	*
1	00D1U 3846D	MAIN UNIT (J)	for S 52JP	1	*
1	00D1U 3846E	MAIN UNIT (E3)	for S 32E3	1	*
1	00D1U 3846F	MAIN UNIT (E2)	for S 32E2	1	*
2	nsp	POWER AMP/KEY UNIT	for S 52E2/E3/JP : 1U 3847A	1	*
2	nsp	POWER AMP/KEY UNIT (EK)	for S 52DABEK : 1U 3847B	1	*
2	nsp	POWER AMP/KEY UNIT	for S 32E3/E2 : 1U 3847C	1	*
2 1		SENSOR UNIT		1	
2 2		DAB INTERFACE UNIT		1	
2 3		REMO/LCD UNIT		1	
2 4		H/P PORTABLE IN UNIT		1	
2 5		KEY UNIT		1	
2 6		WIRE HOLDER UNIT		1	
2 7		WIRE HOLDER UNIT		1	
2 8		WIRE HOLDER UNIT		1	
2 9		WIRE HOLDER UNIT		1	
3	nsp	POWER /IPOD UNIT (E3)	for S 52E3 : 1U 3859A	1	*
3	nsp	POWER /IPOD UNIT (E2) (EK)	for S 52E2 : 1U 3859B	1	*
3	nsp	POWER /IPOD UNIT (J)	for S 52JP : 1U 3859C	1	*
3	nsp	POWER /IPOD UNIT (E3)	for S 32E3 : 1U 3859D	1	*
3	nsp	POWER /IPOD UNIT (E2)	for S 32E2 : 1U 3859E	1	*
3	nsp	POWER /IPOD UNIT (EK)	for S 52DABEK : 1U 3859F	1	*
3 1		POWER UNIT		1	
3 2		IPOD I/O UNIT		1	
3 3		USB TERM. UNIT		1	
3 4		STANDBY TRANS UNIT		1	
3 6		POWER AMP UNIT		1	
4	00DGEN8712	CABINET (E2) ASSY	for S 52E2	1	*
4	00DGEN8712 1	CABINET (E3) ASSY	for S 52E3	1	*
4	00DGEN8712 2	CABINET (EK) ASSY	for S 52DABEK	1	*
4	00DGEN8712 3	CABINET (J) ASSY	for S 52JP	1	*
4	00DGEN8713	CABINET (E2) ASSY	for S 32E2	1	*
4	00DGEN8713 1	CABINET (E3) ASSY	for S 32E3	1	*
4 1		CABINET ASSY	for S 52E3	1	*
4 1		CABINET ASSY	for S 52E2	1	*
4 1		CABINET ASSY	for S 52DABEK	1	*
4 1		CABINET ASSY	for S 52JP	1	*
4 1		CABINET ASSY	for S 32E2	1	*
4 1		CABINET ASSY	for S 32E3	1	*
4 2		CABINET	for S 52	1	*
4 2		CABINET	for S 32	1	*
4 3		FRONT CABINET	for S 52	1	*
4 3		FRONT CABINET	for S 32	1	*
4 4		WINDOW	for S 52E2	1	*
4 4		WINDOW	for S 52E3	1	*
4 4		WINDOW	for S 52DABEK	1	*

Ref. No.	Part No.	Part Name	Remarks	Q'ty	New	
4 4		WINDOW	for S 52JP	1	*	
4 4		WINDOW	for S 32E2	1	*	
4 4		WINDOW	for S 32E3	1	*	
4 5		METAL NET (L)		1	*	
4 6		MATAL NET (R)		1	*	
4 7		BLIND SHEET		1	*	
4 8		SUPPORT SHEET		1	*	
4 9		DOCK LID ASSY		1	*	
4 10		DOC LID COVER		1	*	
4 11		DOCK ESC		1	*	
4 12		ADAPTER SPRING		1	*	
5	00D 463 0978 100	SPRING PLATE		2	*	
6	00D 113 2109 302	KNOB(2P) A ASSY		1	*	
6 1		KNOB(2P) A BASE		1	*	
6 2		LED LENS		1	*	
7	00D 113 2108 303	KNOB(2P) B ASSY		1	*	
7 1		KNOB(2P) B BASE		1	*	
7 2		LED LENS		1	*	
8	00D 113 2104 103	KNOB (ON/STBY)		1	*	
9	00D 113 2105 005	KNOB (EJECT)	for S 52	1	*	
9	00D 113 2105 018	KNOB (EJECT)	for S 32	1	*	
10	00D 113 2106 208	KNOB(PLAY)		1	*	
11	00D 113 2111 109	KNOB (3P)		1	*	
12	00D 113 2112 302	KNOB (SNOOZE)		1	*	
13	00D 443 1625 209	ROTARY KNOB GUIDE		1	*	
14	00D 113 2126 000	KNOB (ALARM)		1	*	
15	00D 113 2126 013	KNOB (ALARM)		1	*	
16	00D 393 6029 107	LCD(MDG24EC18 FJ)		1	*	
17	nsp	SHIELD PLATE		1	*	
18	nsp	EARTH PLATE		3	*	
19	00D 105 1695 201	REAR PANEL	for S 52E3	1	*	
19	00D 105 1695 214	REAR PANEL	for S 52E2	1	*	
19	00D 105 1695 227	REAR PANEL	for S 52DABEK	1	*	
19	00D 105 1695 243	REAR PANEL	for S 32E2	1	*	
19	00D 105 1695 256	REAR PANEL	for S 32E3	1	*	
19	00D 105 1695 269	REAR PANEL	for S 52JP	1	*	
20	nsp	TRANS BRACKET		1	*	
!	21	00D 233 6611 006	POWER TRANS(MAIN/E2)	for S 52E2/DABEK,S 32E2	1	*
!	21	00D 233 6612 005	POWER TRANS(MAIN/E3)	for S 52E3,S 32E3	1	*
!	21	00D 233 0746 003	POWER TRANS(MAIN/J)	for S 52JP	1	*
	22	nsp	UL TUBE (12.7) BK		1	*
	23	nsp	TRANS SHIELD		1	*
	24	nsp	TRANS COVER		1	*
	25	00D 342 0043 000	FERRITE CLAMP102010N		1	*
	26	00D 216 0134 005	HD TUNER(E3)	for S 52E3	1	*
	27	00D 216 0125 001	AM FM TUNER(E2)	for S 52E2/DABEK,S 32E2	1	*
	27	00D 216 0127 009	AM FM TUNER(J)	for S 52JP	1	*
	27	00D 216 0129 007	AM FM TUNER(E3 RDBS)	for S 32E3	1	*
	28	nsp	ANNTEA CABLE		1	*
	29	nsp	HEAT SINK BRACKET		1	*
	30	nsp	SIDE BRACKET (R)		1	*
	31	nsp	SIDE BRACKET (L)		1	*
	32	nsp	EARTH PLATE (REAR)		1	*
	33	00D 399 1099 004	WLAN MODULE(11CH)	for S 52E3,S 32E3	1	*
	33	00D 399 1100 003	WLAN MODULE(13CH)		1	*
	34	nsp	FFC ID SUB ASSY	for S 52E3,S 32E3	1	*

Ref. No.	Part No.	Part Name	Remarks	Q'ty	New
35	nsp	TOP BRACKET		1	*
36	nsp	PWB BRACKET		1	*
37	nsp	PROTECTION SHEET		1	*
38	nsp	PUSH RIVET		2	
39	nsp	CORD HOLDER		2	
40	FGDVS202MS	CD MECHA UNIT	for S 52	1	*
41	nsp	MAIN CHASSIS	for S 32	1	*
42	nsp	E2 LASER CAUTION	for S 52E2/DABEK	1	
42	nsp	LABEL(A)	for S 52E3	1	
43	nsp	BOTTOM COVER		1	*
44	00D 461 1066 002	FELT		4	
45	nsp	DRONE CONE COVER		2	*
46	00D 305 0051 103	PR 06 PASSIVE RADIATOR		2	*
47	nsp	SP BOX (L)		1	*
48	00D 301 0180 001	77RG15 SPAEKER ASSY		2	*
49	nsp	SP BOX (R)		1	*
50	nsp	CORD HOLDER		1	
51	nsp	COVER PLATE		1	*
52	00D 112 1012 109	ROTARY KNOB		1	*
53	854 241 0001 00D	KNOB RING SUB ASSY		1	*
54	nsp	RATING SHEET	for S 52E2	1	*
54	nsp	RATING SHEET	for S 52E3	1	*
54	nsp	RATING SHEET	for S 52DABEK	1	*
★ 55A	nsp	NO. SHEET	for S 52E2/DABEK	1	
★ 55A	nsp	NO. SHEET	for S 32E2	1	
★ 55B	nsp	NO. SHEET	for S 52JP		
★ 56	nsp	SERIAL NO. SHEET	for S 52E3,S 32E3	1	
★ 57	nsp	DANGEROUS LABEL	for S 52E3,S 32E3	1	
★ 58	nsp	DATE LABEL	for S 52E3	1	
★ 59	nsp	MANUFAC.(J)SUB ASSY	for S 52JP	1	
★ 60	nsp	WIRE CLAMPER		8	
61	nsp	EMIGASKET RFSG020210	10mm	5	
62	00D 216 0135 004	DAB TUNER(VENCE4.2)	for S 52DABEK	1	
63	nsp	DAB PWB BRACKET	for S 52DABEK	1	
64	nsp	SHIELD CASE (DAB)	for S 52DABEK	1	
65	nsp	PWB HOLDER	for S 52DABEK	2	
70	nsp	SP NET CUSHION		10	*
71	00D 461 1307 004	LID CUSHION		2	*
72	00D 461 1305 006	ESC CUSHION		3	*
73	nsp	SNOOZE PWB SPACER		3	*
74	00D 461 1306 005	KNOB SPACER		13	*
75	432 510 0010 08D	LCD CUSHION		1	*
76	00D 461 1322 005	EMI FILTER CUSHION		1	*
77	00D 461 1324 003	POWER UNIT PWB SHEET		2	*
78	00D 415 1018 002	INSULATING SHEET		3	*
79	00D 461 1314 000	WIRE CUSHION		3	*
80	00D 461 1323 004	MECHA FFC CUSHION	for S 52	1	*
81	432 510 0020 01D	PWB CUSHION		4	*
82	nsp	SP BOX CUSHION		1	*
83	nsp	PEF SHEET (L)		1	*
84	nsp	PEF SHEET (R)		1	*
85	nsp	SP BOX SPACER		2	*
86	nsp	SP CABLE CUSHION		1	*
87	nsp	SP CABLE CUSHION R		1	*
88	nsp	NOISE INSULATE SHEET		1	*

Ref. No.	Part No.	Part Name	Remarks	Q'ty	New
89	nsp	NOISE INSULATE (BTM)	for S 52	1	*
SCREWS					
101	nsp	2.6X5 CBTS (S) Z		2	
102	nsp	2.6X8 CBTS (P) Z		34	
103	nsp	3X4 CBTS (S) Z		1	
104	nsp	3X6 CBTS(S) Z		20	
105	nsp	3X6 CBTS(S) B		32	
106	nsp	3X6 CBTS (S) B		13	
107	nsp	3X8 CBTS (P) B		26	
108	nsp	3X8 CBTS(B) B		7	
109	nsp	3X10 CBTS (P) Z		5	
110	nsp	3X10 CBTS(B) Z		2	
111	nsp	3X16 CBTS (P) B		6	
112	nsp	4X8 CBTS (P) B		8	
113	00D 477 0064 107	FIXING SCREW		4	
114		WASHER	for ANNTENA CABLE	1	
115		NUT	for ANNTENA CABLE	1	
116	nsp	3X6 CBTS(S) Z	for S 52DABEK	2	
117	nsp	3X6 CBTS(S) B	for S 52DABEK	2	
118	nsp	3W		2	
119	00D 477 0064 107	FIXING SCREW	for S 52E2/DABEK/JP,S 32E3/E2	1	
120	nsp	3X6 CBTS(S) B	for S 52E3	1	
WIRES					
153	nsp	4P VH CON.CORD		1	*
154	nsp	5P PH PH CON.CORD	for S 52	1	*
155	nsp	5P PH PH CON.CORD		1	*
156	nsp	6P PH PH CON.CORD		1	*
157	nsp	6P ZH ZH CON.CORD		1	*
158	nsp	6P PH PH SHIELD CORD		1	*
159	nsp	9P PH PH SHIELD CORD		1	*
160	nsp	11P PH PH CON.CORD		1	*
161	00D 009 0236 033	15P FFC CABLE(1.25)	for S 52E2/DABEK/JP,S 32E3/E2	1	*
162	nsp	16P PHD PHD CON.CORD	for S 52E3	1	*
163	00D 009 0285 039	30P FFC (1.0)	for S 52	1	*
164	nsp	1P COAX CABLE ASSY	for S 52DABEK	1	*
165	nsp	1P WIRE (AWG18)	for S 52DABEK	1	*
166	nsp	8P PH PH SHIELD CORD	for S 52DABEK	1	*
167	nsp	1P CONTACT ASSY	for S 52	1	*
168	nsp	4P PH PH CON.CORD		1	*
169	nsp	13P PH PH SHIELD CORD		1	*
170	nsp	3P ZH SAN CON.CORD		1	*
171	nsp	1P SAN EH CON.CORD		1	*
172	nsp	10P ZH JB CON.CORD		1	*

EXPLODED VIEW OF CD MECHANISM UNIT

④ S-52, S-52DAB model only

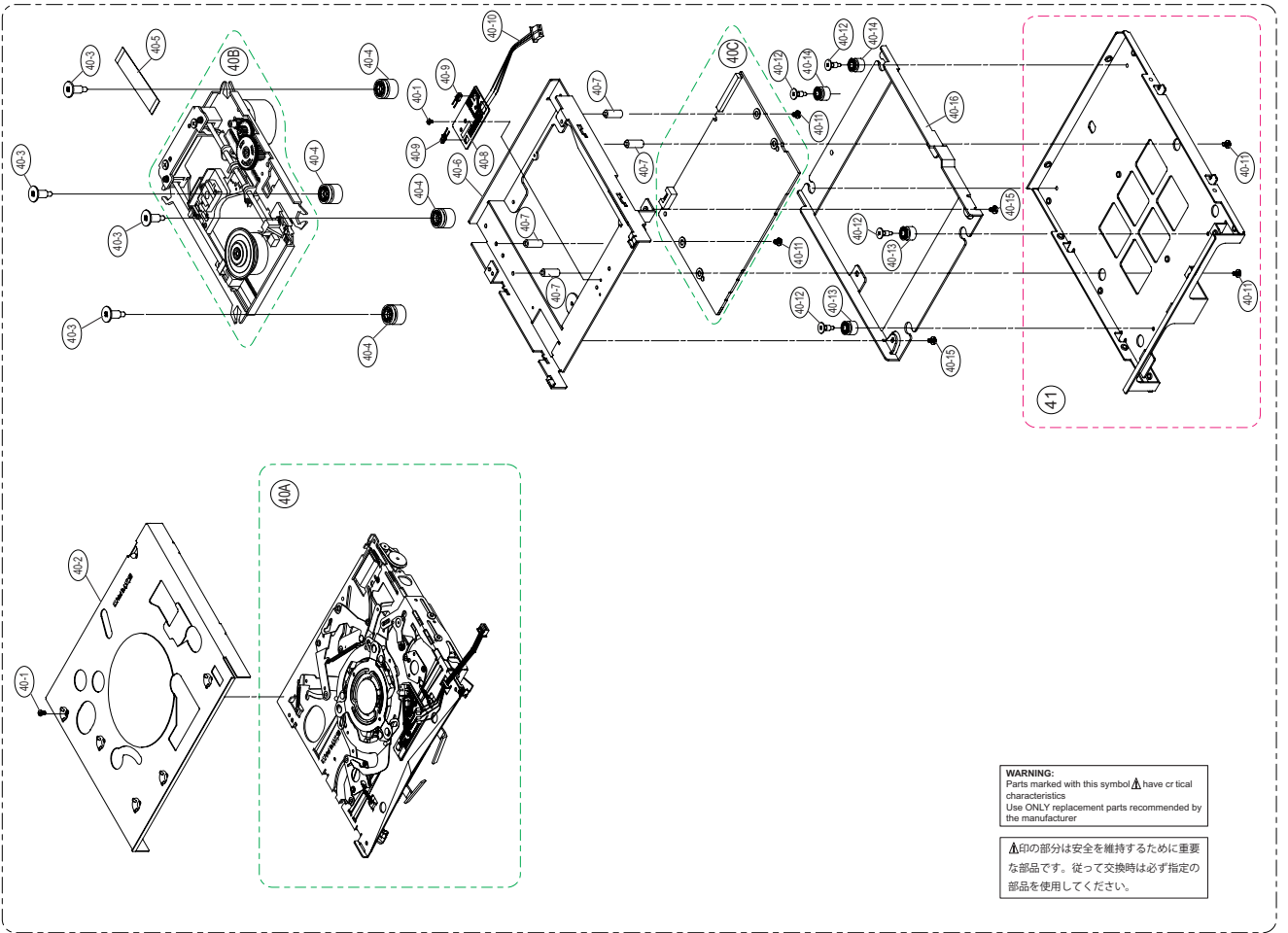

PARTS LIST OF CD MECHANISM UNIT(S-52)

* 本表に "nsp" と記載されている部品は供給できません。

* Parts for which "nsp" is indicated on this table cannot be supplied.

* 本表に記載されている部品は、補修用部品のため製品に使用している部品とは一部、形状、寸法などが異なる場合があります。

* The parts listed below are for maintenance only, might differ from the parts used in the unit in appearances or dimensions.

Ref. No.	Part No.	Part Name	Remarks	Q'ty	New	
40A	00D9KA2A769	FGDVS202MS LOADER UNIT		A2A769	1	*
40B	00D9KA2A770	FGDVS202MS TRAVERSE ASSY		A2A770	1	*
40C	00D9KA2A771	FGDVS202MS PWB AS		A2A771	1	*
40 1	nsp	M2 × 4 BIND S TIGHT CR3		BCS04U3	3	
40 2	nsp	TOP COVER		C8P118	1	
40 3	nsp	SCW DAMPER CR3		C1H012	4	
40 4	00D9KA2G734	DAMPER SI50		A2G734	4	*
40 5	00D9KC2P183	FFC 0.5 24° L70 G		C2P183	1	
40 6	nsp	MAIN BASE		A2P834	1	
40 7	nsp	PCB SHAFT		A2H073	4	
40 8	nsp	SENSOR PCB HF		C8P046	1	
40 9	00D9KECEL012	PT4800BCE00F		ECEL012	2	
40 10	nsp	CNW 3P PN		C8G046	1	
40 11	nsp	M2.6X6 BIND TYPE BK CR3		BDZ06K3	4	
40 12	nsp	SCW DAMPER CR3		C1H013	4	
40 13	00D9KC2G083	DAMPER IDLE		C2G083	2	
40 14	00D9KA2G643	DAMPER SI25 LB		A2G643	2	
40 15	nsp	M2.6X6 BIND S TIGHT CR3		BDS06U3	4	
40 16	nsp	MECHA BRACKET		4125413109	1	
41	nsp	MAIN CHASSIS		4112119102	1	*

PARTS LIST OF PACKING & ACCESSORIES

* 本表に "nsp" と記載されている部品は供給できません。

* Parts for which "nsp" is indicated on this table cannot be supplied.

* 本表に記載されている部品は、補修用部品のため製品に使用している部品とは一部、形状、寸法などが異なる場合があります。

* The parts listed below are for maintenance only, might differ from the parts used in the unit in appearances or dimensions.

Note: The symbols in the column "Remarks" indicate the following destinations.

E3 : U.S.A. & Canada model

E2 : Europe model

EK : U.K. model

JP : Japan model

Ref. No.	Part No.	Part Name	Remarks	Q'ty	New	
1	00D 501 2378 107	CARTON CASE	for S 52E3	1	*	
1	00D 501 2378 110	CARTON CASE	for S 52E2	1	*	
1	00D 501 2378 136	CARTON CASE	for S 52JP	1	*	
1	00D 501 2378 149	CARTON CASE	for S 32E2	1	*	
1	00D 501 2378 152	CARTON CASE	for S 32E3	1	*	
1	00D 501 2378 165	CARTON CASE	for S 52DABEK	1	*	
2	00D 505 0312 073	CABINET COVER		1	*	
3	00D 503 1557 103	CUSHION (L)		1	*	
4	00D 503 1558 102	CUSHION (R)		1	*	
5	00D 502 1144 005	PAD		1	*	
6	00D 502 1148 001	REAR CUSHION	for S 52DABEK	1	*	
7	nsp	ENVELOPE	for INST.MANUAL	1		
8	00D 511 4687 000	INST. MANUAL (E3)	for S 52E3	1	*	
8	00D 511 4688 009	INST. MANUAL (E2)	for S 52E2/DABEK	1	*	
8	00D 511 4690 000	INST. MANUAL (J)	for S 52JP	1	*	
8	00D 511 4691 009	INST. MANUAL (E3)	for S 32E3	1	*	
8	00D 511 4692 008	INST. MANUAL (E2)	for S 32E2	1	*	
9	nsp	S.S.LIST(EX)	for S 52E3/E2/DABEK,S 32E3/E2	1		
10	nsp	T. MEDIA GUIDE SHEET	for S 52E3/E2/DABEK,S 32E3/E2	1	*	
11	nsp	RHAPSODY GUIDE SHEET	for S 52E3,S 32E3	1	*	
12	nsp	XM SHEET	for S 52E3	1		
13	nsp	WARRANTY (HOME)	for S 52E3,S 32E3	1		
14	00D 515 0918 607	SERVICE STATION LIST	for S 52JP	1		
15	nsp	POLY COVER	for ACCESSARY	1		
16	00D 399 1121 008	REMOCON(RC1083)	for S 52	1	*	
17	00D 399 1123 006	REMOCON(RC1089)	for S 32	1	*	
18	nsp	BATTERY (UM 4) ASS		1		
19	00D 231 1152 001	AM LOOP ANTENNA(S)	for S 52E2/DABEK/JP,S 32E2/E3	1		
20	00D 395 0026 005	FM ANT. WIRE	for S 52E2/DABEK,S 32E2	1		
21	00D 395 0034 000	WLAN ANNTENA		1		
!	22	00D 206 2253 000	AC CORD E2 INLET (V)	for S 52E2,S 32E2	1	*
!	22	00D 206 2254 009	AC CORD E3 INLET (V)	for S 52E3,S 32E3	1	*
!	22	00D 206 2256 007	AC CORD J INLET (V)	for S 52JP	1	*
!	23	00D 206 2255 008	AC CORD EK INLET (V)	for S 52DABEK	1	*
	24	00D 146 2519 002	DOCK ADAPTER ASSY		1	*
	25	00D 231 1153 000	AM LOOP ANTENNA(HD)	for S 52E3	1	*
	26	00D 395 0028 003	FM ANT ASS Y(F/WELT)	for S 52E3/JP,S 32E3	1	
	27	00D 395 0030 004	DAB ROOM ANT	for S 52DABEK	1	
	28	nsp	E2 POS LABEL	for S 52E2	1	*
	28	nsp	E2 POS LABEL	for S 32E2	1	*
	28	nsp	UPC LABEL	for S 52E3	1	*
	28	nsp	UPC LABEL	for S 32E3	1	*
	28	00D 517 1530 006	POS LABEL	for S 52JP	1	*
	29	nsp	EK POS LABEL	for S 52DABEK	2	*
	30		CONT.CARD(L)SUB ASSY	for S 52E3/E2/DABEK,S 32E3/E2	1	
	31	00D 515 0920 307	GUARANTEE CARD (M)	for S 52JP	1	
	32	nsp	WIFI LABEL (CARTON)	for S 52E2/DABEK,S 32E2	1	

S32 WIRING DIAGRAM

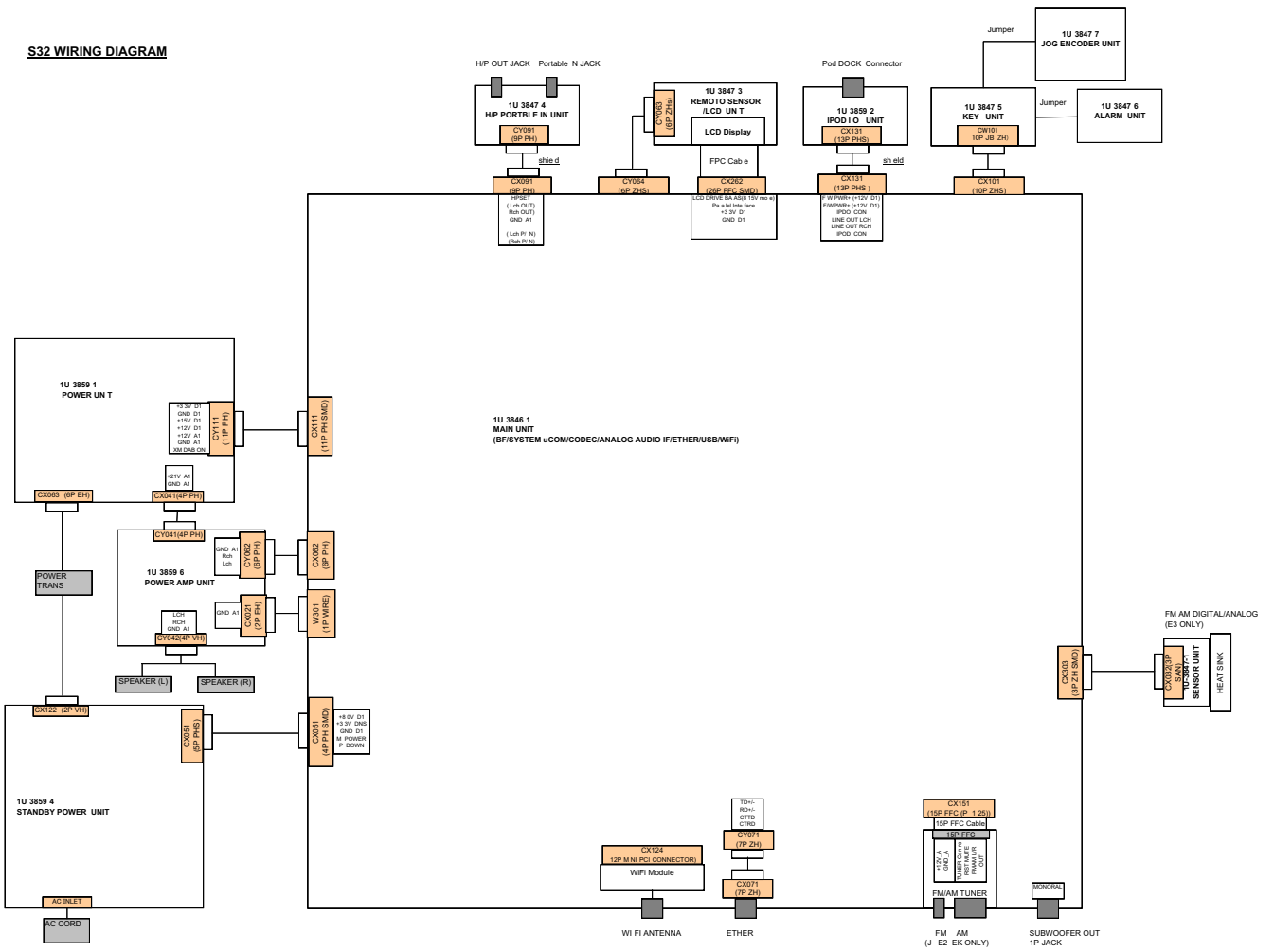

S52 WIRING DIAGRAM

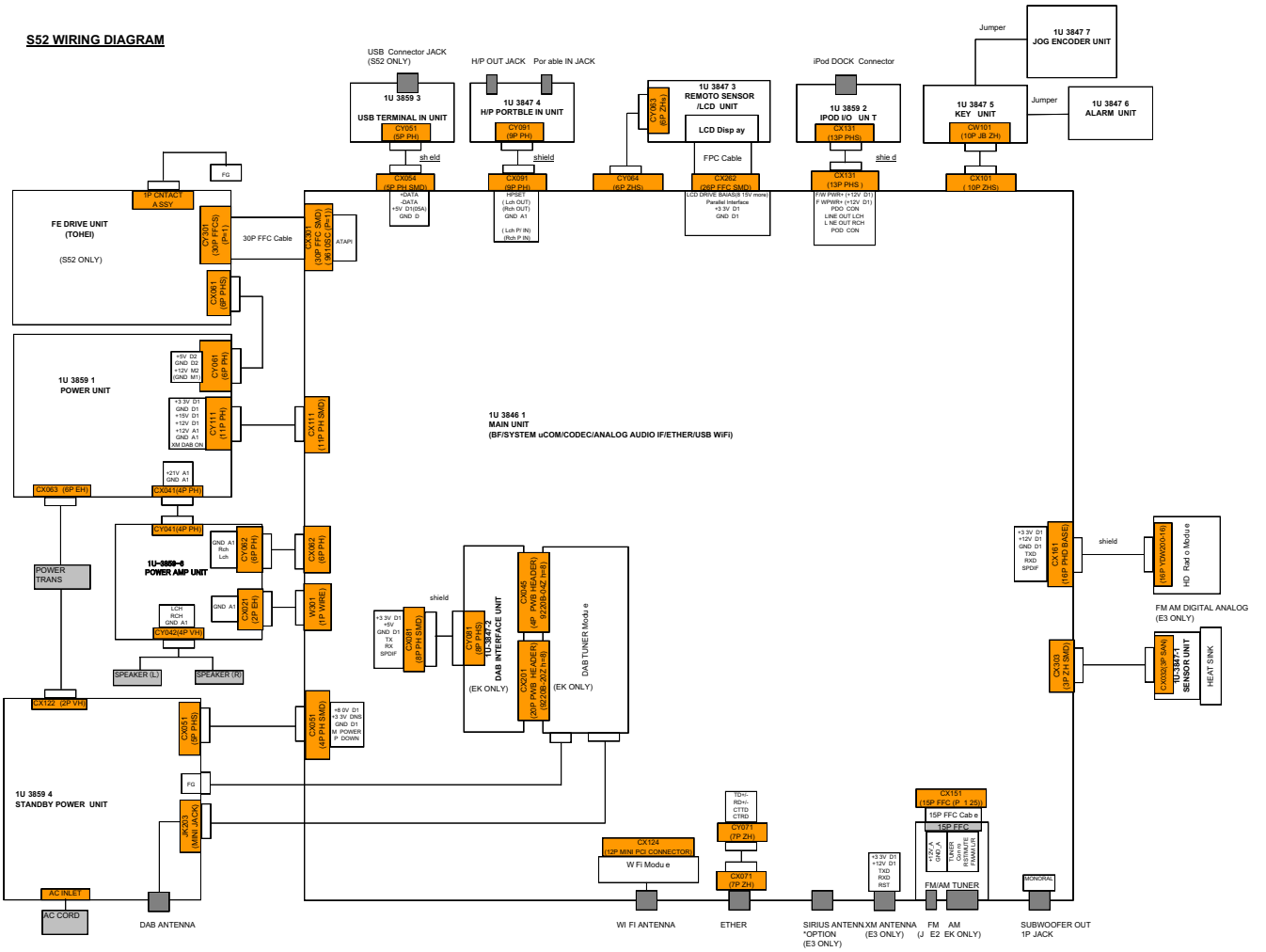

MEASURING METHOD AND WAVEFORMS

To check the waveforms on the FEP, the GND (-) probe of the oscilloscope to "VHALF" point.
(Except for Inner SW, TRVSW)

NOTES

- Measuring Disc: CD/TCD-784
(It is better to use wires for extending between the probe and test points.)
- When watching the HF waveform, use the extending wire as short as possible.
 - When HF waveform is noisy or cannot discriminate the eye-pattern, replace the Traverse Unit after measuring the lop.
 - ① ~ ⑬ points have the certain test points shown below.

各部の波形と測定方法

FEP 基板の波形チェックを行うためにはオシロスコープの GND(-) プローブを "VHALF" ポイントに接続します。

注意

- 測定ディスク： CD/TCD-784
(テストポイントとプローブ間に延長ワイヤを使用するのがより良い方法です。)
- HF 波形を観測する場合、できるだけ短い延長ワイヤを使用してください。
 - HF 波形がノイズで不明瞭、またはアイパターンが識別不能の場合は lop 測定後にトラバースユニットを交換してください。
 - ポイント①～⑬は、下図のように特定テストポイント付きです。

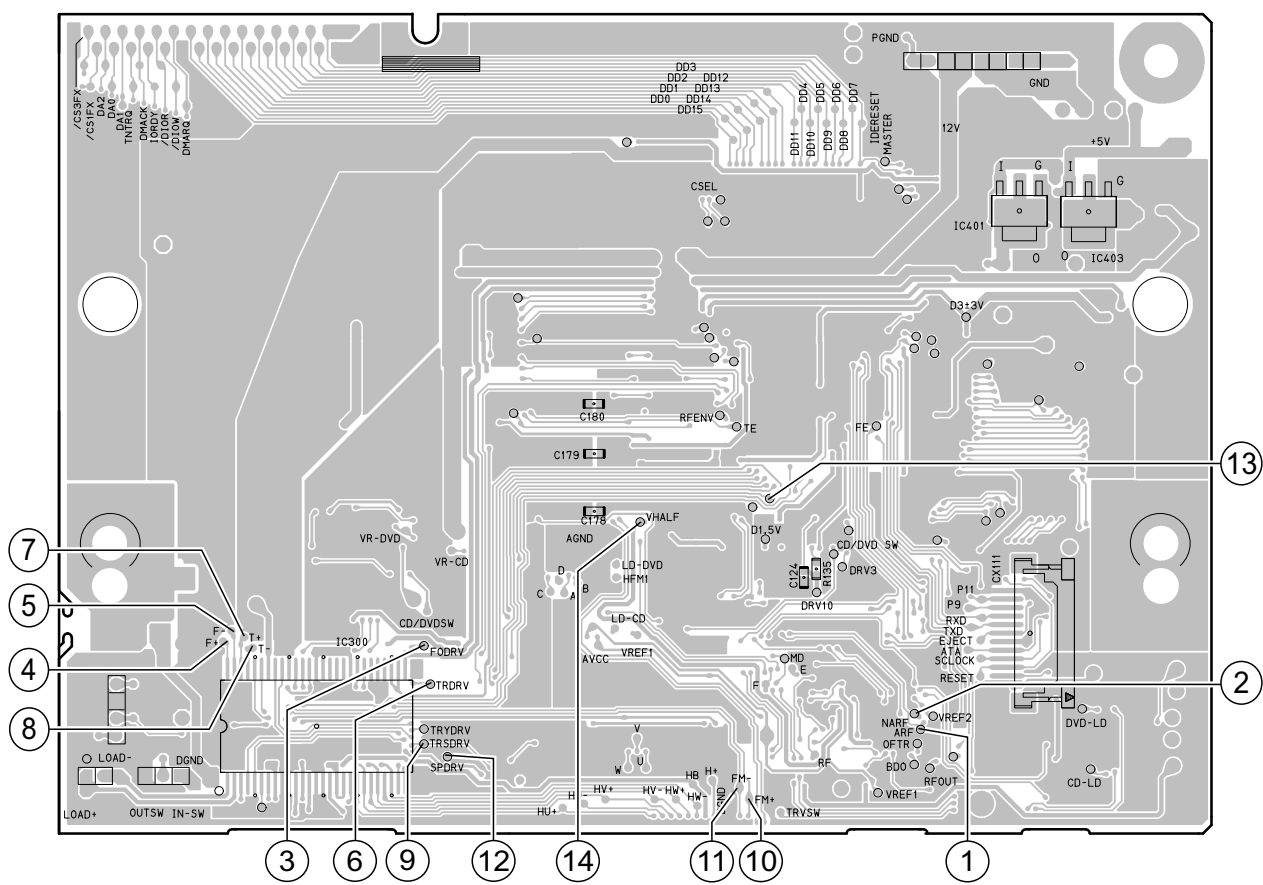

IU-3851 FEP Unit : Foil Side

- * For ARF ①, use NARF ② as the reference (probe ⊖) for the oscilloscope, VHALF ⑭ as the reference voltage for other points.
- * ARF ①は NARF ②をオシロスコープの基準 (プローブ⊖) とし、他のポイントの基準電圧は VHALF ⑭です。

WAVEFORMS
IU-3851 FEP Unit

CD PLAY Disc : TCD-784

RF waveform

- ① ARF
- ② NARF

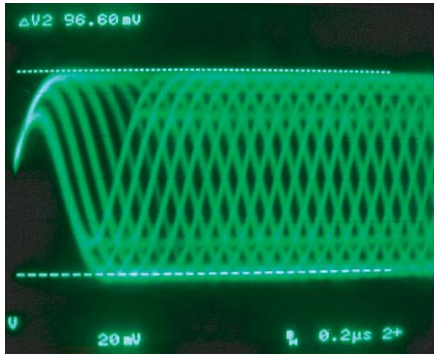

RANGE ② 2 v 2 μ sec

SEARCH (INNER → OUTER)

- ⑨ TRSDRV
- ⑩ FM+
- ⑪ FM

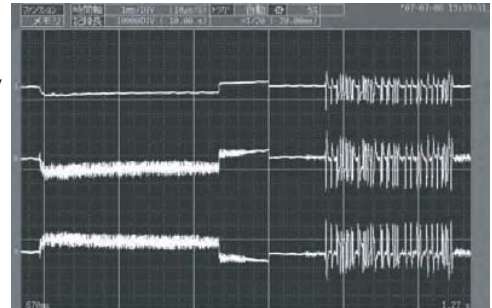

RANGE ⑨ 1 v
 ⑩ 1 v 20 msec
 ⑪ 1 v

CD LOADING → PLAY

- ③ FODRV
- ④ F+
- ⑤ F



RANGE ③ .5 v
 ④ .5 v 0.5 sec
 ⑤ .5 v

CD PLAY (INNER)

- ⑫ SPDRV
- ⑬ FG

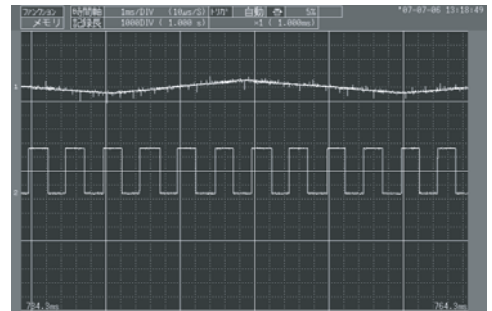

RANGE ⑫ .1 v 1 msec
 ⑬ 1 v

CD PLAY

- ⑥ TRDRV
- ⑦ T+
- ⑧ T

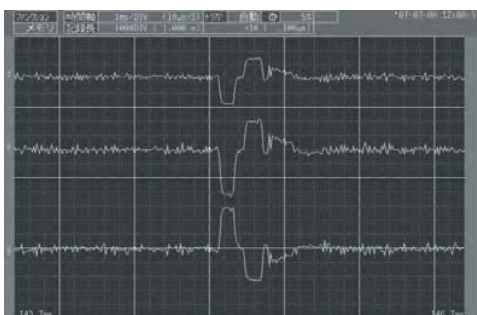

RANGE ⑥ .2 v
 ⑦ .2 v 100 μ sec
 ⑧ .2 v

IU-3846 MAIN Unit

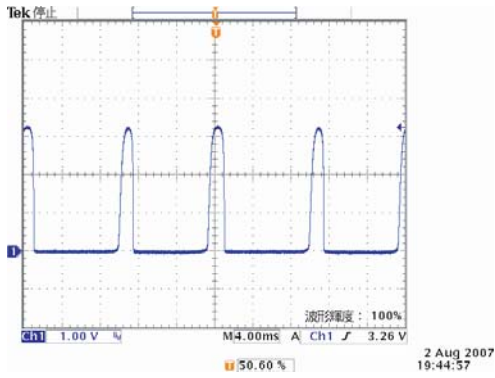

Ⓐ Wave form 1: PWR_OFF_DET 50/60 Waveform
 波形1: 停電検出50/60波形
 CX051 5pin
 (Refer to the SCHEMATIC DIAGRAMS 4/7)
 (SCHEMATIC DIAGRAMS 4/7を参照)

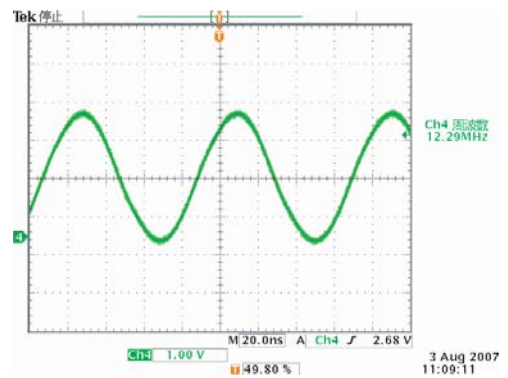

Ⓒ Wave form 3 : CLOCK Waveform (12.288MHz)
 波形3: クロック波形 (12.288MHz)
 X301
 (Refer to the SCHEMATIC DIAGRAMS 3/7)
 (SCHEMATIC DIAGRAMS 3/7を参照)

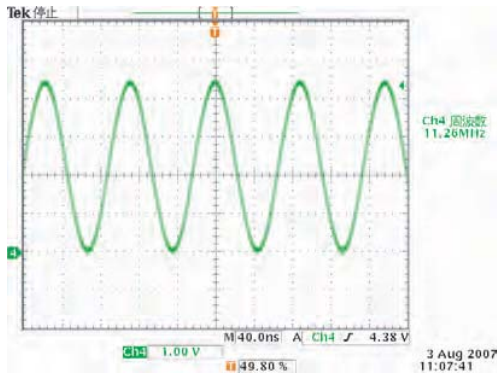

Ⓑ Wave form 2 : CLOCK Waveform (11.2896MHz)
 波形2: クロック波形 (11.2896MHz)
 X302
 (Refer to the SCHEMATIC DIAGRAMS 3/7)
 (SCHEMATIC DIAGRAMS 3/7を参照)

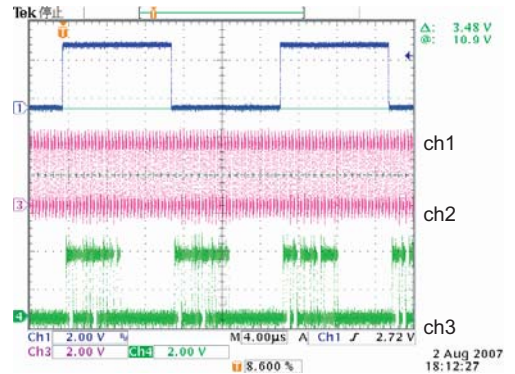

Ⓓ Wave form 4 : A/D Waveform
 波形4: A/D波形
 CH1: IC300 10pin
 CH2: IC300 11pin
 CH3: IC300 32pin
 (Refer to the SCHEMATIC DIAGRAMS 3/7)
 (SCHEMATIC DIAGRAMS 3/7を参照)

IU-3859-6 POWER AMP Unit

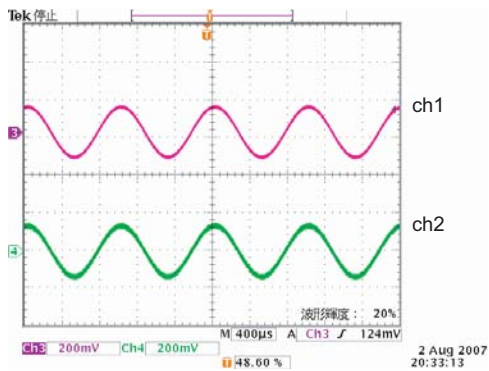

Ⓔ Wave form 5 : Power Amp In Waveform
 波形5: パワーアンプ入力波形
 CH1: IC505 2pin
 CH2: IC505 4pin
 (Refer to the SCHEMATIC DIAGRAMS 6/7)
 (SCHEMATIC DIAGRAMS 6/7を参照)

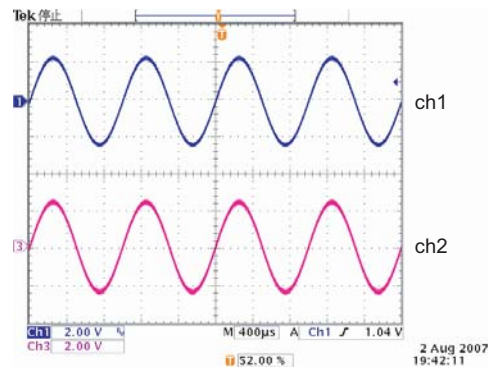

Ⓕ Wave form 6 : Speaker In Waveform
 波形6: スピーカー入力波形
 CH1: CY042 1pin
 CH2: CY042 4pin
 (Refer to the SCHEMATIC DIAGRAMS 6/7)
 (SCHEMATIC DIAGRAMS 6/7を参照)

NOTE FOR SCHEMATIC DIAGRAM

WARNING:

Parts marked with this symbol  have critical characteristics. Use ONLY replacement parts recommended by the manufacturer.

CAUTION:

Before returning the unit to the customer, make sure you make either (1) a leakage current check or (2) a line to chassis resistance check. If the leakage current exceeds 0.5 milliamps, or if the resistance from chassis to either side of the power cord is less than 460 kohms, the unit is defective.

WARNING:

DO NOT return the unit to the customer until the problem is located and corrected.

NOTICE:

ALL RESISTANCE VALUES IN OHM. k 1,000 OHM
M 1,000,000 OHM
ALL CAPACITANCE VALUES IN MICRO FARAD.
P MICRO-MICRO FARAD
EACH VOLTAGE AND CURRENT ARE MEASURED AT
NO SIGNAL INPUT CONDITION.
CIRCUIT AND PARTS ARE SUBJECT TO CHANGE
WITHOUT PRIOR NOTICE.

配線図について

印の部品は安全を維持するために重要な部品です。従って交換時は必ず指定の部品を使用してください。

注)

- (1) 指定なき抵抗値は Ω、k は kΩ、M は MΩ を示す。
- (2) 指定なきコンデンサーの値は μF、p は pF を示す。
- (3) 各部の電圧は無信号の値を示す。
- (4) この配線図は基本配線図です。改良等のため変更することがありますのでご了承ください。

1 2 3 4 5 6 7 8

1U-3846-1
MAIN UNIT
[BF block]

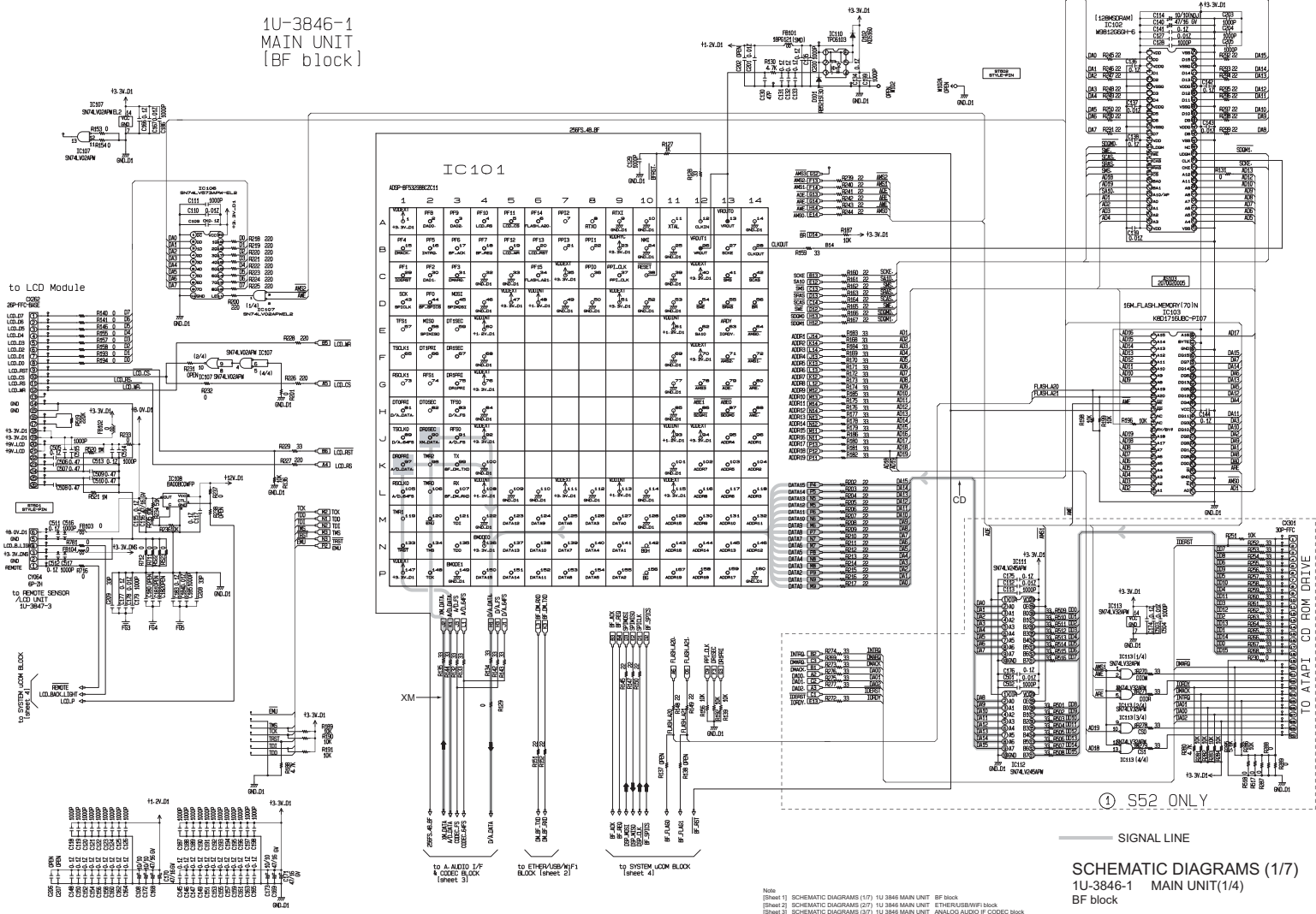

SCHEMATIC DIAGRAMS (1/7)
1U-3846-1 MAIN UNIT(1/4)
BF block

Note
[Sheet 1] SCHEMATIC DIAGRAMS (1/7) 1U-3846 MAIN UNIT BF block
[Sheet 2] SCHEMATIC DIAGRAMS (2/7) 1U-3846 MAIN UNIT ETHERNET I/F CODEC block
[Sheet 3] SCHEMATIC DIAGRAMS (3/7) 1U-3846 MAIN UNIT ANALOG AUDIO I/F CODEC block
[Sheet 4] SCHEMATIC DIAGRAMS (4/7) 1U-3846 MAIN UNIT SYSTEM UCOM block

SCHEMATIC DIAGRAMS (2/7)

S-52 / S-52DAB / S-

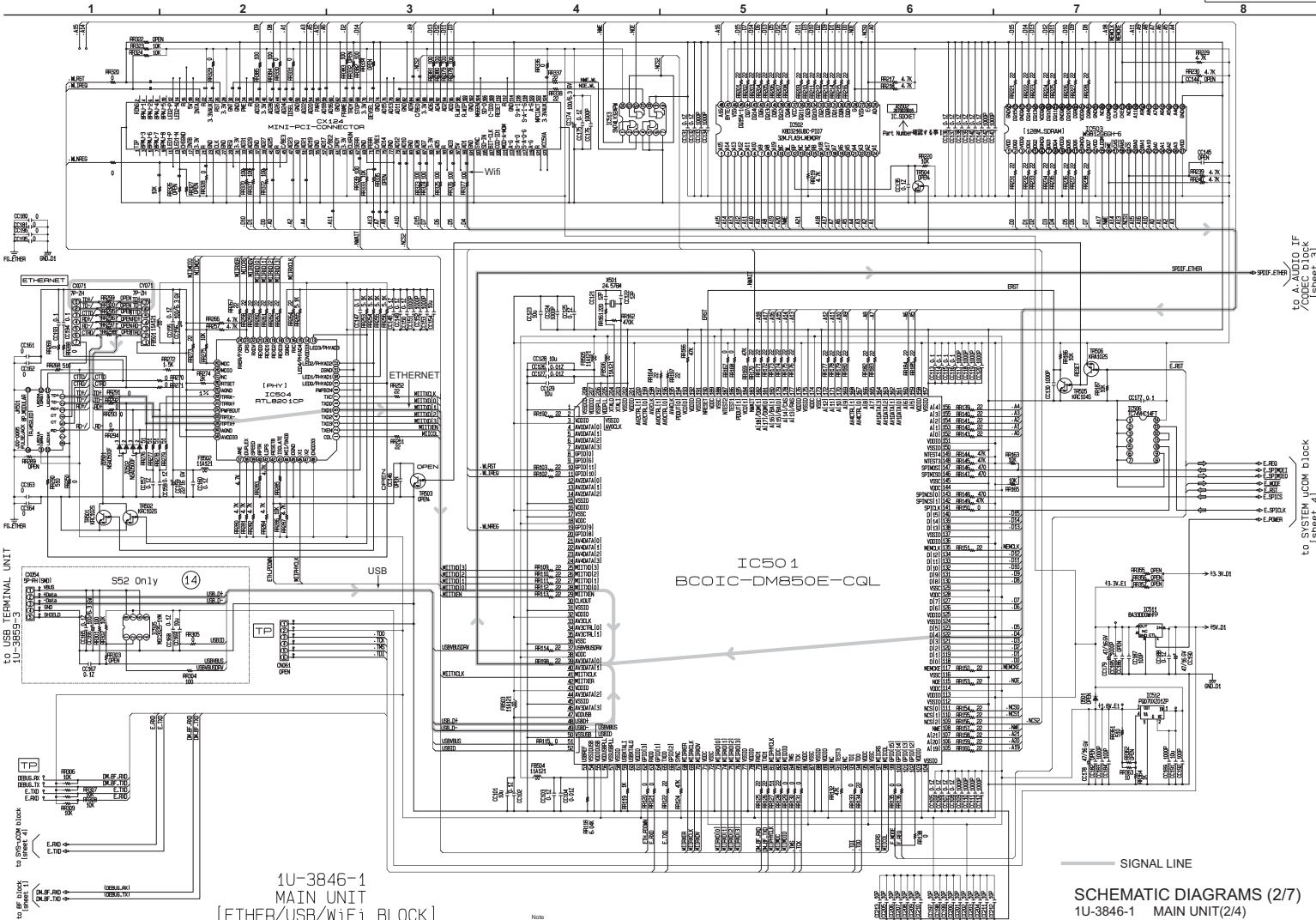

1U-3846-1
MAIN UNIT
(ETHER/USB/WiFi BLOCK)

SIGNAL LINE

SCHEMATIC DIAGRAMS (2/7)
1U-3846-1 MAIN UNIT(2/4)
ETHER/USB/WiFi block

Note:
[Schem 1] SCHEMATIC DIAGRAMS (1/7) 1U 3846 MAIN UNIT BF block
[Schem 2] SCHEMATIC DIAGRAMS (2/7) 1U 3846 MAIN UNIT ETHER/USB/WiFi block
[Schem 3] SCHEMATIC DIAGRAMS (3/7) 1U 3846 MAIN UNIT ANALOG AUDIO FILTER block
[Schem 4] SCHEMATIC DIAGRAMS (4/7) 1U 3846 MAIN UNIT SYSTEM UCOM block

SCHEMATIC DIAGRAMS (4/7)

S-52 / S-52DAB / S-

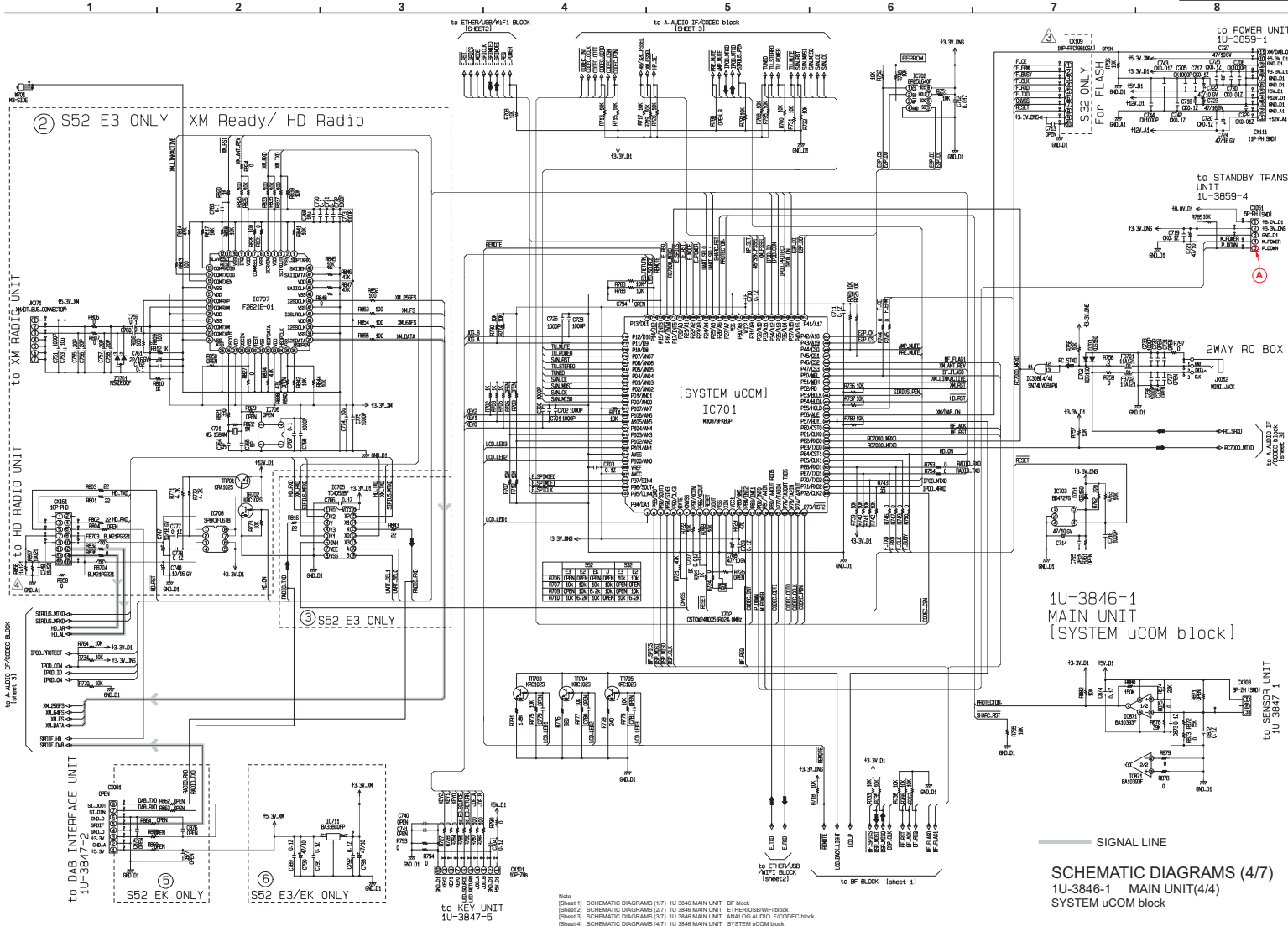

Note
 [Sheet 1] SCHEMATIC DIAGRAMS (1/7) 1U 3846 MAIN UNIT BF block
 [Sheet 2] SCHEMATIC DIAGRAMS (2/7) 1U 3846 MAIN UNIT ETHERNET/WIFI block
 [Sheet 3] SCHEMATIC DIAGRAMS (3/7) 1U 3846 MAIN UNIT ANALOG AUDIO/CODEC block
 [Sheet 4] SCHEMATIC DIAGRAMS (4/7) 1U 3846 MAIN UNIT SYSTEM uCOM block

SIGNAL LINE
 SCHEMATIC DIAGRAMS (4/7)
 1U-3846-1 MAIN UNIT(4/4)
 SYSTEM uCOM block

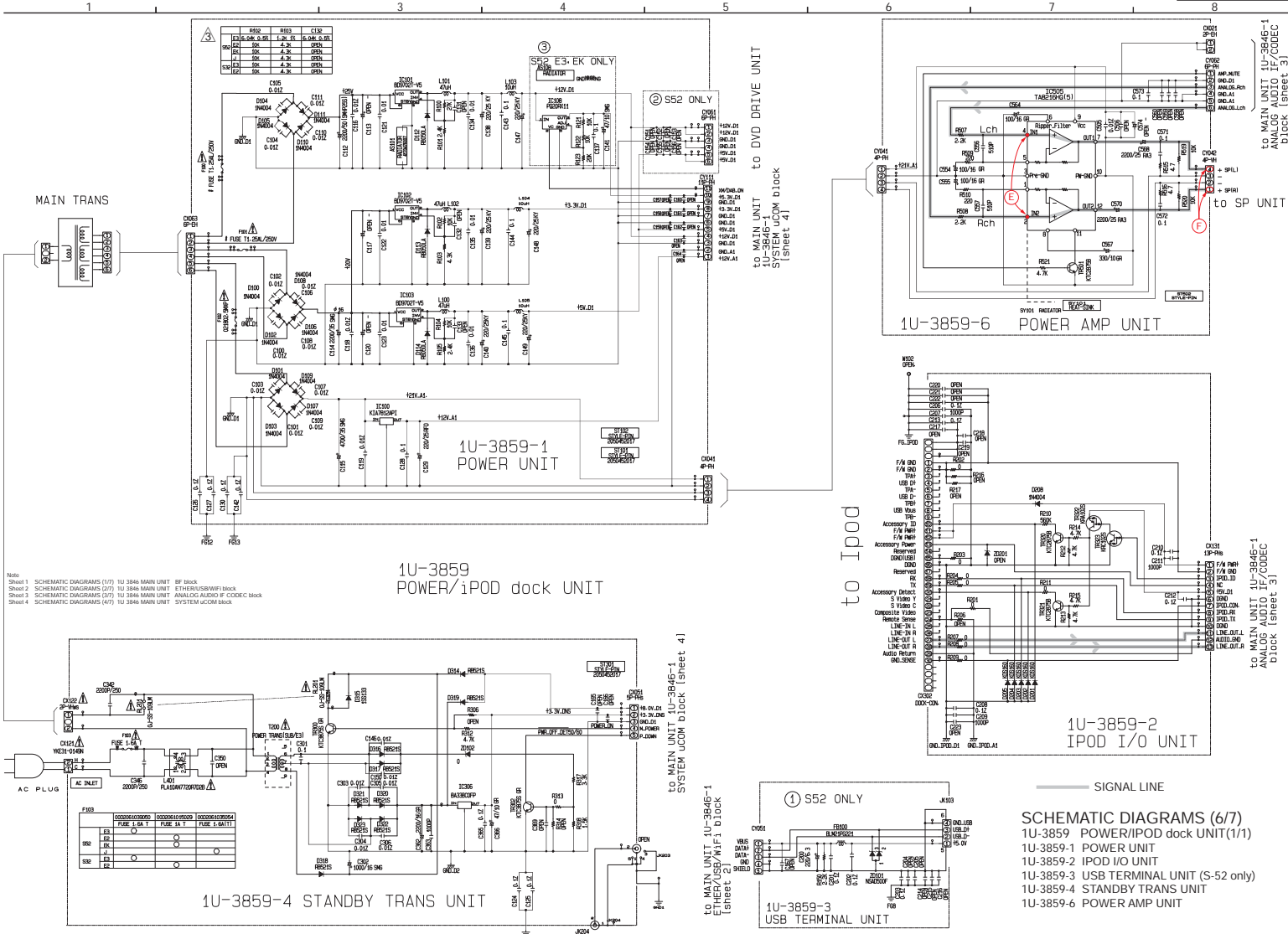

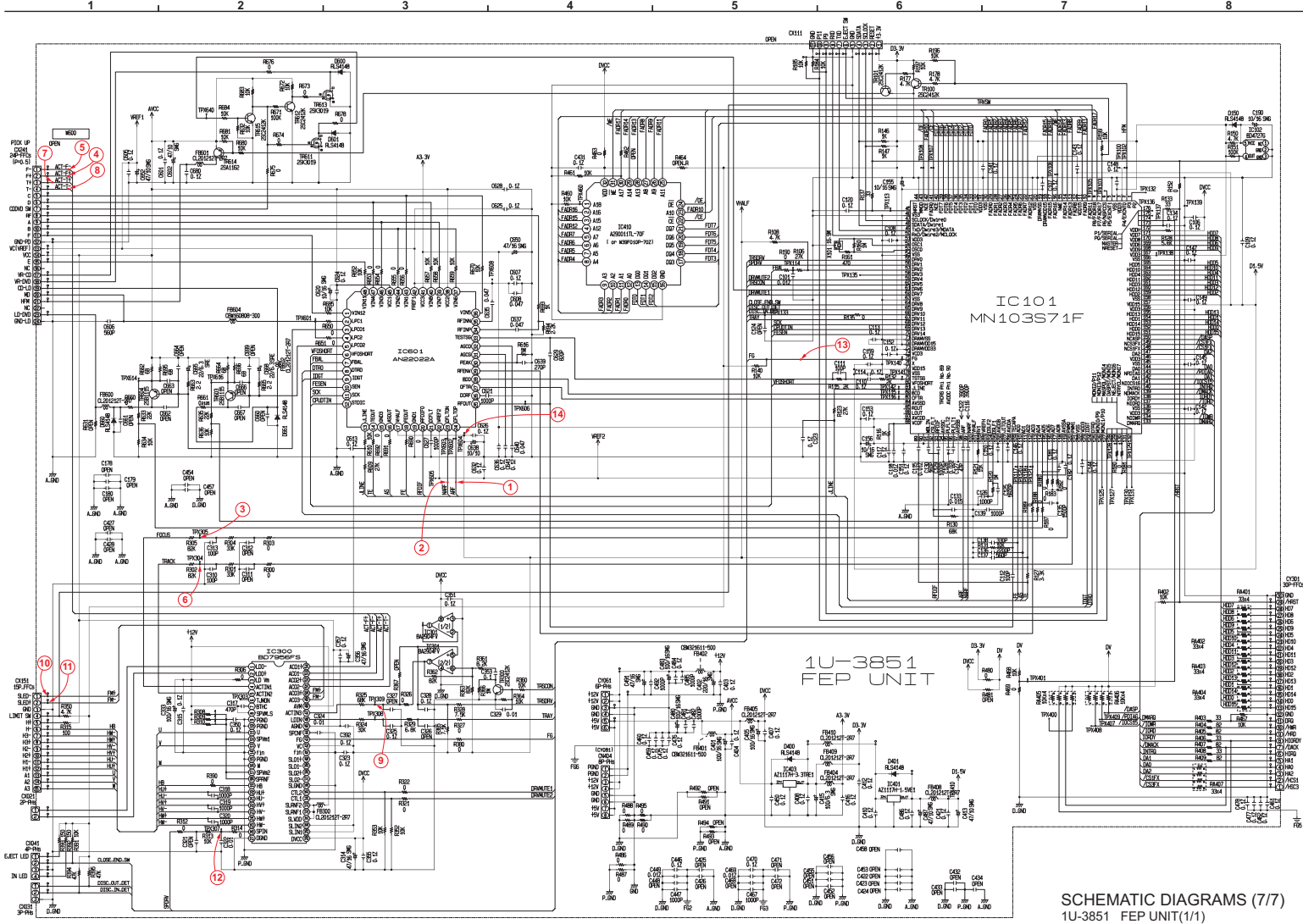

SCHEMATIC DIAGRAMS (7/7)
1U-3851 FEP UNIT(1/1)