

Dual

Service-Anleitung
Service Manual
Instructions de Service

CT 7040

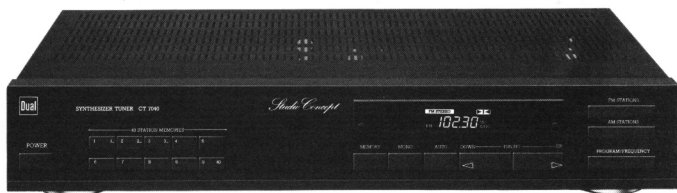

Technische Daten (typische Werte)	Specifications (typical values)	Caractéristiques techniques (valeurs types)	Dati tecnici (valori tipici)	Dual CT 7040
Empfangsbereiche FM (LWV) AM (MW) AM (LW)	Reception wavebands FM (VHF) AM (MW) AM (LW)	Games de fréquences FM (G) AM (P) AM (G)	Campi di ricezione FM (LWV) AM (onde medie) AM (onde lunghe)	87 – 108 MHz 522 – 1611 kHz 153 – 279 kHz
Empfindlichkeit (an 75 Ω) FM – Mono (26 dB) FM – Stereo (46 dB)	Sensitivity (at 75 Ω) FM – mono (26 dB) FM – stereo (46 dB)	Sensibilité (à 75 ohms) FM – Mono (26 dB) FM – Stéréo (46 dB)	Sensibilità (su 75 ohms) FM – mono (26 dB) FM – stereo (46 dB)	1,0 µV 32 µV
Trennschärfe FM stat./dyn.	FM selectivity stat./dyn.	Sélectivité FM stat./dyn.	Selettività FM stat./dyn.	80/70 dB
Geräuschspannungsabstand	Signal/noise ratio	Rapport signal/bruit	Rapporto segnale disturbo	70 dB
Netzspannung Model Europa Model USA/Kanada	Mains voltage European model US/Canadian model	Voltage secteur Modèle Europe Modèle USA/Canada	Tensione di rete modello Europa modello Stati Uniti/Canada	230 V/50 Hz 120 V/60 Hz
Maße (Breite × Höhe × Tiefe)	Dimensions (width × height × depth)	Dimensions (largeur × hauteur × profondeur)	Dimensioni (larghezza × altezza × profondità)	440 × 82 × 245 mm

Abgleichanleitung CT 7040

Signalquelle	Einstellung Gerät	Einstellung Signalquelle	Meßgerät Anschluß	Abgleichposition	Abgleich, Bemerkung
FM-Oszillator					
	108 MHz			L 10	8,3 V DC \pm 0,2 V
	87,5 MHz				Kontrolle: 2,0–2,5 V DC
FM-ZF, Vorkreis					
FM-Meßsender an 75 Ohm Antenneneingang	Senderfreie Frequenz ca. 98 MHz	0–1 mV Hub \pm 40 kHz Mod. 1 kHz ca. 98 MHz auf Deckung	Klirrfaktormeßbrücke Oszilloskop an NF-Ausgang	T 101	NF-Maximum
				T 102	
	90 MHz	ca. 90 MHz auf Deckung		L 1/L 2, L 3/L 4, L 5	NF und Klirrfaktor Minimum
	105 MHz	ca. 105 MHz auf Deckung		CT 1, CT 2, CT 3	NF-Maximum
				Vorkreisabgleich wiederholen	
FM-ZF (Feinabgleich)					
Antenne an 75 Ohm Antenneneingang	Starken FM-Sender auf seiner Sollfrequenz empfangen		DC-Voltmeter an: TP 2–TP 3	T 103	DC-Maximum und DC-Minimum ermitteln
				T 103	
				T 102	0 V \pm 1 mV DC
Pilotfrequenz 76 kHz, Kanaltrennung					
FM-Meßsender an 75 Ohm Antenneneingang	Senderfreie Frequenz ca. 98 MHz	ca. 98 MHz auf Deckung Hub \pm 40 kHz, Mod. 1 kHz 1–2 mV, ohne Pilotton mit 19 kHz Pilot	Frequenzzähler an TP 5	VR 301	76 kHz \pm 50 Hz
			NF-Voltmeter, Oszilloskop an NF-Ausgang	VR 302	Maximale Kanaltrennung
Unterdrückung Pilottonreste (19 kHz)					
FM-Meßsender an 75 Ohm Antenneneingang	Senderfreie Frequenz ca. 98 MHz	Senderfreie Frequenz ca. 98 MHz auf Deckung 1–2 mV, 19 kHz Pilot ein	NF-Voltmeter Oszilloskop an NF-Ausgang	T 302 (l-K)	Minimum
				T 301 (r-K)	
Suchlaufschwelle					
FM-Meßsender an 75 Ohm Antenneneingang	Senderfreie Frequenz ca. 98 MHz	ca. 98 MHz auf Deckung Hub \pm 40 kHz, Mod. 1 kHz 10 μ V	Kontrolle am Display	VR 101	► ◀ Anzeige muß aufleuchten
AM-Oszillator					
	520 kHz		DC-Voltmeter an TP 1	T 201	0,65 V DC \pm 0,05 V
	1619 kHz			TC 203	9,0 V DC \pm 0,4 V
	150 kHz			T 202	1,6 V DC \pm 0,1 V
	283 kHz			TC 204	5,4 V DC \pm 0,4 V
AM-ZF, Vorkreis					
AM Meßsender an 75 Ohm Antenneneingang	999 kHz	20 μ V–1 mV, 1 kHz, Mod. 30 % 999 kHz		T 203, T 204	Maximum
	594 kHz	594 kHz		MW Ferritantenne	
	1404 kHz	1404 kHz		TC 201	
	162 kHz	162 kHz		LW Ferritantenne	
	252 kHz	252 kHz		TC 202	

(R 501 für Displayhelligkeit)

Tuning Instructions for CT 7040

Signal source	Equipment setting	Signal source setting	Connection of measuring instrument	Item to be tuned	Tuning, Remarks
FM oscillator					
	108 MHz			L 10	8.3 V DC \pm 0.2 V
	87.5 MHz				Check: 2.0 - 2.5 V
FM IF, input circuit					
FM signal generator to 75-ohm antenna input	Frequency without transmitters approx. 98 MHz	0 - 1 mV, Shift \pm 40 kHz Mod. 1 kHz Tune to approx. 98 MHz	Harmonic detector oscilloscope to AF output	T 101	AF maximum
		T 102			
	90 MHz	Tune to approx. 90 MHz		T 103	AF and harmonic distortion minimum
	105 MHz	Tune to approx. 105 MHz		L 1/L 2, L 3/L 4, L 5	AF maximum
				TC 1, TC 2, TC 3	
Repeat input-circuit tuning					
FM IF (fine tuning)					
Antenna to 75-ohm antenna input	Receive strong FM transmitter at its nominal frequency		DC voltmeter to: TP 2 - TP 3	T 103	Determine DC maximum and DC minimum
				T 103	Adjust power mean
				T 102	0 V \pm 1 mV DC
				Repeat tuning	
Pilot frequency 76 kHz, channel separation					
FM signal generator to 75-ohm antenna input	Frequency without transmitters approx. 98 MHz	Tune to approx. 98 MHz, Shift \pm 40 kHz, Mod. 1 kHz, 1 - 2 mV, without pilot tone	Frequency counter to TP 5	VR 301	76 kHz \pm 50 Hz
		with 19-kHz pilot	AF voltmeter, oscilloscope to AF output	VR 302	Maximum channel separation
Suppression of residual pilot frequencies (19 kHz)					
FM signal generator to 75-ohm antenna input	Frequency without transmitters approx. 98 MHz	Frequency without transmitters Tune to approx. 98 MHz 1 - 2 mV, 19-kHz pilot ON	AF voltmeter, oscilloscope to AF output	T 302 (left channel)	Minimum
				T 301 (right channel)	
Search threshold					
FM signal generator to 75-ohm antenna input	Frequency without transmitters approx. 98 MHz	Tune to approx. 98 MHz, Shift \pm 40 kHz, Mod. 1 kHz 10 μ V	Check the display	VR 101	► ◀ Display must light up
AM oscillator					
	520 kHz		DC voltmeter to TP 1	T 201	0.65 V DC \pm 0.05 V
	1619 kHz			TC 203	9.0 V DC \pm 0.4 V
	150 kHz			T 202	1.6 V DC \pm 0.1 V
	283 kHz			TC 204	5.4 V DC \pm 0.4 V
AM IF, input circuit					
AM signal generator to 75-ohm antenna input	999 kHz	20 μ V - 1 mV, 1 kHz Mod. 30% 999 kHz		T 203, T 204	Maximum
	594 kHz	594 kHz		AM ferrite-rod antenna	
	1404 kHz	1404 kHz		TC 201	
	162 kHz	162 kHz		LW ferrite-rod antenna	
	252 kHz	252 kHz		TC 202	

(R 501 for display brightness)

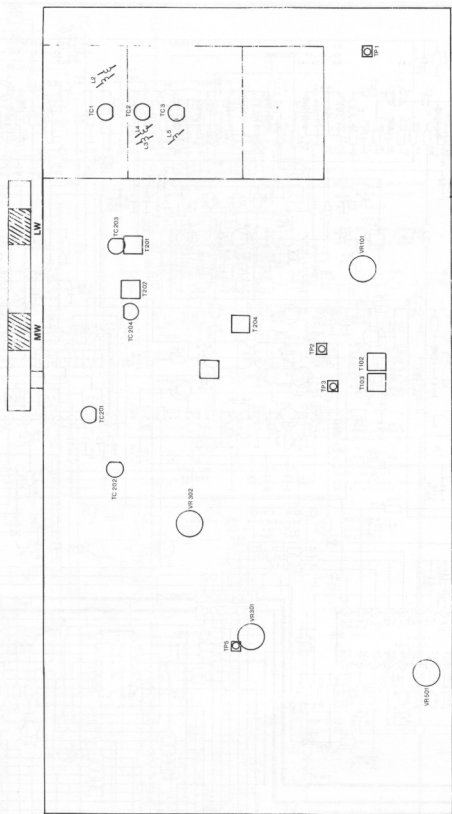

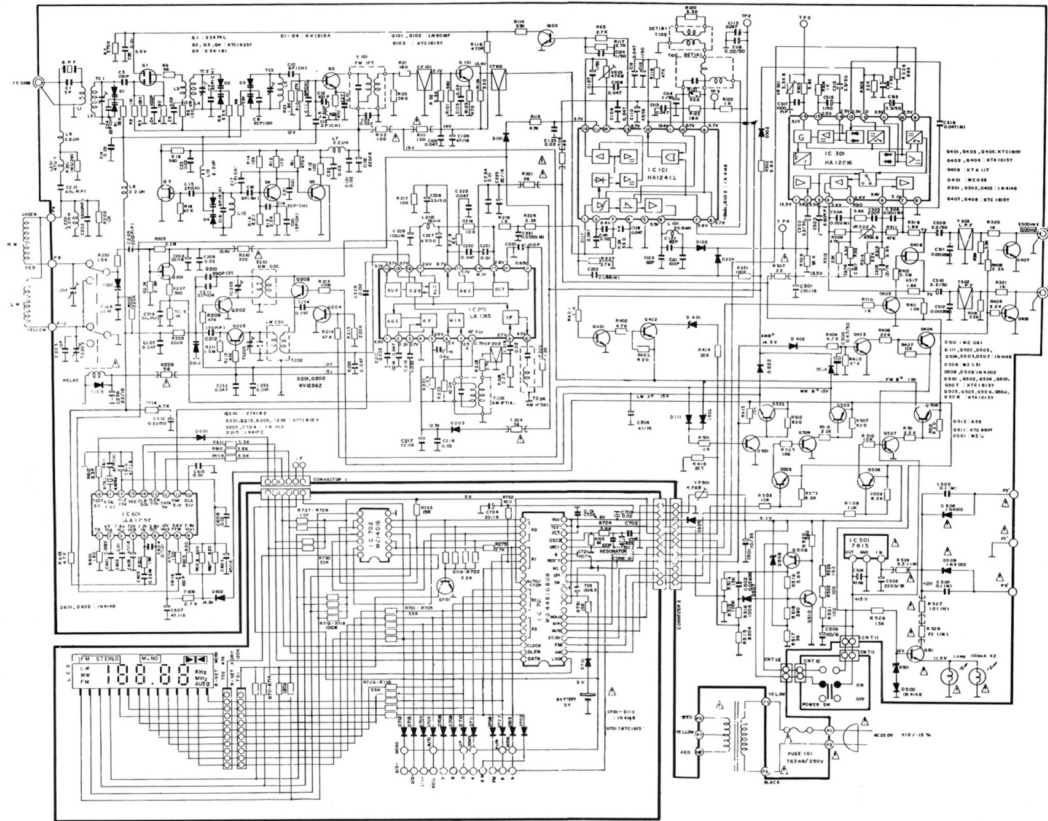

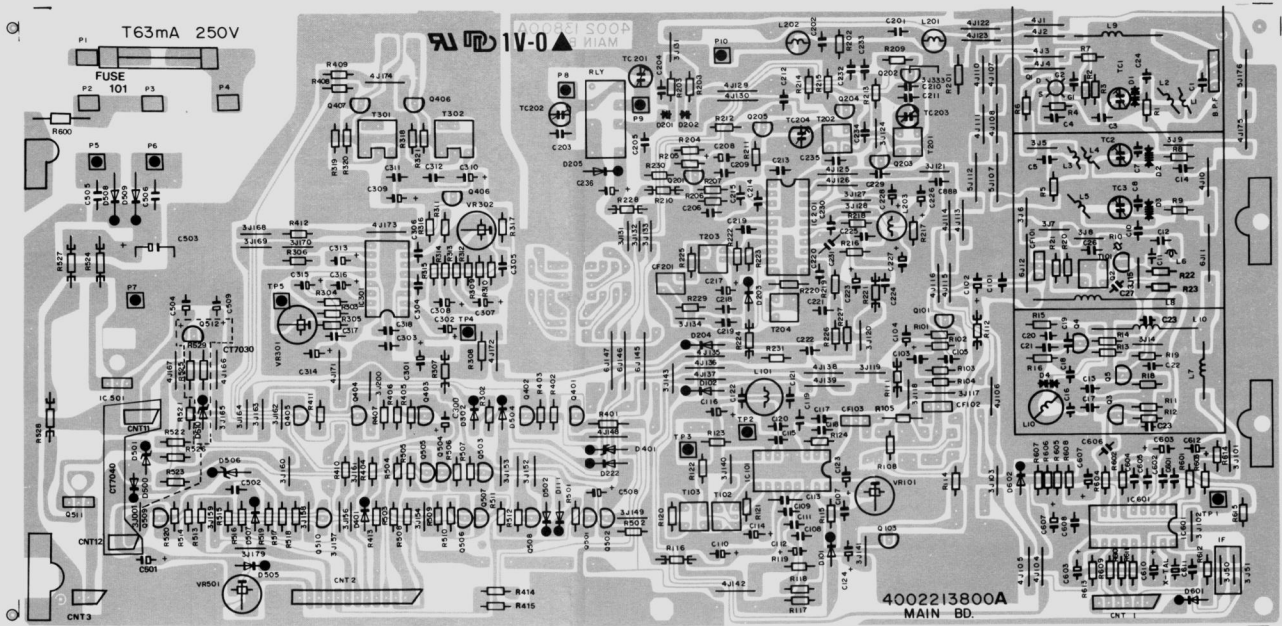

Frontplatte
Front P.C.B.

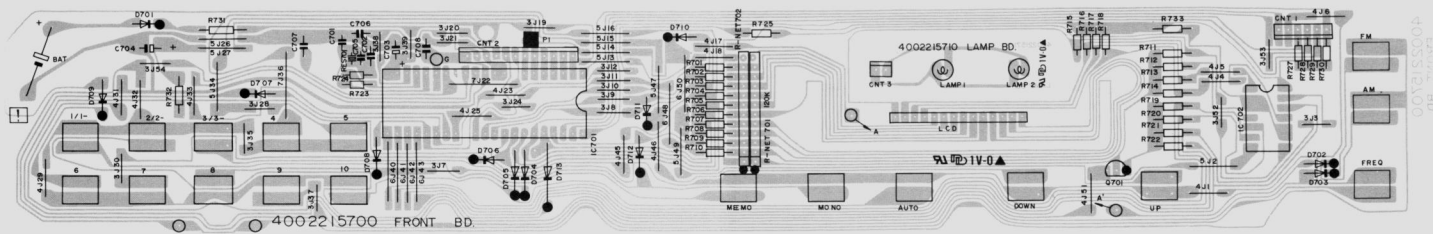

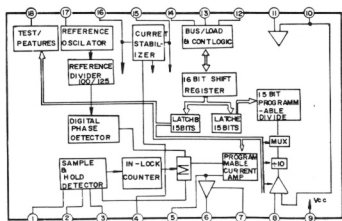

SAA 1057

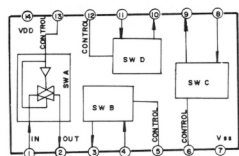

MC 14016B



LM 9018 F



KTC 1815 Y
KTC 1923 Y



25 SK 117 Y



KTK 161 Y
2 SK 192 GR



KTD 880 Y



7815



3 SK74L



MC 14016 BCP



HA 12412
HA 12016



SAA 1057



LA 1245

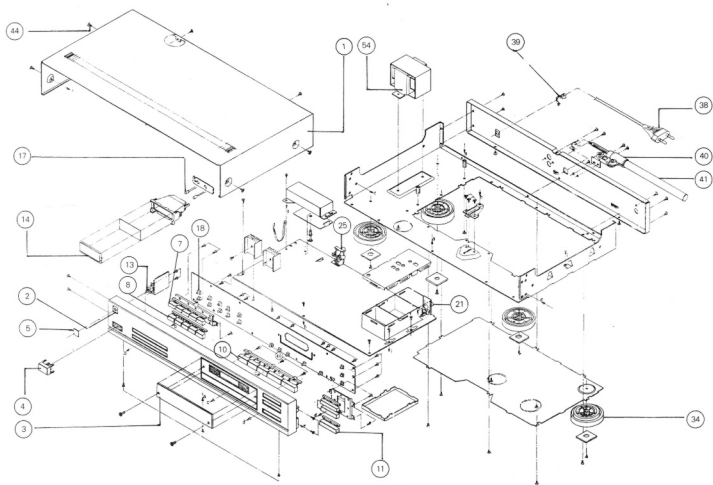

Ersatzteile · Replacement parts · Pièces détachées · CT 7040

Pos.	Art.-Nr.	Bezeichnung
1	283 678	Gehäuseblech
2	284 341	Frontblende
3	284 340	Fenster
4	283 665	Netztaсте
5	283 750	Dual-Zeichen
7	284 668	Tasten (1-5)
8	284 342	Tasten (6-10)
10	284 343	Taste (Funktion)
11	284 344	Taste A
13	284 318	Netzschalter
14	284 345	Display
17	282 344	Lampe
18	280 197	Schalter
21	282 346	Antennenbuchse
25	282 347	Cinchbuchse 3 x 8
34	283 710	Geräteeufs
38	243 750	Netzkabel Europa
39	237 548	Kabeldurchführung
40	282 349	Antennenhalter
41	282 350	MW/LW Antenne
44	282 523	Schraube 3 x 8
54	282 216	Transformator
Grundplatte		
L 1	284 779	Spule FM
L 2	282 221	Spule
L 3	284 780	Spule FM RF
L 4	282 221	Spule
L 5	282 221	Spule
L 6	282 324	Spule 2,2 UH
L 7	282 191	Spule 2,2 UH
bis		
L 9	282 191	Spule 2,2 UH
L 10	283 327	Diode 1 SS 132
L 101	282 194	Spule 20,8 UH
L 201	282 192	Spule 47 UH
L 202	282 195	Spule 2,2 UH
L 203	282 325	Spule 36 MH
T 101	284 781	Spule FM IFT
T 102	282 183	Spule
T 103	282 184	Spule
T 201	282 326	Spule MW
T 202	282 327	Spule LW
T 203	282 189	Spule AM IFT
T 204	282 188	Spule AM IFT
T 301	282 321	Spule MPX
T 302	282 321	Spule MPX
B.PF	282 222	Filter Band Pass
X-TAL	281 411	Quarz 4 MHz
RLY	282 176	Relay RZ 12
CF 101	284 782	Keramikfilter SFE 10,7 MS 3 GH
CF 102	284 782	Keramikfilter SFE 10,7 MS 3 GH
CF 201	282 198	Keramikfilter SFP 455
D 1	282 320	Diode KV 1310 A-3
bis		
D 4	282 320	Diode KV 1310 A-3
D 101	223 906	Diode 1 N 4148
bis		
D 111	223 906	Diode 1 N 4148
D 201	282 223	Diode KV 1236
bis		
D 202	282 223	Diode KV 1236

Pos.	Art.-Nr.	Bezeichnung
D 203	223 906	Diode 1 N 4148
bis		
D 204	223 906	Diode 1 N 4148
D 205	226 501	Diode 1 N 4002
D 222/D 302	223 906	Diode 1 N 4148
D 401	282 078	Diode DZ 3,3 B
D 402/D 500	223 906	Diode 1 N 4148
D 501	282 063	Diode DZ 12 BM
D 502	223 906	Diode 1 N 4148
D 504	223 906	Diode 1 N 4148
bis		
D 505	223 906	Diode 1 N 4148
D 506	283 552	Diode DZ 5,6
D 507	223 906	Diode 1 N 4148
D 508	226 501	Diode 1 N 4002
bis		
D 509	226 501	Diode 1 N 4002
D 601	223 906	Diode 1 N 4148
bis		
D 602	223 906	Diode 1 N 4148
IC 101	268 204	IC HA 12412
IC 201	282 167	IC LA 1245
IC 301	264 541	IC HA 12016
IC 501	283 679	IC GD 7815
IC 601	274 730	IC SAA 1057
Q 1	282 210	Transistor 3 SK 74 L
Q 2	282 171	Transistor KTC 1923 Y
bis		
Q 4	282 171	Transistor KTC 1923 Y
Q 5	282 169	Transistor KTK 161 Y
Q 101	282 172	Transistor LM 9018 F
Q 103	282 076	Transistor KTC 1815 Y
Q 201	282 170	Transistor 2 SK 192 GR
Q 202	282 076	Transistor KTC 1815 Y
bis		
Q 405	282 076	Transistor KTC 1815 Y
Q 406	282 075	Transistor 2 SK 117 Y
Q 407	282 076	Transistor KTC 1815 Y
bis		
Q 408	282 076	Transistor KTC 1815 Y
Q 501	282 076	Transistor KTC 1815 Y
bis		
Q 510	282 076	Transistor KTC 1815 Y
Q 511	282 057	Transistor KTD 880 Y
Frontplatte		
D 701	223 906	Diode 1 N 4148
bis		
D 713	223 906	Diode 1 N 4148
IC 701	281 970	IC UP HD 44840/B 08
IC 702	261 874	IC MC 14016 BCP MOS
BAT	282 207	Akku CR 2439-8
LCD	284 345	Display
R-N 701	282 214	Netzwerk 11 x 473 G
R-N 702	282 213	Netzwerk 11 x 124 G
R-S 701	282 206	Quarz CSB 800 D
Q 701	282 076	Transistor KTC 1815 Y
	283 573	Bedienungsanleitung
	283 706	Faltschachtel
	283 662	Einlage

Änderungen vorbehalten! Subject to change! Sous réserve de modification!