

# EV DYNACORD®

## USER MANUAL

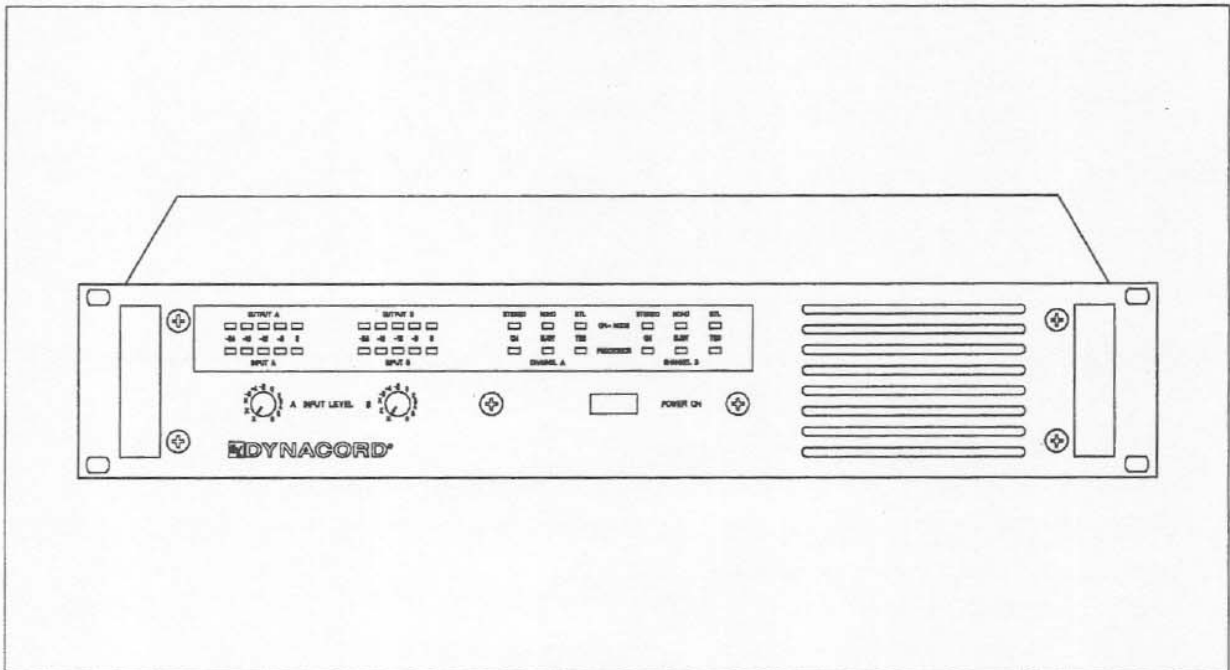

**PCA 2250 / PCA 2450**

**Processor-Controlled Power Amplifier**

## PCA 2250, PCA 2450 General Overview

Stereo Power Mosfet Power Amplifiers with built-in LPN Eq, Nonlinearity Controlled Limiter and Loudspeaker Thermal Voice Coil Overload Protection Network

- \* PCA 2250 2 \* 250 W / 4 Ohms rated power
- \* PCA 2450 2 \* 400 W / 4 Ohms rated power
- \* Excellent dynamic headroom ( 1.5 dB IHF-A)
- \* Excellent internal rise-time and slew-rate
- \* Electronically balanced XLR inputs
- \* Unbalanced phone-jack inputs
- \* Transformer isolated inputs optional
- \* SPEAKON loudspeaker connectors for Channel A and Channel B
- \* SPEAKON loudspeaker connectors for "Bridged Mode"
- \* 2nd order low frequency low-pass-notch-filter eq (LPN)
- \* Built-in fast acting nonlinearity controlled limiter
- \* 1st order built-in voice coil model for protection of loudspeaker cabinets against voice coil thermal overload
- \* Large input and output level display
- \* Status indicators
- \* Excellent reactive load drive capability up to +- 90 degrees load phase angle
- \* No foldback current limiting
- \* Can drive audio transformers safely without the typical annoying "saturation clicks" of foldback current limited bipolar power amplifiers
- \* 2 built-in dual-speed temperature controlled fans
- \* Crowbar DC loudspeaker protection

# CONTROLS AND CONNECTIONS

## FRONT PANEL

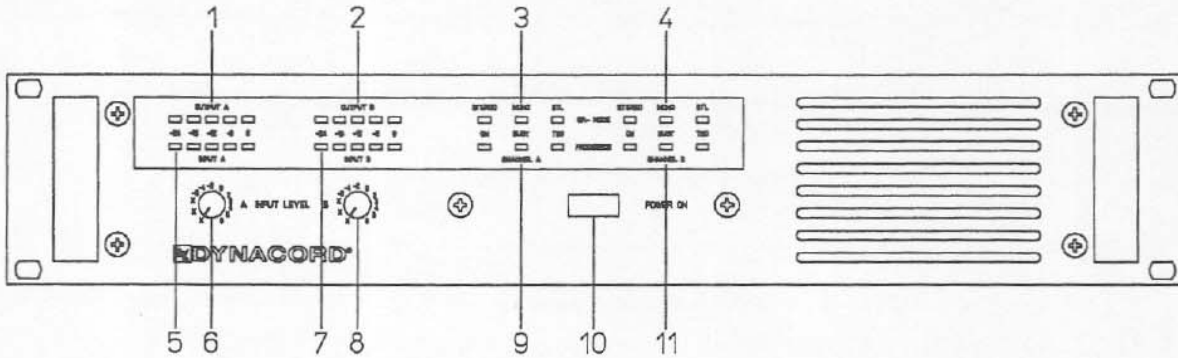

- |                                |                                  |
|--------------------------------|----------------------------------|
| 1. Output display, channel A   | 7. Input display, channel B      |
| 2. Output display, channel B   | 8. Volume control, channel B     |
| 3. Function display, channel A | 9. Processor display, channel A  |
| 4. Function display, channel B | 10. Mains switch                 |
| 5. Input display, channel A    | 11. Processor display, channel B |
| 6. Volume control, channel A   |                                  |

## REAR PANEL

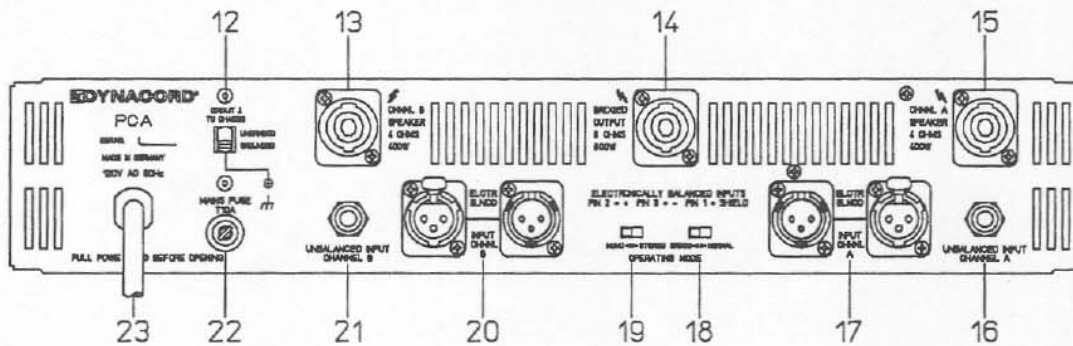

- |                                      |                                      |
|--------------------------------------|--------------------------------------|
| 12. Groundlift switch                | 18. Normal/bridged mode switch       |
| 13. Speaker output, channel B        | 19. Stereo/mono switch               |
| 14. Speaker output, "bridged mode"   | 20. XLR inputs, balanced, channel B  |
| 15. Speaker output, channel A        | 21. Input jack unbalanced, channel B |
| 16. Input jack unbalanced, channel A | 22. Fuse holder                      |
| 17. XLR inputs, balanced, channel A  | 23. Power cord                       |

# OPERATION

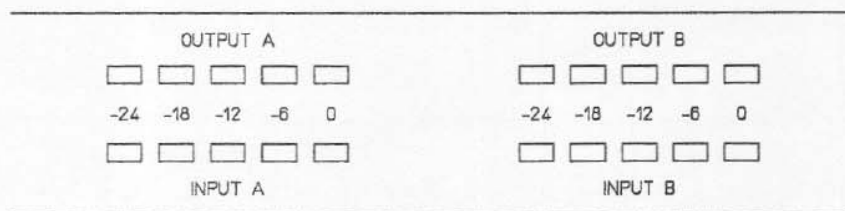

## INPUT A, INPUT B DISPLAY

These LED arrays indicate the input signal for the processor section and power amplifiers. In electrical terms, these displays are positioned behind of the level controls (post fader), i.e. no display will given when the level controls are turned down.

## OUTPUT A, OUTPUT B DISPLAY

These LED arrays indicate the sound signal applied to the output sockets. In the event of the speaker lines being shorted, these displays will only be illuminated slightly or not at all, whereas the input displays will continue to light up.



**EV DYNACORD®**

## INPUT LEVEL A, INPUT LEVEL B

Controls to adjust the power amplifier input level. These controls should normally be positioned between 0 and 6 in order to avoid distortion in output amplifiers of mixers. If these controls are turned to the X position, distortion from overdriving mixer output amplifiers must be expected at high levels. Distortions of this type can, of course, not be corrected by the power amplifier processor.

# OPERATION

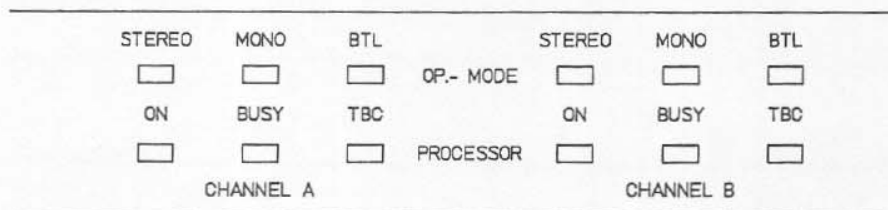

## STEREO

The STEREO LEDs will light up when the selector switch (rear panel) is set to the STEREO position. Channel A and channel B are processed separately.

## MONO

The red MONO LEDs will light up when the selector switch (rear panel) is set to the MONO position. In the MONO position, the input sockets for channel A and channel B are directly connected in parallel. The volume for channel A and channel B can, however, be adjusted separately by means of level controls A, B.

If transformers are retrofitted (transformer-balanced input), the input sockets for channel A and B are not directly connected in the MONO position.

## BTL

Display for bridged mode (selector switch on rear panel). In this position, the bridge output jack (rear panel) must be used only. The green or red LED shows that channel A is operating in phase, channel B in opposite phase.

In bridged mode, MONO will be automatically selected so that the input sockets A or B can be used. The input level will only be indicated on the channel A display.

## ON

LED to indicate that the unit is switched on or off.

## BUSY

This display will light up when the limiter section of the processor is activated. Permanent illumination of the BUSY LED shows amplifier overdriving and should be avoided by reducing the mixer output volume.

## TBC

The short-term peak output power of the PCA power amps is considerably higher than the rated output power in order to give you excellent dynamic behaviour. The "dynamic headroom" (IHF-A) is 1.5 dB which is approximately 40% higher than the rated output power. The TBC circuit contains a simple 1<sup>st</sup>-order voice coil model to simulate the thermal behaviour of a typical woofer. At continuous overdriving or modulation with square wave signals this part of the processor reduces the power output to the rated output, in order to protect the connected loudspeaker system against thermal overload of the woofer's voice coil.

Please note that speakers with less power capability than the rated power cannot be protected completely by the "Thermal Brain Circuit".

# OPERATION

## INPUTS, CHANNEL A, CHANNEL B.



UNBALANCED INPUT  
CHANNEL A

Input jacks, unbalanced

XLR input sockets, electronically balanced

PIN 2 = +

PIN 3 = -

PIN 1 = SHIELD

The XLR jacks are wired in accordance with IEC268-12  
(PIN 2 = +, PIN 3 = -, PIN 1 = SHIELD).

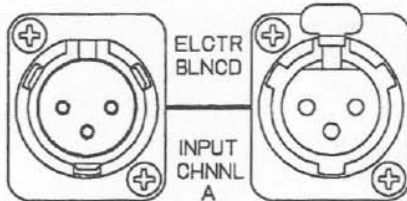

### CAUTION:

When using cables featuring the "obsolete" wiring (PIN 3 = +, PIN 2 = -, PIN 1 = SHIELD), the power amplifier will operate in the "wrong phase". In order to avoid problems of this kind, which are difficult to detect, you should always have your system wiring tested by an authorised dealer.

## MODE SELECTOR SWITCHES

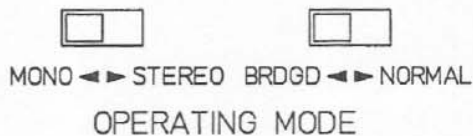

### MONO - STEREO

The STEREO/MONO selector connects the inputs in parallel.

### BRDGD-NORMAL

Used for selecting "bridged mode". In "bridged mode" Channel A, and Channel B a working "push-pull", i.e. in opposite phase and deliver twice the normal output voltage to the speaker terminals.



# OPERATION

## SPEAKER OUTPUTS

SPEAKON speaker output sockets for channel A, B.

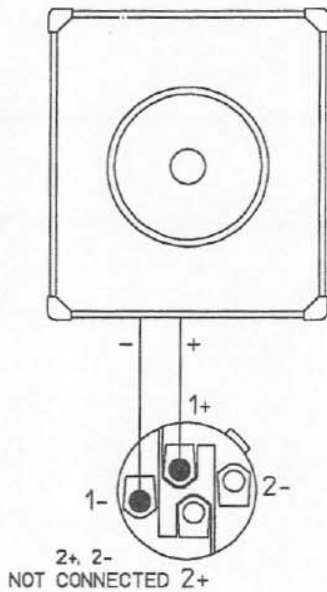

### Check the polarity of the connected speaker cabinets

To prevent acoustic cancellation problems, the polarity of the loudspeaker cabinets connected to the outputs must be equal. Otherwise the bass can sound muddy, suppressed and unprecise and weird midrange lobing problems can occur.

A very simple checking method involves a 9 V battery. If the + pole of the battery is connected to the + pole of the loudspeaker connector, the cone of the woofer should move outwards.

The correct polarity of mid-range and high-range speakers cannot be checked in this way, because some crossover networks change the polarity of speakers in the mid-range and high-range region.

E-V loudspeaker cabinets are internally wired correctly and do not need any polarity check procedure.

Minimum recommended load impedance is 3 ohms.

## OUTPUT FOR BRIDGED MODE

In the "bridged mode" (BTL MODE), channels A and B operate in phase opposition so that the bridge output socket is fed with double the output voltage at the normal output sockets. Since the rated output power in the BTL MODE is 500W (PCA 2250), 800W (PCA 2450) at 8 ohms, speakers should only be connected which are actually capable of processing this power as rated power (not music output or cont. progr.). If speakers with a lower power handling capacity are used in the bridged mode, the continual activation of protection switches in the speakers or even speaker failure must be expected.

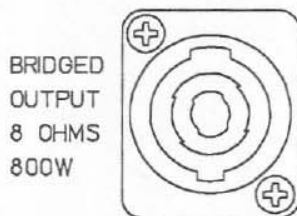

## GROUND LIFT SWITCH

Slide switch to eliminate "hum" resulting from ground loops. Separates the circuit ground from the chassis.

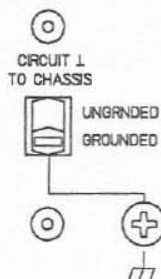

# SPECIFICATIONS

|  | <b>PCA 2250</b>     | <b>PCA 2450</b>     |
|--|---------------------|---------------------|
| Input level, XLR                                 | 510 mV - 10 V       | 650 mV - 10 V       |
| Input level, jack                                | 510 mV - 10 V       | 650 mV - 10 V       |
| Input impedance                                  | 10 kohms (20k bal.) | 10 kohms (20k bal.) |
| Music power 8 ohms                               | 2 x 180 W           | 2 x 300 W           |
| Music power 4 ohms                               | 2 x 300 W           | 2 x 480 W           |
| Rated power 8 ohms                               | 2 x 150 W           | 2 x 250 W           |
| Rated power 4 ohms                               | 2 x 250 W           | 2 x 400 W           |
| Rated Power 8 ohms (Bridged Mode)                | 1 x 500 W           | 1 x 800 W           |
| Minimum load impedance                           | 3 ohm               | 3 ohm               |
| Frequency response (- 3dB)                       | 3.5 Hz - 70 kHz     | 3.5 Hz - 70 kHz     |
| THD at rated output                              | < 0,03%             | < 0,03 %            |
| Crosstalk attenuation 1kHz                       | > 70 dB             | > 70 dB             |
| S/N ratio (A, RMS)                               | > 101 dB            | > 101 dB            |
| Slew rate (internal)                             | > 70 V/μsec         | > 100 V/μsec        |
| Rise time (internal)                             | < 2,5 usec          | < 2 usec            |
| Damping factor (internal)                        | > 300               | > 300               |
| Power consumption (1/8 P <sub>N</sub> IEC noise) | 350 VA              | 570 VA              |
| Operating voltage                                | 120 V AC 60 Hz      | 120 V AC 60 Hz      |
| Thermal Brain Circuit                            | TBC 250 W           | TBC 400 W           |
| Weight   | 16 kg (35.2 lbs)    | 16,5 kg (36.3 lbs)  |
| Dimensions (WxHxD)                               | 483 x 95 x 421 mm   | 483 x 95 x 421 mm   |
| Height units                                     | 2                   | 2                   |
| POWER ON delay                                   | yes                 | yes                 |
| Safety class                                     | I                   | I                   |
| Conversion kits                                  | 90151 # 111 978     | 90151 # 111 978     |
| XLR inputs transformer balanced                  |                     |                     |

Specifications are subject to change without notice.



# TECHNICAL INFORMATION

## Bass Equalization

The PCA power amplifiers are equipped with a 2nd order shelving eq (LPN) to linearize the frequency response and phase response of vented loudspeaker cabinets. The corner frequencies and the quality factors of the LPN have been designed to match with the characteristics of modern high-efficiency loudspeaker cabinets.

The corner frequencies of the LPN can internally be selected for two different classes of loudspeaker cabinets.

Position 1 (see below) is appropriate for high-efficiency cabinets with comparably small cabinet volumes, Position 2 should be used if studio monitors or extremely large bass horns are used.

Factory setting is Position 1.

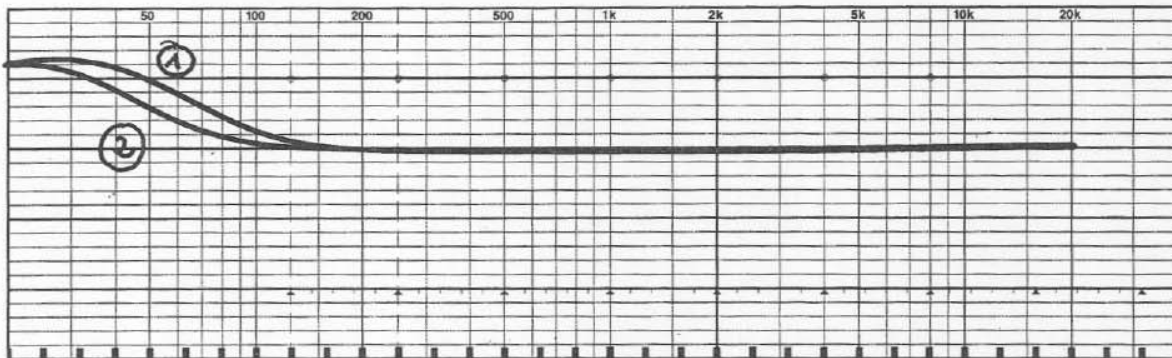

Open the appliance. Selection is performed by means of switches (S 010, channel A and S 011, channel B).

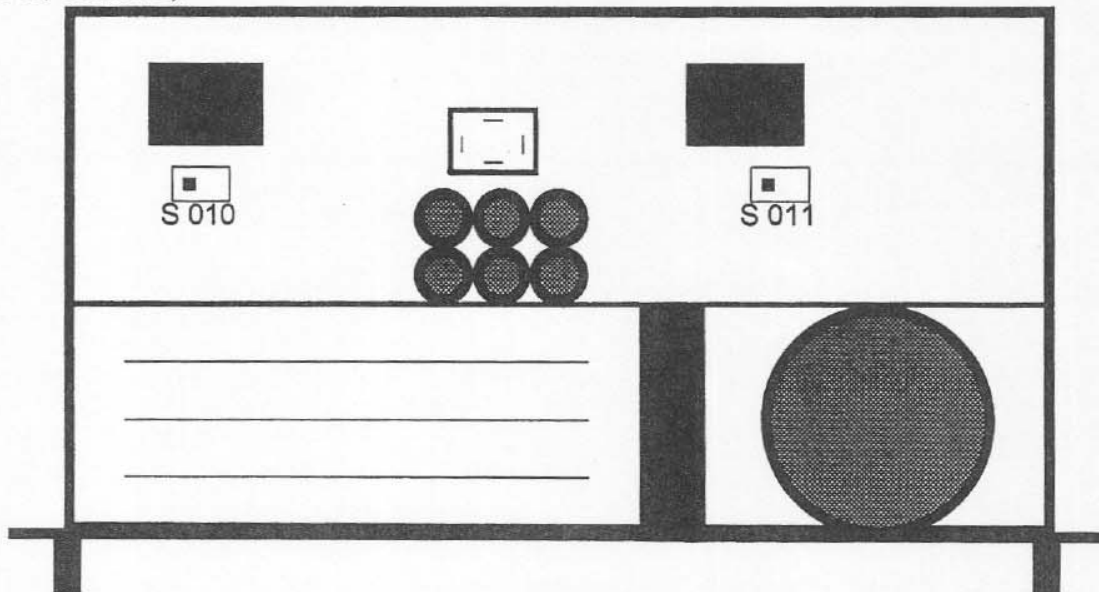

Compensator 1 (switches S 010, S 011) switched to the left as viewed from the front, corresponds to the factory setting Position 1.

# ADJUSTMENT INSTRUCTIONS

## - TONE CONTROLS FOR MIXERS AND PREAMPLIFIERS

Before switching on, turn tone controls to the neutral position, equalizer to bypass. On the basis of this setting, adjust tone control to suit personal requirements. In the case of PCA power amplifiers, drastic adjustments to the tone controls are normally not necessary. Extreme adjustments to bass, mid-range or treble controls are normally indicative of inferior-quality speakers, microphones or preamplifiers.

## - MICROPHONES

Directional microphones are associated with strong bass emphasis when spoken into at short distances. This can normally be eliminated by turning down the bass control or by activating the pop filter (if featured on the microphone). If possible, do not use third-octave or octave equalizers to eliminate pop interference since these in general uncontrollably lead to a deterioration of the phase and transient response of the entire system.

## - EQUALIZERS

Third-octave or octave equalizers should, if at all, be adjusted with extreme caution. On many third-octave or octave equalizers, slight changes in the bass and mid-range produce unacceptable sound coloration which cannot be eliminated by any of the other tone controls.

## - CALIBRATION USING REAL-TIME ANALYSERS AND EQUALIZERS

"Calibration" of amplifier systems with real-time analysers and third-octave or octave equalizers is generally not recommended for reasons of introduction of phase and group delay errors caused by equalizers (dependent on setting). Should calibration appear necessary, as a result of particularly unfavourable conditions, please observe the following precautionary measures when "calibrating" PA systems.

1. Only calibrate in the direct speaker field; this is normally a distance of approx. 3m to a maximum of 5m. If the test microphone is positioned at a greater distance (e.g. centre of the hall), direct sound as well as reverberated sound will be measured. Attempts to linearise this "mess" by means of a third-octave EQ will generally produce an extremely tinny, annoying sound quality.
2. When calibrating in the range from approx. 250 Hz - 5 kHz ("the critical range") using the EQ, only use "cut" positions, never "boost" frequency bands. A "hole" in the spectrum is not half as disturbing as a "boosted frequency band". Avoid boosting the bass range since the transient response of the entire system will be drastically worsened.
3. A maximum of 5 W (pink noise) should be used for calibration purposes in order to avoid power amplifier clipping and associated distortions. In commercially available noise generators, peak pink noise voltage is approximately 10 dB higher than the RMS level so that peaks up to 50 W occur at the output of the power amplifier.
4. Dominant acoustic feedback can sometimes be suppressed a little by means of third-octave EQs or parametric EQs. Applications of this type should, however, be treated with extreme caution so as not to destroy the increase in volume by a loss of intelligibility and a deterioration of the natural sound reproduction.

Overall TEST DATA for PCA 2250  
 =====

Basic settings:  
 -----

Set mode selector switch on rear panel to "STEREO" and "NORMAL"  
 Turn input level switch "fully clockwise"  
 Set bass equalisation switch to position 1 (on left-hand side as viewed from front = condition as delivered)

Perform measurements on channel A or B if nothing else is specified.

- |     |  |                                  |
|-----|--|----------------------------------|
|     | Operating voltage  | E = 120 V AC 50 Hz               |
|     | Test frequency   | F = 1 kHz                        |
| 1.0 | Input voltage  | E <sub>in</sub> = 510 mV (± 10%) |
|     | Load impedance   | R = 4 ohms                       |
| 1.1 | Rated power output 8 ohms = 150 watts = 34.6 V at 8 ohms<br>(E <sub>in</sub> = 555 mV ± 10%) |                                  |
| 1.2 | Rated power output 4 ohms = 250 watts = 31.6 V at 4 ohms<br>(E <sub>in</sub> = 510 mV ± 10%) |                                  |

Bridged mode:

- |     |   |  |
|-----|---|--|
| 1.3 | Rated power output 8 ohms = 500 watts = 63.2 V at 8 ohms<br>(input A and B in "bridged" position internally switched to mono !) E <sub>in</sub> = 510 mV ± 10 % |  |
|-----|---|--|

- |    |   |  |
|----|---|--|
| 2. | Total harmonic distortion ≤ 0.03 % (8 Ω, 34.6 V, 1 kHz)<br>≤ 0.04 % (8 Ω, 3.5 V, 1 kHz) |  |
|----|---|--|

- |     |                       |       |         |
|-----|-----------------------|-------|---------|
| 3.1 | Crosstalk attenuation | A > B | > 70 dB |
|     | (1 kHz, 31.6 V)       | B > A | > 70 dB |

|  |                        |           |           |
|--|------------------------|-----------|-----------|
|  | Interference voltages: | Channel A | Channel B |
|  | -----                  |           |           |

- |     |   |          |          |
|-----|---|----------|----------|
| 4.1 | External voltage<br>(level controls turned up)              | < 1.2 mV | < 1.2 mV |
| 4.2 | Noise voltage CCIR 468<br>(level controls turned up) "peak" | < 3.5 mV | < 3.5 mV |
| 4.3 | Noise voltage "A" RMS<br>(level controls turned up)         | < 700 μV | < 700 μV |
| 4.4 | Noise voltage "A" RMS<br>(level controls turned down)       | < 700 μV | < 700 μV |

5. Frequency responses

FREQUENCY RESPONSE FOR COMPLETE UNIT 20 Hz-20 kHz input voltage

E = 51 mV(-20 dB)

1 = bass equalisation position 1 (PA systems)

2 = bass equalisation position 2 (studio monitors)

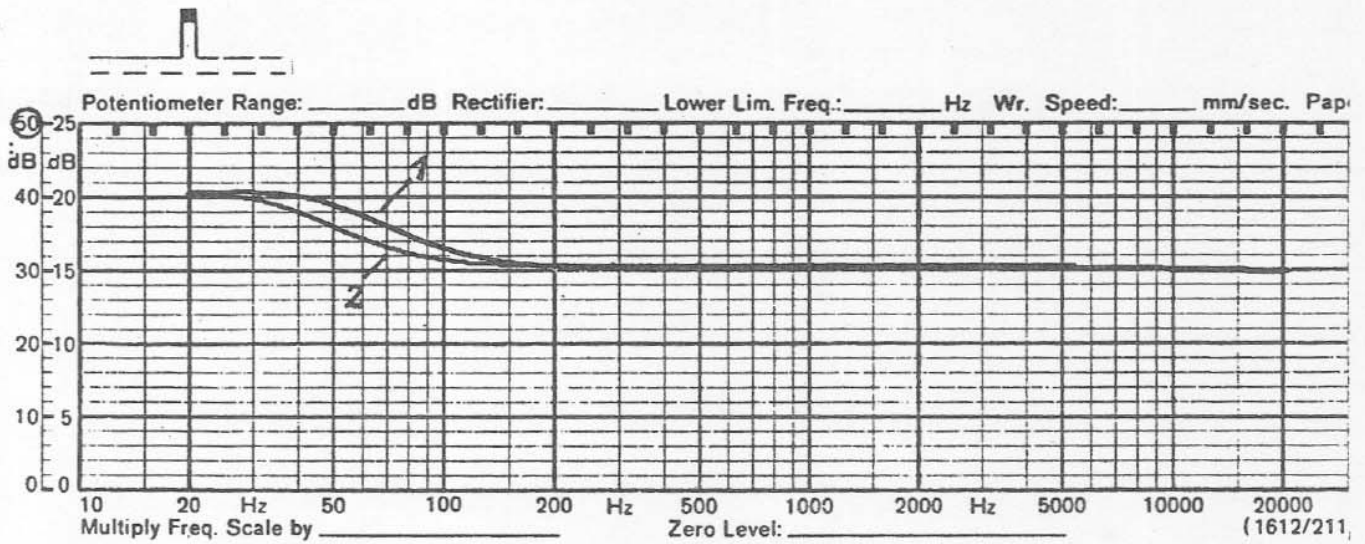

FREQUENCY RESPONSE FOR COMPLETE UNIT input voltage E = 51 mV(-20dB)

1 = 2 Hz - 2 kHz

2 = 200 Hz - 200 kHz

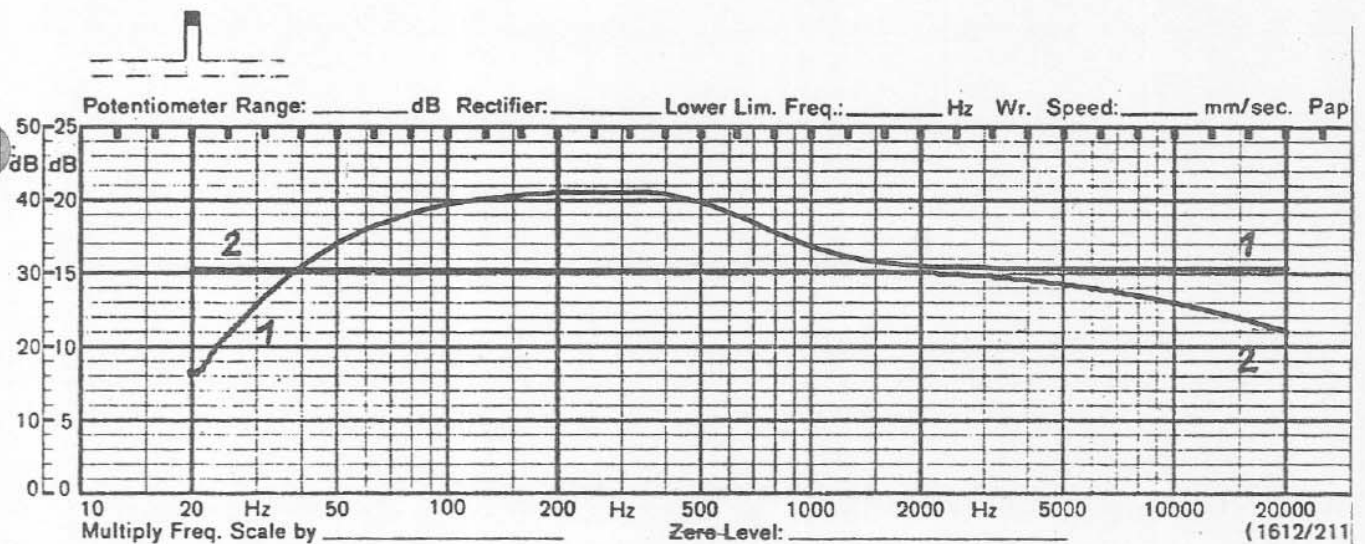

Test points: 500 Hz  $\pm$  0 dB, 50 Hz +8.5 dB ( $\pm$  0.6 dB) -----  
50 kHz - 2.5 dB ( $\pm$  1.5 dB)

- |     |  |  |
|-----|--|--|
| 6.1 | Power input at no load                                 | : 40 VA ( $\pm 15\%$ )                         |
| 6.2 | Power input at rated power<br>(2x 250 watts at 4 ohms) | : 1200 VA ( $\pm 15\%$ )                       |
| 7.1 | Input impedance  | : 10k ohms unbalanced<br>20k ohms electr. bal. |
| 8.  | Max. input voltage                                     | : > 10 volts                                   |
| 9.  | Damping factor internal<br>(related to 8 ohms)         | : > 300  |
| 10. | Slew rate (internal)                                   | : > 70 V/ $\mu$ sec                            |
| 11. | Rise time (internal)                                   | : < 2.5 $\mu$ sec                              |

#### A D J U S T M E N T S :

-----

INTERNAL OFFSET : Channel A - adjust to 0 volt  $\pm$  50 mV  
(Level controls using R 055 at Tp Ch.A.  
turned down)

Channel B - adjust to 0 volt  $\pm$  50 mV  
using R 122 at Tp Ch.B.

PROCESSOR CONTROL VOLTAGE: Check voltage drop at R 066 (channel A)  
and R 133 (channel B).  
E = at least 1.2 V - 1.5 V

PROCESSOR ADJUSTMENT : Adjust both channels until Eout = 16 V,  
close service switch channel A = S 003,  
B = S 004. Using R 024 = channel A  
and R 029 = channel B, adjust output  
voltage to minimum.  
f=1 kHz, attenuation > 40 dB, E <160 mV

PROCESSOR OFFSET : Alternately open and close service  
(Level controls switches S 003 and S 004, using R 028  
turned down) or R 033 adjust to minimum offset at  
power amplifier output.

CLOSED-CIRCUIT CURRENT ADJUSTMENT: Measure indirectly via power input on  
amplifier board 84121. Remove fuse in  
the + line and replace by 0.1 ohm  
resistor. Adjust voltage drop to 5 mV  
(= 50 mA closed-circuit current).

INDICATOR ADJUSTMENT : With an output voltage of E = 16 V,  
adjust output indicator in such a way  
that penultimate LED in each array just  
starts to go out. (Channel A = R 098,  
channel B = R 100 on board 84122)  
With an output voltage of E = 16 V,  
adjust output indicator in such a way  
that penultimate LED in each array just  
starts to go out. (Channel A = R 015,  
channel B = R 018 on board 84122)



BAL. INPUT : Apply signal to pins 2 and 3 of XLR input jack, pin 1 = chassis, E = 480 mV - using R 016 (channel A) and R 019 (channel B) adjust output signal to minimum.

PROCESSOR TEST : Adjust both channels until Eout = 31.6 V; increase input voltage by 10 dB -- BUSY LED will light up, output voltage will rise by approx. 2 dB to 40 volts.

SHORT-CIRCUIT TEST : Adjust both channels individually until 31.6 volts at 4  $\Omega$ . Connect 1  $\Omega$  resistor in parallel. Power input will increase to approx. 950 VA and then continually fall back to approx. 500 VA (approx. 30 sec.) BUSY LED will light up!

FAN CONTROL : Both fans generally run "slow" ! Switching from "slow" > "fast" at 90 °C Switching from "fast" > "slow" at 70 °C

ON DELAY : E002 (power limitation), E003 and E004 (LF output) attract simultaneously.

TBC TEST : Switch unit off. After approx. 10 sec. (TBC circuitry discharged) turn unit back on again at Ein +10 dB. BUSY LED will light up, Eout = 40 V. TBC protective circuitry will respond after approx 30 sec. and reduce the output voltage to approx. 31.6V. (TBC LED will light up.)

### S P E C I F I C A T I O N S

---

|                                       |                                      |
|---------------------------------------|--------------------------------------|
| Input voltage, XLR                    | : 510 mV - 10 V                      |
| Input voltage, jack                   | : 510 mV - 10 V                      |
| Input impedance                       | : 10 k $\Omega$ (20 k $\Omega$ bal.) |
| Music power 8 $\Omega$                | : 2 x 180 watts                      |
| Music power 4 $\Omega$                | : 2 x 380 watts                      |
| Rated power 8 $\Omega$                | : 2 x 150 watts                      |
| Rated power 4 $\Omega$                | : 2 x 250 watts                      |
| Rated power 8 $\Omega$ (bridged mode) | : 500 watts                          |
| Min. load impedance                   | : 3 ohms                             |
| Frequency response (-3 dB)            | : 3.5 Hz - 70 kHz                    |
| Total harmonic distortion             | : < 0.03 %                           |
| Crosstalk attenuation at 1kHz         | : > 70 dB                            |
| S/N ratio (A, RMS)                    | : > 101 dB                           |
| Slew rate (internal)                  | : > 70 V/ $\mu$ sec                  |
| Rise time (internal)                  | : < 2.5 $\mu$ sec                    |
| Damping factor (internal)             | : > 300                              |
| Power input                           | : 1200 VA                            |
| Operating voltage                     | : 120 V $\pm$ 10% AC 50-60 Hz        |
| Weight                                | : approx. 16 kg.                     |
| Dimensions (WxHxD)                    | : 483x95x421mm, 2units high          |
| ON delay                              | : yes                                |
| Enclosure class                       | : I                                  |
| Retrofit kit (input balanced)         | : 90151 # 111798                     |



Overall TEST DATA for PCA 2450  
 =====

Basic settings:  
 -----

Set mode selector switch on rear panel to "STEREO" and "NORMAL"  
 Turn input level switch "fully clockwise"  
 Set bass equalisation switch to position 1 (on left-hand side as viewed from front = condition as delivered)

Perform measurements on channel A or B if nothing else is specified.

- |     |   |                                   |           |
|-----|---|-----------------------------------|-----------|
|     | Operating voltage   | E = 120 V AC 50 Hz                |           |
|     | Test frequency  | F = 1 kHz                         |           |
| 1.0 | Input voltage   | E <sub>in</sub> = 650 mV (± 10%)  |           |
|     | Load impedance  | R = 4 ohms                        |           |
| 1.1 | Rated power output 8 ohms   | = 250 watts = 45 V at 8 ohms      |           |
|     |   | (E <sub>in</sub> = 750 mV ± 10%)  |           |
| 1.2 | Rated power output 4 ohms   | = 400 watts = 40 V at 4 ohms      |           |
|     |   | (E <sub>in</sub> = 650 mV ± 10 %) |           |
|     | Bridged mode:   |                                   |           |
| 1.3 | Rated power output 8 ohms   | = 800 watts = 80 V at 8 ohms      |           |
|     | (input A and B in "bridged" position internally switched to mono !) |                                   |           |
|     |   | E <sub>in</sub> = 650 mV ± 10 %   |           |
| 2.  | Total harmonic distortion   | ≤ 0.03 % (8 Ω, 45 V, 1 kHz)       |           |
|     |   | ≤ 0.04 % (8 Ω, 4.5 V, 1 kHz)      |           |
| 3.1 | Crosstalk attenuation   | A > B > 70 dB                     |           |
|     | (1 kHz, 40 V)   | B > A > 70 dB                     |           |
|     | Interference voltages:  |                                   |           |
|     |   | Channel A                         | Channel B |
| 4.1 | External voltage<br>(level controls turned up)                      | < 1.2 mV                          | < 1.2 mV  |
| 4.2 | Noise voltage CCIR 468<br>(level controls turned up) "peak"         | < 3.5 mV                          | < 3.5 mV  |
| 4.3 | Noise voltage "A" RMS<br>(level controls turned up)                 | < 700 μV                          | < 700 μV  |
| 4.4 | Noise voltage "A" RMS<br>(level controls turned down)               | < 700 μV                          | < 700 μV  |

5. Frequency responses

FREQUENCY RESPONSE FOR COMPLETE UNIT 20 Hz-20 kHz input voltage

E = 65 mV(-20 dB)

1 = bass equalisation position 1 (PA systems)

2 = bass equalisation position 2 (studio monitors)

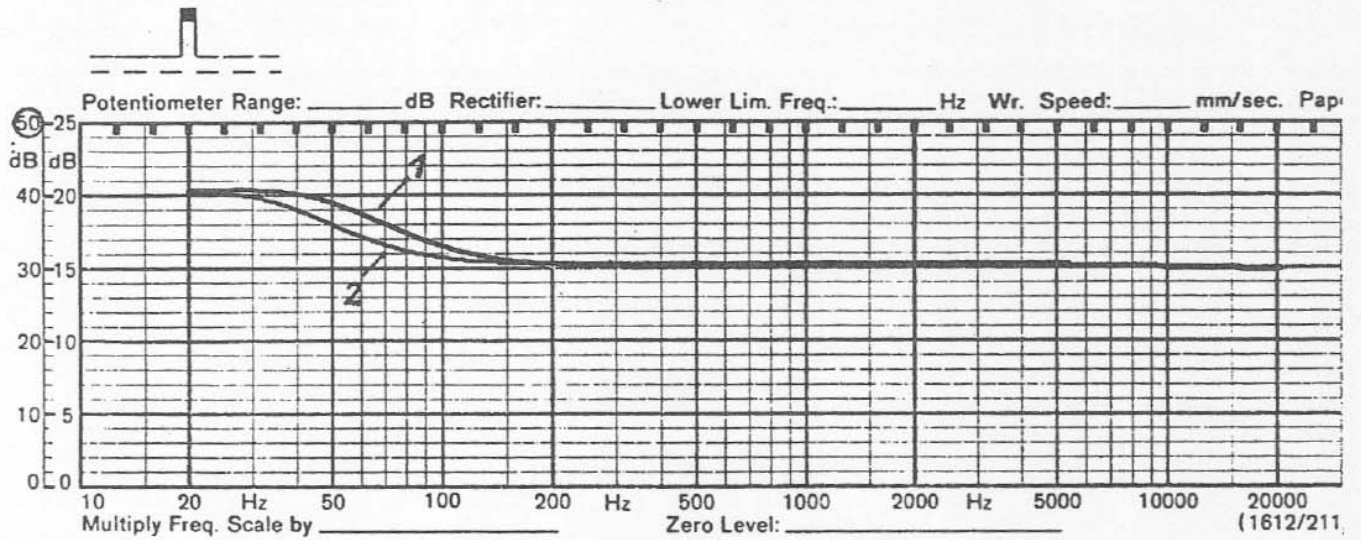

FREQUENCY RESPONSE FOR COMPLETE UNIT input voltage E = 65 mV(-20dB)

1 = 2 Hz - 2 kHz

2 = 200 Hz - 200 kHz

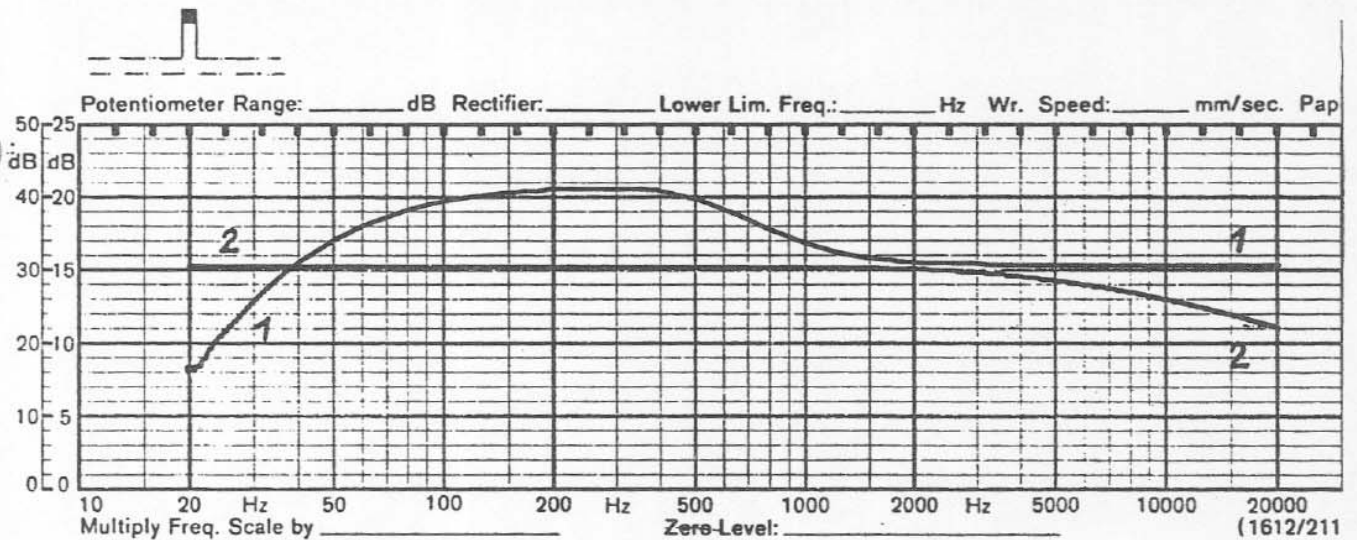

Test points: 500 Hz  $\pm$  0 dB, 50 Hz +8.5 dB ( $\pm$  0.6 dB) -----  
50 kHz - 2.5 dB ( $\pm$  1.5 dB)

- |     |  |  |
|-----|--|--|
| 6.1 | Power input at no load                                 | : 70 VA ( $\pm 15\%$ )                         |
| 6.2 | Power input at rated power<br>(2x 400 watts at 4 ohms) | : 1600 VA ( $\pm 15\%$ )                       |
| 7.1 | Input impedance  | : 10k ohms unbalanced<br>20k ohms electr. bal. |
| 8.  | Max. input voltage                                     | : > 10 volts                                   |
| 9.  | Damping factor internal<br>(related to 8 ohms)         | : > 300  |
| 10. | Slew rate (internal)                                   | : > 100 V/ $\mu$ sec                           |
| 11. | Rise time (internal)                                   | : < 2 $\mu$ sec                                |

A D J U S T M E N T S :

INTERNAL OFFSET : Channel A - adjust to 0 volt  $\pm$  50 mV  
(Level controls using R 055 at Tp Ch.A.  
turned down)

Channel B - adjust to 0 volt  $\pm$  50 mV  
using R 122 at Tp Ch.B.

PROCESSOR CONTROL VOLTAGE: Check voltage drop at R 066 (channel A)  
and R 133 (channel B).  
E = at least 1.2 V - 1.5 V

PROCESSOR ADJUSTMENT : Adjust both channels until  $E_{out} = 20$  V,  
close service switch channel A = S 003,  
B = S 004. Using R 024 = channel A  
and R 029 = channel B, adjust output  
voltage to minimum.  
 $f = 1$  kHz, attenuation > 40 dB,  $E < 200$  mV

PROCESSOR OFFSET : Alternately open and close service  
(Level controls switches S 003 and S 004, using R 028  
turned down) or R 033 adjust to minimum offset at  
power amplifier output.

CLOSED-CIRCUIT CURRENT Measure indirectly via power input on  
ADJUSTMENT: amplifier board 84121. Remove fuse in  
the + line and replace by 0.1 ohm  
resistor. Adjust voltage drop to 10 mV  
(= 100 mA closed-circuit current).

INDICATOR ADJUSTMENT : With an output voltage of  $E = 20$  V,  
adjust output indicator in such a way  
that penultimate LED in each array just  
starts to go out. (Channel A = R 098,  
channel B = R 100 on board 84122)  
With an output voltage of  $E = 20$  V,  
adjust output indicator in such a way  
that penultimate LED in each array just  
starts to go out. (Channel A = R 015,  
channel B = R 018 on board 84122)

BAL. INPUT : Apply signal to pins 2 and 3 of XLR input jack, pin 1 = chassis, E = 650 mV - using R 016 (channel A) and R 019 (channel B) adjust output signal to minimum.

PROCESSOR TEST : Adjust both channels until Eout = 40V, increase input voltage by 10 dB -- BUSY LED will light up, output voltage will rise by approx. 2 dB to 50 volts.

SHORT-CIRCUIT TEST : Adjust both channels individually until 40 volts at 4  $\Omega$ . Connect 1  $\Omega$  resistor in parallel. Power input will increase to approx. 2000 VA and then continually fall back to approx. 900 VA (approx. 30 sec.) BUSY LED will light up!

FAN CONTROL : Both fans generally run "slow" ! Switching from "slow" > "fast" at 90 °C Switching from "fast" > "slow" at 70 °C

ON DELAY : E002 (power limitation), E003 and E004 (LF output) attract simultaneously.

TBC TEST : Switch unit off. After approx. 10 sec. (TBC circuitry discharged) turn unit back on again at Ein +10 dB. BUSY LED will light up, Eout = 50 V. TBC protective circuitry will respond after approx 30 sec. and reduce the output voltage to approx. 40 V. (TBC LED will light up.)

### S P E C I F I C A T I O N S

-----

|                                       |                                      |
|---------------------------------------|--------------------------------------|
| Input voltage, XLR                    | : 650 mV - 10 V                      |
| Input voltage, jack                   | : 650 mV - 10 V                      |
| Input impedance                       | : 10 k $\Omega$ (20 k $\Omega$ bal.) |
| Music power 8 $\Omega$                | : 2 x 300 watts                      |
| Music power 4 $\Omega$                | : 2 x 480 watts                      |
| Rated power 8 $\Omega$                | : 2 x 250 watts.                     |
| Rated power 4 $\Omega$                | : 2 x 400 watts                      |
| Rated power 8 $\Omega$ (bridged mode) | : 800 watts                          |
| Min. load impedance                   | : 3 ohms                             |
| Frequency response (-3 dB)            | : 3.5 Hz - 70 kHz                    |
| Total harmonic distortion             | : < 0.03 %                           |
| Crosstalk attenuation at 1kHz         | : > 70 dB                            |
| S/N ratio (A, RMS)                    | : > 101 dB                           |
| Slew rate (internal)                  | : > 100 V/ $\mu$ sec                 |
| Rise time (internal)                  | : < 2 $\mu$ sec                      |
| Damping factor (internal)             | : > 300                              |
| Power input                           | : 1600 VA                            |
| Operating voltage                     | : 120 V $\pm$ 10% AC 50-60 Hz        |
| Weight                                | : approx. 16,5 kg                    |
| Dimensions (WxHxD)                    | : 483x95x421mm, 2units high          |
| ON delay                              | : yes                                |
| Enclosure class                       | : I                                  |
| Retrofit kit (input balanced)         | : 90151 # 111798                     |

**BLOCKDIAGRAM PCA2250/PCA2450**

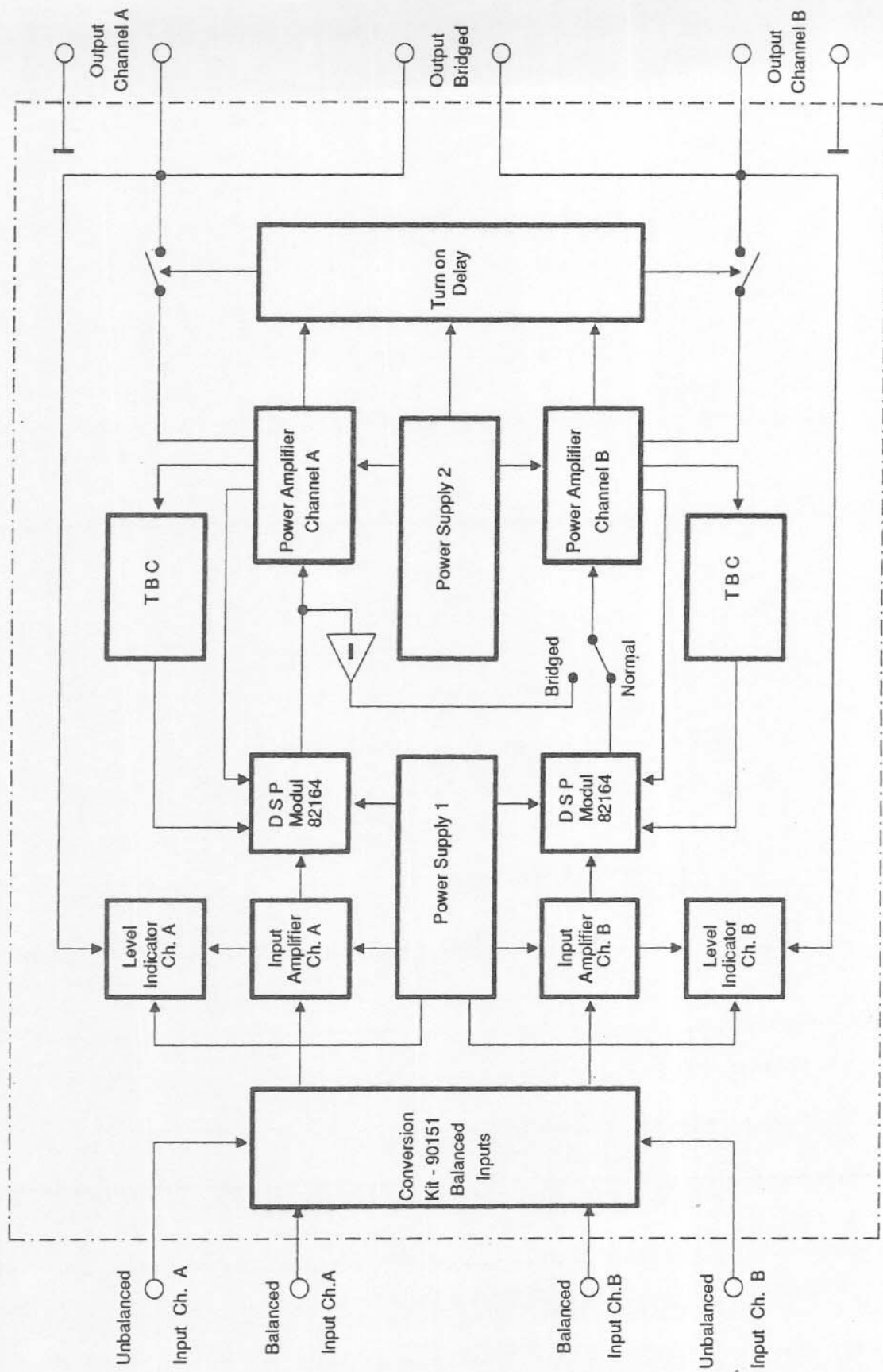

# DIMENSIONS (mm)

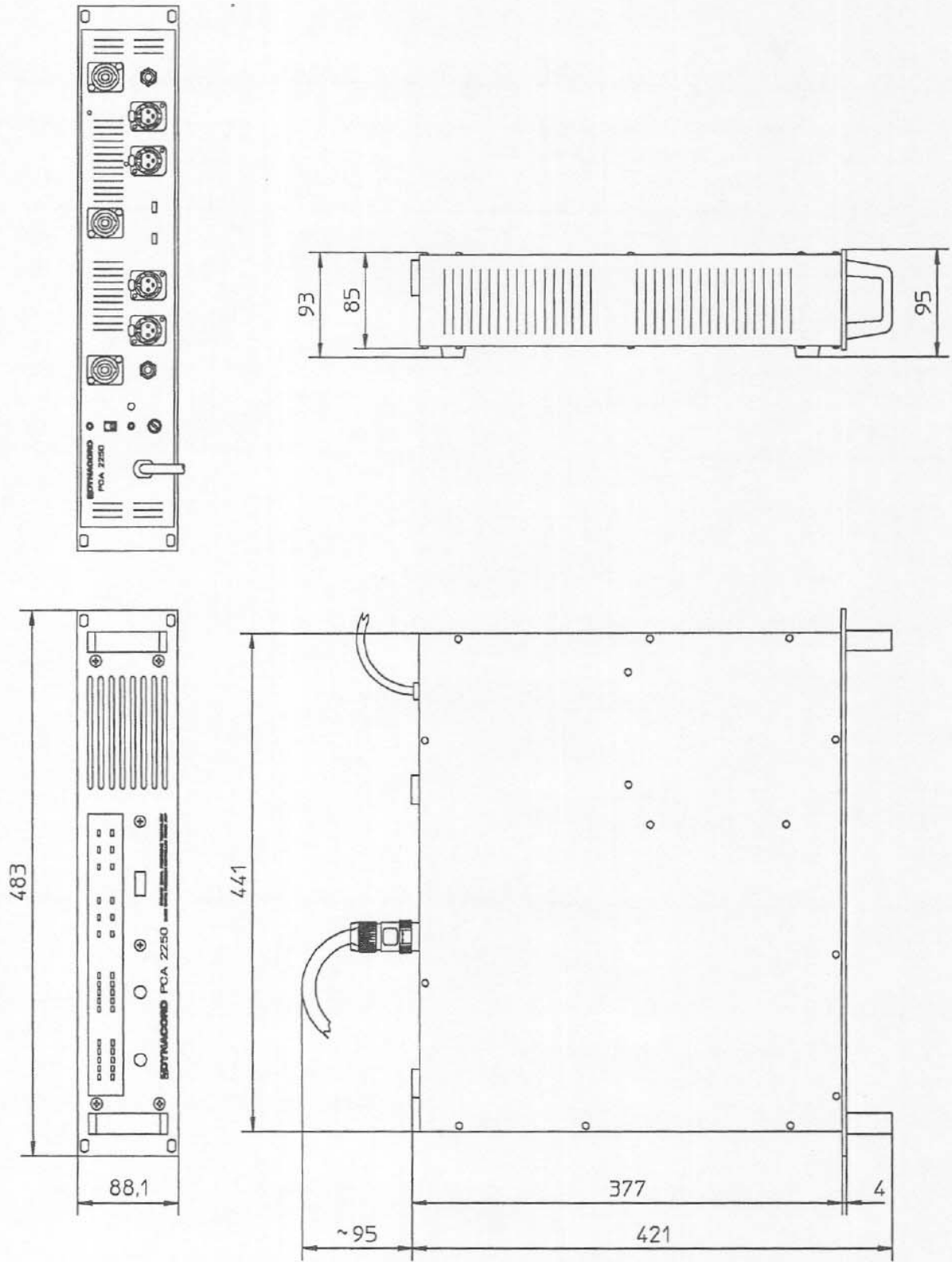



## SPEAKON PLUG CONNECTORS

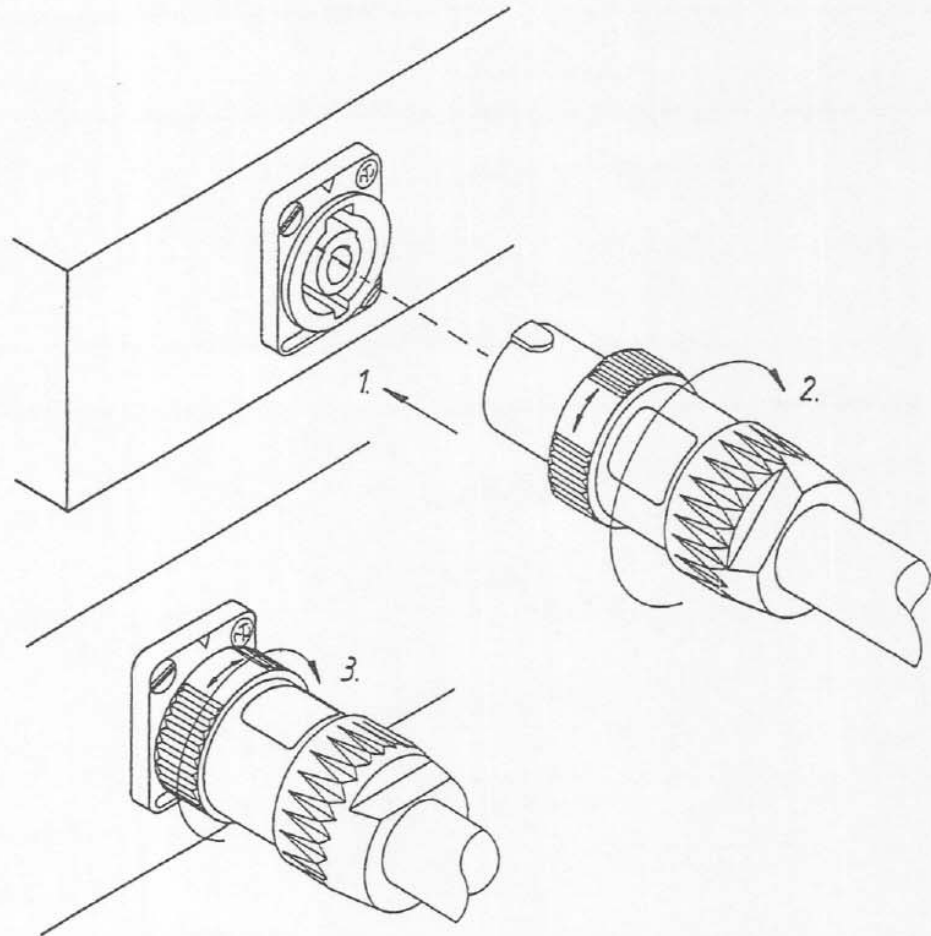

1. Insert plug into socket.
2. Turn main body by 30° , electrical contact will be made after turning only.
3. Turn security ring by 180° , to secure the connection.

| Pos. in diagram | description                 | Part-No. | Pos. in diagram | description                 | Part-No. |
|-----------------|-----------------------------|----------|-----------------|-----------------------------|----------|
| B 001           | speaker socket 4pol.        | 341343   | B003            | phone jack                  | 340985   |
| B 002           | speaker socket 4pol.        | 341343   | B004            | XLR socket female chassis   | 331267   |
| B 003           | speaker socket 4pol.        | 341343   | B005            | XLR socket male chassis     | 330607   |
| S 001           | sliding switch              | 335941   | B006            | phone jack                  | 340985   |
| 00020           | plexiglas panel             | 341264   | C011            | KO-EL 47MF 50V              | 343530   |
| 00030           | knob D 10 black             | 341580   | C012            | KO-EL 47MF 50V              | 343530   |
| 00060           | handle 55mm 2HE             | 341265   | C026            | KO-EL 47MF 50V              | 343530   |
| 00160           | power button black          | 341382   | C027            | KO-EL 47MF 50V              | 343530   |
| 00170           | switch                      | 334628   | C039            | KO-EL 10MF 35V              | 307445   |
| 00180           | wire unit L=497             | 340430   | C040            | KO-EL 10MF 35V              | 307445   |
| 00260           | fan TYP 8314 24V/DC         | 341614   | C041            | KO-EL 1000MF 25V            | 337597   |
| 00870           | rubber foot                 | 335589   | C042            | KO-EL 1000MF 25V            | 337597   |
| 55000           | PCB power amp               | 337050   | C043            | KO-EL 4700.000MF 100V       | 340437   |
| Q 001           | trans. 2SK 176              | 337637   | C044            | KO-EL 4700.000MF 100V       | 340437   |
| Q 002           | trans. 2SK 176              | 337637   | C045            | KO-EL 4700.000MF 100V       | 340437   |
| Q 003           | trans. 2SK 176              | 337637   | C046            | KO-EL 4700.000MF 100V       | 340437   |
| Q 004           | trans. 2SK 176              | 337637   | C047            | KO-EL 4700.000MF 100V       | 340437   |
| Q 005           | trans. 2SJ 56               | 337636   | C048            | KO-EL 4700.000MF 100V       | 340437   |
| Q 006           | trans. 2SJ 56               | 337636   | C049            | safety component            | 341714   |
| Q 007           | trans. 2SJ 56               | 337636   | C050            | safety component            | 341714   |
| Q 008           | trans. 2SJ 56               | 337636   | C052            | KO-EL 1000MF 25V            | 337597   |
| Q 009           | trans. 2SK 176              | 337637   | C053            | KO-EL 1000MF 25V            | 337597   |
| Q 010           | trans. 2SK 176              | 337637   | D001            | diode zener BZX 55C 15V     | 309450   |
| Q 011           | trans. 2SK 176              | 337637   | D002            | diode zener BZX 55C 15V     | 309450   |
| Q 012           | trans. 2SK 176              | 337637   | D003            | diode 1N 4002               | 304360   |
| Q 013           | trans. 2SJ 56               | 337636   | D004            | diode 1N 4002               | 304360   |
| Q 014           | trans. 2SJ 56               | 337636   | D005            | diode 1N 4002               | 304360   |
| Q 015           | trans. 2SJ 56               | 337636   | D006            | diode 1N 4002               | 304360   |
| Q 016           | trans. 2SJ 56               | 337636   | D007            | diode 1N 4002               | 304360   |
| R 186           | safety component            | 329981   | D008            | diode zener 1N 5352B 15V    | 331422   |
| S 005           | thermal cut out switch      | 339137   | D009            | diode zener 1N 5352B 15V    | 331422   |
| 10000           | PCB                         | 841218   | D010            | diode zener ZPD 12V 0,5W    | 305738   |
| R005            | wire-wound resistor 0,39ohm | 341711   | D011            | diode 1N 4148               | 301254   |
| R006            | wire-wound resistor 0,39ohm | 341711   | D012            | diode 1N 4148               | 301254   |
| R007            | wire-wound resistor 0,39ohm | 341711   | D013            | diode zener ZPD 12V 0,5W    | 305738   |
| R008            | wire-wound resistor 0,39ohm | 341711   | D014            | diode zener BZX 55C 2V4     | 329511   |
| R009            | wire-wound resistor 0,39ohm | 341711   | D015            | diode zener ZPD 12V 0,5W    | 305738   |
| R010            | wire-wound resistor 0,39ohm | 341711   | D016            | diode MBS 4991              | 338875   |
| R011            | wire-wound resistor 0,39ohm | 341711   | D017            | diode MBS 4991              | 338875   |
| R012            | wire-wound resistor 0,39ohm | 341711   | D018            | diode zener TYP 1,5 KE120CA | 339061   |
| R021            | wire-wound resistor 0,39ohm | 341711   | D019            | diode zener TYP 1,5 KE120CA | 339061   |
| R022            | wire-wound resistor 0,39ohm | 341711   | D020            | diode 1N 4002               | 304360   |
| R023            | wire-wound resistor 0,39ohm | 341711   | D021            | diode 1N 4002               | 304360   |
| R024            | wire-wound resistor 0,39ohm | 341711   | D022            | diode 1N 4002               | 304360   |
| R025            | wire-wound resistor 0,39ohm | 341711   | D023            | diode 1N 4002               | 304360   |
| R026            | wire-wound resistor 0,39ohm | 341711   | D024            | diode zener 1N 5352B 15V    | 331422   |
| R027            | wire-wound resistor 0,39ohm | 341711   | D025            | diode zener 1N 5352B 15V    | 331422   |
| R028            | wire-wound resistor 0,39ohm | 341711   | D026            | diode zener ZPD 12V 0,5W    | 305738   |
| 0005            | fuse holder                 | 306838   | D027            | diode 1N 4148               | 301254   |
| B001            | XLR socket female chassis   | 331267   | D028            | diode 1N 4148               | 301254   |
| B002            | XLR socket male chassis     | 330607   | D029            | diode zener ZPD 12V 0,5W    | 305738   |
|                 |                             |          | D030            | diode zener BZX 55C 2V4     | 329511   |
|                 |                             |          | D031            | diode zener ZPD 12V 0,5W    | 305738   |

| Pos. in diagram | description              | Part-No. | Pos. in diagram | description                 | Part-No. |
|-----------------|--------------------------|----------|-----------------|-----------------------------|----------|
| D032            | diode 1N 4002            | 304360   | Q029            | trans. BF 391               | 307911   |
| D033            | diode BAT 85             | 301297   | Q030            | trans. BF 491               | 307912   |
| D036            | diode zener ZPD 20V 0,5W | 301310   | Q031            | trans. BF 391               | 307911   |
| D037            | diode zener ZPD 51V 0,5W | 341613   | Q032            | trans. MJE 350              | 338869   |
| D038            | diode 1N 4006            | 305739   | Q033            | trans. MJE 340              | 338868   |
| D039            | diode BAT 85             | 301297   | Q034            | trans. MJE 340              | 338868   |
| D040            | diode zener ZPD 20V 0,5W | 301310   | Q035            | trans. MJE 350              | 338869   |
| D041            | diode zener ZPD 51V 0,5W | 341613   | Q036            | trans. MJE 350              | 338869   |
| D042            | diode 1N 4006            | 305739   | Q037            | trans. BC 560 B             | 306928   |
| E001            | relay ES HA 001 24       | 339849   | Q038            | trans. BC 337-25            | 307150   |
| E002            | relay RP 310 024         | 330404   | Q039            | trans. BC 337-25            | 307150   |
| E003            | relay RP 310 024         | 330404   | Q040            | trans. BF 391               | 307911   |
| E004            | relay RP 310 024         | 330404   | Q041            | trans. BC 550 B             | 301184   |
| F001            | fuse T 16A 250V US       | 343377   | Q042            | trans. BC 550 B             | 301184   |
| G001            | rectifier B 80 C1500 M   | 340791   | Q043            | trans. BC 327-25            | 307430   |
| G002            | rectifier KBPC 35-04     | 343270   | Q044            | trans. BC 327-25            | 307430   |
| I001            | IC NE 5532 N             | 327197   | Q045            | trans. BC 327-25            | 307430   |
| I002            | IC NE 5532 N             | 327197   | Q046            | trans. BC 327-25            | 307430   |
| I003            | IC NE 5532 N             | 327197   | Q047            | trans. BC 327-25            | 307430   |
| I004            | IC LM 308 A              | 338359   | R015            | Res. trimpot 47 kohm lin    | 307602   |
| I005            | IC LM 308 A              | 338359   | R016            | Res. trimpot 2.2 kohm lin   | 335930   |
| I006            | IC LM 340 T-15           | 308292   | R018            | Res. trimpot 47 kohm lin    | 307602   |
| I007            | IC LM 7915 CT            | 308293   | R019            | Res. trimpot 2.2 kohm lin   | 335930   |
| L001            | coil DCN 340092          | 340092   | R024            | Res. trimpot 47 kohm lin    | 307602   |
| L002            | coil DCN 340092          | 340092   | R028            | Res. trimpot 47 kohm lin    | 307602   |
| Q001            | trans. BC 337-25         | 307150   | R029            | Res. trimpot 47 kohm lin    | 307602   |
| Q002            | trans. BC 337-25         | 307150   | R033            | Res. trimpot 47 kohm lin    | 307602   |
| Q003            | trans. BC 617            | 334633   | R050            | wire-wound resistor 3,3kohm | 341712   |
| Q004            | trans. BC 617            | 334633   | R051            | wire-wound resistor 3,3kohm | 341712   |
| Q005            | trans. BF 391            | 307911   | R055            | Res. trimpot 100kohm lin    | 308691   |
| Q006            | trans. BF 491            | 307912   | R069            | Res. trimpot 470 ohm lin    | 331427   |
| Q007            | trans. BF 391            | 307911   | R074            | wire-wound resistor 4,7ohm  | 341713   |
| Q008            | trans. BF 491            | 307912   | R077            | wire-wound resistor 3,3kohm | 341712   |
| Q009            | trans. MJE 350           | 338869   | R098            | Res. trimpot 10 kOhm lin    | 308645   |
| Q010            | trans. BF 391            | 307911   | R100            | Res. trimpot 10 kOhm lin    | 308645   |
| Q011            | trans. MJE 340           | 338868   | R117            | wire-wound resistor 3,3kohm | 341712   |
| Q012            | trans. MJE 340           | 338868   | R118            | wire-wound resistor 3,3kohm | 341712   |
| Q013            | trans. MJE 350           | 338869   | R122            | Res. trimpot 100kohm lin    | 308691   |
| Q014            | trans. MJE 350           | 338869   | R137            | Res. trimpot 470 ohm lin    | 331427   |
| Q015            | trans. BC 560 B          | 306928   | R142            | wire-wound resistor 4,7ohm  | 341713   |
| Q016            | trans. BC 337-25         | 307150   | R144            | wire-wound resistor 3,3kohm | 341712   |
| Q017            | trans. BC 337-25         | 307150   | R187            | safety component            | 333819   |
| Q018            | trans. BF 391            | 307911   | S001            | sliding switch              | 340423   |
| Q019            | triac MAC 223-6          | 338876   | S002            | sliding switch              | 340423   |
| Q020            | triac MAC 223-6          | 338876   | S003            | control element on/off      | 327947   |
| Q021            | trans. BC 327-25         | 307430   | S004            | control element on/off      | 327947   |
| Q022            | trans. BC 327-25         | 307430   | S007            | control element on/off      | 327947   |
| Q023            | trans. BC 550 B          | 301184   | S009            | control element on/off      | 327947   |
| Q024            | trans. BC 550 B          | 301184   | S010            | sliding switch              | 305412   |
| Q025            | trans. BC 550 B          | 301184   | S011            | sliding switch              | 305412   |
| Q026            | trans. BC 550 B          | 301184   | S012            | mains switch                | 334626   |
| Q027            | trans. BF 391            | 307911   | 0005            | IC socket 8pol              | 309354   |
| Q028            | trans. BF 491            | 307912   | 0020            | fuse holder                 | 328390   |

| Pos. in diagram<br>description | Part-No. | Pos. in diagram<br>description | Part-No. |
|--------------------------------|----------|--------------------------------|----------|
| 0100 connector 6pol            | 306840   | I001 IC BA 6144                | 338606   |
| 0101 connector 6pol            | 306840   | I002 IC BA 6144                | 338606   |
| 0105 connector 4pol            | 306609   | I003 IC BA 6144                | 338606   |
| 0110 connector 9pol            | 306446   | I004 IC BA 6144                | 338606   |
| 0115 shorting plug             | 306397   | R017 potentiometer 50k lin B   | 339727   |
|                                |          | R018 potentiometer 50k lin B   | 339727   |
| 1000 PCA Modul kompl.          | 821648   | 00020 power transformer        | 344379   |
|                                |          | 00080 switch thermo UP6 90C    | 332753   |
| 00015 PCB                      | 871008   |                                |          |
| C001 KO-EL 2.2MF 50V           | 304986   |                                |          |
| C002 KO-EL 2.2MF 50V           | 304986   |                                |          |
| C003 KO-EL 10MF 35V            | 307445   |                                |          |
| C004 KO-EL 10MF 35V            | 307445   |                                |          |
| C005 KO-EL 2.2MF 50V           | 304986   |                                |          |
| C006 KO-EL 2.2MF 50V           | 304986   |                                |          |
| C007 KO-EL 10MF 35V            | 307445   |                                |          |
| C008 KO-EL 10MF 35V            | 307445   |                                |          |
| C009 KO-EL 10MF 35V            | 307445   |                                |          |
| D001 LED green 2,5x5mm         | 334693   |                                |          |
| D002 LED green 2,5x5mm         | 334693   |                                |          |
| D003 LED green 2,5x5mm         | 334693   |                                |          |
| D004 LED green 2,5x5mm         | 334693   |                                |          |
| D005 LED green 2,5x5mm         | 334693   |                                |          |
| D006 LED green 2,5x5mm         | 334693   |                                |          |
| D007 LED green 2,5x5mm         | 334693   |                                |          |
| D008 LED green 2,5x5mm         | 334693   |                                |          |
| D009 LED green 2,5x5mm         | 334693   |                                |          |
| D010 LED green 2,5x5mm         | 334693   |                                |          |
| D011 LED green 2,5x5mm         | 334693   |                                |          |
| D012 LED green 2,5x5mm         | 334693   |                                |          |
| D013 LED red 2,5x5mm           | 334694   |                                |          |
| D014 LED red 2,5x5mm           | 334694   |                                |          |
| D015 LED green 2,5x5mm         | 334693   |                                |          |
| D016 LED green 2,5x5mm         | 334693   |                                |          |
| D017 diode 1N 4148             | 346335   |                                |          |
| D018 diode zener BZX 55C 2V4   | 329511   |                                |          |
| D019 diode 1N 4148             | 301254   |                                |          |
| D020 LED red 2,5x5mm           | 334694   |                                |          |
| D021 LED green 2,5x5mm         | 334693   |                                |          |
| D022 LED green 2,5x5mm         | 334693   |                                |          |
| D023 LED green 2,5x5mm         | 334693   |                                |          |
| D024 LED green 2,5x5mm         | 334693   |                                |          |
| D025 LED green 2,5x5mm         | 334693   |                                |          |
| D026 LED green 2,5x5mm         | 334693   |                                |          |
| D027 LED green 2,5x5mm         | 334693   |                                |          |
| D028 LED green 2,5x5mm         | 334693   |                                |          |
| D029 LED green 2,5x5mm         | 334693   |                                |          |
| D030 LED green 2,5x5mm         | 334693   |                                |          |
| D031 LED green 2,5x5mm         | 334693   |                                |          |
| D032 LED red 2,5x5mm           | 334694   |                                |          |
| D033 LED red 2,5x5mm           | 334694   |                                |          |
| D034 LED red 2,5x5mm           | 334694   |                                |          |
| D035 LED red 2,5x5mm           | 334694   |                                |          |

| Pos. in diagram | description                 | Part-No. | Pos. in diagram | description                 | Part-No. |
|-----------------|-----------------------------|----------|-----------------|-----------------------------|----------|
| B 001           | speaker socket 4pol.        | 341343   | C049            | safety component            | 341714   |
| B 002           | speaker socket 4pol.        | 341343   | C050            | safety component            | 341714   |
| B 003           | speaker socket 4pol.        | 341343   | C052            | KO-EL 1000MF 25V            | 337597   |
| S 001           | sliding switch              | 335941   | C053            | KO-EL 1000MF 25V            | 337597   |
| 00020           | plexiglas panel             | 341264   | D001            | diode zener BZX 55C 15V     | 309450   |
| 00030           | knob D 10 black             | 341580   | D002            | diode zener BZX 55C 15V     | 309450   |
| 00060           | handle 55mm 2HE             | 341265   | D003            | diode 1N 4002               | 304360   |
| 00160           | power button black          | 341382   | D004            | diode 1N 4002               | 304360   |
| 00170           | switch                      | 334628   | D005            | diode 1N 4002               | 304360   |
| 00180           | wire unit L=497             | 340430   | D006            | diode 1N 4002               | 304360   |
| 00260           | fan TYP 8314 24V/DC         | 341614   | D007            | diode 1N 4002               | 304360   |
| 00870           | rubber foot                 | 335589   | D008            | diode zener 1N 5352B 15V    | 331422   |
|                 |                             |          | D009            | diode zener 1N 5352B 15V    | 331422   |
| 55000           | PCB power amp               | 337049   | D010            | diode zener ZPD 12V 0,5W    | 305738   |
| Q 001           | trans. 2SK 176              | 337637   | D011            | diode 1N 4148               | 301254   |
| Q 004           | trans. 2SK 176              | 337637   | D012            | diode 1N 4148               | 301254   |
| Q 005           | trans. 2SJ 56               | 337636   | D013            | diode zener ZPD 12V 0,5W    | 305738   |
| Q 008           | trans. 2SJ 56               | 337636   | D014            | diode zener BZX 55C 2V4     | 329511   |
| Q 009           | trans. 2SK 176              | 337637   | D015            | diode zener ZPD 12V 0,5W    | 305738   |
| Q 012           | trans. 2SK 176              | 337637   | D016            | diode MBS 4991              | 338875   |
| Q 013           | trans. 2SJ 56               | 337636   | D017            | diode MBS 4991              | 338875   |
| Q 016           | trans. 2SJ 56               | 337636   | D018            | diode zener TYP 1,5 KE120CA | 339061   |
| R 186           | safety component            | 329981   | D019            | diode zener TYP 1,5 KE120CA | 339061   |
| S 005           | thermal cut out switch      | 339137   | D020            | diode 1N 4002               | 304360   |
|                 |                             |          | D021            | diode 1N 4002               | 304360   |
| 10000           | PCB                         | 841198   | D022            | diode 1N 4002               | 304360   |
| R005            | wire-wound resistor 0,39ohm | 341711   | D023            | diode 1N 4002               | 304360   |
| R008            | wire-wound resistor 0,39ohm | 341711   | D024            | diode zener 1N 5352B 15V    | 331422   |
| R009            | wire-wound resistor 0,39ohm | 341711   | D025            | diode zener 1N 5352B 15V    | 331422   |
| R012            | wire-wound resistor 0,39ohm | 341711   | D026            | diode zener ZPD 12V 0,5W    | 305738   |
| R021            | wire-wound resistor 0,39ohm | 341711   | D027            | diode 1N 4148               | 301254   |
| R024            | wire-wound resistor 0,39ohm | 341711   | D028            | diode 1N 4148               | 301254   |
| R025            | wire-wound resistor 0,39ohm | 341711   | D029            | diode zener ZPD 12V 0,5W    | 305738   |
| R028            | wire-wound resistor 0,39ohm | 341711   | D030            | diode zener BZX 55C 2V4     | 329511   |
| 0005            | fuse holder                 | 306838   | D031            | diode zener ZPD 12V 0,5W    | 305738   |
| B001            | XLR socket female chassis   | 331267   | D032            | diode 1N 4002               | 304360   |
| B002            | XLR socket male chassis     | 330607   | D033            | diode BAT 85                | 301297   |
| B003            | phone jack                  | 340985   | D036            | diode zener ZPD 20V 0,5W    | 301310   |
| B004            | XLR socket female chassis   | 331267   | D037            | diode zener ZPD 51V 0,5W    | 341613   |
| B005            | XLR socket male chassis     | 330607   | D038            | diode 1N 4006               | 305739   |
| B006            | phone jack                  | 340985   | D039            | diode BAT 85                | 301297   |
| C011            | KO-EL 47MF 50V              | 343530   | D040            | diode zener ZPD 20V 0,5W    | 301310   |
| C012            | KO-EL 47MF 50V              | 343530   | D041            | diode zener ZPD 51V 0,5W    | 341613   |
| C026            | KO-EL 47MF 50V              | 343530   | D042            | diode 1N 4006               | 305739   |
| C027            | KO-EL 47MF 50V              | 343530   | E001            | relay ES HA 001 24          | 339849   |
| C039            | KO-EL 10MF 35V              | 307445   | E002            | relay RP 310 024            | 330404   |
| C040            | KO-EL 10MF 35V              | 307445   | E003            | relay RP 310 024            | 330404   |
| C041            | KO-EL 1000MF 25V            | 337597   | E004            | relay RP 310 024            | 330404   |
| C042            | KO-EL 1000MF 25V            | 337597   | F001            | fuse T 16A 250V US          | 343377   |
| C043            | KO-EL 4700.000MF 100V       | 340437   | G001            | rectifier B 80 C1500 M      | 340791   |
| C044            | KO-EL 4700.000MF 100V       | 340437   | G002            | rectifier KBPC 35-04        | 343270   |
| C047            | KO-EL 4700.000MF 100V       | 340437   | I001            | IC NE 5532 N                | 327197   |
| C048            | KO-EL 4700.000MF 100V       | 340437   | I002            | IC NE 5532 N                | 327197   |



| Pos. in diagram | description      | Part-No. | Pos. in diagram | description                 | Part-No. |
|-----------------|------------------|----------|-----------------|-----------------------------|----------|
| I003            | IC NE 5532 N     | 327197   | Q047            | trans. BC 327-25            | 307430   |
| I004            | IC LM 308 A      | 338359   | R015            | Res. trimpot 47 kohm lin    | 307602   |
| I005            | IC LM 308 A      | 338359   | R016            | Res. trimpot 2.2 kohm lin   | 335930   |
| I006            | IC LM 340 T-15   | 308292   | R018            | Res. trimpot 47 kohm lin    | 307602   |
| I007            | IC LM 7915 CT    | 308293   | R019            | Res. trimpot 2.2 kohm lin   | 335930   |
| L001            | coil DCN 340092  | 340092   | R024            | Res. trimpot 47 kohm lin    | 307602   |
| L002            | coil DCN 340092  | 340092   | R028            | Res. trimpot 47 kohm lin    | 307602   |
| Q001            | trans. BC 337-25 | 307150   | R029            | Res. trimpot 47 kohm lin    | 307602   |
| Q002            | trans. BC 337-25 | 307150   | R033            | Res. trimpot 47 kohm lin    | 307602   |
| Q003            | trans. BC 617    | 334633   | R050            | wire-wound resistor 3,3kohm | 341712   |
| Q004            | trans. BC 617    | 334633   | R051            | wire-wound resistor 3,3kohm | 341712   |
| Q005            | trans. BF 391    | 307911   | R055            | Res. trimpot 100kohm lin    | 308691   |
| Q006            | trans. BF 491    | 307912   | R069            | Res. trimpot 470 ohm lin    | 331427   |
| Q007            | trans. BF 391    | 307911   | R074            | wire-wound resistor 4,7ohm  | 341713   |
| Q008            | trans. BF 491    | 307912   | R077            | wire-wound resistor 3,3kohm | 341712   |
| Q009            | trans. MJE 350   | 338869   | R098            | Res. trimpot 10 kOhm lin    | 308645   |
| Q010            | trans. BF 391    | 307911   | R100            | Res. trimpot 10 kOhm lin    | 308645   |
| Q011            | trans. MJE 340   | 338868   | R117            | wire-wound resistor 3,3kohm | 341712   |
| Q012            | trans. MJE 340   | 338868   | R118            | wire-wound resistor 3,3kohm | 341712   |
| Q013            | trans. MJE 350   | 338869   | R122            | Res. trimpot 100kohm lin    | 308691   |
| Q014            | trans. MJE 350   | 338869   | R137            | Res. trimpot 470 ohm lin    | 331427   |
| Q015            | trans. BC 560 B  | 306928   | R142            | wire-wound resistor 4,7ohm  | 341713   |
| Q016            | trans. BC 337-25 | 307150   | R144            | wire-wound resistor 3,3kohm | 341712   |
| Q017            | trans. BC 337-25 | 307150   | R187            | safety component            | 333819   |
| Q018            | trans. BF 391    | 307911   | S001            | sliding switch              | 340423   |
| Q019            | triac MAC 223-6  | 338876   | S002            | sliding switch              | 340423   |
| Q020            | triac MAC 223-6  | 338876   | S003            | control element on/off      | 327947   |
| Q021            | trans. BC 327-25 | 307430   | S004            | control element on/off      | 327947   |
| Q022            | trans. BC 327-25 | 307430   | S007            | control element on/off      | 327947   |
| Q023            | trans. BC 550 B  | 301184   | S009            | control element on/off      | 327947   |
| Q024            | trans. BC 550 B  | 301184   | S010            | sliding switch              | 305412   |
| Q025            | trans. BC 550 B  | 301184   | S011            | sliding switch              | 305412   |
| Q026            | trans. BC 550 B  | 301184   | S012            | mains switch                | 334626   |
| Q027            | trans. BF 391    | 307911   | 0005            | IC socket 8pol              | 309354   |
| Q028            | trans. BF 491    | 307912   | 0020            | fuse holder                 | 328390   |
| Q029            | trans. BF 391    | 307911   | 0100            | connector 6pol              | 306840   |
| Q030            | trans. BF 491    | 307912   | 0101            | connector 6pol              | 306840   |
| Q031            | trans. BF 391    | 307911   | 0105            | connector 4pol              | 306609   |
| Q032            | trans. MJE 350   | 338869   | 0110            | connector 9pol              | 306446   |
| Q033            | trans. MJE 340   | 338868   | 0115            | shorting plug               | 306397   |
| Q034            | trans. MJE 340   | 338868   |                 |                             |          |
| Q035            | trans. MJE 350   | 338869   | 1000            | PCA Modul kompl.            | 821648   |
| Q036            | trans. MJE 350   | 338869   |                 |                             |          |
| Q037            | trans. BC 560 B  | 306928   | 00015           | PCB                         | 871008   |
| Q038            | trans. BC 337-25 | 307150   | C001            | KO-EL 2.2MF 50V             | 304986   |
| Q039            | trans. BC 337-25 | 307150   | C002            | KO-EL 2.2MF 50V             | 304986   |
| Q040            | trans. BF 391    | 307911   | C003            | KO-EL 10MF 35V              | 307445   |
| Q041            | trans. BC 550 B  | 301184   | C004            | KO-EL 10MF 35V              | 307445   |
| Q042            | trans. BC 550 B  | 301184   | C005            | KO-EL 2.2MF 50V             | 304986   |
| Q043            | trans. BC 327-25 | 307430   | C006            | KO-EL 2.2MF 50V             | 304986   |
| Q044            | trans. BC 327-25 | 307430   | C007            | KO-EL 10MF 35V              | 307445   |
| Q045            | trans. BC 327-25 | 307430   | C008            | KO-EL 10MF 35V              | 307445   |
| Q046            | trans. BC 327-25 | 307430   | C009            | KO-EL 10MF 35V              | 307445   |



| Pos. in diagram | description             | Part-No. | Pos. in diagram | description | Part-No. |
|-----------------|-------------------------|----------|-----------------|-------------|----------|
| D001            | LED green 2,5x5mm       | 334693   |                 |             |          |
| D002            | LED green 2,5x5mm       | 334693   |                 |             |          |
| D003            | LED green 2,5x5mm       | 334693   |                 |             |          |
| D004            | LED green 2,5x5mm       | 334693   |                 |             |          |
| D005            | LED green 2,5x5mm       | 334693   |                 |             |          |
| D006            | LED green 2,5x5mm       | 334693   |                 |             |          |
| D007            | LED green 2,5x5mm       | 334693   |                 |             |          |
| D008            | LED green 2,5x5mm       | 334693   |                 |             |          |
| D009            | LED green 2,5x5mm       | 334693   |                 |             |          |
| D010            | LED green 2,5x5mm       | 334693   |                 |             |          |
| D011            | LED green 2,5x5mm       | 334693   |                 |             |          |
| D012            | LED green 2,5x5mm       | 334693   |                 |             |          |
| D013            | LED red 2,5x5mm         | 334694   |                 |             |          |
| D014            | LED red 2,5x5mm         | 334694   |                 |             |          |
| D015            | LED green 2,5x5mm       | 334693   |                 |             |          |
| D016            | LED green 2,5x5mm       | 334693   |                 |             |          |
| D017            | diode 1N 4148           | 346335   |                 |             |          |
| D018            | diode zener BZX 55C 2V4 | 329511   |                 |             |          |
| D019            | diode 1N 4148           | 301254   |                 |             |          |
| D020            | LED red 2,5x5mm         | 334694   |                 |             |          |
| D021            | LED green 2,5x5mm       | 334693   |                 |             |          |
| D022            | LED green 2,5x5mm       | 334693   |                 |             |          |
| D023            | LED green 2,5x5mm       | 334693   |                 |             |          |
| D024            | LED green 2,5x5mm       | 334693   |                 |             |          |
| D025            | LED green 2,5x5mm       | 334693   |                 |             |          |
| D026            | LED green 2,5x5mm       | 334693   |                 |             |          |
| D027            | LED green 2,5x5mm       | 334693   |                 |             |          |
| D028            | LED green 2,5x5mm       | 334693   |                 |             |          |
| D029            | LED green 2,5x5mm       | 334693   |                 |             |          |
| D030            | LED green 2,5x5mm       | 334693   |                 |             |          |
| D031            | LED green 2,5x5mm       | 334693   |                 |             |          |
| D032            | LED red 2,5x5mm         | 334694   |                 |             |          |
| D033            | LED red 2,5x5mm         | 334694   |                 |             |          |
| D034            | LED red 2,5x5mm         | 334694   |                 |             |          |
| D035            | LED red 2,5x5mm         | 334694   |                 |             |          |
| I001            | IC BA 6144              | 338606   |                 |             |          |
| I002            | IC BA 6144              | 338606   |                 |             |          |
| I003            | IC BA 6144              | 338606   |                 |             |          |
| I004            | IC BA 6144              | 338606   |                 |             |          |
| R017            | potentiometer 50k lin B | 339727   |                 |             |          |
| R018            | potentiometer 50k lin B | 339727   |                 |             |          |
| 00020           | power transformer       | 344378   |                 |             |          |
| 00080           | switch thermo UP6 90C   | 332753   |                 |             |          |

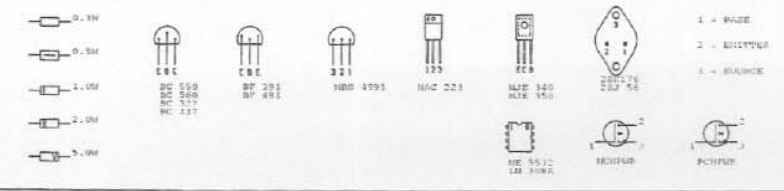
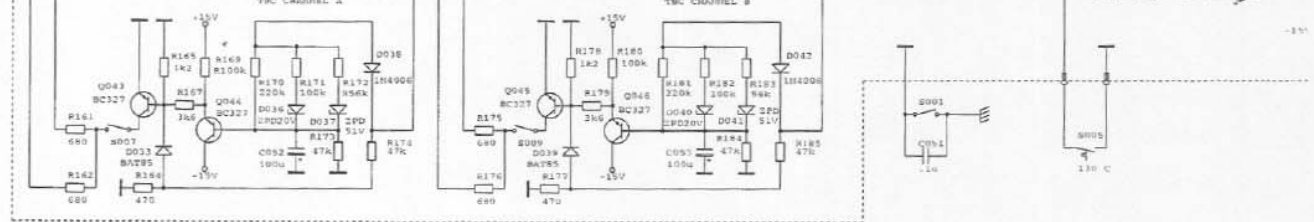
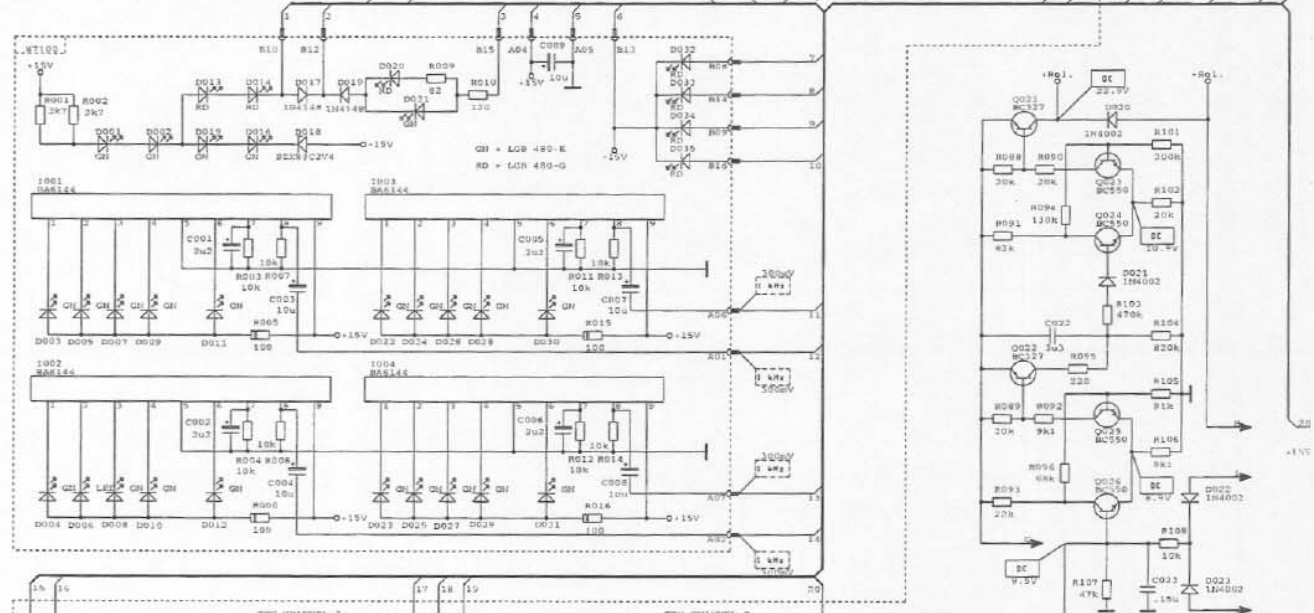
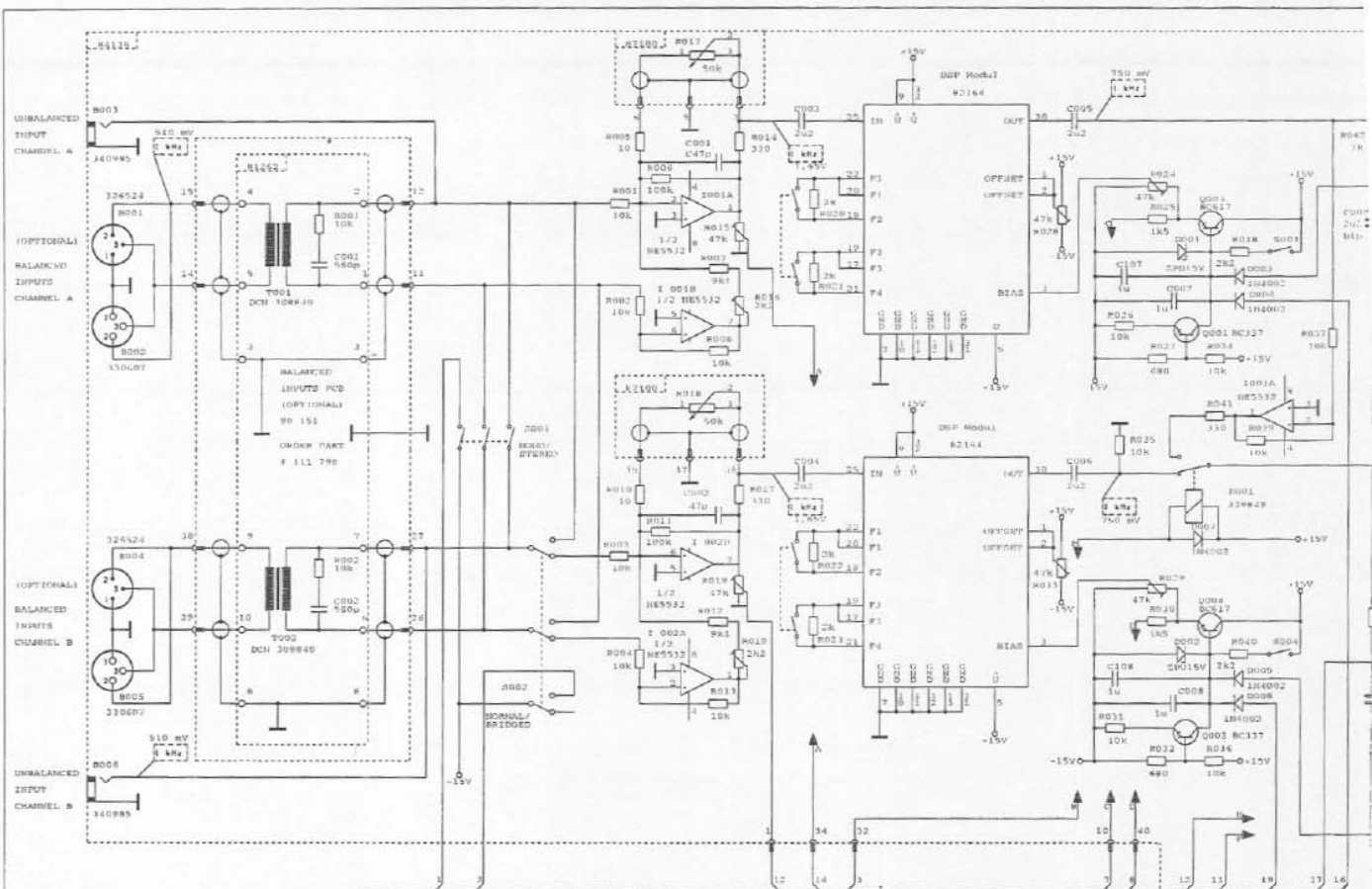

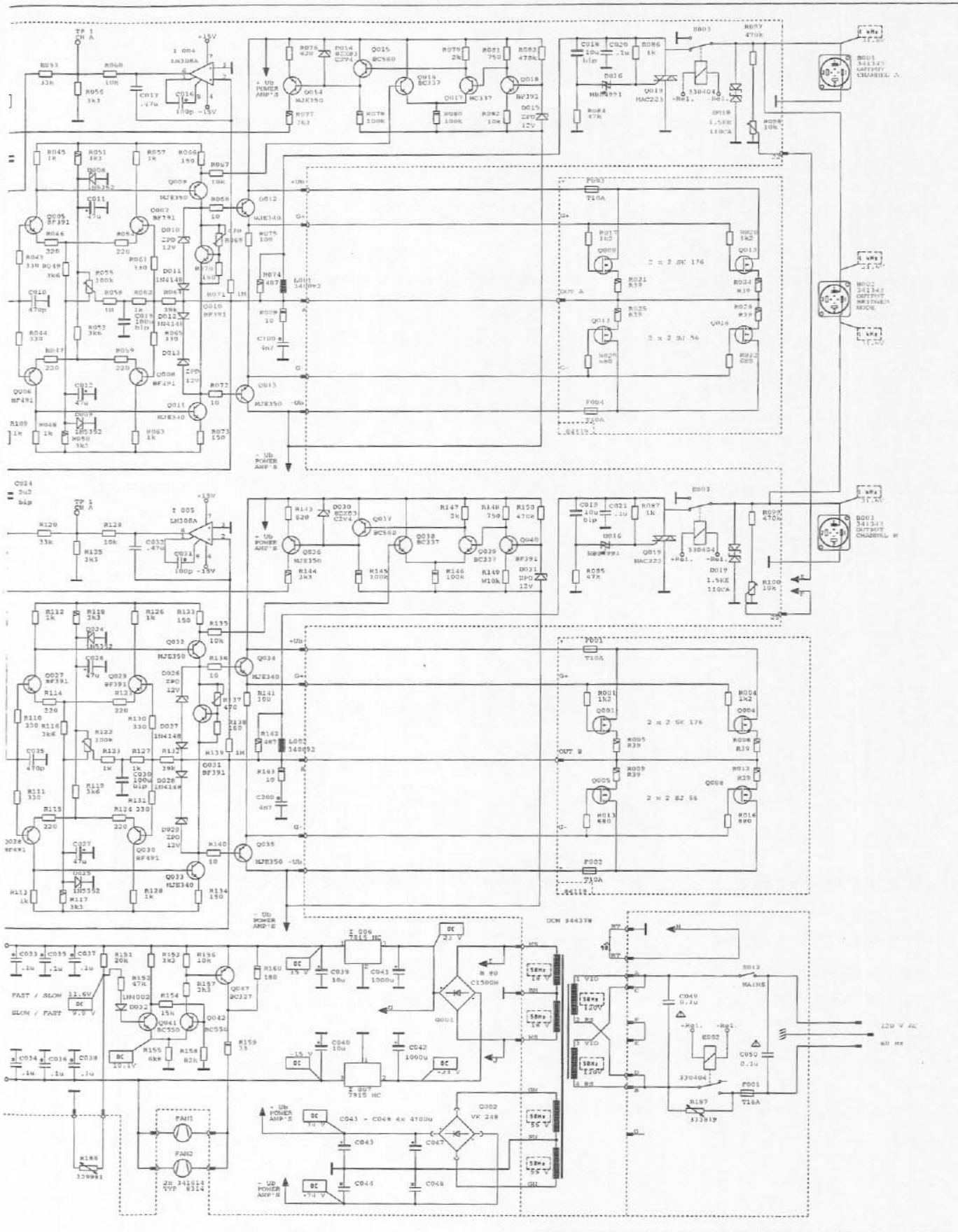

▲ SAFETY COMPONENT (MUST BE REPLACED BY ORIGINAL PART)  
 [Symbol] AC VOLTAGE 50/60 HZ MEASURED WITH VOLTMETER 200V OHM/V  
 [Symbol] DC VOLTAGE MEASURED WITH VOLTMETER 100 OHM/V

| DYNACORD |            |    | CIRCUIT DIAGRAM |  |
|----------|------------|----|-----------------|--|
| 343 402  | PCA 2250 U | 1- |                 |  |

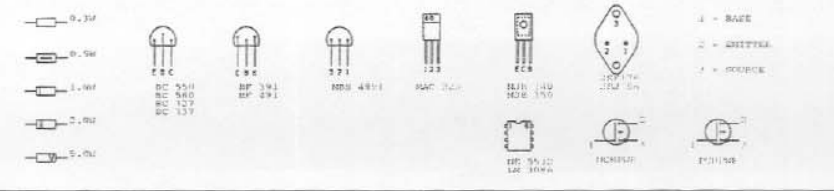
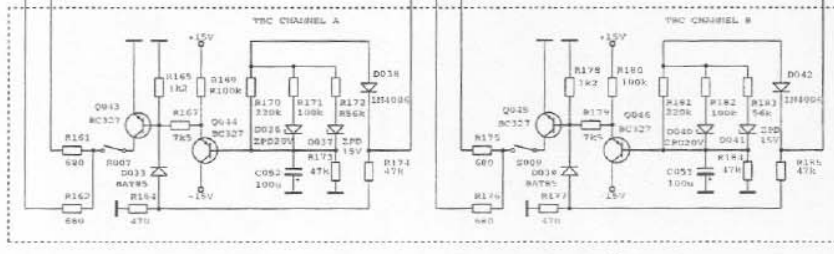
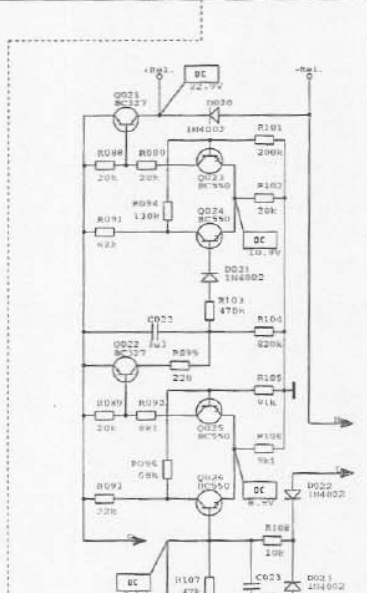
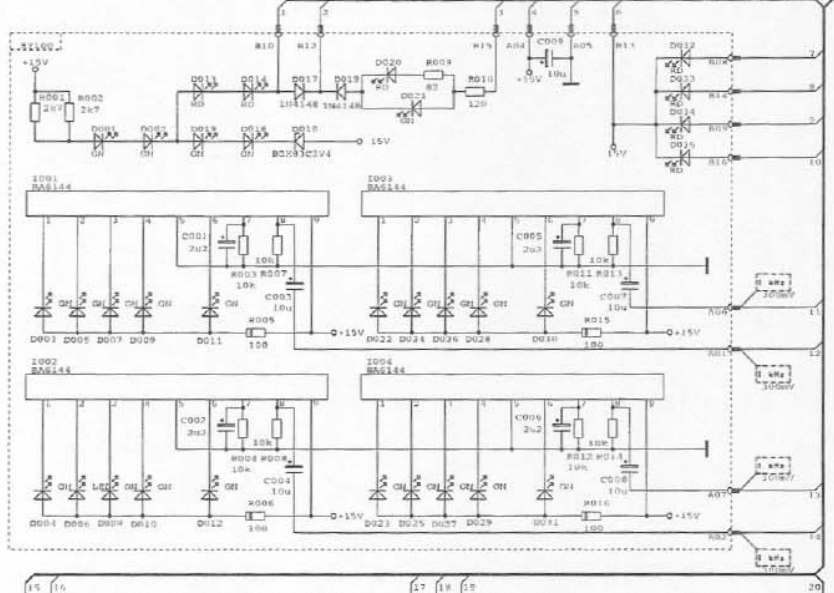
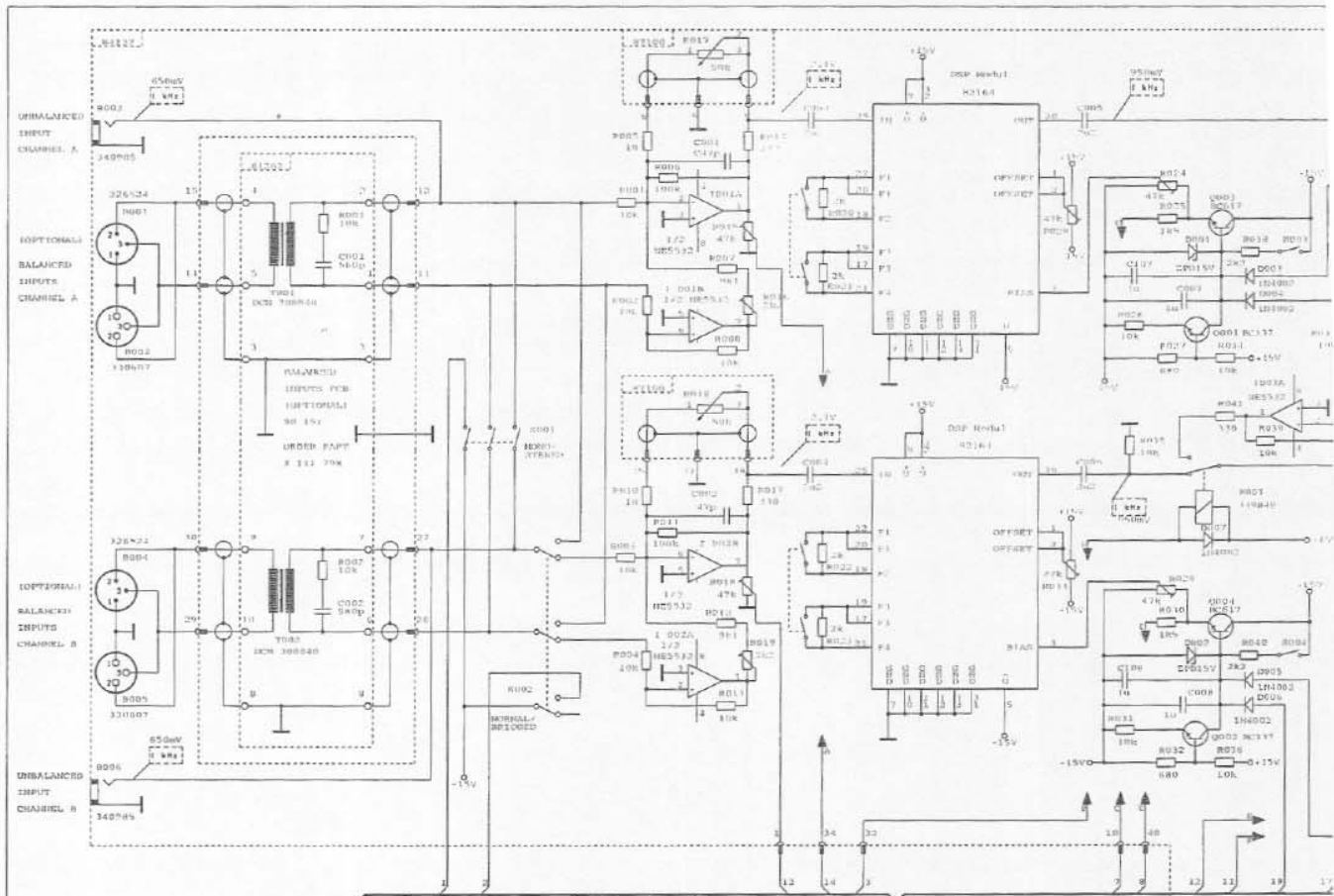

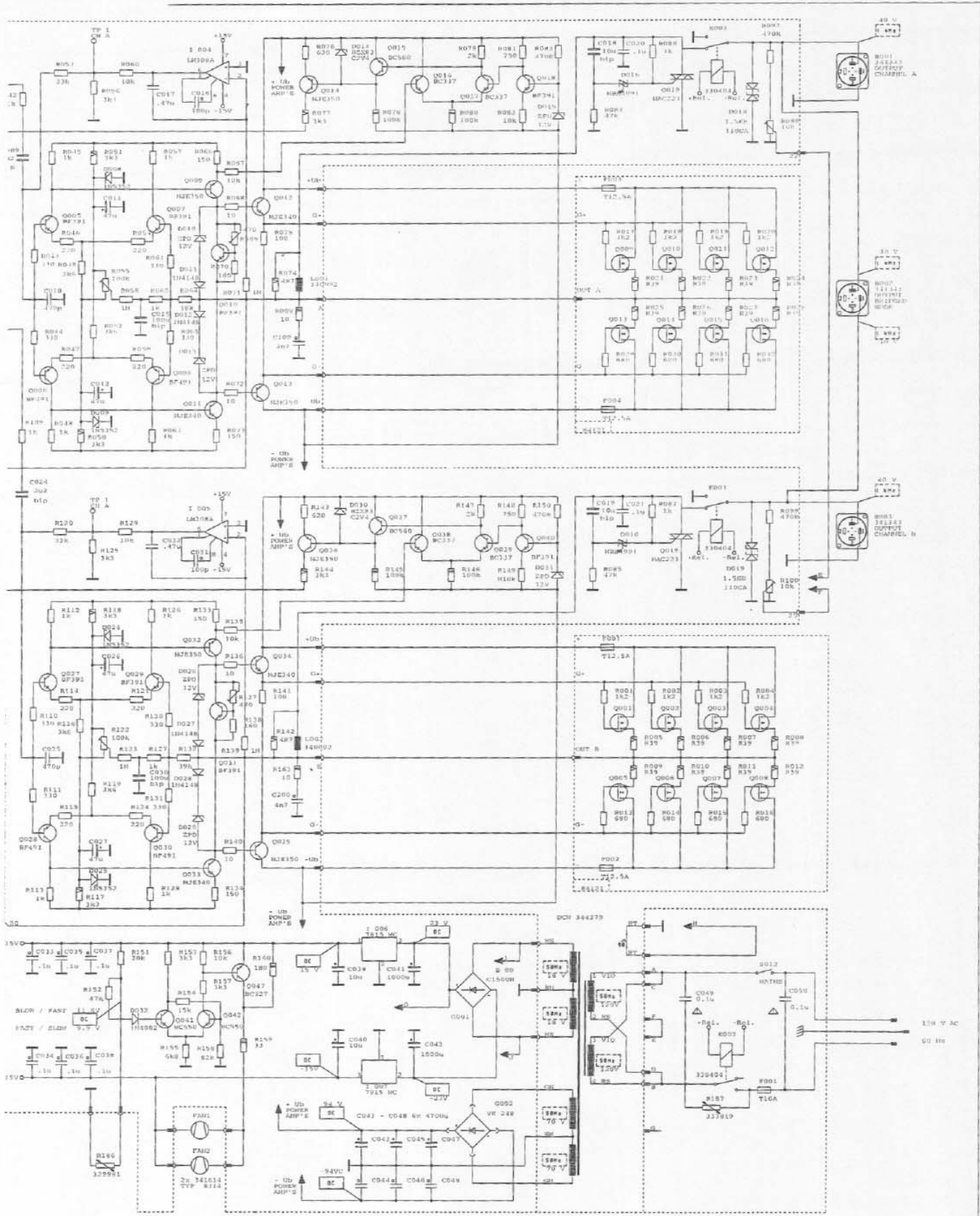

▲ SAFETY COMPONENT (NEVER BE REPLACED BY ORIGINAL PART)  
 100Ω AC VOLTAGE 50/60 HZ MEASURED WITH VOLTMETER 2000 OHM/V  
 50Ω AC VOLTAGE MEASURED WITH VOLTMETER 100 OHM/V

| REVISION |    |      | CIRCUIT DIAGRAM | 1- |
|----------|----|------|-----------------|----|
| NO.      | TO | FROM |                 |    |
|          |    |      |                 |    |
| DYNACORD |    |      | 343 403         | 1- |
|          |    |      | PCA 2450 U      |    |



## WARRANTY (Limited)

Electro-Voice products are guaranteed against malfunction due to defects in materials or workmanship for a specified period, as noted in the individual product-line statement(s) below, or in the individual product data sheet or owner's manual, beginning with the date of original purchase. If such malfunction occurs during the specified period, the product will be repaired or replaced (at our option) without charge. The product will be returned to the customer prepaid. **Exclusions and Limitations:** The Limited Warranty does not apply to: (a) exterior finish or appearance; (b) certain specific items described in the individual product-line statement(s) below, or in the individual product data sheet or owner's manual; (c) malfunction resulting from use or operation of the product other than as specified in the product data sheet or owner's manual; (d) malfunction resulting from misuse or abuse of the product; or (e) malfunction occurring at any time after repairs have been made to the product by anyone other than Electro-Voice or any of its authorized service representatives. **Obtaining Warranty Service:** To obtain warranty service, a customer must deliver the product, prepaid, to Electro-Voice or any of its authorized service representatives together with proof of purchase of the product in the form of a bill of sale or receipted invoice. A list of authorized service representatives is available from Electro-Voice at 600 Cecil Street, Buchanan, MI 49107 (616/695-6831) and/or Electro-Voice West, at 8294 Doe Avenue, Visalia, CA 93291 (209/651-7777). **Incidental and Consequential Damages Excluded:** Product repair or replacement and return to the customer are the only remedies provided to the customer. Electro-Voice shall not be liable for any incidental or consequential damages including, without limitation, injury to persons or property or loss of use. Some states do not allow the exclusion or limitation of incidental or consequential damages so the above limitation or exclusion may not apply to you. **Other Rights:** This warranty gives you specific legal rights, and you may also have other rights which vary from state to state.

**Electro-Voice Electronics** are guaranteed against malfunction due to defects in materials or workmanship for a period of three (3) years from the date of original purchase. Additional details are included in the Uniform Limited Warranty statement.

Service and repair address for this product: Electro-Voice, Inc. 600 Cecil Street, Buchanan, Michigan 49107.

Specifications subject to change without notice.



Electro-Voice a MARK IV company

600 Cecil Street, Buchanan, Michigan 49107, Phone (616) 695-6831, Fax: 616-695-1304

8234 Doe Avenue, Visalia, California 93291, Phone (209) 651-7777, Fax: (209) 651-0164

MarkIV Audio Canada, Inc. 345 Herbert St., Gananoque, Ontario, Canada K7G 2V1, Phone (613)382-2141, Fax (613)382-7466