

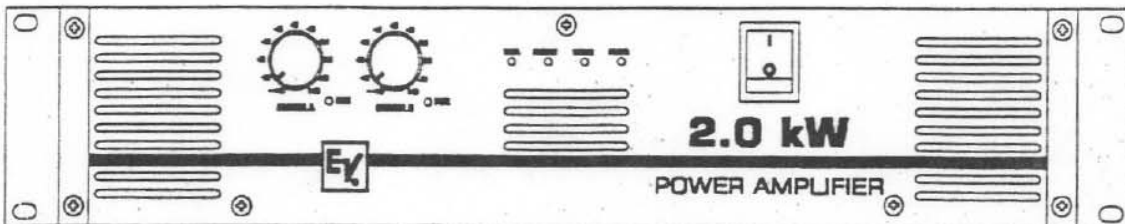

**Electro-Voice®**

1.0KW, 1.5KW, 2.0KW

**STEREO POWER AMPLIFIERS**

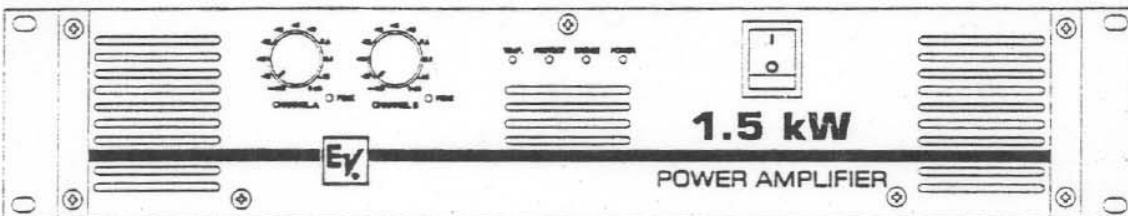
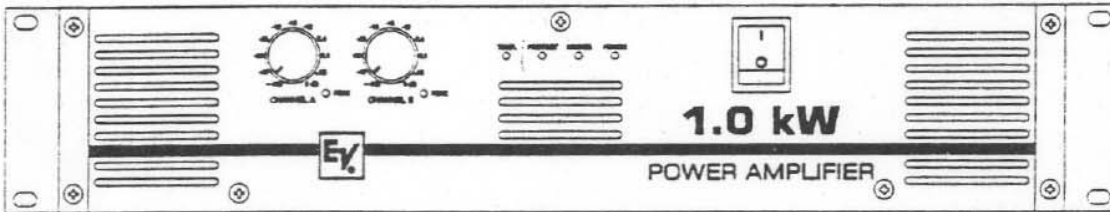



<u>TABLE OF CONTENT</u>	<u>PAGE</u>	<u>TABLES AND ILLUSTRATIONS</u>	<u>PAGE</u>
<u>Product Description</u>	<u>2</u>	<u>Input Figure 1A &amp; 1B</u>	<u>4</u>
<u>Unpacking</u>	<u>3</u>	<u>Output</u>	
<u>Precautions</u>	<u>3</u>	<u>Dual Mode Figure 2</u>	<u>5</u>
<u>Specifications</u>	<u>4</u>	<u>Bridge Mode Figure 3</u>	<u>6</u>
<u>Input Connections</u>	<u>5</u>	<u>Processor Figure 4</u>	<u>6</u>
<u>Output Connections</u>	<u>5</u>	<u>Figure5</u>	<u>7</u>
<u>Operation</u>	<u>5</u>	<u>Table I</u>	<u>8</u>
<u>Output Cable Selection</u>	<u>9</u>	<u>Table II</u>	<u>9</u>
<u>Calculating Power Loss</u>	<u>9</u>	<u>Table III, IV, V, VI</u>	<u>10</u>
<u>Damping Factor</u>	<u>10</u>	<u>Speaker Protection</u>	
<u>Parts List</u>	<u>13</u>	<u>OverCurrent Figure 6</u>	<u>12</u>
<u>Block Diagram</u>	<u>23</u>	<u>DC Figure 7</u>	<u>12</u>
<u>Schematic</u>	<u>24</u>	<u>Table VII</u>	<u>12</u>

## Uniform Limited Warranty Statement

Electro-Voice® products are guaranteed against malfunction due to defects in material or workmanship for a specified period, as noted in the product-line statement(s) below, or in the individual product data sheet or owner's manual, beginning with the date of original purchase. If such malfunction occurs during the specified period, the product will be repaired or replaced (at our option) without charge. The product will be returned to the customer prepaid.

**Exclusions and Limitations:** The Limited Warranty does not apply to: (a) exterior finish or appearance; (b) certain specific items described in the individual product-line statement(s) below, or in the individual product data sheet or owner's manual; (c) malfunction resulting from use or operation of the product other than as specified in the product data sheet or owner's manual; (d) malfunction resulting from misuse or abuse of the product; or (e) malfunction occurring at any time after repairs have been made to the product by anyone other than Mark IV Audio Service or any of its authorized service representatives.

**Obtaining Warranty Service:** To obtain warranty service, a customer must deliver the product, prepaid, to Mark IV Audio Service or any of its authorized service representatives together with proof of purchase of the product in the form of a bill of sale or receipted invoice. A list of authorized service representatives is available from Mark IV Audio Service at 600 Cecil Street, Buchanan, MI 49107 (800-234-6831 or FAX 616-895-4743).

**Incidental and Consequential Damages Excluded:** Product repair or replacement and return to the customer are the only remedies provided to the customer. Electro-Voice® shall not be liable for any incidental or consequential damage including, without limitation, injury to persons or property or loss of use. Some states do not allow the exclusion or limitation of incidental or consequential damages so the above limitation or exclusion may not apply to you.

**Other Rights:** This warranty gives you specific legal rights, and you may also have other rights which vary from state to state.

Electro-Voice® Electronics are guaranteed against malfunction due to defects in materials or workmanship for a period of three (3) years from the date of original purchase. Additional details are included in the Uniform Limited Warranty statement.

Electro-Voice® • a MARK IV company



## PRODUCT DESCRIPTION

The Electro-Voice® 1.0 kW, 1.5 kW and 2.0 kW amplifiers are designed to meet the requirements of the Music Instrument and the Concert Sound markets. These dual channel amplifiers are light weight while delivering high power to 4 or 8  $\Omega$  loads. Both channels can be bridged to provide even greater power to an 8  $\Omega$  load. The enhanced performance of these two rack high amplifiers is made possible by combining a Class-H rail technology with dual switchmode power supplies. The high efficiency of both of these technologies combine to provide a cooler running and lighter weight amplifier.

These amplifiers offer an audio signal processor that can be switched ON or OFF. In the ON position the processor provides two different modes of equalization filters. The factory set position is LPN (Low-pass notch), a second-order shelving equalizer with a pole frequency of 50 Hz. This position dramatically and safely enhances the bass performance of compact vented sound reinforcement speaker systems. The second position of the processor is B6. A more conservative equalization scheme, it offers three second-order underdamped high-pass filters with corner frequencies of 60Hz, 43Hz and 26Hz for low-frequency enhancement of sound reinforcement speaker systems.

Detented volume control knobs along with status LEDs are located on the front panel while input and output connectors are located on the rear panel. The input connectors are the combo XLR/PHONE type with parallel output XLRs for ease of daisy-chaining the input signal to other equipment. The output is available on touch-proof binding post. Cooling air is moved from front to rear through two extruded wind tunnels by continuously variable speed fans.

These amplifiers are in full compliance with the safety requirements of UL, CSA and IEC and are in compliance with the emissions requirements of the FCC and VDE.

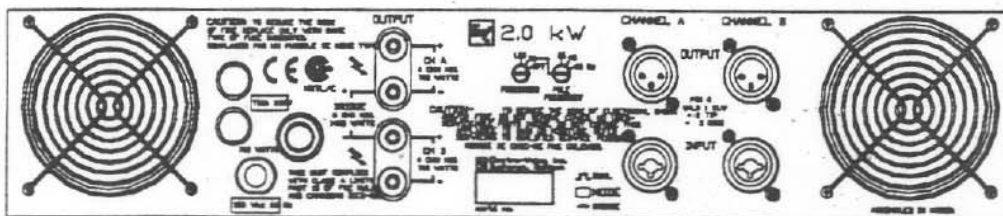
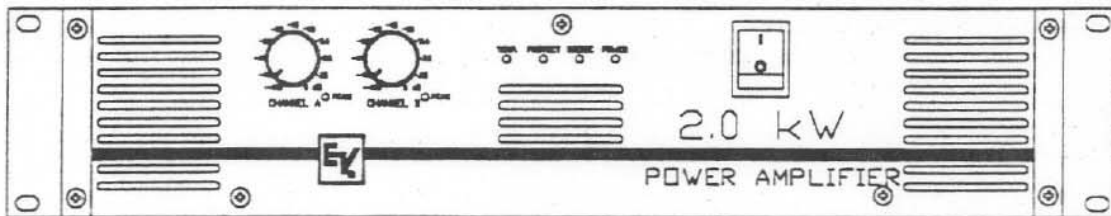



## UNPACKING

This shipping carton is specially designed to protect the amplifier while transporting under normal conditions. It is still possible for damage to occur. Therefore, carefully inspect the outside carton for signs of abuse. If for any reason the amplifier should be returned, use the shipping carton that it came in. Electro-Voice® cannot warranty against damage that occurs as a result of improper packaging.

## PRECAUTIONS

Do not replace the fuses with a higher amp rating than what is specified. There are various circuits inside the amplifier that detect fault conditions and place the amplifier in PROTECT (indicated on the front panel by the red LED). A blown ac panel fuse indicates a more severe problem such as a power supply or amplifier failure. An oversized fuse installed under these conditions can lead to a possible fire hazard.

Should an abnormal operating condition occur that would cause the amplifier to over heat (such as a restriction of the cooling air flow or a prolonged over load) the amplifier will shut down. The front panel LEDs for TEMP and PROTECT will be brightly lit. Remove the fault condition and allow the amplifier temperature to return to normal. The amplifier will automatically restart when it's internal temperature returns to a safe level.

## SPECIFICATIONS

OUTPUT POWER: (Watts)  
 (Ref. 1K Hz, 1% THD)

	1.0KW	1.5KW	2.0KW
Dual Mode			
4-ohm	450	750	900
8-ohm	300	450	550
Bridge Mode			
8-ohm	950	1550	1850
(20 Hz - 20K Hz, < 0.1% THD)			
Dual Mode			
4-ohm	375	600	700
8-ohm	260	350	450
Bridge Mode			
8-ohm	750	1200	1400

INPUT SENSITIVITY (for Rated Full Band Power)

(Vrms/Gain dBV)	1.0KW	1.5KW	2.0KW
Dual Mode	Sens(Gain)	Sens(Gain)	Sens(Gain)
4-ohm	0.74 (34)	0.74 (36)	0.76 (37)
8-ohm	0.84 (34)	0.78 (37)	0.86 (37)
Bridge Mode			
8-ohm	0.73 (41)	0.73 (43)	0.76 (43)

SIGNAL TO NOISE: > 100 dB (A wtd.) measured below rated output



FREQUENCY RESPONSE: 12 Hz to 60K Hz  
 (Ref. 1K Hz, 1 W output, +0/-3 dB, any mode, 30 KHz measurement bandwidth)

CHANNEL SEPARATION: > 50dB

IMD (SMPTE): < 0.05%

SLEW RATE	1.0 KW	1.5 KW	2.0 KW
	20 V/uSec	28 V/uSec	30 V/uSec

DAMPING FACTOR: >200

SIGNAL PROCESSOR: 4 EQ Responses; Selectable Second-order Filters

PHYSICAL:	1.0KW	1.5KW	2.0KW
Depth:	18.5 in.	18.5 in.	18.5 in.
Width:	19.0 in.	19.0 in.	19.0 in.
Height:	3.5 in	3.5 in	3.5 in
Weight:	16 lbs	22 lbs	23 lbs
Shipping Weight:	20 lbs	26 lbs	27 lbs

## INPUT CONNECTIONS

The electronically balanced input connection for each channel is made to a combo connector. The combo connector for each channel is paralleled with a XLR female connector which provides an auxiliary output for routing the input signal to multiple amplifiers. For single-ended unbalanced signal sources, the negative terminal (Ring of the 1/4" phone jack and pin3 of the XLR) should be connected to ground (Sleeve of the 1/4" phone jack and pin 1 of the XLR). The Tip of the 1/4" phone jack connector corresponds to the positive terminal (pin 2 of the XLR). See figure 1.

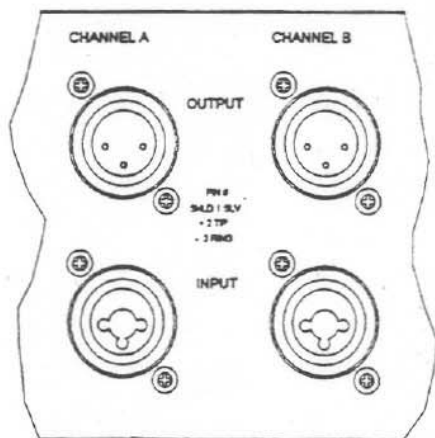

Figure 1A

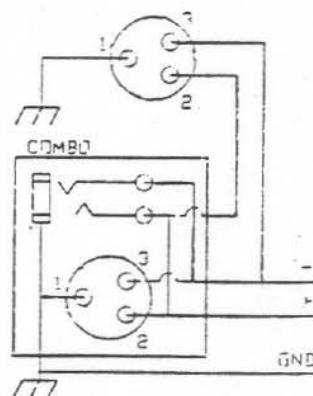

Figure 1B



## OUTPUT CONNECTORS

The output terminals for each channel are tough-proof binding post connectors that accept either banana plugs or up to 7 AWG (4mm) wire. The *Red* post is the high (+) output and the *Black* post is the low (-) output. These connectors are used for both stereo or dual output and mono bridged output. The configuration of the output terminals is controlled by the MODE switch located on the rear of the amplifier.

## OPERATION

**MOUNTING** - The amplifier is designed for standard 19 inch rack mounting. In addition, the amplifiers are equipped with non-skid rubber feet for secure table top or stacked operation. When rack mounting one or more amplifiers or when mounting in combination with other equipment, be sure to allow adequate front and rear ventilation to avoid possible heat related damage to the amplifier or other rack mounted items.

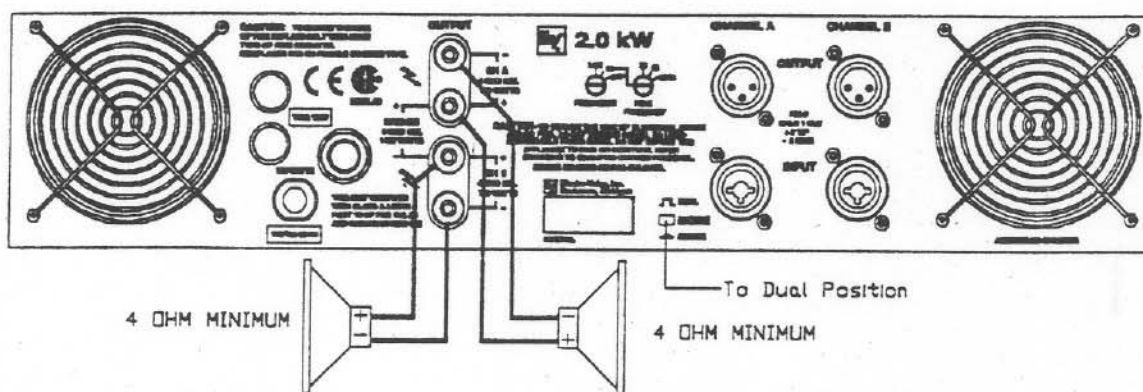

Figure 2

**DUAL MODE** - In the dual mode of operation, each channel may be operated independently into a minimum load impedance of  $4\Omega$  (see figure 2). After installation and hookup, verify that the MODE switch is in the "DUAL" position and that the level controls, located on the front panel, are in the fully counterclockwise (full attenuation) position. Apply power to the amplifier and slowly rotate the level controls clockwise until the desired output power is obtained. If either the "PEAK A" or the "PEAK B" LED is illuminated, reduce the input signal level by rotating the corresponding level control counterclockwise until the LED is extinguished.

**WARNING:** *Never attempt to connect the outputs of the two channels in parallel.*

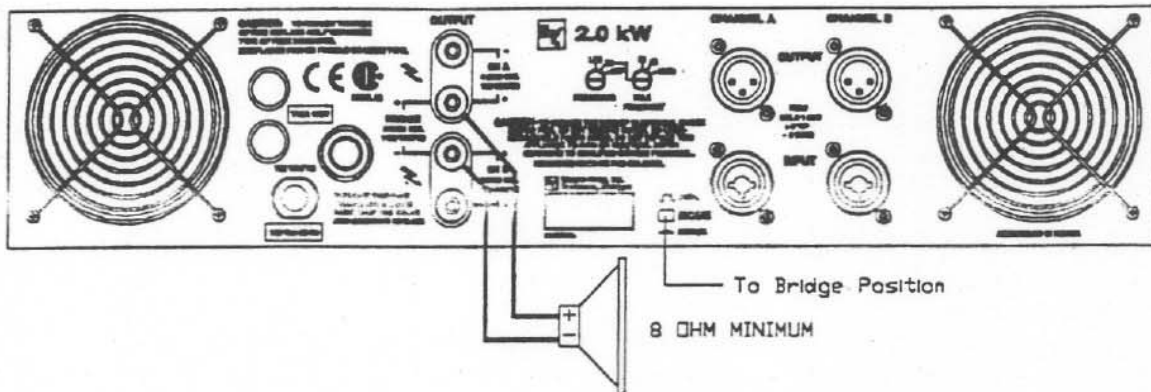

Figure 3

**BRIDGE MODE** - In BRIDGE mode the output load of  $8 \Omega$  or higher is connected across the two Red binding posts. Channel A's Red binding post is the (+) terminal and channel B's Red binding post is the (-) terminal (see figure 3). The input signal is connected to channel A. The channel B input connector is internally disconnected from the channel B amplifier and the channel B amplifier is connected to the channel A input signal after it has been shifted in phase by  $180^\circ$ .

After installation and hookup, verify that the MODE switch is in the "BRIDGE" position and that the level controls (located on the front panel) are in their fully counterclockwise position (full attenuation). Apply power to the amplifier and verify that the "BRIDGE" LED is illuminated. If the "BRIDGE" LED is not illuminated, the MODE switch is in the wrong position. Reset the MODE switch to the "BRIDGE" position.

Slowly rotate the level controls clockwise until the desired output power is obtained. If either the "PEAK A" or the "PEAK B" LED is illuminated, reduce the input signal level by rotating the corresponding level control counterclockwise until the LED is extinguished.

**WARNING:** The bridged output mode provides a true balanced-to-ground output. Do not use any test equipment to test or evaluate this amplifier which does not have floating grounds.

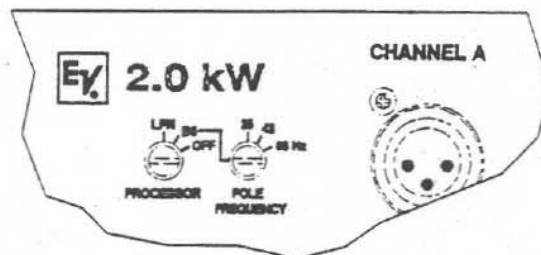
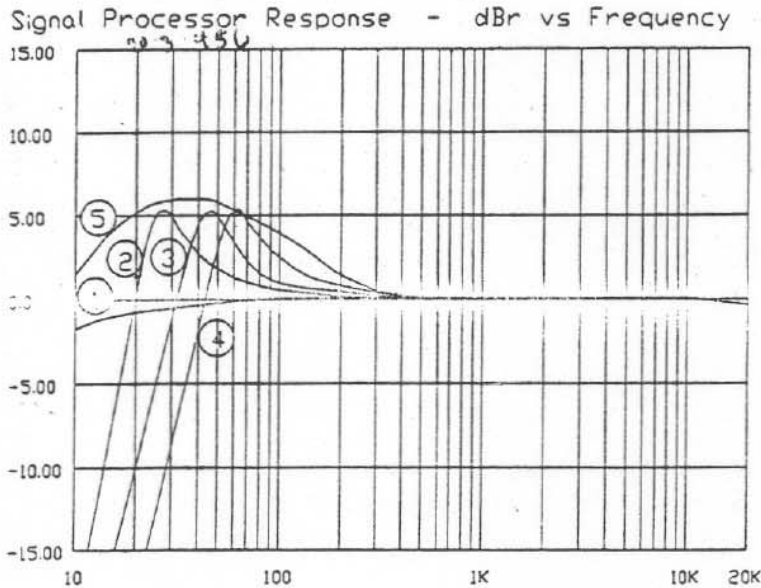

Figure 4

**PROCESSOR** - This switch, located on the rear panel, can be used to select three different processing modes: LPN, B6 and OFF.



Curve 1 PROCESSOR OFF  
Curve 2 B6/26 Hz position  
Curve 3 B6/43 Hz position  
Curve 4 B6/60 Hz position  
Curve 5 LPN position

**POSITION LPN** - The LPN (low-pass-notch) is the factory preset mode, and is a second-order shelving equalizer with a pole frequency of 50 Hz. It dramatically enhances the bass performance of the typical compact, high-efficiency vented speaker system used in portable sound reinforcement. The shape of the response curve (see figure 5) is designed to complement the requirements of these speaker systems and is difficult if not impossible to achieve with conventional, outboard graphic equalizers.

**CAUTION** - Care must be exercised when using the LPN position so as not to over power the speaker with low frequency signals.

**POSITION B6** - In position "B6", an undamped second-order high-pass filter is inserted in the signal path for both low-frequency equalization/enhancement and infrasonic speaker protection. The underdamping produces a maximum 6 dB of bass enhancement at the so-called peak-boost frequency. Below the boost frequency, output is reduced at a rate of 12 dB per octave. This provides—when the frequency of peak-boost is properly matched to the speaker system—a high degree of infrasonic (very-low-frequency) speaker protection. (For detailed comment on infrasonic speaker protection, see Moderate Bass Enhancement of EV Portable Sound Reinforcement Speaker section, below). The B6 position offers three different peak-boost frequencies: 26 Hz, 43 Hz and 60 Hz.

There are two basic situations where the B6 position is appropriate:

1. Moderate bass enhancement of EV portable sound reinforcement speaker systems.
  2. Thiele-Small  $B_6$  alignment of EV fixed-installation low-frequency and subwoofer speaker systems.
- Each application is discussed in more detail below.

#### Moderate Bass Enhancement of EV Portable Sound Reinforcement Speaker Systems

EV sound reinforcement speaker systems are, in general, designed to provide uniform low-frequency response down to just above the frequency where response is specified 3 dB down. The B6 positions, properly chosen, will both enhance this inherent performance and supply infrasonic protection of the speaker/enclosure combination. In an optimally designed vented speaker system, the output near and for an octave or so above the system's 3-dB-down point is supplied substantially by air moving back and forth in the vent, driven to full acoustic output by a relative small motion of the speaker cone itself. The





frequency of maximum vent output is called the "tuning frequency" of the box, where the mass of air in the vent resonates with the "spring" of air within the box.

Strong bass input can be safely applied above the box tuning frequency. Below the box tuning frequency, system output decreases rapidly and cone excursion increases rapidly. Strong bass input in this region can cause distortion, rob amplifier power and even damage the low-frequency speaker. The bass roll-off below the peak-boost frequency of the B6 filters provides protection against such infrasonic (very-low-frequency) signals that could compromise overall system performance. Potentially problematic infrasonic signals include a dropped microphone and synthesizer-produced high-level low bass that the speaker system is not designed to handle.

The 43 and 60 Hz peak-boost frequencies are designed to enhance Electro-Voice portable sound reinforcement speakers. The 43 Hz boost frequency is intended for boxes tuned from 37 to 50 Hz. The 60 Hz boost frequency is for boxes tuned from 55 to 75 Hz. The fundamental idea is to avoid overstressing the speaker by having the peak-boost frequency no more than 15% below the box tuning frequency. For convenience, current Electro-Voice models are shown in Table I. Contact Electro-Voice for information on systems that are not listed.

Table I

Model	Recommended B6 Peak-Boost Frequency	Box Tuning Frequency (for reference only)
MTS-1	60 Hz	55 Hz
S-122	60 Hz	62 Hz
S-152	43 Hz	42 Hz
S-181	43 Hz	41 Hz
S-1202ER	60 Hz	70 Hz
S-1503ER	43 Hz	44 Hz
S-1803ER	43 Hz	37 Hz
SH-1502ER	60 Hz	55 Hz
SH-1512ER	43 Hz	50 Hz
SH-1810ER	43 Hz	39 Hz
Sb120	60 Hz	55 Hz
Sx200	60 Hz	65 Hz
T22	N/A <sup>1</sup>	75 Hz
T52	60 Hz	55 Hz
T53	60 Hz	55 Hz
T18	43 Hz	39 Hz

1. B6 enhancement not recommended for T22. The highest boost frequency of 60 Hz is too low for high-level operation (more than 15% below the 75 Hz box tuning frequency).

### "Step-Down" Equalization (Thiele-Small B<sub>6</sub> alignment) of Electro-Voice TL Series Fixed Installation Sound Reinforcement and Music Playback Speaker Systems.

"Step-Down" is a good way to extend system low-frequency response by increasing amplifier power at certain frequencies instead of enclosure size. In step-down, the enclosure is tuned to a lower-than-normal frequency. This increases system output at the new tuning frequency and reduces output slightly in the region of original tuning. The smoothly falling response which results can be equalized to provide a new system 3 dB-down point that is about 0.7 that of the original. To achieve a similar response extension without equalization would require an enclosure at least twice the size.



The required equalization is a second-order undamped high-pass filter, which provides a 5 dB maximum boost at the appropriate frequency and a 12 dB-per-octave roll-off below that frequency, offering a high degree of infrasonic speaker protection. (For detailed comment on infrasonic speaker protection, see the Moderate Bass Enhancement of EV Portable Sound Reinforcement Speaker Systems section, above).

Most Electro-Voice TL series permanent-installation low-frequency systems are designed for step-down operation. The B6 peak-boost frequencies are appropriate for many TL models, as detailed in Table II. The boost frequencies differ slightly from those specifically noted in the individual TL system engineering data sheets, but the differences are of minor significance. The data sheets provide step-down instructions (usually a matter of covering one of the two enclosure vents with the supplied cover).

For the interested reader, Pro Sound Facts No. 7, available from Electro-Voice, gives more detailed comments on step-down operation. Contact Electro-Voice for information on systems that are not listed.

Table II

Model	Recommended B6 Peak-Boost Frequency	Box Tuning Frequency (for reference only)
TL12-1	43 Hz	43 Hz
TL12-1E	43 Hz	39 Hz
TL15-1	26 Hz	28 Hz
TL15-2	26 Hz	28 Hz
TL18-1	26 Hz	28 Hz
TL440	26 Hz	25 Hz
TL550D	26 Hz	25 Hz
TI880D	26 Hz	25 Hz
TL3512	26 Hz	25 Hz

**POSITION OFF** - In the OFF position, the low-frequency equalizations are switched off. This position must be selected if a signal processing unit like the **Electro-Voice Dx34** is used upstream of the power amplifier. Otherwise equalizer functions are "double-used" in the signal path.

## OUTPUT CABLE SELECTION

Speaker wire size plays an important part in quality sound systems. Small wire sizes can waste power and reduce the damping factor at the speaker terminals. This can add coloration and muddiness to the sound. To help offset this problem Tables III and IV have been assembled to enable the user to calculate the power losses in the speaker cable.

## CALCULATING POWER LOSSES

To calculate the power loss in the speaker cable, multiply the power loss per foot of the 2-wire cable using the appropriate table below by the length of the cable in feet. For example, suppose an installer uses 160 feet of 12 guage 2-wire cable with an 8  $\Omega$  speaker system connected to a 1.0 KW amplifier. The total power loss in the cable is:

$$\text{Total power Loss} = 0.1053 \text{ Watts / Ft.} \times 160 \text{ Feet} = 16.9 \text{ Watts}$$



Does this mean that whenever the amplifier produces 250 watts of output power, 233.1 Watts (250 Watts minus 16.9 Watts) will be delivered to the 8 Ω load? NO! The actual load impedance is now 8 Ω plus the resistance of the cable ( $0.00324 \Omega/\text{Ft} \times 160 \text{ Ft} + 8 \Omega = 8.52 \Omega$ ). Because of the change in the load impedance, the actual total power produced by the amplifier is 234.7 Watts. The power delivered to the load is approximately 234.7 Watts minus 16.9 Watts or 217.8 Watts.

**TABLE III**  
1.0 KW Power losses per foot in 2-wire speaker

2-wire Ω / Ft.	AWG	Ω	4 Ω (375 W) 8 Ω (750 W)	8 Ω (250 W)
0.00081	6		0.0759W	0.0253W
0.00121	8		0.1134W	0.0378W
0.00204	10		0.1913W	0.0638W
0.00324	12		0.3038W	0.1013W
0.00515	14		0.4828W	0.1609W
0.00819	16		0.7678W	0.2559W
0.01302	18		1.238W	0.4069W
0.0207	20		1.941W	0.6489W
0.0329	22		3.086W	1.0280W

\* Bridge mode

**TABLE IV**  
1.5 KW Power losses per foot in 2-wire speaker

2-wire Ω / Ft.	AWG	Ω	4 Ω (600 W) 8 Ω (1200 W)*	8 Ω (400 W)
0.00081	6		0.1215W	0.0405W
0.00121	8		0.1815W	0.0605W
0.00204	10		0.3060W	0.1020W
0.00324	12		0.4860W	0.1620W
0.00515	14		0.7725W	0.2575W
0.00819	16		1.229W	0.4095W
0.01302	18		1.953W	0.6510W
0.0207	20		3.105W	1.0350W
0.0329	22		4.938W	1.6450W

\* Bridge mode

**TABLE V**  
2.0 KW Power losses per foot in 2-wire speaker

2-wire Ω / Ft.	AWG	Ω	4 Ω (700 W) 8 Ω (1400 W)*	8 Ω (450 W)
0.00081	6		0.1418 W	0.0456 W
0.00121	8		0.2118 W	0.0681 W
0.00204	10		0.3570 W	0.1148 W
0.00324	12		0.5670 W	0.1823 W
0.00515	14		0.9016 W	0.2897 W
0.00819	16		1.433 W	0.4607 W
0.01302	18		2.279 W	0.7324 W
0.0207	20		3.623 W	1.164 W
0.0329	22		5.761 W	1.852 W

\* Bridge mode

**TABLE VI**  
Cable resistance; Ω/ft.

AWG	DCR (Ω/ft)
6	0.00081
8	0.00121
10	0.00204
12	0.00324
14	0.00515
16	0.00819
18	0.01302
20	0.02070
22	0.03292

## DAMPING FACTOR

The higher the damping factor of an amplifier, the greater the ability of the amplifier to control unwanted speaker cone movements. When a signal drives a woofer, current flowing through the voice coil creates a magnetic field. This field interacts with the permanent magnetic field in the gap and forces the combination cone and voice coil assembly to move outward. When the signal is removed, the assembly moves inward but its momentum causes it to overshoot its resting point. This overshoot will dampen itself out eventually but the unwanted movements can add considerable distortion to the sound. In the process of moving inward through the magnetic field, the voice coil assembly generates a current of opposite polarity to the original signal. This current induces a voltage or "back EMF" which travels through the speaker wire to the amplifier's output. The lower the amplifier source impedance, the faster the overshoot of the coil will dampen out. The source impedance of an amplifier can be calculated by



dividing the rated output impedance, typically 8  $\Omega$ , by the damping factor. The source impedance of the 1.0 KW, 1.5 KW and the 2.0 KW amplifiers is 0.04  $\Omega$ .

**Cable Selection for Specified Damping Factor at the Load.**

The damping factor rating of the amplifier is typically never realized at the load because of the resistance of the cable. The damping factor at the load should be 30 for general paging systems and 50 for high-fidelity music systems. Economics usually dictate however that these numbers be cut in half. The resulting damping factors at the load should be based on experience and customer

satisfaction. Once a minimum damping factor is determined for a particular type of installation, the following equation can be used to calculate the maximum length of two-wire cable which can be used to achieve the minimum damping factor specified at the load:

$$\text{Max Length} = \frac{\frac{Z_L}{DF} - Z_o}{DCR}$$

ZL = load impedance

Z<sub>o</sub> = Amplifier source impedance

DF = minimum permissible damping factor

DCR = dc resistance per foot of the 2-wire cable (Table IV)

Suppose ZL equals 8  $\Omega$ , Z<sub>o</sub> = 0.04  $\Omega$  and the minimum damping factor at the load is to be 25. In addition, 18 GA cable is preferred. Then the maximum length of cable which can be used to achieve a damping factor of 25 at the load is:

$$\text{Max Length} = ((8/25)-0.04)/0.01302 = 21.5 \text{ feet}$$



## SPEAKER PROTECTION

Sometimes it may be desirable to use in-line fuses to protect loudspeaker systems (Figure 6). It is difficult however to determine the proper fuse value with the correct time lag and overload characteristic to match the limitations of a speaker system. Fuse values are shown for the given power and load in Table VII. The values are calculated for fast-blow fuses which carry 135% of their current rating for an hour but will blow within 1 second at 200%. Other fuse values may be calculated for different power levels from the following equation:

$$\text{Fuse Value} = \frac{\sqrt{P_{out} \cdot ZL}}{ZL \cdot 1.35}$$

$P_{out}$  = rated power of amplifier  
 $ZL$  = load impedance

TABLE VII Speaker Protection Fuse Current Rating

Power (Watts)	4Ω	8Ω	16Ω
100	3.7	2.62	1.85
150	4.54	3.21	2.27
200	5.24	3.7	2.62
300	6.42	4.54	3.21
400	7.41	5.24	3.7
600	9.07	6.42	4.54

Compression drivers are much more susceptible to damage from low frequencies than large cone loudspeakers. Even though an electronic crossover may be employed, problems may arise in the cables between the crossover and the power amplifier, or from misadjustment of the crossover. Either of these situations could apply low frequency signals or hum to the driver and cause damage. To prevent a potential problem, Altec Lansing recommends using a capacitor between the amplifier and the compression driver to suppress low frequencies and possible dc. Refer to the example in Figure 7.

In choosing a value, one must be careful not to interfere with the crossover frequency. As a general rule, select a capacitor whose break frequency with respect to the load is 3dB down at approximately 1/2 of the high pass corner frequency. Mylar capacitors with at least a 100 Volt ac rating are recommended. Table VIII shows the recommended capacitor values for use with 8 and 16 Ω drivers at common crossover frequencies.

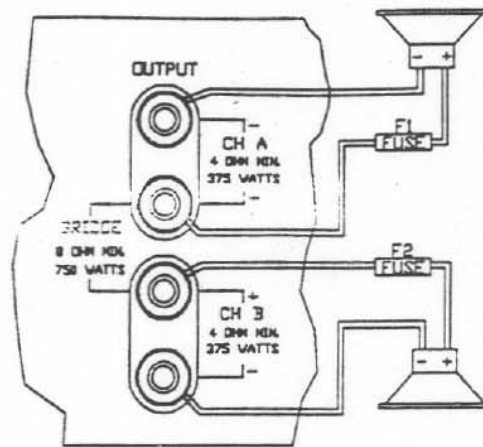

Figure 6

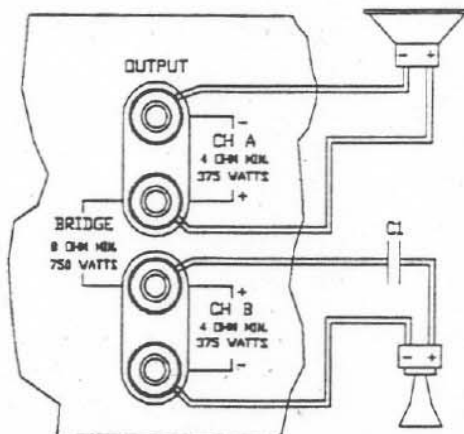

Figure 7



**TABLE VIII Protection Capacitor Sizes for Common Crossover Frequencies**

<b>Crossover Frequency</b>	<b>8Ω</b>	<b>16Ω</b>
500 Hz	80 uF	40 uF
800 Hz	50 uF	25 uF
1000 Hz	40 uF	20 uF
1250 Hz	33 uF	16 uF
2000 Hz	20 uF	10 uF
3150 Hz	12 uF	6 uF
6300 Hz	6 uF	3 uF



**PARTS LIST; 1.0KW, 1.5KW & 2.0KW - 120V & 230V**

**AUDIO AMP ASS'Y (LEFT & RIGHT)**

ALTEC PART NO.	ITEM	SPECIFICATION	QTY	REFERENCE NO.
47-03-122803	RESISTOR	10 1% 1/4W	2	R67,R68 (1.0KW)
47-03-052131	RESISTOR	12 1% 1/4W	2	R67,R68 (1.5KW)
47-03-052132	RESISTOR	22 1% 1/4W	2	R67,R68 (2.0KW)
47-01-039505	RESISTOR	39 1/4W	2	R35,R36
47-01-052133	RESISTOR	43 1/4W	1	R59
47-01-102046	RESISTOR	47 1/4W	2	R14,R15
47-03-052134	RESISTOR	62 1% 1/4W	2	R63,R65 (1.0KW)
			4	R63,R64,R65,R66 (1.5KW, 2.0KW)
47-01-102049	RESISTOR	62 1/4W	1	R60
47-03-037770	RESISTOR	100 1% 1/4W	2	R69,R70
47-01-102054	RESISTOR	100 1/4W	2	R73,R74
47-03-121532	RESISTOR	1K 1% 1/4W	3	R7,R8,R20
47-01-102102	RESISTOR	10K 1/4W	1	R19
47-01-102127	RESISTOR	100K 1/4W	3	R17,R37,R38
47-01-102104	RESISTOR	12K 1/4W	2	R27,R28
47-03-038293	RESISTOR	1.3K 1% 1/4W	2	R1,R2
47-01-102086	RESISTOR	2.2K 1/4W	2	R21,R22
47-01-102110	RESISTOR	22K 1/4W	2	R11,R16
47-03-125227U	RESISTOR	2.2K 1% 1/4W	1	R3 (1.0KW, 2.0KW)
47-03-124677	RESISTOR	2.4K 1% 1/4W	1	R3 (1.5KW)
47-01-102111	RESISTOR	24K 1/4W	2	R40,R39
47-01-102090	RESISTOR	3.3K 1/4W	1	R13
47-01-102068	RESISTOR	390 1/4W	2	R49,R50
47-01-102092	RESISTOR	3.9K 1/4W	2	R29,R30
47-01-102116	RESISTOR	39K 1/4W	3	R12,R25,R26
47-03-125226U	RESISTOR	4.7K 1% 1/4W	2	D25A,D26A
47-01-052135	RESISTOR	4.7 1/4W	2	R41,R42
47-01-102071	RESISTOR	510 1/4W	2	R45,R46
47-01-102121	RESISTOR	56K 1/4W	2	R23,R24
47-01-102074	RESISTOR	680 1/4W	2	R5,R6
47-01-102123	RESISTOR	68K 1/4W	1	R18
47-01-028534	RESISTOR	1K 0.5W	2	R75,R76
47-04-124496	RESISTOR	2.4K 0.5W	2	R71,R72
47-01-028054	RESISTOR	3.3K/0.5W	2	R43,R44
47-01-028544	RESISTOR	33K 0.5W	4	R31,R32,R33,R34
47-01-028523	RESISTOR	4.3K/0.5W	2	R47,R48
47-01-052136	M.RESISTOR	47/1W	2	R9,R10
47-01-052226	C.RESISTOR	0.1 5W (F)	2	R51,R52 (1.0KW)
			4	R51,R52,R53,R54 (1.5KW, 2.0KW)
47-04-052172	C.RESISTOR	0.1 7W(P)	2	R57,R58 (1.0KW)
47-04-052173	C.RESISTOR	0.15 10W(P)	4	R55,R56,R57,R58 (1.5KW, 2.0KW)
47-08-052174	SEMI VOL	B1K	1	SR1



Electro-Voice  
Operation Manual for the  
1.0KW, 1.5KW & 2.0KW amplifiers

15-02-052175	C.CAPACITOR	1KV 100P	2	C6,C7
15-02-052176	C.CAPACITOR	180P/1KV	2	C1,C2
15-02-052177	C.CAPACITOR	5P	3	C12,C13,C5
15-06-052178	M.CAPACITOR	M103	2	C16,C17
15-06-052179	M.CAPACITOR	M272	2	C14,C15
15-06-052180	M.CAPACITOR	M333	2	C20,C21
15-06-052181	M.CAPACITOR	M472	2	C8,C9
15-06-052137	M.F.CAPACITOR	M104 630V MF	1	C18
15-01-052138	E.CAPACITOR	25V 47UF	3	C3,C10,C11
15-01-124506	E.CAPACITOR	50V 4.7UF	1	C4
48-03-028816	TRANSISTOR	2N4401	1	Q24
48-03-027334	TRANSISTOR	2N4403	1	Q25
48-03-052140	TRANSISTOR	A1023Y	2	Q7,Q12
48-03-052141	TRANSISTOR	2SA1266 O	1	Q3
48-03-052142	TRANSISTOR	2SA1268GR	1	Q2
48-03-052143	TRANSISTOR	C1027Y	2	Q8,Q11
48-03-052144	TRANSISTOR	2SC3198"O"	1	Q4
48-03-052145	TRANSISTOR	2SC3200GR	2	Q1,Q23
48-03-052146	TRANSISTOR	2SA1695Y	1	Q10 (1.0KW)
48-03-052147	TRANSISTOR	2SA1294Y	5	Q10,Q16,Q18,Q20,Q22 (1.5KW)
			1	Q10 (2.0KW)
48-03-052148	TRANSISTOR	2SA1216Y	2	Q16,Q22 (1.0KW, 2.0KW)
			2	Q18,Q20 (2.0KW)
48-03-052149	TRANSISTOR	2SA1668Y	1	Q5
48-03-052150	TRANSISTOR	2SC4468Y	1	Q9 (1.0KW)
48-03-052151	TRANSISTOR	2SC3263Y	5	Q9,Q15,Q17,Q19,Q21 (1.5KW)
			1	Q9 (2.0KW)
48-03-052152	TRANSISTOR	2SC2922Y	2	Q15,Q21 (1.0KW, 2.0KW)
			2	Q17,Q19 (2.0KW)
48-03-052153	TRANSISTOR	2SC4382Y	1	Q6
48-03-052154	TRANSISTOR	2SA2955T	1	Q14
48-03-052155	TRANSISTOR	2SC3055T	1	Q13
48-01-052156	DIODE	1N4004	10	D7,D8,D9,D10,D11,D12,D13,D14,D15,D16
48-01-039254	DIODE	1N4148	3	D1,D17,D18
48-01-052157	Z.DIODE	6.8V/1W(1N4736A)	1	D5
48-01-028562	Z.DIODE	8.2V/1W(1N4738A)	1	D6
48-01-052159	DIODE	HER103 UPC	2	D25,D26
47-09-052160	THERMISTOR	KT5D15E 100KJ	1	TH1
48-01-052161	DIODE	FR103/FR105	7	D2,D3,D4,D19,D20,D23,D24
48-01-052162	DIODE	FR302(RG4Z)/303	2	D21,D22
21-06-052163	AUDIO PCB LEFT	ALL COMMON	1	LEFT SIDE
21-06-052164	AUDIO PCB RIGHT	ALL COMMON	1	RIGHT SIDE
28-14-052171	TR STOPPER	ALL COMMON	1	
14-05-052165	MAIN H/S LEFT	EV ALL COMMON	1	LEFT SIDE
14-05-052166	MAIN H/S RIGHT	EV ALL COMMON	1	RIGHT SIDE
28-01-052167	SCREW	SEMS M3X14	10	
28-01-052168	SCREW	SEMS M3X6	2	
28-01-052169	SCREW	SEMS M3X8	2	





28-01-052170 SCREW BIN T2 3X10 BLK 2

**MAIN CONTROL ASSY**

ALTEC PART NO.	ITEM	SPECIFICATION	QTY	REFERENCE NO.
48-01-052156	DIODE	1N4004	9	D6A,D6B,D102,D106,D107,D108,D109, D110,D111
48-01-052161	DIODE	FR103/FR105	6	D1A,D1B,D2A,D2B,D7A,D7B
48-01-039254	DIODE	1N4148	13	D1,D2,D3,D4,D3A,D3B,D4A,D4B,D101, D103,D104,D105,D118
45-01-052182	RELAY	CH11-ED24F	2	RY102,RY103
15-06-052183	X2 CAPACITOR	105/275V(BOX)	1 2	CX101 (120V) CX101,CX102 (230V)
47-01-108491	RESISTOR	1M 1/4W	4 5	R8,R101,R125,R174 (120V) R8,R101,R125,R174,RX101 (230V)
47-01-102090	RESISTOR	3.3K 1/4W	2 2 1	R8A,R8B (1.0KW) R105,R175 R6 (2.0KW)
47-01-102046	RESISTOR	47 1/4W	8	L1A,L1B,L2A,L2B,R23A,R23B,R24A, R24B
47-01-102078	RESISTOR	1K 1/4W	11 2	R5A,R5B,R7,R119,R121,R146,R151, R6A,R6B,R7A,R7B R8A,R8B (2.0KW)
47-01-102086	RESISTOR	2.2K 1/4W	15 1	R31A,R31B,R107,R122,R123,R124,R128,R129,R 136, R137,R140,R141, R147,R150,R181 R6 (1.5KW)
47-01-102127	RESISTOR	100K 1/4W	10	R10A,R10B,R112,R113,R116,R117, R127,R133,R9A,R9B
47-01-102102	RESISTOR	10K 1/4W	14	R3,R27A,R27B,R28A,R28B,R29A,R29B, R30A,R102,R104,R114,R115,R176
47-03-037770	RESISTOR	100K 1% 1/4W	2	R25A,R25B (1.0KW)
47-03-052184	RESISTOR	135K 1% 1/4W	2	R25A,R25B (1.5KW)
47-03-026892	RESISTOR	150K 1% 1/4W	2	R25A,R25B (2.0KW)
47-01-102080	RESISTOR	1.2K 1/4W	2	R32A,R32B
47-01-102094	RESISTOR	4.7K 1/4W	5 2	R9,R106,R126,R130,R131 R8A,R8B (1.5KW)
47-03-052185	RESISTOR	33K 1% 1/4W	3	R12A,R12B,R103 (1.0KW)
47-03-052186	RESISTOR	43K 1% 1/4W	3	R12A,R12B,R103 (1.5KW, 2.0KW)
47-03-052186	RESISTOR	43K 1% 1/4W	2	R134,R135
47-03-109437	RESISTOR	10K 1% 1/4W	8	R1A,R1B,R2A,R2B,R3A,R3B,R4A,R4B,
47-03-052187	RESISTOR	510 1% 1/4W	2	R11A,R11B
47-01-102119	RESISTOR	47K 1/4W	4	R9B,R11,R118,R120,R177
47-03-124669	RESISTOR	1.5K 1% 1/4W	4	R13A,R13B,R14A,R14B
47-03-052188	RESISTOR	5K 1% 1/4W	4	R15A,R15B,R16A,R16B
47-03-052189	RESISTOR	22K 1% 1/4W	1	R4
47-03-028229	RESISTOR	20K 1% 1/4W	1	R5
47-01-107043	RESISTOR	220K 1/4W	2	R1,R2 (1.0KW)
47-01-104541	RESISTOR	330K 1/4W	2	R1,R2 (1.5KW, 2.0KW)
47-01-102062	RESISTOR	220 1/4W	1	R111
47-01-102084	RESISTOR	1.8K 1/4W	1	R109
47-01-123177	RESISTOR	100 0.5W 1/4W	1	R155
47-01-102068	RESISTOR	390 1/4W	1	R12 (1.0KW)
47-01-102070	RESISTOR	470 1/4W	1	R12 (1.5KW, 2.0KW)



Electro-Voice  
Operation Manual for the  
1.0KW, 1.5KW & 2.0KW amplifiers

47-03-125225U	RESISTOR	6.8K 1% 1/4W	3	R110,R145,R152
47-01-102121	RESISTOR	56K 1/4W	2	R148,R149
47-03-052190	RESISTOR	36K 1% 1/4W	2	R144,R153
47-01-102098	RESISTOR	6.8K 1/4W	2	R179,R180
47-03-038293	RESISTOR	1.3K 1% 1/4W	1	R173
47-03-125227U	RESISTOR	2.2K 1% 1/4W	2	R138,R142
47-01-102062	RESISTOR	220 0.5W 1/4W	2	R139,R143
15-06-052191	C.A.CAPACITOR	C104(R-TYPE)	1	R132
15-02-052192	C.A.CAPACITOR	33P(R-TYPE)	22	C11A,C11B,C13A,C17A,C17B,C19A, C104,C109,C110,C113,C116,C119, C123,C141,C21A,C51A,C106,C108, C111,C124,C126,C129
15-02-052193	C.A.CAPACITOR	10P(R-TYPE)	3	C10A,C10B,C102
15-02-052194	C.A.CAPACITOR	100P(R-TYPE)	2	C7A,C7B
15-02-052195	C.A.CAPACITOR	330P(R-TYPE)	5	C2,C3A,C3B,C4A,C4B
48-01-050232	Z.DIODE	12V/1W(1N4742)	2	C6A,C6B
15-01-052196	E.CAPACITOR SMALL	16V 0.47UF 4X7	2	ZD101,ZD102
15-01-052197	E.CAPACITOR	16V 1000UF	2	C24A,C24B
15-01-052198	E.CAPACITOR	16V 470UF	6	C12A,C12B,C14A,C18A,C18B,C20A
15-01-052199	E.CAPACITOR	35V 470UF	3	C103,C125,C130
15-01-124504	E.CAPACITOR	50V 22UF(16V)	4	C16A,C22A,C127,C128
15-01-052200	E.CAPACITOR SMALL	50V 22UF 4X7	2	C1,C101
15-01-052206	E.CAPACITOR	35V 47UF	4	C1A,C1B,C2A,C2B
15-01-052201	E.CAPACITOR SMALL	50V 3.3UF 4X7	2	C9A,C9B
15-01-052206	E.CAPACITOR	50V 47UF	2	C5A,C5B
15-01-124509	E.CAPACITOR	50V 2.2UF(16V)	2	C105,C107
15-01-028691	E.CAPACITOR	50V 10UF	2	C112,C139
15-01-052202	E.CAPACITOR	16V 22UF	1	C4
15-01-028048	E.CAPACITOR	16V 100UF	2	C118,C122
15-01-052207	E.CAPACITOR	16V 47UF	2	C117,C121
47-04-052204	C.RESISTOR	1K 2W(F)	2	C115,C140
47-04-052208	C.RESISTOR	1.2K 2W(F)	2	R37A,R37B (1.0KW)
47-04-052209	C.RESISTOR	4.7 5W(F)	4	R17A,R17B,R18A,R18B (1.5KW)
47-04-052210	C.RESISTOR	680 2W(F)	2	R37A,R37B (1.5KW)
47-04-052211	C.RESISTOR	560 2W(F)	6	R17A,R17B,R18A,R18B,R37A,R37B (2.0KW)
17-01-052212	I.C	NJM072D	2	R22A,R22B
17-01-052213	I.C	NJM072DE	6	R38A,R38B,R17A,R17B,R18A,R18B (1.0KW)
47-04-052214	C.RESISTOR	4.7 2W(F)	2	R38A,R38B (2.0KW)
48-03-052215	TRANSISTOR	2SK30ATM GR	3	U1,U4A,U4B
48-03-052216	I.C	NJM7815FA	2	U1A,U1B
17-01-052217	I.C	NJM7824FA	2	R21A,R21B
17-01-052218	I.C	NJM7812FA	12	Q1,Q1A,Q1B,Q2,Q2A,Q2B,Q3,Q4,Q5, Q103,Q104,Q118
17-01-052219	I.C	NJM7915FA	2	U2A,U105
47-04-124496	RESISTOR	2.4K 0.5W	1	U101
48-03-052143	TRANSISTOR	C1027Y	1	U104
			1	U3A
			2	R19A,R20A
			2	Q101,Q119



**Electro•Voice**  
 Operation Manual for the  
 1.0KW, 1.5KW & 2.0KW amplifiers

48-03-052220	TRANSISTOR	2SC3198Y	3	Q105,Q106,Q107
45-01-052221	RELAY	RY-24WK/CY-24W	1	RY101
48-03-052222	TRANSISTOR	2SA1266Y	2	Q110,Q111
17-01-052223	I.C	NJM431L	1	U108
17-01-052224	I.C	NJM2904D	1	U103
17-01-124981	I.C	74HC32	4	U102
51-02-052225	PUSH SWITCH	JPS2254A	1	SW101
51-04-052227	FUSE	125V 13A , 65TS	1	F102 (1.0KW, 120V)
51-04-052228	FUSE	250V, 6.3A, 50CT	1	F102 (1.0KW, 230V)
51-04-052229	FUSE	250V 20A 314020	1	F102 (1.5KW, 2.0KW, 120V)
51-04-052230	FUSE	250V 10A 65TS	1	F102 (1.5KW, 230V)
51-04-052231	FUSE	250V 12A, 65TS	1	F102 (2.0KW, 230V)
51-04-052232	FUSE	125V 250MA 51S	1	F101
51-04-052233	FUSE CILP	51E	2	
51-04-052234	FUSE CLIP	61B	2	
48-03-052235	TRANSISTOR	2SA928AO(12730)	2	Q108,Q113
56-01-052236	SPRING COIL	2.2UF 8PIE	2	L3A,L3B
15-01-052237	E.CAPACITOR SMALL	16V 1UFB.P 4X7	2	
47-09-052238	THERMISTOR	10D15	1	TH101 (1.0KW)
			2	TH101,TH102 (1.5KW,2.0KW)
14-08-052239	EI TRANS BRACKET	EV ALL COMMON	1	
14-05-052240	SUB HEAT SINK D(T-1)	H 15X12X25	5	U2A,U3A,U101,U104,U105
56-01-052241	INDUCTOR COIL	14PIE X 7 X 7.5	2	L102
15-06-052242	M.CAPACITOR	M104 250V	2	C23A,C23B
56-07-052243	EI4825 (PSL1300A)	EV 120V COMMON	1	T101 (120V)
56-07-052244	EI4825(PSL1300B)	EV 230V COMMON	1	T101 (230V)
21-06-052245	MAIN PCB ALL COMMON	EV MAIN PCB	1	
28-01-052246	SCREW	BIN M3X8 BLACK	5	
56-01-052247	CORE	MP1710MDGC	1	WIRE WOUND (CON3-7 TO CON3)
56-01-052248	CORE ASSY FOR EMI	528T500/3E2A	1	(1.5KW,2.0KW) (230V) ONLY

**POWER SUPPLY - LEFT & RIGHT ASSY**

ALTEC PART NO.	ITEM	SPECIFICATION	QTY	REFERENCE NO.
15-02-052249	C.CAPACITOR	470/1KV	2	C316,C317
48-01-052250	B.DIODE	RBV1506	1	D301
48-03-052251	MOS-FET	IRFPF460	4	Q303,Q304,Q305,Q306 (1.0KW,2.0KW 120V)
48-03-052252	MOS-FET	IRFPF450	4	Q303,Q304,Q305,Q306 (1.5KW, 120V)
48-03-052253	MOS-FET	IRFPF50	4	Q303,Q304,Q305,Q306 (1.0KW,2.0KW 230V)
48-03-052254	MOS-FET	IRFPF40(2SK1539)	4	Q303,Q304,Q305,Q306 (1.5KW, 230V)
15-01-052255	E.CAPACITOR	200V 1000UF	2	C301,C302 (120V)
15-01-052256	E.CAPACITOR	350V 680UF	2	C301,C302 (230V)
15-01-052207	E.CAPACITOR	16V 47UF	2	C303,C309
15-01-124814	E.CAPACITOR	63V 470UF	2	C322,C323 124
15-01-052257	E.CAPACITOR	100V 1500UF	4	C320,C321,C324,C325 (1.0KW)
15-01-052258	E.CAPACITOR	160V 470UF	2	C320,C321 (1.5KW,2.0KW) 15-01
15-01-052259	E.CAPACITOR	160V 1500UF	2	C324,C325 (1.5KW,2.0KW)



Electro-Voice  
Operation Manual for the  
1.0KW, 1.5KW & 2.0KW amplifiers

19

15-01-052260	E.CAPACITOR	63V 1000UF	2	C326,C327
15-02-052261	C.A.CAPACITOR	C102(R-TYPE)	2	C314,C315
48-01-051016	Z.DIODE	1N5819	4	D302,D303,D304,D305
48-01-052262	DIODE	FR107	2	D310,D311
47-01-102224	RESISTOR	22 0.5W	4	R312,R313,R314,R315
47-01-102095	RESISTOR	5.1K 1/4W	2	R302,R303
47-03-051335	RESISTOR	2.94K 1% 1/4W	1	R307
47-01-052263	RESISTOR	2 1/4W	1	R305
47-01-102078	RESISTOR	1K 1/4W	2	R310,R311
47-01-052264	C.RESISTOR	22K 2W(F)	2	R316,R317 (120V)
47-01-052265	C.RESISTOR	47K 2W(F)	2	R316,R317 (230V)
47-01-052266	C.RESISTOR	33K 2W(F)	1	R301 (120V)
47-01-052267	C.RESISTOR	68K 2W(F)	1	R301 (230V)
48-01-052268	Z.DIODE	6.8V/1W(1N4736)	4	D306,D307,D308,D309
51-04-052269	FUSE R-TYPE (PICO)	125V 7A	6	F301,F302,F303,F304,F305,F306 (1.0KW)
			2	F303,F304 (1.5KW,2.0KW)
51-04-052270	FUSE R-TYPE (PICO)	125V 10A	2	F301,F302 (1.5KW,2.0KW)
48-01-052271	B.DIODE	FMU22S	1	D315
48-01-052272	B.DIODE	FMU22R	1	D313
48-01-052273	B.DIODE	FMU34S	1	D314
48-01-052274	B.DIODE	FMU34R	1	D312
56-01-052275	BEAD CORE	90001027(BFS63AAN O)	4	BD301,BD302,BD303,BD304
56-07-052276	PULSE TRANS	90001022	1	T301
56-01-052277	INDUCTOR COIL	25PIE 205	2	L301,L302
14-05-052278	SUB H/S LEFT	EV ALL COMMON	1	LEFT SIDE
14-05-052279	SUB H/S RIGHT	EV ALL COMMON	1	RIGHT SIDE
27-01-052280	OSC PCB ASSY	EV OSC COMMON	1	
15-01-028048	E.CAPACITOR	16V 100UF	1	C328
150-01-052281	E.CAPACITOR	16V 220UF	1	C304
15-01-052207	E.CAPACITOR	16V 47UF	2	C309,C303
15-01-052282	E.CAPACITORS SMALL	16V 10UFB.P 4X7	2	C311,C310
15-02-052194	C.A.CAPACITOR	100P(R-TYPE)	2	C308,C329
15-06-052283	M.CAPACITOR	M562G(J)	1	C307
15-06-052284	M.CAPACITOR	M472J	1	C306
47-01-102224	RESISTOR	22 0.5W	3	R309,R308,R313
47-01-102095	RESISTOR	5.1K 1/4W	2	R302,R303
47-01-102102	RESISTOR	10K 1/4W	1	R304
47-03-051335	RESISTOR	2.94K 1% 1/4W	1	R307
47-01-052263	RESISTOR	2 1/4W	1	R305
47-01-102078	RESISTOR	1K 1/4W	1	R10,R11
15-06-052285	M.CAPACITOR	M473J	1	C305
48-03-052222	TRANSISTOR	2SA1266Y	2	Q301,Q302
48-01-051016	Z.DIODE	1N5819	2	D302,D303
17-01-052286	I.C	3525AN	1	IC301
21-06-052287	OSC PCB	EV OSC PCB	1	
28-14-052288	PCB STOPPER	E/C OSC STOPPER	1	
56-01-052289	C.COIL(BEAD)6PIE	6 PIE W/S.TUBE	2	



**Electro-Voice**  
**Operation Manual for the**  
**1.0KW, 1.5KW & 2.0KW amplifiers**

56-07-052290	MAIN TRANS (EVT750KA)	1000W 120V	1	T302 (1.0KW, 120V)
56-07-052291	MAIN TRANS (EVT750KB)	1000W 230V	1	T302 (1.0KW, 230V)
56-07-052292	MAIN TRANS (EVT1200KA)	1500W 120V	1	T302 (1.5KW, 120V)
56-07-052293	MAIN TRANS (EVT1200KB)	1500W 230V	1	T302 (1.5KW, 230V)
56-07-052294	MAIN TRANS (EVT1400KA)	2000W 120V	1	T302 (2.0KW, 120V)
56-07-052295	MAIN TRANS (EVT1400KB)	2000W 230V	1	T302 (2.0KW, 230V)
21-06-052296	POWER LEFT PCB	EV POWER PCB	1	LEFT SIDE
21-06-052297	POWER RIGHT PCB	EV POWER PCB	1	RIGHT SIDE
28-01-052167	SCREW	SEMS M3X14	4	
28-01-052298	SCREW	SEMS M3X10	1	
28-01-052169	SCREW	BIN M3X8 BLACK	2	

**UNIT ASSY**

ALTEC PART NO.	ITEM	SPECIFICATION	QTY	REFERENCE NO.
14-08-052299	SUB H/SINK BRACKET(A)	EV ALL COMMON	2	
14-08-052300	SUB H/SINK BRACKET B	ALL COMMON	2	(2.0KW, 120V)
56-01-052311	RING CORE	19X11	3	
24-04-052301	PUSH KNOB	ABS6X12	1	
35-01-052302	FAN	AD0812HS-A70GL	2	
24-05-052303	FAN GUARD 80MM	80MM	2	
28-12-052304	CABLE TIE 4"	DACT-100	30	
14-02-052305	BOTTOM COVER	EV ALL COMMON	1	
14-02-052306	TOP COVER	EV ALL COMMON	1	
42-01-052307	FLAT PAD ALL COMMON	DW2 555X525	4	(2.0KW)
42-01-052308	FROM PAD /EV COMMON	DW2 555X525	6	(2.0KW)
42-01-052309	INNER BOX (COMMON)	DW2 567X530X145	1	(2.0KW)
42-01-052310	OUT BOX (COMMON)	DW2 582X545Z173	1	(2.0KW)
16-02-119449	SILICA-GLE ALL COM	5g	1	(2.0KW)
42-04-052312	PLOY BAG/SET	660X650	1	(2.0KW)
42-04-052313	PLOY BAG/POWER CORD	390X125	1	(2.0KW)
16-02-052314	SILICON GREASE	YG5111(TOSHIBA)	5g	(2.0KW)
31-03-109985	SRINK TUBE - 3/8"	125DGREE UL/CSA	70	(2.0KW)
16-02-052315	SILICON	K045	10g	(2.0KW)
16-02-109704	LOCKING PAINT	GREEN	3g	(2.0KW)
28-01-052316	SCREW	SEMS M3X6	9	
28-01-052169	SCREW	SEMS M3X8	11	
28-01-052317	SCREW	BIN T2 3X8 BLK	2	
28-01-052318	SCREW	BIN M4X10	8	
28-01-052319	SCREW	BIN M4X10 BLK	16	
28-01-052320	SCREW	BIN M4X14 BLK	2	
28-01-052321	SCREW	BIN M4X38 BLK	6	
28-01-052322	SCREW	FLT T2 4X10 BLK	2	
28-01-052323	SCREW	FLT M4X14 BLK	2	



28-01-052318	SCREW	BIN M4X10	8
28-01-052324	SCREW	BIN M4X44 BLK	4
28-04-052325	FLAT WASHER	4PIE	4
28-03-052326	STAR WASHER	4PIE	2
28-03-052327	SPRING WASHER	4PIE	2
28-02-052328	NUT	M4	2
14-08-052329	PCB BRACKET	ALL COMMON	2 (2.0KW)
28-01-052330	SCREW	BIN M3X8 BLK	2 120V ONLY
31-02-052331	INSULATING PAD		1 120V ONLY
31-02-052332	INSULATING CAP	15X30MM	2 120V ONLY

**FRONT PANEL ASSY**

ALTEC PART NO.	ITEM	SPECIFICATION	QTY	REFERENCE NO.
51-02-052027	POWER SWITCH	C1350ABY(L)	1	
27-01-052334	V/R PCB ASSY	E/V COMMON	1	
39-01-052335	LED	KLG114	1	LED1
39-01-052336	LED	KLR114	3	LED2,LED5,LED6
39-01-052337	LED	KLB114	1	LED4
39-01-052338	LED	KLA114	1	LED3
21-06-052339	V/R PCB	E/V V/R PCB	1	
47-06-052340	VOLUME EV ALL	VS16P3100125D20	2	VR101A,VR101B
14-07-052341	FRONT PANEL	1000W	1	(1.0KW)
14-07-052342	FRONT PANEL	1500W	1	(1.5KW)
14-07-052343	FRONT PANEL	2000W	1	(2.0KW)
28-01-052168	SCREW	SEMS M3X6	3	
24-04-052334	V/R KNOB	VOLUME KNOB EV	2	

**REAR PANEL ASSY**

ALTEC PART NO.	ITEM	SPECIFICATION	QTY	REFERENCE NO.
27-01-052345	INPUT PCB ASSY	E/V INPUT COMMO	1	
15-06-052191	C.A.CAPACITOR	C104(R-TYPE)	1	C1-1
21-06-052346	INPUT PCB ALL COMMON	E/V INPUT PCB	1	
56-01-052347	EMI FILTER	STB102KBA	4	TF1,TF2,TF1B,TF2B
21-01-052348	XLR JACK/COMBINATION	CXLF-03	2	XR1,XR1B
21-01-052349	XLR JACK	XLMN-3PH	2	XR2,XR2B
21-03-052350	SPK TML/BINDING POS	CL159705L	1	
21-03-052351	SPK TML/BINDING POS	CL159705R	1	
28-09-052352	CORD BUSHING/120V	6P3-4	1	(120V)
28-09-052353	CORD BUSHING/230V	6P-4	1	(230V)
51-04-052227	FUSE	125V 13A / 65TS	1	F2 (1.0KW, 120V)
			2	F2,F3 (2.0KW, 120V)
51-04-052354	FUSE	125V 10A / 61NM	2	F2,F3 (1.5KW, 120V)
51-04-052355	FUSE	250V 5A / 50T	2	F2,F3 (1.5KW, 230V)
51-04-052228	FUSE	250V 6.3A / 50CT	1	F2 (1.0KW, 230V)
			2	F2,F3 (2.0KW, 230V)



Electro-Voice  
Operation Manual for the  
1.0KW, 1.5KW & 2.0KW amplifiers

51-04-052356	FUSE HOLDER	R3-9A 120V 30MM	1	(120V)
51-04-052357	FUSE HOLDER	CQ206B/250V 20MM	1	(230V)
14-07-052358	REAR PANEL	EV1000W 120V	1	(1.0KW, 120V)
14-07-052359	REAR PANEL	EV1000W 230V	1	(1.0KW, 230V)
14-07-052360	REAR PANEL	EV1500W 120V	1	(1.5KW, 120V)
14-07-052361	REAR PANEL	EV1500W 230V	1	(1.5KW, 230V)
14-07-052362	REAR PANEL	EV2000W 120V	1	(2.0KW, 120V)
14-07-052363	REAR PANEL	EV2000W 230V	1	(2.0KW, 230V)
60-06-052364	POWER CORD 6FT	120V 15A 14X3	1	(120V)
60-06-052365	POWER CORD 7FT	230V 10A 1.0X3	1	(230V)
56-01-052366	EMI FILTER	PC2-F15	1	
28-01-052317	SCREW	BIN T2 3X8 BLK	4	
28-01-052330	SCREW	BIN M3X8 BLK	2	
27-01-052367	S-PROCESSOR ASS'Y	EV ALL COMMON	1	
15-01-052368	X2 CAPACITOR	MMY223/100V	6	C5,C6,C7,C105,C106,C107
15-01-052369	X2 CAPACITOR	MMY563/100V	4	C1,C2,C101,C102
15-01-052370	X2 CAPACITOR	MMY683/100V	4	C3,C4,C103,C104
15-01-052371	X2 CAPACITOR	MMY273/100V	2	C8,C108
15-01-052372	X2 CAPACITOR	MMY153/100V	2	C10,C110
15-01-052373	X2 CAPACITOR	MMY472/100V	2	C9,C109
15-02-052194	C.A.CAPACITOR	100P(R-TYPE)	4	C13,C15,C113,C115
15-02-052374	C.A.CAPACITOR	470P(R-TYPE)	4	C17,C117
47-03-052375	RESISTOR	1/8W 220 1%	4	R2,R5,R102,R105
47-03-052376	RESISTOR	1/8W 180K 1%	2	R4,R104
47-03-052377	RESISTOR	1/8W 13K 1%	2	R3,R103
47-03-051217	RESISTOR	1/8W 20K 1%	4	R6,R8,R106,R108
47-03-052378	RESISTOR	1/8W 680 1%	2	R12,R112
47-03-051220	RESISTOR	1/8W 1.4K 1%	2	R10,R110
47-03-052380	RESISTOR	1/8W 1K 1%	4	R9,R109,R111,R111
47-03-052381	RESISTOR	1/8W 100 1%	2	R7,R107
47-03-052382	RESISTOR	1/8W 33 1%	2	R13,R113
47-03-052383	RESISTOR	1/8W 1.5K 1%	2	R1,R101
47-03-052384	RESISTOR	1/8W 47K 1%	2	R18,R118
47-03-052385	RESISTOR	1/8W 24K 1%	2	R16,R116
47-03-052386	RESISTOR	1/8W 910 1%	2	R17,R117
17-01-052213	I.C	NJM072DE	4	U1-A,U1-B,U2-A,U2-B
15-01-052387	E.CAPACITOR SMALL	50V 2.2UF 4X7	6	C12,C112,C14,C16,C114,C116
51-02-052388	SWITCH	BTSR16H-13N-R20	1	S2
51-02-052389	SWITCH	BTSR16H-23N-R20	1	S1
21-06-052390	S-PROCESSOR PCB	EV ALL COMMON	1	
28-02-052391	NUT	M4 HEX	2	
28-01-052392	SCREW	PAN T2 2.3X8BLK	4	
28-01-052318	SCREW	BIN M4X10	1	
14-08-052393	S. PROC SR BRACKET	ALL COMMON	1	
28-03-052326	STAR WASHER	4PIE	2	
28-04-052325	FLAT WASHER	4PIE	2	

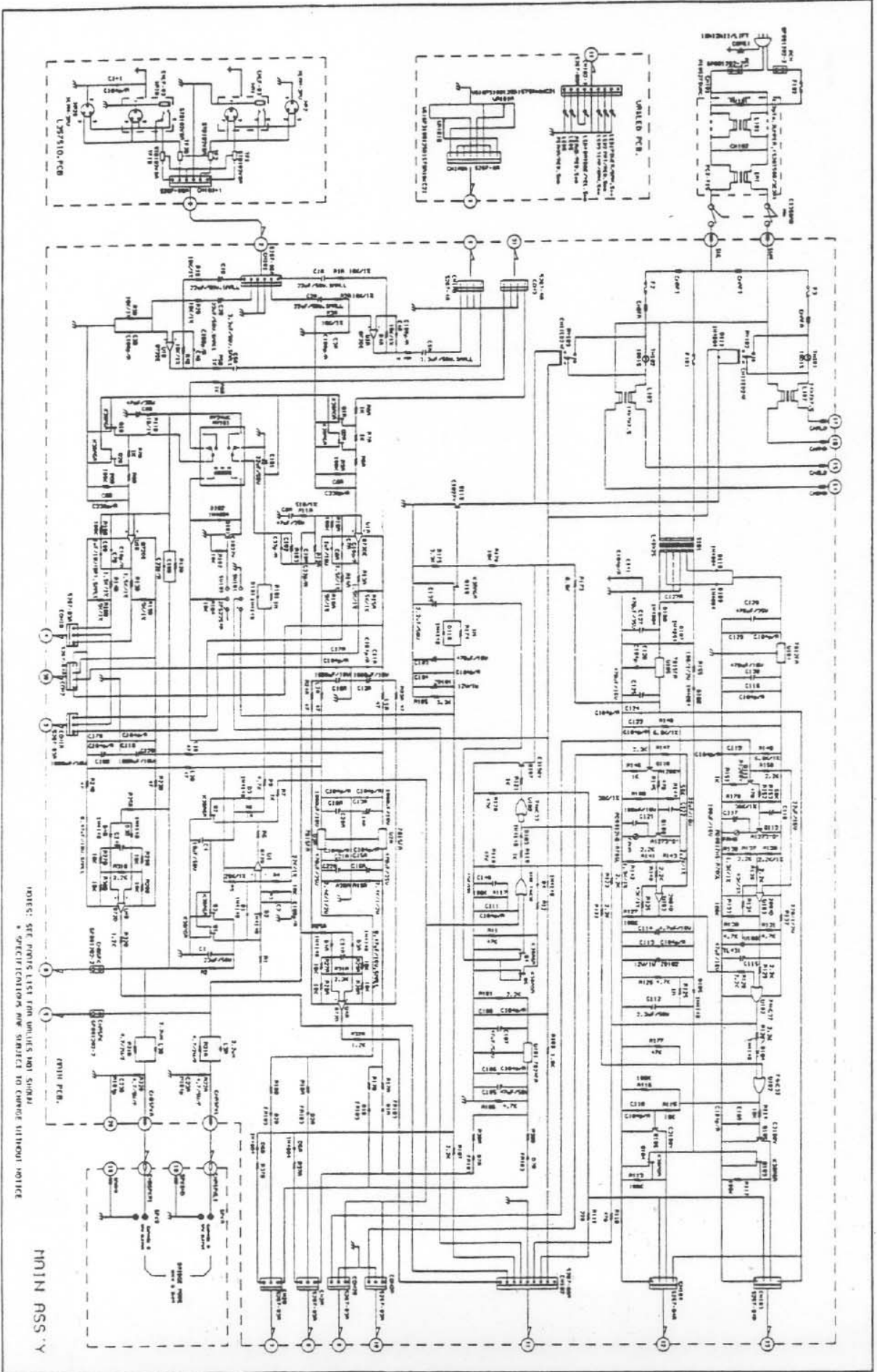

NOTE: SEE POINTS LIST FOR UNLITS NOT SHOWN  
 \* SPECIFICATIONS ARE SUBJECT TO CHANGE WITHOUT NOTICE

MAIN ASS Y



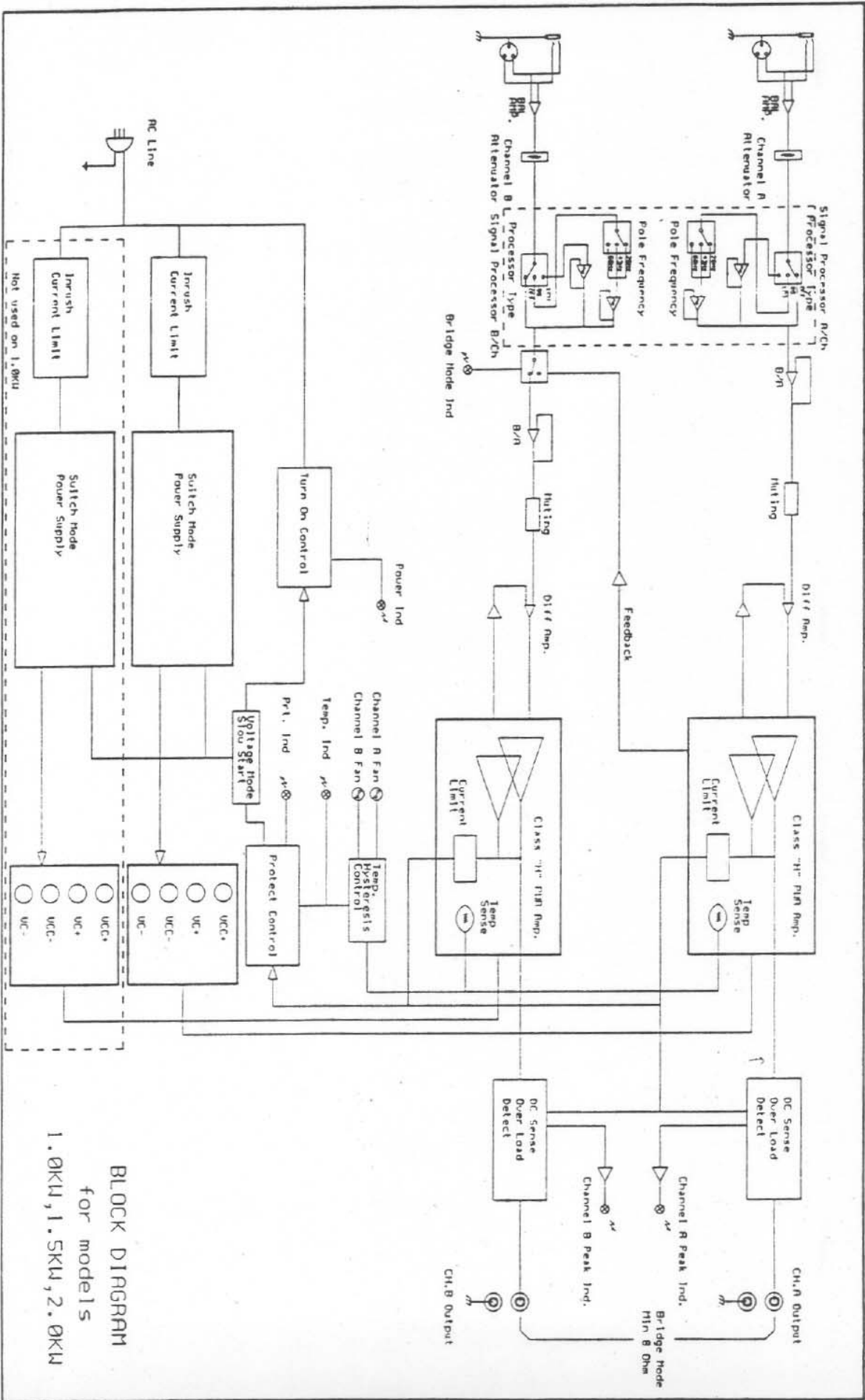

BLOCK DIAGRAM  
for models  
1.0KU, 1.5KU, 2.0KU

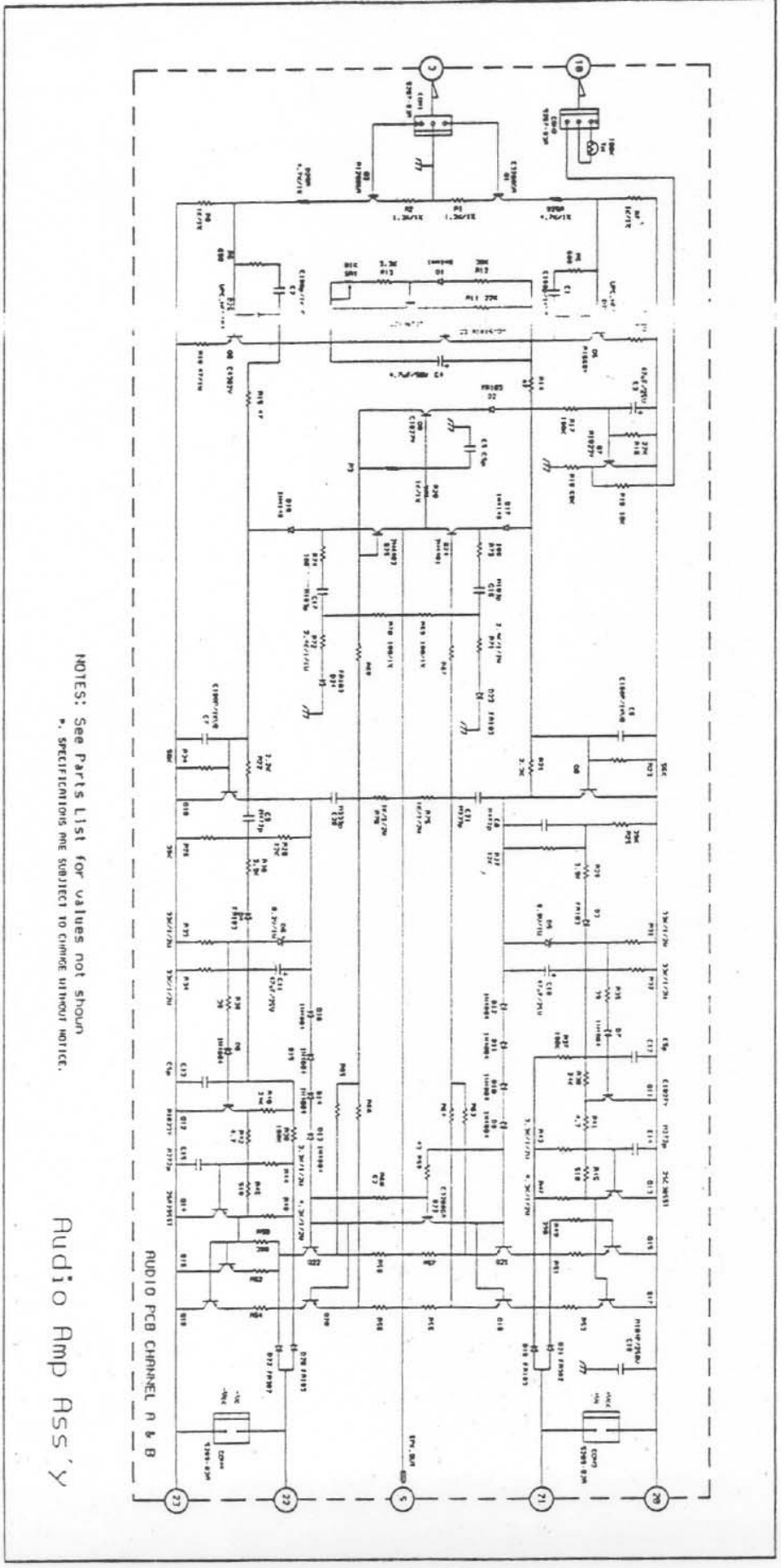

NOTES: See Parts List for values not shown.  
 \* SPECIFICATIONS ARE SUBJECT TO CHANGE WITHOUT NOTICE.

Audio Amp Ass'y

AUDIO PCB CHANNEL A & B

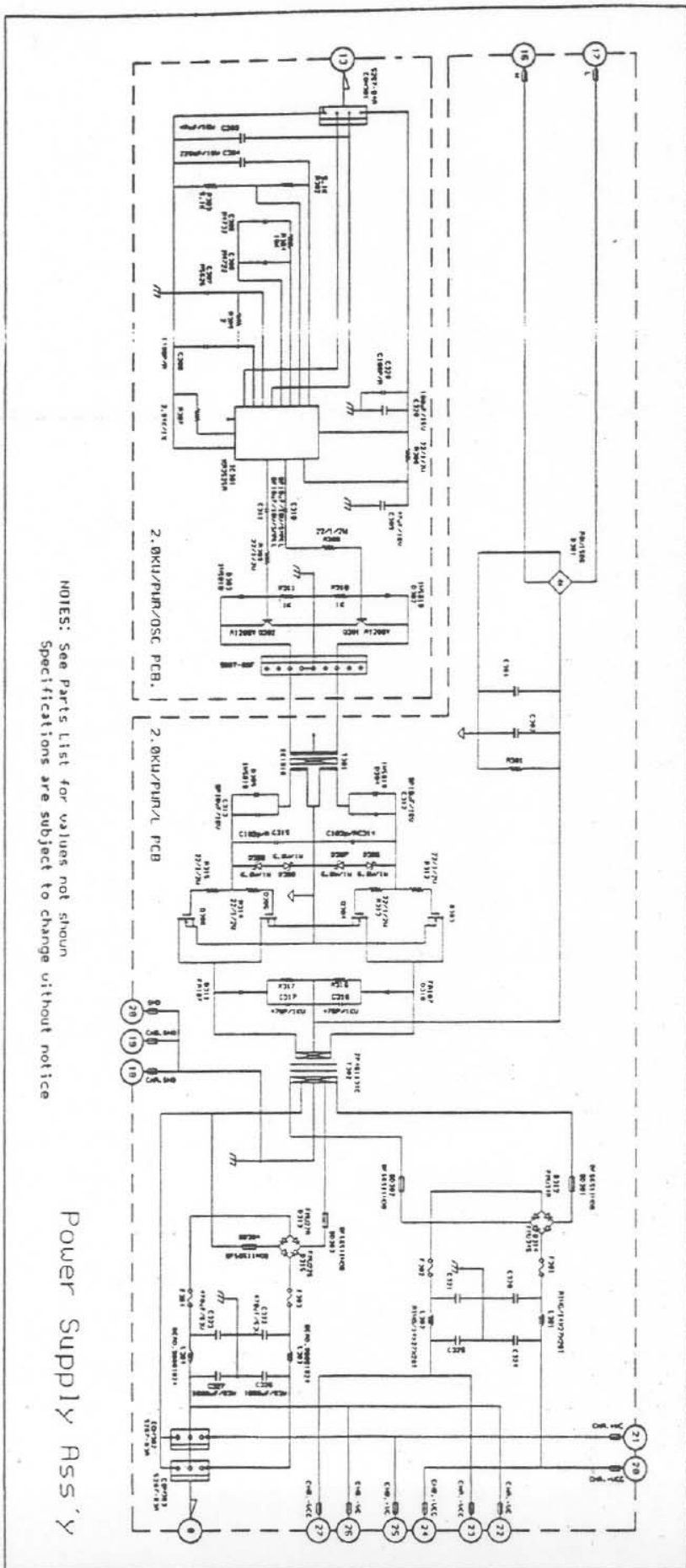

NOTES: See Parts List for values not shown  
 Specifications are subject to change without notice

Power Supply Ass'y