

ELECTRO-VOICE

ELECTRO-VOICE, INC.
BUCHANAN, MICHIGAN

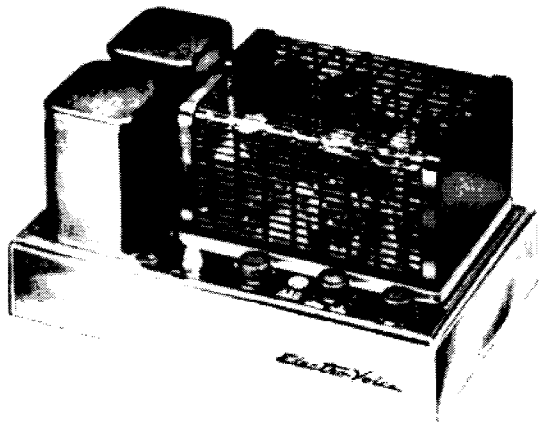

Fig. 1 — Model A30 Amplifier

Instructions

Model A30 Amplifier

30-watt Circlotron High-Fidelity Line Amplifier

GENERAL DESCRIPTION—The Electro-Voice Model A30 amplifier is a high quality 30-watt line amplifier with provision for supplying the power necessary to operate associated remote control and preamplifier equipment. Convenient plug-in connections are provided for this purpose. The polished chrome and black baked enamel finish presents an attractive appearance and provides maximum protection against corrosion.

FEATURES—No output tube DC in transformer. The Model A30 employs the new Wiggins CIRCLOTRON circuit*. DC output current is removed from the output transformer through the use of a bridge circuit. All switching transients are eliminated through unity coupling of output tubes; class AB₁ operation is effected with the resultant improvements in power output, efficiency and tube life. The primary impedance of the output transformer is one quarter of that found in conventional amplifier output circuits, affording a vast increase in power output at extremes of the frequency spectrum.

A damping factor control permits perfect coupling between the amplifier and loudspeaker system eliminating the usual loss of bass from overdamping or hangover due to underdamping. For the first time, through the use of this control, optimum operation of any speaker system is assured.

SPECIFICATIONS

Power Output:	30 watts rated, 60 watts on peaks See Fig. 2 "Maximum Undistorted Power vs. Frequency"
Frequency Response:	± 0.25 db 20 to 70,000 cps at rated output See Fig. 3 "Frequency Response"
Harmonic Distortion:	Less than 0.5% at rated output
Intermodulation Distortion:	Less than 1% at rated output See Fig. 4 "Power vs. Intermodulation Distortion"
Hum and Noise:	90 db below rated output
Speaker Output:	4 ohms, 8 ohms, 16 ohms unbalanced; 600-ohm balanced
Feedback:	Loop feedback: 16 db negative Drive plate: 2 db positive Output circuit: <u>17 db negative</u> Total: 31 db negative
Damping Factor:	Adjustable between 0.1 and 15. See table for critical damping factors of all E-V speakers.
Input Impedance:	250,000 ohms
Sensitivity:	1.25V RMS \rightarrow 11dB

Fig. 2 — Maximum Undistorted Power vs. Frequency

*Electro-Voice patents pending

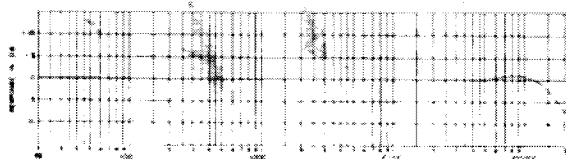

Fig. 3 — Frequency Response

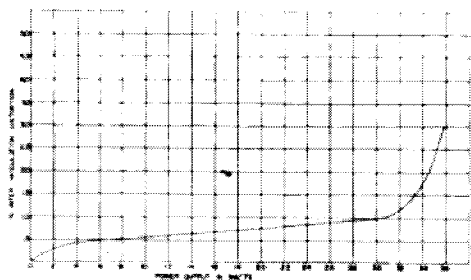

Fig. 4 — Power vs. Intermodulation Distortion

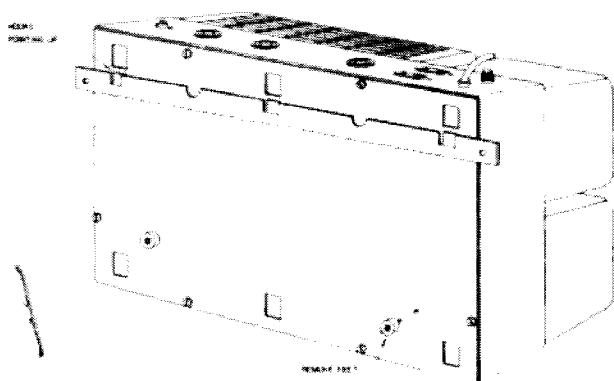

Fig. 5 — Affixing Mounting Brackets

Controls: _____

- a. Gain
- b. Damping Factor
- c. Power On-Off
- d. Hum Adjustment

Tubes:

Total of 6 as follows:

- 1 12AX7
- 1 12BH7
- 2 6BG6G
- 2 5Y3GT

Power Consumption:

117V 60 cycle AC at 1.3 amps max. Built-in power supply for Model PRC1 or PRC2 preamplifier and remote control units.

Accessory Power Available:
(for Preamp, Remote Control Units)

250V DC at 10 MA
18V DC at 150 MA
6.3V AC at 1.05 A

Size:

13½ in. wide x 8½ in. deep x 7 in. high

Weight:

22 lb net, 25 lb shipping

INSTRUCTIONS FOR SET-UP AND OPERATION

Immediately upon unpacking the amplifier carefully inspect it for physical damage. If damage is evidenced, notify the dealer from whom the unit was purchased, or the transportation company if the unit was shipped to you. Responsibility for shipping damage lies with the carrier and claim should be made for recovery.

MOUNTING—The A30 may be mounted either in an upright position or vertically, with the controls toward the top or bottom.

The amplifier is supplied with rubber feet to prevent marring of the surface on which it is placed. For mounting in a vertical position or for fixed upright mounting (See Fig. 5 "Affixing Mounting Brackets") remove these feet by extracting the screws located in the center of each rubber foot. Install one mounting bracket in the desired location on supporting wall or surface with the hooks pointing up. Install the second mounting bracket on the lower end of the bottom plate so that the hooks on mounted bracket engage the three cutouts on the bottom plate nearest the top and fasten the second mounting bracket to the supporting wall or surface. Reasonable ventilation is required, and the unit should not be operated in small, completely enclosed spaces. Brackets may also be used for permanent horizontal mounting. Under unusual conditions of very restricted ventilation, the tube and component cover may be removed to assist cooling. Special brackets are available for rack mounting; order in pairs as Part No. 72094.

PREPARATION FOR USE—Make certain that all tubes are firmly seated in the proper sockets as marked. Connect the loudspeaker or other load to the amplifier using the two black banana-type plugs supplied. Matching to any load between approximately 3 and 20 ohms may be obtained by plugging into the six-prong socket on the rear apron of the amplifier. Use the pins marked "COMMON" and either "4", "8", or "16", whichever is nearest the load impedance. Do not externally ground any portion of the output circuit. A 600-ohm balanced output is also available at this socket. When using a 600-ohm load, do not connect to the "COMMON" pin. The Electro-Voice PRC1 or PRC2 remote control ensemble is recommended for use with the A30 amplifier. Two sockets on the rear apron of the amplifier are provided to supply power to this equipment. Connect the input signal to the jack marked "SIGNAL" on the rear apron of the amplifier, using plug supplied, if desired.

CONTROLS—Three knobs and one screwdriver adjustment are located near the right front corner on top of the amplifier. The gain control adjusts the sensitivity of the amplifier to match the associated equipment.

The damping control is an Electro-Voice development designed to permit precise matching of the A30 to any existing speaker system. Consult table for correct settings for Electro-Voice speaker systems. Adjust for most pleasing sound if no data is available for other loads. For maximum damping (low internal impedance), turn knob completely clockwise. When using 600-ohm output connection, damping control must be set to full clockwise position, and does not operate on this impedance.

The power "ON-OFF-REMOTE" switch functions as the A30 "ON-OFF" switch when power control is desired at the amplifier location. The PRC units are also controlled by this switch.

For remote control of the equipment, when concealment of the amplifier is desired, turn this switch to the "OFF-REMOTE" position. This will allow the PRC preamplifier power switch to function as the master power control.

A hum balancing control is provided for use when the amplifier is used with Electro-Voice PRC1 or PRC2 remote control equipment. To adjust this hum control, remove the acorn nut by turning counterclockwise. This will expose the screwdriver slot adjustment. Adjust for minimum hum under operating conditions. Replace acorn nut. No hum adjustment is required unless the PRC units are connected.

LINE-POWER SERVICE FOR OTHER EQUIPMENT—Two line-power outputs are provided on the rear apron of the amplifier. The one marked "HOT" supplies the power whenever the amplifier is plugged in regardless of the power switch position. Such an outlet is commonly used for devices having their own on-off switch. Use of this outlet will permit a record changer to complete a change cycle before complete shutoff. The outlet marked "SWITCHED" is live only when the amplifier is turned on and may be used to control the tuner, TV set, etc. The power on-off switch should be set at "OFF-REMOTE" position when the amplifier is controlled by PRC units.

SERVICE—The 2-ampere fuse located on the rear apron of the amplifier is of the "slo-blo" 3AG type and in the event of a component failure, should be replaced with an identical 2-ampere type. The fuse will not blow in normal operation. In the event of repeated failure: (a) make certain amplifier is mounted and connected in accordance with these instructions, (b) check tubes for possible shorts and replace if necessary, or (c) refer to the dealer from whom purchased for instructions. Access to tubes may be gained by removing the two screws located on either side of the top of the protective cage. This cage may then be removed. Do not attempt to operate the amplifier without all tubes in place and plate caps connected.

CAUTION NOTES

1. Do not operate amplifier in an overloaded condition for a period of time, as this will substantially shorten the life of the output tubes.
2. Do not attempt to operate the amplifier on a power source other than 105-125V 60 cycle AC.

OPTIONAL ACCESSORIES—Model PRC1 Preamplifier and Remote Control Units. Model PRC2 Preamplifier and Remote Control Units. Rack Mounting Straps Part No. 72094.

CRITICAL DAMPING FACTOR CONTROL SETTINGS

Model	Inf. Baffle	Skylark	Baronet	Aristocrat	Regency	Georgian	Patrician	Kilpeck
SP88	1.0	2.0	2.0					
SP8C	4.0	5.0	5.0					
SP12B	2.5			4.0				
I2BW	2.5			4.0				
I2TRX	1.0			2.0				
I2TRXB	2.5			4.0				
SP12	1.0			2.0				
I2W	1.0			2.0				
I2WK								15.0
SP15	5				1.0			
I5TRX	5				1.0			
I5W	5				1.0			
I5WK						15.0		15.0
I8W	1.0							
I8WK							15.0	15.0

PARTS LIST

Key	Description	Part No.
C1	Capacitor, .1 MFD, 200 V, Plastic Tubular	4265
C2	Capacitor, 50 MMF, 500 V, Ceramic ±20%	4264
C3	Capacitor, 20 MFD, 450 V, Electrolytic	4246
C4	Capacitor, .022 MFD, 400 V, Plastic Tubular	4260
C5	Capacitor, .047 MFD, 400 V, Plastic Tubular	4243
C6	Capacitor, .047 MFD, 400 V, Plastic Tubular	4243
C7	Capacitor, .1 MFD, 600 V, Plastic Tubular	4241
C8	Capacitor, .1 MFD, 600 V, Plastic Tubular	4241
C9	Capacitor, 50 MFD, 100 V, Electrolytic	4242
C10	Capacitor, 40-40 MFD, 500 V, Electrolytic	4247
C11	Capacitor, 40-40 MFD, 500 V, Electrolytic	4247
C12	Capacitor, 500-500 MFD, 25 V, Electrolytic	4249
C13	Capacitor, .047 MFD, 400 V, Plastic Tubular	4243
C14	Capacitor, .047 MFD, 400 V, Plastic Tubular	4243
C15	Capacitor, .01 MFD, 500 V, Ceramic GMV	4252
C16	Capacitor, .01 MFD, 500 V, Ceramic GMV	4252
* R1	Potentiometer, 250K, A Taper	C4686
R2	Resistor, 270K, ½ W, Carbon, ±10%	4669
R3	Resistor, 27K, ½ W, Carbon, ±10%	4651
R4P	Potentiometer } 1 OHM, 2W } R4R } 1800 OHM, 2W } Linear	A4686
R5		
R6	Resistor, 33K, ½ W, Carbon, ±10%	4665
R7	Resistor, 470 OHM, ½ W, Carbon, ±10%	4654
R8	Resistor, 27K, ½ W, Carbon, ±10%	4651
R9	Resistor, 1.2 MEG, ½ W, Carbon, ±10%	4656
R10	Resistor, 56K, ½ W, Carbon, ±10%	4652
R11	Resistor, 56K, ½ W, Carbon, ±10%	4652
R12	Resistor, 470K, ½ W, Carbon, ±10%	4650
R13	Resistor, 470K, ½ W, Carbon, ±10%	4650
R14	Resistor, 12K, 2W, Carbon, ±10%	4679
R15	Resistor, 12K, 2W, Carbon, ±10%	4679
R16	Resistor, 1.2K, ½ W, Carbon, ±10%	4658
R17	Resistor, 47K, ½ W, Carbon, ±10%	4668
R18	Resistor, 470K, ½ W, Carbon, ±10%	4650
R19	Resistor, 470K, ½ W, Carbon, ±10%	4650
R20	Resistor, 100 OHM, 4W, W.W.	4684
R21	Resistor, 100 OHM, 4W, W.W.	4684
R22	Resistor, 39K, 2W, Carbon, ±10%	4682
R23	Resistor, 39K, 2W, Carbon, ±10%	4682
R24	Resistor, 47 OHM, 2W, Carbon, ±10%	4683
R25	Resistor, 33 OHM, ½ W, Carbon, ±10%	4681
R26	Resistor, 33 OHM, ½ W, Carbon, ±10%	4681
R27	Resistor, 220 OHM, ½ W, Carbon, ±10%	4664
* R28	Potentiometer, 200 OHM, 2W, W.W. Linear	D4686
R29	Resistor, 120 OHM, ½ W, Carbon, ±10%	4607
R30	Resistor, 120 OHM, ½ W, Carbon, ±10%	4607
V1	Tube, 12AX7	4311
V2	Tube, 12BH7	4312
V3	Tube, 6BG6	4315
V4	Tube, 6BG6	4315
V5	Tube, 5Y3GT	4314
V6	Tube, 5Y3GT	4314
* T1	Transformer, Power, 96P44	1566
* T2	Transformer, Output, 96A14B	1565
SR1	Rectifier, Selenium, 10MA, Half Wave	5914
SR2	Rectifier, Selenium, 150MA, Bridge	5915
SW1	Switch, Rotary, 5 AMP, 125V AC	5641
Fuse	3AG, 2 AMP, SLO-BLO	313002

Note: 1K = 1,000 OHMS 1 MEG = 1,000,000 OHMS

These parts are available from electronic parts dealers, excepting those marked with an asterisk (*) which may be ordered from Electro-Voice.

Schematic Diagram Model A3U Line Amplifier

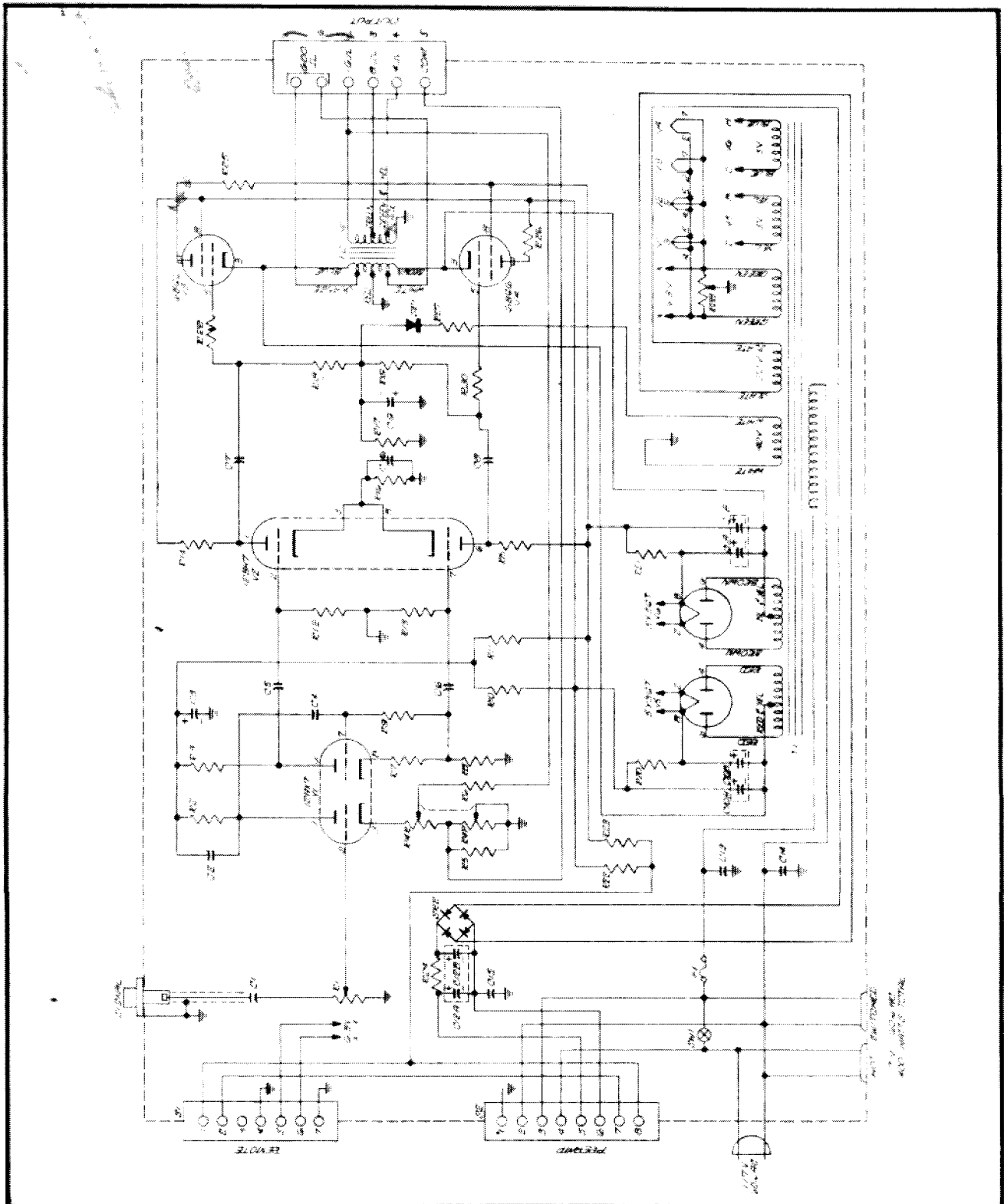

WARRANTY

The Electro-Voice Model A30 amplifier is guaranteed against defects in workmanship and material.

Ey ELECTRO-VOICE, INC. / BUCHANAN, MICHIGAN



Specifications and Instructions

Marked up copy

Model A30 Amplifier

30-watt Circlotron
High-Fidelity Power Amplifier

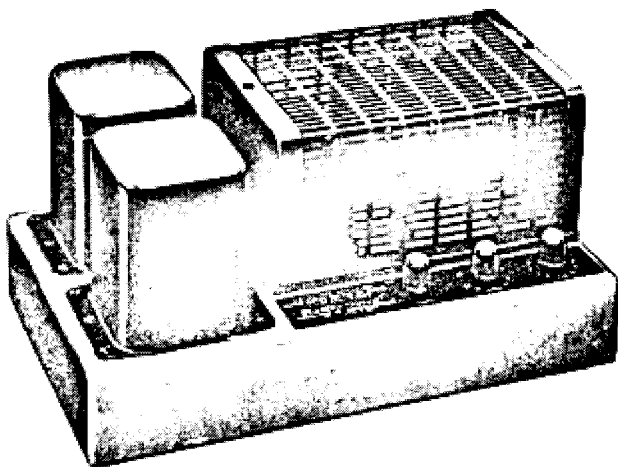

Fig. 1 — Model A30 Amplifier

GENERAL DESCRIPTION — The Electro-Voice Model A30 amplifier is a high quality 30-watt power amplifier. The brushed-brass and rich brown baked enamel finish presents an attractive appearance which will blend with contemporary room decors.

FEATURES — The Model A30 employs the new Wiggins Circlotron circuit. DC output current is removed from the output transformer through the use of a bridge circuit. All switching transients are eliminated through unity coupling between output tubes. The primary impedance of the output transformer is one quarter of that found in conventional amplifier output circuits, allowing an increase in power output at extremes of the frequency spectrum.

A damping factor control permits perfect coupling between the amplifier and loudspeaker system eliminating the usual loss of bass from overdamping or hangover due to underdamping. For the first time, through the use of this control, optimum operation of any speaker system is assured.

SPECIFICATIONS

Power Output:	30 watts rated, 60 watts on peaks See Fig. 2 "Maximum Undistorted Power vs. Frequency"
Frequency Response:	± 0.5 db 20 to 75,000 cps See Fig. 3 "Frequency Response"
Harmonic Distortion:	Less than 0.3% at rated output
Intermodulation Distortion:	Less than 0.5% at rated output See Fig. 4 "Power vs. Intermodulation Distortion"
Hum and Noise:	85 db below rated output
Speaker Output:	4 ohms, 8 ohms, 16 ohms; 70 volts balanced
Feedback:	Loop feedback: 13 db negative Drive plate: 2 db positive Output circuit: 17 db negative Total: 28 db negative
Damping factor:	Adjustable between 0.1 and 15. See table for critical damping factors of all E-V speakers.
Input Impedance:	250,000 ohms
Sensitivity:	1.25V RMS for rated output
Controls:	a. Gain b. Damping Factor c. Power On-Off
Tubes:	Total of 6 as follows: 1 12AX7 1 12BH7A 2 1614 2 5Y3GT
Power Consumption:	117V 60 cycle AC at 1.3 amps max.
Size:	13 3/4 in. wide x 9 in. deep x 7 in. high
Weight:	21 lb net, 24 lb shipping

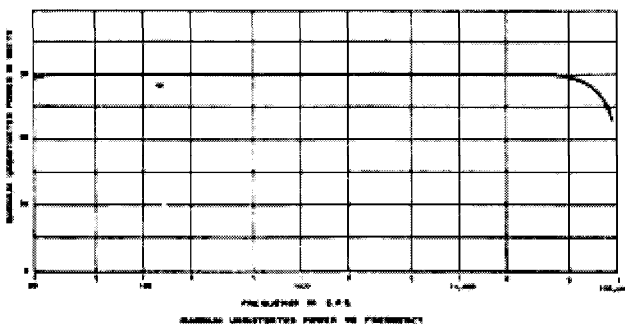

Fig. 2 — Maximum Undistorted Power vs. Frequency

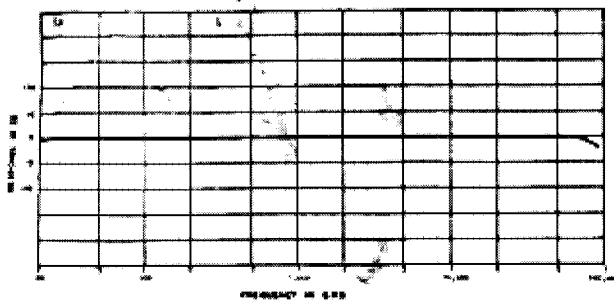

Fig. 3 — Frequency Response at 10-watt Level

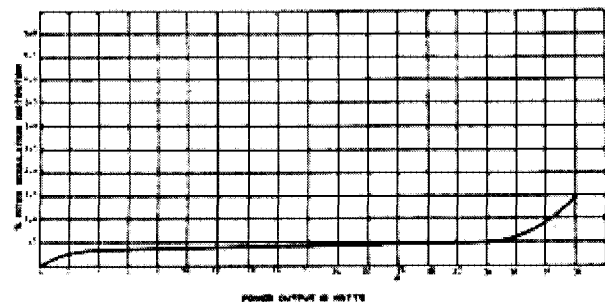

Fig. 4 — Power vs. Intermodulation Distortion

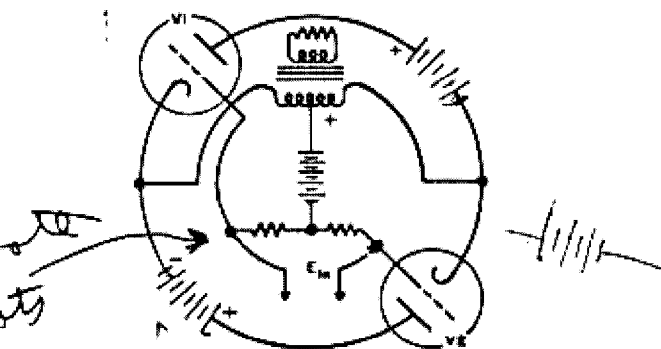

Fig. 5 — Simplified Diagram Circlotron Circuit

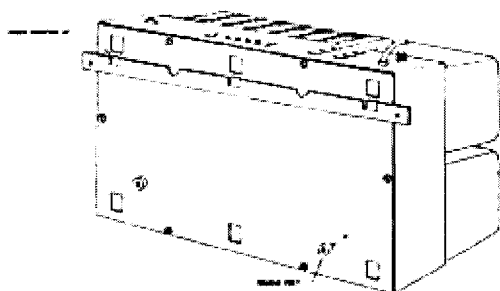

Fig. 6 — Affixing Mounting Brackets

THEORY OF OPERATION

THE OUTPUT TRANSFORMER AND CIRCUIT — One requirement of a quality high-fidelity amplifier is that it has an output transformer with negligible leakage reactance. This leakage reactance must be low to avoid the transient distortion ordinarily resulting from collapsing currents, in class AB or B operation, when either output tube is driven past cut-off. The transient distortion will appear as a parasitic oscillation in the wave form at the instant of cut-off. A high value of leakage reactance also will cause the output transformer of a conventional amplifier to lose efficiency at high frequencies. The distributed capacity of the output transformer should be very low in order to minimize high-frequency attenuation and phase shift. The Circlotron circuit configuration avoids many of the limitations imposed by the output transformer and overcomes the inherent disadvantages of conventional push-pull output circuits.

Figure 5 is a simplified version of the Wiggins Circlotron circuit. Two power supplies are used and are indicated as batteries. Each power supply is connected from the plate of one tube to the cathode of the other. The plate current of each tube circulates through both power supplies *without traversing the windings of the output transformer*. Because any pair of opposite points in this configuration is equipotential, the circuit is a balanced bridge under "no-signal" conditions.

The total primary winding of the output transformer presents a load to each of the two output tubes. One half of this load is in the cathode circuit, the other half in the plate circuit; the plate load of one tube is the cathode load of the other. Because each tube looks into the same load as the other, the result is unity coupling between the tubes. Despite the residual leakage reactance in the transformer, no switching transients can occur during the operation of the amplifier, for both halves of the transformer primary have the same signal current flowing through them. Thus, through the use of this circuit, troublesome switching transients, normally found in even high-quality amplifiers, are completely eliminated.

The impedance of the primary winding of the output transformer is one fourth that of the transformers in usual amplifiers. Therefore, the Circlotron transformer has much less distributed capacity and leakage reactance, so that a wide frequency response range is much more easily attained.

Low quiescent current in the Circlotron circuit results in higher efficiency and produces more power without exceeding the dissipation ratings of the tubes.

THE DRIVER CIRCUIT — The gain of the Circlotron output stage is almost unity, thus requiring a high drive voltage. This higher voltage is obtained by means of technique called "boot strapping". By this method the B+ supply to the driver stage is dynamically changed as signal voltage changes allowing linear operation over a much wider range.

VARIABLE DAMPING FACTOR — It is necessary for the amplifier to present the correct effective impedance to the speaker for optimum acoustic performance at low frequencies. This value of critical damping resistance varies widely with different speakers, and is dependent upon flux density, type of enclosure, length of conductor in the air gap, and to some extent, the position of the enclosure in the room. The Electro-Voice damping factor control is variable over a wide range so that an optimum match can be made between the amplifier and any speaker or system. Varying amounts of voltage and current feedback are combined to match the effective impedance while maintaining the *total* feedback at a constant value. The maximum power available from the amplifier is independent of the damping factor, remaining constant at all settings of the control.

INSTRUCTIONS FOR SET-UP AND OPERATION

Immediately upon unpacking the amplifier carefully inspect it for physical damage. If damage is evidenced, notify the dealer from whom the unit was purchased, or the transportation company if the unit was shipped to you. Responsibility for shipping damage lies with the carrier and claim should be made for recovery.

MOUNTING — The A30 may be mounted in any position. The amplifier is supplied with rubber feet to prevent marring of the surface on which it is placed. For mounting in a vertical position or for fixed upright mounting (See Fig. 6 "Affixing Mounting Brackets") remove these feet by extracting the screws located in the center of each rubber foot. Install one mounting bracket in the desired location on supporting wall or surface with the hooks pointing up. Install the second mounting bracket on the lower end of the bottom plate with the hooks facing down. Place the amplifier so that the hooks on mounted bracket engage the three cutouts on the bottom plate nearest the top and fasten the second mounting bracket to the supporting wall or surface. Reasonable ventilation is required, and the unit should not be operated in small, completely enclosed spaces. Brackets may also be used for permanent horizontal mounting. Under unusual conditions of very restricted ventilation, the tube and component cover may be removed to assist cooling.

Horizontal or vert. with low dimensions

PREPARATION FOR USE — Make certain that all tubes are firmly seated in the proper sockets as marked. Connect the loudspeaker or other load to the amplifier. Matching to any load between approximately 3 and 20 ohms may be obtained from the screw terminals on the rear apron of the amplifier. Use the terminal marked "COMMON" and either "4", "8", or "16", whichever is nearest the load impedance. *It is not permissible to connect either of the output terminals to any chassis-ground; to do so will short out the critical damping control.* If a ground connection is required it should be made directly to the chassis. Two 70-volt balanced output terminals also are provided for constant-voltage systems. *When using the 70-volt output, the damping control must be set to "15" (full clockwise position).* This places the "COMMON" terminal at chassis ground and the terminal then may be used as the balanced line center tap. The Electro-Voice PC1 or PC2 preamplifier or 3303 stereophonic tuner is recommended for use with the A30 amplifier. Connect the input signal to the jack marked "SIGNAL" on the rear apron of the amplifier.

CONTROLS — Three knobs are located near the right front corner on top of the amplifier. The gain control adjusts the sensitivity of the amplifier to match the associated equipment. The damping control is an Electro-Voice development designed to permit precise matching of the A30 to any existing speaker system. Consult the table for correct settings for Electro-Voice speaker systems. Adjust for most pleasing sound if no data is available for other loads. For maximum damping (low internal impedance), turn knob completely clockwise.

The power switch functions as the A30 "On-Off" switch when power control is desired at the amplifier location.

LINE-POWER SERVICE FOR OTHER EQUIPMENT — Two line-power outputs are provided on the rear apron of the amplifier. The one marked "HOT" supplies the power whenever the amplifier is plugged in regardless of the power switch position. Such an outlet is commonly used for devices having their own on-off switch. Use of this outlet will permit a record changer to complete a change cycle before complete shutoff. The outlet marked "SWITCHED" is live only when the amplifier is turned on and may be used to control the tuner, TV set, etc.

SERVICE — The 2-ampere fuse located on the amplifier is of the "slo-blo" 3AG type and in the event of a component failure, should be replaced with an identical 2-ampere type. The fuses will not blow in normal operation. In the event of repeated failure: (a) make certain amplifier is mounted and connected in accordance with these instructions, (b) check tubes for possible shorts and replace if necessary, or (c) refer to the dealer from whom purchased for instructions. Do not attempt to operate the amplifier without all tubes in place. In the event that the amplifier is returned to the factory for service, please include a note stating the nature of the defect.

CAUTION NOTES

1. Do not operate amplifier in an overloaded condition for a period of time, since this will substantially shorten the life of the output tubes.
2. Do not attempt to operate the amplifier from a power source other than 105-125V 60 cycle AC.
3. Do not apply power to amplifier unless *all* tubes are in sockets.
4. Do not attempt to check fuses with power on.

OPTIONAL ACCESSORIES — Model PC1 or PC2 Preamplifier or Model 3303 Stereophonic Tuner.

* CRITICAL DAMPING FACTOR CONTROL SETTINGS

Model	Let. Buffs.	Shylock	Barnet	Alibiport	Empire	Regency	Centaur	Georgian	Farman	Blipet
SPB8	1.0		2.0							
SPBC		5.0								
SP12B	2.5			4.0						
SP12	1.0			2.0						
12TRXB	2.5			4.0						
12TRX	1.0			2.0						
12BW	2.5			4.0						
12W	1.0			2.0						
12WK										10.0
SP15B	1.0				2.0	2.0				
SP15	.5				1.0	1.0				
15TRXB	1.0				2.0	2.0				
15TRX	.5				1.0	1.0				
15BW	1.0				2.0	2.0				
15W	.5				1.0	1.0				
15BWK							10.0			10.0
15WK							10.0	10.0		10.0
18W	1.0									
18WK									10.0	10.0

PARTS LIST

Key	Description	Part No.
C1	Capacitor, 0.1 MFD, 200 V, Plastic Tubular	4263
C2	Capacitor, 100 MMFD, 500 V, Ceramic	4281
C3	Capacitor, 20 MFD, 450 V, Electrolytic	4246
C4	Capacitor, 0.022 MFD, 400 V, Plastic Tubular	4260
C5	Capacitor, 0.022 MFD, 400 V, Plastic Tubular	4260
C6	Capacitor, 0.022 MFD, 400 V, Plastic Tubular	4260
C7	Capacitor, 0.1 MFD, 600 V, Plastic Tubular	4241
C8	Capacitor, 0.1 MFD, 600 V, Plastic Tubular	4241
C9	Capacitor, 50 MFD, 100 V, Electrolytic	4242
C10A	Capacitor, 40-40 MFD, 500, Electrolytic	4247
C10B		
C11A	Capacitor, 40-40 MFD, 500 V, Electrolytic	4247
C11B		
C12	Capacitor, 0.01 MFD, 500 V, Ceramic,	4257
C13	Capacitor, 0.047 MFD, 400 V, Plastic Tubular	4243
C14	Capacitor, 0.047 MFD, 400 V, Plastic Tubular	4243
R1	Potentiometer, 250K, Audio Taper, Carbon	J4686
R2	Resistor, 270K, Carbon	4669
R3	Resistor, 27K, Carbon	4651
R4P	Potentiometer, 1800 OHM—1 OHM, Dual W. W. Linear	K4686
R4P		
R5	Resistor, 33K, Carbon	4665
R6	Resistor, 470 OHM, Carbon	4654
R7	Resistor, 27K, Carbon	4651
R8	Resistor, 1.2 MEG, Carbon	4656
R9	Resistor, 56K, Carbon	4652
R10	Resistor, 56K, Carbon	4652
R11	Resistor, 470K, Carbon	4650
R12	Resistor, 470K, Carbon	4650
R13	Resistor, 12K, 2W, Carbon	4679
R14	Resistor, 12K, 2W, Carbon	4679
R15	Resistor, 1.2K, Carbon	4658
R16	Resistor, 47K, Carbon	4668
R17	Resistor, 470K, Carbon	4650
R18	Resistor, 470K, Carbon	4650
R19	Resistor, 1,000 OHM, Carbon	4693
R20	Resistor, 120 OHM, Carbon	4607
R21	Resistor, 120 OHM, Carbon	4607
R22	Resistor, 1,000 OHM, Carbon	4693
R23	Resistor, 1,000 OHM, Carbon	4693
R24	Resistor, 100 OHM, 4W, Carbon	4684
R25	Resistor, 100 OHM, 4W, Carbon	4684
R26	Resistor, 2.7 OHM, 1W, ±5%, Carbon	4680
V1	Tube, 12AX7	4311
V2	Tube, 12BH7A	431
V3	Tube, 1614	43
V4	Tube, 1614	4
V5	Tube, 5Y3GT	
V6	Tube, 5Y3GT	
BR1	Rectifier, Selenium, 10 MA, Half Wave	5
*SW1	Rotary On-Off Switch	856-
*T1	Transformer, Power	159
*T2	Transformer, Output	152
F1	Fuse, 2A, 3AG, Slo-Blo	20148

Tolerances: Capacitors ±20%, Resistors ±10% unless otherwise indicated. Resistors are ½ watt unless indicated.

Note: 1K=1,000 OHMS 1 MEG=1,000,000 OHMS

These parts are available from electronic parts dealers, excepting those marked with an asterisk(*) which may be ordered from Electro-Voice.

Schematic Diagram Model A30 Power Amplifier

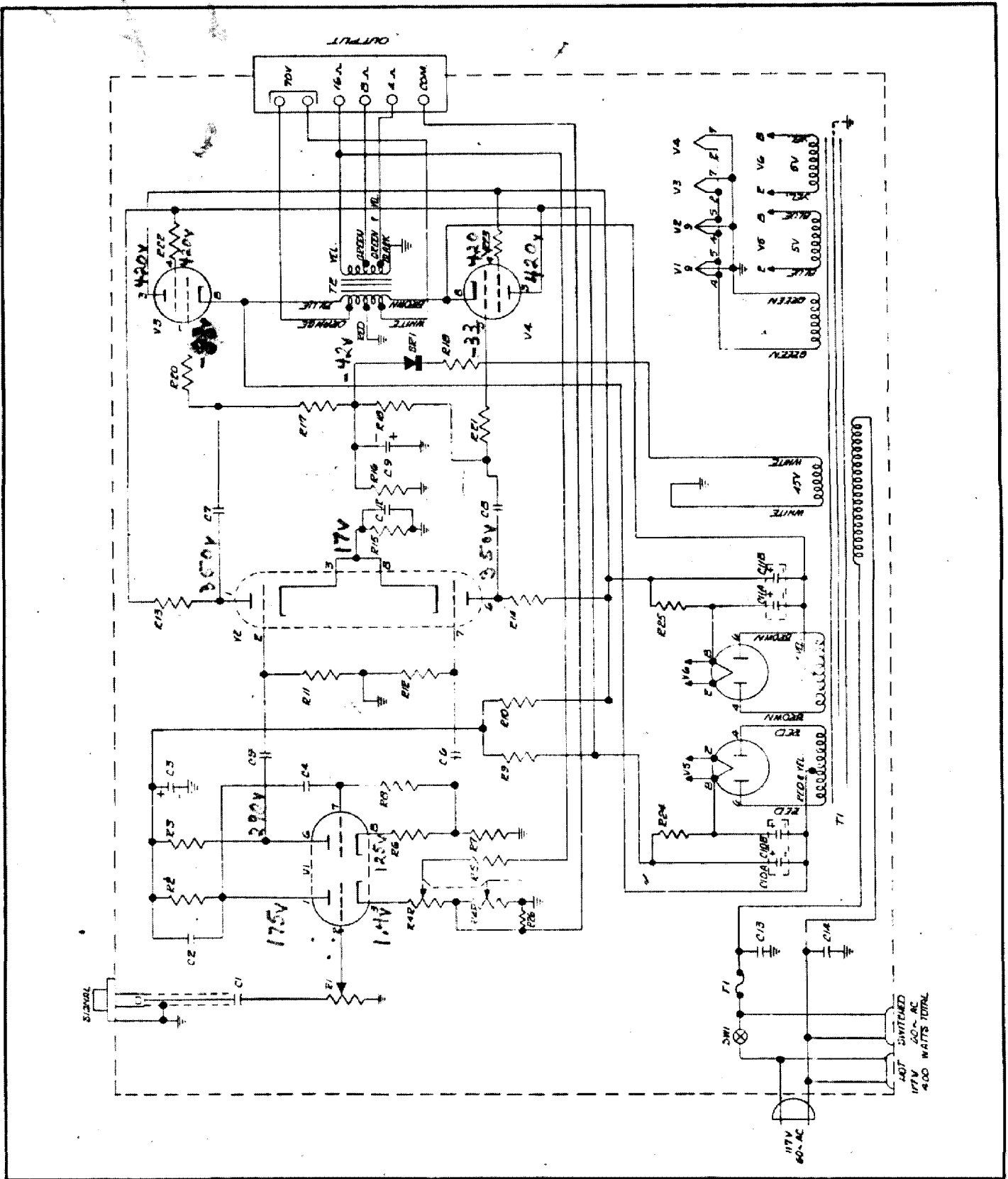

WARRANTY

The Electro-Voice Model A30 amplifier is guaranteed against defects in workmanship and material.