

Electro-Voice®
a MARK IV company

Model AP2300/SA Two-Channel Power Amplifier

SPECIFICATIONS

Conditions:

1. 0 dBu = 0.775 V rms.
2. Dual-mode ratings are for each channel.
3. Both channels operating at rated output power unless noted.
4. 120-volt ac line voltage maintained throughout testing.

Continuous Rated Output Power (20 Hz-20 kHz, 30 kHz measurement bandwidth),

Dual Mode, 4 Ohms:

150 watts at <0.10% THD

Bridge Mode, 8 Ohms:

300 watts at <0.10% THD

Dual Mode, 8 Ohms:

100 watts at <0.05% THD

Bridge Mode, 16 Ohms:

200 watts at <0.05% THD

Maximum Midband Output Power (reference 1 kHz, 1% THD),

Dual Mode, 4 Ohms:

200 watts

Bridge Mode, 8 Ohms:

400 watts

Dual Mode, 8 Ohms:

125 watts

Bridge Mode, 16 Ohms:

250 watts

Dynamic Headroom

(reference 1 kHz, 1% THD),

Any Mode:

≥ 1.0 dB

Power Bandwidth (+, -3 dB, reference 0 dB at 1 kHz, where 0 dB ref. = rated output power in any mode),

Any Mode:

10 Hz-50 kHz

Voltage Gain (reference 1 kHz),

Dual Mode, 4 or 8 Ohms:

30 dB

Bridge Mode, 8 or 16 Ohms:

36 dB

**Input Sensitivity for Rated Output Power
(reference 1 kHz),**

Dual Mode, 4 Ohms:

0 dBu (0.775 V rms)

Bridge Mode, 8 Ohms:

0 dBu (0.775 V rms)

Dual Mode, 8 Ohms:

+1.2 dBu (0.890 V rms)

Bridge Mode, 16 Ohms:

+1.2 dBu (0.890 V rms)

Maximum Input Level (reference 1 kHz):

+20 dBu (7.75 V rms)

**Input Impedance
(per channel, 20 Hz-20 kHz),**

Balanced:

> 30 kilohms

Unbalanced:

> 15 kilohms

Phase Response

(at rated output power, any mode),

at 20 Hz:

< +25 degrees

at 20 kHz:

> -25 degrees

THD (at rated output power, 30 kHz measurement bandwidth),

Any Mode:

< 0.10%

IMD [SMPTE 4:1] (at rated output power),

Any Mode:

< 0.1%

TIM [DIN 100] (at rated output power),

Any Mode:

< 0.1%

Rise Time

(10% to 90%, at rated output power),

Any Mode:

< 5 μsec

Slew Rate (at rated output power),

Dual Mode, 4 or 8 Ohms:

> 18 V/μsec

Bridge Mode, 8 or 16 Ohms:

> 36 V/μsec

Damping Factor,

Dual Mode, 8 Ohms,

20 Hz-1 kHz: > 200

20 kHz: > 80

Channel Separation (below rated output power, single channel operating):

> 75 dB at 1 kHz

Noise (below rated output power, A weighted, any mode):

> 100 dB

Amplifier Protection:

Excessive output voltage

Shorted loads

Excessive phase shift

rf interference

Over temperature

Load Protection:

Startup/shutdown transients

dc fault

Infrasonic signals

Low ac line voltage

Cooling:

Convection

Output Topology:

True complementary symmetry

Output Type,

Dual Mode: Unbalanced, each channel

Bridge Mode: Balanced

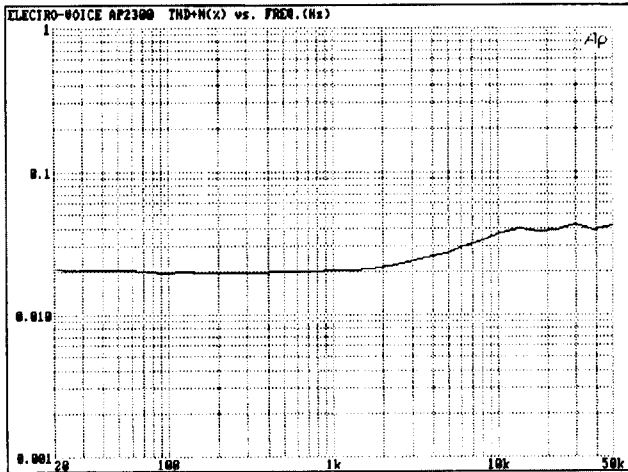

THD + NOISE VS. FREQUENCY

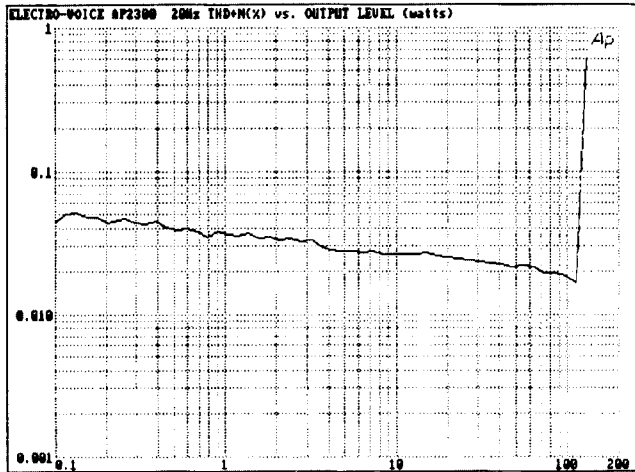

THD + NOISE VS. POWER (20 Hz)

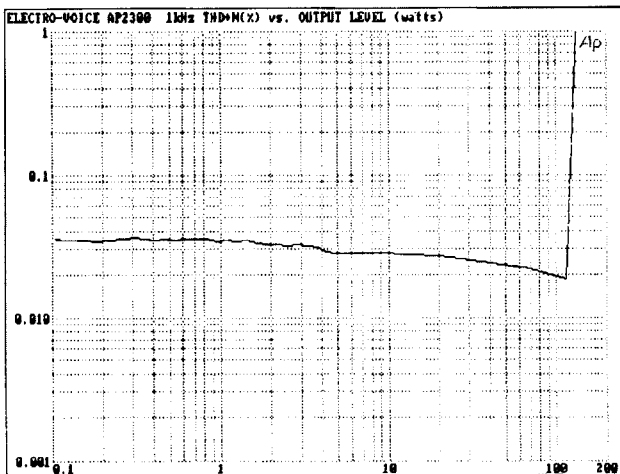

THD + NOISE VS. POWER (1 kHz)

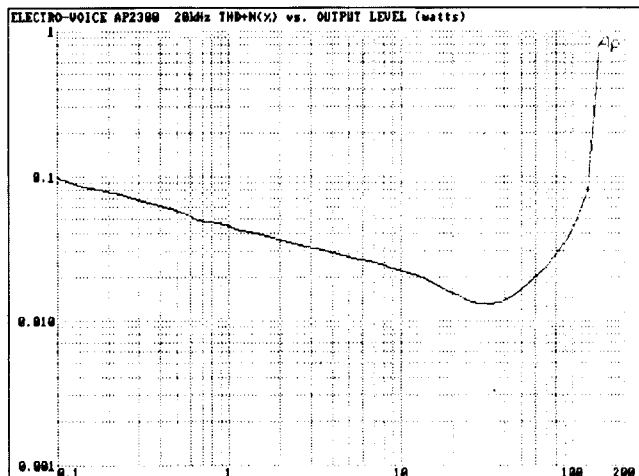

THD + NOISE VS. POWER (20 kHz)

FIGURE 1 — THD + Noise vs. Frequency/Power
(one channel operating at rated output into 8 ohms)

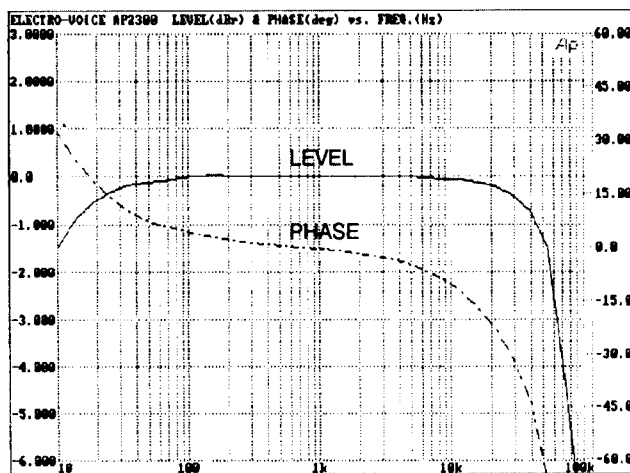

LEVEL + PHASE VS. FREQUENCY

FIGURE 2 — Level + Phase vs. Frequency
(one channel operating at rated output into 8 ohms)

Output Devices (8, both channels),

$P_{d\max}$: 150 watts
 I_c : 15 A dc
 V_{ce0} : 200 V dc
 $T_{j\max}$: 150°C (302°F)

Controls and Switches,

Input Level Controls (two)-Rear:
Continuously variable (AP2300)
Stepped attenuators (AP2300SA)
Dual/bridged mode switch-rear
Power switch-front

Front-Panel Indicators:

Power LED
Clip LED's (two)
Protect LED's (two)

Connections,

Input:
6-terminal barrier strip
Female XLR-type connectors (two)
Octal accessory sockets (two)

Output:
4-terminal barrier strip

Power:
3-terminal IEC ac line receptacle

Power Requirements:

100, 120, 200, 240 V ac,
50/60 Hz, 560 watts at 120 V ac

Power Consumption/Heat Produced (both channels operating dual mode with 1 kHz input signal at stated output power into 4 ohms, or bridge mode into 8 ohms),

$\frac{1}{3}$ Power:
560 watts/1.48 kBTU/hr

Rated Power:
750 watts/1.54 kBTU/hr

Maximum Midband Power:
850 watts/1.56 kBTU/hr

Operating Temperature Range:

Up to 60 degrees C
(140 degrees F) ambient

Dimensions,

Height: 13.3 cm (5.25 in.)
Width: 48.3 cm (19 in.)
Depth: 27.9 cm (11 in.)

Color:

Black

Enclosure:

Rack mount chassis
16-GA steel bottom/sides
18-GA steel top/back
 $\frac{3}{16}$ -inch 6061-T6 aluminum front panel

Shipping Weight:

16.3 kg (36 lb)

Net Weight:

14.5 kg (32 lb)

Supplied Items:

One owner's manual
One detachable power cord
Four "U" jumper plugs for octal sockets

Optional Accessories:

The octal sockets permit a variety of plug-in accessories to be used with the amplifier. The options are listed below.

APM-1 Bridging Input transformer
APM-2 Bridging Input transformer with pad
APL-125 low pass module, 125 Hz
APL-500 low pass module, 500 Hz
APL-800 low pass module, 800 Hz

APL-1250 low pass module, 1250 Hz
APH-125 high pass module, 125 Hz
APH-315 high pass module, 315 Hz
APH-500 high pass module, 500 Hz
APH-800 high pass module, 800 Hz
APH-1250 high pass module, 1250 Hz
APX two-way crossover module,
24 dB/octave, freq. selectable
50 Hz-10 kHz.

APX-2 crossover module, as APX with separate high-pass output for other amplifiers

CX1 two-way crossover module, 24 dB octave, switch-selectable high-frequency attenuation and 500 or 800 Hz crossover, resistive selectable other crossover frequencies, and choice of modules for horn EQ and low-frequency time delay

Four output impedance matching devices are available.

TR150 150-watt 70-volt line transformer
TR300 300-watt 70-volt line transformer
AT-300 300-watt multi-tap auto-transformer
AT-100 100-watt multi-tap auto-transformer

INSTALLATION

Unpacking

Upon receipt of the unit, inspect the shipping carton for possible damage during transit. If damage is found, notify the transportation company immediately. Should damage occur during shipping, it is the responsibility of the consignee to initiate a claim with the carrier.

*** CAUTION ***

No user serviceable parts inside. Hazardous voltage and currents may be encountered within the chassis. The service information contained within this document is for use only by Electro-Voice, Inc., authorized warranty stations and qualified service personnel. To avoid electric shock, do not perform any servicing unless you are qualified to do so.

DESCRIPTION

The AP2300 and AP2300SA are dual-channel power amplifiers for professional sound reinforcement.

The **AP2300SA** features stepped attenuators that are calibrated in 1-dB steps from 0 to 20 dB attenuation, 2-dB steps from 20 to 30 dB attenuation and 3-dB steps for attenuation beyond 30 dB. The **AP2300** uses continuously variable attenuators. The two units are identical in all other respects.

Each channel delivers 100 watts of continuous average power into 8 ohms or 150 watts into 4 ohms over full audio frequency range. In the bridge mode, the amplifier can deliver more than 300 watts at less than 0.10% THD.

Each channel is independently protected against . . .

- Over temperature
- Excessive output voltage
- Excessive phase shift
- Radio-frequency interference
- Shorted loads

The load is protected from startup/shutdown transients, infrasonic signals, low ac line voltage, and dc. When a problem is

detected, an output relay automatically disconnects the load from the channel and illuminates the Protect LED located on the front panel.

The AP2300 has electronically balanced inputs and accessory sockets for plug-in transformers and electronic modules. The level controls are rear mounted to avoid accidental changes. The universal power transformer permits 100-, 120-, 200-, 220-, and 240-V 50/60 Hz ac operation. The Electro-Voice AP2300 power amplifier is the choice for serious professional installations which demand the highest quality at high power levels for extended periods of time.

ARCHITECTS' AND ENGINEERS' SPECIFICATIONS

The power amplifier shall be a dual-channel model of solid-state design employing true complementary-symmetry output circuitry and capable of operating from a 100/120/200/220/240-V, 50/60-Hz ac line. The amplifier shall contain sensing circuitry to provide protection for the output transistors against over temperature, excessive output voltage, radio-frequency interference, shorted loads, and excessive output phase shift. The load shall be similarly protected against infrasonic signals, startup/shutdown transients, low ac line voltage, and dc.

Rear-mounted panel controls shall include a two-position mode switch for selecting between the dual monophonic mode or the bridged monophonic mode, and individual input level controls.* Input connections for each channel shall include an octal socket for use with an optional plug-in input bridging transformer or electronic accessory modules, a 3-pin female XLR-type connector, and a barrier-strip connector. Output terminals shall be a barrier-strip connector.

Front panel indicators shall include an illuminated power on/off indicator, individually illuminated clipping indicators (Clip), and individually illuminated protection-circuit-activation indicators (Protect). The front panel control shall be the power on/off switch.

The power amplifier shall meet the following performance criteria. Maximum input voltage: 7.75 V rms. Input voltage for rated output power into 4 ohms: 0.775 rms. Rated output power channel: 150 watts into 4 ohms from 20 Hz to 20 kHz at less than 0.10% THD; 100 watts into 8 ohms from 20 Hz to 20 kHz at less than 0.05% THD; 300 watts into 8-ohm bridged load from 20 Hz to 20 kHz at less than 0.10% THD with channel #1 driven. Voltage amplification in dual mode: 30 dB. Hum and noise: at least 100 dB (A weighted) below rated output power. Frequency response: 20 Hz to 20 kHz, ± 1 dB at any output power up to rated output power. Damping factor: greater than 200 at any frequency up to 1 kHz in dual mode with 8-ohm load.

*The AP2300SA version shall have calibrated stepped attenuators for input level control

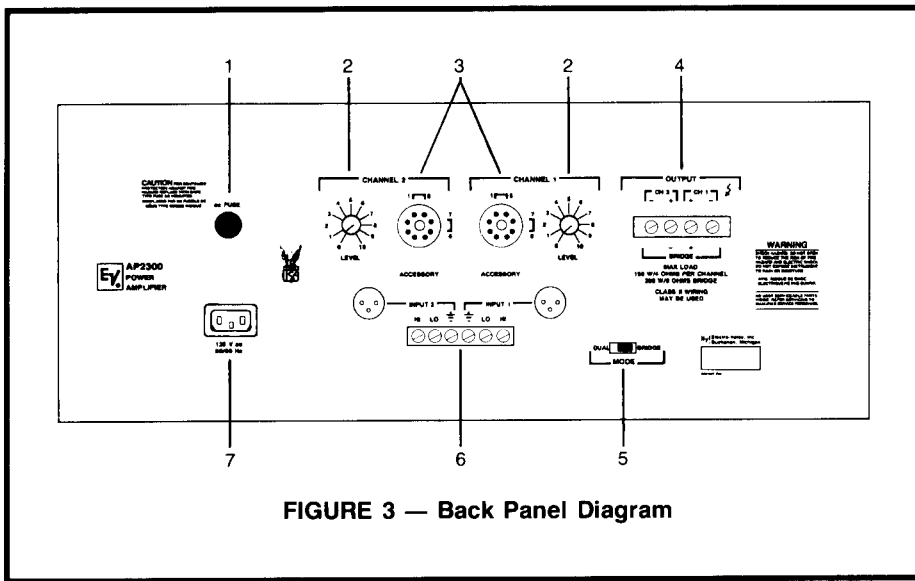

FIGURE 3 — Back Panel Diagram

1. **AC FUSE RECEPTACLE:** This holder requires either a 5-A, 250-V Normal-Blo fuse (for 100/120-V ac operation), or a 2.5-A Normal-Blo fuse (for 200/220/240-V ac operation).
2. **INPUT ATTENUATORS:** These controls adjust the input levels for both channels.
3. **ACCESSORY SOCKETS:** These octal sockets allow the use of several accessories. See the SPECIFICATIONS section for a listing of all compatible accessories.
4. **CHANNEL OUTPUT CONNECTIONS:** This terminal strip is for speaker connections, either in the dual or bridge mode.
5. **MODE SWITCH:** This switch enables either the dual or bridge mode of operation.
6. **CHANNEL INPUT CONNECTIONS:** Differential input connections can be made to either the terminal strip or the XLR-type connectors.
7. **POWER CORD RECEPTACLE:** This receptacle is for the supplied three-prong male power cord.

Transient intermodulation distortion (DIN 100): less than 0.1% in dual mode into 8 ohms. Intermodulation distortion (SMPTE): less than 0.1% in dual mode into 8 ohms. Crosstalk: more than 75 dB below rated output power. Operating temperature range: up to 60 degrees C (140 degrees F) ambient. Dimensions: 5.25"Hx19"Wx 11"D. Net weight: 32 pounds. Color: black. Enclosure: rack mounted chassis; 16GA steel bottom/sides; 18GA steel top/back; 3/16" 6061-T6 aluminum front panel.

The power amplifier shall be the Electro-Voice AP2300/AP2300SA.

WARRANTY (Limited)

Electro-Voice Professional Sound Reinforcement Electronic Components are guaranteed for two years from date of original purchase against malfunction due to defects in workmanship and materials. If such malfunction occurs, unit will be repaired or replaced (at our option) without charge for materials or labor if delivered prepaid to the proper Electro-Voice service facility. Unit will be returned prepaid. Warranty does not extend to finish, appearance items or malfunction due to abuse or operation under other than specified conditions, nor does it extend to incidental or consequential damages. Some states do not allow the exclusion or limitation of incidental or consequential damages, so the above exclusion may not apply to you. Repair by other than Electro-Voice or its authorized service agencies will void this guarantee. A list of authorized service centers is available from Electro-Voice, Inc., 600 Cecil Street, Buchanan, MI 49107 (AC/616-695-6831); Electro-Voice West, 8234 Doe Avenue, Visalia, CA 93291 (AC/209-651-7777) and/or Electro-Voice, 10500 West Reno, Oklahoma City, OK 73125 (AC/405-324-5311). This warranty gives you specific legal rights, and you may also have other rights which vary from state to state.

Service and repair address for this product: Electro-Voice, Inc., 10500 West Reno, Oklahoma City, OK 73125.

Specifications subject to change without notice.



ELECTRO-VOICE, INC., 600 Cecil Street, Buchanan, Michigan 49107

MANUFACTURING PLANTS AT ■ BUCHANAN, MI ■ NEWPORT, TN ■ SEVIERVILLE, TN ■ GANANOQUE, ONT
 © Electro-Voice, Inc. 1989 ■ Litho In U.S.A. Form 2950

a MARK IV company



Electro-Voice®
POWER AMPLIFIERS

OWNER'S MANUAL

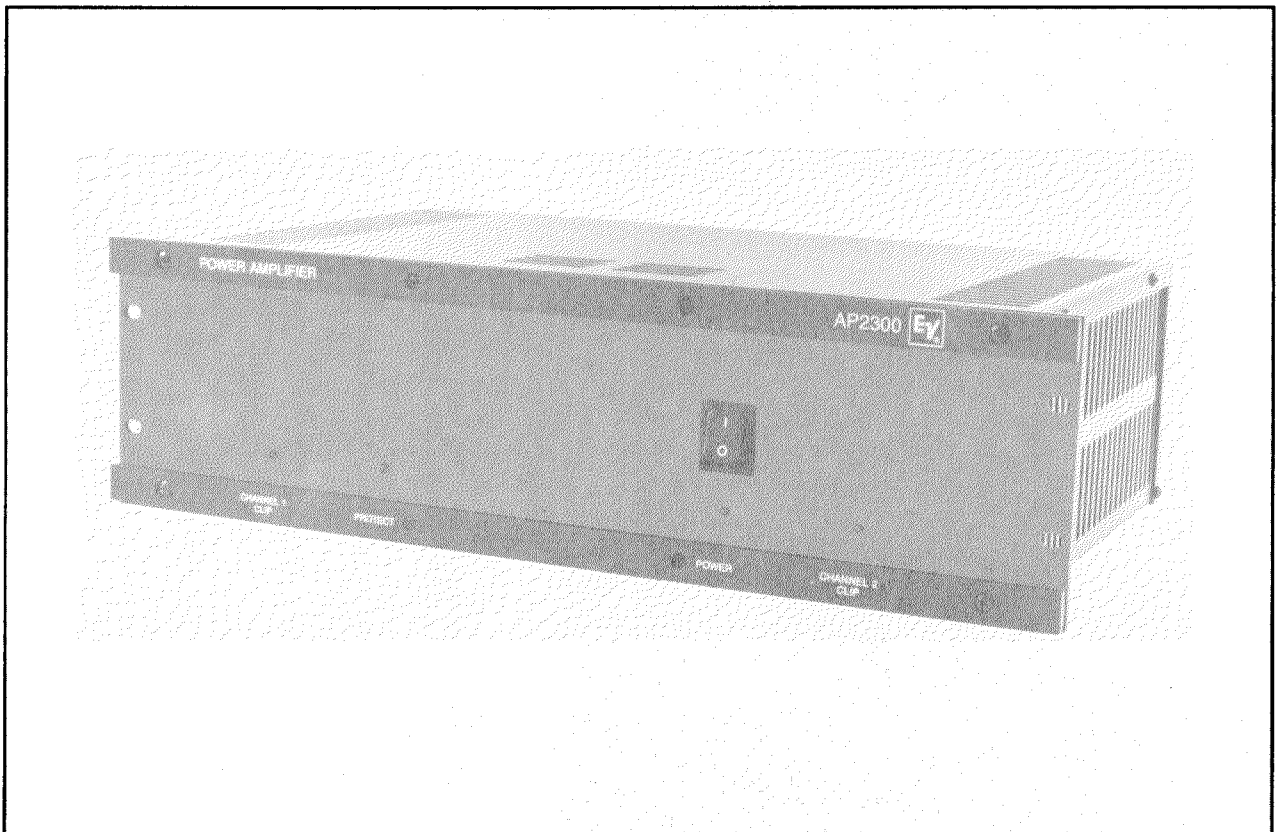

AP2300 POWER AMPLIFIER

**AP2300SA POWER AMPLIFIER
WITH STEPPED ATTENUATORS**

TABLE OF CONTENTS

FEATURES AND DESCRIPTION	1
SPECIFICATIONS	2
OPERATION	7
Front Panel Indicators.....	7
Back Panel Connections and Controls.....	8
INSTALLATION	9
Amplifier Input Connections.....	9
Auxiliary Line Output Connections.....	9
Speaker Output Connections.....	9
Speaker Protection Fuse Selection.....	10
Compression Driver Protection.....	11
Modes of Operation.....	11
Primary Voltage.....	12
Alternate Primary Voltage.....	12
Mounting.....	13
Cooling.....	13
Final Instructions.....	13
SCHEMATIC DIAGRAMS	14
SERVICE/WARRANTY INFORMATION	16
Shipping Damage.....	16
Factory Service.....	16
Warranty.....	16

WARNING: TO REDUCE THE RISK OF FIRE OR ELECTRIC SHOCK, DO NOT EXPOSE THIS EQUIPMENT TO RAIN OR MOISTURE.

FEATURES

- The amplifier's two channels can operate independently of each other, or may be bridged into an 8-ohm load.
- Differential inputs can be made to either an XLR-type connector or a terminal barrier strip.
- Octal sockets permit a variety of plug-in accessories to be used with the amplifier.
- Front panel LED's show when the power is on, the output signal is clipping, and the amplifier is in the protection mode.
- Input levels are controlled independently for each channel.
- Primary voltage may be configured to run on 100, 120, 200, 220 or 240 volts.
- Stepped input attenuators (AP2300SA) and continuously variable attenuators (AP2300) are available.
- Convection cooling is used for quiet operation.
- Inputs are electronically balanced (optional APM-1 plug-in transformer available).
- Level controls are located on the back panel to prevent "accidental" changes.

DESCRIPTION

The AP2300 is a dual-channel power amplifier for professional sound reinforcement.

The AP2300SA features stepped attenuators that are calibrated in 1-dB steps from 0 to 20 dB attenuation, 2-dB steps from 20 to 30 dB attenuation and 3-dB steps for attenuation beyond 30 dB. The AP2300 uses continuously variable attenuators. The two units are identical in all other respects.

Each channel can deliver 100 watts of power into an 8-ohm load or 150 watts into a 4-ohm load over the full audio frequency range. In bridge mode, the amplifier will deliver more than 300 watts into an 8-ohm load at less than 0.10% THD.

Input attenuators are located on the rear panel. Clip and protect LED indicators are located on the front panel. Efficient heat sinking and self-contained forced-air cooling enhance the reliability of the unit.

Each channel is independently protected against

- Overtemperature
- Excessive output voltage
- Excessive phase shift
- Radio-frequency interference
- Shorted loads

The load is protected from turn-on and turn-off transients, infrasonic signals, low ac line voltage and dc. When a problem is detected, an output relay automatically disconnects the load from the amplifier's output and activates the protect LED on the front panel.

SPECIFICATIONS

CONDITIONS

1. 0 dBu = 0.775 V rms.
2. Dual-mode ratings are for each channel.
3. Both channels operating at rated output power unless noted.
4. 120-volt ac line voltage maintained throughout testing.

CONTINUOUS RATED OUTPUT POWER (20 Hz-20 kHz at less than 0.1% THD, 30-kHz measurement bandwidth)

- Dual Mode, 4 Ω : 150 watts/channel
- Bridge Mode, 8 Ω : 300 watts
- Dual Mode, 8 Ω : 100 watts/channel
- Bridge Mode, 16 Ω : 200 watts

MAXIMUM MIDBAND OUTPUT POWER (1 kHz, 1% THD)

- Dual Mode, 4 Ω : 200 watts/channel
- Bridge Mode, 8 Ω : 400 watts
- Dual Mode, 8 Ω : 125 watts
- Bridge Mode, 16 Ω : 250 watts

DYNAMIC HEADROOM (1 kHz, 1% THD, any mode)
 ≥ 1 dB**POWER BANDWIDTH** (1 kHz, +0/-3 dB where 0 dB = rated output power in any mode)

10 Hz - 50 kHz

VOLTAGE GAIN REFERENCE (1 kHz)

- Dual Mode, 4 or 8 Ω : 30 dB
- Bridge Mode, 8 or 16 Ω : 36 dB

INPUT SENSITIVITY FOR RATED OUTPUT POWER (1 kHz)

- Dual Mode, 4 Ω : 0 dBu (0.775 V rms)
- Bridge Mode, 8 Ω : 0 dBu (0.775 V rms)
- Dual Mode, 8 Ω : +1.2 dBu (0.890 V rms)
- Bridge Mode, 16 Ω : +1.2 dBu (0.890 V rms)

MAXIMUM INPUT LEVEL (1 kHz)
+20 dBu (7.75 V rms)**INPUT IMPEDANCE** (1 kHz)

- Balanced: 15 $k\Omega$
- Unbalanced: 15 $k\Omega$ (non-inverting input)

PHASE RESPONSE (at rated output power, any mode)

- 20 Hz: $< +25^\circ$
- 20 kHz: $> -25^\circ$

THD (any mode, 30 kHz measurement bandwidth)
 $< 0.1\%$ **IMD** (SMPTE 4:1, any mode)
 $< 0.1\%$ **TIM** (DIM 100, any mode)
 $< 0.1\%$ **RISE TIME** (10% to 90%, any mode)
 $< 5 \mu\text{sec}$ **SLEW RATE**

- Dual Mode, 4 or 8 Ω : $> 18 \text{ V}/\mu\text{sec}$
- Bridge Mode, 8 or 16 Ω : $> 36 \text{ V}/\mu\text{sec}$

DAMPING FACTOR (dual Mode, 8 Ω)
20 Hz - 1 kHz: > 200
20 kHz: > 80 **CROSSTALK** (1 kHz, 0 dB = rated output power into 8 Ω , single channel operating)
 > 75 dB**NOISE** (below rated output power, A-weighting filter, any mode, 50/60-Hz line frequency)
 > 100 dB**AMPLIFIER PROTECTION**

- Excessive output voltage
- Shorted outputs
- Excessive phase shift
- Radio-frequency interference
- Overtemperature

LOAD PROTECTION

- Startup/shutdown transients
- dc faults
- Infrasonic signals
- Low ac line voltage

COOLING

- Convection

OUTPUT TOPOLOGY

- True complementary symmetry

OUTPUT TYPE

- Dual Mode: Unbalanced, each channel
- Bridge Mode: Balanced

OUTPUT DEVICES

- Total number: 8 devices (both channels)
- $P_{d\text{max}}$ rating: 150 watts
- V_{ceo} : 200 volts dc
- I_c : 15 A dc
- $T_{j\text{max}}$: 150 $^\circ\text{C}$ (302 $^\circ\text{F}$)

SPECIFICATIONS

CONTROLS AND SWITCHES

Two continuously variable input attenuators (AP2300) or two stepped attenuators (AP2300SA), rear
 Bridge mode switch, rear
 Power switch, front

STEPPED ATTENUATOR STEP SIZES

(AP2300SA only, from full clockwise position)

Click Position

1 - 20:	1-dB steps (20 dB attenuation at 20)
20 - 25:	2-dB steps (30 dB attenuation at 25)
25 - 26:	3-dB step (33 dB attenuation at 26)
26 - 27:	4-dB step (37 dB attenuation at 27)
27 - 28:	4-dB step (41 dB attenuation at 28)
28 - 29:	4-dB step (45 dB attenuation at 29)
29 - 30:	5-dB step (50 dB attenuation at 30)
30 - 31:	off ($-\infty$ at 31)

FRONT-PANEL INDICATORS

Power LED
 Clip LED's (two), one per channel
 Protect LED

CONNECTIONS

Input: 6-terminal barrier strip, female XLR-type connectors (two), octal accessory sockets (two), with ± 15 volts dc power
 Output: 4-terminal barrier strip
 Power: 3-terminal IEC ac line receptacle

POWER REQUIREMENTS

100, 120, 200, 220, 240 V ac, 50/60 Hz, 560 watts (at 120 V ac)

POWER CONSUMPTION/HEAT PRODUCED

(both channels operating in dual mode with 1 kHz input signal at stated output power into 4 Ω loads)

One-Third Midband Power: 560 watts/1.48 kBTU/hr
 Rated Power: 750 watts/1.54 kBTU/hr
 Maximum Midband Power: 850 watts/1.56 kBTU/hr

OPERATING TEMPERATURE RANGE

Up to 60 °C (140 °F) ambient

DIMENSIONS

Height: 13.3 cm (5-1/4 in.)
 Width: 48.3 cm (19 in.)
 Depth: 27.9 cm (11 in.)

COLOR

Black

ENCLOSURE

Rack-mount chassis, 16-GA steel bottom/sides, 18-gauge steel top/back, 3/16-inch 6061-T6 aluminum front panel

SHIPPING WEIGHT

21.8 kg (48 lb)

NET WEIGHT

17.7 kg (39 lb)

SUPPLIED ITEMS

Four "U" jumper plugs for octal sockets (two per socket installed)
 One owner's manual
 One detachable power cord with three-prong male plug

OPTIONAL INPUT ACCESSORIES

Model	Description
APM-1	15-k Ω bridging input transformer with fixed pad options
APL-125	3rd-order Butterworth (18 dB per octave) low-pass filters at indicated corner frequencies
APL-500	
APL-800	
APL-1250	
APH-125	3rd-order Butterworth (18 dB per octave) high-pass filters at indicated corner frequencies
APH-315	
APH-500	
APH-800	
APH-1250	
APX	4th-order Linkwitz-Riley (24 dB per octave) crossover filter with 24 switch-selectable frequencies on ISO 1/3-octave centers from 50 Hz to 10kHz

OPTIONAL OUTPUT ACCESSORIES

Model	Description
AT100	100-watt autoformer with 4-, 8-, 16-, 50-, 70.7- and 100- Ω taps
AT300	300-watt autoformer with 2.67-, 4-, 5.33-, 8- and 16- Ω taps
TR150	150-watt, 70.7-volt transformer
TR300	300-watt, 70.7-volt transformer

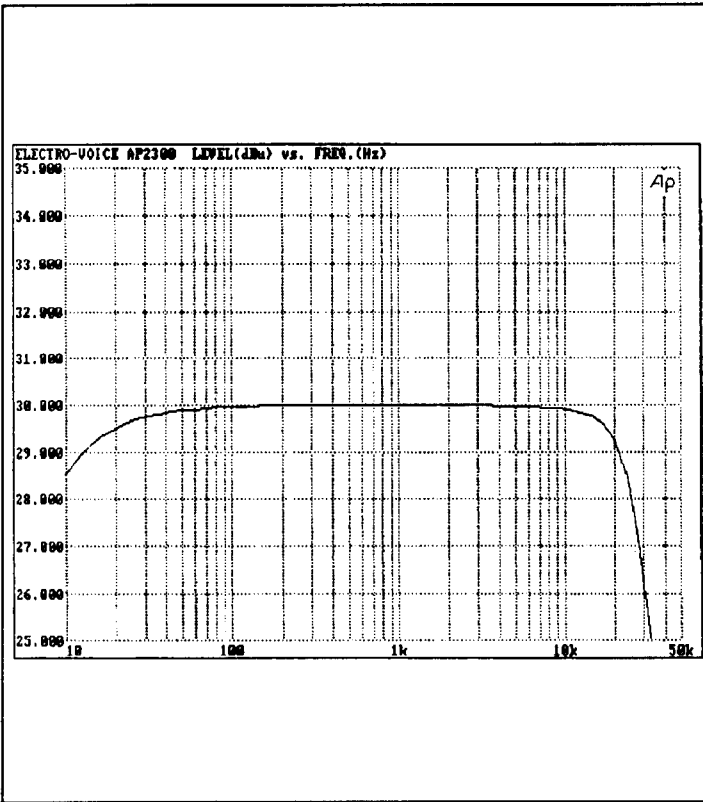

LEVEL VS. FREQUENCY

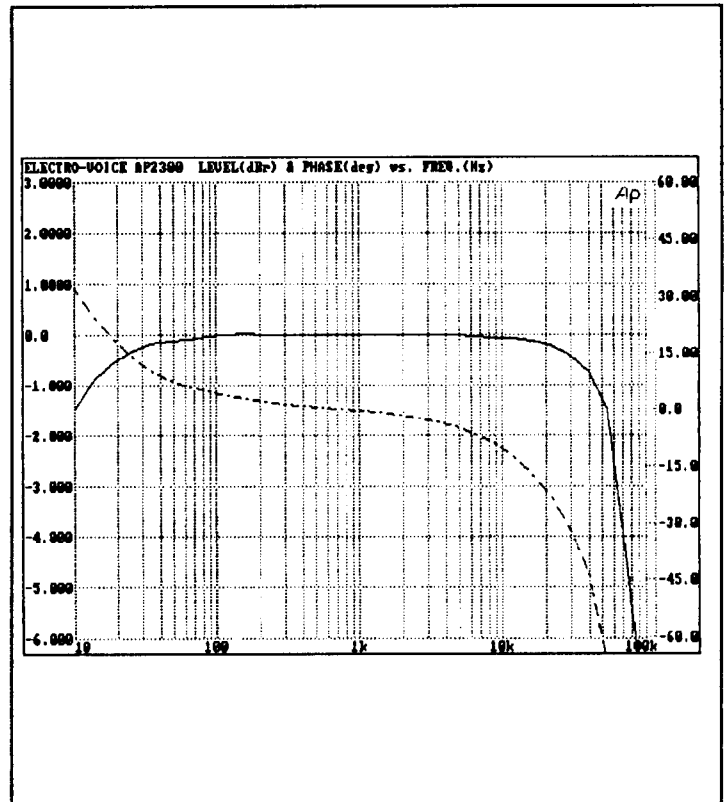

LEVEL + PHASE VS. FREQUENCY

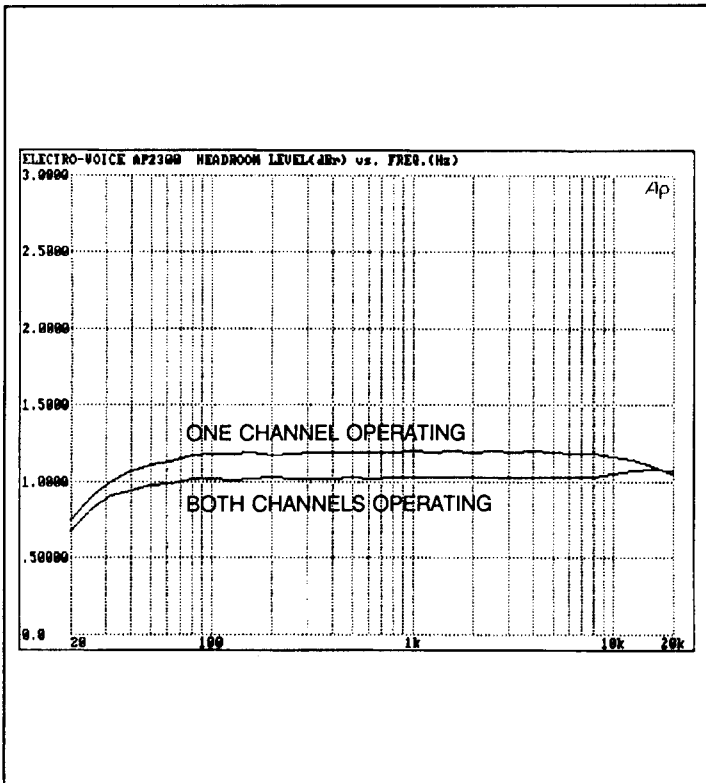

HEADROOM VS. FREQUENCY

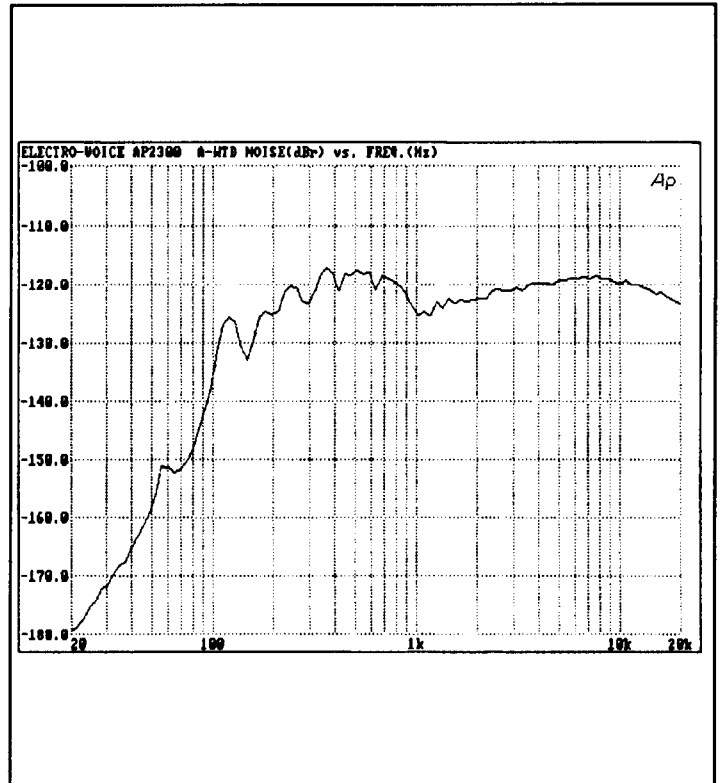

NOISE VS. FREQUENCY

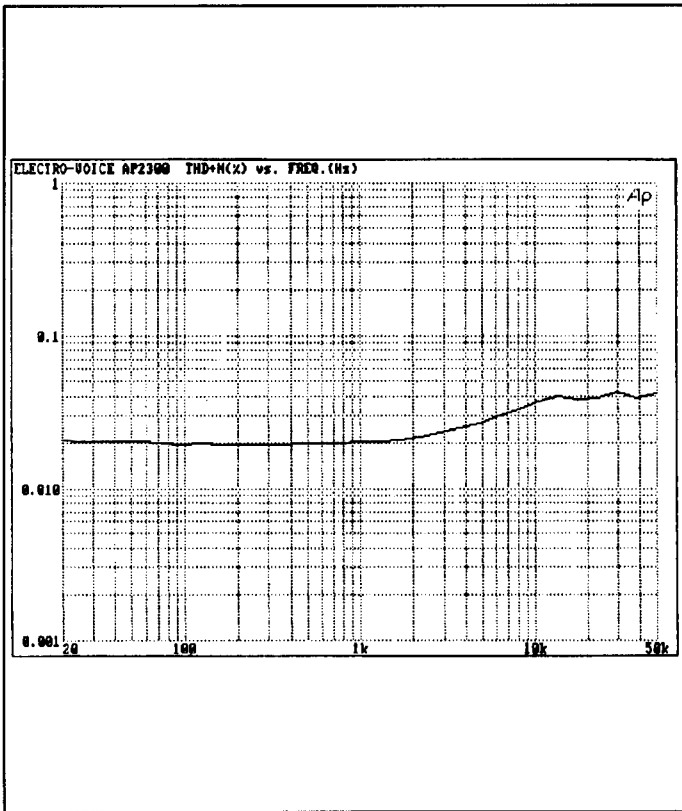

THD + NOISE VS. FREQUENCY

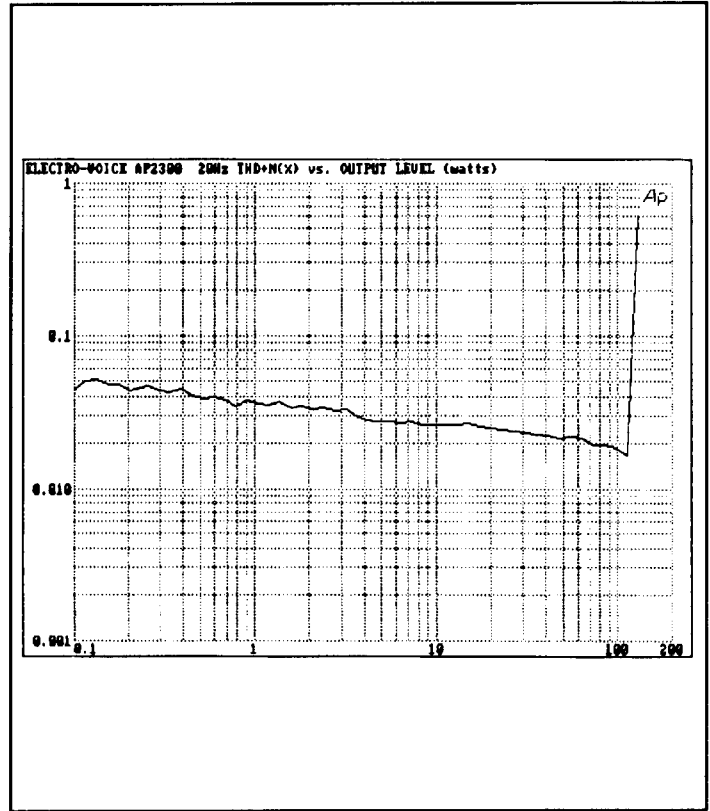

THD + NOISE VS. POWER (20 Hz)

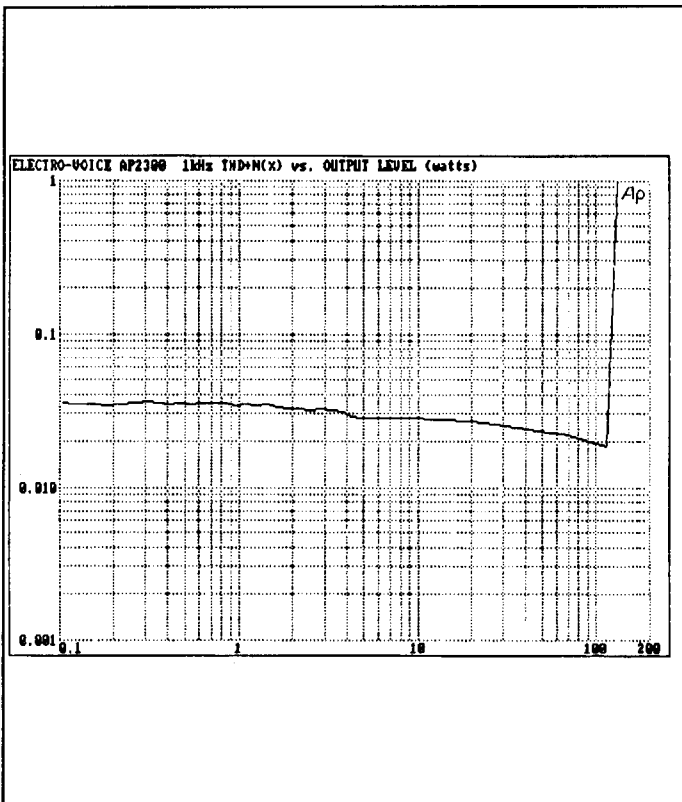

THD + NOISE VS. POWER (1 kHz)

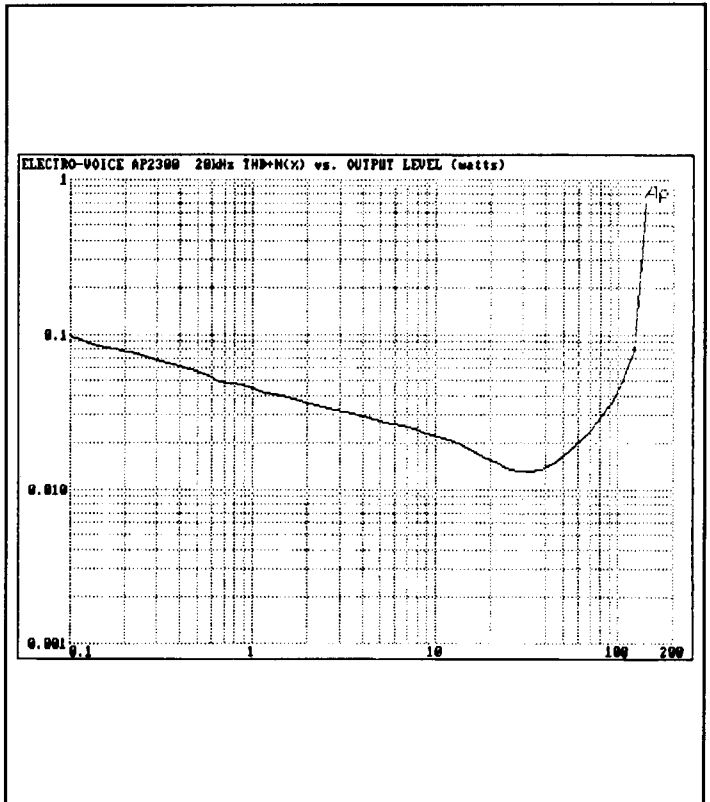

THD + NOISE VS. POWER (20 kHz)

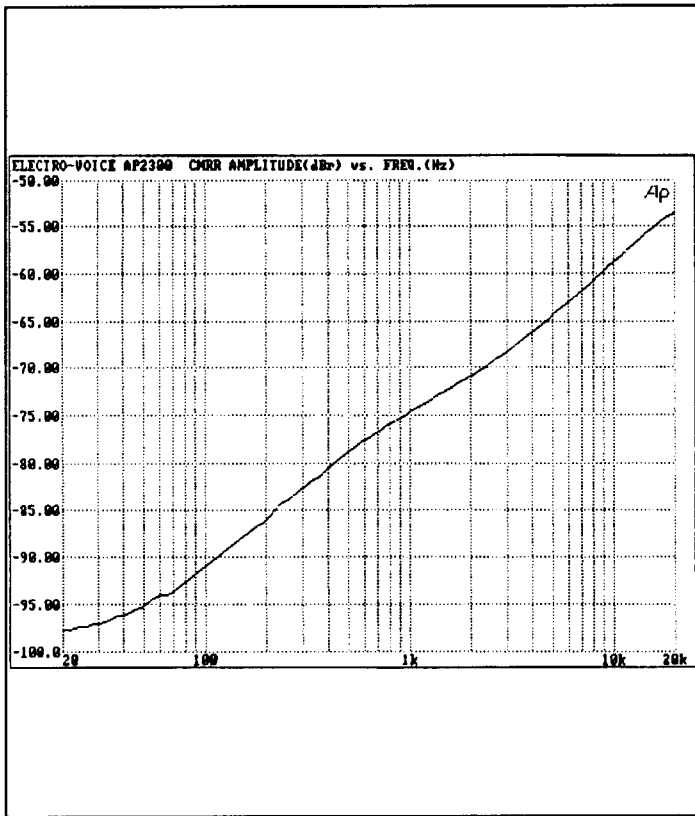

CMRR VS. FREQUENCY

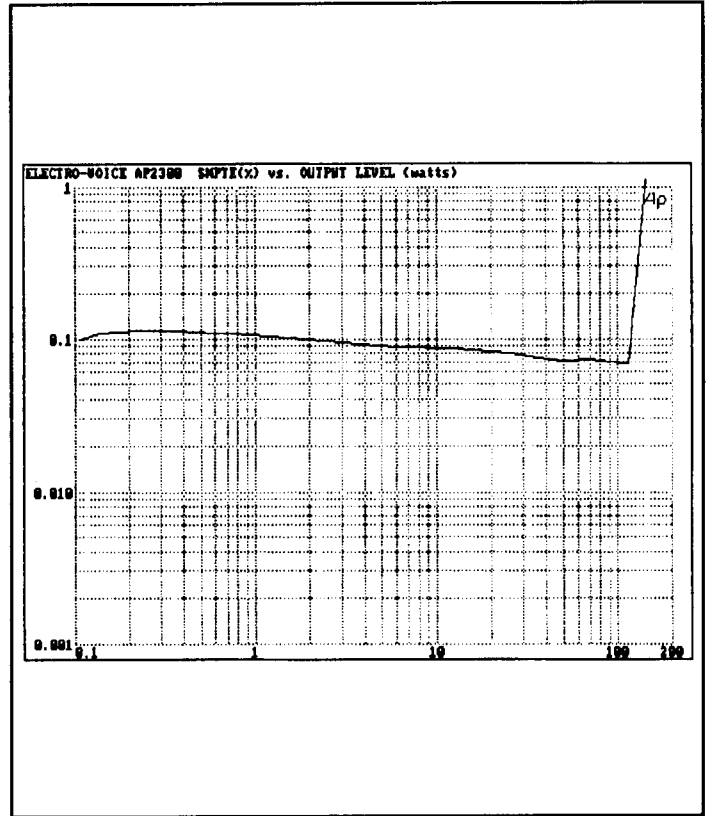

SMPTE VS. POWER

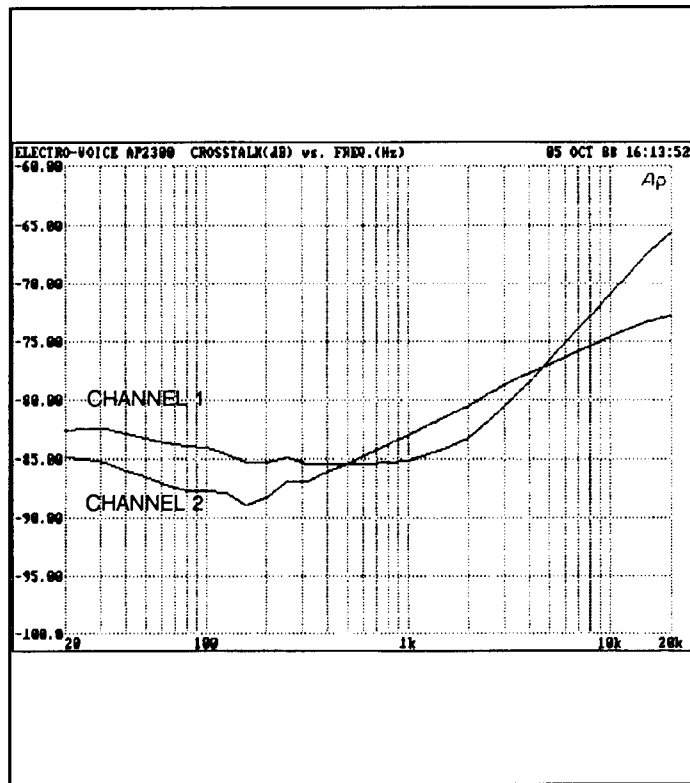

CROSSTALK VS. FREQUENCY

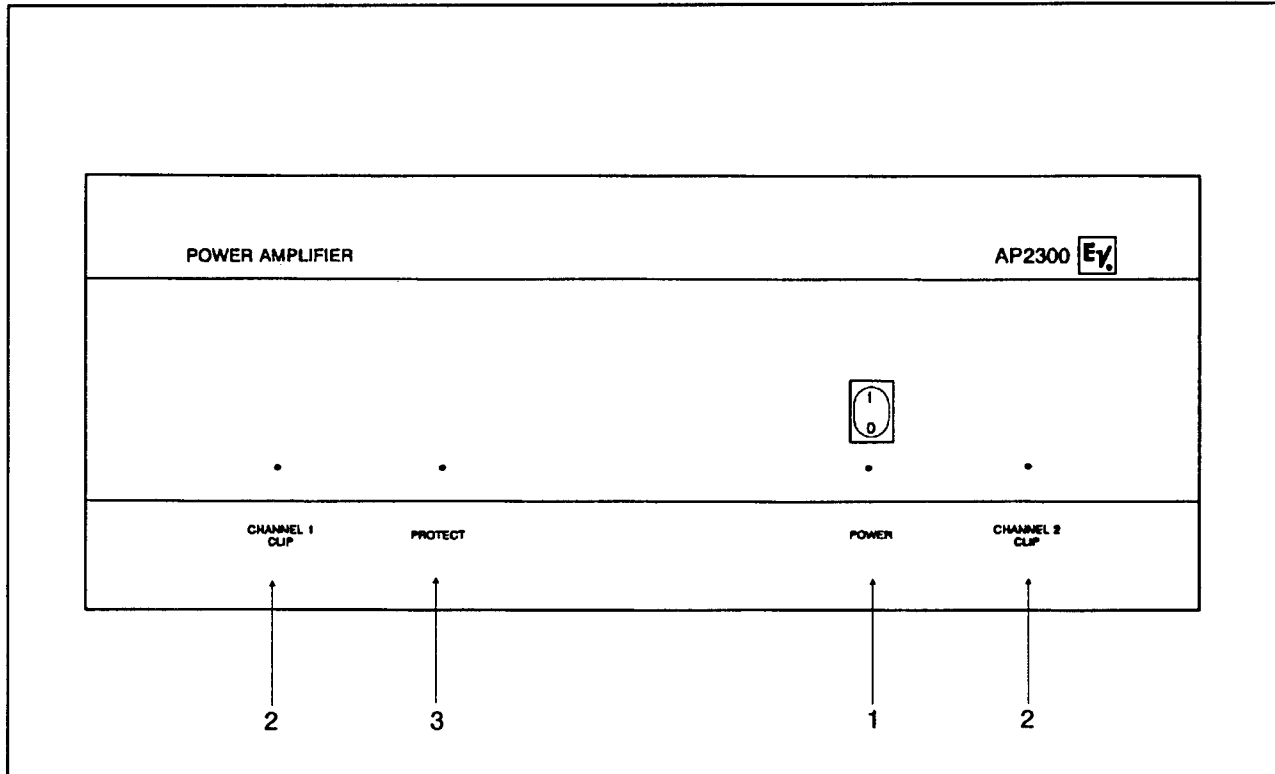

Pictorial 1 - Front Panel Diagram

OPERATION

FRONT PANEL INDICATORS (refer to Pictorial 1).

1. POWER INDICATOR : This LED is located directly below the power switch and lights when the unit is on.

2.CLIP INDICATORS: These LED's will light when the peak value of the output signal approaches the dc operating rail.

3.PROTECT INDICATOR: This LED will light when the amplifier has detected a fault condition and is in the protect mode.

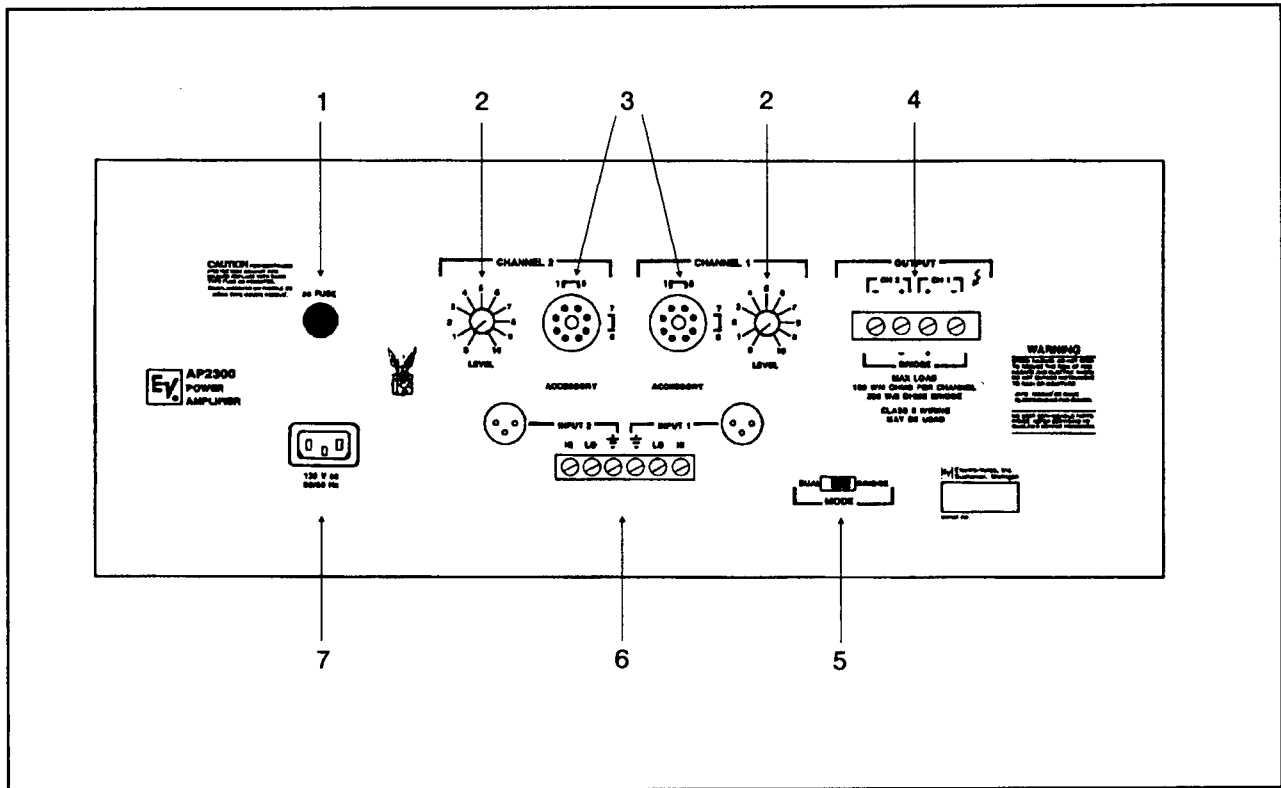

Pictorial 2 - Back Panel Diagram

OPERATION

BACK PANEL CONNECTIONS AND CONTROLS (refer to Pictorial 2).

1. AC FUSE RECEPTACLE: This holder requires either a 5-A, 250-V Normal-Blo fuse (for 100/120-V ac operation), or a 2.5-A, 250-V Normal-Blo fuse (for 200/220/240-V ac operation).

2. INPUT ATTENUATORS: These controls adjust the input levels for both channels.

3. ACCESSORY SOCKETS: These octal sockets allow the use of several accessories. See the SPECIFICATIONS section, page 3, for a listing of all compatible accessories.

4. CHANNEL OUTPUT CONNECTIONS: This terminal strip is for speaker connections, either in the dual or bridge mode.

5. MODE SWITCH: This switch enables either the dual or bridge mode of operation.

6. CHANNEL INPUT CONNECTIONS: Differential input connections can be made to either the terminal strip or the XLR-type connectors.

7. POWER CORD RECEPTACLE: This receptacle is for the supplied three-prong male power cord.

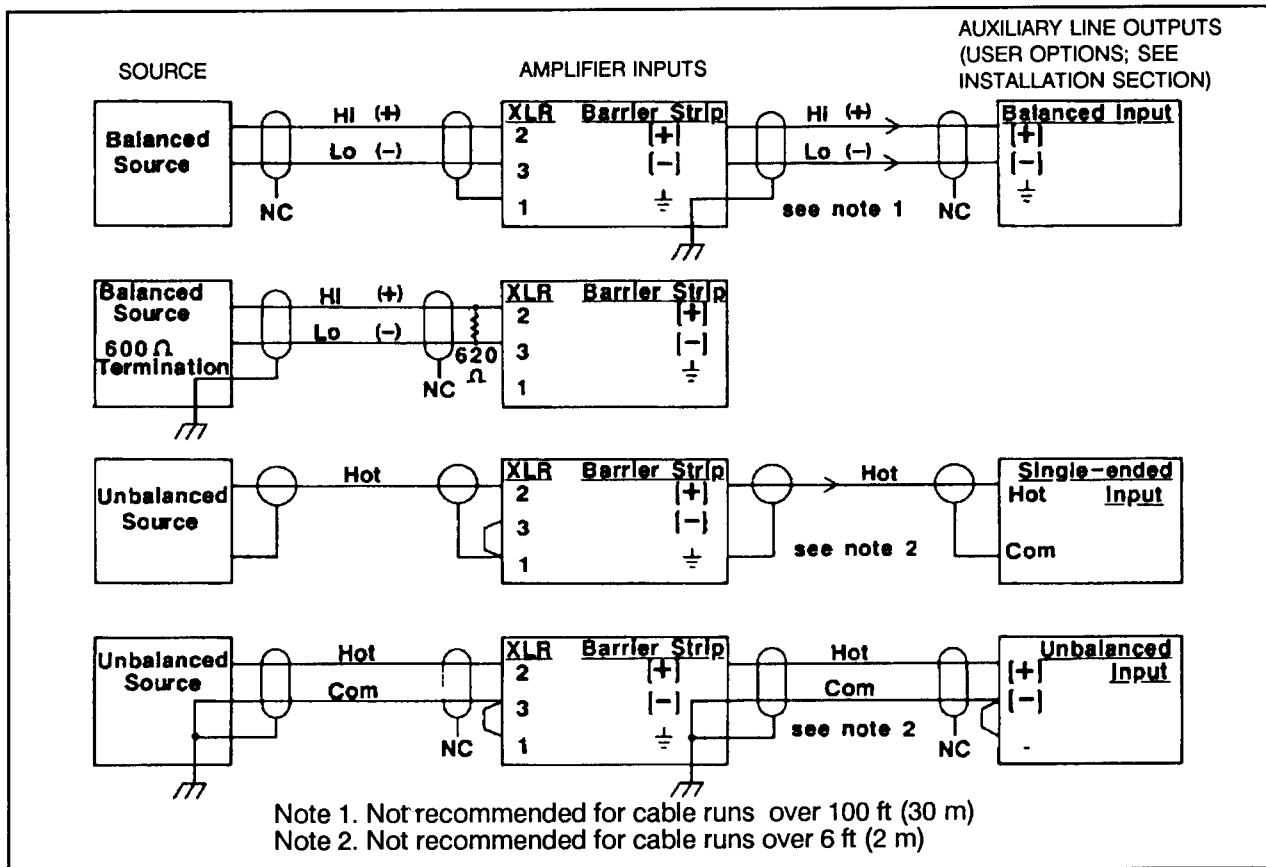

Figure 1 - Typical Input Connections

INSTALLATION

Amplifier Input Connections

Differential input connections are made to either the terminal strip or the XLR-type connector. The channel input connectors are wired in parallel. Pin 2 of the XLR-type connector is (+), pin 3 is (-), and pin 1 is ground. The polarity of the terminal is marked on the barrier strip. Tie the low (-) side of the signal to ground when using an unbalanced line. See the left half of Figure 1 for typical input connections.

Auxiliary Line Output Connections

The XLR-type and terminal barrier strip connectors are wired in parallel. Since the input impedance of the amplifier is high, there is minimal loading on the signal source. Thus, when input connections are made to one connector, the other may be used as an auxiliary line output to feed other high-input-impedance equipment. See the right half of Figure 1 of possible applications.

Speaker Output Connections

Termination of the speaker line(s) is made to the 4-terminal barrier strip. The polarity for each channel is marked, as is proper speaker termination for bridged operation. See Figure 2, page 10, for typical output configurations. See the following sections for suggestions on choosing protection fuses and capacitors.

Before making output connections, the input attenuators should be turned off (full counterclockwise). This will eliminate any chance of damage to the loudspeaker.

Speaker cables of sufficient gauge for the length used are important. Cables that are too small result in a lower damping factor and power loss due to cable resistance. The nomograph in Figure 3, page 10, will aid in selection of the proper gauge cable. To use the graph see the following instructions.

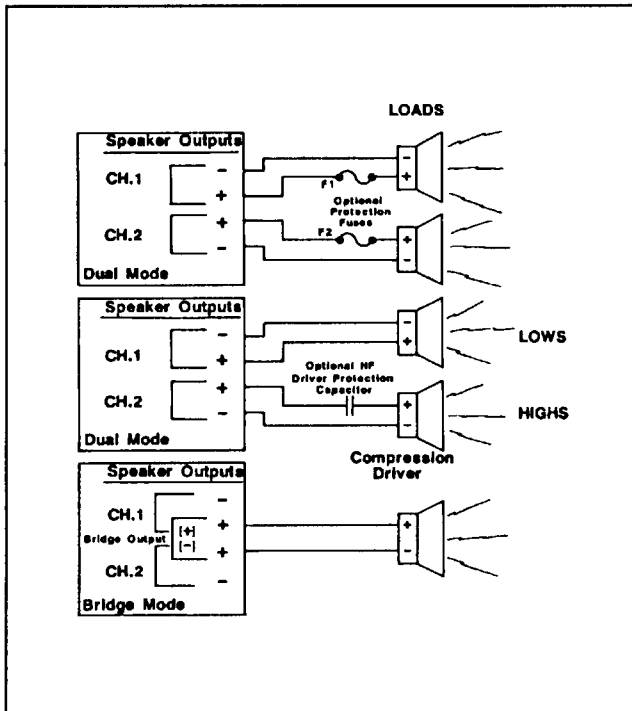

Figure 2 - Typical Output Connections

1. Note the load resistance of the speakers connected to each channel of the amplifier. Mark this value on the nomograph Load Resistance line.

2. Choose an acceptable system damping factor (50 is typical). Mark this value on the Damping Factor line.

3. Draw a pencil line through those two points, intersecting the Source Resistance line.

4. Mark the length of the cable run on the 2-Cond. Cable line.

5. Draw a pencil line from the intersection point on the Source Resistance line through the mark on the 2-Cond. Cable line.

6. Note where this pencil line intersects the Annealed Copper Wire line. This value is the required gauge of the speaker cable.

7. If the size of the cable is unacceptable, settle for a lower damping factor and try again.

Speaker Protection Fuse Selection

Sometimes it is desirable to use in-line fuses to protect loudspeaker systems. It is difficult to determine the proper fuse value with the correct time lag and overload characteristics to match the limitations of a given speaker system. The values shown in Table 1, page 11, should serve as a guide only. To use, determine the power rating and load value. Select a

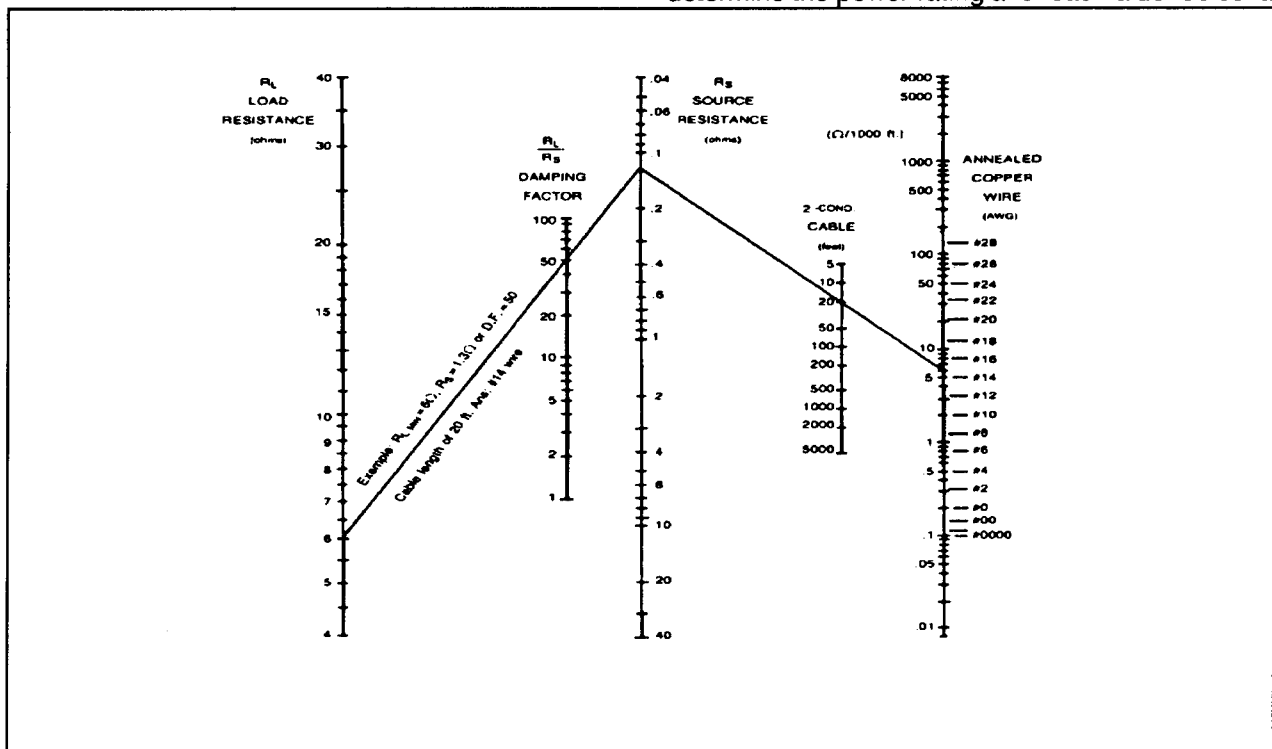

Figure 3 - Source Resistance and Damping Factor vs. Length and Size of Output Leads

standard value fuse of the next smaller value to the one in the table.

FUSE VALUES			
POWER	4-Ω LOAD	8-Ω LOAD	16-Ω LOAD
50 W	2.62 A	1.85 A	1.31 A
100 W	3.70 A	2.61 A	1.85 A
200 W	5.24 A	3.70 A	2.62 A
300 W	6.42 A	4.54 A	3.21 A
400 W	7.41 A	5.24 A	3.70 A

Table 1 - Calculated Speaker Protection Fuse Values

The values are calculated for fast-blow fuses which will carry 135% of their current rating for an hour but will blow within one second at 200%. Other fuse values may be calculated for different power levels from the following equation:

$$\text{Fuse value (amperes)} = \frac{P_{\text{out}} \times R_L}{R_L \times 1.35}$$

where R_L is the load impedance and P_{out} is the power rating.

Use 32-volt fuses if possible. They typically have the lowest internal resistance which will minimize deterioration of the amplifier's damping factor. Refer to Figure 2, page 10, for additional information.

Compression Driver Protection

Compression drivers, used for middle- and high-frequency sound reproduction, are much more susceptible to damage from low frequencies than large cone loudspeakers. Even though an electronic crossover may be employed, problems may arise in the cables between the crossover and the power amplifier, or from misadjustment of the crossover. Either of these could apply low-frequency signals or hum to the driver and cause damage. To prevent a potential mishap, it is recommended that a capacitor be used between the amplifier and the compression driver to suppress low frequencies and possible dc. Refer to Figure 2, page 10, for installation details.

In choosing a value, be careful not to interfere with the crossover frequency. As a general rule, select a capacitor whose break frequency, with respect to the load, is 3 dB down at approximately one-half of the high-pass corner frequency of the crossover. Mylar

capacitors of at least 50 volts (preferably 100 volts) are recommended, but electrolytics are usable if they are nonpolar. Table 2 shows the recommended capacitor values for use with 8- and 16-ohm drivers at popular crossover frequencies.

CAPACITOR VALUES		
CROSSOVER FREQUENCY	8-Ω DRIVERS	16-Ω DRIVERS
500 Hz	80 μF	40 μF
800 Hz	50 μF	25 μF
1000 Hz	40 μF	20 μF
1200 Hz	33 μF	16 μF
2000 Hz	20 μF	10 μF
3500 Hz	12 μF	6 μF
7000 Hz	6 μF	3 μF

Table 2 - Compression-Driver Protection Capacitors

Modes of Operation

Dual Channel: In this mode, the amplifier's two channels operate independently of one another. Channel one's output is controlled by the channel one input attenuator. The same is true for channel two's output. The mode switch must be in the dual position.

Bridge: In this configuration, the amplifier can deliver 300 watts into an 8-ohm load. It is recommended that the load be greater than 4 ohms. Use the following directions to set the amplifier for bridge operation.

1. Set the rear panel switch to the bridge position.
2. Attach an input line to the channel one input only. Level adjustment is done with the channel one attenuator.
3. Do not use the channel two input; otherwise distortion may result. When in the bridged mode, disconnect the channel two input and turn the channel two input attenuator to the off position (full counterclockwise).
4. Connect the load across the two plus (+) terminals at the output barrier strip. Do not use either of the minus (–) terminals at the output strip. The channel one plus (+) output is in phase with pin 2 (+) of the channel one input connector.

Primary Voltage

The amplifier is provided from the factory with the primary of the power transformer wired for 120 volts. Make sure that the rear of the unit is marked for 120-volt operation before connecting the power cord.

*****CAUTION*****

Hazardous voltages and currents may exist within the chassis. The service information contained within this document is for use only by Electro-Voice authorized warranty stations and qualified service personnel.

Alternate Primary Voltage

The amplifier can be powered with line voltages other than 120 volts by altering the primary wiring of the power transformer. Table 3 lists the primary wire color, the terminal block (TB), and where the TB wire should be located for operation at the desired voltage.

To alter the transformer primary wiring configuration use the following procedure:

1. Disconnect the amplifier from the ac power source.
2. Remove the 14 screws securing the top cover.

Permanent Connections●	Factory Wiring (120 V)	100 V
		
200 V	220 V	240 V
		
● DO NOT MOVE THESE WIRES, THEY ARE COMMON TO ALL PRIMARY VOLTAGES		

Table 3 - Primary Power Conversion Chart for 100-, 200-, 220-, and 240-V, 50/60-Hz Operation

3. Locate the two voltage-selection terminal blocks mounted on the crossbar between the heatsinks. The transformer has six primary leads. The colors are black, brown, white, black/white, brown/white and white/black. Disconnect the primary leads of the power transformer by pulling each wire firmly to disengage it from the terminal connector. Select the desired operating voltage on Table 4 and reconnect the wires accordingly. Push each wire firmly into the connector to snap it in place.

4. Install the correct line fuse (values in Table 4).

5. Plug the amplifier into a variac and sweep the mains voltage from zero to full operating voltage while monitoring the amplifier's dc rail voltages. The dc rail voltage should be approximately ± 55 V dc, $+5\%$ at the selected primary voltage.

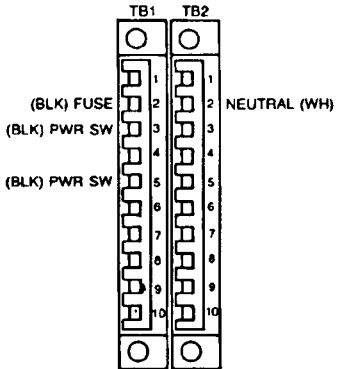
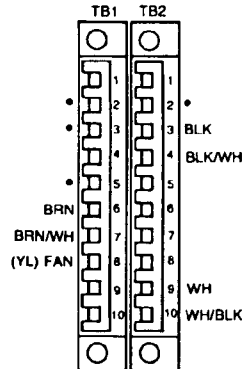
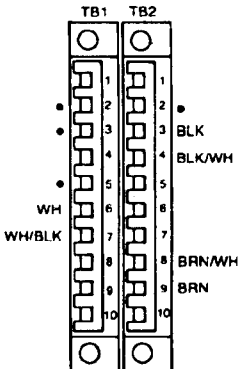
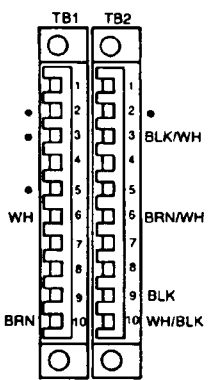
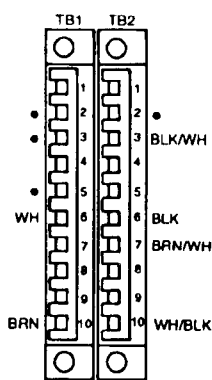
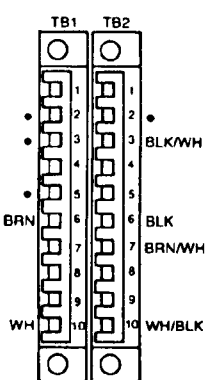
6. Reinstall the top cover with the 14 screws.

MAIN FUSE VALUES	
LINE VOLTAGE	LINE FUSE, 314 SERIES, NORMAL-BLO
100 V ac	5 A/250 V
120 V ac	5 A/250 V
200 V ac	2.5 A/250 V
220 V ac	2.5 A/250 V
240 V ac	2.5 A/250 V

Table 4 - Main Fuse Selection Guide

Mounting

The AP2300 may be installed in a standard 19-inch wide equipment rack and requires 3 rack spaces (5-1/4 inches). Mounting screws are supplied.

Cooling

The AP2300 must be adequately ventilated to avoid excessive temperature rise. Do not impede the air flow into or out of the amplifier. If the ambient temperature exceeds 60 °C (140 °F), units should be spaced at least 1-3/4 inches apart or a blower should be installed to increase the air flow in the rack cabinet. Further, if the load is less than 4 ohms, and the rms output is high (e.g., concert sound reinforcement) the additional cooling space is recommended.

Final Instructions

1. Do not operate the amplifier in a completely closed, unventilated housing.

2. Do not connect the outputs of the channels in parallel.

3. Do not connect the output terminals to a battery, power supply, or the power mains. Damage caused from such a hookup is not covered by the warranty.

4. Be careful when making connections, selecting signal sources and controlling the output level.

5. Do not tie the input signal ground to the ground lead of an output. Ground-loop-induced oscillations may occur.

6. Ensure that the main ac power is within 10% of selected voltage and frequency. Failure to operate the unit within these limits voids the warranty.

7. Use only the proper size mains fuse for the selected ac voltage, as indicated in Table 4.

8. Do not connect either side of the loudspeaker cable to ground when operating the unit in the bridged mode. The bridge mode is balanced to ground.

9. Make certain that the test equipment is not ground referenced when testing the unit in the bridged mode.

10. Tampering with the circuit or repair by unauthorized personnel will void the warranty of the unit.

AP2300 SCHEMATIC

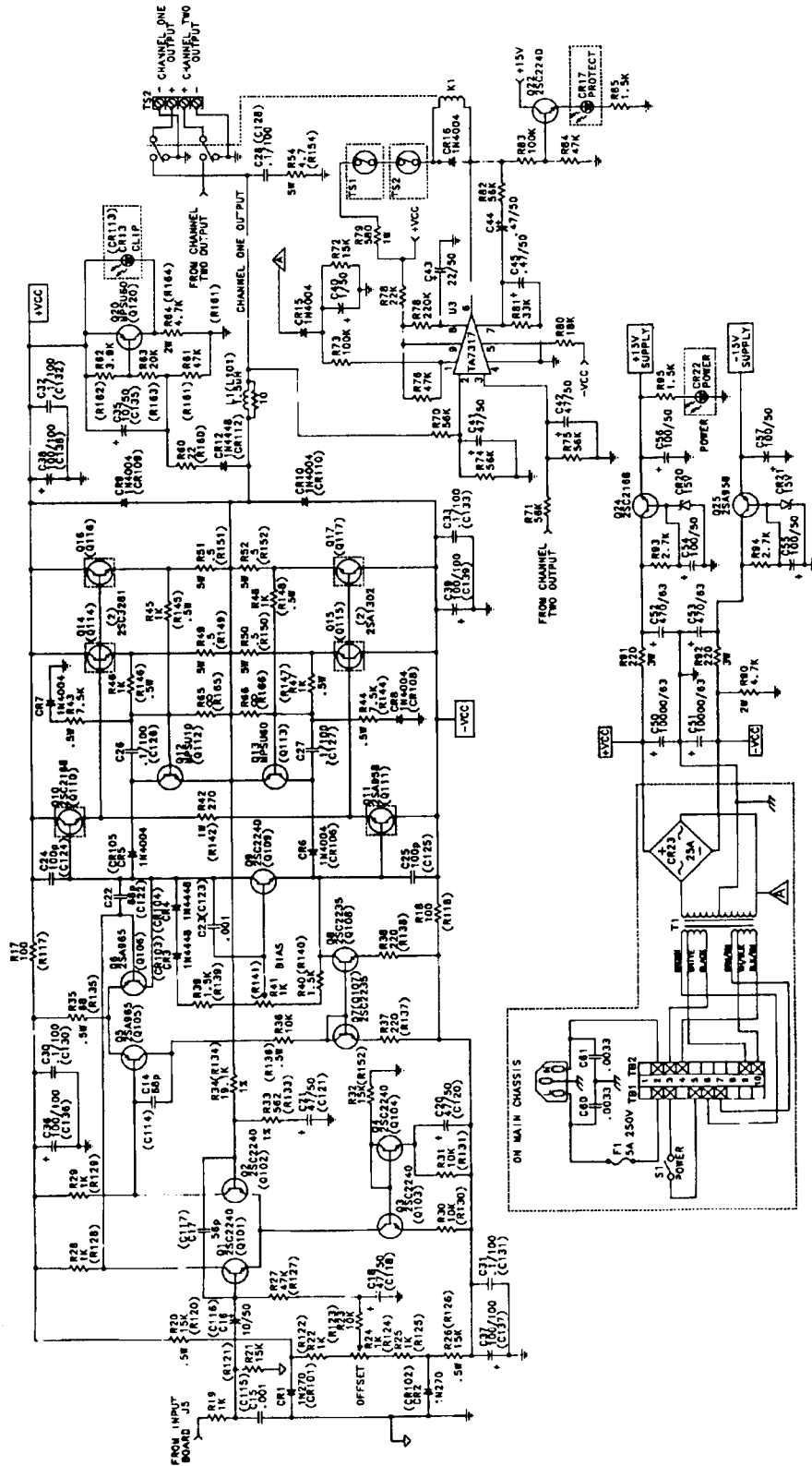

AP2300 INPUT BOARD SCHEMATIC

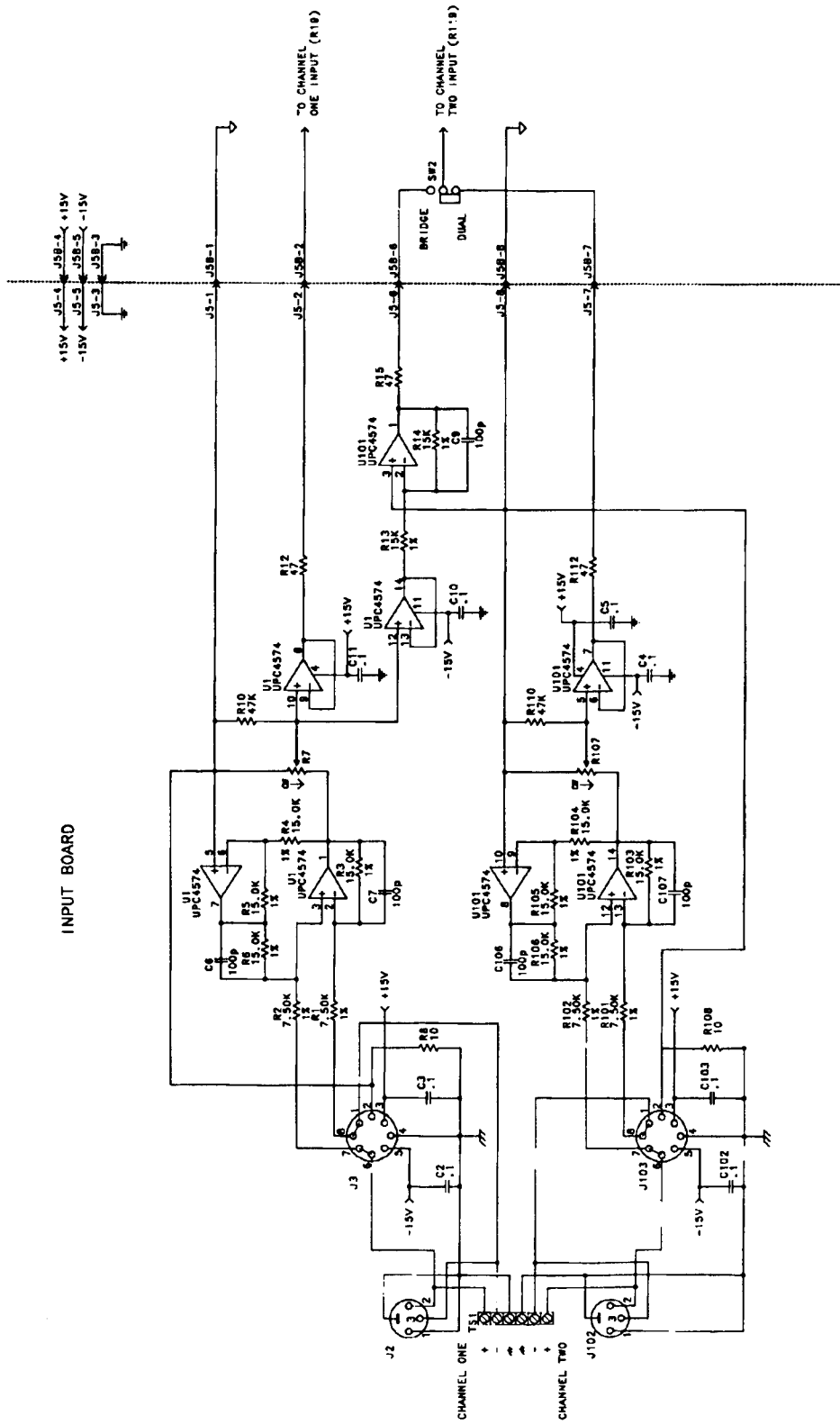

SERVICE INFORMATION**Shipping Damage**

Inspect the shipping carton for possible damage. If damage is found, notify the transportation company immediately. Save the carton as evidence for the carrier to inspect. If damage occurs during shipping, it is the responsibility of the consignee to file a claim with the carrier. If the carton is in good condition but the amplifier is damaged, call Electro-Voice.

Factory Service

If factory service is required, ship the unit prepaid in its original carton to:

Electro-Voice, Inc.
CustomerService/Repair
10500 W.Reno
Oklahoma City, OK 73128

Enclose a note describing the problem along with any other helpful information such as where and how the unit is used.

WARRANTY (Limited) -

Electro-Voice Professional Sound Reinforcement Electronic Components are guaranteed for two years against malfunction due to defects in workmanship and materials. If such malfunction occurs, unit will be repaired or replaced (at our option) without charge for materials or labor if delivered prepaid to the proper Electro-Voice service facility. Unit will be returned prepaid. Warranty does not extend to finish, appearance items or malfunction due to abuse or operation under other than specified conditions, nor does it extend to incidental or consequential damages. Some states do not allow the exclusion or limitation of incidental or consequential damages, so the above exclusion may not apply to you. Repair by other than Electro-Voice or its authorized service agencies will void this guarantee. A list of authorized service centers is available from Electro-Voice, Inc., 600 Cecil Street, Buchanan, MI 49107 (AC/616-695-6831); Electro-Voice, Inc., 3810 148th Avenue N.E., Redmond, WA 98052 (AC/206-881-9555); and/or Electro-Voice West, 8234 Doe Avenue, Visalia, CA 93291 (AC/209-651-7777). This warranty gives you specific legal rights, and you may also have other rights which vary from state to state.

Service and repair address for this product:

Electro-Voice, Inc., 10500 W. Reno, Oklahoma City, OK 73128

Specifications subject to change without notice.