



Electro-Voice®

OPERATION MANUAL & SERVICE INSTRUCTIONS

MODEL AP2800

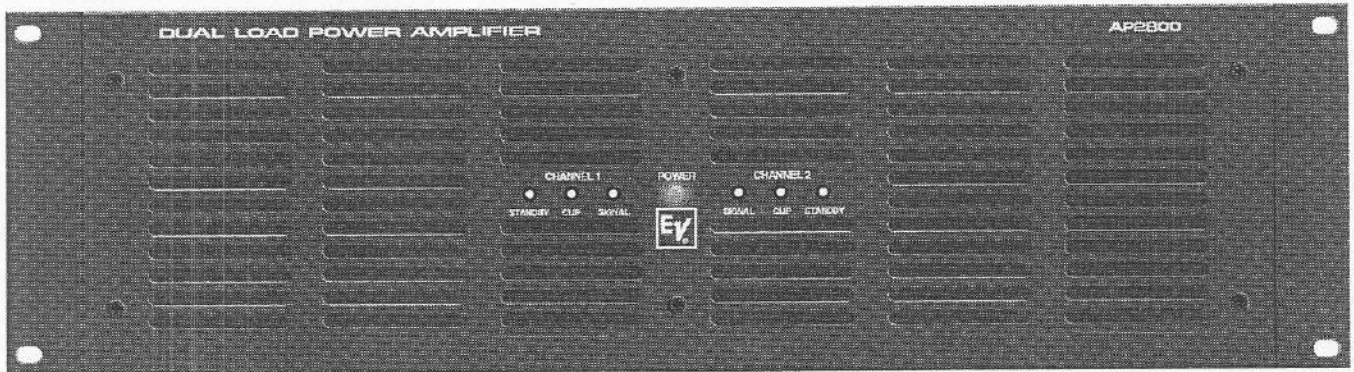



TABLE OF CONTENTS	PAGE	TABLES AND ILLUSTRATIONS	PAGE
PRODUCT DESCRIPTION	3	INPUT MODULE AND LINK CONNECTIONS ILLUSTRATIONS	
UNPACKING	3	Figure 1 Connections for balanced or unbalanced signal sources	6
PRECAUTIONS	3	Figure 2 Internal jumpers for accessories, link and grd jumper	6
SPECIFICATIONS	4	Figure 3 Input grounding options	6
POWER CONSUMPTION AND THERMAL DISSIPATION	5	Figure 4 Inserting an external device internal connections	7
INPUT MODULE AND LINK CONNECTIONS	5	Figure 5 Inserting an external device external connections	7
BRIDGING TRANSFORMER OPTION	7	Figure 6 Optional accessory link-out connections	7
OUTPUT CONNECTIONS, CONFIGURATIONS	8	OUTPUT CONNECTION ILLUSTRATIONS	
Dual Mode	8	Figure 8 Dual mode configuration	8
Parallel Mono	8	Figure 9 Parallel mono configuration	8
Bridged Mono	9	Figure 10 Bridged mono configuration	9
ILLEGAL MODE	9	Figure 11 Optional protection fuse connection	13
70 VOLT OPERATION	9	Figure 12 BIAMP connection with driver protection capacitor	13
INSTALLATION	10	SERVICE INSTRUCTIONS	
VENTILATION	10	Figure 13 Access screws	17
OUTPUT CABLE SELECTION	11	Figure 14 DC bias and IT calibration trim pot locations	17
CALCULATING POWER LOSSES	11	Figure 15 Idle current trim pot locations	17
DAMPING FACTOR & CABLE LENGTH	12	TABLES	
SPEAKER PROTECTION	13	I. H-Pad Resistance Values using 1% resistors	7
SERVICE INSTRUCTIONS	14	II. Power losses per foot in 2-wire speaker cable	11
INPUT CARD PIN ASSIGNMENTS	18	III. DC resistance for 2-wire cable	12
SCHEMATIC/INPUT BOARD	19	IV. Speaker protection fuse chart	13
FACTORY SERVICE	20	V. Protection capacitor sizes for common cross-over frequencies	13
TECHNICAL SERVICE	20		
ACCESSORIES	20		

Uniform Limited Warranty Statement

Electro-Voice® products are guaranteed against malfunction due to defects in materials or workmanship for a specified period, as noted in the product-line statement(s) below, or in the individual product data sheet or owner's manual, beginning with the date of original purchase. If such malfunction occurs during the specified period, the product will be repaired or replaced (at our option) without charge. The product will be returned to the customer prepaid.

Exclusions and Limitations: The Limited Warranty does not apply to: (a) exterior finish or appearance; (b) certain specific items described in the individual product-line statement(s) below, or in the individual product data sheet or owner's manual; (c) malfunction resulting from use or operation of the product other than as specified in the product data sheet or owner's manual; (d) malfunction resulting from misuse or abuse of the product; or (e) malfunction occurring at any time after repairs have been made to the product by anyone other than Electro-Voice® Customer Service or any of its authorized service representatives.

Obtaining Warranty Service: To obtain warranty service, a customer must deliver the product, prepaid, to Electro-Voice® Customer Service or any of its authorized service representatives together with proof of purchase of the product in the form of a bill of sale or receipted invoice. A list of authorized service representatives is available from Electro-Voice® Customer Service at 600 Cecil Street, Buchanan, MI 49107 (800-234-6831 or FAX 616-695-4743).

Incidental and Consequential Damages Excluded: Product repair or replacement and return to the customer are the only remedies provided to the customer. Electro-Voice® shall not be liable for any incidental or consequential damages including, without limitation, injury to persons or property or loss of use. Some states do not allow the exclusion or limitation of incidental or consequential damages so the above limitation or exclusion may not apply to you.

Other Rights: This warranty gives you specific legal rights, and you may also have other rights which vary from state to state.

Electro-Voice® Electronics are guaranteed against malfunction due to defects in materials or workmanship for a period of three (3) years from the date of original purchase. Additional details are included in the Uniform Limited Warranty statement.

PRODUCT DESCRIPTION

The Electro-Voice® model AP2800 amplifier is designed for direct voice-coil drive and/or 70.7-volt distributed systems. Each channel can be independently configured for 70.7-volt line operation or 8/4-ohm systems. The two channels together can be paralleled or bridged for driving a single load. This series features an ultraquiet continuously variable cooling system which pulls air from front to back. An air filter is provided and can be removed from the front for cleaning. The input module is removable and provides internal connections for signal processing accessories and input transformers. There are also provisions for input grounding options and an H-pad for attenuation and impedance matching. XLR connectors and removable screw terminal connectors are standard. There is an additional connector provided to allow the user to link internal optional accessories such as power limiters, filters or cross-overs to the input of other amplifiers in the system. This allows for example the implementation of stereo two-way or mono three-way cross-overs within a single standard input module. This can be expanded between two amplifiers to provide stereo three-way or mono five-way cross-overs. Optional control modules replace the standard input module to allow compatibility and connection to an Interactive Technology network. Each channel is protected against load shorts, over-temperature and output dc. The front panel indicators provide signal present, signal clip and standby for each channel as well as a power on indicator.

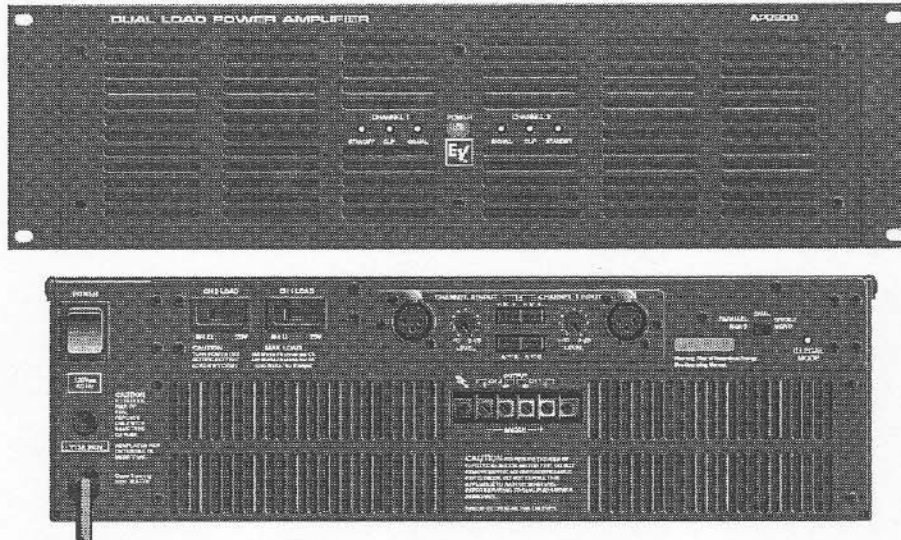

UNPACKING

This shipping carton is specially designed to protect the amplifier while transporting under normal conditions. It is still possible for damage to occur so carefully inspect the outside carton for signs of abuse. If for any reason the amplifier should be returned, use the shipping carton that it came in. Electro-Voice® cannot warranty against damage that occurs as a result of improper packaging.

PRECAUTIONS

Do not replace the fuse with a higher amp rating than what is specified. There are various circuits inside that detect fault conditions and place the amplifier in standby (indicated on the front panel by the amber LEDs). A blown ac panel fuse indicates a more severe problem such as a transformer failure. An oversized fuse installed under these conditions can lead to a possible fire hazard.

There is a thermal fuse located inside the transformer primary windings to protect against unusual conditions that the amplifier fault logic may not sense. For example, a leaky power supply capacitor can cause excessive current to flow therefore heating up the transformer, yet the amplifier appears to perform normally. If the amplifier is operating under extreme conditions that cause the transformer to overheat, it is possible for this thermal fuse to trip before either the back panel fuse blows or the amplifier engages a standby condition. In this case, the internal transformer fuse will remain open (no power) until the temperature inside the transformer drops to a safe level. At that time the fuse will close and power will again be applied. This shut-down condition can be recognized by a total power lost even though the panel fuse is good. This contrasts against a thermal shut-down by the fault logic where the power and stand-by LEDs on the front panel are brightly lit and the internal fan may be running.



SPECIFICATIONS

RATED POWER specifications are for < 0.1% THD, 20-20kHz, both channels driven (30kHz measurement bandwidth).

FULL POWER specifications are for 0.1% THD @ 1 kHz, both channels driven (30 kHz measurement bandwidth).

RATED POWER IN WATTS	AP2800
<i>Full power in paranthesis</i>	
Dual Mode	
4-ohm	500 (548)
8-ohm	400 (437)
70-volt	400 (460)
Parallel Mono	
2-ohm	1000 (1060)
4-ohm	800 (854)
8-ohm	400 (511)
70-volt	800 (915)
Bridged Mono	
8-ohm	1000 (1120)
16-ohm	800 (870)
140-volt	800 (910)

FREQUENCY RESPONSE

10 Hz to 80kHz (ref. 1kHz, 1 watt output, + 0/-3 dBr)

POWER BANDWIDTH

20Hz to 20kHz

(ref. 1kHz, +0/- .5 dBr where 0 dBr = rated output power in any mode)

VOLTAGE GAIN: (ref. 1 kHz)	AP2800
Dual Mode	
4/8-ohm	37.2 dBu
70-volt	39.2 dBu
Parallel Mono	
2/4/8-ohm	37.2 dBu
70-volt	39.2 dBu
Bridged Mono	
8/16-ohm	43.2 dBu
140-volt	45.2 dBu

SIGNAL TO NOISE: > 100 dBr (A wtd.) measured below rated output

SENSITIVITY	AP2800
8 ohm / 70 V / 140 V	0 dBu (0.775 Vrms)
4Ω Dual	-2 dBu (0.616 Vrms)
2Ω Par	-2 dBu (0.616 Vrms)
8Ω bridged	-2 dBu (0.616 Vrms)

INPUT IMPEDANCE:	15k Ohms
SOURCE IMPEDANCE:	0.032 Ohms
CROSS TALK:	< -70 dB at 1kHz
DC OFFSET:	Less than 10 mV
SLEW RATE:	15 V/uS
DAMPING FACTOR:	> 300 (1 kHz, 8-ohm)
AC POWER:	120 V ac / 60 Hz
MINIMUM AC VOLTAGE:	95 V ac / 60 Hz

PHYSICAL:	AP2800
Depth:	16.75 in. (425.5mm)
Width:	19 in. (482.6mm)
Height:	5.25 in. (133.4mm)
Weight:	49.5 lb (22.45 kg)
Shipping Weight:	53.87 lb (24.42 kg)

POWER CONSUMPTION AND THERMAL DISSIPATION

The following tables provide guidelines for estimating heat dissipation of the amplifier, given it's intended application. This data is based on the following equation:

$$P_{dis} = P_{ac} - P_{ld}$$

P_{dis} = Power Dissipated in Watts

P_{ac} = True AC Mains Power in Watts Consumed

P_{ld} = Total Average Power Delivered to the Load

The applications are as follows:

Idle: The amplifier is on with no signal present.

Paging/Background Music: The amplifier is operating with one second announcements (at full power) every 15 seconds or back ground music which is attenuated -32 dB.

Continuous Speech: The amplifier is operating with continuous speech that is attenuated -23 dB.

Dynamic: The amplifier is operating with a dynamic input signal such as a motion-picture sound track or classical music. Loud passages are at full power, soft passages are equivalent to continuous speech.

Full Music Power: The amplifier is operating with continuous music input at rated output to the load with only occasional clipping.

Conditions for following measurements:

Line = 120 Vac / 60 Hz • Both channels driven equally and with equal loads for dual mode measurements

INPUT MODULE AND LINK CONNECTIONS

Balanced input connections may be made to either the three-pin screw terminals or the XLR connectors. The screw terminal connections are internally wired directly to the XLR pins. XLR pin 1 corresponds to the screw terminal marked with a ground symbol. XLR pins 2 and 3 correspond to the terminals marked "+" and "-" respectively (refer to input board schematic on page 19). Figure 1 illustrates two types of connections to the input module using the detachable 3.5 millimeter plugs that are provided as part of the accessory kit. The first connection shown is for interfacing to a balanced signal source. The source generates two signals (+ and -) and provides a ground reference for shielding. The optimum ground reference for this configuration is the chassis ground of both the source device and the amplifier. This configuration requires that the internal ground jumper is set in either the "CHAS GND" position or the floating position (see figures 2 and 3). The second connection

AP2800

Line Current, Power Consumed/
Dissipated and Output for selected
applications

Application: Idle						
Load	Line Current (A)	Pac (W)	Pld (W)	Pdi (W)	Btu/Hr	Kcal/Hr
2 ohm Parallel	1.11	43	0	43	148	37
4 ohm Dual	1.09	42	0	42	144	36
8 ohm Dual	1.15	48	0	48	165	41
8 ohm Bridged	1.13	47	0	47	161	40
70 V Dual	1.19	53	0	53	182	45
70 V Parallel	1.11	46	0	46	158	39
140 V Bridged	1.13	48	0	48	165	41

Application: Paging/Background Music						
Load	Line Current (A)	Pac (W)	Pld (W)	Pdi (W)	Btu/Hr	Kcal/Hr
2 ohm Parallel	1.66	104	0.91	104	356	88
4 ohm Dual	1.68	110	0.91	109.09	374	93
8 ohm Dual	1.43	83	0.73	82.27	282	70
8 ohm Bridged	1.68	110	0.91	109.09	374	93
70 V Dual	1.48	90	0.73	89.27	306	76
70 V Parallel	1.44	84	0.73	83.27	286	71
140 V Bridged	1.48	90	0.73	89.27	306	76

Application: Continuous Speech						
Load	Line Current (A)	Pac (W)	Pld (W)	Pdi (W)	Btu/Hr	Kcal/Hr
2 ohm Parallel	3.26	261	10	251	860	213
4 ohm Dual	3.31	264	10	254	870	215
8 ohm Dual	2.46	183	8	175	600	149
8 ohm Bridged	3.25	259	10	249	853	211
70 V Dual	2.47	185	8	177	608	150
70 V Parallel	2.45	180	8	172	589	145
140 V Bridged	2.48	185	8	177	606	150

Application: Dynamic						
Load	Line Current (A)	Pac (W)	Pld (W)	Pdi (W)	Btu/Hr	Kcal/Hr
2 ohm Parallel	6.72	582	65	527	1804	446
4 ohm Dual	6.81	597	65	532	1822	451
8 ohm Dual	4.68	394	52	342	1171	290
8 ohm Bridged	6.71	589	65	524	1794	444
70 V Dual	4.69	392	52	340	1164	288
70 V Parallel	4.82	400	52	348	1192	295
140 V Bridged	4.75	394	52	342	1171	290

Application: Full Music Power						
Load	Line Current (A)	Pac (W)	Pld (W)	Pdi (W)	Btu/Hr	Kcal/Hr
2 ohm Parallel	9.73	893	160	733	2510	621
4 ohm Dual	9.8	901	160	741	2537	627
8 ohm Dual	6.71	588	128	460	1575	390
8 ohm Bridged	9.7	890	160	730	2499	618
70 V Dual	6.71	582	128	454	1555	385
70 V Parallel	6.93	597	128	469	1605	397
140 V Bridged	6.77	586	128	458	1568	388

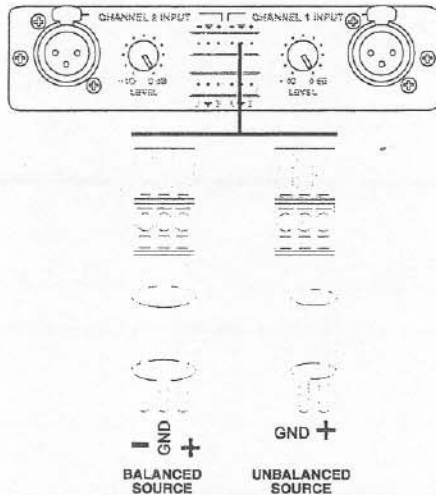
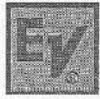

Figure 1 Connections for balanced or unbalanced signal sources.

shown in figure 1 is for an unbalanced signal source. Since the "-" of the unbalanced signal source is also the signal-ground, the "-" terminal of the amplifier must be referenced to this same point. The internal ground jumper must be in the "SIG GND" position for all unbalanced connections (see figures 2 and 3). The balanced and unbalanced connections shown in figure 1 can also apply to XLR connectors. If you are using XLR connectors and you intend to float the shield, be sure you are not inadvertently connecting the chassis ground to the cable shield through the fourth connection of the XLR connector. Some XLR connectors provide a fourth connection to the metal housing which will connect to the chassis ground of the amplifier when plugged in.

XLR PIN 1 GROUND JUMPER

To help facilitate various grounding connections for pin 1 of the XLR connectors (and the input terminal ground), a three pin jumper is provided on the standard input module (figure 2). This jumper connects pin 1 of both XLR connectors to either the chassis ground (indicated by CHAS GND) or signal ground (indicated by SIG GND). The unit is shipped with pin 1 connected to the chassis (Figure 3). This position offers the best isolation from ground loops and noise if you use a uniformly shielded twisted pair cable that does not include a drain wire. A third option is to float the input ground by removing the jumper completely (Figure 3). This will break ground loops but may not offer good shielding unless the signal source provides a good ground for the cable shield. You should only use the signal ground position if you are using unbalanced signal sources.

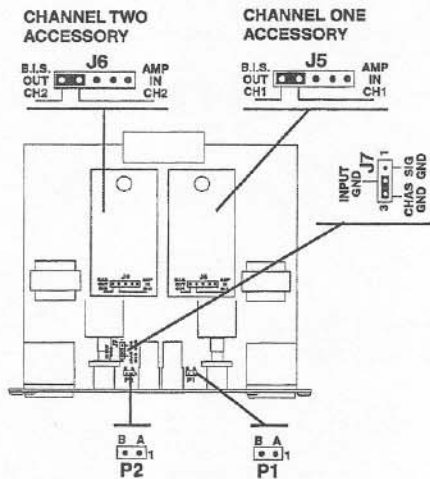

Figure 2 Internal jumpers for accessories, link connector and ground jumper.

LINK CONNECTOR

Each channel of the standard input module provides the user with a flexible three-pin link connector. There are two primary functions that the link connector performs. (1) It provides a way to insert an external signal processor into the signal path by isolating the entire balanced input stage from the unbalanced input to the amplifier. (2) It provides buffered outputs for the optional accessories that plug into the standard input module. The pin marked 'A' of each link connector is hard-wired to the output of the optional accessory module (figure 6). The pin marked 'B' is unassigned. This pin ties to a header (P1 for channel 1, P2 for channel 2) inside the standard input module and is not connected to any circuit in the board (figure 2). The center pin of the link connector is hard-wired to the analog signal ground and is used as the ground reference for all link connections to external components (refer to input board schematic on page 19).

INSERTING EXTERNAL SIGNAL PROCESSORS INTO THE SIGNAL PATH

You can isolate the entire balanced input stage for each channel by removing the jumper J5/ch1 or J6/ch2. The output of this stage is marked on the pc board as 'B.I.S. OUT CH1' or 'B.I.S. OUT CH2' (figure 2). This signal can be brought out of the module via the 'B' pin of the Link connector by patching 'B.I.S. OUT CH1 or CH2' to the post header of P1 or P2 that is marked 'B' (figure 4). The accessory kit that is included with the amplifier contains several post-header terminals that can be used to build shorting jumper wires. The signal can be returned via the 'A' pin of the Link connector since it is hard wired to the unbalanced amplifier input. The ability to insert signal processors such as filters, equalizers and compressor/limiters allows the user to take advantage of the features of the balanced input stage (i.e. H-pad, transformer isolation and ground selection) which is not likely to be available on most signal processing equipment. Figure 5 shows how this feature can be used to insert an equalizer into the audio path for channel one using the internal connections shown in figure 4.

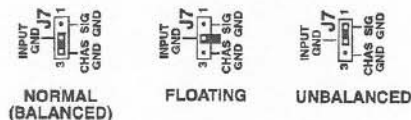

Figure 3 Input grounding options.

BRIDGING TRANSFORMER OPTION

The 7100 Series input module can be transformer balanced without replacing the input card. An optional ITM transformer will provide isolation from the source equipment. When the ITM Transformer is used in conjunction with the on-board H-PAD connections, any combination of attenuation and matching configurations can be achieved. For more information see H-PAD.

H-PAD

The standard input module provides the user with the ability to insert an H-Pad into the input signal path. This circuit can be used to attenuate input signals prior to the optional bridging transformer (ITM) and/or the active circuitry in the input module (refer to input board schematic on page 19). The H-Pad can also be designed to match the source impedance in addition to attenuating the input. Table 1 lists resistor values to use in the H-Pad for typical loads of 15k and 600 ohms.

TABLE 1 H-Pad Resistance Values Using 1% Resistors

Desired Attenuation (600 Ω)	Resistor Values for Pad in Ohms					
	RH1	RH2	RH3	RH4	RH5	RH6
-20 dB	243	243	121	243	243	604
-15 dB	210	210	221	210	210	604
-10 dB	154	154	422	154	154	604
0 dB	short	short	open	short	short	604

Desired Attenuation (15 k)	Resistor Values for Pad in Ohms					
	RH1	RH2	RH3	RH4	RH5	RH6
-20 dB	6190	6190	3010	6190	6190	open
-15 dB	5230	5230	5490	5230	5230	open
-10 dB	3920	3920	10600	3920	3920	open
0 dB	short	short	open	short	short	open

Conversion to Balanced-T-type attenuator

The H-Pad may be converted to a balanced-T-type attenuator by replacing resistor RH3 with resistors RH7 and RH8 where RH7 = RH8 = RH3 / 2.

Calculating the Resistor Values for Other Attenuation Losses

Other losses may be calculated using the following formulas:

$$RH1 = RH2 = RH4 = RH5 = \frac{(Z_L)(\sqrt{N} - 1)}{2(\sqrt{N} + 1)}$$

$$RH3 = \frac{2(Z_L)(\sqrt{N})}{(N - 1)}$$

$$RH6 = Z_L$$

Z_L = terminating impedance (usually 600Ω or 15kΩ)

N = 10 (Loss in dB / 10)

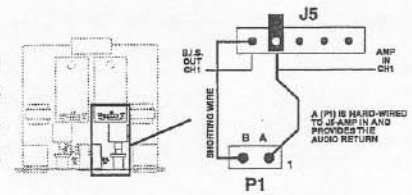

To insert external device (Channel One):

1. Remove shorting jumper at J5
2. Connect a user-supplied shorting wire from P1-B to J5-B. I.S. out Ch1.
3. See Figure 5 for external connections

Figure 4 Inserting an external device (channel-one internal connections).

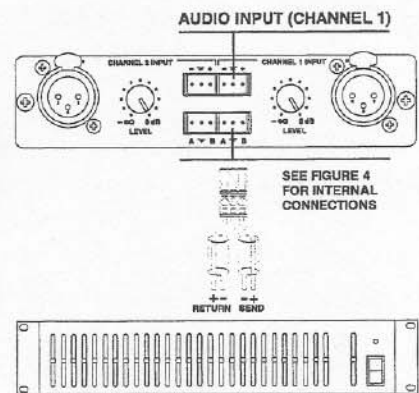

Figure 5 Inserting an external device (channel-one external connections).

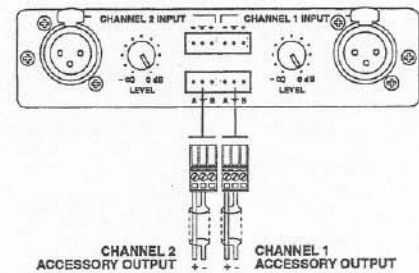

Figure 6 Optional accessory link-out connections.



Caution: Replace output cover after speakers are connected. Do not expose bare wires and terminals.

OUTPUT CONNECTIONS, CONFIGURATIONS

Speaker output connections are made to the four-terminal barrier-strip connector located below the input module. The output configurations are determined by the three-position mode switch located to the right of the input module, and the load switches located to the left of the input module.

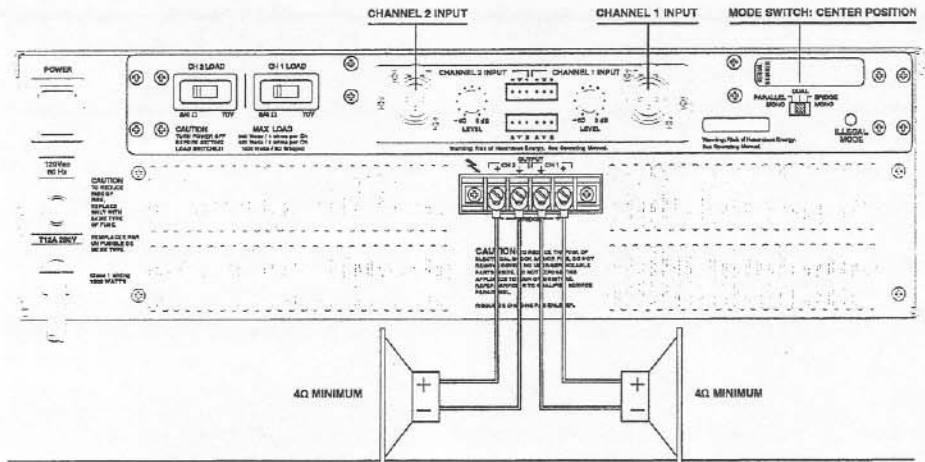

Figure 8 Dual (Stereo) Mode Connections

Dual Mode - In this configuration the amplifier is operating as two independent power amplifiers. Each speaker load can be independently configured for 8/4-ohm or 70-Volt line operation using the load switches located to the left of the input module (Figure 8).

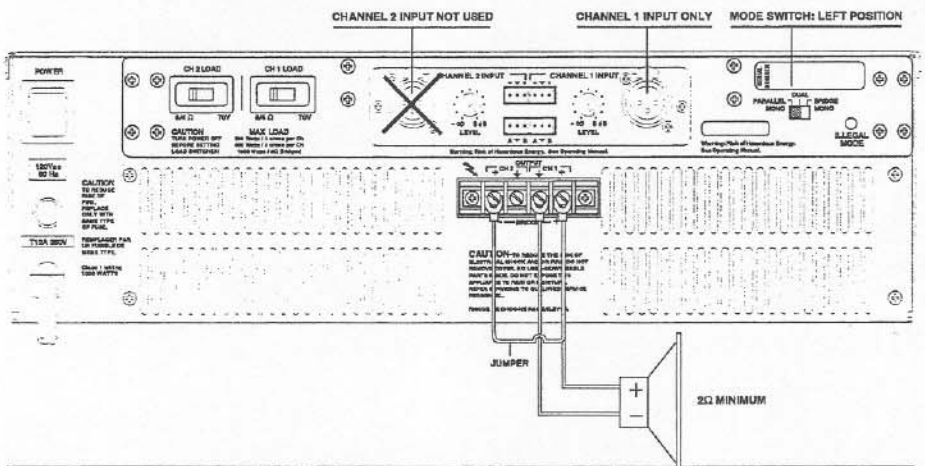

Figure 9 Parallel Mono Connections

Parallel Mono - This configuration provides the means to increase the current delivered to a single speaker load by shorting the outputs together (Figure 9). Both channels are combined to create one power amplifier that has the equivalent power capacity of both channels. Do not make the mistake however of assuming that for example, an AP2800 in parallel mono mode driving a single 8-ohm load will deliver 800 watts. It will still deliver 400 watts with a 0 dBu input signal. The advantage of parallel mono is the ability to double the power into a 4-ohm load (800 watts) as well as deliver still more power into 2 ohms (1000 watts) without overheating or current limiting. For distributed 70-volt line applications, parallel mono mode allows

WARNING: The load switches must be set in tandem when operating in parallel mono mode. If one load switch is set for 70-volt and the other is set for 8/4 ohms while in this mode, the protection logic will disable channel one. See "ILLEGAL MODE" for more information.

loading the amplifier for the full rated power of both channels on a single 70-volt line. The signal source is connected to the channel-one input only. The channel-2 input is disabled.

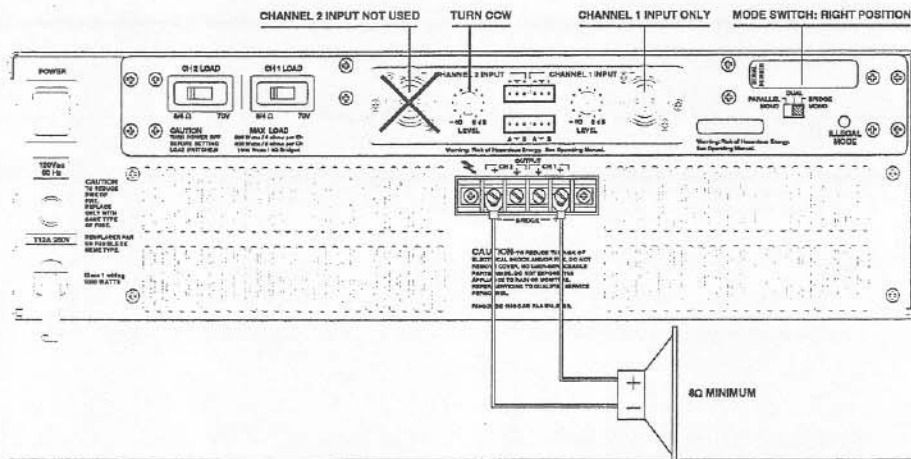

Figure 10 Bridged Mono Connections

Bridged Mono - In this mode a single speaker load is connected across the amplifier outputs (Figure 10). For proper operation the signal source is connected to the channel-one input. The channel-two input level should be fully counterclockwise. In this mode the amplifier is providing a true balanced output.

For 8/4-ohm load configuration, the load impedance should not be less than 8 ohms. A 70-volt load configuration in bridged mono mode allows driving a 100-volt distributed system* or a 140-volt system.

*input sensitivity must be adjusted to -3 dBu (0.549 V rms)

ILLEGAL MODE PROTECTION

Illegal mode protection is provided to guard against an improper mono-mode setting. When the amplifier is set in either bridged or parallel mono, both channels are combined as one power stage to drive the speaker load. It is necessary that each amplifier's load switch is configured identically since it is driving the same load. To avoid problems, the protection logic will sense an improper condition and disable both channels. Both channel 1 Standby LEDs on the front panel will turn on. In addition the "ILLEGAL MODE" LED on the rear panel will also turn on. The amplifier will remain in this mode until both load switches are identically set, or dual mode is selected.

70 VOLT OPERATION

70-volt line operation provides a means to drive multiple sets of speakers without the confusion and complexity of adjusting the final load impedance. The term 70-volt refers to the output rms voltage delivered by the amplifier (it is actually 70.7 Vrms). By comparison, the output voltage for an AP2800 into an 8-ohm load with an input of 0 dBu is 56.6 volts rms. When the amplifier load switch is changed to the 70-volt position, two things happen. One is that the gain is increased so that an input of 0 dBu results in an output of 70.7 volts rms. The second is that the amplifier power supply voltage is adjusted to accommodate this output level.

CAUTION: Unlike the other modes where the speaker load has one terminal connected to ground, bridged mono mode provides a differential "floating" signal to the speaker load and therefore any test equipment that is used to measure this signal should also have a floating ground.

WARNING: The load switches must be set in tandem when operating in bridged mono mode. If one load switch is set for 70-volt while the other is set for 8/4 ohms while in this mode, the protection logic will disable both channels. See "ILLEGAL MODE PROTECTION" for more information.



WARNING: Do not use the 70-volt position as a method for increasing gain to a low impedance load. When the supply voltage is increased for 70-volt operation, there must be a corresponding increase in the load impedance. Otherwise the resulting high voltage and increased current will cause the amplifier to overheat and shut down.

This type of system requires a speaker that includes a small power converting transformer. Each speaker is rated not by its load impedance but by the power that it consumes from the amplifier. For example, if you have speakers that have a 70-volt rating of 10-watts each then you can parallel forty of these speakers to each channel of a AP2800 amplifier. The total power is evenly distributed among each speaker. Even if several speakers are disconnected from the line, the remaining speakers will still only consume 10 watts each. The power can also be unevenly distributed. For example ten 20-watt speakers can be paralleled with twenty 10-watt speakers as long as the total power does not exceed that of the amplifier that is driving the 70-volt line. In this case each 20 watt speaker will be 3 dB louder than the 10 watt speakers. The relatively high impedance of a 70-volt line allows longer cable runs to remote speakers (see "OUTPUT CABLE SELECTION", "CALCULATING POWER LOSSES" and "DAMPING FACTOR" for more details on the affects of cable length on a speaker system). Any amplifier that drives a 70-volt line must be capable of providing an output of 200 volts peak to peak. This is why many amplifiers require expensive step-up transformers. The AP2800 can drive the 70-volt line direct without using step-up transformers. A 140-volt system can be directly driven using the bridged mono mode. A 100-volt system can be driven in bridged mono mode if the input signal is reduced to -3 dBu (0.549 V rms). A 100-volt system would require speakers that are designed with transformers that have a 100-volt input tap. Likewise a 140-volt system would require speakers that are designed with transformers that have a 140-volt input tap.

INSTALLATION

The amplifier may be installed in a standard 19 inch equipment rack. The AP2800 requires 133.4 mm (5.25 in.) of vertical rack space and 425.5 mm (16.75 in.) of depth. The amplifier secures to the rack cabinet with four rack mount screws and cup washers provided in the hardware kit.

WARNING: Do not operate the amplifier within a completely closed unventilated housing.

VENTILATION

The amplifier must be adequately ventilated to avoid excessive temperature rise. The air is drawn from front to back therefore a rear ventilated cabinet should be used. If the amplifier shuts down due to elevated temperatures then the equipment should be spaced at least 44 mm (1.75 in.) apart or a blower installed to provide sufficient air movement within the cabinet.

OUTPUT CABLE SELECTION

Speaker wire size plays an important part in quality sound systems. Small wire gauges can waste power and reduce the damping factor at the speaker terminals. This can add coloration and muddiness to the sound. To help offset this problem Tables II and III have been assembled to enable you to calculate the power losses in the speaker cable.

CALCULATING POWER LOSSES

To calculate the total power loss in the speaker cable, multiply the power loss per foot of the 2-wire cable using the appropriate table below by the length of the cable in feet. For example, suppose an installer uses 160 feet of 12 gauge 2-wire cable with an 8-ohm speaker system connected to a AP2800 amplifier. The total power loss in the cable is:

$$\text{Total Power Loss} = 0.162 \text{ watts/foot} \times 160 \text{ feet} = 25.9 \text{ watts}$$

Does this mean that whenever the amplifier produces 400 watts of output power, 374.1 watts (400 watts minus 25.9 watts) will be delivered to the 8 ohm load? NO! The actual load impedance is 8 ohms plus the resistance of the cable ($0.00324 \times 160 \text{ feet} + 8 = 8.52 \text{ ohms}$). Because of the change in the load impedance, the actual total power produced by the amplifier is 374.1 watts. The power delivered to the load is approximately 374.1 watts minus 25.9 watts or 348.2 watts.

TABLE II AP2800 Power Losses per foot in 2-wire Speaker Cable

Ω AWG	2 (1000W)*	4 (500W) 8 (1000W)**	8 (400W)	16(200W)	70V (400W) 140V (800W)**
6	0.405	0.101	0.041	0.005	0.026
8	0.605	0.151	0.061	0.008	0.040
10	1.020	0.255	0.102	0.013	0.067
12	1.620	0.405	0.162	0.020	0.106
14	2.575	0.644	0.258	0.032	0.168
16	4.095	1.024	0.410	0.051	0.267
18	6.510	1.628	0.651	0.081	0.425
20	10.350	2.588	1.035	0.129	0.676

*Parallel Mono **Bridged Mono



DAMPING FACTOR

The higher the damping factor of an amplifier, the greater the ability of the amplifier to control unwanted speaker cone movements. When a signal drives a woofer, current flowing through the voice coil creates a magnetic field. This field interacts with the permanent magnetic field in the gap and forces the combination cone and voice coil assembly to move outward. When the signal is removed, the assembly moves inward but its momentum causes it to overshoot its resting point. This overshoot will dampen itself out eventually but the unwanted movements can add considerable distortion to the sound. In the process of moving inward through the magnetic field, the voice coil assembly generates a current of opposite polarity to the original signal. This current induces a voltage or "back EMF" which travels through the speaker wire to the amplifier's output. The lower the amplifier source impedance, the faster the overshoot of the voice coil will dampen out. The source impedance of an amplifier can be calculated by dividing the rated output impedance, typically 8 ohms, by the damping factor. The source impedance of the AP2800 is 0.032 ohms.

Cable Selection for Specified Damping Factor at the Load.

The damping factor rating of the amplifier is typically never realized at the load because of the resistance of the cable. The damping factor at the load should be 30 for general paging systems and 50 for high-fidelity music systems. Economics usually dictate however that these numbers are cut in half. The resulting damping factor at the load should be based on experience and customer satisfaction. Once a minimum damping factor is determined for a particular type of installation, the following equation can be used to calculate the maximum length of two-wire cable which can be used to achieve the minimum damping factor specified at the load:

$$\text{Max Length} = \frac{\frac{ZL}{DF} - Z_o}{DCR}$$

ZL = load impedance

Z_o = Amplifier source impedance

DF = minimum permissible damping factor

DCR = dc resistance per foot of the 2-wire cable (Table III)

For 70-volt systems ZL can be approximated as:

$$ZL = 70.7^2/P_{out}$$

P_{out} = Amplifier rated power

For 100-volt systems ZL = 100²/P_{out}

For 140-volt systems ZL = 141.4²/P_{out}

Suppose ZL equals 4 ohms, Z_o = 0.032 ohms (AP2800) and the minimum damping factor at the load is to be 25. In addition, 18 GA cable is preferred. Then the maximum length of cable which can be used to achieve a damping factor of 25 at the load is:

$$\text{Max Length} = ((4/25) - 0.032) / 0.01302 = 9.83 \text{ feet}$$

Suppose you would like to calculate the maximum length of 2-wire cable using the same conditions as above except now you are using a 70V system instead of an 8 ohm system. For a 400 watt 70-volt system, ZL = 70.7²/400 = 12.5 ohms. Using the above calculation for a minimum DF of 25:

$$\text{Max Length} = ((12.5/25) - 0.032) / 0.01302 = 36 \text{ feet}$$

A 140-volt 400 watt system using the same conditions as above would allow over 151 feet of 18 gauge cable. In each case, the total power loss in the cable is

TABLE III DC Resistance for 2-wire cable

AWG	DCR (Ω/ft)	DCR (Ω/m)
6	0.00081	0.00264
8	0.00121	0.00421
10	0.00204	0.00669
12	0.00324	0.01063
14	0.00515	0.01691
16	0.00819	0.02685
18	0.01302	0.04289
20	0.02070	0.06764
22	0.03292	0.10658

roughly the same (between 14 and 16 watts) even though the cable length was extended from 9.83 to 151 feet! This illustrates the advantage of high-voltage systems for distributed sound.

SPEAKER PROTECTION

Sometimes it may be desirable to use in-line fuses to protect loudspeaker systems (Figure 11). It is difficult however to determine the proper fuse value with the correct time lag and overload characteristics to match the limitations of a speaker system. Fuse values are shown for the given power and load in Table IV. The values are calculated for fast-blow fuses which carry 135% of their current rating for an hour but will blow within 1 second at 200%. Other fuse values may be calculated for different power levels from the following equation:

$$\text{Fuse Value} = \frac{\sqrt{P_{out} \cdot Z_L}}{Z_L \cdot 1.35}$$

P_{out} = rated power of amplifier

Z_L = load impedance

TABLE IV Speaker Protection Fuse Chart

Power (Watts)	4Ω	8Ω	16Ω
100	3.70	2.62	1.85
150	4.54	3.21	2.27
200	5.24	3.70	2.62
300	6.42	4.54	3.21
400	7.41	5.24	3.70
500	8.28	5.85	4.14

Compression drivers are much more susceptible to damage from low frequencies than large cone loud-speakers. Even though an electronic crossover may be employed, problems may arise in the cables between the crossover and the power amplifier, or from misadjustment of the crossover. Either of these situations could apply low frequency signals or hum to the driver and cause damage. To prevent a potential problem, Electro-Voice® recommends using a capacitor between the amplifier and the compression driver to suppress low frequencies and possible dc. Refer to the example in Figure 12.

In choosing a value, one must be careful not to interfere with the crossover frequency. As a general rule, select a capacitor whose break frequency with respect to the load is 3 dB down at approximately 1/2 of the high pass corner frequency. Mylar capacitors with at least a 100 volt ac rating are recommended. Table V shows the recommended capacitor values for use with 8 and 16-ohm drivers at common crossover frequencies.

TABLE V. Protection Capacitor Sizes for Common Cross-Over Frequencies

X-over Freq	8 Ohm	16 Ohm
500 HZ	80 uF	40 uF
800 HZ	50 uF	25 uF
1000 HZ	40 uF	20 uF
1250 HZ	33 uF	16 uF
2000 HZ	20 uF	10 uF
3150 HZ	12 uF	6 uF
6300 HZ	6 uF	3 uF

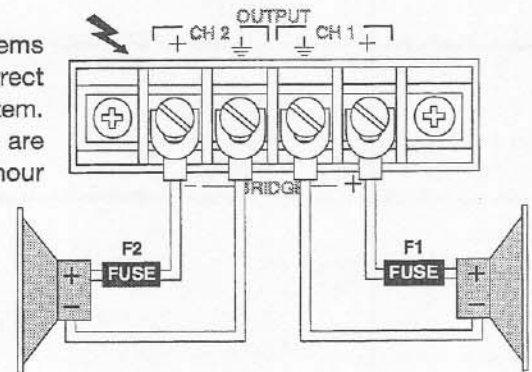

Figure 11 Optional protection fuse connection

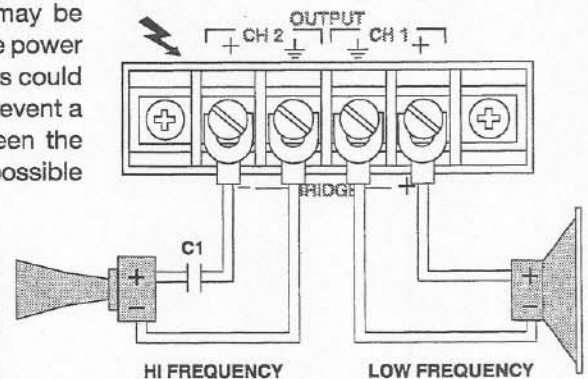

Figure 12 BIAMP connection with driver protection capacitor



Electro-Voice®

Operation Manual for the Model AP2800

SERVICE INSTRUCTIONS

CAUTION - NO USER SERVICEABLE PARTS INSIDE. EXTREMELY HAZARDOUS VOLTAGES AND CURRENTS MAY BE ENCOUNTERED WITHIN THE CHASSIS. THE SERVICING INFORMATION CONTAINED WITHIN THIS DOCUMENT IS ONLY FOR USE BY ELECTRO-VOICE® AUTHORIZED WARRANTY REPAIR STATIONS AND QUALIFIED SERVICE PERSONNEL. TO AVOID ELECTRIC SHOCK, DO NOT PERFORM ANY SERVICING OTHER THAN THAT CONTAINED IN THE OPERATING INSTRUCTIONS UNLESS YOU ARE QUALIFIED TO DO SO. OTHERWISE, REFER ALL SERVICING TO QUALIFIED SERVICE PERSONNEL.

SERVICE INSTRUCTIONS

CAUTION - NO USER SERVICEABLE PARTS INSIDE. EXTREMELY HAZARDOUS VOLTAGES AND CURRENTS MAY BE ENCOUNTERED WITHIN THE CHASSIS. THE SERVICING INFORMATION CONTAINED WITHIN THIS DOCUMENT IS ONLY FOR USE BY ELECTRO-VOICE® AUTHORIZED WARRANTY REPAIR STATIONS AND QUALIFIED SERVICE PERSONNEL. TO AVOID ELECTRIC SHOCK, DO NOT PERFORM ANY SERVICING OTHER THAN THAT CONTAINED IN THE OPERATING INSTRUCTIONS UNLESS YOU ARE QUALIFIED TO DO SO. OTHERWISE, REFER ALL SERVICING TO QUALIFIED SERVICE PERSONNEL.

Notice: Modifications to Electro-Voice® products are not recommended. Such modifications shall be at the sole expense of the person(s) or company responsible, and any damage resulting therefrom shall not be covered under warranty or otherwise.

Note: If you need to verify the performance of the amplifier against the rated specifications, you must be able to maintain the ac line voltage constant at 120 V ac. Therefore, we recommend a suitably rated variac (50 ampere rating at 120 V ac).

DC OFFSET TRIM PROCEDURE

The following adjustments are best performed after the amplifier has warmed up. First remove the top cover by the 6 access screws along the front and back (Figure 13). Refer to figure 14 for the following procedure.

1. With the amplifier in dual mode, turned on and no signal, locate trim pot R7 on the Driver PCB
2. Adjust for an output of zero volts dc, +/- 1 mV, measured at the channel-1 output speaker terminals.
3. Repeat step 2 adjusting R26, measured at the channel-2 output speaker terminals.

IDLE CURRENT TRIM PROCEDURE

The following adjustments are made on the main power amplifier board. This board can be exposed by removing the four access screws at the four corners on the rear panel and raising the driver board assembly (Figure 13). Each channel is a grounded bridge configuration. Since a grounded bridge consists of 2 amplifier stages for each output, there are 2 independent idle adjustments for each channel. One is for the high side amplifier that drives the positive output terminal and the other is for the low side amplifier which sinks or sources the return path (ground terminal). Refer to Figure 15 for the following procedures.

1. The Channel-1 high side bias is adjusted with R102 for a dc voltage measure of 5 mV, +/- 0.1 mV across the outside legs of R108.
2. The Channel-1 low side bias is adjusted with R125 for a dc voltage measure of 5 mV, +/- 0.1 mV across the outside legs of R122.
3. The Channel-2 high side bias is adjusted with R202 for a dc voltage measure of 5 mV, +/- 0.1 mV across the outside legs of R208.
4. The Channel-2 low side bias is adjusted with R225 for a dc voltage measure of 5 mV, +/- 0.1 mV across the outside legs of R222.

NOTICE: Repairs performed by other than authorized warranty stations (Dealers) or qualified personnel shall void the warranty period of this unit. To avoid loss of warranty, see your nearest Electro-Voice® authorized dealer, or call Electro-Voice® Customer Service directly at 1-800-234-6831 or FAX 616-695-4743 or write:

Electro-Voice® Customer
Service
600 Cecil Street,
Buchanan, MI 49107
USA



IT SIGNAL CALIBRATION
Equipment Required:

- 1 kHz sine wave generator
- True RMS AC/DC Volt Meter (four digit)
- 4.0 Ω Resistive Load 2% tolerance (500W)

I/OUT SENSE AND AUDIO OUT (MONITOR) SIGNAL CALIBRATION.

1. Be sure that the amplifier power is off.
2. Set the mode switch on the back panel to the dual (center) position.
3. Set the load switches for both channels in the 8/4 Ω (left) position.
4. Connect the 4.0 Ω load to the output terminals of channel one.
5. Connect the output of the generator to the input of channel one. The generator level should be off until you are ready to calibrate.
6. Turn the power amplifier on and increase the generator level (1 kHz sine wave) for an output measure of 44.72 Vrms.
7. While delivering this voltage to the 4.0 Ω load, adjust R35 (R36/ch2) of the driver pcb for 4.50 Vdc, measured on pin 7 of U3 (pin 7, U9/ch2). See figure 14 for trim pot locations.
8. Turn generator signal off.
9. Turn the power amplifier off and disconnect the 4.0 Ω load.
10. Turn the power amplifier on and increase the generator level (1 kHz sine wave) for an output measure of 56.57 Vrms.
11. While delivering this voltage to the unloaded output of the amplifier, adjust R120 (R152/ch2) of the driver pcb for .775 Vrms (AC) measured on pin 1 of U2 (pin1, U8/ch2). See figure 14 for trim pot locations.
12. Repeat the above steps for channel two. Trim pot and IC references for channel two are in parenthesis.

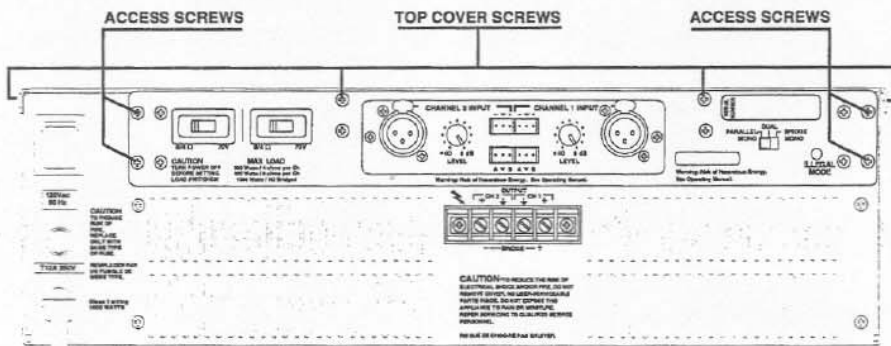

Figure 13 Access screws

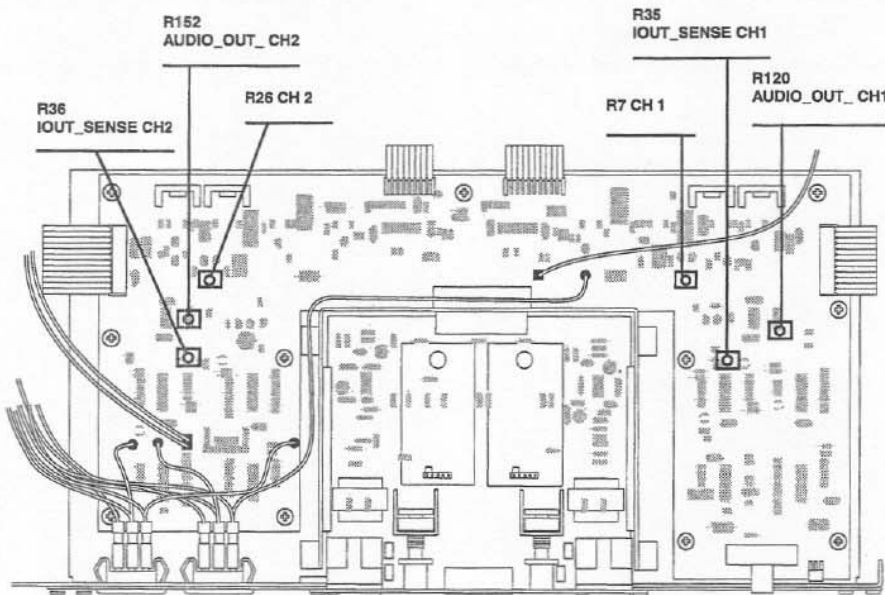

Figure 14 DC bias and IT calibration trim pot locations

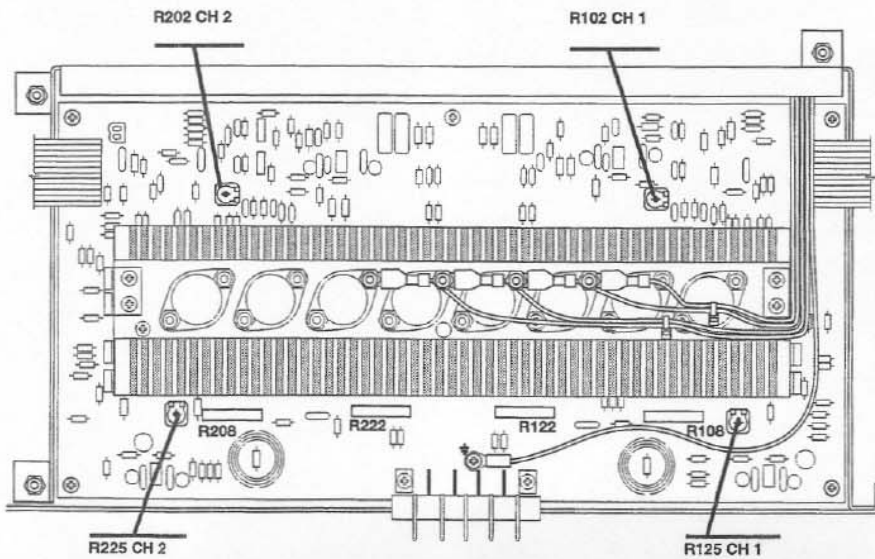
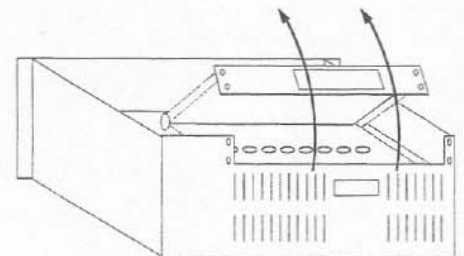

Figure 15 Idle current trim pot locations





INPUT CARD PIN ASSIGNMENTS

The input module connects to the amplifier via a 30-pin connector (reference designator J1A of the input board schematic). The amplifier provides various signals and controls through this connector. The following is a brief description of each pin-function.

PIN#	NAME	FUNCTION
1	VOUT_SENSE_CH1	0 to 5 Volt DC signal that represents the load voltage for channel 1.
2	VOUT_SENSE_CH2	Same as above but for channel 2.
3	IOUT_SENSE_CH1	0 to 5 Volt DC signal that represents the load current for channel 1.
4	IOUT_SENSE_CH2	Same as above but for channel 2.
5	TEMP_CH1	0 to 5 Volt DC signal that indicates the channel 1 heat sink temperature. Scale is 25 to 100°C.
6	TEMP_CH2	Same as above but for channel 2.
7	AUDIO_OUT_CH1	Channel one output scaled down for 0 dBu full scale. Can be used for monitoring or line out.
8	AUDIO_OUT_CH2	Same as above but for channel 2.
9	STANDBY_CH1	Control signal turns channel 1 power supply on by forcing pin to agnd. Normally it is connected to the channel 1 fault signal pin 17.
10	+15V	15 volt DC supply with 100 mA capacity.
11	STANDBY_CH2	Same as pin 9 but for channel 2.
12	-15V	-15 volt DC supply with 100 mA capacity.
13	CLIP_CH1	0 to 8 volt signal. Indicates a clip condition by going high (> 4 volts).
14	+6V	6 volt DC supply with 800 mA capacity reference only to DGND.
15	CLIP_CH2	Same as pin 13 but for channel 2.

PIN#	NAME	FUNCTION
16	DGND	Reference for 6 volt DC supply (pin 14).
17	FAULT_CH1	Normally connected to STANDBY_CH1. Indicates either critical temperature, over-current, output DC or shorted output devices by going high (> 5 volts). Normally this signal is low (< 1 volt). It is referenced to AGND.
18	DGND	Same as pin 16.
19	FAULT_CH2	Same as pin 17 but for channel 2.
20	DGND	Same as pin 16.
21	POWER_CTL	Shorting this pin to DGND will power down the entire amplifier with the exception of the 6 volt DC supply.
22	AGND	Analog, fault and +15 volt supply ground reference.
23	AUDIO_IN_CH2	Input to power amplifier. Unbalanced and referenced to AGND. Sensitivity is 0.775 Vrms.
24	AGND	Same as pin 22.
25	AGND	Same as pin 22.
26	AGND	Same as pin 22.
27	AUDIO_IN_CH1	Same as 23 but for channel 1.
28	AGND	Same as pin 22.
29	CHASSISGND	Connects to the chassis ground inside of the amplifier.
30	CHASSISGND	Same as above.

SCHEMATIC/INPUT BOARD

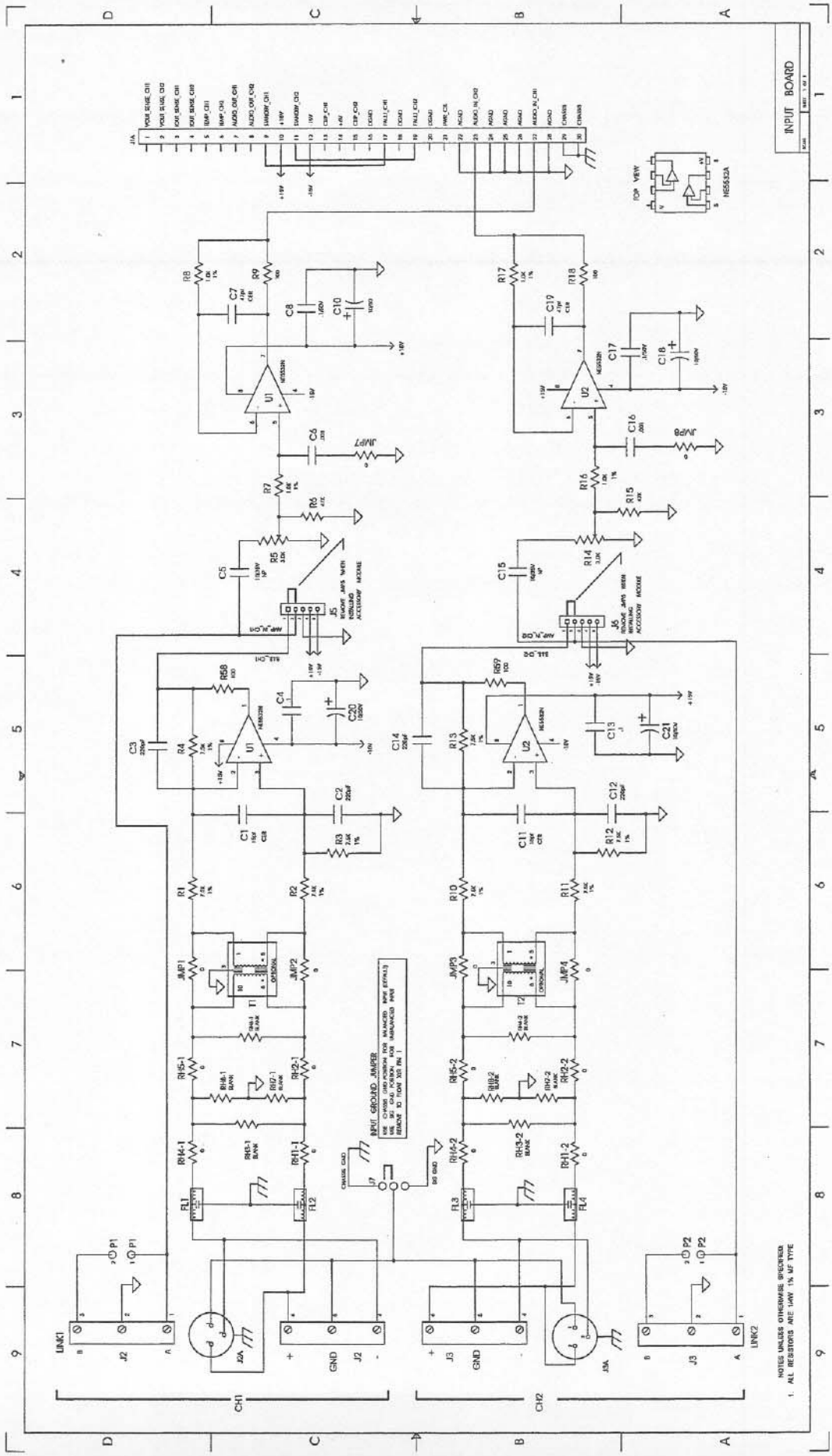



Electro-Voice®

FACTORY SERVICE

If there is not an authorized service representative in your area you can ship the unit in its original packing prepaid to:

**Electro-Voice®
Customer Service**
600 Cecil Street
Buchanan, MI 49107
USA

OR

**Electro-Voice®
Customer Service**
9130 Glenoaks blvd
Sun Valley, CA 91352
USA

For a listing of authorized service representatives write to:

Electro-Voice® Customer Service
600 Cecil Street
Buchanan, MI 49107
USA

or call: 1-800-234-6831 or FAX 616-695-4743

To obtain warranty service, a customer must deliver the product, prepaid, to Electro-Voice® Customer Service or any of its authorized service representatives together with proof of purchase of the product in the form of a bill of sale or receipted invoice.

TECHNICAL ASSISTANCE

For applications assistance or other technical information, call: 1-800-234-6831

ACCESSORIES

For information on accessories contact
Electro-Voice® Customer Service at
1-800-234-6831 or FAX 616-695-4743

© 1997 by Electro-Voice,® Inc. All rights reserved worldwide.