

Electro-Voice®

a MARK IV company

Model AP3200 Two-Channel Power Amplifier

SPECIFICATIONS

Conditions:

1. 0 dBu = 0.775 V rms.
2. Dual-mode ratings are for each channel.
3. Both channels operating at rated output power unless noted.
4. 120-volt ac line voltage maintained throughout testing.

Continuous Rated Output Power (20 Hz-20 kHz, 30 kHz measurement bandwidth),

- Dual Mode, 4 Ohms:**
600 watts/ch at <0.10% THD
- Bridge Mode, 8 Ohms:**
1200 watts at <0.10% THD
- Dual Mode, 8 Ohms:**
400 watts/ch at <0.05% THD
- Bridge Mode, 16 Ohms:**
800 watts at <0.05% THD

Continuous Rated Output Power to Subwoofer (20 Hz-1 kHz at less than 0.1% THD),

- Dual Mode, 4Ω:** 650 watts/ch
- Bridge Mode, 8Ω:** 1300 watts
- Dual Mode, 8Ω:** 420 watts/ch
- Bridge Mode, 16Ω:** 840 watts

Maximum Midband Output Power (reference 1 kHz, 1% THD),

- Dual Mode, 4 Ohms:**
725 watts/ch
- Bridge Mode, 8 Ohms:**
1450 watts
- Dual Mode, 8 Ohms:**
450 watts/ch
- Bridge Mode, 16 Ohms:**
900 watts

Dynamic Headroom (reference 1 kHz, 1% THD),

- Any Mode:**
≥ 0.25 dB

Power Bandwidth (+0, -1 dB, reference 0 dB at 1 kHz, where 0 dB ref. = rated output power in any mode),
20 Hz-20 kHz

Frequency Response (ref. 1 kHz, 1 watt output, +0, -3 dB):
10 Hz - 90 kHz

Voltage Gain (reference 1 kHz),
Dual Mode, 4 or 8 Ohms:
36 dB
Bridge Mode, 8 or 16 Ohms:
42 dB

Input Sensitivity for Rated Output Power (reference 1 kHz),

- Dual Mode, 4 Ohms:**
+0.2 dBu (0.79 V rms)
- Bridge Mode, 8 Ohms:**
+0.2 dBu (0.79 V rms)
- Dual Mode, 8 Ohms:**
+1.4 dBu (0.91 V rms)
- Bridge Mode, 16 Ohms:**
+1.4 dBu (0.91 V rms)

Maximum Input Level (reference 1 kHz):
+20 dBu (7.75 V rms)

Input Impedance (per channel, 20 Hz-20 kHz),

- Balanced:**
> 30 kilohms
- Unbalanced:**
> 15 kilohms

**Phase Response
(at rated output power, any mode),**
at 20 Hz:
< +25 degrees
at 20 kHz:
> -15 degrees

THD (at rated output power, 30 kHz measurement bandwidth),
Any Mode:
< 0.10%

IMD [SMPTE 4:1] (at rated output power),
Any Mode:
< 0.05%

TIM [DIN 100] (at rated output power),
Any Mode:
< 0.05%

**Rise Time
(10% to 90%, at rated output power),**
Any Mode:
< 6 μsec

Slew Rate (at rated output power),
Dual Mode, 4 or 8 Ohms:
> 30 V/μsec
Bridge Mode, 8 or 16 Ohms:
> 60 V/μsec

Damping Factor,
Dual Mode, 8 Ohms,
20 Hz-1 kHz: > 250
20 kHz: > 75

Channel Separation (below rated output power, single channel operating):
> 80 dB at 1 kHz

Noise (below rated output power, A weighted, any mode):
> 100 dB

Amplifier Protection:
Excessive output voltage
Shorted loads
Excessive phase shift
RF interference
Over temperature

Load Protection:
Startup/shutdown transients
dc fault
Infrasonic signals
Low ac line voltage

Cooling:
2-speed fan

Output Topology:
True complementary symmetry

Output Type,
Dual Mode: Unbalanced, each channel
Bridge Mode: Balanced

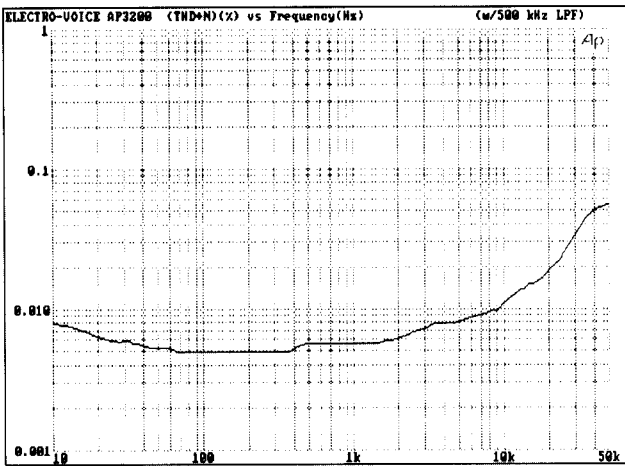

THD + NOISE VS. FREQUENCY

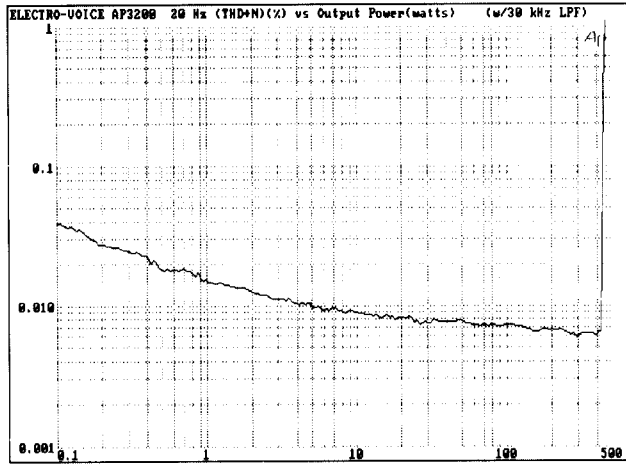

THD + NOISE VS. POWER (20 Hz)

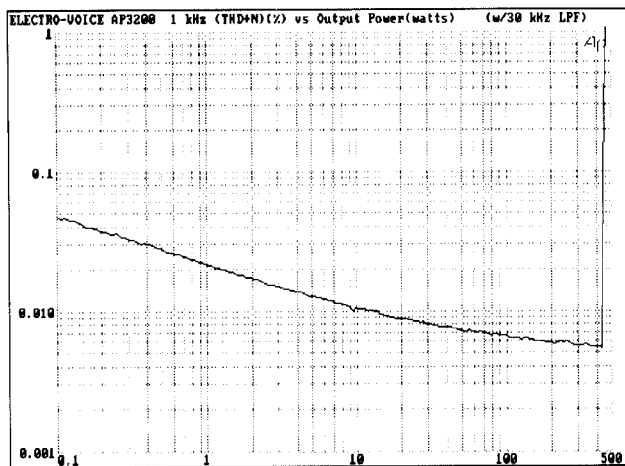

THD + NOISE VS. POWER (1 kHz)

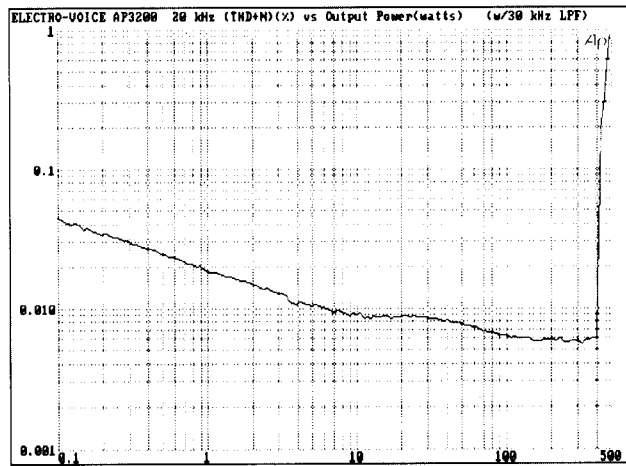

THD + NOISE VS. POWER (20 kHz)

FIGURE 1 — THD + Noise vs. Frequency/Power
(one channel operating at rated output into 8 ohms)

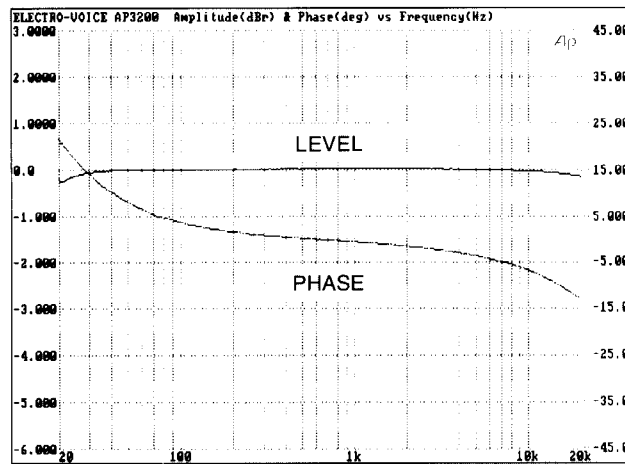

LEVEL + PHASE VS. FREQUENCY

FIGURE 2 — Level + Phase vs. Frequency
(one channel operating at rated output into 8 ohms)

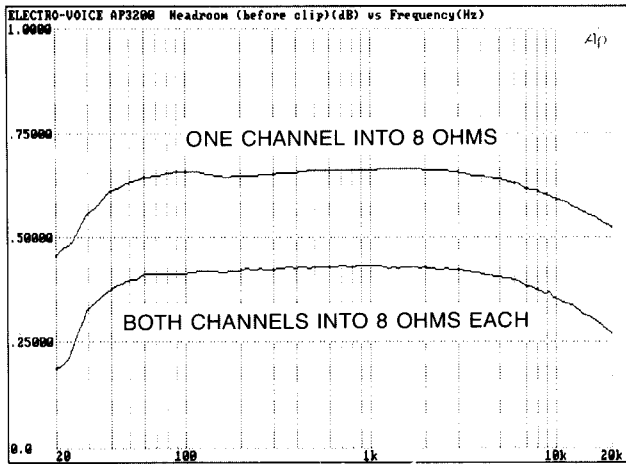

HEADROOM BEFORE CLIPPING VS. FREQUENCY

FIGURE 3 — Headroom in dB vs. Frequency
(0.0 dB referenced to 400-watt output power)

Output Devices (32, both channels),

$P_{d_{max}}$: 250 watts
I_c: 16 A dc
V_{ceo}: 250 V dc
T_{j_{max}}}: 200°C (392°F)

Controls and Switches,

Input Level Controls (two)-Rear:

Continuously variable

Dual/bridged mode switch-rear

Power switch-front

Front-Panel Indicators:

Power LED
Clip LED's (two)
Protect LED's (two)

Connections,

Input:

6-terminal barrier strip
Female XLR-type connectors (two)
Octal accessory sockets (two)

Output:

4-terminal barrier strip

Power:

3-terminal IEC ac line receptacle

Power Requirements:

120 V ac, 50/60 Hz, 1800 watts
(configurable to 240 V ac)
100 V ac, 50/60 Hz model available

Power Consumption/Heat Produced (both channels operating dual mode with 1 kHz input signal at stated output power into 4 ohms, or bridge mode into 8 ohms),

1/3 Power:

1800 watts/4.465 kBTU/hr

Rated Power:

2520 watts/4.488 kBTU/hr

Maximum Midband Power:

2700 watts/4.216 kBTU/hr

Operating Temperature Range:

Up to 60 degrees C
(140 degrees F) ambient

Dimensions,

Height: 13.3 cm (5.25 in.)
Width: 48.3 cm (19 in.)
Depth: 40.8 cm (15.75 in.)

Color:

Black

Enclosure:

Rack mount chassis
16-GA steel
3/16-inch 6061-T6 aluminum front panel

Shipping Weight:

28.1 kg (62 lb)

Net Weight:

23.6 kg (52 lb)

Supplied Items:

One owner's manual
One detachable power cord
Four "U" jumper plugs for octal sockets

Optional Accessories:

The octal sockets permit a variety of plug-in accessories to be used with the amplifier. The options are listed below:

APM-1 bridging input transformer with optional resistive padding
APL-125 low-pass module, 125 Hz
APL-500 low-pass module, 500 Hz
APL-800 low-pass module, 800 Hz

APL-1250 low-pass module, 1250 Hz
APH-125 high-pass module, 125 Hz
APH-315 high-pass module, 315 Hz
APH-500 high-pass module, 500 Hz
APH-800 high-pass module, 800 Hz
APH-1250 high-pass module, 1250 Hz
APX two-way crossover module,
24 dB/octave, freq. selectable
50 Hz-10 kHz.

APX-2 crossover module, as APX with separate high-pass output for other amplifiers

CX1 two-way crossover module, 24 dB/octave, switch-selectable high-frequency attenuation and 500 or 800 Hz crossover, resistive-selectable other crossover frequencies, and choice of modules for horn EQ and low-frequency signal delay

Five output impedance matching devices are available:

TR150 150-watt 70-volt line transformer
TR300 300-watt 70-volt line transformer
TR600 600-watt 70-volt line transformer
AT300 300-watt multi-tap auto-transformer
AT100 100-watt multi-tap auto-transformer

INSTALLATION

Unpacking

Upon receipt of the unit, inspect the shipping carton for possible damage during transit. If damage is found, notify the transportation company immediately. Should damage occur during shipping, it is the responsibility of the consignee to initiate a claim with the carrier.

*** CAUTION ***

No user serviceable parts inside.

Hazardous voltage and currents may be encountered within the chassis. The service information contained within this document is for use only by Electro-Voice, Inc., authorized warranty stations and qualified service personnel. To avoid electric shock, do not perform any servicing unless you are qualified to do so.

DESCRIPTION

The AP3200 is a dual-channel power amplifier for professional sound reinforcement.

Each channel delivers 400 watts of continuous average power into 8 ohms or 600 watts into 4 ohms over full audio frequency range. In the bridge mode, the amplifier can deliver more than 1200 watts at less than 0.10% THD into 8 ohms.

Each channel is independently protected against . . .

- Over temperature
- Excessive output voltage
- Excessive phase shift
- Radio-frequency interference
- Shorted loads

The load is protected from startup/shutdown transients, infrasonic signals, low ac line voltage, and dc. When a problem is detected, an output relay automatically

disconnects the load from the channel and illuminates the Protect LED located on the front panel.

The AP3200 has electronically balanced inputs and accessory sockets for plug-in transformers and electronic modules. The level controls are rear mounted to avoid accidental changes. The standard power transformer permits operation at 120/240 V ac, 50/60 Hz. A 100-V-ac, 50/60-Hz model is available. The Electro-Voice AP3200 power amplifier is the choice for serious professional installations which demand the highest quality at high power levels for extended periods of time.

ARCHITECTS' AND ENGINEERS' SPECIFICATIONS

The power amplifier shall be a dual-channel model of solid-state design employing true complementary-symmetry output circuitry and capable of operating from a 120/240 V ac, 50/60 Hz ac line. 100 V ac, 50/60 Hz is available. The amplifier shall contain sensing circuitry to provide protection for the output transistors against over temperature, excessive output voltage, radio-frequency interference, shorted loads, and excessive output phase shift. The load shall be similarly protected against infrasonic signals, startup/shutdown transients, low ac line voltage, and dc.

Rear-mounted panel controls shall include a two-position mode switch for selecting between the dual monophonic mode or the bridged monophonic mode, and individual input level controls. Input connections for each channel shall include an octal socket for use with an optional plug-in input bridging transformer or electronic accessory modules, a 3-pin female XLR-type connector, and a barrier-strip connector. Output terminals shall be a barrier-strip connector.

Front panel indicators shall include an illuminated power on/off indicator, individually illuminated clipping indicators (Clip), and individually illuminated protection-circuit-activation indicators (Protect). The front panel control shall be the power on/off switch.

The power amplifier shall meet the following performance criteria. Maximum input voltage: 7.75 V rms. Input voltage for rated output power into 4 ohms: 0.79 Vrms. Rated output power per channel: 600 watts into 4 ohms from 20 Hz to 20 kHz at less than 0.10% THD; 400 watts into 8 ohms from 20 Hz to 20 kHz at less than 0.05% THD; 1200 watts into an 8-ohm bridged load from 20 Hz to 20 kHz at less than 0.10% THD with channel #1 driven. Voltage amplification in dual mode: 36 dB. Hum and noise: at least 100 dB (A weighted) below rated output power. Frequency response: 20 Hz to 20 kHz, ± 1 dB at any output power up to rated output power. Damping factor: greater than 250 at any frequency up to 1 kHz in dual mode with 8-ohm load.

ARCHITECTS' AND ENGINEERS' SPECIFICATIONS (continued)

Transient intermodulation distortion (DIN 100): less than 0.05% in dual mode into 8 ohms. Intermodulation distortion (SMPTE): less than 0.05% in dual mode into 8 ohms. Crosstalk: more than 80 dB below rated output power. Operating temperature range: up to 60 degrees C (140 degrees F) ambient. Dimensions: 5.25"Hx19"Wx 15.75"D. Net weight: 52 pounds. Color: black. Enclosure: rack mounted chassis; 16GA steel bottom/sides; 3/16" 5052 aluminum front panel.

The power amplifier shall be the Electro-Voice AP3200.

WARRANTY (Limited)

Electro-Voice Professional Sound Reinforcement Electronic Components are guaranteed for two years from date of original purchase against malfunction due to defects in workmanship and materials. If such malfunction occurs, unit will be repaired or replaced (at our option) without charge for materials or labor if delivered prepaid to the proper Electro-Voice service facility. Unit will be returned prepaid. Warranty does not extend to finish, appearance items or malfunction due to abuse or operation under other than specified conditions, nor does it extend to incidental or consequential damages. Some states do not allow the exclusion or limitation of incidental or consequential damages, so the above exclusion may not apply to you. Repair by other than Electro-Voice or its authorized service agencies will void this guarantee. A list of authorized service centers is available from Electro-Voice, Inc., 600 Cecil Street, Buchanan, MI 49107 (AC/616-695-6831); or Electro-Voice West, 8234 Doe Avenue, Visalia, CA 93291 (AC/209-651-7777). This warranty gives you specific legal rights, and you may also have other rights which vary from state to state.

Specifications subject to change without notice.

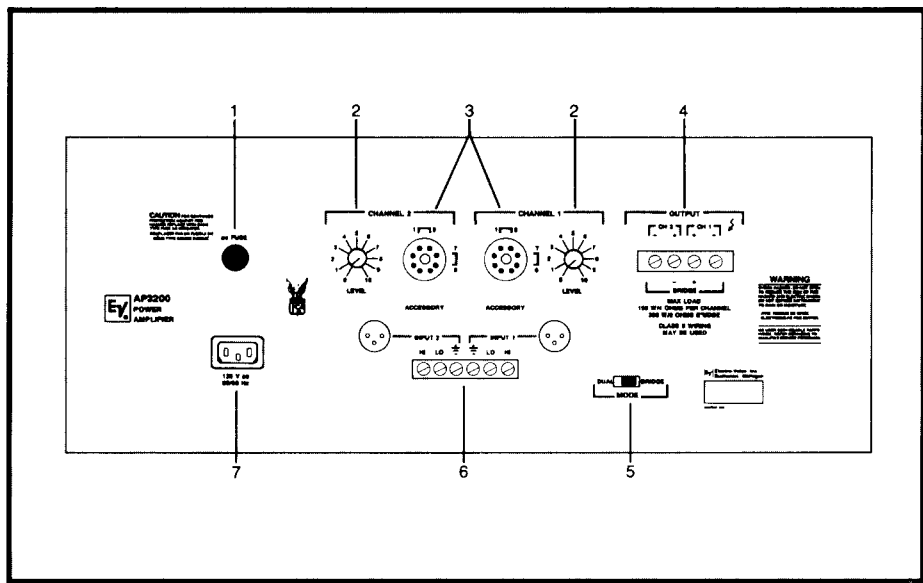

BACK PANEL LAYOUT

Figure 4 illustrates the items described below:

1. **AC FUSE RECEPTACLE:** This holder requires a Littelfuse type 3AB, 15 amp, 1250-volt SLO-BLO® 326 series ceramic cartridge body, or equivalent

SLO-BLO® is a registered trademark of Littelfuse, Inc.
2. **INPUT ATTENUATORS:** These controls adjust the input levels for both channels.
3. **ACCESSORY SOCKETS:** These octal sockets allow the use of several accessories. See the SPECIFICATIONS section for a listing of all compatible accessories.

4. **CHANNEL OUTPUT CONNECTIONS:** This terminal strip is for speaker connections, either in the dual or bridge mode.
5. **MODE SWITCH:** This switch enables either the dual or bridge mode of operation.
6. **CHANNEL INPUT CONNECTIONS:** Differential input connections can be made to either the terminal strip or the XLR-type connectors.
7. **POWER CORD RECEPTACLE:** This receptacle is for the supplied three-prong male power cord.



Electro-Voice®
POWER AMPLIFIER

OWNER'S OPERATION AND SERVICE MANUAL



AP3200 POWER AMPLIFIER

Table of Contents

1 ELECTRICAL	1
1.1 120 V ac, 50/60 Hz Power Connections	1
1.2 230/240 V ac, 50/60 Hz Power Connections	1
2 INSTALLATION	1
2.1 Rack Mounting	1
2.2 Ventilation	1
3 SIGNAL CONNECTIONS	2
3.1 Input Connections	2
3.2 Line Output Connections	2
3.3 Output Connections	2
3.4 Output Cable Selection	2
3.4.1 Calculating Power Losses with 8 ohm Loads	2
3.4.2 Calculating Power Losses with 4 ohm Loads	3
3.5 Damping Factor	3
3.5.1 Calculating the Maximum Length of Cable for a Specified Damping Factor	4
3.6 Speaker Protection Fuse Selection	4
3.7 Compression Driver Protection Capacitors	5
4 OCTAL ACCESSORY SOCKETS	5
5 PROTECTION SYSTEMS	6
5.1 Load Protection Circuitry	6
5.2 Amplifier Protection Circuitry	6
5.3 Protect Indicator	6
6 OPERATION	6
6.1 Dual Mode of Operation	6
6.2 Bridge Mode of Operation	6
7 IN CASE OF PROBLEMS	6
8 SPECIFICATIONS	8
9 SERVICE INFORMATION	13
9.1 Trimpot Adjustments	13
9.2 Equipment Needed	13
9.3 Adjusting R39, the LF Cancel Trimpot	13
9.4 Adjusting R26, the BIAS Trimpot	13
9.5 Adjusting R23 and R24, the Negative and Positive Current Limit Trimpots	14
9.6 Checking the Short Circuit Current	15
9.7 Ordering Replacement Parts	15
9.8 Factory Service	15
9.9 Technical Assistance	15

1 ELECTRICAL

Two amplifier models are available. One model has a 50/60 Hz power transformer with two 120 V ac primary windings. These windings may be wired in parallel or series for operation at either 120 V ac or 220/240 V ac. The other amplifier model is for export into countries where the ac line voltage is 100 volts, 50/60 Hz. The next two sections refer to the first model with the dual 120 V ac primary windings.

1.1 120 V ac, 50/60 Hz Power Connections

The amplifier is provided with the primary of the power transformer strapped for 120 V ac operation from the factory. Refer to Figure 2a for the wiring details.

WARNING: Verify that the power transformer's primary circuit configuration is correct for the intended ac line voltage **BEFORE** applying power to the amplifier.

1.2 220/240 V ac, 50/60 Hz Power Connections

The power transformer has two 120 volt primary windings which can be connected in parallel for 120 V ac line voltages, or in series to meet 220/240 V ac requirements. Use the following procedures to re-strap the primary of the power transformer for 220/240 V ac applications.

1. Make sure the amplifier is not connected to any power source.
2. Remove and save the eleven screws securing the top cover. There are three screws on each side and three along the top-rear edge of the chassis. In addition, you must remove the two innermost screws inset into the top bumper strip. Refer to Figure 1 for

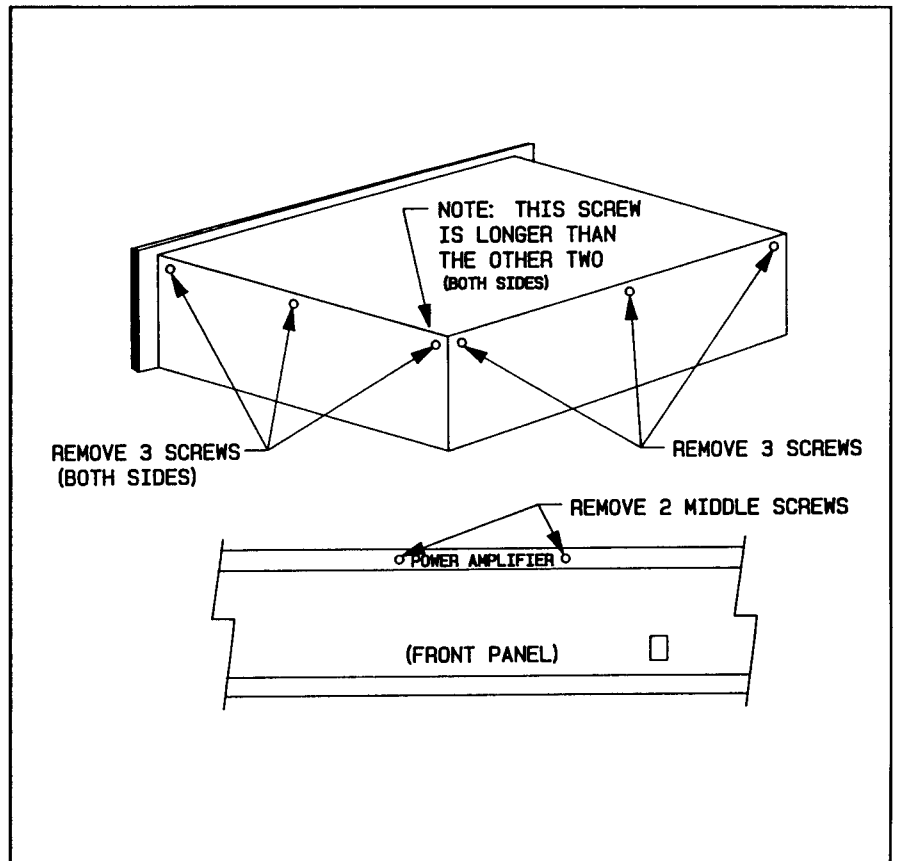

Figure 1 Top Cover Removal

3. Locate the barrier strip mounted on the top-rear edge of the power transformer. Referring to Figure 2b, reconnect the leads as shown.
4. Install the top cover with the eleven screws previously removed. Two screws are longer than the others removed from the sides and rear. These longer screws install into the rearmost position on each side of the chassis.
5. Install an 8 amp fuse, Littelfuse Type 3AB 8A/250V slo-blo® 326-series ceramic body or equivalent.

2 INSTALLATION

2.1 Rack Mounting

The amplifier may be installed in a standard 19 inch equipment rack. It requires 5¼ inches of vertical rack space and secures to the rack cabinet with the four rack mount screws and cup washers provided in the hardware kit.

2.2 Ventilation

The amplifier must be adequately ventilated to avoid excessive temperature rise. It should not be used in areas where the ambient temperature exceeds 60 °C (140 °F). To determine the ambient air temperature, operate the system in the rack until the temperature stabilizes. Measure the ambient air with a bulb-type thermometer held at the bottom

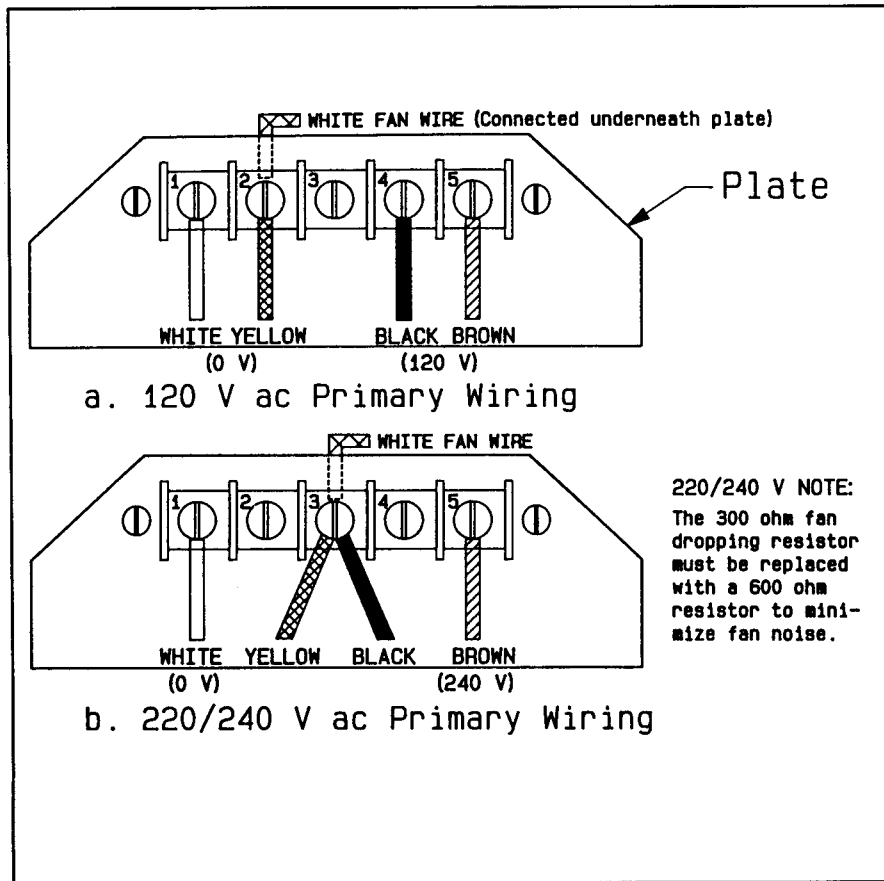

Figure 2 Primary Wiring Configuration for 120 V ac and 220/240 V ac

of the uppermost amplifier. Do not let the thermometer touch the metal chassis because the chassis will be hotter than the ambient air. If the air temperature exceeds 60 °C (140 °F), the equipment should be spaced at least 1.75 inches apart or a blower installed to provide sufficient air movement within the cabinet.

WARNING: Do not operate the amplifier within a completely closed unventilated housing.

3 SIGNAL CONNECTIONS

3.1 Input Connections

Balanced input connections may be made to either the barrier strip or the female XLR connectors. For single-ended inputs, strap the low (—) input to

ground (pin 3 on XLR). Otherwise, the electronically-balanced input stage will see 6 dB less input signal level than with a balanced input. Refer to Figure 3 for typical input connections.

3.2 Line Output Connections

The XLR and barrier strip connectors are wired in parallel. Pin 2 of the XLR is the (+) input on the barrier strip, and pin 3 is the (—) input. Since the input impedance of the electronically-balanced input stage is high (15 kohms), there is minimal loading on the signal source. When the input connections are made to one connector, the other may be used as an auxiliary line output to feed other high input impedance equipment. Refer to Figure 3 for possible applications.

3.3 Output Connections

Output connections are made to the four terminal barrier strip connector. Refer to Figure 4 for typical output connections.

3.4 Output Cable Selection

Speaker wire size plays an important part in quality sound systems. Small wire gauges can waste power and reduce the damping factor at the speaker terminals. This can add coloration and muddiness to the sound. To help offset this problem, Table I has been assembled to enable you to calculate the power losses in the speaker cable.

3.4.1 Calculating Power Losses with 8 ohm Loads

To calculate the total power loss in the speaker cable, multiply the power loss per foot (or meter) of the 2-wire cable selected from Table I by the length of the cable in feet (or meters). For example, suppose an installer uses 160 feet of 10 GA 2-wire cable with an 8 Ω speaker system. The total power loss in the cable is:

Total Power Loss in cable

$$= 0.1013 \text{ watts/foot} \times 160 \text{ feet} \\ = 16.2 \text{ watts}$$

Does this mean that whenever the amplifier produces 400 watts of output power, 383.8 watts (400 watts minus 16.2 watts) will be delivered to the 8 ohm load? NO! The actual load impedance is 8 ohms plus the resistance of the cable (0.00204 ohms/foot times 160 feet) for a total load impedance of 8.3264 ohms. At the 8 Ω rated output power, the output voltage is 56.57 V rms. Therefore, the amplifier produces 384.3 watts with this load instead of 400 watts. This was calculated by squaring the voltage and dividing

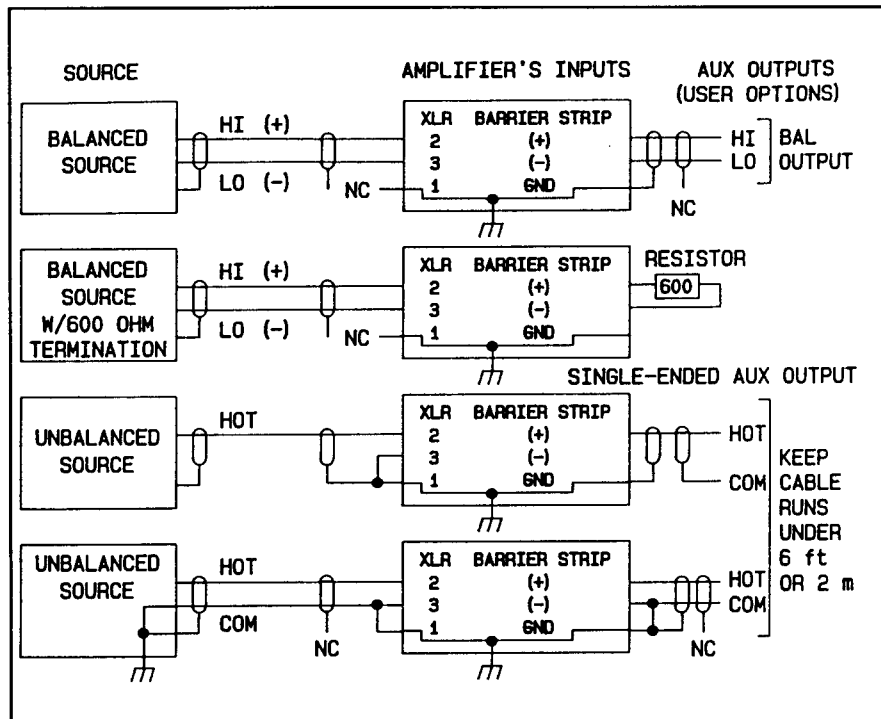

Figure 3 Typical Input Connections

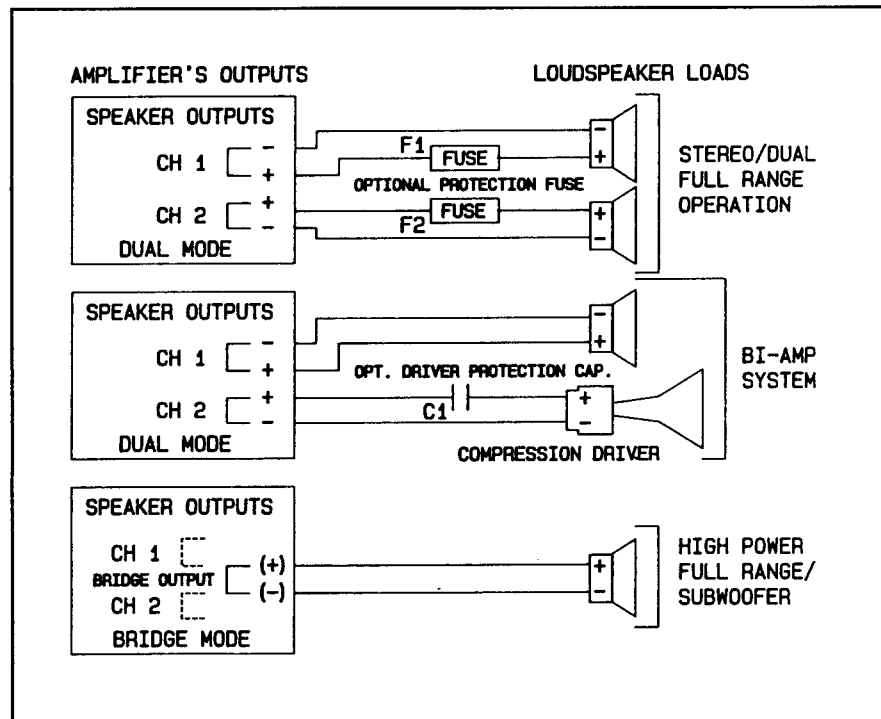

Figure 4 Typical Output Connections

by the load impedance (56.57^2 divided by 8.3264 ohms). As a result, the actual power delivered

to the load is 368.1 watts (384.3 watts minus 16.2 watts).

Had 18 GA wire been used in the above example, the loss in the cable would have been 100.8 watts. This example illustrates the importance of using the proper wire size.

3.4.2 Calculating Power Losses with 4 ohm Loads

To calculate the losses when using a 4 ohm speaker system, multiply the loss at 8 ohms by 3. In the above example, the 10 GA wire would consume 48.6 watts of power while the 18 GA wire would waste 302.5 watts - more than half of the amplifier's 4 ohm power rating.

3.5 Damping Factor

The higher the damping factor rating of an amplifier, the greater the ability of the amplifier to control unwanted speaker cone movements. When a signal drives a woofer, current flowing through the voice coil creates a magnetic field. This field interacts with the permanent magnetic field in the gap and forces the combination cone and voice coil assembly to move outward. When the signal is removed, the assembly moves inward but its momentum causes it to overshoot its resting point. This overshoot will dampen itself out eventually but the unwanted movements can add considerable distortion products to the sound.

In the process of moving inward through the magnetic field, the voice coil assembly generates a current of opposite polarity to the original signal. This current induces a voltage or "back EMF" which travels through the speaker wire to the amplifier's output. The lower the amplifier's output impedance, the faster the overshoot of the voice coil will dampen out. The output impedance of an amplifier can be calculated by dividing the rated output impe-

dance, typically 8 ohms, by the damping factor. The AP3200 has a damping factor rating of 250 which corresponds to an output impedance of 0.032 ohms.

3.5.1 Calculating the Maximum Length of Cable for a Specified Damping Factor Specification at the Load

The damping factor rating is typically never realized at the load because of the resistance of the cable (and other factors such as the contact resistance of an output relay or the resistance of an output fuse). The damping factor at the load should be 30 for general paging systems and 50 for high fidelity music systems. Economics usually dictate, however, that these numbers are cut-in-half. The resulting damping factor at the load should be based on experience and customer satisfaction. Once a minimum damping factor is determined for a particular type of installation, the following equation can calculate the maximum length of 2-wire cable which can be used to achieve the minimum damping factor specified at the load:

Max. Length of 2-wire cable in feet

$$= \frac{ZL - Zo}{DF} \text{ DCR/ft}$$

where

ZL is the load impedance to connect to the amplifier;

Zo is the amplifier's output impedance (0.032 ohms for the AP3200);

DF is the minimum permissible damping factor at the load; and

DCR/ft is the DC resistance of the 2-wire cable per foot from Table I.

The same equation can be used to

Table I AP3200 Power Losses in 2-wire Speaker Cable

AWG (GA)	DCR/ft (Ω/ft)	Power Loss/ft (watts/ft)	Cable Cross-Sectional area (mm ²)	DCR/meter (Ω/m)	Power Loss/meter (watts/m)
6	0.00081	0.0402	13.30	0.00264	0.1314
8	0.00121	0.0603	8.36	0.00421	0.2082
10	0.00204	0.1013	5.26	0.00669	0.3288
12	0.00324	0.1606	3.31	0.01063	0.5175
14	0.00515	0.2542	2.08	0.01691	0.8108
16	0.00819	0.4011	1.31	0.02685	1.2567
18	0.01302	0.6303	0.82	0.04289	1.9319
20	0.02070	0.9834	0.52	0.06764	2.8752
22	0.03292	1.5185	0.33	0.10658	4.1497

calculate the maximum cable length in meters by substituting the DCR per meter value from Table I.

Let's use the equation. Suppose ZL equals 8 ohms, Zo = 0.032 ohms, and the minimum damping factor at the load is 25. In addition, 18 GA cable is preferred. Then, the maximum length of 18 GA cable which can be used to achieve a damping factor of 25 at the load is:

$$\frac{8 - (0.032)}{25} \div 0.01302 \text{ } \Omega/\text{ft} = 22.1 \text{ feet}$$

Sometimes it may be necessary to locate the speaker 100 feet or more away from the amplifier. In this situation, a much larger gauge cable is required. However, this may not be practical or economical. The size of the 2-wire cable can be greatly reduced by stepping up the output voltage of the amplifier to 70, 100, 140, or 210 volt, using an output transformer, then stepping down the voltage at the load. Such a system is shown in Figure 5.

The maximum length of 2-wire cable in this situation can be approximated from the following equation:

Max. Length of 2-wire cable in feet

$$\frac{V^2}{(\text{Pout})(\text{DCR/ft})} \left(\frac{1}{\text{DF}} - \frac{Zo}{ZL} \right)$$

where

V is the stepped-up voltage of the system;
 Pout is the rated output power of the amplifier;
 Zo is the output impedance of the amplifier (0.032 ohms for the AP3200);
 ZL is the load impedance;
 DCR/ft is the DC resistance of the 2-wire cable per foot from Table I; and
 DF is the minimum permissible damping factor at the load.

Suppose a 210 volt system were used at a 1200 watt power level to drive an 8 ohm load with a minimum damping factor of 25. Using the same 18 GA cable as before, the maximum length can now be 102 feet. Power companies use this technique to transfer large amounts of power over great distances.

3.6 Speaker Protection Fuse Selection

Sometimes it may be desirable to use in-line fuses (fuses in series with the output)

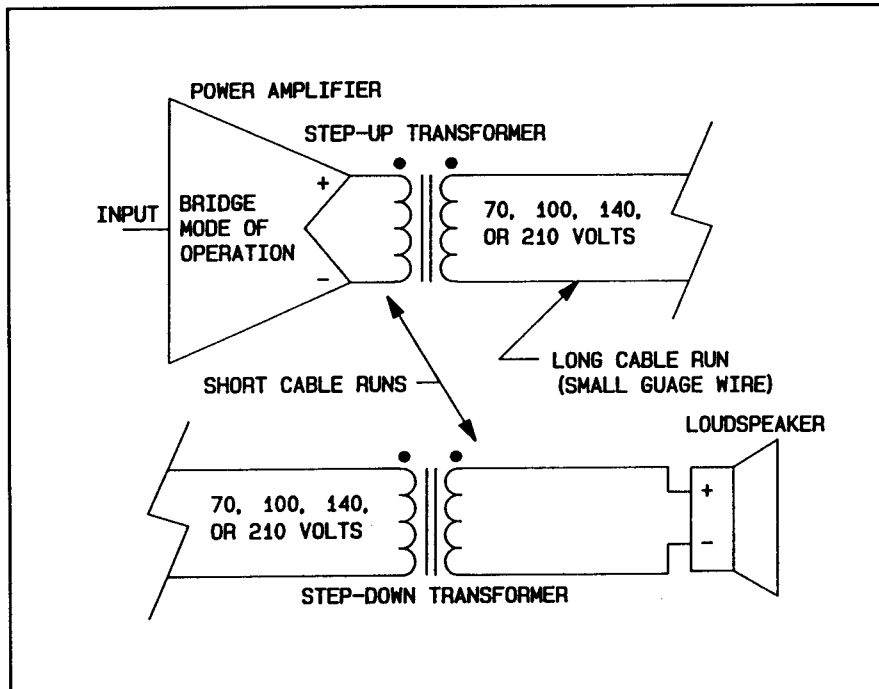

Figure 5 High-voltage Distribution System

to protect loudspeaker systems (or the amplifier). It is difficult, however, to determine the proper fuse value with the correct time lag and overload characteristics to match the limitations of a speaker system. The values shown in Table II should serve only as a guide. To use, determine the power rating and load value. Then, select a standard value fuse of the next smaller value to the one listed in the table.

The values are calculated for fast-blow fuses which carry 135% of their current rating for an hour but will blow within 1 second at 200%. Other fuse values may be calculated for different power levels from the following equation:

$$\text{Fuse value} = \frac{(\text{Pout} \times \text{ZL})^{1/2}}{\text{ZL} \times 1.35} \text{ amps}$$

where

Pout is the output power rating of the amplifier; and

ZL is the load impedance. Use 32 volt fuses if possible; they typically have the lowest internal resistance which will help minimize deterioration of the damping factor at the load. Refer to the example in Figure 4.

Table II Calculated Output Fuse Values

Power (watts)	4 Ω Load	8 Ω Load	16 Ω Load
100	3.70	2.62	1.85
150	4.54	3.21	2.27
200	5.24	3.70	2.62
300	6.42	4.54	3.21
400	7.41	5.24	3.70
600	9.07	6.42	4.54

3.7 Compression Driver Protection Capacitors
Compression drivers, used for mid to high frequency sound reproduction, are much more susceptible to damage from low frequencies than large cone loudspeakers. Even though an electronic crossover may be employed,

problems may arise in the cables between the crossover and the power amplifier, or from misadjustment of the crossover. Either of these situations could apply low frequency signals or hum to the driver and cause damage. To prevent a potential mishap, Electro-Voice recommends using a capacitor between the amplifier and the compression driver to suppress low frequencies and possible DC. Refer to the example in Figure 4.

In choosing a value, one must be careful not to interfere with the crossover frequency. As a general rule, select a capacitor whose break frequency, with respect to the load, is 3 dB down at approximately 1/2 of the high pass corner frequency.

Mylar capacitors with at least a 100 volt ac rating are recommended. Table III shows the recommended capacitor values for use with 8 and 16 ohm drivers at popular crossover frequencies.

Table III Compression Driver Protection Capacitors

Crossover Frequency	8 Ω Driver	16 Ω Driver
500 Hz	80 μF	40 μF
800 Hz	50 μF	25 μF
1000 Hz	40 μF	20 μF
1250 Hz	33 μF	16 μF
2000 Hz	20 μF	10 μF
3150 Hz	12 μF	6 μF
6300 Hz	6 μF	3 μF

4 OCTAL ACCESSORY SOCKETS

Two octal sockets permit a variety of plug-in accessories to be used with the amplifier. Normally, one "U" jumper is inserted between octal socket pins 8 and 1, and another between pins 7 and 6. These jumpers must remain in place for the amplifier to operate when not using any accessory

modules. To use with an accessory module, remove (and save) the jumpers and install the module making sure the key on its center post aligns with the groove in the female socket. For operation, refer to the instructions provided with the module. Schematically, the module will be inserted between the input connector and the balanced input stage.

Electronic modules are powered from a bipolar 15 volt supply in the amplifier. The supply is capable of supplying up to 25 ma DC of current. Currents in excess of 25 ma DC may prevent the amplifier from disengaging from its built-in protection mechanisms.

5 PROTECTION SYSTEMS

5.1 Load Protection Circuitry

Each channel independently protects its load from startup/shutdown transients, DC, and large subsonic signals.

5.2 Amplifier Protection Circuitry

A unique current-limiting circuit was designed specifically for the amplifier. It features a variable current limit which is a function of the output signal voltage. As a result, the amplifier can deliver the rated currents into rated loads but substantially limits the current into low impedance or shorted loads (shorted output terminals). Once the short is removed, however, the amplifier will resume normal operation.

A dual speed fan is also incorporated to provide efficient cooling under the most demanding conditions. When the heatsink temperature at the fin tips reaches approximately 88 °C (190 °F), the fan automatically switches to high speed operation. As the temperature cools to approximately 78 °C

(172°F), low speed operation is once again resumed.

The heatsink is also thermally equalized to prevent the output devices nearest the fan from operating at a cooler temperature than the devices at the opposite end. This minimizes the thermal gradient across the heatsink and forces the devices to operate at more nearly the same temperature. This equalizes the lifetimes and reliability characteristics of the output devices so that no one device becomes the weak link in the chain.

Should the heatsink temperature of a channel remain excessively high, the affected channel will shut down automatically. When the output devices cool to a safe operating temperature, the channel will automatically resume normal operation.

5.3 Protect Indicator

The "PROTECT" LED does not turn-on abruptly as others may do; its intensity is allowed to vary. As a result, its degree of brightness serves as a relative indicator of the severity of the current operating conditions e.g., the brighter the LED, the greater the stress on the channel(s). This provides a visual notification well in advance of any impending shutdown.

Although the channel may still operate with the LED apparently at full brightness, a total shutdown will occur within a few seconds unless the operating conditions improve. If a shutdown does occur, the channel will resume normal operation as soon as its devices have cooled to an acceptable temperature.

6 OPERATION

6.1 Dual Mode of Operation

In the dual mode of

operation, the channels may be operated independently. After installation and hookup, verify that the mode switch, located on the rear panel, is in the "DUAL" position and rotate the level controls fully counterclockwise (full attenuation). Input a 0 dBu (0.775 V rms) nominal signal level and apply power. Slowly increase the level controls until the desired output power is obtained. If either "CLIP" LED illuminates, reduce the output with the channel level control or reduce the input signal level at its source.

WARNING: *Never attempt to connect the outputs of the two channels in parallel.*

6.2 Bridge Mode of Operation

After installation and hookup, verify that the mode switch, located on the rear panel, is in the "BRIDGE" position. Rotate both level controls fully counterclockwise (full attenuation). Input a 0 dBu (0.775 V rms) nominal signal level into channel 1 only and apply power. Slowly increase the level control of channel 1 until the desired output power is obtained. If either "CLIP" LED illuminates, reduce the output level with the level control or reduce the input signal level at its source.

CAUTION: *Be sure that no input connections are made to channel 2 and that its level control is fully counterclockwise (OFF).*

WARNING: *The bridged output mode provides a true balanced-to-ground output. Do not use any test equipment to test or evaluate this amplifier which does not have floating grounds.*

7 In Case of Problems

Please check the following items:

1. Verify that the amplifier

is properly connected to an ac power source and that the source is active.

2. Verify that the input connections are properly made. Refer to Figure 3.
3. Verify that the output connections are properly made. Refer to Figure 4.
4. Check the input and output cables for proper wiring and continuity.
5. Check the signal source and the load.
6. Insure that the two jumpers for each octal socket are properly installed (if not using optional plug-in modules).
7. Insure that any accessory modules installed do not draw more than 25 ma DC of current.
8. Check that the mode switch is in the desired position.

**Electro-Voice Customer
Service/Repair
8324 Doe Avenue
Visalia, CA 93219 U.S.A.
Tel: (209) 651-7777
FAX: (209) 651-0164**

NOTICE: *Repairs performed by other than authorized warranty stations (Dealers) or qualified personnel shall void the warranty period of this unit. To avoid loss of warranty, see your nearest Electro-Voice authorized dealer, or call Electro-Voice Customer Service directly at (405) 324-5311, FAX (405) 324-8981, or write:*

**Electro-Voice Customer
Service/Repair
10500 W. Reno
Oklahoma City, OK 73128
U.S.A.**

**Electro-Voice Customer
Service/Repair
600 Cecil Street
Buchanan, MI 49107 U.S.A.
Tel: (616) 695-6831
FAX: (616) 695-1304**

8 SPECIFICATIONS

Conditions:

1. 0 dBu = 0.775 volts rms.
2. Dual mode ratings are for each channel.
3. Both channels operating at rated output power unless noted.
4. 120 volt ac line input voltage maintained for all tests unless noted.

Continuous Rated Output Power:

(20 Hz - 20 kHz at less than 0.1% THD)
 Dual mode, 4 Ω: 600 watts/ch
 Bridge mode, 8 Ω: 1200 watts
 Dual mode, 8 Ω: 400 watts/ch
 Bridge mode, 16 Ω: 800 watts

Continuous Rated Output Power to Subwoofer:

(20 Hz - 1 kHz at less than 0.1% THD)
 Dual mode, 4 Ω: 650 watts/ch
 Bridge mode, 8 Ω: 1300 watts
 Dual mode, 8 Ω: 420 watts/ch
 Bridge mode, 16 Ω: 840 watts

Maximum Midband Output Power:

(Ref. 1 kHz, 1% THD, @120 volts ac line voltage)
 Dual mode, 4 Ω: 700 watts/ch
 Bridge mode, 8 Ω: 1400 watts
 Dual mode, 8 Ω: 425 watts/ch
 Bridge mode, 16 Ω: 850 watts

(Ref. 1 kHz, 1% THD, @108 volts ac (10% sag))
 Dual mode, 4 Ω: 575 watts/ch
 Bridge mode, 8 Ω: 1150 watts
 Dual mode, 8 Ω: 350 watts/ch
 Bridge mode, 16 Ω: 700 watts

(Ref. 1 kHz, 1% THD, @100 volts ac (17% sag))
 Dual mode, 4 Ω: 500 watts/ch
 Bridge mode, 8 Ω: 1000 watts
 Dual mode, 8 Ω: 300 watts/ch
 Bridge mode, 16 Ω: 600 watts

Headroom (Before clip): ≥0.25 dB
 (Ref. 1 kHz, 1% THD, any mode)

Frequency Response: 10 Hz - 90 kHz
 (Ref. 1 kHz, 1 watt output, +0/-3 dB)

Power Bandwidth: 20 Hz - 20 kHz
 (Ref. 1 kHz, +0/-1 dBr where 0 dBr = rated output power in any mode)

Voltage Gain:

(Ref. 1 kHz)
 Dual mode, 4 Ω or 8 Ω: 36 dB
 Bridge mode, 8 or 16 Ω: 42 dB

Input Sensitivity for Rated Output Power:

(Ref. 1 kHz, ±0.25 dB)
 Dual mode, 4 Ω: +0.2 dBu (0.79 V rms)
 Bridge mode, 8 Ω: +0.2 dBu (0.79 V rms)
 Dual mode, 8 Ω: +1.4 dBu (0.91 V rms)
 Bridge mode, 16 Ω: +1.4 dBu (0.91 V rms)

Maximum Input Level: +20 dBu (7.75 V rms)
 (Ref. 1 kHz)

Input Impedance:

(Ref. 1 kHz)
 Balanced: 15 kΩ
 Unbalanced: 15 kΩ

Polarity:

Positive-going signal applied to pin 2 of XLR or (+) of barrier strip produces positive-going signal at (+) output terminal.

Phase Response:

(Any mode)
 20 Hz: <+25°
 20 kHz: >-15°

THD: <0.1% (Typ. <0.01%)
 (Any mode, 30 kHz measurement bandwidth)

IMD (SMPTE 4:1): <0.05% (Typ. <0.01%)
 (Any mode)

TIM (DIM 100): <0.05%
 (Any mode)

Rise Time: <6 μsec
 (Any mode, 10% to 90%)

Slew Rate:
 Dual mode, 4 or 8 Ω: >30 V/μsec
 Bridge mode, 8 or 16 Ω: >60 V/μsec

Damping Factor:
 (Dual mode, 8 Ω)
 20 Hz - 1 kHz: >250
 20 kHz: >75

Crosstalk: <80 dBr
 (Ref. 1 kHz, 0 dBr = rated output power into 8 ohms, single channel operating)

Noise: >100 dB
 (Below rated output power, A-weighting filter, 8 Ω dual mode, 50/60 Hz ac line frequency)

Operating and Service Instructions for the Electro-Voice AP3200 Power Amplifier

Amplifier Protection:	Shorted output terminals, Over-temperature, RF interference	Female XLR (x 2), Octal accessory socket (x 2), powered with ± 15 volts DC at 25 ma.
Load Protection:	Startup/shutdown transients, DC faults, Subsonic signals	Output: Power:
Cooling:	Heatsink:	4 terminal barrier strip 4 ft (1.22 m), 3-wire, 14 GA power cord with NEMA 5-15 plug Littelfuse Type 3AB 15 A/250 V Slo-Blo® 326-series ceramic cartridge body, or equivalent
Fan:	Thermally equalized 3/16 in aluminum black anodized heat-sink, 1 per channel Thermostatically controlled dual speed fan. Approximately 55 CFM at low speed and 105 CFM at high speed. Ball bearing fan has minimum life rating of 50,000 hours at 25 °C ambient temperature	Fuse Type:
Output Topology:	True complementary symmetry with grounded collectors (no mica insulators means better heat transfer)	Power Requirements:
Output Type:	Dual mode:	120 V ac, 50/60 Hz, 1800 watts (configurable to 220/240 V ac). 100 V ac, 50/60 Hz model available.
Bridge mode:	Unbalanced, each channel Balanced	Operating ac Voltage Range:
Output Devices:	Total number:	Operates from line voltages as low as 90 volts (at reduced output power) assuming a 120 V ac nominal line.
Pdmax rating:	32 devices	Power Consumption/ Heat Produced:
Vceo:	250 watts	(Both channels operating in dual mode with 1 kHz sinewave input signal at stated output power into 4 Ω loads)
Ic:	250 volts DC	idle:
Tjmax:	16 amps DC	100 watts/0.340 kBTU/h
Controls and Switches:	Rear:	1/8th max midband power:
Front:	Two input level controls, Mode switch Power switch	1440 watts/4.276 kBTU/h
Front Panel Indicators:	Power LED,	1/3rd max midband power:
Clip LED (x 2),	Protect LED (x 2)	1800 watts/4.465 kBTU/h
Connections:	Input:	Rated output power:
6 terminal barrier strip,	Dimensions (Rear of rack ears to max depth):	2,520 watts/4.488 kBTU/h
5.25 in H x 19 in W x	Operating Temperature Range:	Max midband power:
2.75 in D	Up to 60 °C (140 °F) ambient	2,700 watts/4.216 kBTU/h

Operating and Service Instructions for the Electro-Voice AP3200 Power Amplifier

	15.75 in D (13.3 cm H x 48.3 cm W x 40.1 cm D)	APL-125 Low Pass Filter, 125 Hz APL-500 Low Pass Filter, 500 Hz APL-800 Low Pass Filter, 800 Hz APL-1250 Low Pass Filter, 1250 Hz APH-125 High Pass Filter, 125 Hz APH-315 High Pass Filter, 315 Hz APH-500 High Pass Filter, 500 Hz APH-800 High Pass Filter, 800 Hz APH-1250 High Pass Filter, 1250 Hz CX-1 24 dB/Oct Link- witz-Riley Crossover with Delay and Horn EQ
Shipping Weight:	62 lbs (28.1 kg)	
Net Weight:	52 lbs (23.6 kg)	
Color:	Black	
Enclosure:	Rack mount chassis, 16 GA steel, 3/16 in 5052 aluminum alloy front panel	
Standard Accessories:	4 - "U" jumper plugs for octal sockets (2 per socket, installed) 1 - Operating Instr- uctions and Service Manual	
Optional Accessories:	APM-1 Input Brid- ging Transformer with Optional Res- istive Pad TR300 300 watt 70 volt Transformer TR600 600 watt 70 volt Transformer AT300 300 watt Auto- former APX 24 dB/oct Link- witz-Riley Crossover APX-2 24 dB/oct Linkwitz-Riley Crossover with External High Freq- uency Output	

Electro-Voice continually strives to improve products and performance. Therefore, the specifications are subject to change without notice.

Slo-Blo® is a registered trademark of Littelfuse, Inc.

ELECTRO-VOICE UNIFORM LIMITED WARRANTY STATEMENT

Electro-Voice electronics are guaranteed against malfunction due to defects in materials or workmanship for a period of three (3) years from the date of original purchase. If such malfunction occurs during the specified period, the product will be repaired or replaced (at our option) without charge. The product will be returned to the customer prepaid. Exclusions and limitations: (A) exterior finish or appearance; (B) certain specific items described in the individual product-line statement(s) below, or in the individual product data sheet or owner's manual; (C) malfunction resulting from use or operation of the product other than as specified in the product data sheet or owner's manual; (D) malfunction resulting from misuse or abuse of the product; or (E) malfunction occurring at any time after repairs have been made to the product by anyone other than Electro-Voice or any of its authorized service representatives. Obtaining warranty service: To obtain warranty service, a customer must deliver the product, prepaid, to Electro-Voice or any of its authorized service representatives together with proof of purchase of the product in the form of a bill of sale or receipted invoice. A list of authorized service representatives is available from Electro-Voice at 600 Cecil Street, Buchanan, MI 49107 (616) 695-6831 and/or Electro-Voice West at 8234 Doe Avenue, Visalia, CA 93291 (209) 651-7777.

Incidental and consequential damages excluded: Product repair or replacement and return to the customer are only remedies provided to the customer. Electro-Voice shall not be liable for any incidental or consequential damages including, without limitation, injury to persons or property or loss of use. Some states do not allow the exclusion or limitation of incidental or consequential damages so the above limitation or exclusion may not apply to you. Otherwise this warranty gives you specific legal rights, and you may also have other rights which vary from state to state.



AP3200 Power Amplifier

SERVICE INSTRUCTIONS

*** * * CAUTION * * ***

NO USER SERVICEABLE PARTS INSIDE. EXTREMELY HAZARDOUS VOLTAGES AND CURRENTS MAY BE ENCOUNTERED WITHIN THE CHASSIS. THE SERVICING INFORMATION CONTAINED WITHIN THIS DOCUMENT IS ONLY FOR USE BY ELECTRO-VOICE AUTHORIZED WARRANTY REPAIR STATIONS AND QUALIFIED SERVICE PERSONNEL. TO AVOID ELECTRIC SHOCK, DO NOT PERFORM ANY SERVICING OTHER THAN THAT CONTAINED IN THE OPERATING INSTRUCTIONS UNLESS YOU ARE QUALIFIED TO DO SO. OTHERWISE, REFER ALL SERVICING TO QUALIFIED SERVICE PERSONNEL.

9 SERVICE INFORMATION

WARNING: No user servicable parts inside. Extremely hazardous voltages and currents may be encountered within the chassis. The servicing information contained within this document is only for use by Electro-Voice authorized warranty repair stations and qualified service personnel. To avoid electric shock DO NOT perform any servicing other than that contained in the Operating Instructions unless you are qualified to do so. Otherwise, refer all servicing to qualified service personnel.

NOTICE: Modifications to Electro-Voice products are not recommended. Such modifications shall be at the sole expense of the person(s) or company responsible, and any damage resulting therefrom shall not be covered under warranty or otherwise.

9.1 Trimpot Adjustments

Figure 12 is a component layout of the main circuit board for one channel (both channels use the same board). The schematic of the amplifier is shown in Figure 13. Several trimpots are provided for adjustment. Resistor R26 adjusts the bias. Resistor R23 sets the negative current limit and resistor R24 sets the positive current limit. These two resistors also affect the symmetry of clipping. The LF Cancel trimpot, R39, minimizes distortion caused by ripple on the power supply lines.

9.2 Equipment Needed

To precisely adjust the trimpots, you must have the following equipment:

- 1 — Oscilloscope (Tektronix 2445 or equivalent)
- 1 — Distortion analyzer (Sound Technology 1700B or equivalent)

- 1 — 15 amp ac ammeter
- 1 — 2 Ω load rated at 1000 watts or one 4 Ω load rated at 750 watts
- 1 — 8 Ω load rated at 500 watts
- 1 — Small non-conducting flat-blade screwdriver or set of plastic TV alignment tools
- 1 — 12 in jumper cable with alligator clips on each end
- Miscellaneous handtools (to remove the top cover)

NOTE: If you need to verify the amplifier's performance against the rated specifications, you must be able to maintain the ac line voltage constant at 120 V ac (or 240 V ac if wired according to Figure 2b). Therefore, we recommend a suitably rated variac (50 ampere rating at 120 V ac).

9.3 Adjusting R39, the LF Cancel Trimpot

Shown in Figure 6 is a distortion waveform resulting from an improperly adjusted R39. Notice the near sawtooth appearance of the waveform. The trace in Figure 7 shows the resulting waveform after R39 is properly adjusted. Notice the reduction in ripple.

To adjust R39 for minimum ripple, follow the procedures below:

1. Turn power off and disconnect the unit from its power source. Make sure the unit is in the Dual mode with 8 Ω loads connected to each channel.
2. Remove the eleven screws securing the top cover. Refer to Figure 1 for the screw locations.
3. Connect the sinewave generator output of the anal-

alyzer to the input of Channel 1. Rotate the input level control of Channel 1 to its full clockwise position. Rotate the input level control of Channel 2 to its full counter-clockwise position.

4. Apply power to the amplifier and adjust the sine-wave generator for a 60 Hz, 0 dBu (0.775 V rms) output level. For this adjustment, it is not necessary to maintain a constant 120 V ac line input voltage under load.
5. Find R39 on the component layout in Figure 12. With a non-conducting or plastic-shaft screwdriver, adjust R39 for least amount of ripple as shown in Figure 7.
6. Repeat steps 3 through 5 for Channel 2.
7. Turn off the generator's output signal. If you have concluded with the test and alignment procedures, disconnect the amplifier from its power source and re-install the top cover with the eleven screws previously removed.

9.4 Adjusting R26, the BIAS Trimpot

Shown in Figure 8 is a distortion waveform resulting from an improperly adjusted R26. Notice the pronounced spikes at the crossover point in the waveform. The trace in Figure 9 shows the waveform with less pronounced spikes after R26 is properly adjusted.

To adjust R26 for the proper bias, follow the procedures below:

1. Turn power off and disconnect the unit from its power source. Make sure the unit is in the Dual mode with 8 Ω loads connected to each channel.
2. Remove the eleven screws securing the top cover. Refer to Figure 1 for the screw locations.
3. Connect the sinewave generator output of the analyzer to the input of Channel 1. Rotate the input level control of Channel 1 to its full clockwise position. Rotate the input level control of Channel 2 to its full counter-clockwise position.
4. Apply power to the amplifier and adjust the sinewave generator for a 1 kHz, 0 dBu (0.775 V rms) output level. For this adjustment, it is not necessary to maintain a constant 120 V ac line input voltage under load.
5. Find R26 on the component layout in Figure 12. Rotate the shaft of R26 slowly clockwise until the spikes are minimized in the distortion waveform as shown in Figure 9.
6. Repeat steps 3 through 5 for Channel 2.
7. Check the ac idle current draw. With both channels at idle, the ac line current should be approximately 1 amp or less. If the idle current draw exceeds 1 amp, rotate R26 counter-clockwise slightly on both channels until the idle current is no more than 1 amp.

8. Turn off the generator's output signal. If you have concluded with the test and alignment procedures, disconnect the amplifier from its power source and re-install the top cover with the eleven screws previously removed.

9.5 Adjusting R23 and R24, the Negative and Positive Current Limit Trimpots

Shown in Figure 11 is an asymmetrically clipped waveform caused by an improperly adjusted positive current limit as determined by R24. Had R23 been improperly adjusted, the negative half of the waveform would be clipped as well, but its degree of clipping is a function of R23 only and is independent of R24.

In the following procedures, you will be adjusting the current limit thresholds by varying R23 and R24 in such a way so as to insure symmetrical clipping.

1. Turn power off and disconnect unit from power source. Make sure the unit is in the Dual mode with a 2 Ω load connected to the channel under test. If you do not have a 2 Ω load, you may use a 4 Ω load or even an 8 Ω load. The higher the load impedance, however, the less likely it is you will have symmetrical clipping on peaks into lower impedance loads.
2. Remove the eleven screws securing the top cover. Refer to Figure 1 for the screw locations.
3. Connect the sinewave generator output of the analyzer to the input of Chan-

nel 1. Rotate the input level control of Channel 1 to its full clockwise position. Rotate the input level control of Channel 2 to its full counter-clockwise position.

4. Find R23 and R24 on the component layout in Figure 12. Reach into the amplifier and rotate the shafts of R23 and R24 to their full clockwise positions.

5. Apply power to the amplifier and adjust the sinewave generator for a 1 kHz, -10 dBu (0.245 V rms) output level. For this adjustment, it is not necessary to maintain a constant 120 V ac line input under load.

6. Increase the level of the generator until the output of the amplifier reaches 42.43 V rms (which corresponds to 900 watts output into the 2 Ω load).

The ac line current draw will be approximately 19 amps. Although the fuse installed is a 15 amp fuse, it should not blow during this test unless the amplifier is operated continuously for an extended period of time.

If a 2 Ω load is unavailable, use either the 4 or 8 Ω load and increase the generator output level accordingly to the corresponding rated output power.

7. While monitoring the distortion waveform on the oscilloscope, rotate R23 counter-clockwise until the negative half of the

waveform just begins to visibly clip (more pronounced spikes will appear on the distortion waveform). Then, rotate slightly clockwise just until the visible clipping disappears and the spikes in the distortion waveform reduce to their pre-clip level.

8. Repeat Step 7 for the positive current limit pot R24. You may have to slightly re-adjust R23.
9. If R23 and R24 are properly adjusted, the channel should clip symmetrically (@ 1% THD) at approximately 1000 watts as shown in Figure 11.
10. Repeat Steps 3 through 9 for Channel 2.
11. Turn off the generator's output signal. If you have concluded with the test and alignment procedures, disconnect the amplifier from its power source and re-install the top cover with the eleven screws previously removed.

9.6 Checking the Short Circuit Current

With one channel operating at full rated power into an 8 Ω load, carefully short the output terminals using the 12 inch jumper cable while monitoring the ac line current. The ac line current draw under a short circuit condition should be less than 3 amps (typically 1.5 to 2 amps). If it exceeds 3 amps, you need to re-adjust R23 and R24 by rotating them slightly counter-clockwise, both by approximately the same amount, until the ac line current is under 3 amps. Repeat this procedure for Channel 2.

9.7 Ordering Replacement Parts

To order replacement parts, look up the ordering number from the component parts listing and call (405) 324-5311, FAX (405) 324-8981, or write:

Electro-Voice
Replacement Parts Sales
600 Cecil Street
Buchanan, MI 49107 U.S.A.

9.8 Factory Service

If factory service is required, ship the unit in its original packing prepaid to:

Electro-Voice Customer
Service/Repair
600 Cecil Street
Buchanan, MI 49107 U.S.A.
Tel: (616) 695-6831
FAX: (616) 695-1304

Electro-Voice Customer
Service/Repair
8324 Doe Avenue
Visalia, CA 93219 U.S.A.
Tel: (209) 651-7777
FAX: (209) 651-0164

Enclose a note describing the problem in as much detail as possible. Include any additional helpful information such as test conditions, where used, how used, etc.

9.9 Technical Assistance

For applications assistance or other technical information, contact the Technical Services Manager. You can call (616) 695-6831, TWX 810-270-31353, FAX (616) 695-1304, or write:

Electro-Voice
Technical Services Manager
600 Cecil Street
Buchanan, MI 49107
U.S.A.

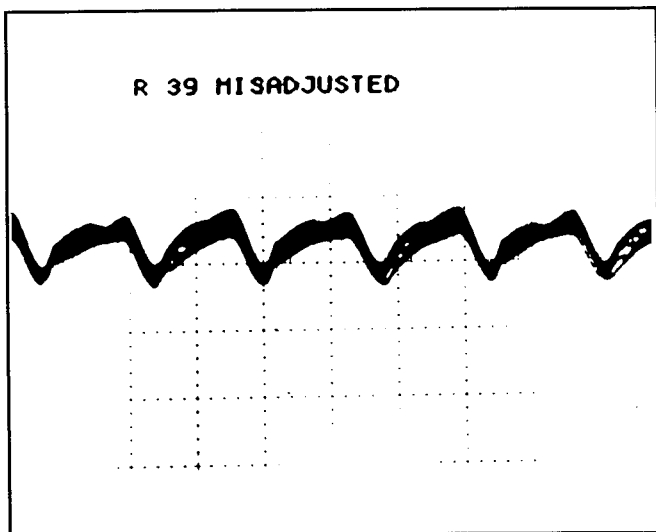

Figure 6 Results with Improperly Adjusted LF Cancel

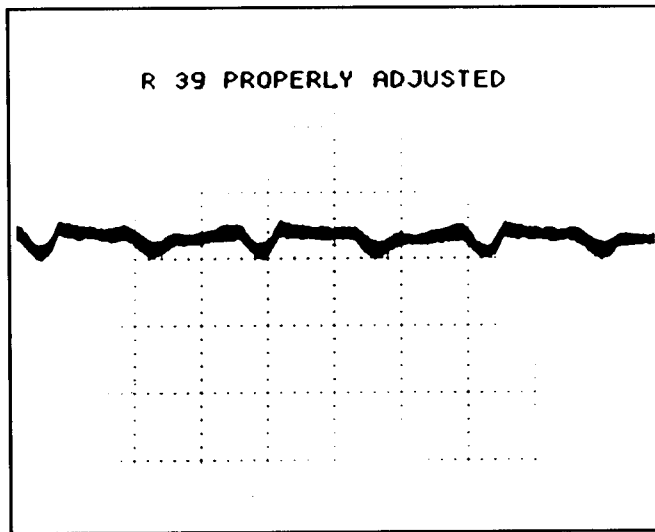

Figure 7 Results with Properly Adjusted LF Cancel

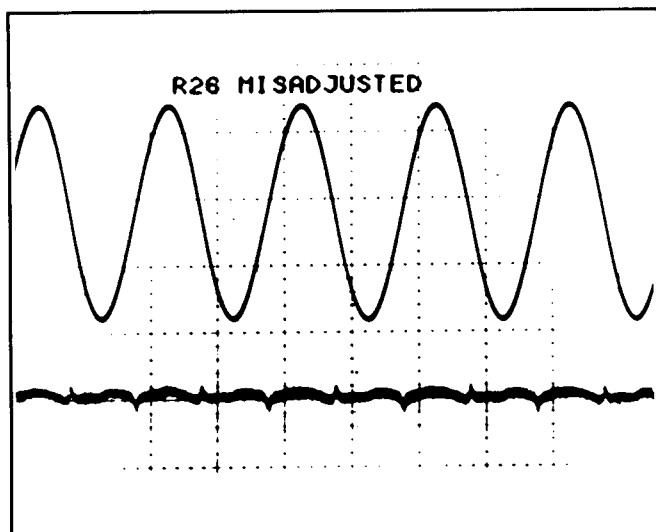

Figure 8 Results with Improperly Adjusted Bias

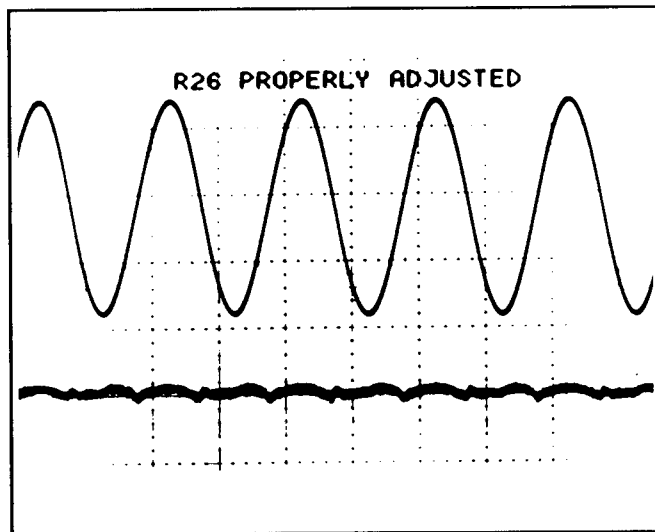

Figure 9 Results with Properly Adjusted Bias

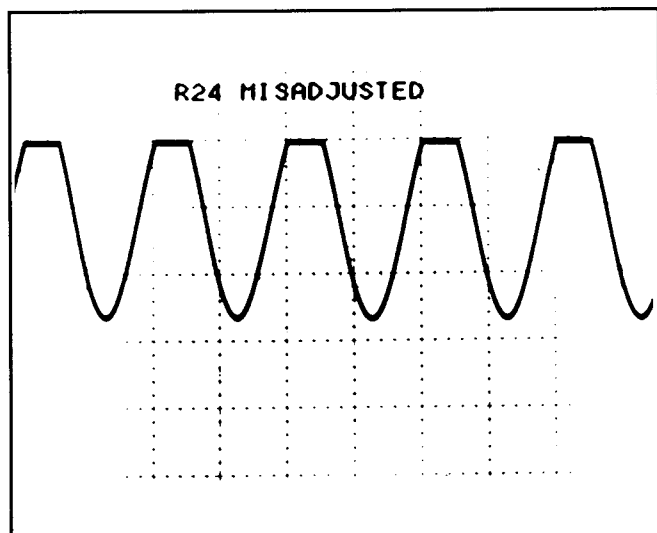

Figure 10 Improperly Adjusted Positive Current Limit

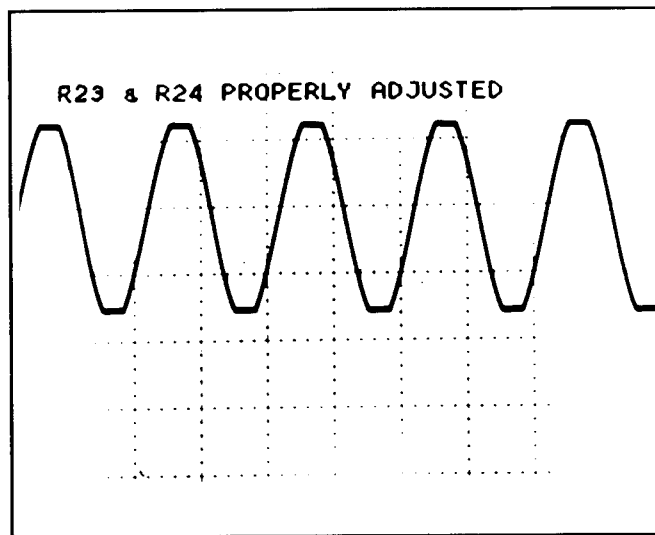

Figure 11 Properly Adjusted Pos and Neg Current Limit

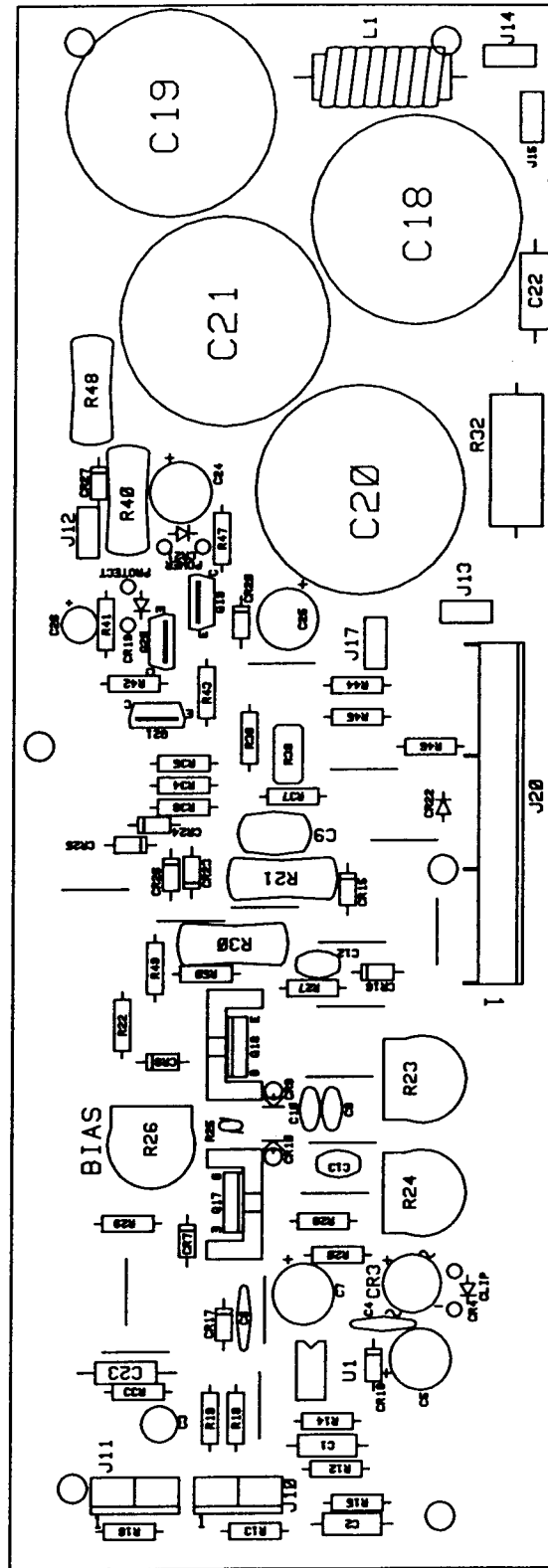

Figure 12 Component Layout of Main Channel Board

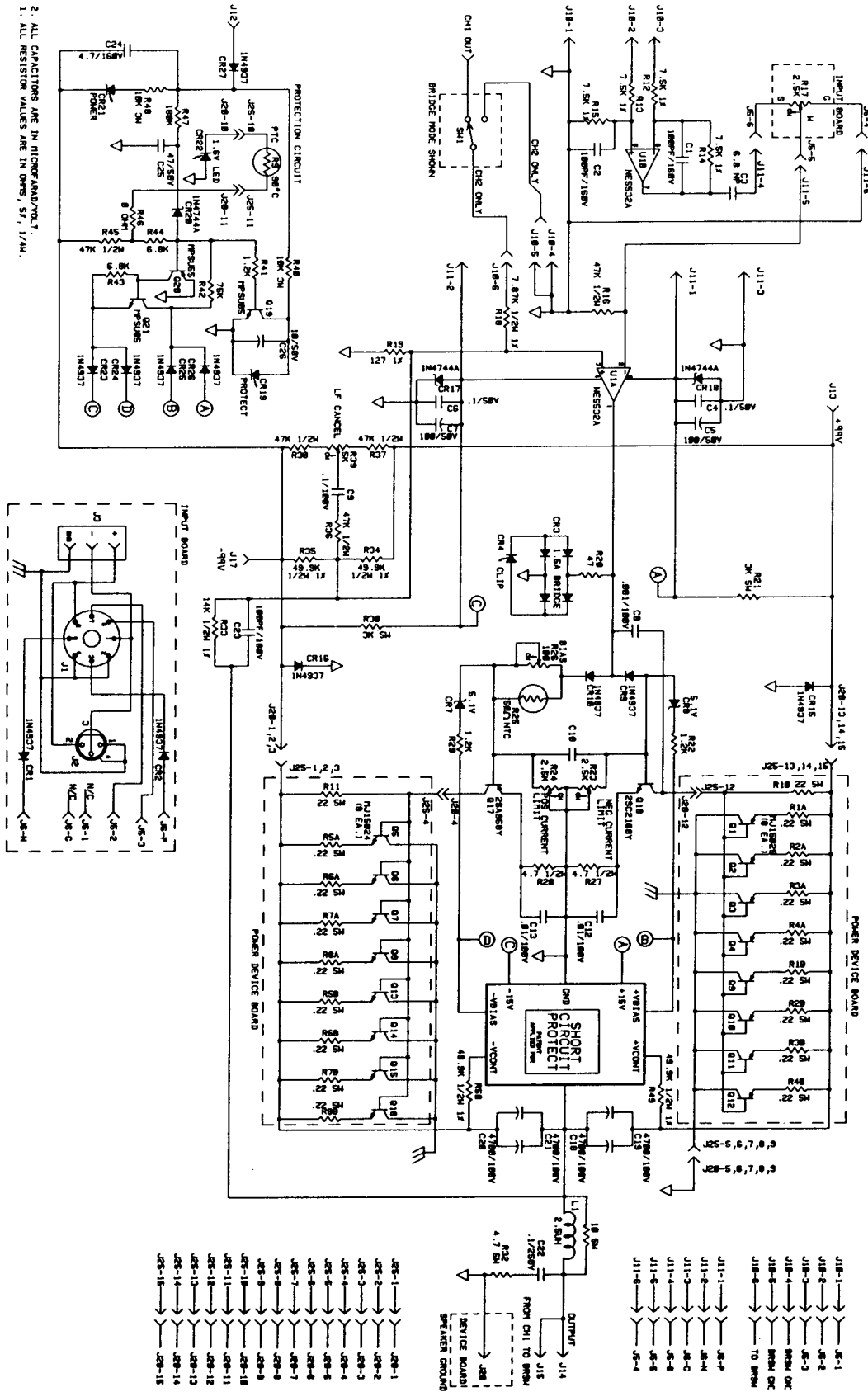

Figure 13 Schematic of AP3200, Sheet 1 of 2

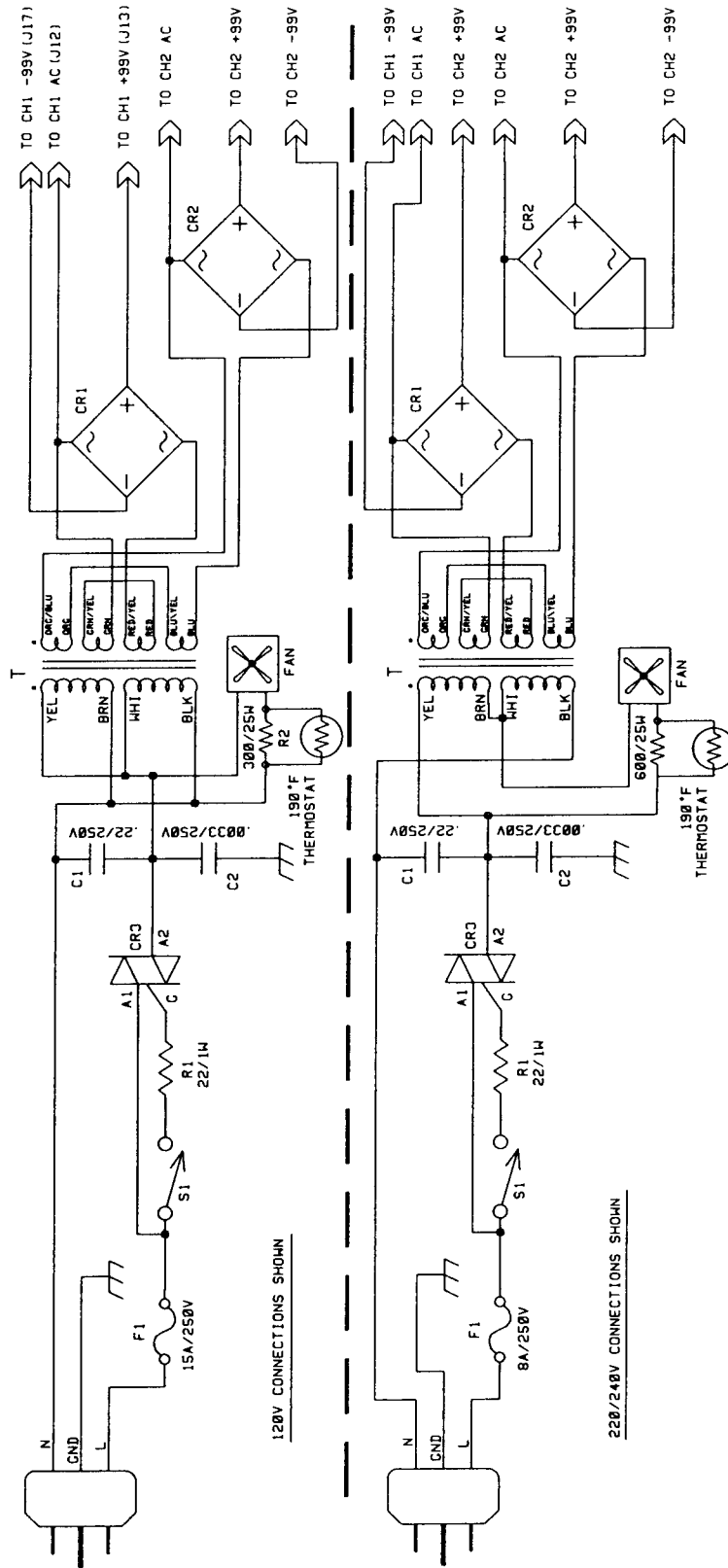

Figure 13 Schematic of AP3200, Sheet 2 of 2

Component Parts Listing for the AP3200

Reference Designator	Ordering Number	Name and Description
R1, R2, R3, R4, R5, R6, R7, R8	47-09-125029	Resistor, $2 \times 0.22 \Omega$, 5 watt, 5%
R9	53-01-125094	Resistor, 100Ω @25 °C, Positive Temperature Coefficient
R10, R11	47-01-125064	Resistor, 22Ω , 5 watt, 5%
R12, R13, R14, R15	47-03-124805	Resistor, $7.5 \text{ k}\Omega$, 0.25 watt, 1%, metal film
R16, R36, R37, R38, R45	47-01-028404	Resistor, $47 \text{ k}\Omega$, 0.5 watt, 5%, carbon film
R17	47-06-124795	Potentiometer, $2.5 \text{ k}\Omega$, log taper, rotary PC mount
R18	47-01-125106	Resistor, $7.87 \text{ k}\Omega$, 0.5 watt, 1% metal film
R19	47-01-125099	Resistor, 127Ω , 0.25 watt, 1% metal film
R20	47-01-125101	Resistor, 47Ω , 0.25 watt, 5% carbon film
R21, R30	47-01-125102	Resistor, $3 \text{ k}\Omega$, 5 watt, 5%
R22, R29, R41	47-01-102080	Resistor, $1.2 \text{ k}\Omega$, 0.25 watt, 5% carbon film
R23, R24	47-06-125100	Trimpot, $2.5 \text{ k}\Omega$, 0.25 watt, horizontal mount with shaft
R25	47-09-125021	Resistor, 50Ω @25 °C, Negative Temperature Coefficient
R26	47-06-125035	Trimpot, 100Ω , 0.25 watt, horizontal mount with shaft
R27, R28	47-01-102208	Resistor, 4.7Ω , 0.5 watt, 5%
R32	47-01-124834	Resistor, 4.7Ω , 5 watt, 5%
R33	47-03-125105	Resistor, $14 \text{ k}\Omega$, 0.5 watt, 1% metal film
R34, R35, R49, R50	47-03-125033	Resistor, $49.9 \text{ k}\Omega$, 0.5 watt, 1% metal film
R39	47-06-125104	Trimpot, $5 \text{ k}\Omega$, 0.15 watt, vertical mount
R40, R48	47-01-125066	Resistor, $10 \text{ k}\Omega$, 3 watt, 5%
R42	47-01-102124	Resistor, $75 \text{ k}\Omega$, 0.25 watt, 5% carbon film
R43, R44	47-01-102098	Resistor, $6.8 \text{ k}\Omega$, 0.25 watt, 5% carbon film
R46	21-01-110310	Resistor, 0Ω jumper
R47	47-01-109298	Resistor, $180 \text{ k}\Omega$, 0.25 watt, 5% carbon film
C1, C2, C23	15-06-037468	Capacitor, 100 pF , 160 volt, 5%, polypropylene
C3	15-01-125026	Capacitor, $6.8 \mu\text{F}$, 50 VDC, non-polar, Aluminum
C4, C6	15-02-124437	Capacitor, $0.1 \mu\text{F}$, 50 VDC, ceramic disk
C5, C7	15-01-124503	Capacitor, $100 \mu\text{F}$, 50 VDC, Aluminum
C8	15-06-124587	Capacitor, $0.001 \mu\text{F}$, 100 VDC, 5%, polypropylene
C9	15-06-124637	Capacitor, $0.1 \mu\text{F}$, 100 VDC, 5%, polypropylene
C12, C13	15-06-124588	Capacitor, $0.01 \mu\text{F}$, 100 VDC, 5%, polypropylene
C18, C19, C20, C21	15-01-036110	Capacitor, $4700 \mu\text{F}$, 100 VDC, Aluminum, 10%
C22	15-06-100113	Capacitor, $0.1 \mu\text{F}$, 250 VDC, 10%, Polyester
C24	15-01-125024	Capacitor, $4.7 \mu\text{F}$, 160 VDC, Aluminum
C25	15-01-124508	Capacitor, $47 \mu\text{F}$, 50 VDC, Aluminum
C26	15-01-124502	Capacitor, $10 \mu\text{F}$, 50 VDC, Aluminum
L1	56-01-026510	Inductor, $2.0 \mu\text{H}$, choke
CR1, CR2, CR9, CR10, CR15, CR16, CR23, CR24, CR25, CR26, CR27	48-01-125067	Diode, 1N4937, fast recovery rectifier
CR3	48-02-037580	Bridge Rectifier, 1.5 Amp, 70 V
CR4, CR19, CR21	39-01-124540	LED, red, with 12 inch leads
CR7, CR8	48-01-122988	Zener, 1N5231B, 5.1 volt, 0.5 watt, 5%
CR11, CR13, CR17, CR18, CR20	48-01-125098	Zener, 1N4744A, 15.0 volt, 1 watt, 5%
CR22	39-01-121926	LED, red, T1-3/4
U1	17-01-122832	IC, NE5532A
Q1, Q2, Q3, Q4, Q9, Q10, Q11, Q12	48-03-122979	Transistor, MJ15025, PNP

Reference Designator	Ordering Number	Name and Description
Q5, Q6, Q7, Q8, Q13, Q14, Q15, Q16	48-03-122978	Transistor, MJ15024, NPN
Q17	48-03-124475	Transistor, 2SA958Y, PNP
Q18	48-03-124474	Transistor, 2SC2168Y, NPN
Q19, Q21	48-03-028711	Transistor, MPS-U05, NPN
Q20	48-03-028712	Transistor, MPS-U55, PNP
C1	15-02-124994	Capacitor, 0.22 μ F, 250 VAC
C2	15-02-125108	Capacitor, 0.0033 μ F, 250 VAC
CR1, CR2	48-02-122651	Bridge Rectifier, 25 amp, 400 volt
CR3	48-02-125089	Triac, Q4025P, 25 amp, 400 volt
F1	51-04-125092	Fuse, 15 amp, 250 volt, Time Delay
R1	47-01-102224	Resistor, 22 Ω , 0.5 watt, 5%
S1	51-02-124582	Switch, power
T1	56-08-027872	Transformer, power
TS1	53-01-124572	Thermostat, 170 °F, normally open
(F1)	28-13-026422	Hardware, rack mount
	51-04-122930	Fuse, 8 amp, 250 volt, NB-UL-CER
	35-01-124521	Fan, equipment cooling, 100 CFM
	47-02-123106	Resistor, 300 Ω , 25 watt, 5%