

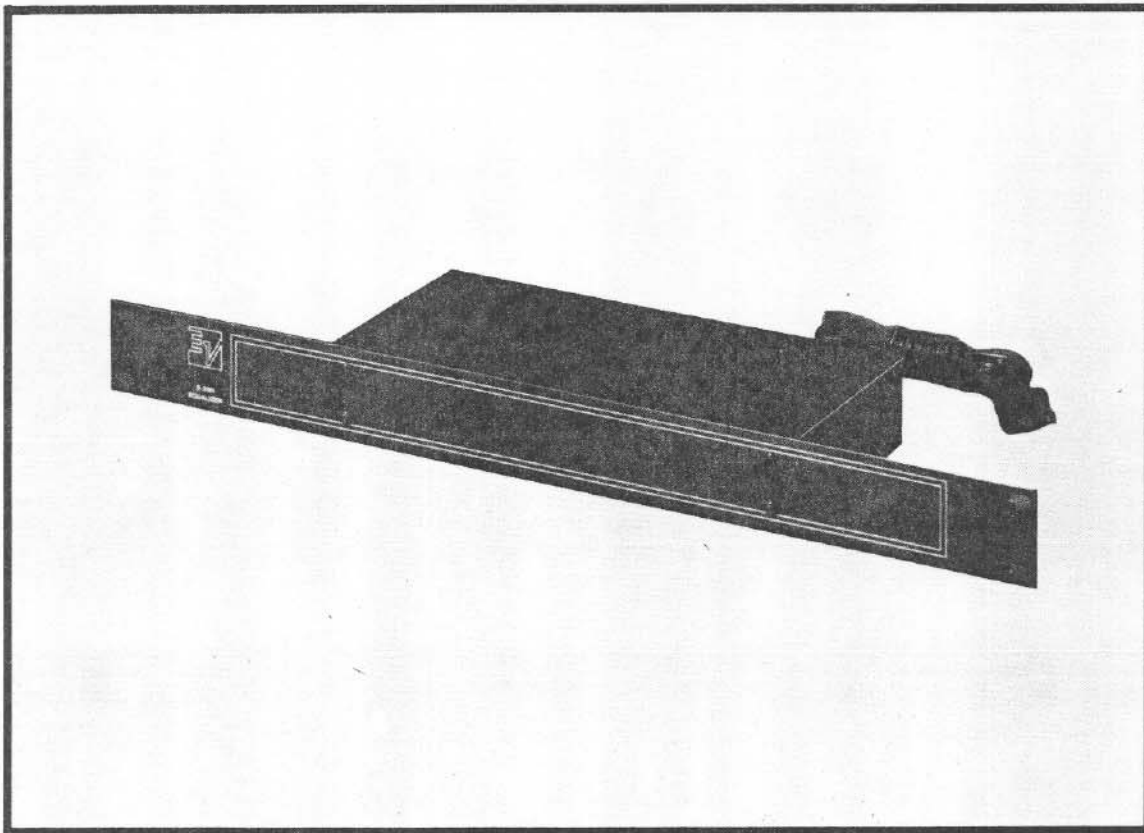

Electro-Voice®
MODEL S-200
EQUALIZER



**S-200 EQUALIZER
WITH RACK MOUNT**

SERVICE MANUAL

a **gulton** company

TABLE OF CONTENTS

	Page
Specifications	2
Description	2
Figures	3
PC Board	4
Schematics	4
Parts List	5
Repair Parts/Warranty	6

SPECIFICATIONS

<p>NUMBER OF CHANNELS — Two</p> <p>GAIN — 0 dB above 1000 Hz (See Figure 1)</p> <p>INPUT — 500 k ohm, unbalanced</p> <p>OUTPUT — Unbalanced</p> <p>INTERNAL IMPEDANCE — 560 ohms</p> <p>RECOMMENDED LOAD — ≥ 2000 ohms</p> <p>MAXIMUM OUTPUT LEVEL — +18 dBu (+16 dB V) into 10 k ohm load</p>	<p>NOISE, 20-20,000 Hz — -90 dBu (input terminated with 600 ohms)</p> <p>TOTAL HARMONIC DISTORTION — < 0.01% maximum .002 typical at ±12 dBu (+10 dBV)</p> <p>CHANNEL SEPARATION (20-20,000 Hz) — > 85 dB</p> <p>POWER REQUIREMENTS — Domestic Model: 100-130 V, 60 Hz, 2.5 W max. Export Model: 200-260 V, 50/60 Hz, 2.5 W max.</p> <p>DIMENSIONS — 4.2 cm (1.67 in.) height 24.3 cm (9.58 in.) width 11.1 cm (4.35 in.) depth</p> <p>WEIGHT — 822 grams (1 lb 13 oz)</p> <p>RACK SPACE REQUIRED — 4.4 cm (1.75 in.)</p>
---	--

DESCRIPTION

The Model S-200 Equalizer is a two-channel active device designed to be used with the Model S-200 Stage Speaker system as an option. With its application to the sound system it allows the speakers to be switched into their equalized (step-down) mode of operation, thereby extending the low frequency response limit by almost one octave, from 90 Hz to 50 Hz. In addition, this mode provides four decibels of increased efficiency.

Unlike some competitive systems which provide up to 18 dB of electrical boost at high frequencies, the S-200 equalizer is essentially flat above 1000 Hz. This substantially reduces the amount of high frequency energy which must be provided by the power amplifier. In addition, the sharp cutoff filter operating below 50 Hz attenuates sub-sonic signals and noise that lie below the useful response range of the speakers. Not only are these energy-robbing signals eliminated from the power amplifiers, but speaker cone excursion can be significantly reduced. See Figure 1.

Standard ¼-inch phone jacks are provided for input and output connections. The equalizer is designed to drive two high impedance, unbalanced loads, as provided by typical power amplifiers. Up to five such amplifiers may be driven in parallel without appreciable degradation of specifications, and up to ten, with only a reduction in output level (headroom).

An adapter panel is provided to allow the S-200 equalizer to be mounted in a standard, 19-inch rack. The input and output circuit grounds are isolated from the chassis by an internal 10-ohm resistance, to reduce the likelihood of generating a ground loop when mounted in an equipment rack.

Although it is unlikely that the equalizer could be overloaded at its input under any normal conditions, Figure 2 shows the maximum permissible input level versus frequency. At high and low frequency extremes, this represents a substantially greater level than that of competitive units.

The S-200 Equalizer should be connected between the mixer (or preamplifier) and the power amplifier of your sound system. Connect the output of the mixer to the input of the Equalizer. Then connect the output of the equalizer to the input of the power amplifier, using shielded cable for both of these connections. Connect the line cord to a source of ac power, as indicated by the red LED on the front panel. Since power drain is less than 2½ watts, the equalizer may be left energized between uses, if desired.

The equalizer can deliver over 8 volts RMS output into a high impedance load, which is much greater than that required to drive most power amplifiers to full output. A number of amplifiers may be driven in parallel, so long as their combined impedance does not fall appreciably below 1000 ohms. The latest BI-FET operational amplifier circuitry is employed to assure very fast slew-rate capability, and clean sound. The inputs are very high impedance, and protected against incidental dc leakage voltages up to 50 V.

Although a line voltage within the specified range (see "Power Requirements" section) is required for full rated output, satisfactory performance will extend 15 percent below this range, with some sacrifice in output voltage capability.

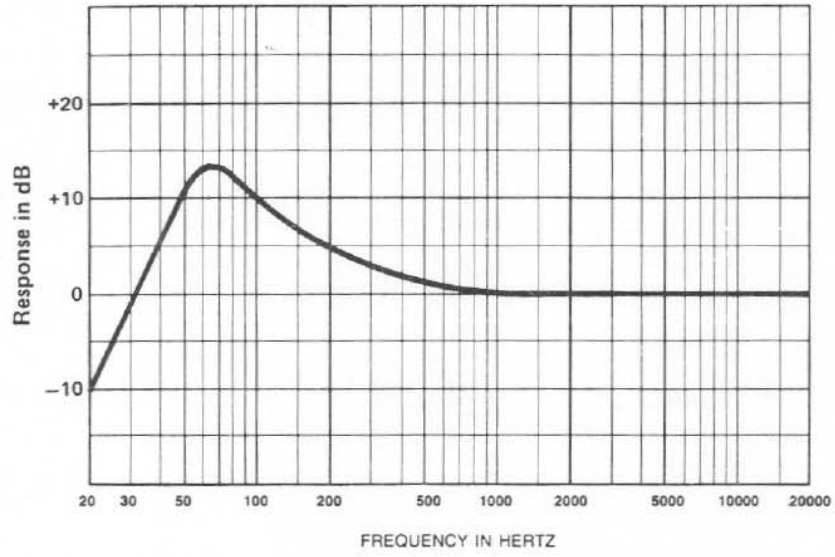

FIGURE 1
Frequency Response

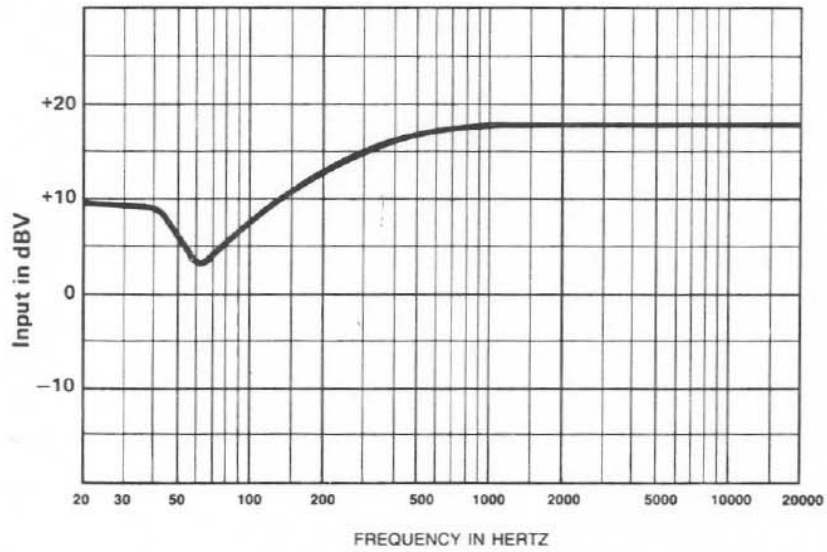
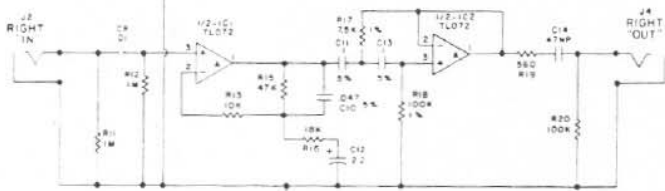
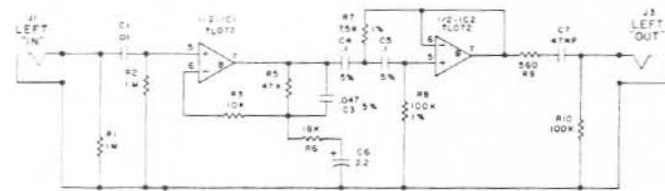
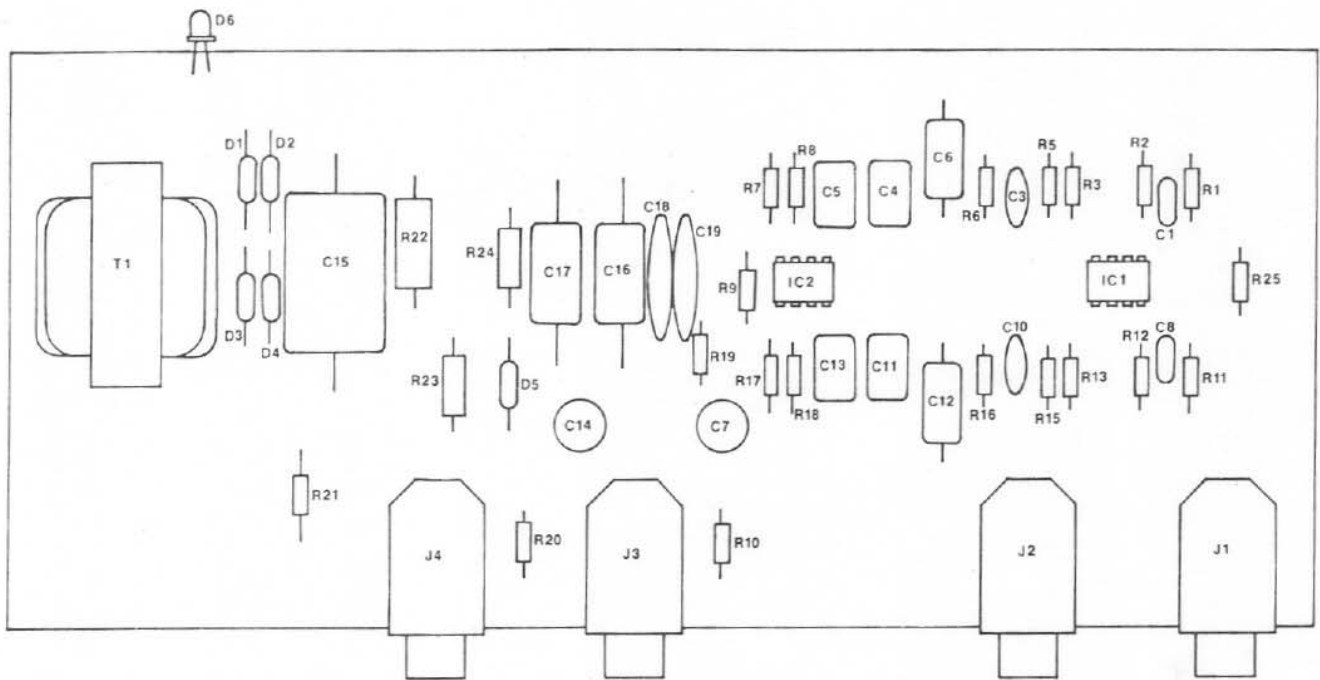
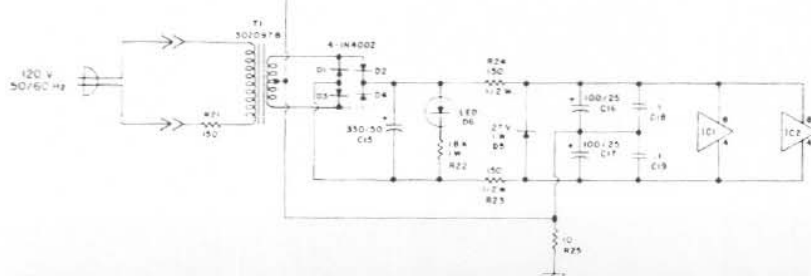

FIGURE 2
Maximum Input Voltage



NOTES:

1. LAST REF NOS. USED
C19, R25, T1, D6, J4, IC2.
2. ALL CAPACITORS IN #18
UNLESS OTHERWISE SPECIFIED.
3. ALL RESISTORS 1/4 W., 5%
UNLESS OTHERWISE SPECIFIED.
4. REF. Nos. NOT USED - C2, C9, R4, R14



454265	TUBING, FIBERGLASS, 1/2" LONG	—
300107	LUG, P.C., SOLDER	—
005857-2	RESISTOR, 5%, 1/4W., C.F., 150Ω	R 21
300093	JACK, 1/4" PHONE, RN-112 A.P.C.	J1,2,3,4
008042	DIODE, ZENER, 27V., 1W.	D5
004216	CAPACITOR, ELECT., N.P., 47μf, 25V	C7,14
005926	RESISTOR, 5%, 1/4W., C.F., 100K	R10,20
005829	RESISTOR, 5%, 1/4W., C.F., 10Ω	R25
003037	CAPACITOR, MYLAR, 10%, .01μf	C1,8
005951	RESISTOR, 5%, 1/4W., C.F., 1MEG	R1,2,11,12
454253	TUBING, INSUL., 18 GA.	—
005902	RESISTOR, 5%, 1/4W., C.F., 10K	R3,13
005918	RESISTOR, 5%, 1/4W., C.F., 47K	R5,15
003250	CAPACITOR, MYLAR, 5%, .047μf	C3,10
005908	RESISTOR, 5%, 1/4W., C.F., 18K	R6,16
001403	CAPACITOR, ELECT., 2.2 of 25V.	C6,12
003273	CAPACITOR, MYLAR, 5%, .1μf	C4,5,11,13
007010	I.C., TL072	I.C.1,2
005645	RESISTOR, 1%, 1/4W., C.F., 100K	R8,18
005616	RESISTOR, 1%, 1/4W., C.F., 7.5K	R7,17
005871	RESISTOR, 5%, 1/4W., 560Ω	R9,19
004091	CAPACITOR, CER. DISC, .1μf	C18,19
001412	CAPACITOR, ELECT., 100μf, 25V.	C16,17
005048	RESISTOR, 5%, 1/2W., 150Ω	R23,24
005303	RESISTOR, 5%, 1W., 1.8K	R22
001616	CAPACITOR, ELECT., 330μf, 50V.	C15
008022	DIODE, IN4002	D1,4
008064	LED, RED, T-1	D6
302097	TRANSFORMER	T1
451135	P.C. BOARD	—
PART No.	DESCRIPTION	REF No.

REPAIR PARTS

Service parts are available from the Redmond factory. Contact us by phone or mail.

Our address: Electro-Voice, Inc.
3810 148th Ave. NE
Redmond, WA 98052

206/881-9555
(8AM-4PM pacific time zone)

If you are ordering parts and do not have the six digit part number, please include the model and serial number of the unit, the assembly part number and revision. The assembly part number/revision is a six digit, one letter code beginning with 800 that is rubber stamped on the parts side of the PCB assembly. In lieu of this information, the two digit, one letter code etched into the foil side of the PCB is helpful. If you are ordering a control or switch, tell us the function name . . . power, frequency, input level, etc.

In any event, be sure to include the following information:

Your Name
Shipping address (no post office boxes, please)
City, State, Zip
Daytime phone number
Method of shipment (UPS ground if not specified)

If you call us for assistance on/with a problem, please have the EXACT model number, serial and assembly part numbers handy.

WARRANTY (Limited)

Electro-Voice EVT Electronic Components are guaranteed for one year from date of original purchase against malfunction due to defects in workmanship and materials. If such malfunction occurs, unit will be repaired or replaced (at our option) without charge for materials or labor if delivered prepaid to the proper Electro-Voice service facility. Unit will be returned prepaid. Warranty does not extend to finish, appearance items or malfunction due to abuse or operation under other than specified conditions, nor does it extend to incidental or consequential damages. Some states do not allow the exclusion or limitation of incidental or consequential damages, so the above exclusion may not apply to you. Repair by other than Electro-Voice or its authorized service agencies will void this guarantee. A list of authorized service centers is available from Electro-Voice, Inc., 600 Cecil Street, Buchanan, MI 49107 (AC/616-695-6831); Electro-Voice, Inc., 3810 148th Avenue N.E., Redmond, WA 98052 (AC/206-881-9555); and/or Electro-Voice West, 8234 Doe Avenue, Visalia, CA 93291 (AC/209-651-7777). This warranty gives you specific legal rights, and you may also have other rights which vary from state to state.

Service and repair address for this product:
Electro-Voice, Inc., 3810 148th Avenue N.E., Redmond, Washington 98052.

Specifications subject to change without notice.

PROPRIETARY NOTICE

This document and the technical data hereon disclosed, are proprietary to Electro-Voice, Inc. and shall not, without express written permission of Electro-Voice, Inc. be used, released or disclosed in whole or in part, or used to solicit quotations from a competitive source or used for manufacture by anyone other than Electro-Voice, Inc. The information hereon has been developed at private expense, and may only be used for purposes of engineering evaluation and for incorporation into technical specifications and other documents which specify parts procured by or procurement of products from Electro-Voice, Inc.

**ELECTRO-VOICE, INC., 600 Cecil Street, Buchanan, Michigan 49107**

MANUFACTURING PLANTS AT ■ BUCHANAN, MI ■ NEWPORT, TN ■ SEVIERVILLE, TN ■ REDMOND, WA ■ GANANOQUE, ONT
©Electro-Voice, Inc. 1986 ■ Litho in U.S.A.

a gulton company

Form 2571