

series seven

OPERATORS HANDBOOK

FERROGRAPH

OPERATOR'S HANDBOOK

Ferroglyph

SERIES SEVEN, Mk 2

SERIAL NUMBER 78,800/2 ONWARDS

**THE FERROGRAPH COMPANY LTD.
LONDON AND SOUTH SHIELDS**



CONTENTS

	<i>Page</i>
Foreword	7
General Specification	8
General Description	10
OPERATING INSTRUCTIONS	13
Connections	13
Power Supply	14
Inputs — Microphone	14
Tuner (radio)	14
Pick-up Cartridge	15
Other Sources	15
Outputs — Loudspeaker	16
Amplifier	16
Tape Recorders	17
Headphones	17
Deck Operation	17
Tape Loading	18
Tape Speed	18
Play	19
Record	19
Automatic and Foil Stop	20
Fast Wind	20
Replay	22
Bass and Treble Controls	22
Output Switch	23
Meter Switch	23
Record	24
Interjection	24
Stereo Models	24
Radio	25
Gramophone	25
Microphone	25
Characteristics	26
Placement	26
Use of Microphone	27
Monitoring	27
General Details	28
Changing Tracks	28
Editing and Splicing Tape	29
Spools	31
Tape and Bias	33
Auxiliary Socket	34
Externally Controlled Operation	34
Time Switch	35
Remote Operation — Start/Stop	35
Volume	35
Signal Operation	36
Special Applications	36
Echo Effect	36
Use as an Amplifier	37
Cabinet Mounting	37
Stereophonic Models Only	39
Transfer Switch — Multiplay	40
4 Input Mixing	40
Echo Effect	43
Quarter Track	43
Models 702 and 704	44
Care and Maintenance	44
TECHNICAL SECTION	45
Technical Details	45
220V, 50 Hz Power Supply	46
Record — Constant Tones (Frequency Response)	46
Bias Adjustment	46
Monitoring (Signal Level)	48
Bass and Treble Controls	49
Endless Loop Cassette	49
Loading	50
Mounting	50
Operation	51
Technical Description (Design Details)	52
Mechanical Section	53
Electronic Section	59
Appendix A	68
Operational Fault Analysis	68
Appendix B	70
Accessories	70
Index	72

FERROGRAPH SERIES SEVEN

GENERAL SPECIFICATION

RECORDING MEDIUM

Magnetic tape, $\frac{1}{4}$ " wide, on reels of up to $8\frac{1}{2}$ " diameter.

TRACK WIDTH

Full track — .248 in. (6.3 mm.); $\frac{1}{2}$ track — .090 in. (2.3 mm.);
 $\frac{1}{4}$ track — .043 in. (1.1 mm.).

HEAD GAP WIDTH

Record head — 250μ in. (6.3μ); Replay head — 80μ in. (2μ).

OPERATING TAPE SPEEDS

Three (3): — $7\frac{1}{2}$, $3\frac{3}{4}$, $1\frac{7}{8}$ in./sec. (19, 9.5, 4.75 cm/sec.)
Suffix H 15, $7\frac{1}{2}$, $3\frac{3}{4}$ in./sec. (38, 19, 9.5 cm/sec.)

TAPE SPEED ACCURACY

Better than $\pm 1\%$ (at specified supply frequency).

PLAYING TIME PER TRACK

2,400 ft. (720 m.) of tape — 1 hr. 4 min. at $7\frac{1}{2}$ in./sec. (19 cm/sec.)
2 hr. 8 min. at $3\frac{3}{4}$ in./sec. (9.5 cm/sec.)

FAST WIND TIME

Continuously variable in either direction; at fast speed less than
1 min. for 1,200 ft. (360 m.) of tape.

"WOW" AND "FLUTTER"

Less than 0.08% at $7\frac{1}{2}$ ins./sec. (19 cm/sec.)
0.15% at $3\frac{3}{4}$ ins./sec. (9.5 cm/sec.)
0.20% at $1\frac{7}{8}$ ins./sec. (4.75 cm/sec.)

High Speed Models (Suffix H)

Less than 0.08% at 15 ins./sec. (38 cm/sec.)
0.10% at $7\frac{1}{2}$ ins./sec. (19 cm/sec.)
0.15% at $3\frac{3}{4}$ ins./sec. (9.5 cm/sec.)

FREQUENCY RESPONSE

Record-Replay, using Long Play Ferrotape type B.

15 in./sec. (38 cm/sec.)	: 30-20,000Hz ± 2 dB	} H
$7\frac{1}{2}$ in./sec. (19 cm/sec.)	: 30-17,000Hz ± 2 dB	
$3\frac{3}{4}$ in./sec. (9.5 cm/sec.)	: 40-14,000Hz ± 3 dB	
$1\frac{7}{8}$ in./sec. (4.75 cm/sec.)	: 50- 7,000Hz ± 3 dB	

REPLAY CHARACTERISTIC — D.I.N. (N.A.B. on 117V models)

15 in./sec. (38 cm/sec.)	: 35μ sec. (50μ sec. -N.A.B.)
$7\frac{1}{2}$ in./sec. (19 cm/sec.)	: 50/3180 μ sec.
$3\frac{3}{4}$ in./sec. (9.5 cm/sec.)	: 90/3180 μ sec.
$1\frac{7}{8}$ in./sec. (4.75 cm/sec.)	: 120/1590 μ sec.

MAXIMUM OUTPUT (per channel)

10 Watts R.M.S. into 8-16 Ω loudspeaker.

AMPLIFIER DISTORTION

Less than 0.25% R.M.S. at all levels up to 10 Watts.

SIGNAL TO NOISE RATIO

Unweighted, including hum, better than 55dB.—ref. 2% distortion.
Weighted (C.C.I.F.), better than 60dB. ($\frac{1}{4}$ track—58dB).

BASS CONTROL

Continuously variable up to ± 15 dB at 50Hz, ± 20 dB at 20Hz.

TREBLE CONTROL

Continuously variable up to ± 10 dB at 10kHz, ± 15 dB at 20kHz.

INTERNAL LOUDSPEAKERS

Two (2) — elliptical 7 in. x 4 in. (18 cm. x 10 cm.).

INPUT LEVEL (for full depth recording)

Microphone: 300 μ V-15mV at 10K Ω , Recommended Source: 250-
2,000 Ω .

Line: 50mV-10V at 2M Ω , Recommended Source: any impedance.

OUTPUTS (from full depth recording)

600 Ω : 2V at 600 Ω

Low Level: 300mV into 10K Ω or greater

*Loudspeaker: up to 10 Watts R.M.S. into 8-16 Ω

POWER SUPPLY

200-250V, 50Hz; Suffix A: 117V, 60Hz.

POWER CONSUMPTION

100 Watts approximately.

CHANNEL SEPARATION (Stereo Models Only)

Stereo operation — approx. 50dB; Mono operation — better than
65dB at 1,000Hz.

OVERALL DIMENSIONS (with lid)

16 $\frac{1}{2}$ " wide x 17 $\frac{1}{2}$ " x 10" (425 mm. wide x 445 mm. x 255 mm.).

WEIGHT

49 $\frac{1}{2}$ lbs. (22.5 Kgm).

ALTERNATIVE MODELS

Suffix P: Portable wood case, leather-cloth covered, with lid.

Suffix W: Wooden case, natural wood finish.

Suffix S: Uncased version.

*On Models 702 and 704, this output is replaced by:—

Low Level Adjustable: up to 300mV into 10K Ω or greater.

GENERAL DESCRIPTION

The Series Seven Ferrographs retain the basic 3 motor drive system of the earlier models, but have completely redesigned mechanics with solenoid operation. This enables the tape to be started and stopped by remote switching, and on Record and Replay the recorder can be controlled by a time switch.

The main functions of the deck (Fast, Stop, Pause, Run) are selected by a single knob, with a separate press button for Record. On fast wind the direction and speed of wind are governed by a separate control. An automatic stop operates at the end of the reel and the 4-digit turns counter is driven from the take-up spool.

Reel retainers are fitted to the reel carriers, which will accommodate all types of spool conforming to the international standard. Three tape speeds are available on each deck, and tension arms provide slur-free starting at all tape speeds. The easy access head block gives straight line tape loading, and the deck can be operated in either horizontal or vertical positions.

Each deck is fitted with separate Erase, Record and Replay heads, so that off-the-tape monitoring is possible whilst recording, and the Output switch gives instant comparison of the original and recorded signals. This can be done aurally on the internal loudspeaker or the signal levels can be checked visually on the meter, which can also be switched to read the record bias.

Up to 10 Watts is available from the output stage and this can be made subject to separate Bass and Treble control giving boost or cut. Either internal or external loudspeakers may be used and an alternative Low Level output is provided. There is also a 600 Ω emitter follower output which will give a signal independent of the Output, Bass and Treble controls. The tape can also be monitored on fast wind (but muted to avoid discomfort) for accurate place location on the tape.

On record, mixing is given by separate gain controls for the Microphone input and the Line input (suitable for radio or crystal and ceramic pick-ups). All connections (except the Microphone input) are on a panel at the rear of the recorder, and the instrument is mounted on a rigid metal frame which facilitates removal from its portable case and its inclusion in alternative cabinets.

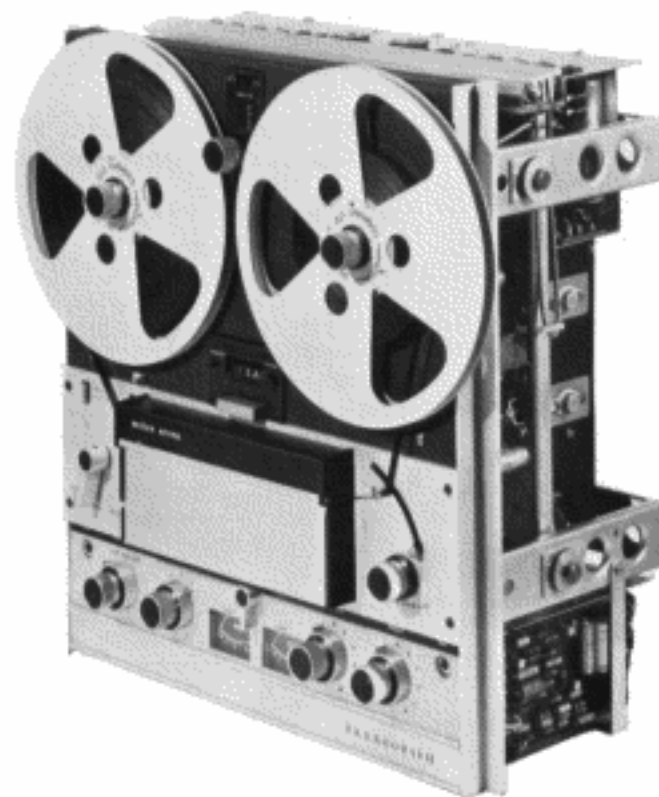

FIG. 1. FERROGRAPH — UNCASSED MODEL

The Model 713 is a monophonic recorder operating on the upper half of the tape with facilities as described above. The Models 722 ($\frac{1}{2}$ track) and 724 ($\frac{1}{4}$ track) are stereophonic recorders with each channel identical to that of the mono recorders. The two internal loudspeakers are fed separately from two 10 Watt output stages and a Record switch allows stereo recording or mono recording on either track. On mono operation a switch can be used to connect the output of either track to the Line input of the other track and this can be utilised to produce "multi-play" recordings, or alternatively to give 4 input mixing on either track or echo without external connections. The Models 702 and 704 are similar to the Models 722 and 724, but do not have power amplifiers or loudspeakers, the third output being at low level.

IMPORTANT NOTICE

To achieve the lowest possible noise levels from any magnetic tape recorder, it is essential that the record and replay heads be entirely free from residual (*i.e.* permanent) magnetism. In other words, the heads should not be allowed to become polarised, and therefore permanent magnets, or steel tools which may have become magnetised, should not be used near the heads.

Under normal operating conditions it is difficult to cause polarisation on the Ferrograph, since automatic demagnetisation is provided for the record head by arranging the supersonic bias current through the head to die away gradually on releasing the Record Button. Nevertheless, there are two things to be avoided. (a) On stereo models the Record Mode switch (Upper-Stereo-Lower) should not be turned when on Record *i.e.* while the Record Button is depressed. (b) On all models, large switching surges in the amplifiers should be prevented by turning the appropriate gain control to zero before removing or inserting an input plug.

Observing the above precautions will avoid the major factors which cause polarisation, but nevertheless, if it does occur and manifest itself by increased hiss, irregular thumping noises in the background and some distortion, the quickest and most convenient method of demagnetising the record and replay heads is to use the Wearite Defluxer (Appendix B). The pole tip should be held against the working face of each head in turn for one or two seconds, then the defluxer slowly withdrawn well clear of the recorder before releasing the energising button.

It is also essential to maintain the working face of each head scrupulously clean and free from dust or tape oxide deposit, which will seriously impair its performance. A special head cleaning brush is provided with the recorder for this purpose and it should be used as described on page 44. This is particularly important when using new tapes, which often have a certain amount of surplus oxide tending to collect on the heads and capstan/pinch roller. It is therefore advisable to clean the capstan and pinch roller more frequently when using a new reel of tape, as outlined in "Care and Maintenance", page 44.

Due to constant efforts to improve performance and consequent modifications, it may be found that minor differences exist between the actual instrument and that described in this manual. It is therefore essential to quote the serial number of the recorder when ordering any replacement parts.

FERROGRAPH SERIES SEVEN

OPERATING INSTRUCTIONS

The carrying handle is at the rear of the recorder adjacent to the flap covering the connection panel. This flap can be raised using the slot, when the handle can be withdrawn from its recess. The cabinet lid is removed by sliding the two knobs (one at each end of the recess) away from the lid, which can then be slid backwards and lifted clear. It is replaced and secured in the reverse manner.

When 8½" reels are fitted to the recorder, they overhang the deck slightly and must be removed when refitting the lid. Smaller reels of 7" diameter or less can be left on the deck, but it is inadvisable to operate the instrument with the lid in position, as this inhibits the ventilation arrangements. For the same reason, the square aperture on the underside of the cabinet should not be obstructed, as this would stop adequate air in-flow.

When the Ferrograph is to be operated vertically, the two studs at the front of the recorder case should be replaced by the two larger feet supplied with the recorder. The two "press-in" studs should be levered out of their positions and the new feet screwed into the same two places so that when the recorder is stood upright, its front face is inclined backward very slightly. Also, the auto stop control at the extreme right of the deck control panel should be turned so that the screwdriver slot is in line with "V" (see page 20).

The recorder is also supplied with a mains lead, a head cleaning brush, hexagonal "Allen" keys (3B.A, 4B.A and 6B.A) and replacement fuses.

Note. All subsequent references to "mains" in this manual mean the A.C. power supply e.g. the mains fuse.

CONNECTIONS

Except for the microphone input on the front panel, all connections are at the rear of the recorder *i.e.* Line input, 600 Ω output, Low Level output and Loudspeaker output. The mains input is at the centre of the panel with the mains and D.C. fuses either side. These are all 1A rating, size 20 m.m. long x 5 m.m. dia. except for the Mains Fuse on the 117V model (Suffix A) which is 20 m.m. x 5 m.m. dia. rated at 2 Amp.

Power Supply

The recorder should be connected to the power supply using the lead and socket provided, by inserting into the plug at the centre of the rear panel (Fig. 3 or 4). The other end of the lead should be fitted with a plug appropriate to the installation (brown - Live, blue - Neutral, green/yellow - Earth), and plugged into the 240V, 50Hz supply — 117V, 60Hz supply for models suffix A (for 220V, 50Hz supply see page 46).

The instrument is energised by the switch at the rear centre of the deck, when the "On" lamp will be illuminated.

Inputs

Microphone

Medium impedance microphones (250-2,000 Ω) can be plugged directly into the Microphone input (300 μ V-15mV) on the front panel and reasonably long leads used (the maximum length will depend upon local conditions e.g. sources of hum, interference, etc) When using a low impedance (30-50 Ω) microphone, a matching unit is necessary (e.g. TA/30/ML in appendix B) and very long leads can be used.

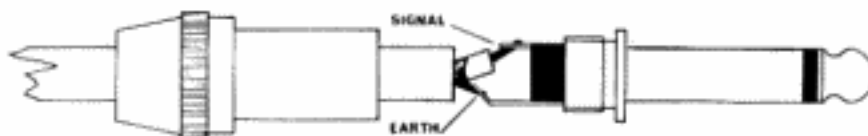

FIG. 2. JACK PLUG WIRING

Tuner (radio)

The output from most tuner units may be fed directly into the "Line" input, which will accept signals from 50mV to 10V (input impedance 2M Ω), and this will also apply to the "Tape", "Tape Output" and "Tape Recorder" sockets on modern radios. Unless stated otherwise in the tuner instructions, screened lead should be used for this connection. In the unlikely event of the signal being too weak for the "Line" input, it may be plugged into the Microphone input.

When recording from V.H.F. (F.M.) stereo receivers, no extra filters are necessary.

On a radio without a special output, the best method is to use it virtually as a tuner and to take the signal from immediately after the detector stage, usually across the volume control, as this avoids any hum and distortion associated with the radio output stage. A more convenient method (though not as good) is to connect to the extension loudspeaker socket (twisted flex leads can be used). If the radio's internal loudspeaker is disconnected on plugging in, it is normally necessary to connect a resistor (usually 3 Ω) across the leads to maintain the correct load on the radio output stage. If one of the leads is earthed on the radio, this must be connected to earth at the recorder (to the longer connection blade on the jack plug).

Note:—Great care must be taken when connecting to a radio which will operate from both A.C. and D.C. power supplies as the chassis will probably be connected directly to the mains. In this case either a transformer or isolating capacitors will be required in the signal leads and it is advisable to consult the manufacturer (or supplier) of the radio before attempting to connect to other equipment. This does not apply to a portable radio operating on its own internal batteries.

Pick-up Cartridge

Ceramic and crystal pick-ups can be fed directly into the Line input as this is high impedance (2M Ω) and is capable of accepting large signals (up to 10V). If a crystal pick-up with a very high output is used, such that the Line gain control is operating over a very small part of its control range, the output can be reduced as described in the Technical Section, page 46.

With magnetic pick-ups, some form of correction is necessary to produce a level response from their velocity characteristic output, and usually a small pre-amplifier is used. The circuit of a suitable pre-amplifier, powered from the Auxiliary Socket or a 48V. D.C. supply, is available on request.

For record players, radiograms, etc., having their own pre-amplifiers, these should be used and connected as for a tuner/radio above.

Other Sources

When the signal is obtained from a source not mentioned above, the correct connection will depend on the signal strength and impedance. Normally most signals may be fed to the Line input (50mV-10V), but weak signals should be fed to the Microphone input (300 μ V-15mV). In cases where there is some doubt, the dealer or relevant manufacturer should be consulted.

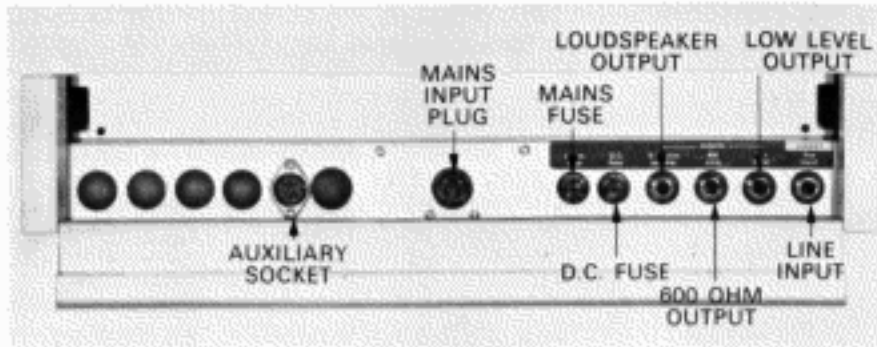

FIG. 3. REAR PANEL—MONO

Outputs

Loudspeaker

The Loudspeaker output will provide up to 10 Watts undistorted output into a 15 or 8 Ω external loudspeaker for high fidelity listening. Plugging into this socket automatically disconnects the internal loudspeaker and the external loudspeaker signal is then governed by the Output, Bass and Treble controls.

Note:—As with other transformerless power output stages, care should be taken not to short the speaker leads to each other, as this will probably overload the amplifier and blow the D.C. fuse. The faulty connection must be corrected and the fuse replaced before the amplifier will function again. On the stereo models, there are two fuses — one for each channel — so that only one channel will be inoperative when a fuse blows. However, the oscillator is powered through the Upper track fuse and should this blow, it will not be possible to record (even on the Lower track) until the Upper track D.C. fuse is replaced. On no account should anti-surge or delay fuses be used.

Amplifier

If it is required to use an external amplifier and loudspeaker, either instead of or together with the internal amplifier and loudspeakers, it may be fed from the 600 Ω output. This is an emitter follower giving approximately 2V signal at 600 Ω impedance from a full depth recording, and while the impedance into which it is fed is not critical, impedances of less than 600 Ω will reduce the output available. If the internal loudspeakers are not required, the Output control can be turned to zero as the 600 Ω output is independent of the Output, Bass and Treble controls.

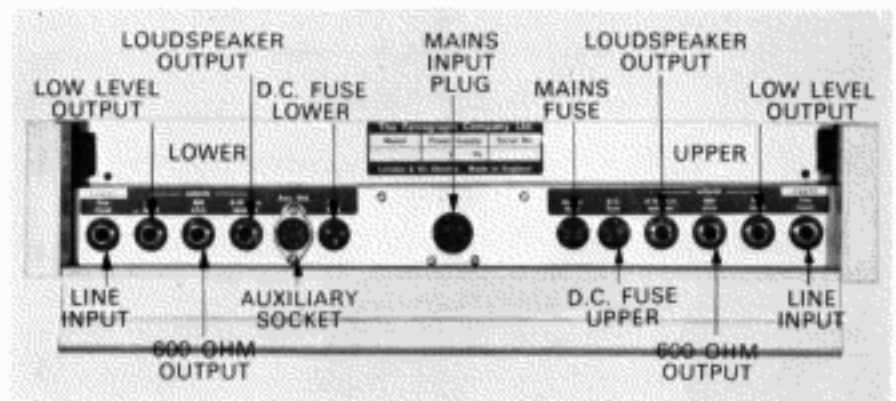

FIG. 4. REAR PANEL—STEREO

If it is required to utilise the internal tone controls, the amplifier may be fed from the Low Level output (300mV at 2-5k Ω) provided that the amplifier input impedance is 10K Ω or higher. Again, if the internal loudspeakers are not required, they can be silenced by turning down the Output control. However, the signal is modified by the Bass and Treble controls and this is useful when replaying tapes recorded to a characteristic other than that of the recorder. On Models 702 and 704, the Low Level Adjustable output could be used, when the signal can be adjusted by the Output control.

Headphones

If it is required to use headphones, these should be plugged into the Loudspeaker output. Although their impedance is not critical, it is recommended that this be 100 Ω or higher, as with lower impedance headphones the Output control setting may need to be very low indeed, in view of the large output power available.

DECK OPERATION

The deck of the Series Seven Ferrograph has been designed for single knob control of the major operations, the Function knob being situated at the front left of the deck, as shown in Fig. 5. It has four positions, "Fast", "Stop", "Pause" and "Run" and should be at "Stop" when loading or adjusting the speed controls.

At the centre of the deck, adjacent to the turns counter, is a small lamp labelled "Reset". This lamp is operated by the "fault" relay and lights up whenever an incorrect setting occurs, or if one of the automatic stops operates. In either event the Function switch must be returned to "Stop (Reset)" and the cause of the fault removed before the lamp will go out, thus indicating that the deck is again ready for operation.

The tape drive will switch off and the "Reset" lamp light up if—

- (a) the equalisation knob is turned while running.
- (b) the speed change knob is turned while running.
- (c) the Auto stop operates.
- (d) the Foil stop operates.

In each case the Function switch must be returned to "Stop" and the "fault" corrected before the "Reset" lamp will go out.

The deck will not function if the "Reset" lamp is on

Tape Loading

To load the deck with tape, the two retaining knobs should be unscrewed from the reel carriers. The reel of tape to be recorded or replayed should be fitted onto the left hand reel carrier (Fig. 5) and the empty spool onto the right hand reel carrier.

The head cover at the centre of the deck control panel should now be raised and the loading knob moved away from the heads to open the loading gate mechanism, which will latch in the open position. The tape can then be inserted in a straight line between the slots in the side pieces as shown in Fig. 5. The end of the tape must be taken round the auto stop guide as shown and attached to the right hand spool. The loading knob should then be depressed slightly to unlatch the mechanism and to allow the loading gate to close, as unless this is done the recorder will not function.

If required, the reel retainers may be screwed back onto the reel carriers to secure the reels during transport, or to prevent them riding off with the deck running in the vertical position (this is not necessary when using reels fitted with their own "Hublock" facility).

When using a tape fitted with a foil at each end, the tape should be wound on manually until the foil has passed the foil stop, before turning to "Pause" or "Fast" (see page 20).

Tape Speed

The Speed Selector knob is situated at the rear centre of the deck, and selects one of the three tape speeds. The knob should be turned counter clockwise to obtain a faster speed, or clockwise to obtain a slower, until the required tape speed is shown in the aperture above the knob. The Equalisation switch on the left of the amplifier control panel must also be set to the same speed as it is electrically interlocked with the speed change switch. Failure to do this will cause the "reset" lamp to light up.

Play

On turning the Function knob to "Pause", the three motors are energised and the drive for the capstan/flywheel started, so that the deck is on "standby". The tape drive is started by turning the Function knob to "Run", and as the capstan is already turning, the start is practically instantaneous.

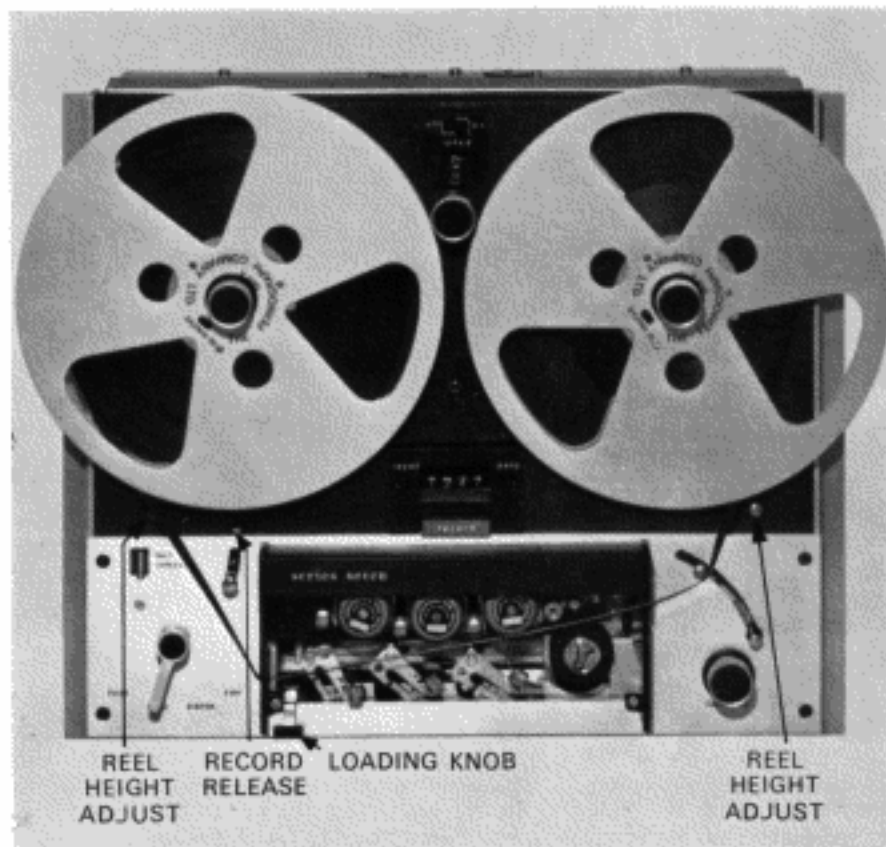

FIG. 5. TAPE LOADING

Temporary stopping of the tape is obtained by turning to "Pause" while at the end of the tape the Function knob should be returned to "Stop".

Record

The Record (and erase) function is obtained by pressing the Record button and turning to "Pause", then "Run". To prevent accidental erasure, once the Function knob has been set to "Pause" or "Run", the Record button cannot be pressed unless the Record Release catch is moved to the left. On allowing the catch to return to the right, the Record button is locked down in the 'on' position.

The Record button is released manually by moving the Record Release catch to the right or automatically on turning the Function

knob to "Stop". It has no effect if pressed on "Stop" or "Fast", nor will it lock down with the Function knob in these positions.

Automatic and Foil Stops

The tape tensioning arm between the head assembly and the take-up reel is differentially damped to prevent any "snatch" on starting the tape. It also functions as an automatic stop and switches off the tape drive should there be a loss of tape tension *e.g.* at the end of a reel. Its operation has a built-in delay of approx. $1\frac{1}{2}$ seconds so that it does not stop the tape due to a momentary loss of tape tension. It does not require any special tape, but it should be set for optimum performance with the deck horizontal or vertical. This is done by turning the control at the extreme of the deck control panel so that the screwdriver slot is in line with 'h' or 'v' respectively.

In the path of the tape between the supply reel and the head assembly is the foil stop guide. When this is shorted to earth (through the adjacent tape tensioning guide) by a piece of foil spliced into the tape, it switches off the tape drive. At the start of a tape fitted with foil at each end, the foil should be wound manually past the foil stop before turning to Run.

As explained previously, once either stop has operated, the Function knob must be returned to "Stop" before the recorder will function again. In the case of "foil stop" the foil must also be cleared from the contacts before the reset lamp can be extinguished.

Fast Wind

On turning the Function switch to "Fast", the tape is controlled by the "Fast Wind" knob, which governs the power fed to each reel motor. On turning it clockwise most power is fed to the right hand motor, on turning it anticlockwise most power is fed to the left hand motor, while in the central position the power is fed equally to both, and the tape will remain stationary. By suitable manipulation the amount of back tension applied to the tape can be arranged so that a suitably tight wind can be obtained in either direction. In general, the more back tension applied the tighter the wind, while with little back tension, a fast but not so even wind will be obtained. The actual smoothness of wind will depend upon other factors such as the tape itself and the reels on which it is being wound.

The turns counter (if properly zeroed) can be used for place location or the signal on the tape can be monitored as described on page 27. The Fast Wind knob should be used to slow down the tape (or to stop it altogether) when the appropriate point is reached, before applying the brakes by turning to "Stop". Obviously the tape must be allowed to come to rest before turning to "Pause" and "Run", and a special lock device is fitted to prevent turning to "Run" accidentally. Accordingly, after turning from "Fast" to "Stop", the catch must be moved sideways to release the lock before the Function knob can be turned on to "Pause".

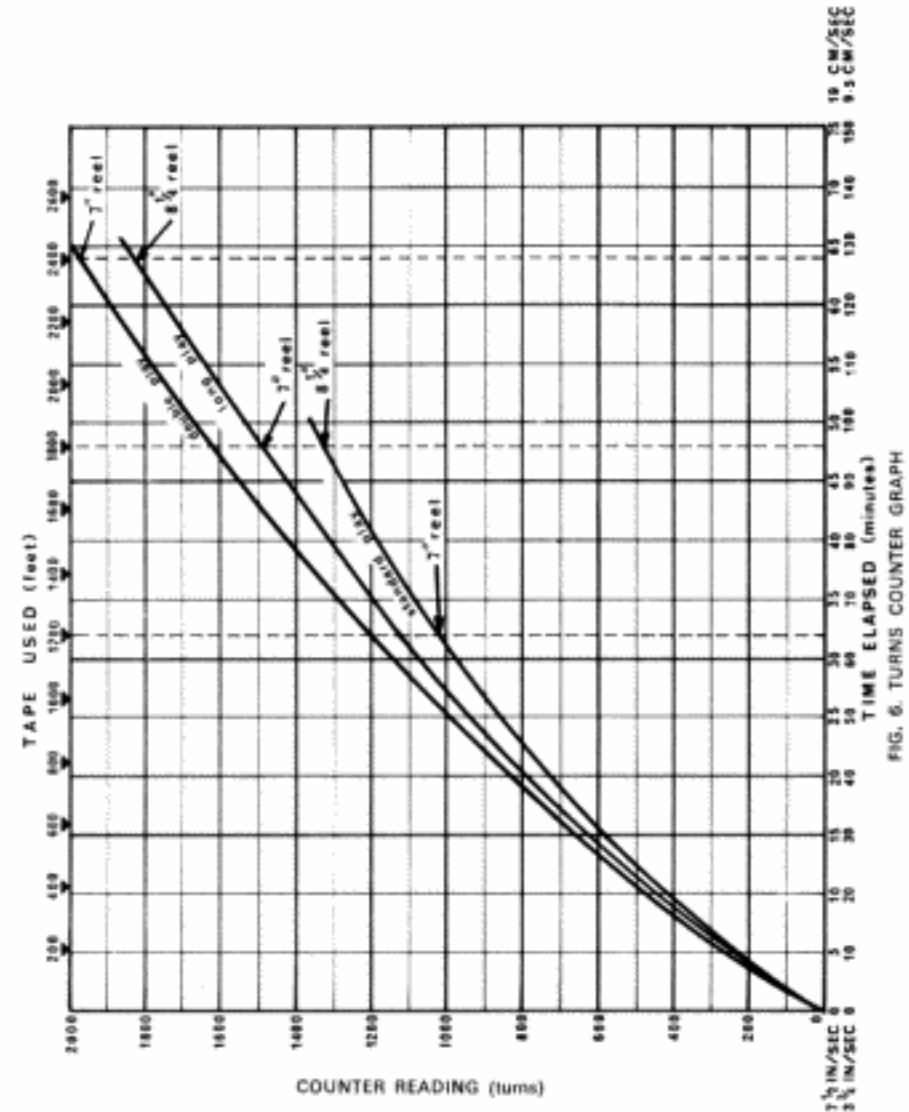

FIG. 6. TURNS COUNTER GRAPH

Note:—When the "Fast Wind" knob is adjusted so that the tape is stationary, the power is being dissipated entirely as heat, and it is therefore inadvisable to leave the Function knob at "Fast" for a long period. As soon as the tape comes to rest, the Function knob should be returned to "Stop".

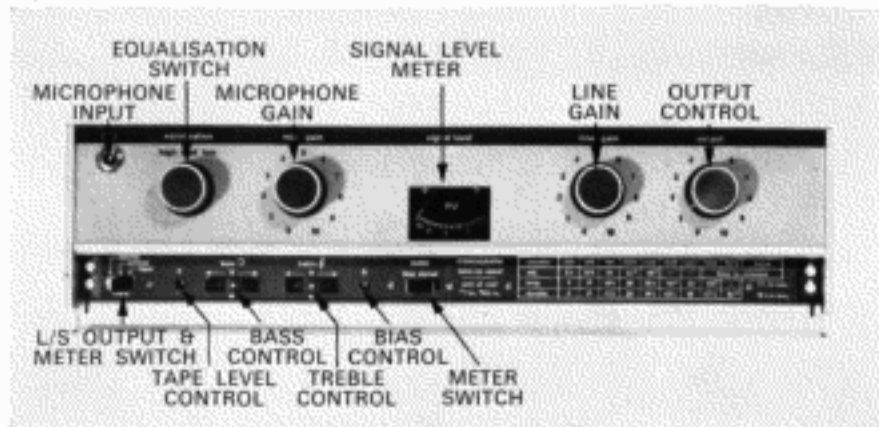

FIG. 7. AMPLIFIER CONTROLS—MONO

REPLAY

The tape should be loaded as on Page 18 and the tape speed and equalisation knobs set to the required positions ("Reset" light out). If the output switch is set to the "Tape" position, on turning to "Run" the signal off the tape will be heard on the loudspeaker, the volume being adjusted by the Output control on the front panel.

If required, the quality of the signal can be modified by the Bass and Treble controls as described below, their usual "flat" setting being at the central position. The signal can be observed on the meter by setting the Meter switch to "Output".

Bass and Treble Controls

The Bass and Treble controls act independently of each other to provide a variable amount of cut or lift as required. At its extreme settings, the Bass control will give approximately 15dB boost or cut at 50Hz and the Treble control will give approximately 10dB boost or cut at 10kHz (Fig. 18, page 48).

Their usual setting is at the central position, when an overall level response is obtained, and this will be correct for most applications, particularly those of engineering and scientific interest. However, in the more general use of the recorder for listening purposes, it is advantageous to be able to make some allowance for the characteristics of the loudspeaker, its acoustic environment (which can alter the audible sound quality) and also the peculiarities of the human ear. In particular, the bass boost can be most useful in improving the sound from the smaller loudspeaker enclosures, on which the bass response is necessarily restricted by physical dimensions, to balance with the usually good high frequency response.

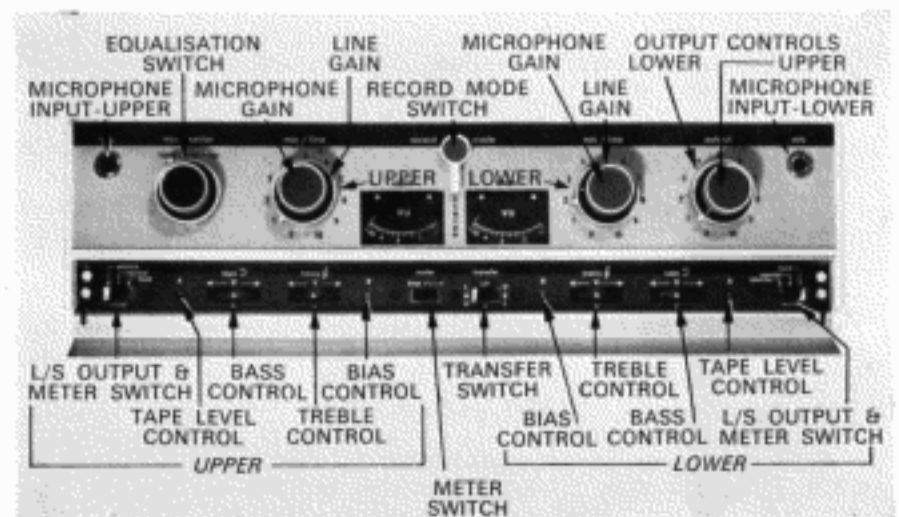

FIG. 8. AMPLIFIER CONTROLS—STEREO

The "tone" controls can also be used to improve a recording by reducing hiss or noise or by increasing the frequency response of a rather limited recording. In each case the other control can also be used to balance the overall sound quality.

While a level response is obtained at their central positions when replaying tapes recorded to the same characteristic as the Ferrograph, tapes recorded to other characteristics can be replayed satisfactorily by using the Bass and Treble controls as explained in the Technical Section, page 49.

Output Switch

The Output switch underneath the front flap selects the signal which is fed to the three outputs and the loudspeakers. When at "Tape" it selects the replay signal off the tape, and at "Source" it selects the signal from the inputs (Line and/or Microphone). If the Meter switch is set to "Output", the Output switch also controls the signal fed to the VU meter.

Meter Switch

As selected by the Meter switch, the meter can be used to read the "Bias", the "Source" signal from the record amplifier, or the "Output" signal as selected by the Output switch.

RECORD

The appropriate connections should be made as described on page 14, and the correct tape speed and equalisation selected. It is advisable to insert or remove the plugs only when the corresponding gain control is at or near zero (fully anti-clockwise) as this avoids switching surges in the amplifier causing loud "plops" in the output stages with possible damage to the loudspeakers.

If at all possible, the gain control setting should be determined before commencing to record. To do this, the Meter switch should be at its centre position "Source" (or at "Output" with the Output switch at "Source"). If a microphone is being used, the loudspeaker must be silenced by turning the Output control to zero.

The input signals can now be observed on the meter and each signal level set independently. When mixing two or more signals, their combined levels should not cause the meter to rise above 0 VU on the scale. The meter has a VU characteristic which is so arranged that the meter pointer should rise up to 0 VU on the very loudest peaks of the signal but should never be driven into the red portion. One possible exception to this might be a very long sustained note (such as from an organ), which could cause the pointer to creep slightly over 0 VU without distortion.

After the gain controls have been adjusted, the Record button should be pressed and the function Switch turned to "Pause", when the meter will be illuminated. The recording is started by turning to "Run", when the tape will start immediately.

The record signal is still shown on the meter and if necessary the record level can be corrected by re-adjusting the gain controls. During the recording the tape can be stopped temporarily by turning to "Pause" then back to "Run". At the end of the recording the Record button is automatically released on turning the Function switch to "Stop".

Interjection

If it is required to insert a recording into a particular part of the tape (interjection), the record signal level controls should be adjusted as above and the tape run through on replay (Record button not pressed). At the required point the Record Release catch should be moved to the left and the Record button pressed, when recording (and erasing) will commence immediately as indicated by the meter illumination. The Record button is locked "on" by allowing the Record Release to return to the right. To end the recording without stopping the tape drive, the Record button can be released by moving the Record Release catch to the left, or the Record button is released automatically on turning the Function switch to "Stop".

Stereo Models

On stereophonic instruments, the two channels should be adjusted independently, or if the Record Mode switch is set to Upper or Lower,

these may be recorded individually as on a normal mono recorder. However, it is inadvisable to adjust the Record Mode selector when actually on Record as this may cause polarisation of the heads, and the mode should be selected before pressing the Record button. When recording monophonically on a stereo instrument, the Transfer switch can be used as described on page 40, but except when specifically required, it must be left at the central "Off" position.

Radio

The radio should be connected as on page 14 and after the radio or tuner unit has been properly tuned in and its tone controls set to their normal or highest fidelity positions, the recording can commence. The meter should not read above 0dB even on the loudest signals, but once the correct gain setting has been found, there should be no necessity to re-adjust it during the recording as the station or studio engineer will be monitoring the programme and correcting the signal level so as not to overload the transmitter.

Gramophone

The connections are given on page 15, and the appropriate gain control should be adjusted for the correct record level. As the dynamic range on disc is very similar to that on tape, once the gain control has been set so that the meter does not quite rise above 0dB on the loudest passages, it should not be necessary to re-adjust it during the transcription.

Microphone

When using a microphone in the same room as the recorder, it is essential that the internal (or external) loudspeaker be silent, or acoustic feedback will occur. This takes the form of a "howl" as the noise from the loudspeaker is picked up by the microphone, amplified and transmitted again by the loudspeaker in a vicious circle, gradually building up in volume. If it is required to listen to the signal, headphones must be used or the signal can be monitored visually on the meter (see page 27).

The chief point of difference between live recording and recording from the radio is that the studio control of dynamic range in the latter is not present. This means that more attention must be paid to the signal level meter and the gain control settings. Depending upon the dynamic range of the programme material, a certain amount of volume compression may be necessary. This involves reducing the level of the loudest passages and increasing that of the weakest so that the former does not overload the tape nor the latter become lost in the background noise. However, too drastic use of the gain control should

be avoided or the contrast between loud and soft passages may be lost altogether.

Microphone Characteristics

Making a "live" recording with a microphone requires close attention to detail for optimum results, as the quality of the recording is dependent, among other things, upon the type of microphone used, the location of the microphone and the acoustics of the room or surroundings. A primary property of the microphone is its directional characteristic, and there are three basic types. The omnidirectional microphone picks up sounds equally from all directions and is very useful for recording sounds from several separated sources, *e.g.* a group of people sitting around a room. The bidirectional microphone has a "figure-of-eight" response and picks up sounds from the front and back, but is largely insensitive to sounds originating at the sides, and this can be very useful in eliminating unwanted background noises. The third type has a unidirectional or cardioid response, picking up sounds from the front and towards the sides (usually over a 180° arc) but being insensitive to sound originating towards the rear. This can be very useful for recording in locations with high background noise and also for stage and concert work in eliminating noises from the auditorium.

While most types of microphone, except high impedance and crystal types, can be used with the Series Seven Ferrograph, it is pointless to restrict the overall fidelity by using the very cheapest. Having regard to all the factors involved, the most suitable for general purposes are the moving coil (dynamic) and ribbon microphones. To match into the microphone input, they should be medium impedance (250-2,000 Ω), but low impedance microphones can be used with a low-to-medium matching unit (TA/30/ML, page 14).

Microphone Placement

The above characteristics are for "free field" or open air conditions, but when used indoors, reflections from plane surfaces such as walls and windows can modify the effective directionality of the microphone and by suitable placement each of the above types can be used in most situations. If desirable, the room reflections can be decreased by drawing curtains over windows, hard furniture, etc., or increased by removing cushions, soft furnishings, etc., and by rolling back the carpet. A certain amount of experimentation may be necessary to find the best position for the microphone, but as the tape recorded during this process can be used again for the recording proper, this is no great hardship. It is advisable to keep the microphone a reasonable distance from the recorder *e.g.* about 5 ft., or to orientate the microphone (if directional) so that the recorder is in an insensitive part of the microphone field, as a certain amount of mechanical noise from the moving parts (especially

the tape) is inevitable, and for highest quality recordings all background noise should be avoided.

Use of Microphones

With regard to the detailed use of a particular microphone, the individual manufacturer will issue appropriate instructions depending upon its type and directionality. However, it is usually undesirable to speak into any microphone unnecessarily closely (particularly if it has been kept in a cold room) as condensation may affect the performance and unless the microphone is specially treated may eventually cause corrosion. With ribbon microphones close talking should always be avoided as this causes bass accentuation, but should it be necessary, due to high local noise, speaking should be across the front at a minimum of 3". On no account should a ribbon microphone be blown into to check that it is functioning as this may damage the delicate ribbon, and for this reason, it should not be used out of doors on a very windy day. In general, all microphones should be treated with the care they deserve and severe shocks should be avoided.

Monitoring

As all Series Seven Ferrographs have separate record and replay heads, it is possible to monitor the signal off the tape whilst recording, and this can be done aurally (loudspeaker or headphones) by setting the Output switch to "Tape". The replay signal can also be observed on the meter if the Meter switch is set to "Output".

On setting the Output switch to "Tape", then "Source", and back again, the replay and record signals can be compared aurally or visually. Their levels are normally set for Ferrotape type B such that the meter indication on "Tape" is the same as on "Source" for easier comparison of the signal quality, and hence the record signal level can be checked on the meter even with the Output switch at "Tape". This will apply to most of the standard good quality tapes, but if it is required to use tape which has an output markedly different from Ferrotape, it is possible to readjust the "Tape" level as outlined in the Technical Section, page 48.

The recording can be monitored aurally by a loudspeaker (internal or external) or by headphones connected as on page 17, or alternatively an external amplifier and loudspeaker could be used. When using a microphone for recording, the loudspeaker must be silent to avoid acoustic feedback (see page 25), and audible monitoring must be done using headphones. If these are not available the meter can provide a useful check that the signal is being recorded by setting the Output switch to "Tape" and the Meter switch to "Output".

On Fast Wind, audible monitoring can also be used for place location on the tape (Output switch at "Tape"), when the signal is heard as a

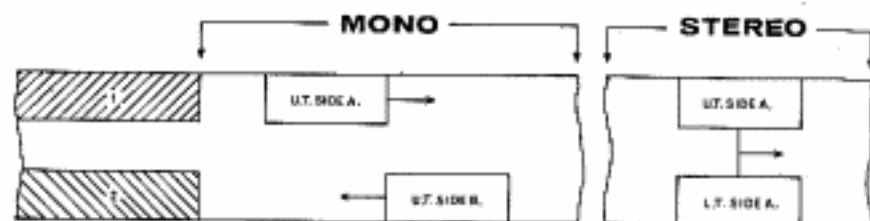

FIG. 9. TRACK DISPOSITIONS—HALF TRACK

high pitched gabble, depending upon the speed of the wind. To avoid a shrill, irritating sound when the tape is travelling at high speed, the high frequency response is automatically reduced on "Fast", and consequently if the tape is slowed down to nearly normal speed it may seem a little muffled. If not required, the Output control should be turned down or the Output switch set to "Source".

GENERAL DETAILS

Changing Tracks

The disposition of the conventional monophonic track upon the tape is shown in Fig. 9, the advantage of this system being that two tracks can be accommodated side by side on the tape, which doubles the length of playing time per reel. In practice, after a full recording has been made upon the top track in the normal way, the left hand spool will be empty and all the tape on the right hand reel. They should each be removed and replace on the opposite reel carrier, the tape being loaded in the usual way. The unrecorded lower half of the tape has now become the upper and may be recorded as usual. At the end of the reel the tape can be reversed again, when the first recording will again be on the upper half and ready for replaying. Thus on a full 7 in. reel of Long Play tape up to $1\frac{1}{2}$ hours playing time is available at $7\frac{1}{2}$ in./sec. with a break of only a few seconds half way for the reel transposition.

If required, the tracks may be reversed in the middle of a reel. After stopping and opening the loading gate, both reels should be removed and inverted. They can then be refitted to the opposite sides and the tape threaded through the heads in the usual way, with no twists. After loading the tape, the loading gate must be closed before the deck can become operational again.

On half track stereo instruments, recording should proceed as usual (Fig. 9), but since both tracks are recorded, the tape cannot be

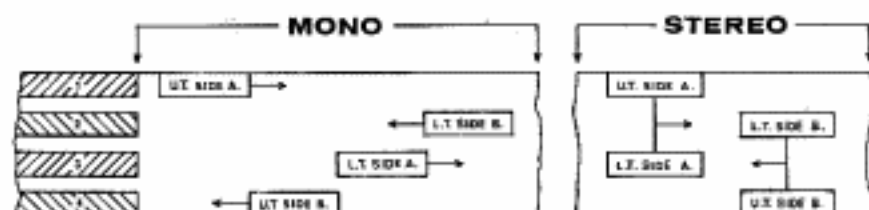

FIG. 10. TRACK DISPOSITIONS—QUARTER TRACK

reversed at the end of the reel. However, when used monophonically on "upper", the stereo recorders will operate exactly as described for the mono recorder above.

The quarter track stereo arrangement is shown in Fig. 10. After recording on tracks 1 & 3 the tape can be reversed and another recording made on tracks 2 & 4 as shown. When recording monophonically the usual track sequence is 1 - 4 - 3 - 2. This is obtained by first recording on "upper" on side A of the reel (track 1). At the end of the reel the tape is reversed and recorded on side B, still on "upper" (track 4). Reversing the tape at the end, recording takes place on "lower" on side A (track 3), leaving the final recording on "lower" on side B (track 2).

Editing and Splicing

One of the advantages of a tape recording is that it is easily edited; unwanted passages may be cut out and the ends rejoined. In this way a composite programme of selected material may be built up. Of course, it is only possible to edit one mono track, as cutting out or splicing in pieces of tape obviously affects both tracks. However, once the editing has been done for the single track, the composite tape may be put back on the recorder and the other track recorded in the normal way with material which does not require editing.

Splicing and joining the ends of cut or broken tape is normally carried out by means of suitable adhesive tape applied to the back of the magnetic tape, which is usually the more polished side. For joining together two lengths of tape with as unobtrusive a joint as possible, a diagonal cut at 45° to the edge of the tape is used. This produces a "silent" joint and minimises any "drop-out" effect which may occur if the two ends of the tape do not meet quite accurately. When editing tapes, particularly when removing single words or noises, a vertical joint at right angles to the tape edge is often used, and this is also suitable for adding leader tapes and inserting stop foils. With either

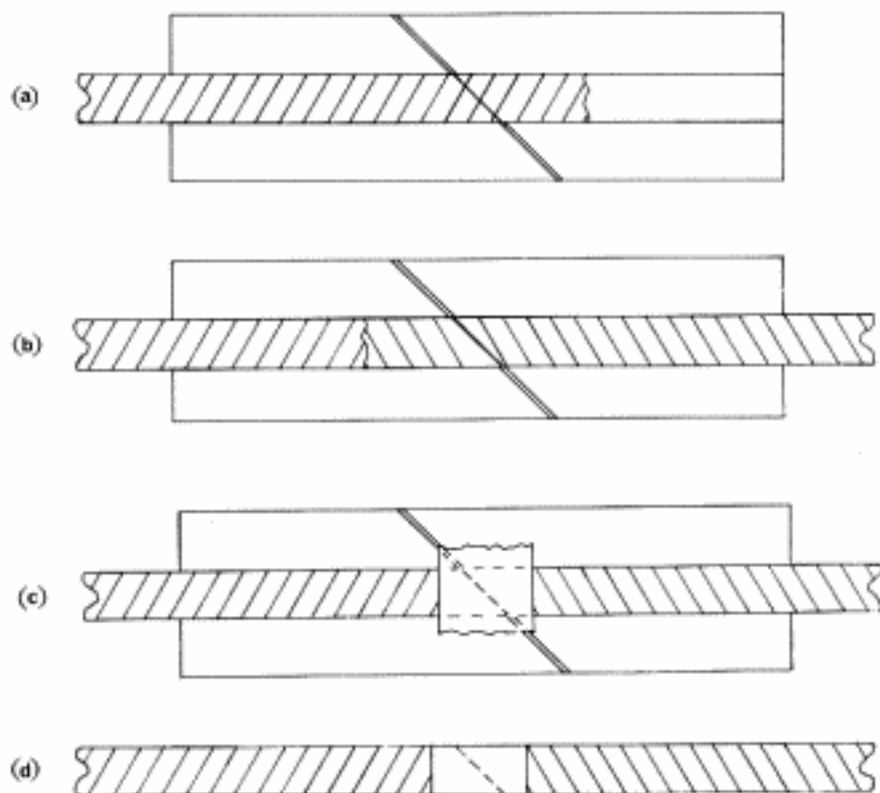

FIG. 11. TAPE SPLICING

angle the joining procedure is the same, although in some cases more care may be needed to ensure that the cut is made at exactly the right point on the tape.

First of all, one of the pieces of tape should be placed, backing uppermost, along the channel in the splicing block and pressed gently into it, if necessary aligning the correct part of the tape opposite the appropriate slot. A very sharp cutter or razor blade should be drawn smoothly along the slot and through the tape. The unwanted part of the tape should be removed and the procedure repeated with the other piece of tape which is to be joined fed in from the other end. On removing the second unwanted length of tape, the two parts to be joined are left in the channel with their ends accurately butted together. The piece of splicing tape can now be pressed firmly on to the tape so as to cover the joint.

Two basic sizes of splicing tape are available and this determines the precise way in which each is applied. The $\frac{1}{2}$ inch wide splicing tape should be applied across the tape, which should then be removed from the block and the surplus trimmed level with the edge of the tape. The trimmed splicing tape should not project over the edge as this may catch in the tape guides; on the other hand the trimming cut should not encroach too much into the magnetic tape as this will reduce the signal at that point, which is particularly important with quarter track tapes. The other size of splicing tape is the same width as the recording tape and a strip about $\frac{1}{2}$ inch long should be placed along the length of the tape. This must be laid very carefully and if it is not quite accurate, any overlap of splicing tape must be removed.

Note:—When removing the tape from the channel, it is advisable to “peel” the tape out at an angle, since to pull it out vertically may damage the edges of the tape.

If required, steps *a* and *b* can be combined by placing the two tapes one above the other before making the single cut. The top “unwanted” piece of tape should be removed immediately, the other being removed after the splicing tape has been applied.

If a splicing block is not available, the two pieces of tape should be held firmly together and the appropriate cut made using a pair of sharp scissors. The two ends should then be butted together accurately and the splicing tape applied to the backing, when it can be trimmed as usual.

Spools

The reel carriers on the Series Seven Ferrograph recorders are specially designed so that any type of spool conforming to the international standard can be used. To accommodate different thicknesses of spool, the reel carriers are adjustable in height by turning the screws indicated in Fig. 5 :- clockwise to raise and anti-clockwise to lower. To cater for vertical operation of the deck, reel retaining knobs are provided for ordinary spools and these are also useful if it is required to leave the reels on the recorder during transportation. However, the Hublok reels have a built-in device for this and when fitting or removing them the small projection should be moved in the direction of the arrow. The tape can also be fastened to the reel by pressing one coloured portion radially inwards and inserting the tape end behind the other.

Again, different sizes of spool can be used on the Ferrograph from the maximum diameter of $8\frac{1}{2}$ in. to the very small, but while the performance may still be satisfactory when using the small “message” spools, the tape speed constancy cannot be guaranteed if those having an inside diameter of less than $1\frac{1}{2}$ in. are used. Also, the brakes are adjusted for

<i>Playing Time Per Track</i>				
Length of Tape	15 in./sec.	7½ in./sec.	3¾ in./sec.	1⅞ in./sec.
150 ft.	2 min.	4 min.	8 min.	16 min.
200 ft.	2½ min.	5 min.	10 min.	21 min.
300 ft.	4 min.	8 min.	16 min.	32 min.
400 ft.	5 min.	10 min.	21 min.	42 min.
450 ft.	6 min.	12 min.	24 min.	48 min.
600 ft.	8 min.	16 min.	32 min.	1 hr. 4 min.
900 ft.	12 min.	24 min.	48 min.	1 hr. 36 min.
1,200 ft.	16 min.	32 min.	1 hr. 4 min.	2 hr. 8 min.
1,800 ft.	24 min.	48 min.	1 hr. 36 min.	3 hr. 12 min.
2,400 ft.	32 min.	1 hr. 4 min.	2 hr. 8 min.	4 hr. 16 min.
3,600 ft.	48 min.	1 hr. 36 min.	3 hr. 12 min.	6 hr. 24 min.
4,800 ft.	1 hr. 4 min.	2 hr. 8 min.	4 hr. 16 min.	8 hr. 32 min.

correct operation with spools of equal size and weight on each side. Should it be found necessary to use dissimilar spools, e.g. a small plastic spool with a large metal spool, this can be done satisfactorily on "Run" but on "Fast" the tape should be slowed down (using the Fast Wind knob) until almost stationary before moving the Function switch from "Fast" to "Stop". This is particularly important if using very thin tapes.

It will be observed that the large, 8½ in. diameter spools overhang the deck slightly, and only those of 7 in. diameter or less can be left on the recorder with the lid fitted. The approximate lengths of tape which are normally accommodated on the various sizes of spool are given in the table.

<i>Approximate Length of Tape Per Reel</i>				
Size of Reel	Standard Play	Long or Extra Play	Double Play	Triple Play
3 in.	150 ft.	225 ft.	300 ft.	450 ft.
3½ in.	200 ft.	300 ft.	400 ft.	600 ft.
4 in.	300 ft.	450 ft.	600 ft.	900 ft.
4½ in.	400 ft.	600 ft.	900 ft.	1,200 ft.
5 in.	600 ft.	900 ft.	1,200 ft.	1,800 ft.
5½ in.	900 ft.	1,200 ft.	1,800 ft.	2,400 ft.
7 in.	1,200 ft.	1,800 ft.	2,400 ft.	3,600 ft.
8½ in.	1,800 ft.	2,400 ft.	3,600 ft.	4,800 ft.

Tape

The Series Seven Ferrograph is set up for use with Ferrotape, and its specification is obtained using tape of similar quality and characteristics. As supplied the bias is set for "low noise" tape such as Ferrotape type B, Scotch Dynarange tape, etc., and certain continental tapes, but if it is required to use Ferrotape type A and other similar tapes, the bias can be adjusted for optimum results as outlined in the Technical Section, page 46.

In addition to Standard and Long Play Tapes, Double Play tape can be used with satisfactory results, particularly at the slower speeds where its more flexible backing gives a more intimate contact with the working face of the head, leading to a more constant output, especially at the higher frequencies. Triple and Quadruple Play tapes can also be used, but due to their different oxide formulation they give greater distortion at the higher recording levels and the recording should be made at a lower level than usual. They may also give excessive output at the higher frequencies.

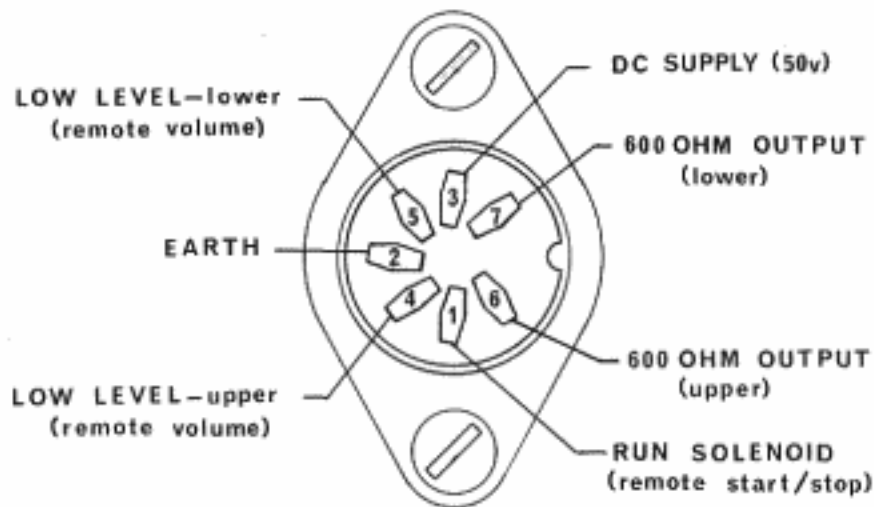

FIG. 12. AUXILIARY SOCKET CONNECTIONS

Auxiliary Socket

The Auxiliary Socket is situated at the rear of the recorder and is intended to augment the facilities and capabilities of the instrument. It is a 7 pin socket conforming to the D.I.N. specification and into it can be inserted the standard 3 pin, 5 pin and 7 pin D.I.N. plugs, connecting to pins 1 to 3, 1 to 5 and 1 to 7 respectively. The pin connections are shown in Fig. 12, pin 2 being Earth. Pins 1 & 2 are used for remote starting and stopping of the tape (e.g. with a foot switch) with the recorder in the "Pause" position; pin 3 will provide up to 200mA D.C. from the +50V supply for powering various ancillary units. On the mono recorders, the Low Level output is wired to pin 4, the 600 Ω output to pin 6 and pins 5 & 7 are unconnected. On the stereo recorders, the Low Level outputs are wired to pins 4 (Upper) and 5 (Lower) and the 600 Ω outputs to pins 6 (Upper) and 7 (Lower). These output connections can be used for a remote volume unit, remote level indicators, Signal operated Switching Unit, etc.

EXTERNALLY CONTROLLED OPERATION

As the Series Seven deck uses electromagnetic actuators, the instrument can be controlled externally to perform various functions as described on the next page.

Time Switch

Unattended control by time switch is a very useful facility and is achieved as follows:—

The recorder should be loaded with tape and if necessary wound on to the required point. The time switch should then be connected into the mains lead of the recorder and the recorder controls set to whatever operation is required. For replay, the Function switch should be set to "Run", and the output and tone controls to pre-determined positions. For record, the Function switch should still be at "Run" with the "Record" button depressed. The Line and/or Microphone gain controls should be set to pre-determined positions to give a suitable signal for recording. *Check that the Mains Switch of the recorder is at "On".*

When the time clock switches on the mains the tape will start up and replay or record as arranged. When the time clock switches off, the tape will stop, and this operation can be repeated as arranged on the timing device. Should the tape run out before the timer switches off, the auto stop will operate and shut off the tape drive, the recorder remaining energised until the timer switches off the mains.

Remote Operation

Start/Stop

The Series Seven Ferrograph can be remotely started and stopped on Record or Replay by the closing and opening of a pair of contacts connected to pins 1 & 2 of the Auxiliary Socket. A 3, 5 or 7 pin D.I.N. plug can be used. The two leads (Fig. 12) should be wired to a switch (or pair of contacts) which is normally open, and the recorder left energised in the "Pause" position (with or without the Record button pressed). On closing the switch, the "Run" solenoid will be energised and the tape drive started. On opening the switch the tape drive will stop. This can be repeated as required and since the motors and capstan are energised continuously, the start and stop will be practically instantaneous. One example of this method is the use of a footswitch when the hands are otherwise engaged, and such a switch is available as an accessory.

Volume

The volume of the signal fed to the internal loudspeakers and the Loudspeaker output can be varied remotely by connecting a 5K Ω , logarithmic potentiometer as a variable resistance across the Low Level output. This could be on the jack socket itself or on the Auxiliary Socket; for mono recorders between pins 4 & 2, for stereo recorders between pins 4 & 2 (upper) and 5 & 2 (lower) using separate earth leads for each channel. A seven or five pin D.I.N. plug should be used.

The maximum volume (with the variable resistance at maximum) is still governed by the Output control on the recorder, but adjusting the remote control will vary the signal from this down to zero.

Signal Operation

The Auxiliary Socket on the rear panel is arranged to accept a Signal operated Switching Unit. This unit is designed to drive the tape only when a signal is present for recording and to switch off the tape drive when the signal ceases. To allow for short gaps in the signal *e.g.* pauses in speech, the Switching Unit has a built-in delay of 5-25 secs. before switching off. Thus by omitting the long silent periods when no signal occurs, messages, etc., spread over a long time can be recorded onto a single tape.

After plugging the Switching Unit into the Auxiliary Socket, the recorder should be set in the "Pause" position with the "Record" button pressed and the record gain controls adjusted to pre-determined settings. *The appropriate Output Switch must be set to "Source"*.

SPECIAL APPLICATIONS

Echo Effect

Due to the physical spacing of the record and replay heads there is a finite delay between the record and replay signals which corresponds to the time taken for the tape to travel between the two heads. At $7\frac{1}{2}$ in/sec. this is approximately $\frac{1}{8}$ sec. ($\frac{1}{16}$ sec. at 15 in/sec., $\frac{3}{8}$ sec. at $3\frac{3}{4}$ in/sec., $\frac{3}{4}$ sec. at $1\frac{1}{2}$ in/sec.). Thus part of the replay signal fed back into the record amplifier will give the effect of an echo whose magnitude will depend upon the amount of signal fed back.

The Meter switch should be set to "Source" and the Output switch to "Tape". A lead should then be connected between the 600 ohm output and the Line input (Line gain control at zero). The signal to be recorded should be fed into the Microphone input, and its gain control advanced to a suitable record level. On turning to Run and pressing the Record button, the echo can be added to the record signal by gradually turning up the Line gain control. Care should be taken not to set the echo too high as this may cause it to build up, leading to instability.

When applying echo to a stereophonic recording, each channel should be connected as described above, taking care to adjust the controls to give approximately the same amount of echo to each channel, unless an unbalance is intentionally required.

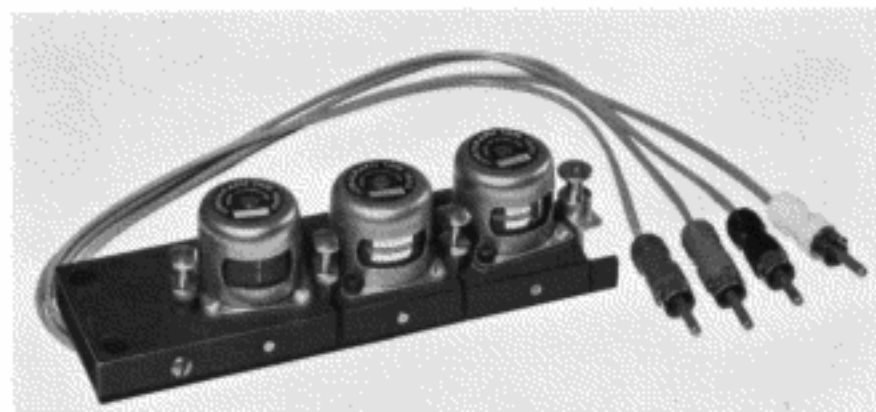

FIG. 13. HEAD BLOCK—STEREO

When recording monophonically on the stereo models, the Transfer switch can be used to apply echo without external connections, as described on page 43.

Use as an Amplifier

By setting the "Output" switch to "Source", the Series Seven Ferrograph can be used as a "straight-through" amplifier, providing up to 10 Watts output to the internal or external loudspeaker(s). It can be used in conjunction with a tuner unit, radio or turntable, or it can be used with a microphone as a "public address" system. The mixing facilities can be used and the output signal modified by the Bass and Treble controls.

Cabinet Mounting

The Series Seven Ferrograph can be fitted into consoles or cabinets with or without its standard case. When in the case it will fit into a space $16\frac{3}{4}$ in. wide by $17\frac{1}{2}$ in. long and about $7\frac{1}{2}$ in. deep with $2\frac{1}{2}$ in. top clearance. The 7 in. reels will fit within the confines of the deck, but $8\frac{1}{2}$ in. reels will overlap the case by about $\frac{1}{4}$ in. at each side.

To remove the recorder from its case, it should be stood vertically (handle at the top, amplifier at the bottom) and all connections to the rear panel removed, also all fuses. The handle should be lifted and first one end then the whole handle pushed down into the recess to take it clear of the inside of the case (Fig. 15), when the four bolts on the floor of the case can be unscrewed. The recorder chassis should be slid forward and the two loudspeaker leads unplugged, one at each side, when the chassis can be lifted clear of the case.

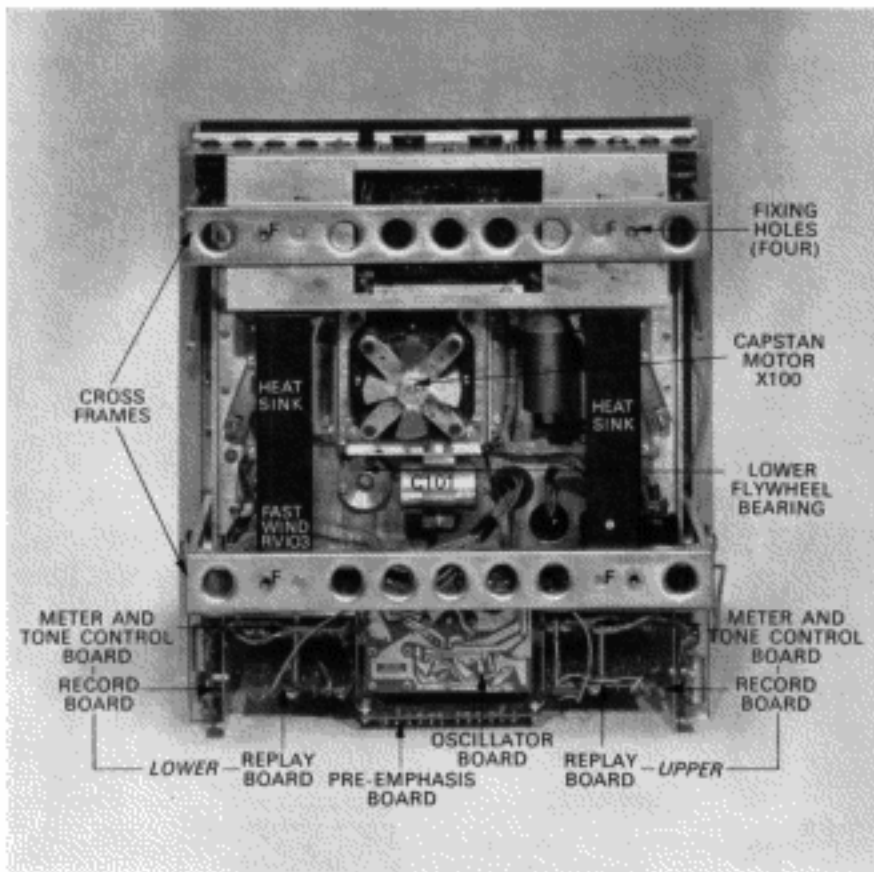

FIG. 14. RECORDER CHASSIS—REAR VIEW

It is refitted into the case in the reverse manner. When doing so, a length of tape or string should be inserted between one end of the handle and its recess so that after insertion into the case, the handle can readily be pulled out of the recess by means of this loop.

When mounting the chassis in a cabinet, it should not be supported by the two aluminium side frames but the two steel "U" frames should rest on the floor (or supporting beams) and if required, it can be held in position by the four bolts used to hold it in the case. When fitting into the new cabinet, a clearance of at least $\frac{1}{8}$ in. should be left at the sides to ensure adequate ventilation; Fig. 15 gives the overall dimensions of the chassis. A metallic screen (e.g. aluminium foil) should be placed across the front of the amplifier and earthed to the chassis, as shown in Fig. 15, to prevent hum.

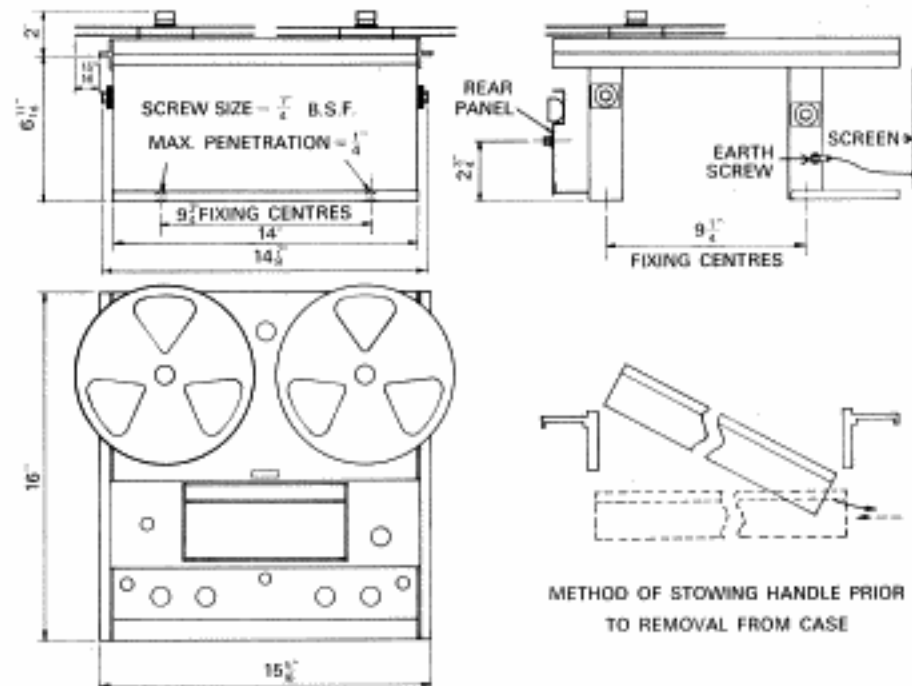

FIG. 15. CHASSIS MODEL DIMENSIONS

STEREOPHONIC MODELS ONLY

On the dual channel Series Seven Ferrographs, each channel is exactly as described in the rest of the text but with the addition of a Transfer switch, giving various facilities in mono operation, and a Record Mode switch (Upper-Stereo-Lower) which selects the track(s) on which the recording is to be made. This Record Mode switch should not be turned while the Record Button is depressed as this may polarise the record head, leading to increased background noise and hiss on the recording (see Important Notice, page 12).

When used for recording or replaying stereophonically, each channel will operate independently of the other and in the absence of specific instructions with a pre-recorded tape, it is usual to have the external loudspeakers disposed 7-10 ft. apart with the Upper Track on the left. The record gain controls and meters are arranged to this convention (Fig. 8), and of the dual knobs adjacent to the meters the top knob controls the Microphone input and the bottom knob the Line input. Of the Output controls the bottom knob controls the Lower track and the top knob the Upper track.

In mono operation the Record Mode switch should be at Upper or Lower, the more usual being Upper as this is the conventional track used on standard mono recorders. Again, the operation is as described in the manual except that the Transfer switch can be utilised if required

If it is required to use both output stages for the same signal, both Low Level outputs (or pins 4 & 5 on the Auxiliary Socket) can be connected together. On turning up the speaker controls, both speakers will give the same signal. If a mono tape is to be replayed into both speakers, the Output switch on the other track should be set to "Source" and the Line and Microphone gain controls turned to zero.

Transfer Switch

Multiplay

The Transfer switch enables the signal from one track of a tape to be fed into the Line input of the other track without the need for external connections, and to be re-recorded. If required, a second signal can be mixed with the first and repetition of this process can give "multiplay" recording.

If it is required to copy a signal from the Lower track onto the Upper track and simultaneously to add another signal, the Transfer switch should be set to L→U and the Lower Output switch to "Tape". On starting the tape the Lower replay signal will register on the Upper meter with the strength determined by the Upper Line gain control and the quality governed by the Lower Bass and Treble controls. The second signal should be fed into the Upper Microphone input and adjusted to the required level by the Upper Microphone gain control, the resultant composite signal being heard through the Upper amplifier and loudspeaker (or headphones). If the second signal is not suitable for the Microphone input, it could be fed to the Line input but both signals will be adjusted by the one control. This means that the relative volumes of the two must be set by an external volume control for the second signal. Re-recording from Upper to Lower can be done similarly.

Immediately after use the Transfer switch should be returned to its central "Off" position.

4 Input Mixing

The Transfer switch can also be used to provide 4 input mixing when recording monophonically on either track. Taking the Upper track as an example, the Transfer switch should be set to L→U and both Output switches to "Source". The signals from the Lower Microphone and Lower Line inputs are then connected to the Upper Line input, and while each is still subject to its own gain control and the Lower Tone controls, the Upper Line control acts as a master control. The Upper Microphone is adjusted by the Upper Microphone control completely independently of the other signals.

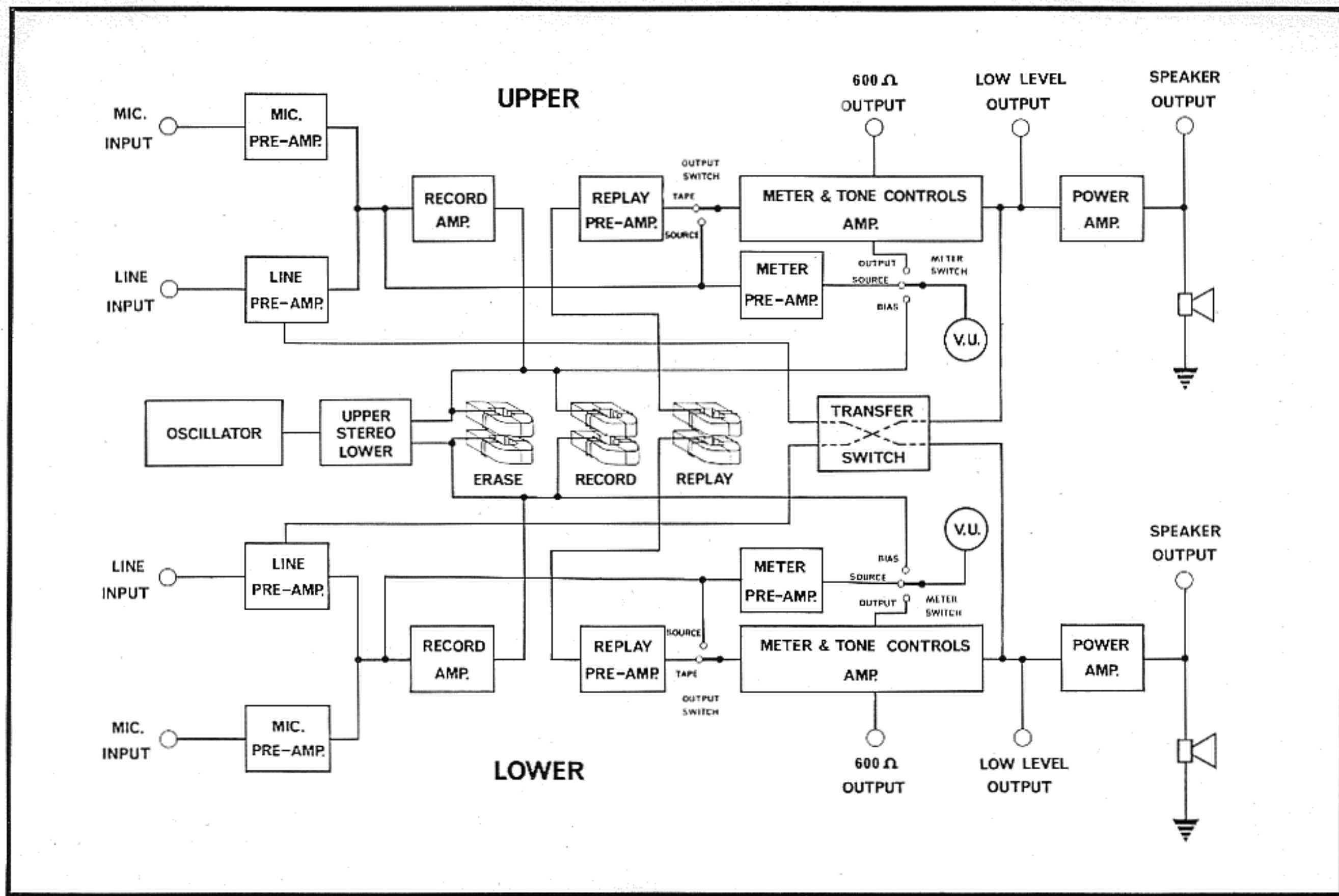

FIG. 16. BLOCK DIAGRAM—STEREO MODELS
41

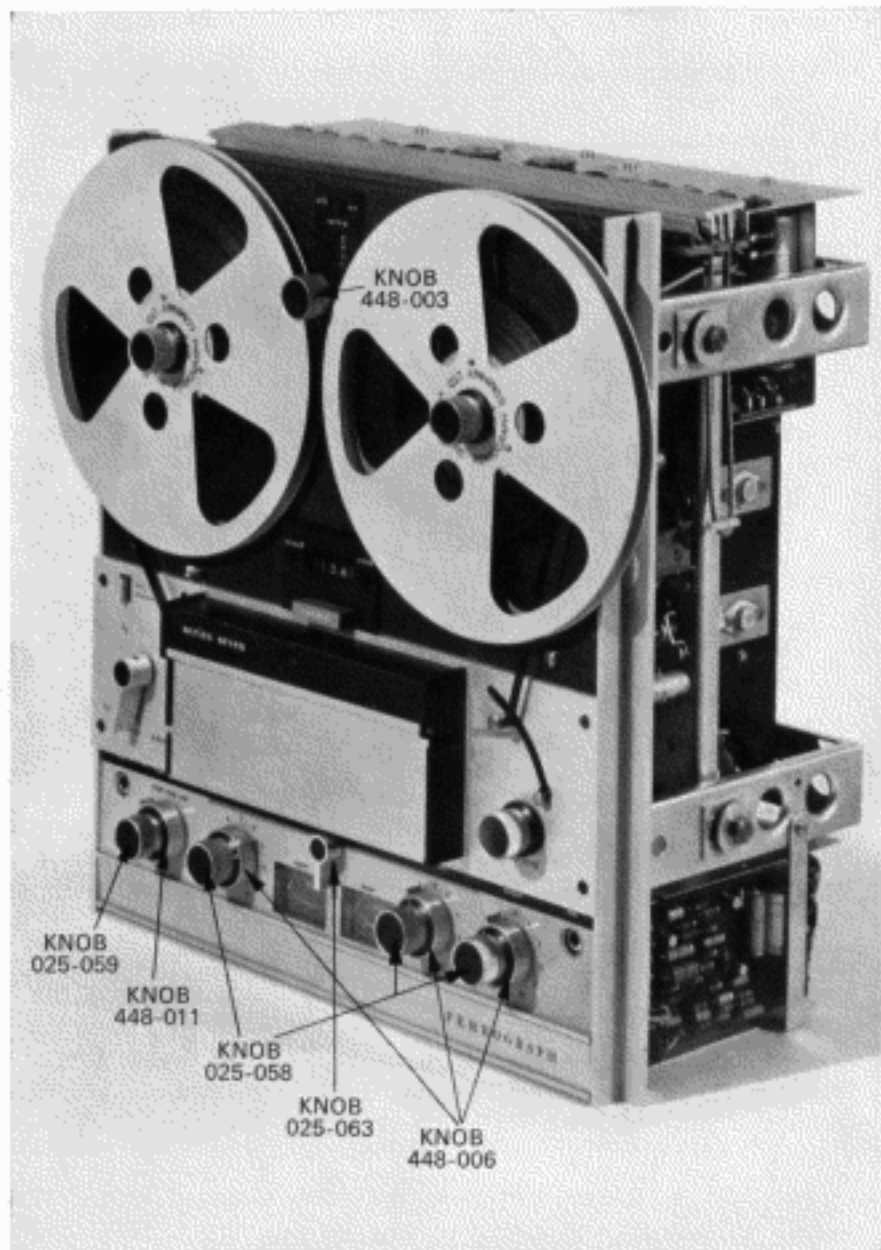

FIG. 17. RECORDER CHASSIS—FRONT VIEW

If it is required to use the Upper Line Input in addition to one or both of the Lower inputs, the Lower signals should be adjusted relative to it by their individual gain controls and the overall signal strength adjusted by the Upper Line control.

The reverse will apply when recording on the Lower track.

Echo Effect

The remarks in page 36 still apply, particularly for stereo recording, but when used monaurally the need for external connections can be avoided by use of the Transfer switch. This is done on the Upper track by setting the Transfer switch to U→L and the Upper Output switch to "Tape", when the amount of echo will be set by the Upper Line control and the quality by the Upper Tone controls. The echo is applied to the Lower Track with the Transfer switch set to L→U and the Lower Output switch at "Tape".

Quarter Track

After recording stereophonically with a quarter track instrument on tracks 1 and 3, the tape can be reversed and another recording made on tracks 2 and 4 as shown in Fig. 10. In all other respects the operation is exactly as described above.

When recording monophonically the usual track sequence is 1-4-3-2. This is obtained by first recording on Upper on side A of the reel (track 1). At the end of the reel the tape is reversed and recorded still on Upper on side B (track 4). Reversing the tape at the end, recording takes place on Lower on side A (track 3), leaving the final recording on Lower on side B (track 2).

Standard mono half track tapes can be played on the Upper track, but if it is attempted to replay stereo half track tapes, the Lower track output will be low due to the track dispositions of the two systems (compare Figs. 24 & 25).

Due to the narrower tracks, quarter track recorders are more susceptible to "drop-outs" in the tape and to the effect of dust and dirt. For this reason it is recommended that Long or Double Play tapes be used as their more flexible backing gives a more intimate contact with the tape heads. Double Play tape is particularly recommended for the slower tape speeds. Even when using pressure pads, particles of dust, dirt or tape oxide can cause poor contact and the tape path and faces of the heads should be cleaned frequently. If a particular tape produces this effect, it can often be improved by fast winding the tape directly between the reels in contact with a clean cloth folded over the tape.

Models 702 and 704

The preceding Operating Instructions apply to Models 722 & 724. Models 702 & 704 are identical, but do not have power amplifiers or loudspeakers. The Loudspeaker outputs are replaced by Low Level Adjustable outputs which provide the same signals as the other Low Level outputs but with the levels adjusted by the Output controls.

CARE AND MAINTENANCE

Little actual maintenance is necessary with the Ferrograph beyond the periodic removal of dust and dirt from the head assembly. After a time, particularly when new tape is being used, loose oxide coating from the tape will accumulate on the working faces of the heads. This will lead to a reduction in the high frequency response of the replay head and sometimes to a reduction in the recorded signal level from the record head, and if allowed to accumulate for a long period on the erase head it can even affect the erasure. The working faces of the heads can be exposed by raising the head cover and opening the loading gate. A small brush is supplied with the recorder and this can be used to clean the heads by moving it gently back and forth across the face of each head in turn. The record and replay heads are vital parts and their working faces should be treated with great care; nothing abrasive should be allowed to touch them as they have been given a very high polish and this is a very desirable condition to maintain. The head cans should not be disturbed or removed as the gap setting (or alignment) of the head faces may be upset with subsequent loss of performance, nor should steel tools be used near the heads as any magnetisation in them may cause permanent magnetism in the heads with deleterious effect. Should this occur, it will be necessary to use a defluxer (see Appendix B) as described on page 12.

Tape oxide will also accumulate on the driving surfaces of the capstan and pinch roller, reducing the traction and leading to slip in the tape drive. This will produce speed variations ("Wow" and "Flutter") which may become noticeable as variations in pitch. To avoid this the capstan and pinch roller should be cleaned regularly with a lightly damped fluff-free cloth. Care should be taken not to damage these driving surfaces as this could also cause "Wow" and "Flutter". At the same time the contact/guide at the end of the Auto stop arm should be cleaned, as accumulation of tape oxide can prevent the contacts from making properly.

Should it be necessary to replace one of the fuses on the rear panel, these are type 20 m.m. long x 5 m.m. dia. rated at 1 Amp, except for Mains fuse on the 117V model (Suffix A) which is 20 mm. x 5 mm. dia. rated at 2 Amp. Any interior adjustments should be left to experienced service engineers who have the necessary specialised instruments for correct alignment.

TECHNICAL SECTION

TECHNICAL DETAILS

This section contains technical information and descriptions of circuitry to enable the more sophisticated user to obtain maximum benefit from the instrument. However, while explanations are given in detail, re-adjustment of pre-set controls should not be attempted without adequate understanding of each operation.

220V, 50Hz Power Supply

If it is required to use the standard recorder (240V, 50Hz) from a 220V, 50Hz supply, this can be done by removing the recorder from its case (page 37), thus exposing the underside of the power unit (Fig. 14). The wire link across the 240V tags should be removed and a link soldered across the 220V tags. The recorder can then be refitted into the cabinet (page 38) and connected to the 220V, 50Hz supply. (Note:—Voltage selector tagboard is not fitted to 117V, 60 Hz models).

Record

The basic connections and recording functions are described on pages 14 & 24 but the following notes are apposite.

Crystal Pick-up

While overloading will not occur when feeding high output crystal pick-ups into the Line input, it may be that the gain control is operating over an inconveniently small part of its range. This can be cured by connecting a capacitor (1,800 pf) across the leads viz. in parallel with the pick-up, when the output will be attenuated to a more suitable level.

Constant Tones (Frequency Response)

When recording constant tones (e.g. sine wave) from a source connected as in page 14, a level of recording higher than that suitable for audio signals is sometimes permissible. The signal level meter has the standard VU characteristic which calibrates 0 VU on the scale as 4dB below peak recording level to allow for transient peaks in the average audio signal (e.g. orchestral music), and thus constant tones of up to 2000Hz approximately can be recorded at +3dB on the meter scale without overloading the tape. With frequencies above this it is necessary to record at a lower level to avoid tape saturation due to the pre-emphasis of the record characteristic. Accordingly, recordings of a wide range of tones such as a frequency response check should be made with a reference level of 20dB below peak recording level.

Bias Adjustment

The bias on the Series Seven Ferrograph can be adjusted by the screw-driver pre-set control 'B' at the front of the recorder and its value can be observed on the meter by setting the Meter switch to read "Bias". The meter is calibrated at $7\frac{1}{2}$ in/sec. such that at 0dB the bias is suitable for "Low Noise" tape such as Ferrotape type B or Scotch Dynarange tape, and at -2dB it is suitable for the standard Ferrotape type A. The recommended bias settings (equalisation switch at the $7\frac{1}{2}$ in/sec. position) for various brands of tape are given below. These are intended as a guide and tapes not included in the list can also be used on the Ferrograph with average bias settings or with a suitable setting determined by experiment to give the best result.

Decreasing the bias will improve the high frequency response but at the expense of increased distortion and probably a lower signal output, and the final adjustment of the bias will be a compromise between these three factors. If a constant amplitude low frequency sine-wave is available (about 500Hz), the tape should be run at the $7\frac{1}{2}$ in/sec. tape speed and the bias set to slightly higher than that value which gives maximum output of the replay signal as shown on the meter (Meter switch to "Output", Output switch to "Tape"). On setting the Meter switch to "Bias" the reading suitable for that brand of tape can be noted and recorded in the blank spaces of the table.

Bias Reading	Brand of Tape
-2	Ferrotape — Type A; Scotch — 215 (150) Ampex — 541 and 631; Irish — 601 Emitape — 99 (old); Kodak — V150
0	Ferrotape — *Type B; Scotch — *203 Ampex — *444; Agfa — PE31, *PE36 & *PER525 B.A.S.F. — LGS35 and *LP35LH; Philips — *LP Emitape — *815 & *99 (new)
Bias measured at $7\frac{1}{2}$ in/sec. *Indicates "low noise" tape	

The best compromise between Signal/Noise ratio, distortion and frequency response is obtained with a slightly different bias value at each tape speed. Consequently, the circuit is arranged to adjust the bias automatically to the optimum value appropriate to each position of the Equalisation switch. It is for this reason that the meter bias readings should be noted or reset only when switched to the $7\frac{1}{2}$ in/sec. equalisation position.

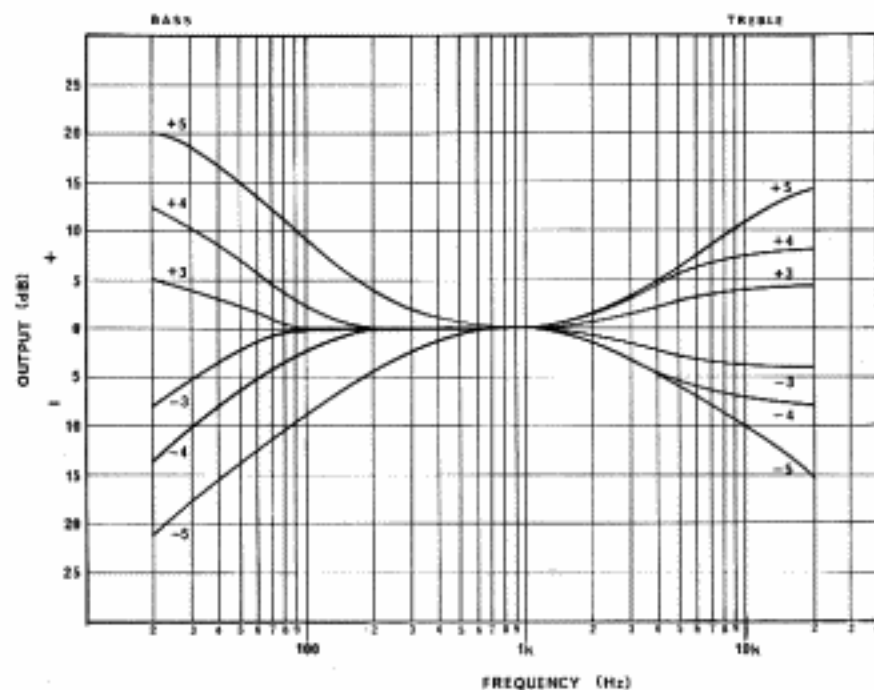

FIG. 18. EFFECT OF BASS AND TREBLE CONTROLS

Monitoring (Signal Level)

As the Series Seven Ferrograph has separate record and replay heads it is possible to monitor the signal off the tape whilst recording, and this can be done aurally from the loudspeaker by setting the Output switch to "Tape", and visually on the meter by setting the Meter switch to "Output".

The record and replay signals are set so that the meter indication on "Tape" is the same as on "Source" for easier comparison of the signal quality. However, different brands of tape vary slightly in the strength of the replay signal obtained and if the brand in use is markedly different from that to which the recorder has been set, there will be an observable difference between the readings. If it is desired to correct for this, the two signals should be compared and the "Tape Level" pre-set control "A" (see Fig. 7 or 8) adjusted with a screwdriver until the "Tape" and "Source" indications on the meter are the same (if recording constant tones see page 46).

Once this has been set correctly for the brand of tape in use, it should not be necessary to re-adjust the "Tape Level" control ("A") again unless a tape is used which has an output level markedly different.

Bass and Treble Controls

The Bass and Treble controls can be used independently of each other to provide a continuously variable amount of lift or cut as required (Fig. 18). When at their normal central position an overall level response (record/replay) is obtained.

When replaying tapes recorded on other instruments, the Bass and Treble controls can be utilized to give a level response on the loudspeakers or at the Low Level and Loudspeaker outputs. Their settings will depend upon the characteristic to which the tape was recorded. While their final positions may depend upon the judgement of the listener as explained on page 22, the recommended settings for a level response with various characteristics at each tape speed are given in the table.

Speed	Characteristic	Bass	Treble
15 in/sec. (38 cm/sec.)	CCIR/IEC/DIN (35 μ sec.)	0	0
	NAB (50 μ sec.)	0	+3
	USA (Ampex)	0	+3
7½ in/sec. (19 cm/sec.)	DIN/NAB (50/3180 μ sec.)	0	0
	IEC (70 μ sec.)	+3	+2
	CCIR (100 μ sec.)	+3	+4
	USA (Ampex)	0	-2
3¾ in/sec. (9.5 cm/sec.)	DIN/NAB (90/3180 μ sec.)	0	0
	IEC (140 μ sec.)	+3	+1½
	CCIR (200 μ sec.)	+2	+4½
	USA (Ampex)	0	0

ENDLESS LOOP CASSETTE

The Ferrograph instrument has many applications in science and industry, some of which do not need a long recording sequence but instead require an endless band of tape for continuous recording or replaying. For this application a loop of a few minutes is usually adequate and the Endless Loop Cassette has been designed to accommodate a maximum of 4 minutes at 7½ in/sec. or 8 min. at 3¾ in/sec. (Both of these times can in fact be doubled by using special graphited tape).

Provided the phenomenon to be monitored is capable of being converted into electrical signals it can be recorded so that information on the last few minutes is always available, with the tape acting as a "memory loop". One example of this is when the recorder is arranged to switch off as soon as a fault occurs: the tape then contains a recording of the conditions leading up to the fault.

Loading

Before mounting, the cassette should be loaded with the required length of tape, and for satisfactory performance this should not exceed that for the maximum running times quoted. The tape should be taken from a reel of *Acetate* based tape, preferably well aged, and on *no* account should *PVC* or *Polyester (Mylar)* based tape be used as these cause binding and sticking between the layers of tape in the cassette. However, if the special *Graphited* tape is available the permissible playing time may be doubled. For every minute of loop at $7\frac{1}{2}$ in/sec. $37\frac{1}{2}$ ft. of tape is required ($18\frac{1}{2}$ ft. at $3\frac{1}{2}$ in/sec.), up to a maximum of 150 ft.

The three screws (and their nuts and spacers) around the edge of the cassette should be removed and the small peg inserted as in Fig. 19. The start of the tape should be passed from the outside through to the inside of the cassette between the fourth and fifth rollers counted in an anti-clockwise direction from the peg, and the tape wound clockwise in the conventional "coating inside" method over the peg. The tape ends should be spliced together, without twists, leaving a loop of approximately 18 inches outside the cassette, then the peg should be removed and the three spacers and screws refitted.

Mounting

When using the cassette, the reel carriers are not used and the take-up reel motor should be de-energised. This is done by proceeding as if to remove the recorder from its case as on page 37, until the right hand reel motor is exposed at the rear (there is no need to remove the chassis entirely from the case, and the speaker leads should be left plugged in). The two pin socket on the take-up motor should be removed and fitted onto the adjacent "dummy" position. The recorder can then be fitted into the case, the fuses re-inserted and the instrument reconnected to the mains.

The cassette is mounted as shown in Fig. 19 by two captive screws which fit into hank bushes on the deck plate, and the tape is threaded through the heads in the usual way. However while the tape is running there must be little or no tension in the tape being rewound onto the cassette and therefore the tape must not pass round the auto stop arm as usual. To prevent it from operating, the arm must have a small piece of insulating material placed between it and the fixed guide.



FIG. 19. ENDLESS LOOP CASSETTE

Operation

In operation the tape is pulled from the inside of the cassette by the capstan drive and due to the drag between adjacent turns, the whole mass of tape will revolve easily on the anodised surface of the cassette and the PTFE rollers, thus rewinding the tape on the outside. When first run

after loading, the winding tension will adjust itself automatically to the correct inter-turn friction and the length of the free loop after the capstan will vary accordingly. In most cases the loop will lengthen as the tape tightens up, and after the tape has run for some minutes the tape can be respliced (preferably at the original joint) to shorten the loop to a convenient length. It should not be made too small as this may cause the tape to bind in the cassette.

Where the cassette is loaded with a previously recorded tape of a fixed length, the loop cannot be shortened haphazardly. Any slack tape should be taken up by making more turns round the cassette (resplicing the tape to avoid twists) till the free loop is too short to make another turn without removing the slack altogether.

After the cassette has been operating for some while, at a convenient time the tape should be stopped and the heads and capstan/pinch roller cleaned to remove excessive accumulation of tape oxide. Once the tape has been "run in", little oxide deposit will occur and the tape can be run for longer periods without attention.

TECHNICAL DESCRIPTION

The Series Seven Ferrograph recorders have been designed to keep the basic operation as simple as possible, yet to offer numerous facilities for those who wish to use more advanced techniques. The main functions of the instrument are controlled by a single knob on the deck, and the gain controls are arranged on the front panel for straight-forward operation. The adjustable controls and switches which give the further flexibility required by the enthusiast, are located underneath the hinged flap at the front of the panel.

As in earlier Ferrographs, the instrument is constructed in three main sections (deck, amplifier and power unit) interconnected by plugs and sockets to facilitate servicing. The deck comprises the mechanics for the tape transport together with the main function switch, the tape heads, etc.; the power unit contains the mains transformer, the smoothed power supplies, the main 10 Watt transformerless power output stage(s), (if fitted), and the rear panel with the input and output sockets; the amplifier unit includes all the amplifiers and pre-amplifiers, the record oscillator, etc., and supports the main control panel with the mixing, volume and tone controls, switches, etc. In the following description of the design features, the recorder has been split into two main sections, "Mechanics" and "Electronics".

Mechanical Section

The basic and most important feature of the tape deck is that the main functions of the tape transport are electrically operated. This is achieved by the use of electro-magnetic actuators operating over a short stroke for consistent and reliable performance, and by the use of counter-

balanced levers or arms so that the instrument can be operated horizontally or vertically as desired. The operations of the recorder are entirely controlled by a single Function knob, but connections are made to the Auxiliary Socket on the rear panel so that the tape drive can be started or stopped remotely, either manually or automatically, e.g. by a time switch. Again, because the recorder is fully transistorised, no "warming up" period is necessary and the complete recorder can be controlled by a time switch in the mains lead.

Tape Transport

The tape transport system on the Series Seven deck utilises three motors, a capstan motor and two reel motors. On "Fast" the reel motors X101 & X102 are in series across the mains supply as is also the Fast Wind control RV103. This wire-wound potentiometer (25 Watt rating) has its slider connected to the junction point of the two reel motors and by varying the position of this from one side to the other, the power is divided unequally between the reels so that tape wind is achieved in either direction at fast or slow speeds. This potentiometer is out of circuit except when the Function switch is at "Fast".

The capstan motor X100 is resiliently mounted on neoprene shock mounts to minimise mechanical noise, and uses grease-packed ball races, seated in special neoprene mounts, for greater reliability and long life. It is a split phase capacity type induction motor which, after reaching its synchronous speed, is insensitive to small changes of applied voltage or load, and therefore its speed, within certain limits, is controlled only by the frequency of the mains supply. It runs anti-clockwise viewed from the top of its spindle, on which is mounted a stepped pulley with a sand-blasted finish for reliable traction.

Operation

The speed change switch SW104 is fitted with a three position cam which moves the start lever to engage with one of three slider bars each carrying an idler wheel. On turning the Function switch SW100 from "Stop" to "Pause", the Start solenoid L100 is energised from the separate 24V supply (fused by FS100), and the start armature is pulled into engagement with it, releasing the brakes and actuating a micro-switch SW102 which energises all three motors. Simultaneously the idler lever, spring loaded to maintain constant pressure, moves the idler wheel into engagement with the capstan motor pulley and flywheel, thus driving the flywheel. The heavy stepped flywheel is fixed to a stainless steel spindle, the top end of which is precision ground and sand blasted to operate as the capstan. Its lower bearing is a grease packed race, held in a special neoprene lined mount which is factory adjusted so that the capstan is precisely parallel (in all vertical planes) with the pinch roller spindle, and the sintered bronze, self-lubricating upper bearing is supported in a special gimbal mounting.

On "Pause", although the brakes are off, the tape is maintained stationary by the two reel motors, which are energised (in series across the mains) in opposite directions. On turning to "Run", the left hand reel motor is replaced by R105 and the run solenoid L101 pulls on the run armature which moves the resilient pinch roller against the tape, gripping it against the capstan. As this is already rotating, the tape is driven immediately and reaches its correct speed almost instantaneously. The tape is taken up by the right hand reel, which now has increased power, and slight back tension is maintained on the tape by a special constant friction brake acting on the left hand spool to minimise flutter.

Tape Tension

On starting and stopping the tape, snatch due to the inertia of the reel is eliminated by two differentially damped tape tensioning arms on each side of the head assembly, and these automatically compensate for any slight delay in taking up the tape when the reel is nearly full. On the high speed models only, at 15 in/sec., the relay RL101 shorts out R105 for a few seconds to give the take-up reel extra power to cope with the very fast tape start.

Automatic Stop

The right hand arm between the capstan and the take-up reel also acts as an automatic stop. Should the tape tension fail, it will swing fully over and contact the fixed pillar, energising a delay circuit (VT100 & VT101). After approx. 1½ secs. the auto stop relay RL100 is energised and this switches off both the Start and Run solenoids, completely shutting down the deck. As the relay has a hold-on contact (RL100a) the Function switch must be returned to "Stop" to de-energise the relay by removing its earth connection. The auto stop relay is also triggered by the tape speed and equalisation switches if these are not both set to the same tape speed, and again, once the relay has been actuated it can only be de-energised by turning the Function switch to "Stop".

Braking

When the Start solenoid is de-energised, the brakes are re-applied to the drums on the underside of the reel carriers. They are arranged to be self-wrapping so as to have maximum effect on the reel from which the tape is issuing and very little on the reel onto which the tape is being wound, so that on being applied after fast winding they act equally well whatever the direction of tape travel. The amount of braking torque applied to each reel is adjusted by sliding a locking screw in a slot, and hence the braking can be balanced for optimum performance. Because the speed of fast wind is adjustable, sharp braking is unnecessary and the brakes are normally set to avoid overspill in both directions without applying too great a strain on the tape, particularly the thinner types, and once set correctly no further adjustments should be needed.



FIG. 20 DECK MECHANICS



FIG. 21. MONO TRACK DIMENSIONS MODEL 713

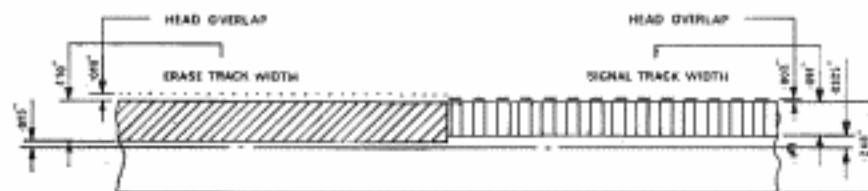

FIG. 22. MONO TRACK DIMENSIONS MODELS 702 AND 722

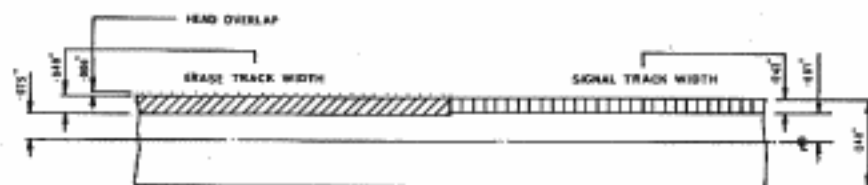

FIG. 23. MONO TRACK DIMENSIONS MODELS 704 AND 724

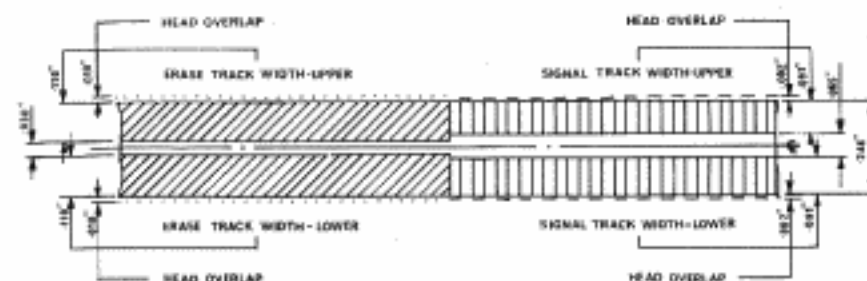

FIG. 24. STEREO TRACK DIMENSIONS MODELS 702 AND 722

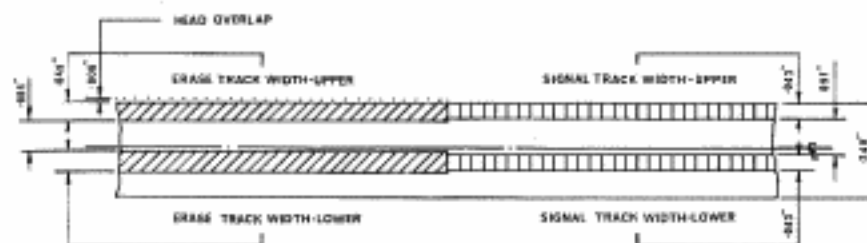

FIG. 25. STEREO TRACK DIMENSIONS MODELS 704 AND 724

Turns Counter

The turns counter is driven from the underside of the right hand reel carrier by a belt, and indicates the revolutions of the take-up reel. However, as the length of tape per revolution varies throughout the tape depending upon the amount of tape on the reel, the counter reading is not related linearly to time, and a graph showing the relationship tape/turns is given on page 21. The turns counter is returned to zero (usually at the beginning of a reel) by pressing the Zero button adjacent to it.

Switching

The main function knob operates a ceramic rotary switch SW100, which selects the basic functions of the instrument. In addition the switch spindle carries a cam, immediately underneath the cover plate, which engages the friction brake on "Run" and disengages it in the other positions, and which retracts the arm which moves the pressure pads from the heads on "Stop" and "Fast". This cam also engages with the mechanism which prevents the switch from being turned straight through from "Fast" to "Run", and this is released by moving the "Lock Release" knob sideways to the left.

When the Function switch is at "Pause" or "Run", the Record button cannot be pressed down to the 'on' position until the Record Release catch is moved to the left. On allowing it to return to the right, the Record arm is locked 'on'. The Record Release catch can be moved to the left by hand or this is done automatically on returning the Function cam to "Stop", when the Record lever will spring up to its "off" position. When the Record lever is pressed down to the "on" position, it opens two contacts SW108 which normally short the record head leads to earth. It also operates a microswitch SW107 which switches on the D.C. (via SW100) to the meter illumination and 100kHz oscillator giving the power for the erase head and bias for the record head, but only on "Pause" and "Run" as selected by SW100.

Heads

The three heads are mounted on a block, (fitted beneath the hinged cover at the centre of the instrument) which may be removed from the deck as a complete unit. Each head is mounted rigidly on its own plate, the erase head X103 to the left of the block, the record head X104 in the centre, and the replay head X105 to the right. While the erase head is fixed, the mountings of the record and replay heads are each spring loaded on a central pivot with azimuth adjustment by a single hex. socket headed screw (3 B.A. key) at the front left of each head. This enables the heads to be aligned with their gaps accurately at right angles

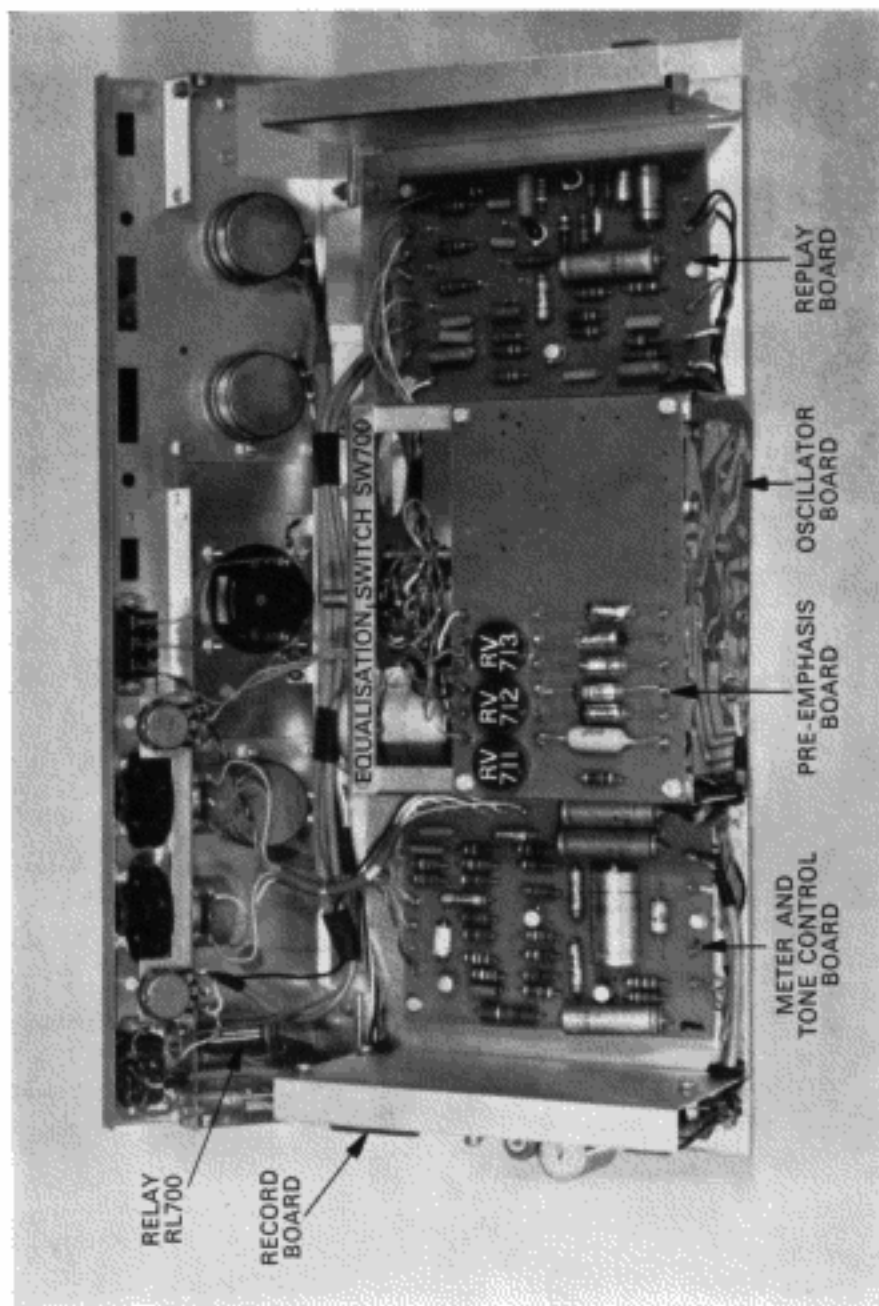

FIG. 26. MONO AMPLIFIER FRONT VIEW

to the path of the tape to ensure proper high frequency response. Again, for reliable performance, particularly at high frequencies, pressure pads are used on "Run" to maintain the tape (even poor quality tape with a stiff backing) in intimate contact with the head face.

Electronic Section

The electronics of the Series Seven Ferrographs are completely transistorised and accordingly are constructed on printed circuit boards, the interconnecting wires being soldered to pins rigidly fitted to the boards. In the analysis of the circuitry which follows, each board is described separately (in the two channel models some boards are duplicated, one for each channel, and the alternative components quoted in brackets refer to the Lower Track).

Silicon transistors are used throughout because of their reliability and their capacity to withstand temperature variations, and a wide range has been used, each type to suit a particular application. The record and replay tape heads have been designed specifically to match their respective amplifiers both in impedance and gap dimension. Extra low noise transistors (pnp "Planar II") are used in the critical replay pre-amplifier stages to give a noise level well below that produced by the tape itself.

By making use of the high input impedance and excellent overload margin of field effect transistors, the Line input has an impedance of $2M\Omega$ and signals from 50mV to as high as 10V may be fed into it without overloading.

The Microphone input will also accept a wide range of signal strengths and this is achieved by the use of a distinctive negative-feedback gain control. When this is turned to a lower gain setting to suit stronger signals, the feedback in the circuit is increased, thus maintaining the distortion at a very low level.

Replay Board

The lead from the replay head X105 is soldered directly to the board to avoid hum loops, and the signal is passed via R.F. interference suppression components R300/C302 to the base of VT300. The output of this stage is further amplified by VT301 with negative-feedback equalisation applied by R315-319 and C313-317, to provide the correct characteristic at each tape speed. The treble response is adjusted by C313, 315 or 316, while the extreme bass is set by R315 or R317, as selected by the equalisation switch SW700. The signal is further amplified by VT302, and a phase-shift arrangement consisting of C311 with C305, 306 or 307 (again depending upon the tape speed) produces

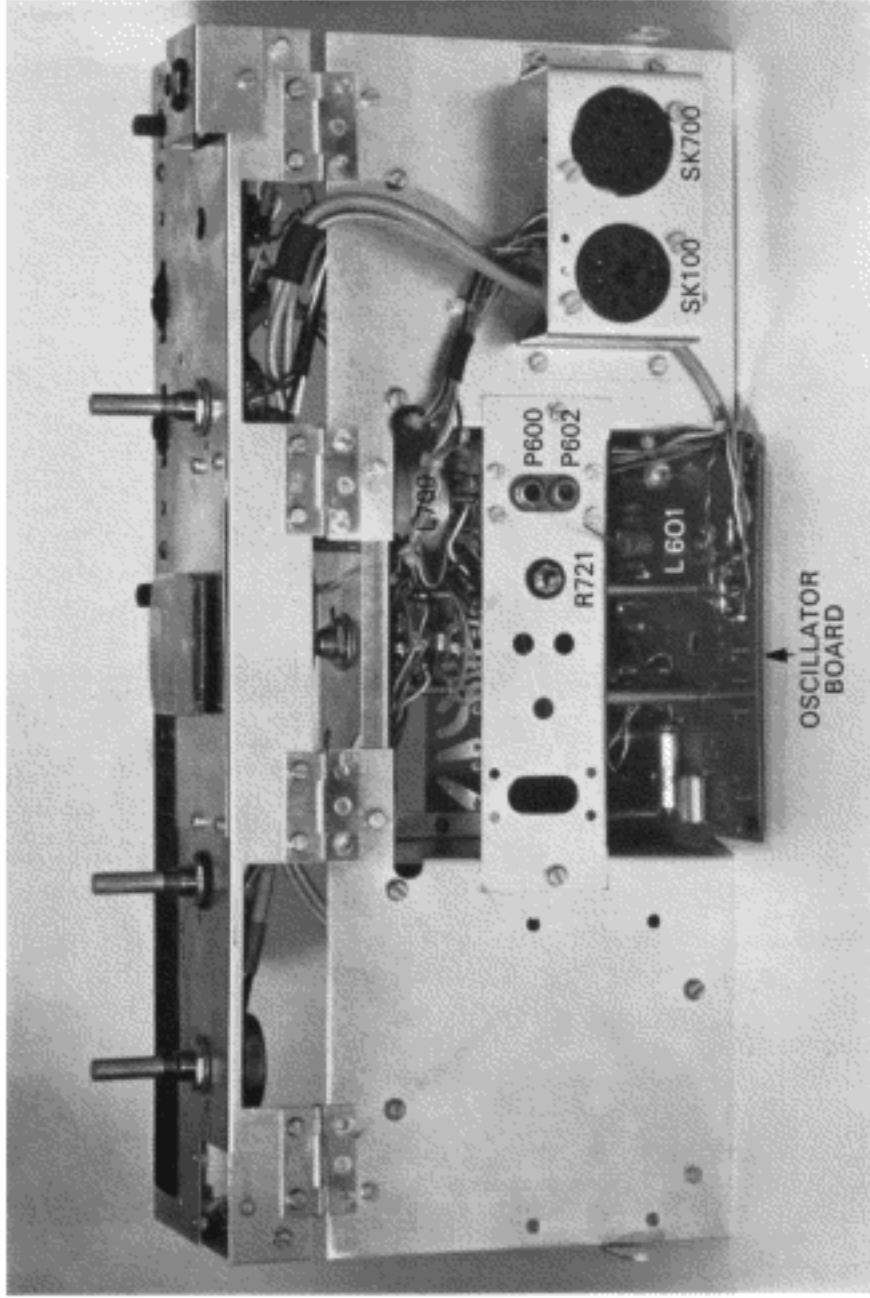

FIG. 27. MONO AMPLIFIER REAR VIEW

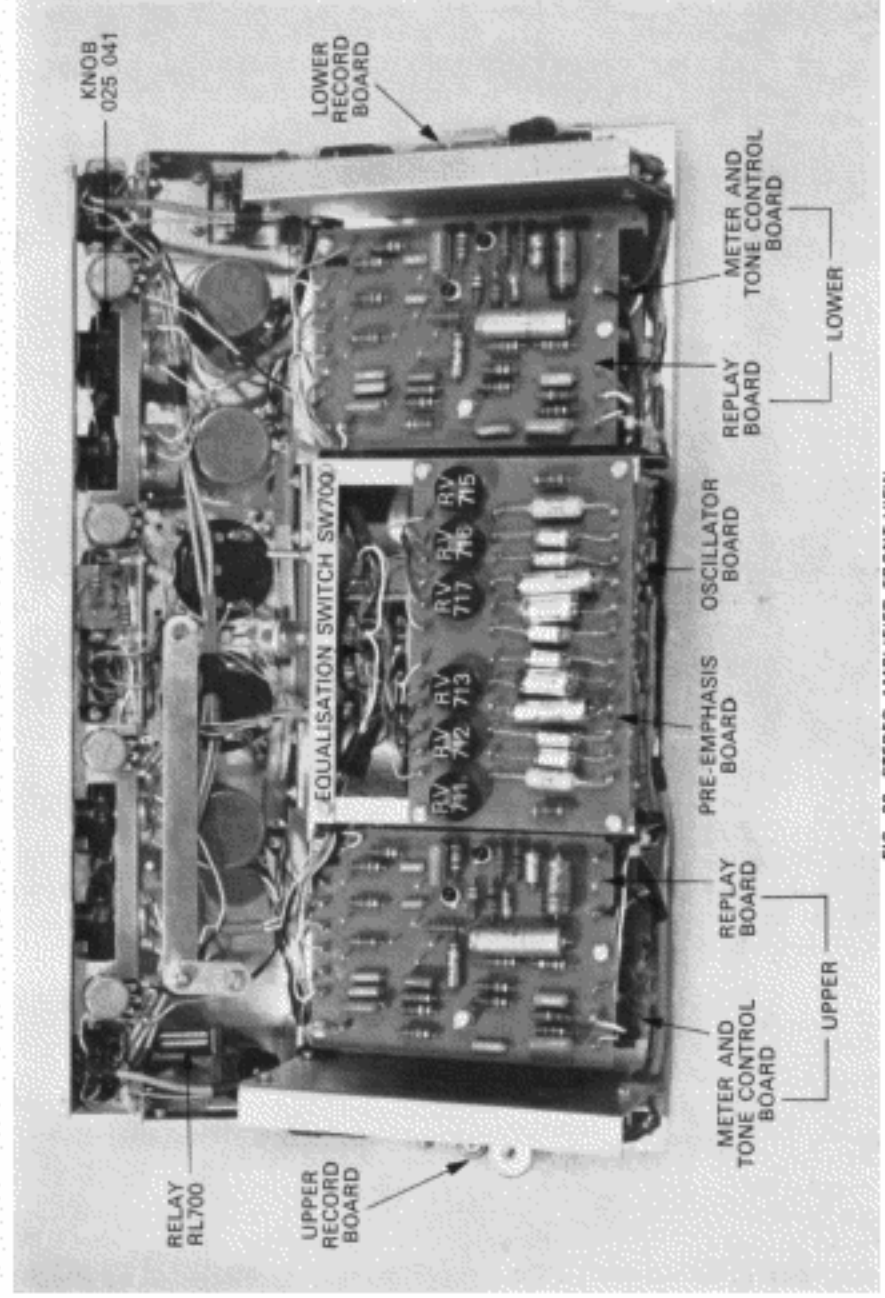

FIG. 28. STEREO AMPLIFIER FRONT VIEW

a small treble lift, followed by a sharp fall in the response, at the extreme of the frequency range. This removes any R.F. bias pick-up and ensures that the response extends only slightly beyond a chosen limit for each tape speed, thus reducing hiss to a minimum. The muting of the high frequencies during fast wind is provided by switching in R313 and C312.

The output signal from the replay board passes to the "Tape level" control marked "A" under the hinged flap on the control panel.

Meter and Tone Control Board

The input signal for this board comes from the "Output" switch SW702 (or SW703), and is either "Source" or "Tape" as selected manually by the Output switch. The signal is amplified by VT400, which has a small voltage gain, and fed to the emitter follower VT401 which gives an output of 2V at approximately 30 Ω . The impedance is made up to 600 Ω to drive the Line output by the series resistor R406, but it drives the VU meter directly, thus avoiding the slight distortion of the signal which would occur due to the meter rectifier if this was driven from the higher impedance 600 Ω point. As is usual with VU meters, an offset of 4dB is used between sine wave and music signals, an indication of 0 VU on music signals corresponding to maximum recording level (32mMx/mm.).

The signal then passes to the tone control stage VT402, which has no mid-frequency gain but provides boost or cut at both ends of the audio band with a clearly defined central level position for the Bass and Treble controls. The signal is fed to the Low Level output and "Output" control via R417 which on the stereo models enables both channels to be connected together without any increase in distortion, if required. The Output control varies the signal fed to the Power Amplifier Board.

The Output control is a linear potentiometer feeding into a relatively low impedance in order to give an effective logarithmic characteristic. This arrangement has been found to be more consistent than logarithmic potentiometers and gives excellent balance on all gain settings on stereo models.

Power Amplifier Board

This is located on the power unit, attached to a heat sink, and it consists of a transformerless arrangement with heavy negative feedback taken from both sides of the loudspeaker coupling capacitor C500. Resistor R511 provides feedback down to D.C., ensuring high stability even on reactive loads, while feedback via R512 reduces the effective reactance of C500 to an insignificant value. Control of the quiescent current in the output stage is effected by R506, which is adjusted for approximately 25mA total current for the board. Correction of the quiescent current for ambient temperature variations is obtained from the forward resistances of MR500 & 501.

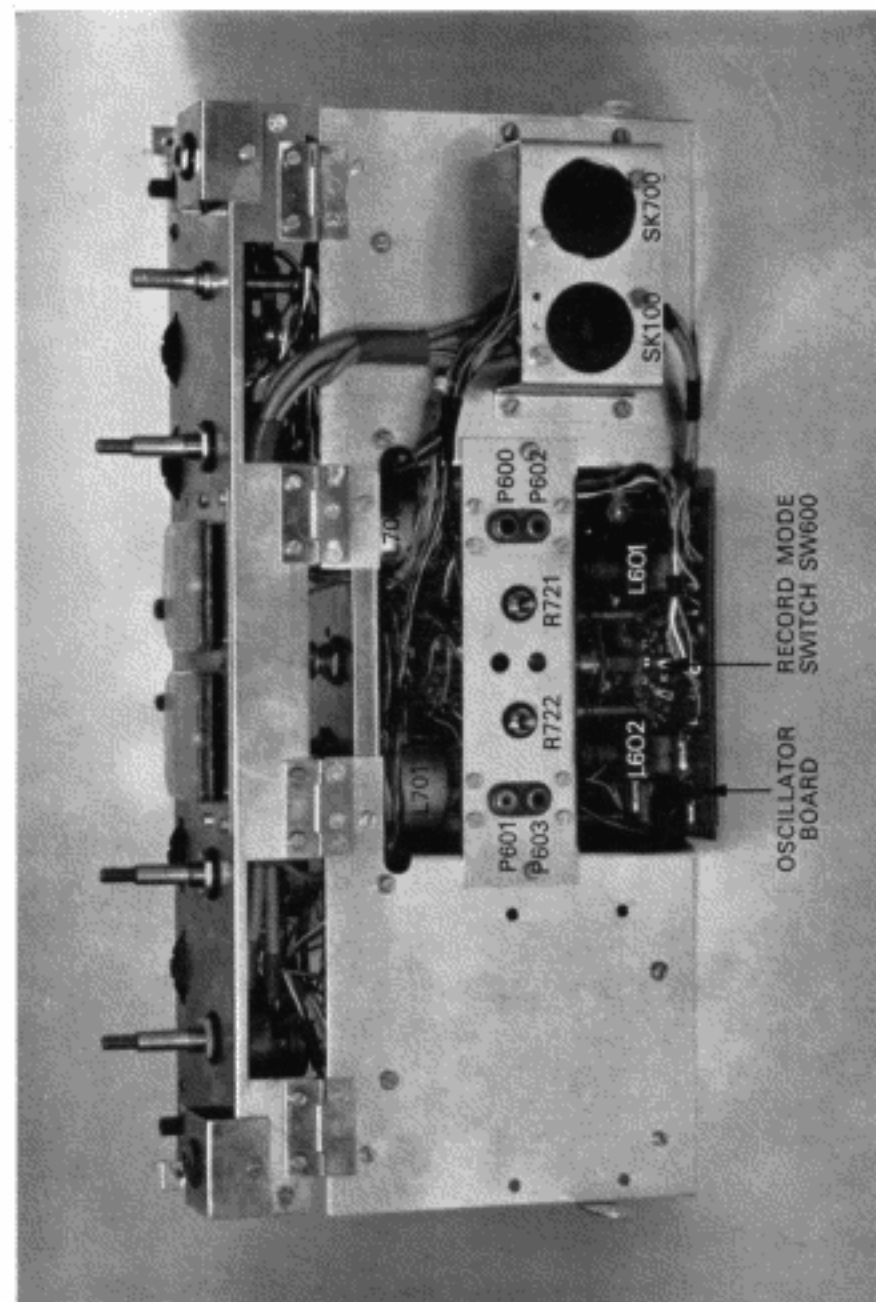

FIG. 29. STEREO AMPLIFIER REAR VIEW

Record Board

The signal from the Line input is fed directly to the gate of the F.E.T. VT202, which is used in a "follower" configuration to give unity voltage gain with an impedance transfer from $2M\ \Omega$ to a few hundred ohms. Protection of the F.E.T. from stray leakage voltages inadvertently fed into the input is provided by R227 and MR200. The signal passes through R216 to the Line gain control, which on stereo models may also receive a signal from the Transfer switch if this is in use.

The Microphone input signal passes through R.F. filter components R200 & C202 to the microphone pre-amplifier, which has two stages VT200 & VT201 with the Microphone gain control giving variable negative feedback to control the volume. After amplification the signal mixes with that from the Line input, the mixing being at low impedance to achieve a minimum noise level. The combined signal passes through VT203, which gives bass lift to the recording characteristic via C210 & R217, and thence to VT204. A variable tapping on RV220 provides the "Source" signal for the Output switch and Meter Board, the bass boost being removed by C212 & R222. The final record stage VT204 operates with heavy negative feedback which is reduced at high frequencies by SW700 which connects different by-pass capacitors for each tape speed, thus applying record pre-emphasis. The signal is then passed from the collector of VT204 via filter C214/R225 which, together with the filter on the oscillator board, prevents bias from appearing on the collector of VT204. The audio output from the Board is prevented from reaching the record head, unless the "Record" button is depressed, by SW108 on the deck. This ensures that no accidental recording (even without bias) can take place during replay due to signals which may still be present in the recording amplifier.

Pre-emphasis Board

This carries the pre-emphasis components which are selected by SW700 to provide high-frequency boost to the record signal, the lower octave being controlled by C702-704 (and C708-710 on stereo models) depending upon the tape speed in use, and the extreme limit of the response by RV711-713 (RV715-717).

Oscillator Unit

This is mounted on the rear of the amplifier and consists of a push-pull arrangement with VT600 & VT601, operating at approximately 100kHz. The coil L600 has a tuned secondary which passes the R.F. signal to the record and erase heads. On the stereo models this is done via the track selector switch SW600 which also maintains the bias constant in the mono and stereo modes by means of the dummy load RV606. The frequency is maintained constant by C607, connected in the "Stereo" position.

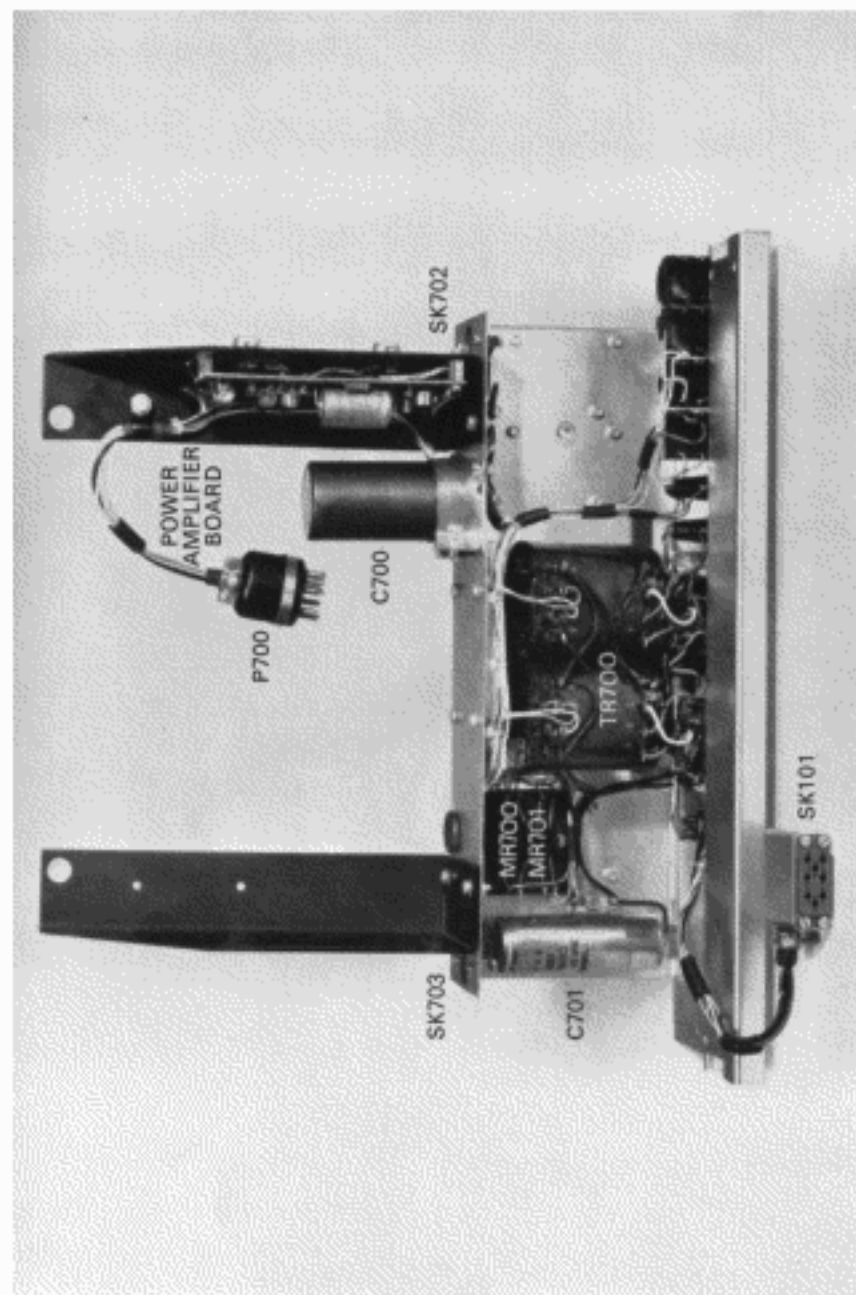

FIG. 30. MONO POWER UNIT

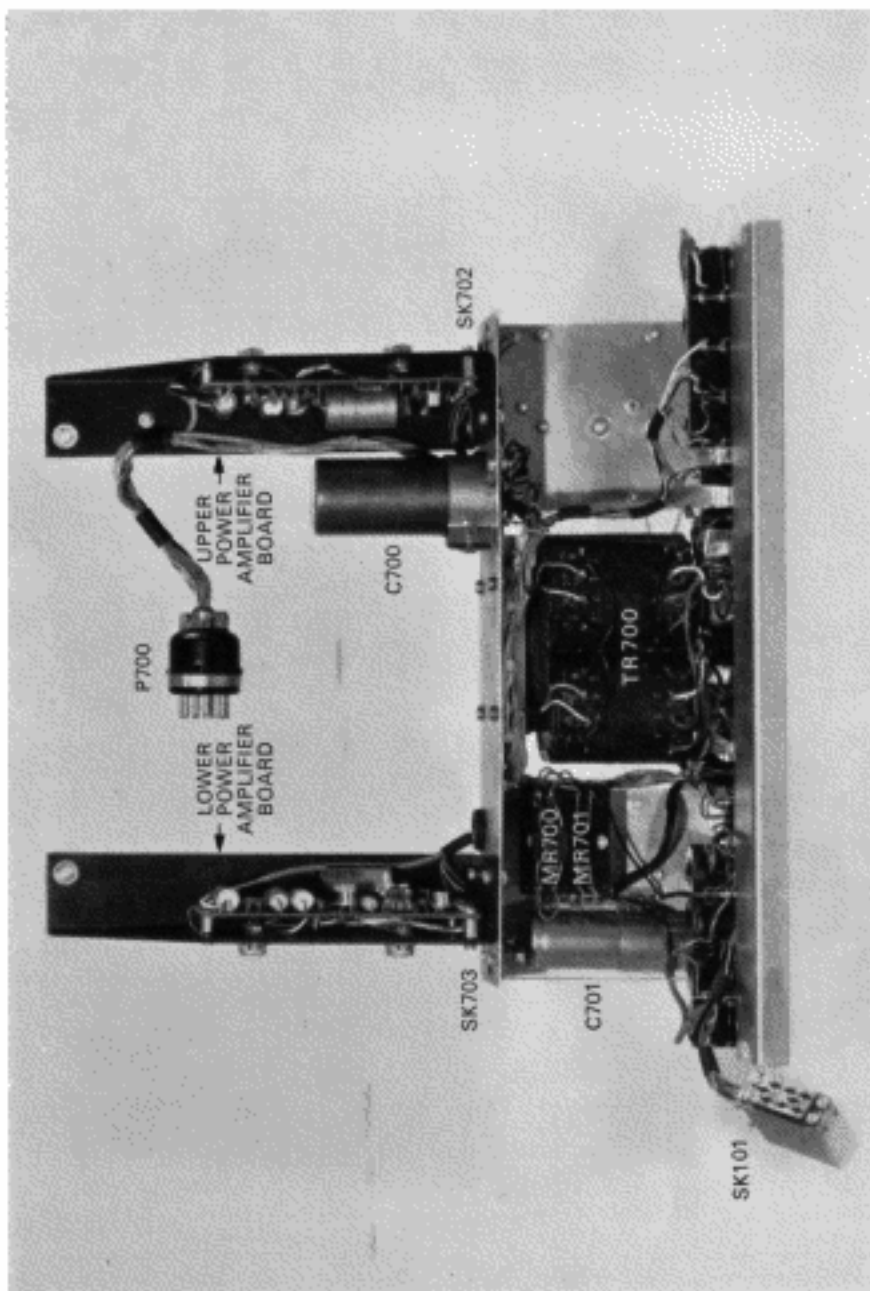

FIG. 31. STEREO POWER UNIT

The erase/bias supply is fed to the erase head via SK602 (SK603), which point also feeds bias to the record head via the bias control RV723 (RV724) which is mounted on the front panel under the hinged flap and marked "B". The earth return for the record head passes back to the oscillator coil via RV721 (RV722), which gives a measurement point for the bias current when the meter is set to read "Bias".

The D.C. supply for the oscillator is present only when the Record button is pressed, and the oscillator voltage is increased slightly at the faster tape speeds by omitting R701 & R702. This increases the bias proportionally so that the value is optimum at each tape speed, giving the best possible balance between distortion, dynamic range and frequency response.

Meter Board

The Meter Board is mounted directly on the back of the meter(s), the "source" signal being fed to it from RV220 on the record board. Transistor VT800 (or VT801) amplifies this signal to a level suitable for feeding to the meter when selected by the Meter switch at "Source". With the Meter switch at "Bias", the bias is read directly on the meter. With the Meter switch at "Output", the meter is connected to the emitter follower VT401 and reads "Tape" or "Source" as selected by the Output switch.

APPENDIX A

OPERATIONAL FAULT ANALYSIS

Symptoms	Possible Operational Causes
1. No "On" lamp; tape will not run.	Mains fuse blown. Mains lead or plug not properly fitted. Mains selector knob loose or wrongly positioned.
2. "Reset" lamp illuminated; tape will not run.	Tape wrongly set round auto-stop, or foil on tape contacting foil stop. Speed selector and Equalisation switches not set to same speed.
3. "Reset" lamp not on but tape will not run.	Speed selector has been turned when Function switch not at "Stop". Return to "Stop" and turn Speed Selector to adjacent speed then back again.
4. After turning from "Run" to "Stop", Function switch will not return to "Run".	Function switch has been turned too far and Fast wind catch has engaged. To clear, move "Lock Release" sideways.
5. Known, well recorded tape will not play; tape runs but no indication on meter.	Output switch at "Source". Tape incorrectly positioned in heads. Piece of splicing tape sticking on replay head. D.C. fuse blown. Replay control "A" at minimum.
6. Tape runs, indication on meter but no sound from speaker.	"Output" control at zero. Incorrectly wired plug in Speaker output. Short circuit plug in Low Level output.
7. Tape replays but with poor frequency response.	Bass and/or Treble controls incorrectly set. Accumulation of dirt or tape oxide over replay head gap.

Appendix A—continued

Symptoms	Possible Operational Causes
8. With Record button pressed on "Run", tape erases but does not record.	Appropriate gain control incorrectly set. Input plug not properly inserted or in wrong socket. Connecting lead faulty.
9. Signal recorded but previous recording incompletely erased.	Piece of splicing tape or tape oxide covering working face of erase head.
10. Signal recorded weakly, with poor frequency response.	Tape coating outside instead of inside. Bias control "B" turned to minimum — check by setting meter to read Bias (at $7\frac{1}{2}$ in/sec.).
11. Hum recorded on tape (check by changing replay speed — if hum recorded its frequency will also change).	Microphone (and matching unit if used) in hum field. Microphone transformer or leads insufficiently screened. Microphone leads or stand not properly earthed or in contact with mains leakage paths.
12. Take-up reel carrier appears to run hot, especially compared with supply reel carrier.	It is normal for the take-up reel carrier to feel hot to the touch. (The wind back reel motor is not energised on "Run").
13. Auto stop fails to operate (after built-in delay).	The contact has become covered with tape oxide. Clean the contact /guide at the end of the arm as described in "Care and Maintenance", page 44.
14. Tape winds unevenly, especially during very fast wind.	Reels incorrectly set for height. Tape has stretched non-uniformly and is concave or wavy, leading to odd layers winding on at different heights.
15. Turns counter does not register or makes a clicking noise.	"Zero" button has not been reset correctly. Press button fully down.

Appendix A—Stereo Models only

Symptoms	Possible Operational Causes
16. When recording stereophonically, breakthrough of one track to the other.	Transfer switch not set to "Off"
17. When recording monophonically, does not erase or record.	Record Mode switch set to wrong position.

APPENDIX B

The following accessories are available for use with the Ferrograph.

Carrying Case for Series Seven Ferrograph

Best quality waterproof canvas with zip fastener; gives full protection against rain and dust.

Dust Cover

Attractive rigid transparent cover to protect the mechanism from dust, etc.

Defluxer

For demagnetising record and replay heads. Prevents hiss and protects tapes from cumulative background noise (see Note at front of Manual).

Endless Loop Cassette

As described in Manual, page 49.

Signal-Operated Switching Unit

As described in Manual, page 36.

Foot Switch

Foot operated switch for start and stop of tape. Supplied with 6 ft. of lead with plug to fit Auxiliary Socket (see page 35).

Microphone Matching Unit

Type TA/30/ML for use with 30/50 Ω microphone to match into medium impedance input.

Ferrotape

Long Play magnetic recording tape supplied on full reels.

Standard

Type A oxide

AL7 7" dia. 1,800 ft.

AL8 8 $\frac{1}{2}$ " dia. 2,400 ft.

Low Noise—Extended Response

Type B oxide

BL7 7" dia. 1,800 ft.

BL8 8 $\frac{1}{2}$ " dia. 2,400 ft.

Spare Tape Spools

Spools (empty)	7" dia.	RE7
	8 $\frac{1}{2}$ " dia.	RE8

Miscellaneous

The following spares can also be supplied.

Lamp Bulb	LES,14V	455—002
Fuse	1A (20 mm. x 5 mm. dia.)	380—000
	2A (20 mm. x 5 mm. dia.)	380—009
Belt (turns counter)		060—000
Jack Plug, Screened	SP7	
	Unscreened	UP7
Auxiliary Socket Plug (7 pin, DIN)		577—002

INDEX—continued

Optimum bias	47	Response, specification	8
Output, amplifier	16	Retainers, reel	18, 31
, headphones	17		
, loudspeaker	16	Selector, equalisation	18
, switch	23	, mains voltage	46
		, speed	18
Pause	18	Signal operation	36
Pick-up,	15	, level	48
, ceramic	15	, op. switching unit	36
, crystal	15, 46	Source (output switch)	23
, magnetic	15	Specification	8, 9
Playing time	32	Speed selector	18
Plug, mains	13	Splicing block	29
Polarised head	12, 39	, tape	31
Power supply,	14	Spools, height	31
, 220V, 50Hz	46	, hublok	18, 31
Public address operation	37	, size	31
		Start/stop, remote	35
		Stereo, loudspeaker	
Quarter track	43	placement	39
		, models	39
Radio, input	15	, record	24, 39
, record	25	, track dispositions	28, 29
Radiogram	15	Stop, auto	20, 50
Record mode switch	25, 39	, foil	20
Record player	15	Surges, switching	24
Record,	24	Switch, equalisation	18
, gramophone	25	, mains	13
, level	24, 46	, meter	23
, microphone	25	, output	23
, radio	25	, record mode	25, 39
, stereo	25, 39	, transfer	40
Reel, height	31	Switching surges	24
, retainers	18, 31		
Remote, start/stop	35	Tape,	33
, volume	35	, bias	46
Removal from case	37	, double play	33
Replacement fuse	44	, graphited	49, 50
Replay,	22	, length per reel	33
, characteristics	8, 49	, level-'A'	48
, level	46	, loading	18
Reset lamp	18	, long play	33
Response, frequency check	46	, low noise	33, 46

INDEX—continued

Tape, output switch	23	Tuner, input	14
, quadruple play	33	, record	25
, speed	18	Turns counter	20, 21
, splicing	29		
, triple play	33	V.H.F. (F.M.) stereo	14
, wind	20	V.U. meter	24
Technical section	45	Vertical operation	13, 31
Time per reel	32	Voltage selector (mains)	46
Time switch operation	35	Volume, loudspeaker	22
Tone controls	22, 49	, remote	35
Tones, constant	46		
Track, changing	28	Wind, fast	20
, disposition	28, 29	, tape	20, 32
Track-to-track transfer	40		
Transfer switch	40		
Treble control	22, 49		