

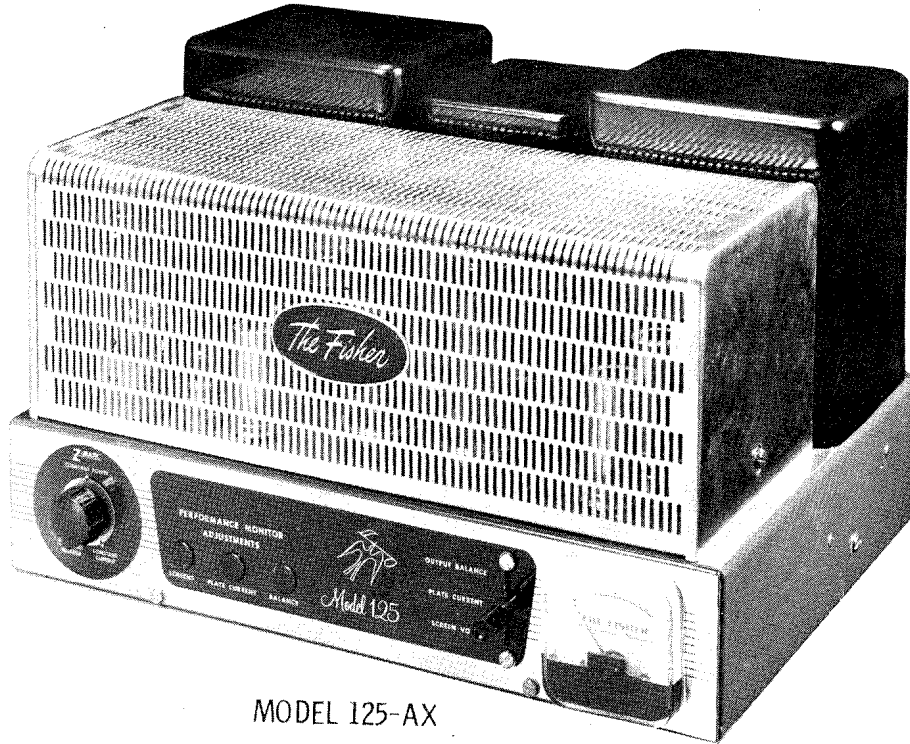

FISHER MODELS
125-A, 125-AX

FISHER MODELS
125-A, 125-AX



MODEL 125-AX

FISHER MODELS
125-A, 125-AX

TRADE NAME	Fisher Models 125-A, 125-AX		
MANUFACTURER	Fisher Radio Corp., 21-21 44th Drive, Long Island City 1, N. Y.		
TYPE SET	AC Operated Audio Amplifier		
TUBES (Ten)	Types 12AU7 AF Amp. -Phase Inv., 12AX7 Driver, (4) EL34/6CA7 Output, 6AU6 Volt. Reg. Cont., 6Y6GT Volt. Regulator, (2) 5R4GY Rectifier		
POWER SUPPLY	105-125 Volts AC-50/60 Cycles	RATING	1.92 Amp. @ 117 Volts (200 Watts)

ADJUSTMENTS

PERFORMANCE MONITOR ADJUSTMENTS (R2, R3, R4)

1. Connect a 16Ω load to the output terminals.
2. Short the input jack.
3. Turn Level Adjust (R5) fully counterclockwise.
4. Remove the 3 caps covering these adjustments. Turn each control to its mechanical center of rotation.
5. Turn on the amplifier and adjust input voltage to 117 Volts.
6. Hold Monitor Switch in "Screen Volts" positions. Rotate Screens (R2) until meter pointer coincides with screen mark on meter.
7. With Monitor Switch in "Plate Current" position, rotate Plate Current (R3) until pointer coincides with plate mark on meter.
8. Hold Monitor Switch in "Output Balance" position. Rotate Balance (R4) until pointer coincides with balance mark on meter, or is within 1/8 inch.
9. Check all three adjustments and repeat if necessary. Recheck after 30 minutes.
10. If proper indications are not obtained, check output tubes (V3, V4, V5, V6).

DRIVER BALANCE ADJUSTMENT (R6)

This adjustment is not necessary unless the associated circuit has been tampered with or repaired, and then only if the proper equipment is available.

1. Connect an accurately calibrated, low distortion audio generator to the input receptacle.
2. Connect a 16Ω 150W resistor across the output terminals.
3. Connect either a harmonic or intermodulation distortion analyzer across the resistor.
4. Set Impedance Matching Switch (M7) to 16Ω position.
5. Turn Z-Matic Control (R1) fully counterclockwise.
6. Set the generator to 1000 ν with an output slightly below the clipping point of the amplifier output. Keep generator output constant.
7. Adjust Driver Balance (R6) for minimum distortion on the analyzer.

HOWARD W. SAMS & CO., INC. • Indianapolis 5, Indiana

The listing of any available replacement part herein does not constitute in any case a recommendation, warranty or guaranty by Howard W. Sams & Co., Inc., as to the quality and suitability of such replacement part. The numbers of these parts have been compiled from information furnished to Howard W. Sams & Co., Inc., by the manufacturers of H691

the particular type of replacement part listed. Reproduction or use, without express permission, of editorial or pictorial content, in any manner, is prohibited. No patent liability is assumed with respect to the use of the information contained herein. © 1958 Howard W. Sams & Co., Inc., Indianapolis 5, Indiana. Printed in U.S. of America

PARTS LIST AND DESCRIPTIONS

TUBES (GENERAL ELECTRIC, SYLVANIA)

ITEM No.	USE	TYPE	USE	TYPE
V1	AF Amp. -Phase Inv.	12AU7	Output	EL34/6CA7 ①
V2	Driver	12AX7	Volt Reg. Control	6AU6
V3	Output	EL34/6CA7 ①	Volt Regulator	6X6GT
V4	Output	EL34/6CA7 ①	Rectifier	5R4GY
V5	Output	EL34/6CA7 ①	Rectifier	5R4GY

① Domestic type listed may not be directly interchangeable in some instances. Output tubes are matched and color coded. Replace with a tube matching the characteristics of the like coded tube in the other parallel branch.

CONTROLS

ITEM No.	RATING	REPLACEMENT DATA				INSTALLATION NOTES
		RESIST-ANCE	WATTS	FISHER PART No.	CENTRALAB PART No.	
R1A	1000Ω	1/2		R-581-125	AB-31	Z-Matic
R2A	50K	1/2		5-581-128	AK-1	Screen
R3A	50K	1/2		R-581-128	AK-31	Plate Current
R4A	50K	1/2		R-581-127	AK-1	Balance, Tap@25K
R5A	500K	1/2		R-2815-9	AK-1	Level Adjust
R6A	500Ω	1/2		R-581-126	AK-4	Driver Balance
					AK-1	

REPLACEMENT DATA

ITEM No.	CLAROSTAT PART No.	IRC PART No.	MALLOY PART No.
	A47-50K-S	Q11-123	U35
	FKS-1/4	RQ	U36
	A47-50K-S	Q11-123	Not Req.
	FKS-1/4	RQ	Not Req.
	A47F-50K	Q11-133	U50
	FKS-1/4	RQ	Not Req.
	A47-500K-S	Q11-103	U2
	FKS-1/4	RQ	Not Req.

ELECTROLYTIC CAPACITORS

ITEM No.	RATING	REPLACEMENT DATA				SPRAGUE PART No.
		CORNELL-DUBILIER PART No.	AEROVOX PART No.	PYRAMID PART No.	SANGAMO PART No.	
C1	120	B0489	AFH2-66-50	TMD-93	T-195	TVL-2850
C2	120	B0489	AFH2-66-50	TMD-93	MT-4720	TVL-2850
C3A	40	C0344	AFH3-43-50	TMT-39	MT-4720	TVL-3786
C3B	40				Q-061	
C4	450	BR145	PRS450V1	TD-40-250	MMT-4501	R1260*
C5	230	BR4025	PRS250V40		MT-2540	TVA-1511
C6	250	BR145	PRS450V1		MMT-4501	R2622*

* Non-Catalog Item

FIXED CAPACITORS

Capacity values given in the rating column are in mfd. for Paper Capacitors, and in mmfd. for Mica and Ceramic Capacitors.

ITEM No.	RATING	REPLACEMENT DATA				NOTES
		FISHER PART No.	AEROVOX PART No.	MALLOY PART No.	SPRAGUE PART No.	
C7	22	C68P224V2	P288N-22	GEM-2022	2TM-P22	
C8	500	CC21G9501K5	S1500	UC-535	5GA-T5	
C9	150	CC21G151K5	NFO-S1150	2T-5315	5TCC-T15	10%
C10	22	C68P224M4	P488N-22	GEM-4022	4TM-P22	
C11	22	C68P224M4	P488N-22	GEM-4022	4TM-P22	
C12	022	C68P223M4	P488N-022	GEM-4122	4TM-S22	
C13	022	C68P223M4	P488N-022	GEM-4122	4TM-S22	
C14	300	CC21G301K5	P488N-022	GEM-4122	4TM-S22	
C15	047	C68P473M4	P488N-047	GEM-4147	4TM-S47	10%
C16	01	C-3357	P1088N-01	GEM-1611	MB-S1	
C17	600	C-2747	P688N-601	GEM-601	6TM-S1	

RESISTORS

All wattages 1/2 watt, or less, unless otherwise listed.

ITEM No.	RATING	REPLACEMENT DATA		FISHER PART No.	NOTES
		OHMS	WATT		
R7	22K			RC20BF224K	
R8	270K			RC20BF274K	Note 1
R9	2200Ω			RC20BF224K	
R10	1000Ω			RC20BF102K	
R11	2200Ω			RC20BF224K	
R12	2200Ω			RC20BF224K	
R13	330Ω			RC20BF331K	
R14	47K 5%			RC20BF475J	
R15	10K			RC20BF103K	
R16	47K 5%			RC20BF475J	
R17	470K			RC20BF474K	
R18	100K 5%			RC20BF104J	Note 1
R19	220Ω			RC20BF221K	
R20	2200Ω			RC20BF224K	
R21	470K			RC20BF474K	
R22	100K 5%			RC20BF104J	
R23	220Ω			RC20BF221K	
R24	3.3meg			RC20BF333K	
R25	220K			RC20BF224K	
R26	68Ω			RC20BF680K	
R27	100Ω			RC20BF101K	
R28	68Ω			RC20BF680K	
R29	3.3meg			RC20BF333K	
R30	220K			RC20BF224K	
R31	68Ω			RC20BF680K	
R32	100Ω			RC20BF101K	
R33	68Ω			RC20BF680K	

Note 1. R8 and R16 may be reversed in some versions.

Note 2. Not used in Model 125 A.

Note 3. Not used in some versions. When used, value may vary.

ITEM No.	RATING	REPLACEMENT DATA		FISHER PART No.	NOTES
		OHMS	WATT		
R34	2200Ω			RC20BF224K	
R35A	1Ω			3.5 (WW)	Note 2
R35B	1Ω			3.5 (WW)	
R35C	.8Ω			3 (WW)	
R36	27K			RC20BF273K	
R37	10K			RC20BF103K	
R38	100K			RC20BF104K	
R39	220K			RC20BF224K	
R40	100K			RC20BF104K	
R41	150K			RC20BF154K	
R42	220K			RC20BF224K	
R43	22K			RC20BF223K	
R44	220K-1meg			1	Note 3
R45	56K			RC20BF563K	Note 4
R46	29K			RC20BF293K	
R47	8200Ω			RC20BF822K	
R48	38K			RC20BF383K	
R49	680K			RC20BF684K	
R50	68Ω			RC20BF680K	
R51	2200Ω			RC20BF224K	
R52	15Ω			7 (WW)	
R53	82Ω			R-581-137	
R54	82Ω			RC40BF820K	Note 5
R55	82K			RC40BF820K	Note 5
R56	1-5meg			RC40BF823J	Note 3
R57	150-500Ω				Note 3

Note 4. Some versions may use 120K in this application.

Note 5. R53 and R54 should be a matched pair.

Replace with original value.

PARTS LIST AND DESCRIPTIONS (Continued)

FILTER CHOKE

ITEM No.	RATINGS		REPLACEMENT DATA						
	CURRENT (Measured)	INDUCTANCE (O CURRENT 1000 C)	FISHER PART No.	Haldorson PART No.	Merit PART No.	Ram PART No.	Stancor PART No.	Thordarson PART No.	Triad PART No.
L1	.160A	40Ω 5.5HY	L-581-131						

TRANSFORMER (POWER)

ITEM No.	RATING	REPLACEMENT DATA						
		FISHER PART No.	Haldorson PART No.	Merit PART No.	Ram PART No.	Stancor PART No.	Thordarson PART No.	Triad PART No.
T1	PRI. 117V @ 1.92A	T-581-147						
	SEC. 1 1350VCT 5V @ 3.9A Tap @ 150V @ .004A SEC. 2 6.3VCT @ 7.6A .27A							

TRANSFORMER (AUDIO OUTPUT)

ITEM No.	IMPEDANCE	REPLACEMENT DATA					NOTES		
		FISHER PART No.	Haldorson PART No.	Merit PART No.	Ram PART No.	Stancor PART No.		Thordarson PART No.	Triad PART No.
T2	1600Ω 72Ω PRI.2 (70V) 1600Ω 16Ω Taps @ 8Ω 4Ω	T-581-148①							① Part #T-581-122 used in Model 125A only.

SELENIUM RECTIFIER

ITEM No.	RATING CURRENT (Measured)	REPLACEMENT DATA			NOTES
		FISHER PART No.	FEDERAL PART No.	INTERNATIONAL PART No.	
M1	.004A.	SR-588-128	D-5413		10T

FUSES

ITEM No.	TYPE	RATING	REPLACEMENT DATA					
			FISHER PART No.	LITTELFUSE PART No.	FUSE HOLDER	BUSS PART No.		
M2	3AG	8A 125V	F-581-154	312008. (8A 125V)	X-1036	342001	GLF8	HKP

MISCELLANEOUS

ITEM No.	PART NAME	FISHER PART No.	NOTES
M3	Lamp	I-588-120	Meter
M4	Lamp	I-588-120	Meter
M5	Lamp		Neon, NE-16
M6	Lamp		Neon, NE-16
M7	Switch	S-557-138	Impedance Matching, DPST, Slide Type, Model 125AX
M8	Switch	S-505-117	Impedance Matching, DPST, Slide Type, Model 125A
M9	Meter	S-581-124	Performance Monitor, Rotary, Wafer, Lever Type
		M-581-130	Performance Monitor

CABINETS & CABINET PARTS

(When Ordering Cabinets & Cabinet Parts, Specify Model, Chassis & Color)

NAME	PART NO.	DESCRIPTION
Knob	E-588-118	Z-Matic
Knob	E-546-135	Performance Monitor Lever
Cover	AS-581-107CX	Perforated
Dress Panel	AS-581-109B	

WIRING DATA

General-use Unshielded Hook-up Wire Use BELDEN No. 8530 (Solid) Available in Ten Colors
 Power Cord Use BELDEN No. 1765-B (6 Ft. Length)
 Use BELDEN No. 1725-K (1/2 Ft. Length)

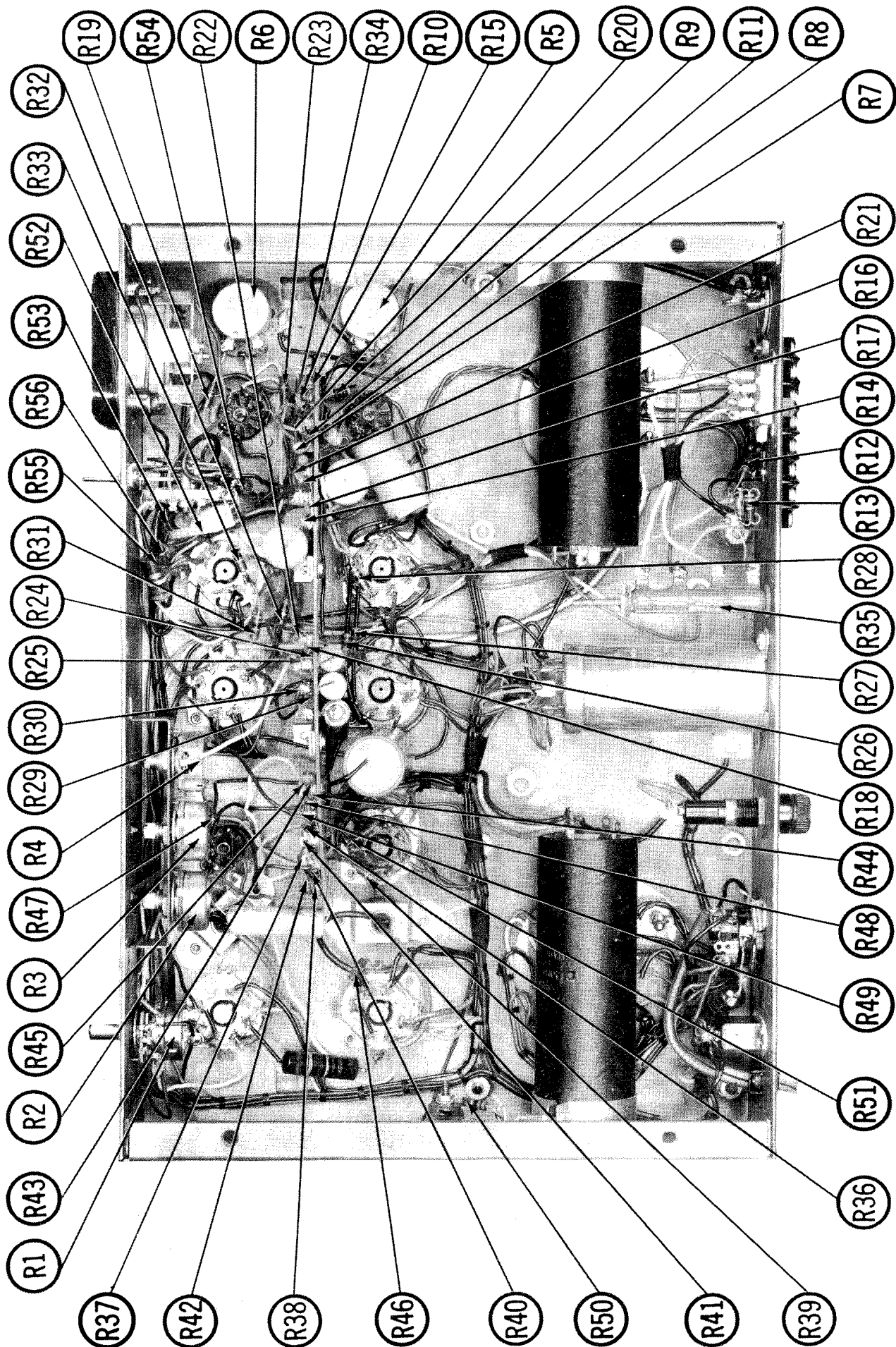

CHASSIS BOTTOM VIEW - RESISTOR IDENT.

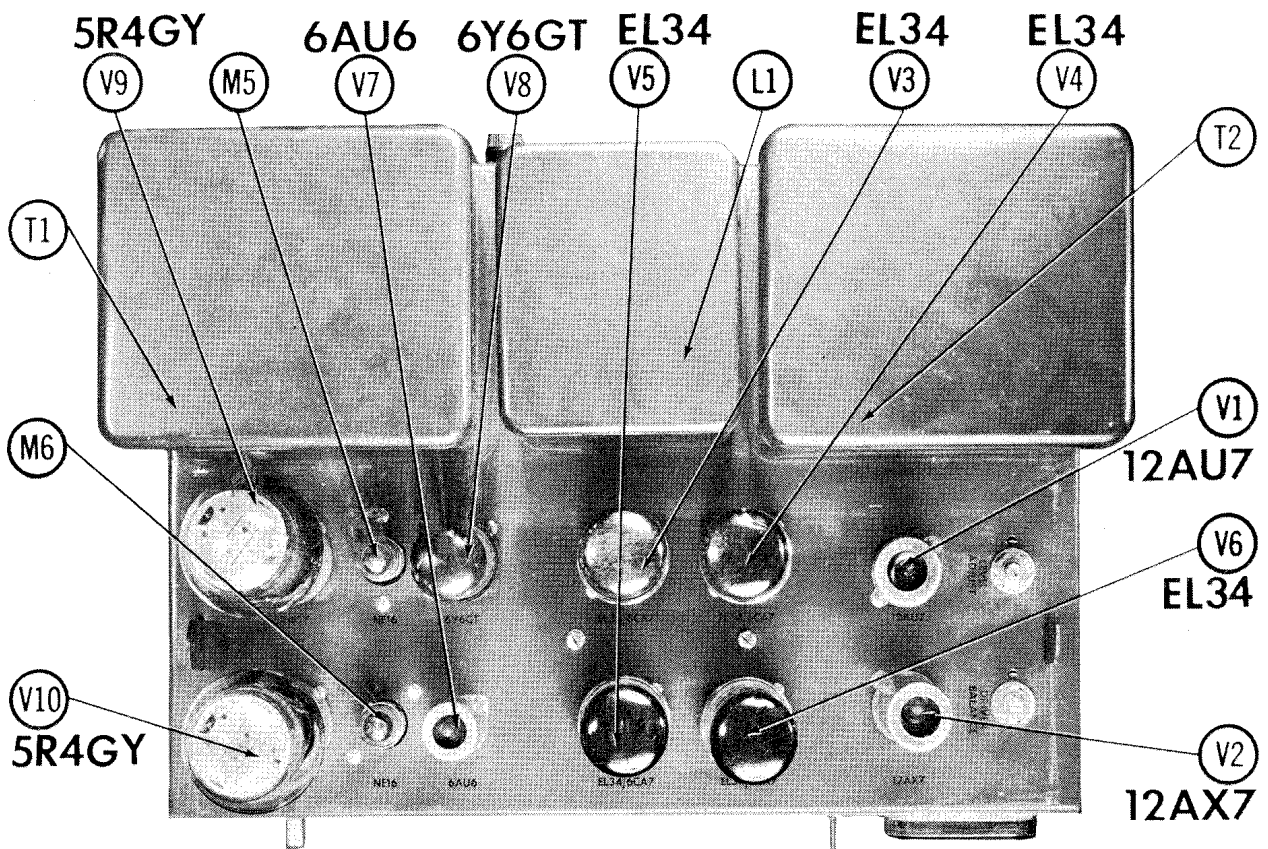

CHASSIS - TOP VIEW

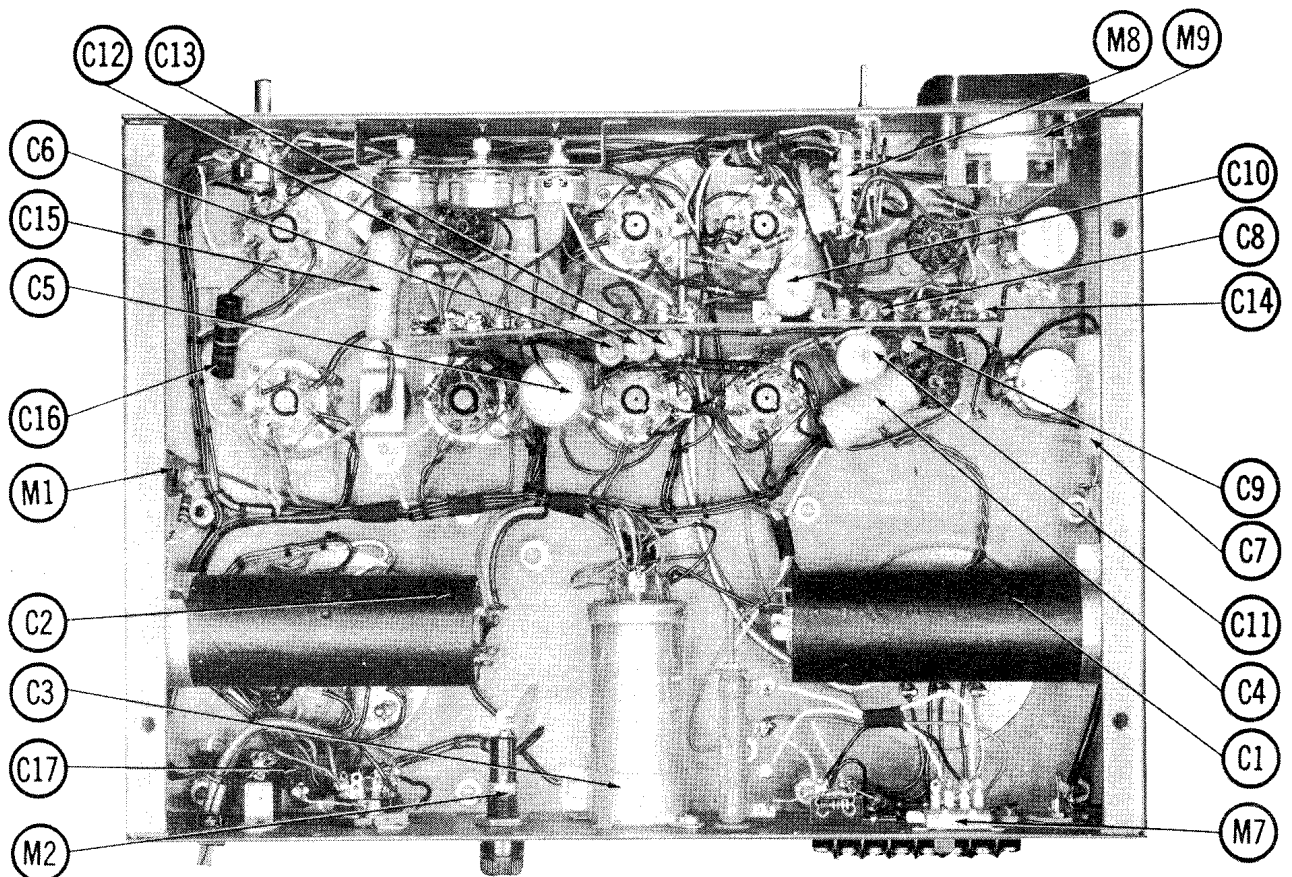

CHASSIS BOTTOM VIEW - CAPACITOR & MISC. IDENT.

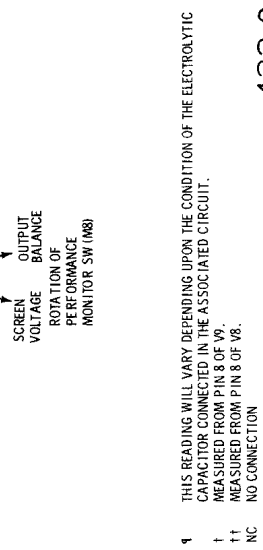
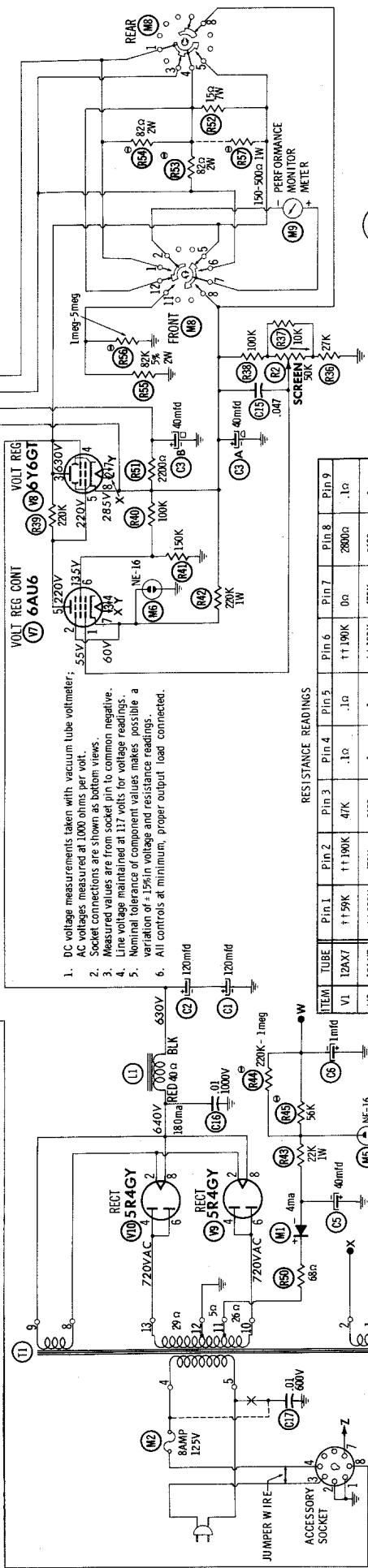
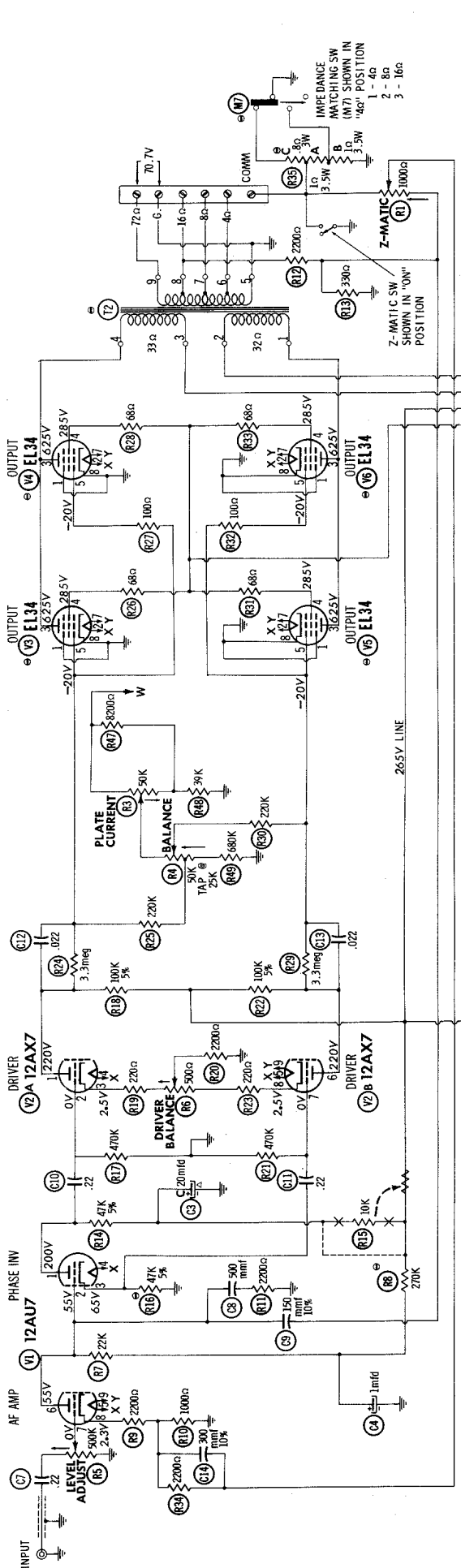

RESISTANCE READINGS

ITEM	TUBE	Pin 1	Pin 2	Pin 3	Pin 4	Pin 5	Pin 6	Pin 7	Pin 8	Pin 9
V1	12AX7	11.59K	11.190K	47K	.10	.10	11.190K	00	28000	.10
V2	12AU7	11.100K	470K	26000	.10	.10	11.100K	470K	26000	.10
V3	6CA7	00	.10	1.880	1.680	250K	NC	.10	00	
V4	6CA7	00	.10	1.880	1.680	250K	TP	.10	00	
V5	6CA7	00	.10	1.870	1.680	250K	NC	.10	00	
V6	6CA7	00	.10	1.870	1.680	250K	TP	.10	00	
V7	6AU6	35K	11.220K	.10	.10	1.280K	65K	11.220K		
V8	6Y6GT	NC	.10	1.400	1.400	1.280K	TP	.10	1	
V9	5R4GY	NC	1	TP	310	NC	310	TP	1	
V10	5R4GY	NC	1	TP	290	NC	290	NC	1	

1. DC voltage measurements taken with vacuum tube voltmeter; AC voltages measured at 1000 ohms per volt.
2. Socket connections are shown as bottom views.
3. Measured values are from socket pin to common negative.
4. Line voltage maintained at 117 volts for voltage readings.
5. Nominal tolerance of component values makes possible a variation of $\pm 15\%$ in voltage and resistance readings.
6. All controls at minimum, proper output load connected.

SEE PARTS LIST FOR ALTERNATE VALUE OR APPLICATION
 DC COIL RESISTANCE VALUES UNDER ONE OHM NOT SHOWN ON SCHEMATIC DIAGRAM