

Service Manual Supplement

DVD Video Player

FILE NO.

DVD-7000 (US)
(XE)

DVD-S2000 (US)

PRODUCT CODE No.
137 100 02 7000/US
137 100 01 7000/XE
137 100 00 S2000/US

The construction of model DVD-7000/US and DVD-S2000/US is similar to model DVD-S1500/US-2, and the construction of model DVD-7000/XE is similar to model DVD-1500/XE. The differences between these models require the bellow specified items. Please also refer to the original service manual DVD-S1500/US-2 or DVD-1500/XE (SM5810157) for other items.

LASER BEAM SAFETY PRECAUTION(XE)

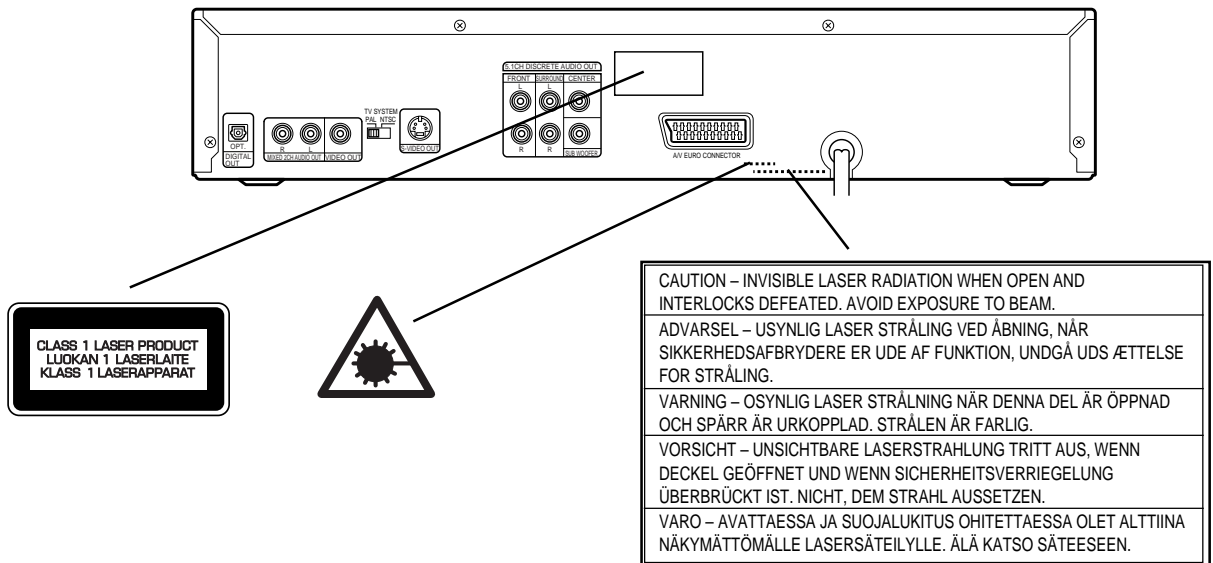

CAUTION OF DVD P.W.BOARD

If a "E" mark label is put on near a rating plate as shown, "E type" DVD P.W.Board ASSY is used.

If there is no "E" mark label near a rating plate, "U tpye" DVD P.W.Board ASSY is used.

("U type" is used for DVD-S1500/US-2 or DVD-1500/XE)

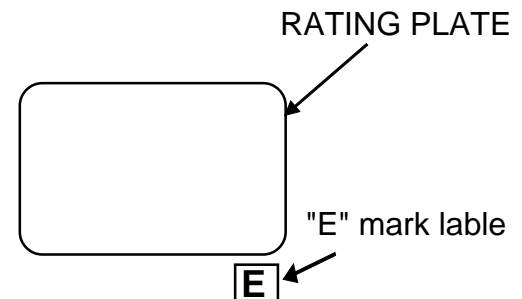

EXPLODED VIEW (CABINET & CHASSIS)

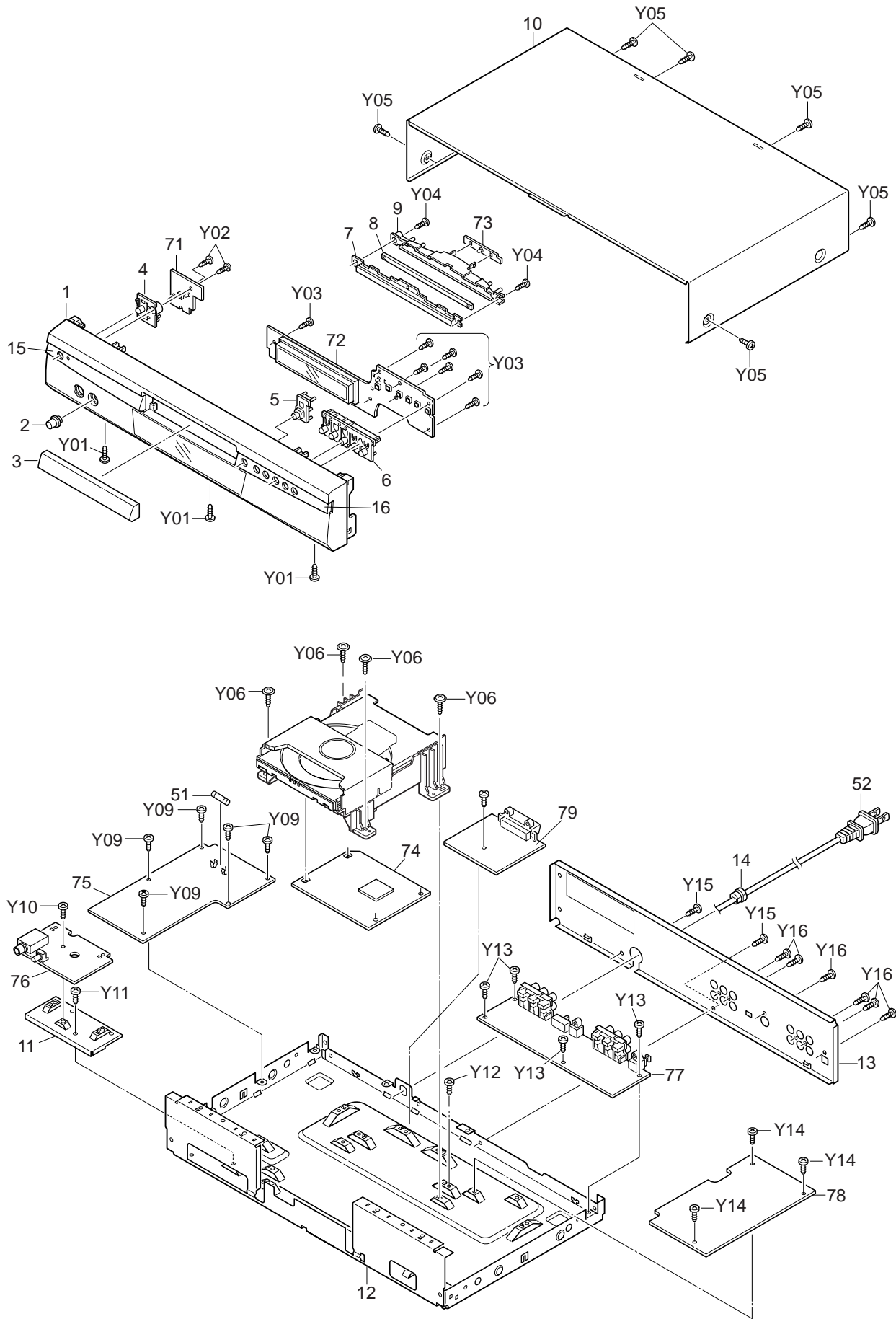

PARTS LIST

PRODUCT SAFETY NOTICE

EACH PRECAUTION IN THIS MANUAL SHOULD BE FOLLOWED DURING SERVICING. COMPONENTS IDENTIFIED WITH THE IEC SYMBOL Δ IN THE PARTS LIST AND THE SCHEMATIC DIAGRAM DESIGNATED COMPONENTS IN WHICH SAFETY CAN BE OF SPECIAL SIGNIFICANCE. WHEN REPLACING A COMPONENT IDENTIFIED BY Δ , USE ONLY THE REPLACEMENT PARTS DESIGNATED, OR PARTS WITH THE SAME RATINGS OF RESISTANCE, WATTAGE OR VOLTAGE THAT ARE DESIGNATED IN THE PARTS LIST IN THIS MANUAL. LEAKAGE-CURRENT OR RESISTANCE MEASUREMENTS MUST BE MADE TO DETERMINE THAT EXPOSED PARTS ARE ACCEPTABLY INSULATED FROM THE SUPPLY CIRCUIT BEFORE RETURNING THE PRODUCT TO THE CUSTOMER.

CAUTION : Regular type resistors and capacitors are not listed. To know those values, refer to the schematic diagram.
 Regular type resistors are less than 1/4 W carbon type and 0 ohm chip resistors.
 Regular type capacitors are less than 50 V and less than 1000 μ F type of Ceramic type and Electrical type.

PACKING & ACCESSORIES

REF.NO.	PART NO.	DESCRIPTION	REF.NO.	PART NO.	DESCRIPTION
			8	614 312 7697	DEC,WINDOW LED,UPER DVD TRAY (XE)(S2000/US)
	614 176 1268	INNER POLYE COVER,CABLE(US)	8	614 314 3789	DEC,WINDOW LED,UPER DVD TRAY (7000/US)
	614 312 1138	CARTON CASE,INNER(S2000/US)	9	614 312 1060	REFLECTOR,TRAY WINDOW, DVD WINDOW TRAY
	614 314 3826	CARTON CASE,INNER(7000/US)	10	614 312 0902	ASSY,CABINET,BENDING, AFTER BENDING(7000/US)
	614 314 9743	CARTON CASE,INNER(XE)	10	614 313 0031	ASSY,CABINET,BENDING, AFTER BENDING(S2000/US)(XE)
	614 313 9812	CUSHION,PAD,CARTON TOP	11	614 312 7703	MOUNTING,PHONE PWB,PHONE PWB
	614 312 1152	CUSHION,LEFT,LEFT	12	614 310 4445	ASSY,CABINET,BOTTOM
	614 312 1169	CUSHION,RIGHT,RIGHT	13	614 312 1053	PANEL,REAR(S2000/US)
	614 312 1213	INSTRUCTION SHEET, QUICK GUIDE(S2000/US)	13	614 314 3802	PANEL,REAR(7000/US)
	614 314 3833	INSTRUCTION SHEET, QUICK GUIDE(7000/US)	13	614 313 7559	PANEL,REAR(XE)
	614 312 1220	INSTRUCTION MANUAL(S2000/US)	14	614 129 1901	FIXER,AC CORD
	614 314 3840	INSTRUCTION MANUAL(7000/US)	14	614 284 1884	FIXER,AC CORD
	614 314 9804	INSTRUCTION MANUAL(XE)	15	614 312 1022	DEC,ESCUTCHEON L,LEFT SIDE
	614 315 4624	INSTRUCTION,MANUAL,GREEK(XE)	16	614 312 1039	DEC,ESCUTCHEON R,RIGHT SIDE
	645 007 8590	POLY BAG-0100X0250*NC,CABLE(XE)	FIXING PARTS		
	645 013 6535	POLY BAG-0250X0350*NC, INST MANUAL(XE)	REF.NO.	PART NO.	DESCRIPTION
	645 012 2958	POLY BAG-0250X0350*NC, INST MANUAL(US)	Y01	411 021 6405	SCR S-TPG BIN 3X8, FRONT-BOTTOM FIX
	645 044 8539	POLY SHEET-0850X0600*NC,SET(US)	Y02	411 021 3503	SCR S-TPG BIN 3X10, FRONT-POWER SW PWB FIX
	645 036 5775	POLY SHEET-0850X0600*NC,SET(XE)	Y03	411 021 3503	SCR S-TPG BIN 3X10,FRONT-PWB FIX
	645 042 6995	REMOCON,REM-S2000,C.G(S2000/US)	Y04	411 165 3803	SCR S-TPG BIN 2.3X10, FRONT-REFLECTOR LED
	645 043 5843	REMOCON,RB-7000U,(7000/US)	Y05	411 021 3701	SCR S-TPG BIN 3X10,CABINET
	645 043 9322	REMOCON,RB-7000,(XE)	Y06	411 020 8905	SCR S-TPG BRZ+FLG 3X10, DVD MECHA
	645 036 6734	BATTERY COVER, SERVICE PART(7000/US)	Y09	411 021 6405	SCR S-TPG BIN 3X8,POWER PWB
	645 043 9728	BATTERY COVER, SERVICE PART(S2000/US)	Y10	411 021 6405	SCR S-TPG BIN 3X8,PHONE PWB
	645 003 3414	CABLE,A/V(-3)	Y11	411 021 6405	SCR S-TPG BIN 3X8, MOUNTIN PHONE - BOTTOM
or	645 017 6012	CABLE,A/V(-3)	Y13	411 021 6405	SCR S-TPG BIN 3X8,OUT PWB
or	645 023 0806	CABLE,A/V(-3)	Y14	411 021 6405	SCR S-TPG BIN 3X8,MPEG PWB
or	645 037 3893	CABLE,A/V(-3)	Y15	411 021 3701	SCR S-TPG BIN 3X10,BOTTOM-REAR
or	645 013 8768	CABLE,S TERMINAL(US)	Y16	411 021 3701	SCR S-TPG BIN 3X10, REAR-ELECT PART
or	645 023 0820	CABLE,S TERMINAL(US)			
or	645 023 1308	CABLE,S TERMINAL(US)			
or	645 037 3909	CABLE,S TERMINAL(US)			

CABINET & CHASSIS

REF.NO.	PART NO.	DESCRIPTION
1	614 314 3727	ASSY,CABINET,FRONT(XE)
1	614 314 4038	ASSY,CABINET,FRONT(7000/US)
1	614 312 0926	ASSY,CABINET,FRONT(S2000/US)
2	614 313 5500	KNOB,ROTARY,HP VOLUME(XE) (S2000/US)
2	614 314 3796	KNOB,ROTARY,HP VOLUME(7000/US)
3	614 314 4076	ASSY,DEC,DVD,TRAY
4	614 312 0940	BUTTON,POWER
5	614 312 0957	BUTTON,OPEN/CLOSE
6	614 312 0933	BUTTON,PLAY/ PAUSE/ STOP
7	614 312 1015	DEC,WINDOW TRAY,UPER DVD TRAY (XE)(S2000/US)
7	614 314 3772	DEC,WINDOW TRAY,UPER DVD TRAY (7000/US)

ELECTRICAL-PARTS

REF.NO.	PART NO.	DESCRIPTION
51	Δ 423 027 4606	FUSE 125V 1A,125V 1A(US)
51	Δ 423 017 0007	FUSE 250V 1A,250V 1A(XE)
52	Δ 645 016 9939	CORD,POWER-1.74MK(XE)
52	Δ 614 255 2513	POWER CORD(XE)
52	Δ 645 032 7537	CORD,POWER-1.86MK(US)
	614 310 9754	ASSY,WIRE,SOCKET-SCART 11P(XE)
	614 313 0352	ASSY,WIRE,DG-LOADER 6P
	614 313 2318	ASSY,WIRE,MPEG-FRONT 12P
	614 313 2325	ASSY,WIRE,MPEG-SOCKET 10P
	614 313 2332	ASSY,WIRE,MPEG-SOCKET 9P
	614 313 2349	ASSY,WIRE,DG-MPEG 13P

PARTS LIST

REF.NO.	PART NO.	DESCRIPTION	REF.NO.	PART NO.	DESCRIPTION
	614 313 2370	ASSY,WIRE,MPEG-SOCKET 11P	R6004	401 105 0603	MT-GLAZE 10K JA 1/16W(US)
	614 314 2447	ASSY,WIRE,SOCKET-HP 5P	or	401 105 5202	MT-GLAZE 470 JA 1/16W(XE)
	645 041 9300	FLEXIBLE FLAT CABLE, MPEG-LOADER 16P	R6005	401 105 2805	MT-GLAZE 2.2K JA 1/16W(US)
	645 041 9317	FLEXIBLE FLAT CABLE, MPEG-LOADER 26P	or	401 105 6506	MT-GLAZE 680 JA 1/16W(XE)
	645 042 8999	CORE,FERRITE,FRONT-DG	R6006	401 105 0702	MT-GLAZE 100K JA 1/16W(US)
	645 042 8999	CORE,FERRITE,FRONT-MPEG	R6007	401 105 0702	MT-GLAZE 100K JA 1/16W(US)
	645 042 8999	CORE,FERRITE,LOADER-DG	R6008	401 105 0504	MT-GLAZE 1K JA 1/16W(US)
	645 042 8999	CORE,FERRITE,MPEG-SOCKET	R6009	401 105 0504	MT-GLAZE 1K JA 1/16W(US)
	645 013 6498	CORE,FERRITE,SOCKET-HP	R6010	401 105 0504	MT-GLAZE 1K JA 1/16W(US)
or	645 031 7637	CORE,FERRITE,SOCKET-HP	R6011	401 105 0504	MT-GLAZE 1K JA 1/16W(US)
	645 013 6498	CORE,FERRITE,AC CORD	or	401 105 0603	MT-GLAZE 10K JA 1/16W(XE)
or	645 031 7637	CORE,FERRITE,AC CORD	R6012	401 105 0603	MT-GLAZE 10K JA 1/16W(US)
			R6014	401 105 2805	MT-GLAZE 2.2K JA 1/16W(XE)
			R6017	401 105 8104	MT-GLAZE 56K JA 1/16W(US)
			R6038	401 105 0603	MT-GLAZE 10K JA 1/16W(XE)
			R6039	401 105 5301	MT-GLAZE 4.7K JA 1/16W(XE)
			R6040	401 105 5301	MT-GLAZE 4.7K JA 1/16W(XE)
			R6041	401 105 5301	MT-GLAZE 4.7K JA 1/16W(XE)
			R6043	401 105 0504	MT-GLAZE 1K JA 1/16W(XE)
			R6044	401 105 0405	MT-GLAZE 100 JA 1/16W
			R6100	401 105 7909	MT-GLAZE 0.000 ZA 1/16W
			R6101	401 105 7909	MT-GLAZE 0.000 ZA 1/16W
			R6102	401 105 7909	MT-GLAZE 0.000 ZA 1/16W
			R6103	401 105 7909	MT-GLAZE 0.000 ZA 1/16W
			R6104	401 105 7909	MT-GLAZE 0.000 ZA 1/16W
			R6105	401 105 7909	MT-GLAZE 0.000 ZA 1/16W
			R6106	401 105 7909	MT-GLAZE 0.000 ZA 1/16W
			R6107	401 105 7909	MT-GLAZE 0.000 ZA 1/16W
			R6108	401 105 7909	MT-GLAZE 0.000 ZA 1/16W
			R6109	401 105 7909	MT-GLAZE 0.000 ZA 1/16W
			R6110	401 105 7909	MT-GLAZE 0.000 ZA 1/16W
			R6111	401 105 7909	MT-GLAZE 0.000 ZA 1/16W(US)
			R6112	401 105 7909	MT-GLAZE 0.000 ZA 1/16W(US)
			R6113	401 105 7909	MT-GLAZE 0.000 ZA 1/16W(US)
			R6114	401 105 7909	MT-GLAZE 0.000 ZA 1/16W(US)
			R6115	401 105 7909	MT-GLAZE 0.000 ZA 1/16W(US)
			R6116	401 105 7909	MT-GLAZE 0.000 ZA 1/16W(US)
			R6117	401 105 7909	MT-GLAZE 0.000 ZA 1/16W(US)
			R6120	401 035 4108	MT-GLAZE 0.000 ZA 1/8W(XE)
			S6040	614 220 5471	SWITCH,TACT
			or	614 240 1002	SWITCH,TACT
			or	645 006 5958	SWITCH,PUSH 1P-1T
			S6041	614 220 5471	SWITCH,TACT
			or	614 240 1002	SWITCH,TACT
			or	645 006 5958	SWITCH,PUSH 1P-1T
			S6042	614 220 5471	SWITCH,TACT
			or	614 240 1002	SWITCH,TACT
			or	645 006 5958	SWITCH,PUSH 1P-1T
			S6043	614 220 5471	SWITCH,TACT
			or	614 240 1002	SWITCH,TACT
			or	645 006 5958	SWITCH,PUSH 1P-1T
			S6044	614 220 5471	SWITCH,TACT
			or	614 240 1002	SWITCH,TACT
			or	645 006 5958	SWITCH,PUSH 1P-1T
			S6045	614 220 5471	SWITCH,TACT
			or	614 240 1002	SWITCH,TACT
			or	645 006 5958	SWITCH,PUSH 1P-1T
			TA601	614 112 1383	DOUBLE_FACE,DOUBLE_FACE
			X6001	645 041 8471	OSC,CERAMIC 5.000MHZ(XE)

POWER SW P.W.BOARD ASSY

REF.NO.	PART NO.	DESCRIPTION
71	614 313 0314	ASSY,PWB,POWER SW(Only initial)(US)
71	△ 614 313 3216	ASSY,PWB,POWER SW(Only initial)(XE)
CN640	614 035 4935	SOCKET,DIP 4P,TO_FRONT
D6401	408 032 5404	LED SLP-9118C-51H-S-T1,STANDBY
D6402	407 012 4406	DIODE 1SS133(US)
S6401	614 220 5471	SWITCH,TACT
or	614 240 1002	SWITCH,TACT
or	645 006 5958	SWITCH,PUSH 1P-1T

FRONT P.W.BOARD ASSY

REF.NO.	PART NO.	DESCRIPTION
72	614 313 0284	ASSY,PWB,FRONT(Only initial)(US)
72	△ 614 313 2837	ASSY,PWB,FRONT(Only initial)(XE)
BR601	614 305 2241	HOLDER,FL
CN601	645 006 0878	PLUG,12P
CN602	614 035 4959	SOCKET,DIP 6P,TO_DG
CN604	614 035 4935	SOCKET,DIP 4P,TO_POWER_SW
CN605	614 035 4911	SOCKET,DIP 2P,TO_LED
CN612	614 313 2387	ASSY,WIRE,TO_DG
D6040	407 012 4406	DIODE 1SS133(US)
D6041	407 012 4406	DIODE 1SS133(US)
D6042	407 012 4406	DIODE 1SS133(US)
D6043	407 012 4406	DIODE 1SS133(US)
D6044	407 012 4406	DIODE 1SS133(US)
D6045	407 012 4406	DIODE 1SS133(US)
D6046	408 037 4204	LED SLP-3118B-51HAB-T1, OPEN_CLOSE
D6047	407 063 9108	ZENER DIODE MTZJ6.8B(US)
DS601	407 217 8407	PHOTO DIODE SPS-440-1-G
FL601	645 039 9213	FLOURESCENT TUBE
IC601	410 389 4702	IC UPD780232GC-025-8BT(XE)
or	410 349 2700	IC UPD16311GC-AB6(US)
IC602	409 464 7905	IC BMR-0301E(XE)
Q6020	405 000 0508	TR DTA114ES(US)
or	405 110 5400	TR KRA102M-A(US)
or	405 000 3806	TR DTC114YS(XE)
or	405 143 0007	TR KRC107M(XE)
Q6021	405 000 0508	TR DTA114ES(US)
or	405 110 5400	TR KRA102M-A(US)
or	405 000 3806	TR DTC114YS(XE)
or	405 143 0007	TR KRC107M(XE)
Q6022	405 000 0409	TR DTA114EK(US)
or	405 146 5306	TR KRA102S(US)
or	405 000 3608	TR DTC114YK(XE)
or	405 159 0503	TR KRC107S(XE)
R6001	401 105 0603	MT-GLAZE 10K JA 1/16W(US)
or	401 105 4502	MT-GLAZE 390 JA 1/16W(XE)
R6002	401 105 0603	MT-GLAZE 10K JA 1/16W(US)
or	401 105 5202	MT-GLAZE 470 JA 1/16W(XE)
R6003	401 105 0603	MT-GLAZE 10K JA 1/16W(US)
or	401 105 4502	MT-GLAZE 390 JA 1/16W(XE)

TRAY LED P.W.BOARD ASSY

REF.NO.	PART NO.	DESCRIPTION
73	614 313 0321	ASSY,PWB,TRAY LED(Only initial)
CN650	614 035 4911	SOCKET,DIP 2P,TO_FRONT
D6501	407 212 8907	LED HLMP-BB01-J0B00,TRAY

PARTS LIST

DVD P.W.BOARD ASSY

REF.NO.	PART NO.	DESCRIPTION	REF.NO.	PART NO.	DESCRIPTION
74	614 315 1272	ASSY,PWB DVD E TYPE(Only initial)	Q1012	405 153 2008	TR 2SK3018
CN100	645 040 0865	SOCKET,FPC 33P	Q1013	405 029 3504	TR DTC144EK
CN200	645 041 3810	SOCKET,FPC 26P	or	405 146 1407	TR KRC104S
CN500	645 041 3803	SOCKET,FPC 16P	or	405 138 6700	TR DTC144EKA
CN510	645 006 0953	PLUG,8P	Q5020	405 014 4509	TR 2SC2412K-R
CN540	645 006 0915	PLUG,4P	or	405 146 2206	TR KTC3875-GR
CN600	645 006 0922	PLUG,5P	or	405 146 2107	TR KTC3875-Y
CN610	645 028 8692	SOCKET,FPC 11P	or	405 011 1006	TR 2SC1623-L6
CN620	645 006 2025	PLUG,2P	R1003	401 105 2607	MT-GLAZE 22 JA 1/16W
CN630	645 006 0908	PLUG,2P	R1004	401 105 2607	MT-GLAZE 22 JA 1/16W
CN900	645 006 0939	PLUG,6P	R1005	401 105 0504	MT-GLAZE 1K JA 1/16W
IC100	409 482 3903	IC LA9702WL-MPB	R1006	401 105 0504	MT-GLAZE 1K JA 1/16W
IC101	409 333 2505	IC BU4066BCF	R1007	401 105 2805	MT-GLAZE 2.2K JA 1/16W
IC200	409 822 9606	IC LC78660W-D	R1008	401 105 2805	MT-GLAZE 2.2K JA 1/16W
IC201	409 447 3702	IC T224162B-35S	R1009	401 105 0603	MT-GLAZE 10K JA 1/16W
or	410 367 3604	IC LC324265AT-25DV-TLM	R1010	401 105 2904	MT-GLAZE 22K JA 1/16W
or	409 447 3702	IC T224162B-35S	R1011	401 105 0702	MT-GLAZE 100K JA 1/16W
or	410 375 9407	IC LC324265AT-25DV-MPB	R1012	401 105 2904	MT-GLAZE 22K JA 1/16W
or	410 388 4505	IC M11B416256A-35T	R1013	401 105 2904	MT-GLAZE 22K JA 1/16W
IC500	409 490 0307	IC M37920S4CGP	R1014	401 105 3406	MT-GLAZE 27K JA 1/16W
IC502	409 183 0102	IC M51953BFP	R1015	401 105 4205	MT-GLAZE 33K JA 1/16W
IC504	409 330 9606	IC TC7SHU04FU	R1016	401 105 2904	MT-GLAZE 22K JA 1/16W
or	409 484 7503	IC NC7SZU04P5	R1017	401 105 4205	MT-GLAZE 33K JA 1/16W
IC550	410 386 7300	IC ASSY(IC LE28C1001ATS-90-MPB)	R1018	401 105 2607	MT-GLAZE 22 JA 1/16W
IC601	409 484 9101	IC BA5937AFP	R1019	401 105 2607	MT-GLAZE 22 JA 1/16W
IC602	409 405 6301	IC BA6849FP	R1122	401 105 5301	MT-GLAZE 4.7K JA 1/16W
IC900	▲ 409 416 6406	IC BA033FP	R1124	401 105 5301	MT-GLAZE 4.7K JA 1/16W
L1001	645 019 0988	INDUCTOR,1000 OHM	R1125	401 105 0603	MT-GLAZE 10K JA 1/16W
or	645 020 2001	INDUCTOR,1000 OHM	R1126	401 105 3406	MT-GLAZE 27K JA 1/16W
L1002	645 019 0988	INDUCTOR,1000 OHM	R1128	401 105 0603	MT-GLAZE 10K JA 1/16W
or	645 020 2001	INDUCTOR,1000 OHM	R1132	401 105 5400	MT-GLAZE 47K JA 1/16W
L1003	645 019 0988	INDUCTOR,1000 OHM	R1133	401 105 5400	MT-GLAZE 47K JA 1/16W
or	645 020 2001	INDUCTOR,1000 OHM	R1137	401 105 0504	MT-GLAZE 1K JA 1/16W
L1004	645 019 0988	INDUCTOR,1000 OHM	R1141	401 105 0504	MT-GLAZE 1K JA 1/16W
or	645 020 2001	INDUCTOR,1000 OHM	R1156	401 105 5905	MT-GLAZE 560 JA 1/16W
L1005	645 019 0988	INDUCTOR,1000 OHM	R1157	401 105 5905	MT-GLAZE 560 JA 1/16W
or	645 020 2001	INDUCTOR,1000 OHM	R1158	401 105 0405	MT-GLAZE 100 JA 1/16W
L2001	645 019 0988	INDUCTOR,1000 OHM	R1159	401 105 0504	MT-GLAZE 1K JA 1/16W
or	645 020 2001	INDUCTOR,1000 OHM	R1160	401 105 4007	MT-GLAZE 330 JA 1/16W
L9001	645 001 5427	INDUCTOR,2.2U M	R1161	401 105 4007	MT-GLAZE 330 JA 1/16W
Q1002	405 014 4509	TR 2SC2412K-R	R1162	401 105 4007	MT-GLAZE 330 JA 1/16W
or	405 146 2206	TR KTC3875-GR	R1163	401 105 1402	MT-GLAZE 150 JA 1/16W
or	405 146 2107	TR KTC3875-Y	R1164	401 105 4007	MT-GLAZE 330 JA 1/16W
or	405 011 1006	TR 2SC1623-L6	R1165	401 105 4007	MT-GLAZE 330 JA 1/16W
Q1003	405 014 4509	TR 2SC2412K-R	R1166	401 105 4007	MT-GLAZE 330 JA 1/16W
or	405 146 2206	TR KTC3875-GR	R1167	401 105 4007	MT-GLAZE 330 JA 1/16W
or	405 146 2107	TR KTC3875-Y	R1168	401 105 4007	MT-GLAZE 330 JA 1/16W
or	405 011 1006	TR 2SC1623-L6	R1169	401 105 4007	MT-GLAZE 330 JA 1/16W
Q1004	405 035 5509	TR 2SA1036K-R	R1170	401 105 5400	MT-GLAZE 47K JA 1/16W
or	405 158 5905	TR KTA1505-Y	R1171	401 105 7909	MT-GLAZE 0.000 ZA 1/16W
Q1005	405 035 5509	TR 2SA1036K-R	R1172	401 105 5400	MT-GLAZE 47K JA 1/16W
or	405 158 5905	TR KTA1505-Y	R1174	401 105 5400	MT-GLAZE 47K JA 1/16W
Q1008	405 014 4509	TR 2SC2412K-R	R1176	401 105 2904	MT-GLAZE 22K JA 1/16W
or	405 146 2206	TR KTC3875-GR	R1177	401 105 2904	MT-GLAZE 22K JA 1/16W
or	405 146 2107	TR KTC3875-Y	R1179	401 105 2904	MT-GLAZE 22K JA 1/16W
or	405 011 1006	TR 2SC1623-L6	R1180	401 105 1105	MT-GLAZE 12K JA 1/16W
Q1009	405 014 4509	TR 2SC2412K-R	R1181	401 105 3406	MT-GLAZE 27K JA 1/16W
or	405 146 2206	TR KTC3875-GR	R1184	401 105 8104	MT-GLAZE 56K JA 1/16W
or	405 146 2107	TR KTC3875-Y	R1185	401 105 7909	MT-GLAZE 0.000 ZA 1/16W
or	405 011 1006	TR 2SC1623-L6	R1186	401 105 7909	MT-GLAZE 0.000 ZA 1/16W
Q1010	405 002 0308	TR 2SA1037K-R	R1187	401 105 7909	MT-GLAZE 0.000 ZA 1/16W
or	405 146 9700	TR KTA1504-GR	R1189	401 105 3406	MT-GLAZE 27K JA 1/16W
or	405 134 5905	TR 2SA1037AK-R	R1190	401 105 5400	MT-GLAZE 47K JA 1/16W
Q1011	405 014 4509	TR 2SC2412K-R	R1191	401 105 6605	MT-GLAZE 6.8K JA 1/16W
or	405 146 2206	TR KTC3875-GR	R1192	401 105 3406	MT-GLAZE 27K JA 1/16W
or	405 146 2107	TR KTC3875-Y	R1193	401 105 5400	MT-GLAZE 47K JA 1/16W
or	405 011 1006	TR 2SC1623-L6	R1195	401 105 7909	MT-GLAZE 0.000 ZA 1/16W
			R1197	401 105 7909	MT-GLAZE 0.000 ZA 1/16W
			R1198	401 105 7909	MT-GLAZE 0.000 ZA 1/16W

PARTS LIST

REF.NO.	PART NO.	DESCRIPTION	REF.NO.	PART NO.	DESCRIPTION
R1199	401 105 7909	MT-GLAZE 0.000 ZA 1/16W	R5007	401 105 0603	MT-GLAZE 10K JA 1/16W
R2001	401 105 0504	MT-GLAZE 1K JA 1/16W	R5008	401 105 0603	MT-GLAZE 10K JA 1/16W
R2002	401 105 0504	MT-GLAZE 1K JA 1/16W	R5017	401 105 5301	MT-GLAZE 4.7K JA 1/16W
R2003	401 105 0504	MT-GLAZE 1K JA 1/16W	R5018	401 105 0603	MT-GLAZE 10K JA 1/16W
R2004	401 105 0504	MT-GLAZE 1K JA 1/16W	R5019	401 105 0603	MT-GLAZE 10K JA 1/16W
R2006	401 105 0504	MT-GLAZE 1K JA 1/16W	R5020	401 105 5400	MT-GLAZE 47K JA 1/16W
R2007	401 105 0504	MT-GLAZE 1K JA 1/16W	R5021	401 105 0603	MT-GLAZE 10K JA 1/16W
R2008	401 105 0603	MT-GLAZE 10K JA 1/16W	R5022	401 105 0603	MT-GLAZE 10K JA 1/16W
R2009	401 105 0603	MT-GLAZE 10K JA 1/16W	R5024	401 105 5301	MT-GLAZE 4.7K JA 1/16W
R2010	401 105 0603	MT-GLAZE 10K JA 1/16W	R5026	401 105 0603	MT-GLAZE 10K JA 1/16W
R2011	401 105 0603	MT-GLAZE 10K JA 1/16W	R5027	401 105 0603	MT-GLAZE 10K JA 1/16W
R2012	401 105 0603	MT-GLAZE 10K JA 1/16W	R5028	401 105 0603	MT-GLAZE 10K JA 1/16W
R2013	401 105 0603	MT-GLAZE 10K JA 1/16W	R5029	401 105 0603	MT-GLAZE 10K JA 1/16W
R2014	401 105 0603	MT-GLAZE 10K JA 1/16W	R5031	401 105 0603	MT-GLAZE 10K JA 1/16W
R2015	401 105 0603	MT-GLAZE 10K JA 1/16W	R5032	401 105 0603	MT-GLAZE 10K JA 1/16W
R2016	401 105 0603	MT-GLAZE 10K JA 1/16W	R5033	401 105 0603	MT-GLAZE 10K JA 1/16W
R2017	401 105 0603	MT-GLAZE 10K JA 1/16W	R5034	401 105 0603	MT-GLAZE 10K JA 1/16W
R2018	401 105 0603	MT-GLAZE 10K JA 1/16W	R5035	401 105 0603	MT-GLAZE 10K JA 1/16W
R2019	401 105 0603	MT-GLAZE 10K JA 1/16W	R5036	401 105 0603	MT-GLAZE 10K JA 1/16W
R2020	401 105 2607	MT-GLAZE 22 JA 1/16W	R5037	401 105 0603	MT-GLAZE 10K JA 1/16W
R2040	401 105 4205	MT-GLAZE 33K JA 1/16W	R5038	401 105 5301	MT-GLAZE 4.7K JA 1/16W
R2084	401 105 0702	MT-GLAZE 100K JA 1/16W	R5039	401 105 7909	MT-GLAZE 0.000 ZA 1/16W
R2407	401 105 3406	MT-GLAZE 27K JA 1/16W	R5040	401 105 7909	MT-GLAZE 0.000 ZA 1/16W
R2408	401 105 7909	MT-GLAZE 0.000 ZA 1/16W	R5042	401 105 5400	MT-GLAZE 47K JA 1/16W
R2410	401 105 0603	MT-GLAZE 10K JA 1/16W	R5043	401 105 5400	MT-GLAZE 47K JA 1/16W
R2411	401 105 1006	MT-GLAZE 1.2K JA 1/16W	R5044	401 105 5400	MT-GLAZE 47K JA 1/16W
R2412	401 105 2003	MT-GLAZE 1.8K JA 1/16W	R5045	401 105 5400	MT-GLAZE 47K JA 1/16W
R2413	401 105 2904	MT-GLAZE 22K JA 1/16W	R5046	401 105 5400	MT-GLAZE 47K JA 1/16W
R2414	401 105 2904	MT-GLAZE 22K JA 1/16W	R5047	401 105 5400	MT-GLAZE 47K JA 1/16W
R2417	401 105 1006	MT-GLAZE 1.2K JA 1/16W	R5048	401 105 5400	MT-GLAZE 47K JA 1/16W
R2419	401 105 6506	MT-GLAZE 680 JA 1/16W	R5049	401 105 7909	MT-GLAZE 0.000 ZA 1/16W
R2423	401 105 1402	MT-GLAZE 150 JA 1/16W	R5066	401 105 0603	MT-GLAZE 10K JA 1/16W
R2424	401 105 8005	MT-GLAZE 1M JA 1/16W	R5067	401 105 0603	MT-GLAZE 10K JA 1/16W
R2425	401 105 6001	MT-GLAZE 5.6K JA 1/16W	R5068	401 105 0603	MT-GLAZE 10K JA 1/16W
R2426	401 105 0603	MT-GLAZE 10K JA 1/16W	R5069	401 105 0603	MT-GLAZE 10K JA 1/16W
R2427	401 105 2706	MT-GLAZE 220 JA 1/16W	R5070	401 105 0603	MT-GLAZE 10K JA 1/16W
R2428	401 105 0405	MT-GLAZE 100 JA 1/16W	R5071	401 105 0603	MT-GLAZE 10K JA 1/16W
R2429	401 105 0405	MT-GLAZE 100 JA 1/16W	R5072	401 105 0603	MT-GLAZE 10K JA 1/16W
R2430	401 105 0405	MT-GLAZE 100 JA 1/16W	R5073	401 105 0603	MT-GLAZE 10K JA 1/16W
R2431	401 105 0405	MT-GLAZE 100 JA 1/16W	R5075	401 105 0603	MT-GLAZE 10K JA 1/16W
R2432	401 105 0405	MT-GLAZE 100 JA 1/16W	R5076	401 105 5301	MT-GLAZE 4.7K JA 1/16W
R2435	401 105 7909	MT-GLAZE 0.000 ZA 1/16W	R5077	401 105 0603	MT-GLAZE 10K JA 1/16W
R2437	401 105 7909	MT-GLAZE 0.000 ZA 1/16W	R5080	401 105 5301	MT-GLAZE 4.7K JA 1/16W
R2439	401 105 7909	MT-GLAZE 0.000 ZA 1/16W	R5203	401 105 7909	MT-GLAZE 0.000 ZA 1/16W
R2441	401 105 7909	MT-GLAZE 0.000 ZA 1/16W	R5204	401 105 7909	MT-GLAZE 0.000 ZA 1/16W
R2443	401 105 7909	MT-GLAZE 0.000 ZA 1/16W	R5205	401 105 7909	MT-GLAZE 0.000 ZA 1/16W
R2445	401 105 7909	MT-GLAZE 0.000 ZA 1/16W	R5206	401 105 7909	MT-GLAZE 0.000 ZA 1/16W
R2447	401 105 7909	MT-GLAZE 0.000 ZA 1/16W	R5208	401 105 7909	MT-GLAZE 0.000 ZA 1/16W
R2449	401 105 7909	MT-GLAZE 0.000 ZA 1/16W	R5209	401 105 7909	MT-GLAZE 0.000 ZA 1/16W
R2451	401 105 7909	MT-GLAZE 0.000 ZA 1/16W	R5210	401 105 7909	MT-GLAZE 0.000 ZA 1/16W
R2453	401 105 7909	MT-GLAZE 0.000 ZA 1/16W	R5211	401 105 7909	MT-GLAZE 0.000 ZA 1/16W
R2455	401 105 7909	MT-GLAZE 0.000 ZA 1/16W	R5212	401 105 7909	MT-GLAZE 0.000 ZA 1/16W
R2457	401 105 7909	MT-GLAZE 0.000 ZA 1/16W	R5213	401 105 7909	MT-GLAZE 0.000 ZA 1/16W
R2459	401 105 7909	MT-GLAZE 0.000 ZA 1/16W	R5214	401 105 0603	MT-GLAZE 10K JA 1/16W
R2461	401 105 2607	MT-GLAZE 22 JA 1/16W	R5215	401 105 0504	MT-GLAZE 1K JA 1/16W
R2463	401 105 7909	MT-GLAZE 0.000 ZA 1/16W	R5216	401 105 8005	MT-GLAZE 1M JA 1/16W
R2466	401 105 7909	MT-GLAZE 0.000 ZA 1/16W	R5221	401 105 0603	MT-GLAZE 10K JA 1/16W
R2467	401 105 7909	MT-GLAZE 0.000 ZA 1/16W	R5222	401 105 3307	MT-GLAZE 2.7K JA 1/16W
R2468	401 037 5004	MT-GLAZE 0.000 ZA 1/10W	R5223	401 105 0603	MT-GLAZE 10K JA 1/16W
R2469	401 105 7909	MT-GLAZE 0.000 ZA 1/16W	R5224	401 105 0603	MT-GLAZE 10K JA 1/16W
R2470	401 105 7909	MT-GLAZE 0.000 ZA 1/16W	R5226	401 105 8005	MT-GLAZE 1M JA 1/16W
R2471	401 105 7909	MT-GLAZE 0.000 ZA 1/16W	R5228	401 105 0603	MT-GLAZE 10K JA 1/16W
R2472	401 105 7909	MT-GLAZE 0.000 ZA 1/16W	R5229	401 105 0603	MT-GLAZE 10K JA 1/16W
R2473	401 105 7909	MT-GLAZE 0.000 ZA 1/16W	R5239	401 105 0603	MT-GLAZE 10K JA 1/16W
R5003	401 105 0603	MT-GLAZE 10K JA 1/16W	R5240	401 105 0603	MT-GLAZE 10K JA 1/16W
R5004	401 105 0603	MT-GLAZE 10K JA 1/16W	R5241	401 105 0603	MT-GLAZE 10K JA 1/16W
R5005	401 105 0603	MT-GLAZE 10K JA 1/16W	R5242	401 105 0603	MT-GLAZE 10K JA 1/16W
R5006	401 105 0603	MT-GLAZE 10K JA 1/16W	R5243	401 105 0603	MT-GLAZE 10K JA 1/16W

PARTS LIST

REF.NO.	PART NO.	DESCRIPTION	DG P.W.BOARD ASSY	REF.NO.	PART NO.	DESCRIPTION
R5244	401 105 0603	MT-GLAZE 10K JA 1/16W		75	614 313 0291	ASSY,PWB,DG(Only initial)(US)
R5247	401 105 0603	MT-GLAZE 10K JA 1/16W		75	△ 614 313 2844	ASSY,PWB,DG(Only initial)(XE)
R5248	401 105 0603	MT-GLAZE 10K JA 1/16W		C4900	△ 403 348 1508	MT-POLYEST 0.022U K 400V
R5249	401 105 0603	MT-GLAZE 10K JA 1/16W		C4901	403 082 0201	POLYPRO 470P J 100V
R5250	401 105 0603	MT-GLAZE 10K JA 1/16W		C4902	403 082 0201	POLYPRO 470P J 100V
R5251	401 105 5301	MT-GLAZE 4.7K JA 1/16W		C4906	△ 404 080 8206	MT-POLYEST 0.1U K 250V
R5252	401 105 5301	MT-GLAZE 4.7K JA 1/16W		C4907	△ 404 080 8206	MT-POLYEST 0.1U K 250V
R5253	401 105 5301	MT-GLAZE 4.7K JA 1/16W		CN481	645 006 0885	PLUG,13P
R5254	401 105 5301	MT-GLAZE 4.7K JA 1/16W		CN483	645 005 8127	PLUG,6P
R5255	401 105 5301	MT-GLAZE 4.7K JA 1/16W		CN485	645 005 8127	PLUG,6P
R5256	401 105 5301	MT-GLAZE 4.7K JA 1/16W		D4800	407 099 9509	ZENER DIODE MTZJ30B
R5257	401 105 5301	MT-GLAZE 4.7K JA 1/16W		D4802	407 012 4406	DIODE 1SS133
R5258	401 105 5301	MT-GLAZE 4.7K JA 1/16W		D4803	△ 407 169 5806	DIODE RK36LF-C4
R5259	401 105 5301	MT-GLAZE 4.7K JA 1/16W		D4804	△ 407 205 0109	DIODE RK34LF-C4
R5260	401 105 5301	MT-GLAZE 4.7K JA 1/16W		D4805	△ 407 213 3000	DIODE AG01Z
R5261	401 105 5301	MT-GLAZE 4.7K JA 1/16W		D4806	△ 407 213 3000	DIODE AG01Z
R5262	401 105 5301	MT-GLAZE 4.7K JA 1/16W		D4807	407 065 1308	ZENER DIODE MTZJ3.6B
R5263	401 105 5301	MT-GLAZE 4.7K JA 1/16W		D4820	407 099 6607	ZENER DIODE MTZJ12B
R5264	401 105 5301	MT-GLAZE 4.7K JA 1/16W		D4850	△ 407 004 9709	DIODE DSK10C
R5265	401 105 5301	MT-GLAZE 4.7K JA 1/16W		D4900	△ 407 091 6704	DIODE AP01C
R5266	401 105 5301	MT-GLAZE 4.7K JA 1/16W		D4901	△ 407 213 3000	DIODE AG01Z
R5267	401 105 5301	MT-GLAZE 4.7K JA 1/16W		D4902	△ 407 213 3000	DIODE AG01Z
R5268	401 105 5301	MT-GLAZE 4.7K JA 1/16W		D4903	△ 407 213 3000	DIODE AG01Z
R5269	401 105 5301	MT-GLAZE 4.7K JA 1/16W		D4904	△ 407 012 0408	DIODE 1N4004
R5270	401 105 5301	MT-GLAZE 4.7K JA 1/16W		or	△ 407 004 9808	DIODE DSK10E
R5271	401 105 5301	MT-GLAZE 4.7K JA 1/16W		or	△ 407 004 9808	DIODE DSK10E
R5272	401 105 5301	MT-GLAZE 4.7K JA 1/16W		D4905	△ 407 012 0408	DIODE 1N4004
R5273	401 105 5301	MT-GLAZE 4.7K JA 1/16W		or	△ 407 004 9808	DIODE DSK10E
R5274	401 105 5301	MT-GLAZE 4.7K JA 1/16W		or	△ 407 004 9808	DIODE DSK10E
R5275	401 105 5301	MT-GLAZE 4.7K JA 1/16W		D4906	△ 407 012 0408	DIODE 1N4004
R5276	401 105 7909	MT-GLAZE 0.000 ZA 1/16W		or	△ 407 004 9808	DIODE DSK10E
R5280	401 105 5400	MT-GLAZE 47K JA 1/16W		or	△ 407 004 9808	DIODE DSK10E
R6009	401 105 0603	MT-GLAZE 10K JA 1/16W		D4907	△ 407 012 0408	DIODE 1N4004
R6010	401 105 0603	MT-GLAZE 10K JA 1/16W		or	△ 407 004 9808	DIODE DSK10E
R6011	401 105 0603	MT-GLAZE 10K JA 1/16W		or	△ 407 004 9808	DIODE DSK10E
R6012	401 148 6006	MT-GLAZE 2.2 JA 1/16W		D4910	407 012 4406	DIODE 1SS133
R6013	401 148 6006	MT-GLAZE 2.2 JA 1/16W		FPC01	645 006 4760	HOLDER,FUSE
R6014	401 148 6006	MT-GLAZE 2.2 JA 1/16W		or	645 031 7903	HOLDER,FUSE
R6015	401 148 6006	MT-GLAZE 2.2 JA 1/16W		FPC02	645 006 4760	HOLDER,FUSE
R6016	401 105 6407	MT-GLAZE 68 JA 1/16W		or	645 031 7903	HOLDER,FUSE
R6017	401 105 6407	MT-GLAZE 68 JA 1/16W		HS491	△ 614 215 9347	HEAT SINK
R6021	401 105 7909	MT-GLAZE 0.000 ZA 1/16W		HS492	△ 614 215 9347	HEAT SINK
R6508	401 105 0504	MT-GLAZE 1K JA 1/16W		IC480	△ 409 483 2707	IC PQ05RD21
R6509	401 105 0603	MT-GLAZE 10K JA 1/16W		IC483	△ 409 067 7203	IC L5431
R6526	401 105 7909	MT-GLAZE 0.000 ZA 1/16W		IC484	409 416 6406	IC BA033FP
R6562	401 105 7909	MT-GLAZE 0.000 ZA 1/16W		IC490	△ 409 460 3109	IC STR-G6651
R6564	401 105 5301	MT-GLAZE 4.7K JA 1/16W		L4800	645 042 3703	INDUCTOR,22U
R6565	401 105 0603	MT-GLAZE 10K JA 1/16W		L4801	645 042 3703	INDUCTOR,22U
R6566	401 105 7909	MT-GLAZE 0.000 ZA 1/16W		L4802	645 003 5814	INDUCTOR,100U J
R6568	401 105 0603	MT-GLAZE 10K JA 1/16W		L4900	△ 645 038 2024	LINE FILTER
R6569	401 105 0603	MT-GLAZE 10K JA 1/16W		PC490	407 213 9309	PHOTO COUPLE PF5001-B C
R6573	401 105 0504	MT-GLAZE 1K JA 1/16W		or	407 213 2805	PHOTO COUPLE TLP621-GR
R6574	401 105 0504	MT-GLAZE 1K JA 1/16W		PC491	407 213 9309	PHOTO COUPLE PF5001-B C(XE)
R6575	401 105 7909	MT-GLAZE 0.000 ZA 1/16W		or	407 213 2805	PHOTO COUPLE TLP621-GR(XE)
R9000	401 037 5004	MT-GLAZE 0.000 ZA 1/10W		PR481	△ 645 014 2451	PROTECTOR,0.25A 125V
R9001	401 037 5004	MT-GLAZE 0.000 ZA 1/10W		or	△ 645 042 2522	PROTECTOR,0.25A 125V(XE)
R9002	401 037 5004	MT-GLAZE 0.000 ZA 1/10W		PR482	△ 645 014 2512	PROTECTOR,1A 125V
R9003	401 037 5004	MT-GLAZE 0.000 ZA 1/10W		or	△ 645 042 2614	PROTECTOR,1A 125V(XE)
R9004	401 037 5004	MT-GLAZE 0.000 ZA 1/10W		PR483	△ 645 014 2550	PROTECTOR,2A 125V
R9005	401 037 5004	MT-GLAZE 0.000 ZA 1/10W		or	△ 645 042 2669	PROTECTOR,2A 125V(XE)
X2000	645 040 6089	OSC,CERAMIC 16.934MHZ		PR484	△ 645 013 7075	PROTECTOR,0.5A 125V
X5000	645 041 3797	OSC,CERAMIC 16.0MHZ		PT490	△ 645 040 7901	TRANS,POWER,PULSE(US)
				or	△ 645 042 9279	TRANS,POWER,PULSE(XE)
				Q4801	△ 405 141 3703	TR KTA1271-
				Q4820	△ 405 141 1402	TR KTD863-GR
				Q4821	405 000 3806	TR DTC114YS(XE)
				or	405 143 0007	TR KRC107M(XE)

PARTS LIST

REF.NO.	PART NO.	DESCRIPTION
Q4850	405 000 3806	TR DTC114YS(XE)
or	405 143 0007	TR KRC107M(XE)
Q4851	405 000 3806	TR DTC114YS(XE)
or	405 143 0007	TR KRC107M(XE)
Q4852	405 000 3806	TR DTC114YS(XE)
or	405 143 0007	TR KRC107M(XE)
Q4853	405 004 4601	TR 2SA608-F-SPA(XE)
or	405 004 5103	TR 2SA608-G-SPA(XE)
or	405 006 1806	TR 2SA933S-R(XE)
or	405 006 1905	TR 2SA933S-S(XE)
or	405 143 6504	TR KTA1267-GR(XE)
Q4854	△ 405 023 5009	TR 2SD400-E-MP(XE)
or	△ 405 023 5306	TR 2SD400-F-MP(XE)
or	△ 405 141 1402	TR KTD863-GR(XE)
Q4855	405 004 4601	TR 2SA608-F-SPA(XE)
or	405 004 5103	TR 2SA608-G-SPA(XE)
or	405 006 1806	TR 2SA933S-R(XE)
or	405 006 1905	TR 2SA933S-S(XE)
or	405 143 6504	TR KTA1267-GR(XE)
R4800	401 105 0504	MT-GLAZE 1K JA 1/16W
R4802	401 105 7305	MT-GLAZE 820 JA 1/16W
R4803	401 105 0504	MT-GLAZE 1K JA
R4804	401 105 1501	MT-GLAZE 1.5K JA 1/16W
R4808	401 105 0306	MT-GLAZE 10 JA 1/16
R4809	401 105 2706	MT-GLAZE 220 JA 1/16W
R4810	401 105 0504	MT-GLAZE 1K JA 1/16W
R4820	401 105 5301	MT-GLAZE 4.7K JA 1/16W
R4850	401 105 2706	MT-GLAZE 220 JA 1/16W(XE)
R4851	401 105 4106	MT-GLAZE 3.3K JA 1/16W(XE)
R4852	401 105 0603	MT-GLAZE 10K JA 1/16W(XE)
R4853	401 105 7503	MT-GLAZE 82K JA 1/16W(XE)
R4854	401 105 0603	MT-GLAZE 10K JA 1/16W(XE)
R4855	401 105 0603	MT-GLAZE 10K JA 1/16W(XE)
R4901	△ 402 083 4904	RESISTOR 220K J- 1W(US)
or	△ 402 083 4904	RESISTOR 220K J- 1W(XE)
R4905	△ 402 082 6206	RESISTOR 0.56 J- 1W
R4907	△ 402 083 4904	RESISTOR 220K J- 1W(XE)
or	△ 402 082 6305	RESISTOR 68K J- 1W(US)
R4909	△ 402 081 9000	RESISTOR 10 J- 1/2W(US)
SCR41	411 021 6405	SCR S-TPG BIN 3X8
SCR42	411 021 6405	SCR S-TPG BIN 3X8
WR490	614 017 6964	TERMINAL BOARD(US)
or	614 017 8203	TERMINAL BOARD(XE)
WR491	614 017 6964	TERMINAL BOARD(US)
or	614 017 8203	TERMINAL BOARD(XE)

HP P.W.BOARD ASSY

REF.NO.	PART NO.	DESCRIPTION
76	614 313 0307	ASSY,PWB,HP(Only initial)(US)
76	△ 614 314 8913	ASSY,PWB,HP(Only initial)(XE)
CN620	645 009 0042	JACK,PHONE D6.43
CN621	645 005 9292	PLUG,5P
D6351	407 012 4406	DIODE 1SS133
IC635	409 460 9507	IC BH3544F
L6201	645 001 4550	INDUCTOR,10U K
or	645 031 7835	INDUCTOR,10U K
L6301	645 001 4550	INDUCTOR,10U K
or	645 031 7835	INDUCTOR,10U K
L6381	645 038 1478	INDUCTOR,1000 OHM
Q6351	△ 405 023 5009	TR 2SD400-E-MP
or	△ 405 023 5306	TR 2SD400-F-MP
or	△ 405 141 1402	TR KTD863-GR
Q6352	405 000 3608	TR DTC114YK(XE)
or	405 159 0503	TR KRC107S(XE)
R6201	401 105 4205	MT-GLAZE 33K JA 1/16W
R6203	401 105 0504	MT-GLAZE 1K JA 1/16W
R6205	401 105 0504	MT-GLAZE 1K JA 1/16W
R6206	401 105 7909	MT-GLAZE 0.000 ZA 1/16W(XE)

REF.NO.	PART NO.	DESCRIPTION
R6207	401 105 5301	MT-GLAZE 4.7K JA 1/16W(XE)
R6301	401 105 4205	MT-GLAZE 33K JA 1/16W
R6303	401 105 0504	MT-GLAZE 1K JA 1/16W
R6304	401 012 3308	CARBON 10 JA 1/4W
R6305	401 105 0504	MT-GLAZE 1K JA 1/16W
R6351	401 105 0603	MT-GLAZE 10K JA 1/16W
R6352	401 105 0504	MT-GLAZE 1K JA 1/16W
R6353	401 105 5400	MT-GLAZE 47K JA 1/16W
VR635	645 041 3247	VR,ROTARY 10KBX2

SOCKET P.W.BOARD ASSY

REF.NO.	PART NO.	DESCRIPTION
77	614 313 0338	ASSY,PWB,SOCKET(Only initial)(US)
77	△ 614 313 2851	ASSY,PWB,SOCKET(Only initial)(XE)
B6732	645 001 4550	INDUCTOR,10U K
or	645 031 7835	INDUCTOR,10U K
CN670	645 005 8158	PLUG,10P
CN671	645 005 8141	PLUG,9P
CN672	645 005 9292	PLUG,5P
CN673	645 005 8165	PLUG,11P(XE)
CN674	645 005 8165	PLUG,11P
CN681	645 041 1694	JACK,RCA-3(XE)
or	645 041 1298	JACK,RCA-6(US)
CN682	407 218 1100	PHOTO COUPLE GP1FA550TZ
or	407 215 1608	PHOTO COUPLE TOTX178A
CN683	645 041 3544	SOCKET,DIN 4P
CN684	645 041 3698	JACK,RCA-6
D6800	407 187 8001	ZENER DIODE UDZ10B
D6801	407 187 8001	ZENER DIODE UDZ10B
L6701	645 037 1608	INDUCTOR,2.2U J
L6702	645 037 1608	INDUCTOR,2.2U J
L6703	645 037 1608	INDUCTOR,2.2U J
L6704	645 037 1608	INDUCTOR,2.2U J(US)
L6705	645 037 1608	INDUCTOR,2.2U J(US)
L6706	645 037 1608	INDUCTOR,2.2U J(US)
L6731	645 038 1478	INDUCTOR,1000 OHM
L6732	645 038 1478	INDUCTOR,1000 OHM
L6733	645 038 1478	INDUCTOR,1000 OHM
L6734	645 038 1478	INDUCTOR,1000 OHM
Q6701	405 021 0204	TR 2SD1012-F-SPA
or	405 021 0600	TR 2SD1012-G-SPA
or	405 033 6706	TR 2SD1468S-R
or	405 033 6805	TR 2SD1468S-S
or	405 151 4400	TR KTD1303
Q6750	405 021 0204	TR 2SD1012-F-SPA
or	405 021 0600	TR 2SD1012-G-SPA
or	405 033 6706	TR 2SD1468S-R
or	405 033 6805	TR 2SD1468S-S
or	405 151 4400	TR KTD1303
Q6751	405 021 0204	TR 2SD1012-F-SPA
or	405 021 0600	TR 2SD1012-G-SPA
or	405 033 6706	TR 2SD1468S-R
or	405 033 6805	TR 2SD1468S-S
or	405 151 4400	TR KTD1303
Q6752	405 021 0204	TR 2SD1012-F-SPA
or	405 021 0600	TR 2SD1012-G-SPA
or	405 033 6706	TR 2SD1468S-R
or	405 033 6805	TR 2SD1468S-S
or	405 151 4400	TR KTD1303
Q6801	405 021 0204	TR 2SD1012-F-SPA
or	405 021 0600	TR 2SD1012-G-SPA
or	405 033 6706	TR 2SD1468S-R
or	405 033 6805	TR 2SD1468S-S
or	405 151 4400	TR KTD1303
Q6850	405 021 0204	TR 2SD1012-F-SPA
or	405 021 0600	TR 2SD1012-G-SPA
or	405 033 6706	TR 2SD1468S-R
or	405 033 6805	TR 2SD1468S-S

PARTS LIST

REF.NO.	PART NO.	DESCRIPTION	REF.NO.	PART NO.	DESCRIPTION
or	405 151 4400	TR KTD1303	D8401	407 209 4509	ZENER DIODE UDZS6.8B
Q6851	405 021 0204	TR 2SD1012-F-SPA	D8402	407 209 4509	ZENER DIODE UDZS6.8B
or	405 021 0600	TR 2SD1012-G-SPA	D8601	407 208 9703	ZENER DIODE UDZS5.6B
or	405 033 6706	TR 2SD1468S-R	D8602	407 209 4509	ZENER DIODE UDZS6.8B
or	405 033 6805	TR 2SD1468S-S	D8901	407 187 8209	ZENER DIODE UDZ12B
or	405 151 4400	TR KTD1303	IC801	409 482 6805	IC NDV8401-3AUW,MPEG&UCOM
Q6852	405 021 0204	TR 2SD1012-F-SPA	IC802	410 390 9802	IC ASSY, IC ASSY FLASH (IC LE28DW8102T-90-MPB,FLASH)
or	405 021 0600	TR 2SD1012-G-SPA	IC803	410 390 9901	IC ASSY, IC ASSY FLASH (IC LE28DW8102T-90-MPB,FLASH)
or	405 033 6706	TR 2SD1468S-R			
or	405 033 6805	TR 2SD1468S-S			
or	405 151 4400	TR KTD1303			
R6707	401 105 2805	MT-GLAZE 2.2K JA 1/16W			
R6708	401 105 0702	MT-GLAZE 100K JA 1/16W	IC804	409 434 3807	IC 74LCX373MTC
R6750	401 105 0504	MT-GLAZE 1K JA 1/16W	or	409 486 2506	IC TC74LCX373FT
R6751	401 105 0504	MT-GLAZE 1K JA 1/16W	IC805	409 434 3807	IC 74LCX373MTC
R6752	401 105 0504	MT-GLAZE 1K JA 1/16W	or	409 486 2506	IC TC74LCX373FT
R6755	401 105 2805	MT-GLAZE 2.2K JA 1/16W	IC806	409 482 0209	IC K4S161622D-TC80,SDRAM2MB
R6756	401 105 0702	MT-GLAZE 100K JA 1/16W	or	410 349 2601	IC KM416S1120DT-G8,SDRAM2MB
R6757	401 105 2805	MT-GLAZE 2.2K JA 1/16W	or	410 349 2502	IC EM636165TS-8,SDRAM2MB
R6758	401 105 0702	MT-GLAZE 100K JA 1/16W	IC807	409 482 0209	IC K4S161622D-TC80,SDRAM2MB
R6759	401 105 2805	MT-GLAZE 2.2K JA 1/16W	or	410 349 2601	IC KM416S1120DT-G8,SDRAM2MB
R6760	401 105 0702	MT-GLAZE 100K JA 1/16W	or	410 349 2502	IC EM636165TS-8,SDRAM2MB
R6761	401 105 5301	MT-GLAZE 4.7K JA 1/16W	IC811	409 486 3701	IC 74VHCU04MTC
R6762	401 105 0504	MT-GLAZE 1K JA 1/16W	or	409 363 2308	IC TC74VHCU04FT
R6763	401 105 7909	MT-GLAZE 0.000 ZA 1/16W(XE)	IC812	409 183 0102	IC M51953BFP
R6764	401 035 4108	MT-GLAZE 0.000 ZA 1/8W(XE)	IC813	409 432 8101	IC 74VHC157MTC
R6807	401 105 2805	MT-GLAZE 2.2K JA 1/16W	or	410 314 2902	IC TC74VHC157FT-EL
R6808	401 105 0702	MT-GLAZE 100K JA 1/16W	IC815	409 489 9700	IC NC7SZ157P6
R6850	401 105 0504	MT-GLAZE 1K JA 1/16W	IC816	410 377 4707	IC 74VHCT244AMTC-X
R6851	401 105 0504	MT-GLAZE 1K JA 1/16W	or	410 314 3404	IC TC74VHCT244AFT-EL
R6852	401 105 0504	MT-GLAZE 1K JA 1/16W	IC817	409 489 4903	IC 93LC76/SN,EEPROM(8i)
R6855	401 105 2805	MT-GLAZE 2.2K JA 1/16W	or	409 486 1905	IC S-29430AFE,EEPROM(8K)
R6856	401 105 0702	MT-GLAZE 100K JA 1/16W	IC818	410 380 5708	IC 74VHCT374AMTC-X
R6857	401 105 2805	MT-GLAZE 2.2K JA 1/16W	or	410 380 4404	IC TC74VHCT374AFT-EL
R6858	401 105 0702	MT-GLAZE 100K JA 1/16W	IC841	409 480 3806	IC PCM1720E,DAC_2CH
R6859	401 105 2805	MT-GLAZE 2.2K JA 1/16W	IC842	409 039 8603	IC NJM4560M
R6860	401 105 0702	MT-GLAZE 100K JA 1/16W	IC861	409 480 4209	IC PCM1600Y,DAC_2CH
R6862	401 105 0504	MT-GLAZE 1K JA 1/16W	IC862	409 039 8603	IC NJM4560M
S6701	645 040 6102	SWITCH,SLIDE 2P-2TX4(US)	IC863	409 039 8603	IC NJM4560M
S6702	645 040 6119	SWITCH,SLIDE 2P-2TX2(XE)	IC864	409 039 8603	IC NJM4560M

MPEG P.W.BOARD ASSY

REF.NO.	PART NO.	DESCRIPTION	REF.NO.	PART NO.	DESCRIPTION
78	614 313 0345	ASSY,PWB,F0RNET F01, MPEG(Only initial)	Q8011	405 146 5306	TR KRA102S
B8001	645 019 0988	INDUCTOR,1000 OHM	or	405 000 0409	TR DTA114EK
or	645 020 2001	INDUCTOR,1000 OHM	Q8012	405 146 1605	TR KRC102S
B8013	645 019 0988	INDUCTOR,1000 OHM	or	405 000 2908	TR DTC114EK
or	645 020 2001	INDUCTOR,1000 OHM	Q8101	405 146 1605	TR KRC102S
B8101	645 019 0988	INDUCTOR,1000 OHM	or	405 000 2908	TR DTC114EK
or	645 020 2001	INDUCTOR,1000 OHM	Q8401	405 064 9202	TR 2SD1757K-S
B8401	645 019 0988	INDUCTOR,1000 OHM	Q8601	405 146 1605	TR KRC102S
or	645 020 2001	INDUCTOR,1000 OHM	or	405 000 2908	TR DTC114EK
B8601	645 019 0988	INDUCTOR,1000 OHM	R8001	401 105 7909	MT-GLAZE 0.000 ZA 1/16W
or	645 020 2001	INDUCTOR,1000 OHM	R8002	401 105 7909	MT-GLAZE 0.000 ZA 1/16W
B8602	645 019 0988	INDUCTOR,1000 OHM	R8003	401 105 7909	MT-GLAZE 0.000 ZA 1/16W
or	645 020 2001	INDUCTOR,1000 OHM	R8004	401 105 7909	MT-GLAZE 0.000 ZA 1/16W
B8901	645 019 0988	INDUCTOR,1000 OHM	R8005	401 105 7909	MT-GLAZE 0.000 ZA 1/16W
or	645 020 2001	INDUCTOR,1000 OHM	R8006	401 105 7909	MT-GLAZE 0.000 ZA 1/16W
B8902	645 019 0988	INDUCTOR,1000 OHM	R8007	401 105 5202	MT-GLAZE 470 JA 1/16W
or	645 020 2001	INDUCTOR,1000 OHM	R8008	401 105 2706	MT-GLAZE 220 JA 1/16W
CN801	645 029 6406	PULG,12P	R8009	401 105 2706	MT-GLAZE 220 JA 1/16W
CN805	645 029 6383	PULG,10P	R8011	401 105 7909	MT-GLAZE 0.000 ZA 1/16W
CN806	645 029 6376	PULG,9P	R8020	401 105 0603	MT-GLAZE 10K JA 1/16W
CN809	645 042 5356	SOCKET,FPC 26P	R8026	401 105 0603	MT-GLAZE 10K JA 1/16W
CN810	645 042 5349	SOCKET,FPC 16P	R8027	401 105 0603	MT-GLAZE 10K JA 1/16W
CN818	645 041 0079	PLUG,13P	R8028	401 105 0504	MT-GLAZE 1K JA 1/16W
CN861	645 029 6390	PULG,11P	R8035	401 105 2607	MT-GLAZE 22 JA 1/16W
			R8036	401 105 2607	MT-GLAZE 22 JA 1/16W
			R8037	401 105 0603	MT-GLAZE 10K JA 1/16W
			R8038	401 105 2607	MT-GLAZE 22 JA 1/16W
			R8039	401 105 2607	MT-GLAZE 22 JA 1/16W

PARTS LIST

REF.NO.	PART NO.	DESCRIPTION	REF.NO.	PART NO.	DESCRIPTION
R8040	401 105 2607	MT-GLAZE 22 JA 1/16W	R8174	401 105 6001	MT-GLAZE 5.6K JA 1/16W
R8041	401 105 2607	MT-GLAZE 22 JA 1/16W	R8401	401 105 7909	MT-GLAZE 0.000 ZA 1/16W
R8042	401 105 2607	MT-GLAZE 22 JA 1/16W	R8402	401 105 0603	MT-GLAZE 10K JA 1/16W
R8043	401 105 2607	MT-GLAZE 22 JA 1/16W	R8403	401 105 0702	MT-GLAZE 100K JA 1/16W
R8044	401 105 2607	MT-GLAZE 22 JA 1/16W	R8404	401 105 0603	MT-GLAZE 10K JA 1/16W
R8045	401 105 1501	MT-GLAZE 1.5K JA 1/16W	R8405	401 105 0603	MT-GLAZE 10K JA 1/16W
R8046	401 105 2607	MT-GLAZE 22 JA 1/16W	R8406	401 105 0504	MT-GLAZE 1K JA 1/16W
R8047	401 105 2607	MT-GLAZE 22 JA 1/16W	R8407	401 105 0603	MT-GLAZE 10K JA 1/16W
R8051	401 113 4402	MT-GLAZE 75 JA 1/16W	R8408	401 113 6703	MT-GLAZE 9.1K JA 1/16W
R8052	401 113 4402	MT-GLAZE 75 JA 1/16W	R8409	401 105 5202	MT-GLAZE 470 JA 1/16W
R8053	401 113 4402	MT-GLAZE 75 JA 1/16W	R8410	401 105 0702	MT-GLAZE 100K JA 1/16W
R8054	401 105 0801	MT-GLAZE 12 JA 1/16W	R8411	401 105 0504	MT-GLAZE 1K JA 1/16W
R8055	401 113 5805	MT-GLAZE 1.1K JA 1/16W	R8420	401 105 0504	MT-GLAZE 1K JA 1/16W
R8056	401 105 0603	MT-GLAZE 10K JA 1/16W	R8421	401 105 0504	MT-GLAZE 1K JA 1/16W
R8071	401 105 0603	MT-GLAZE 10K JA 1/16W	R8422	401 105 0306	MT-GLAZE 10 JA 1/16W
R8072	401 105 0603	MT-GLAZE 10K JA 1/16W	R8423	401 105 7909	MT-GLAZE 0.000 ZA 1/16W
R8073	401 105 0603	MT-GLAZE 10K JA 1/16W	R8424	401 105 7909	MT-GLAZE 0.000 ZA 1/16W
R8074	401 105 0603	MT-GLAZE 10K JA 1/16W	R8425	401 105 7909	MT-GLAZE 0.000 ZA 1/16W
R8075	401 105 0603	MT-GLAZE 10K JA 1/16W	R8426	401 105 7909	MT-GLAZE 0.000 ZA 1/16W
R8076	401 105 0603	MT-GLAZE 10K JA 1/16W	R8427	401 113 4907	MT-GLAZE 200 JA 1/16W
R8077	401 105 0603	MT-GLAZE 10K JA 1/16W	R8429	401 105 0504	MT-GLAZE 1K JA 1/16W
R8078	401 105 0603	MT-GLAZE 10K JA 1/16W	R8430	401 105 0504	MT-GLAZE 1K JA 1/16W
R8101	401 105 8005	MT-GLAZE 1M JA 1/16W	R8501	401 105 7909	MT-GLAZE 0.000 ZA 1/16W
R8102	401 105 1006	MT-GLAZE 1.2K JA 1/16W	R8502	401 105 0603	MT-GLAZE 10K JA 1/16W
R8103	401 105 8005	MT-GLAZE 1M JA 1/16W	R8503	401 105 0702	MT-GLAZE 100K JA 1/16W
R8104	401 105 1006	MT-GLAZE 1.2K JA 1/16W	R8504	401 105 0603	MT-GLAZE 10K JA 1/16W
R8105	401 105 0405	MT-GLAZE 100 JA 1/16W	R8505	401 105 0603	MT-GLAZE 10K JA 1/16W
R8106	401 105 2706	MT-GLAZE 220 JA 1/16W	R8506	401 105 0504	MT-GLAZE 1K JA 1/16W
R8107	401 105 0405	MT-GLAZE 100 JA 1/16W	R8507	401 105 0603	MT-GLAZE 10K JA 1/16W
R8108	401 105 2706	MT-GLAZE 220 JA 1/16W	R8508	401 113 6703	MT-GLAZE 9.1K JA 1/16W
R8109	401 105 0603	MT-GLAZE 10K JA 1/16W	R8509	401 105 5202	MT-GLAZE 470 JA 1/16W
R8111	401 105 7909	MT-GLAZE 0.000 ZA 1/16W	R8510	401 105 0702	MT-GLAZE 100K JA 1/16W
R8112	401 105 7909	MT-GLAZE 0.000 ZA 1/16W	R8511	401 105 0504	MT-GLAZE 1K JA 1/16W
R8113	401 105 7909	MT-GLAZE 0.000 ZA 1/16W	R8601	401 105 0603	MT-GLAZE 10K JA 1/16W
R8114	401 105 7909	MT-GLAZE 0.000 ZA 1/16W	R8602	401 105 0702	MT-GLAZE 100K JA 1/16W
R8121	401 105 7909	MT-GLAZE 0.000 ZA 1/16W	R8603	401 105 0603	MT-GLAZE 10K JA 1/16W
R8122	401 105 7909	MT-GLAZE 0.000 ZA 1/16W	R8604	401 105 0603	MT-GLAZE 10K JA 1/16W
R8123	401 105 7909	MT-GLAZE 0.000 ZA 1/16W	R8605	401 105 0504	MT-GLAZE 1K JA 1/16W
R8124	401 105 7909	MT-GLAZE 0.000 ZA 1/16W	R8606	401 105 0603	MT-GLAZE 10K JA 1/16W
R8126	401 105 7909	MT-GLAZE 0.000 ZA 1/16W	R8607	401 113 6703	MT-GLAZE 9.1K JA 1/16W
R8131	401 105 7909	MT-GLAZE 0.000 ZA 1/16W	R8608	401 105 5202	MT-GLAZE 470 JA 1/16W
R8132	401 105 7909	MT-GLAZE 0.000 ZA 1/16W	R8609	401 105 0702	MT-GLAZE 100K JA 1/16W
R8133	401 105 7909	MT-GLAZE 0.000 ZA 1/16W	R8610	401 105 0504	MT-GLAZE 1K JA 1/16W
R8134	401 105 7909	MT-GLAZE 0.000 ZA 1/16W	R8611	401 105 0603	MT-GLAZE 10K JA 1/16W
R8135	401 105 7909	MT-GLAZE 0.000 ZA 1/16W	R8612	401 105 0702	MT-GLAZE 100K JA 1/16W
R8136	401 105 7909	MT-GLAZE 0.000 ZA 1/16W	R8613	401 105 0603	MT-GLAZE 10K JA 1/16W
R8137	401 105 7909	MT-GLAZE 0.000 ZA 1/16W	R8614	401 105 0603	MT-GLAZE 10K JA 1/16W
R8138	401 105 7909	MT-GLAZE 0.000 ZA 1/16W	R8615	401 105 0504	MT-GLAZE 1K JA 1/16W
R8141	401 105 7909	MT-GLAZE 0.000 ZA 1/16W	R8616	401 105 0603	MT-GLAZE 10K JA 1/16W
R8142	401 105 7909	MT-GLAZE 0.000 ZA 1/16W	R8617	401 113 6703	MT-GLAZE 9.1K JA 1/16W
R8143	401 105 7909	MT-GLAZE 0.000 ZA 1/16W	R8618	401 105 5202	MT-GLAZE 470 JA 1/16W
R8144	401 105 7909	MT-GLAZE 0.000 ZA 1/16W	R8619	401 105 0702	MT-GLAZE 100K JA 1/16W
R8151	401 105 7909	MT-GLAZE 0.000 ZA 1/16W	R8620	401 105 0504	MT-GLAZE 1K JA 1/16W
R8152	401 105 7909	MT-GLAZE 0.000 ZA 1/16W	R8621	401 105 0603	MT-GLAZE 10K JA 1/16W
R8153	401 105 7909	MT-GLAZE 0.000 ZA 1/16W	R8622	401 105 0702	MT-GLAZE 100K JA 1/16W
R8154	401 105 7909	MT-GLAZE 0.000 ZA 1/16W	R8623	401 105 0603	MT-GLAZE 10K JA 1/16W
R8155	401 105 7909	MT-GLAZE 0.000 ZA 1/16W	R8624	401 105 0603	MT-GLAZE 10K JA 1/16W
R8156	401 105 7909	MT-GLAZE 0.000 ZA 1/16W	R8625	401 105 0504	MT-GLAZE 1K JA 1/16W
R8157	401 105 7909	MT-GLAZE 0.000 ZA 1/16W	R8626	401 105 0603	MT-GLAZE 10K JA 1/16W
R8158	401 105 7909	MT-GLAZE 0.000 ZA 1/16W	R8627	401 113 6703	MT-GLAZE 9.1K JA 1/16W
R8159	401 105 7909	MT-GLAZE 0.000 ZA 1/16W	R8628	401 105 5202	MT-GLAZE 470 JA 1/16W
R8161	401 105 7909	MT-GLAZE 0.000 ZA 1/16W	R8629	401 105 0702	MT-GLAZE 100K JA 1/16W
R8162	401 105 7909	MT-GLAZE 0.000 ZA 1/16W	R8630	401 105 0504	MT-GLAZE 1K JA 1/16W
R8163	401 105 2706	MT-GLAZE 220 JA 1/16W	R8641	401 105 7909	MT-GLAZE 0.000 ZA 1/16W
R8164	401 105 7909	MT-GLAZE 0.000 ZA 1/16W	R8644	401 105 7909	MT-GLAZE 0.000 ZA 1/16W
R8171	401 105 1501	MT-GLAZE 1.5K JA 1/16W	R8645	401 105 7909	MT-GLAZE 0.000 ZA 1/16W
R8172	401 105 1501	MT-GLAZE 1.5K JA 1/16W	R8646	401 105 7909	MT-GLAZE 0.000 ZA 1/16W
R8173	401 105 0603	MT-GLAZE 10K JA 1/16W	R8647	401 105 7909	MT-GLAZE 0.000 ZA 1/16W

PARTS LIST

REF.NO.	PART NO.	DESCRIPTION
R8648	401 105 7909	MT-GLAZE 0.000 ZA 1/16W
R8649	401 105 7909	MT-GLAZE 0.000 ZA 1/16W
R8650	401 105 7909	MT-GLAZE 0.000 ZA 1/16W
R8651	401 105 7909	MT-GLAZE 0.000 ZA 1/16W
R8652	401 105 7909	MT-GLAZE 0.000 ZA 1/16W
R8653	401 105 7909	MT-GLAZE 0.000 ZA 1/16W
R8654	401 105 7909	MT-GLAZE 0.000 ZA 1/16W
R8655	401 105 7909	MT-GLAZE 0.000 ZA 1/16W
R8656	401 105 7909	MT-GLAZE 0.000 ZA 1/16W
R8701	401 105 0603	MT-GLAZE 10K JA 1/16W
R8702	401 105 0702	MT-GLAZE 100K JA 1/16W
R8703	401 105 0603	MT-GLAZE 10K JA 1/16W
R8704	401 105 0603	MT-GLAZE 10K JA 1/16W
R8705	401 105 0504	MT-GLAZE 1K JA 1/16W
R8706	401 105 0603	MT-GLAZE 10K JA 1/16W
R8707	401 113 6703	MT-GLAZE 9.1K JA 1/16W
R8708	401 105 5202	MT-GLAZE 470 JA 1/16W
R8709	401 105 0702	MT-GLAZE 100K JA 1/16W
R8710	401 105 0504	MT-GLAZE 1K JA 1/16W
R8711	401 105 0603	MT-GLAZE 10K JA 1/16W
R8712	401 105 0702	MT-GLAZE 100K JA 1/16W
R8713	401 105 0603	MT-GLAZE 10K JA 1/16W
R8714	401 105 0603	MT-GLAZE 10K JA 1/16W
R8715	401 105 0504	MT-GLAZE 1K JA 1/16W
R8716	401 105 0603	MT-GLAZE 10K JA 1/16W
R8717	401 113 6703	MT-GLAZE 9.1K JA 1/16W
R8718	401 105 5202	MT-GLAZE 470 JA 1/16W
R8719	401 105 0702	MT-GLAZE 100K JA 1/16W
R8720	401 105 0504	MT-GLAZE 1K JA 1/16W
R8721	401 105 0603	MT-GLAZE 10K JA 1/16W
R8722	401 105 0702	MT-GLAZE 100K JA 1/16W
R8723	401 105 0603	MT-GLAZE 10K JA 1/16W
R8724	401 105 0603	MT-GLAZE 10K JA 1/16W
R8725	401 105 0504	MT-GLAZE 1K JA 1/16W
R8726	401 105 0603	MT-GLAZE 10K JA 1/16W
R8727	401 113 6703	MT-GLAZE 9.1K JA 1/16W
R8728	401 105 5202	MT-GLAZE 470 JA 1/16W
R8729	401 105 0702	MT-GLAZE 100K JA 1/16W
R8730	401 105 0504	MT-GLAZE 1K JA 1/16W
R8821	401 105 7909	MT-GLAZE 0.000 ZA 1/16W
R8822	401 105 7909	MT-GLAZE 0.000 ZA 1/16W
R8823	401 105 7909	MT-GLAZE 0.000 ZA 1/16W
R8824	401 105 7909	MT-GLAZE 0.000 ZA 1/16W
R8825	401 105 7909	MT-GLAZE 0.000 ZA 1/16W
R8826	401 105 7909	MT-GLAZE 0.000 ZA 1/16W
R8827	401 105 7909	MT-GLAZE 0.000 ZA 1/16W
R8828	401 105 7909	MT-GLAZE 0.000 ZA 1/16W
R8829	401 105 7909	MT-GLAZE 0.000 ZA 1/16W
R8831	401 105 7909	MT-GLAZE 0.000 ZA 1/16W
R8841	401 105 7909	MT-GLAZE 0.000 ZA 1/16W
R8842	401 105 7909	MT-GLAZE 0.000 ZA 1/16W
R8843	401 105 7909	MT-GLAZE 0.000 ZA 1/16W
R8901	401 105 6605	MT-GLAZE 6.8K JA 1/16W
R8902	401 105 6605	MT-GLAZE 6.8K JA 1/16W
X8001	645 042 7763	OSC,CRYSTAL 33.000MHZ
X8002	645 042 2157	OSC,CRYSTAL 27.000MHZ

SCART P.W.BOARD ASSY

REF.NO.	PART NO.	DESCRIPTION
79	△ 614 313 2868	ASSY,PWB,SCART(XE)(Only initial)
B6601	645 034 7887	INDUCTOR,1000 OHM
CN660	645 005 8165	PLUG,11P
CN661	645 021 1508	SOCKET,RGB 21P
D6601	407 218 9205	ZENER DIODE KDZ15V
or	407 179 1003	ZENER DIODE UDZ15B
D6602	407 218 9205	ZENER DIODE KDZ15V
or	407 179 1003	ZENER DIODE UDZ15B
D6603	407 218 9205	ZENER DIODE KDZ15V
or	407 179 1003	ZENER DIODE UDZ15B
D6604	407 218 9205	ZENER DIODE KDZ15V
or	407 179 1003	ZENER DIODE UDZ15B
D6605	407 218 9205	ZENER DIODE KDZ15V
or	407 179 1003	ZENER DIODE UDZ15B
D6606	407 218 9205	ZENER DIODE KDZ15V
or	407 179 1003	ZENER DIODE UDZ15B
R6601	401 105 0504	MT-GLAZE 1K JA 1/16W
R6602	401 105 0504	MT-GLAZE 1K JA 1/16W
SH660	614 313 4220	SHIELD

WIRING CONNECTION

This is a basic wiring connection.

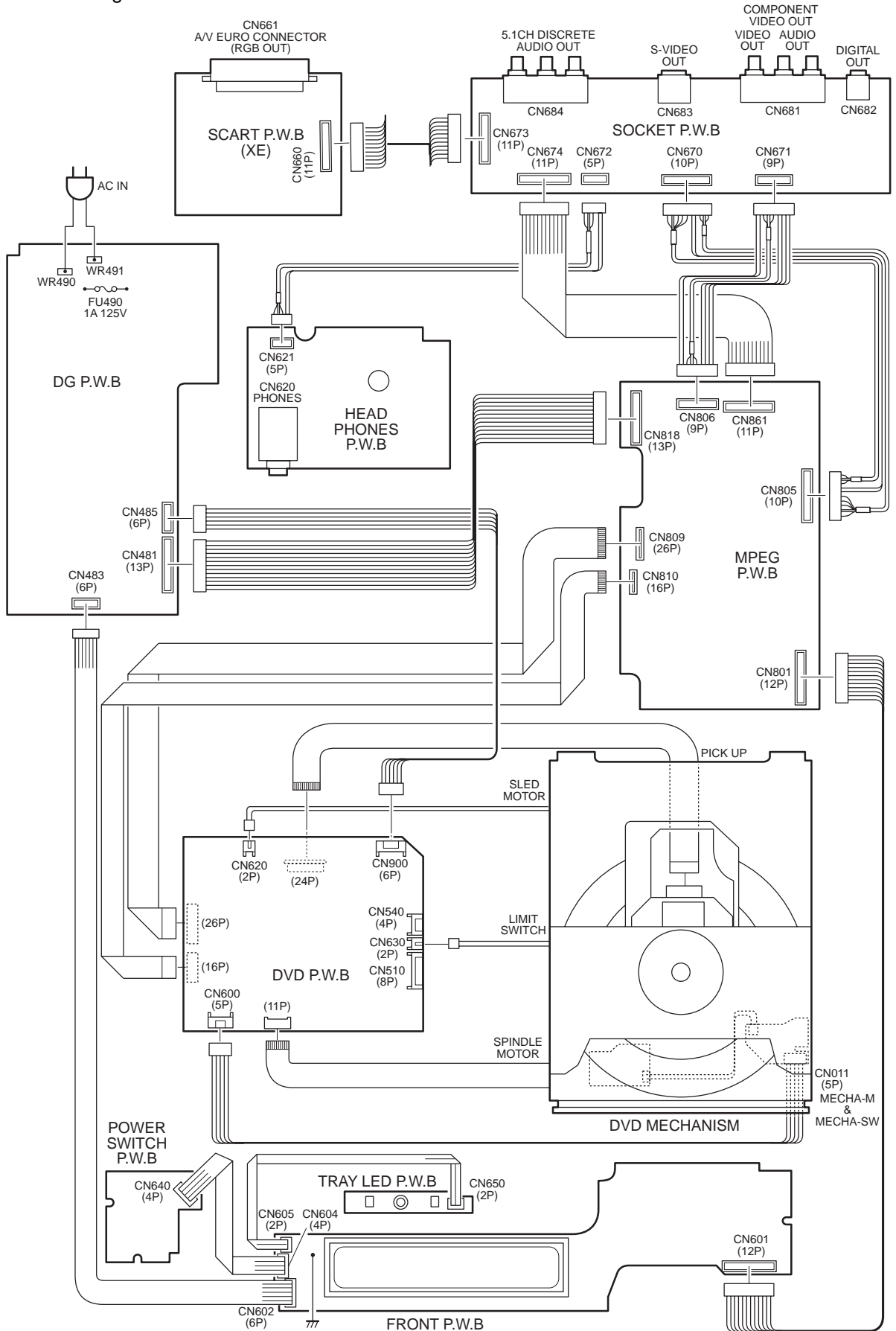

SCHEMATIC DIAGRAM (DVD LE type)

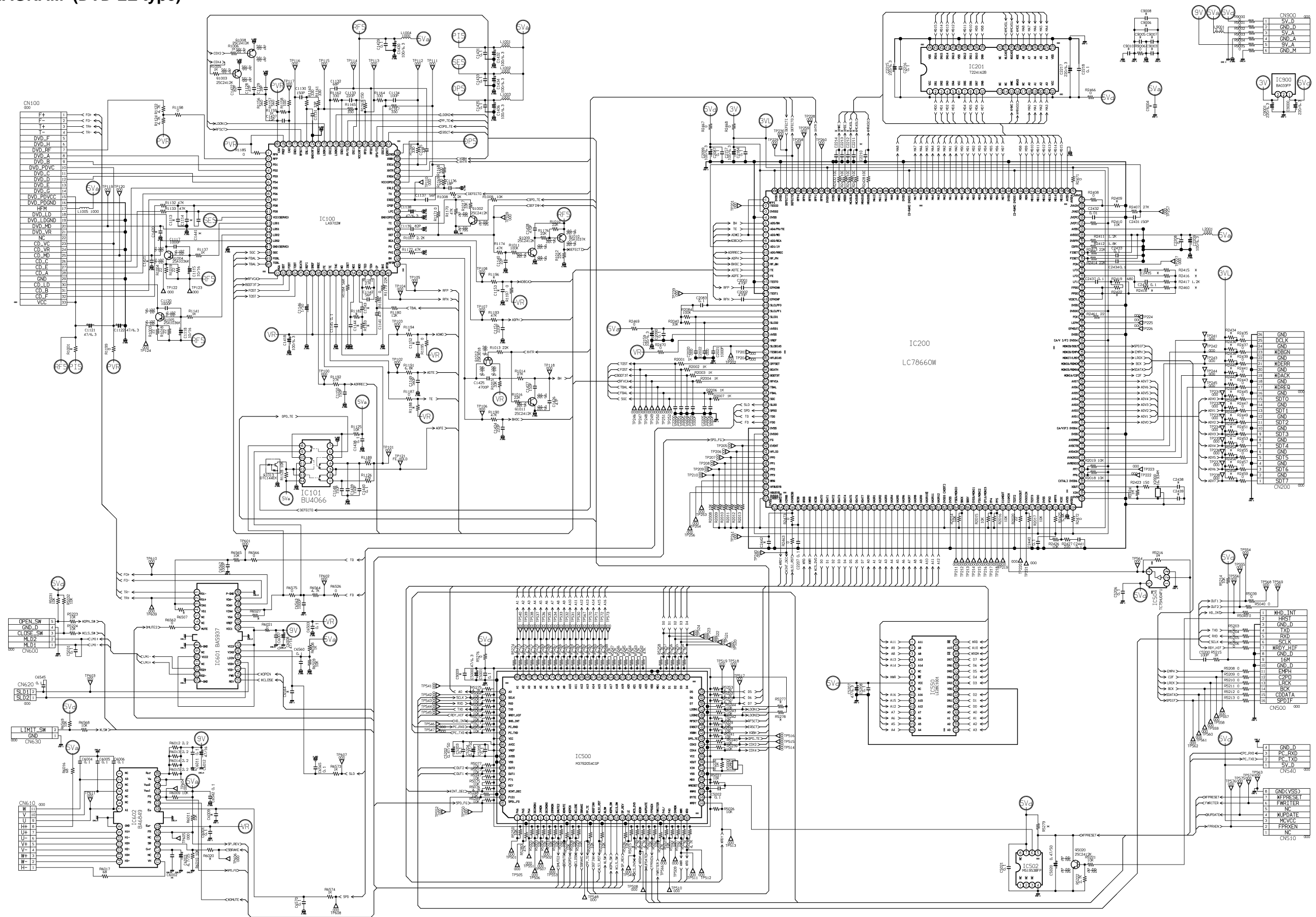

This is a basic schematic diagram.

SCHEMATIC DIAGRAM (MPEG)

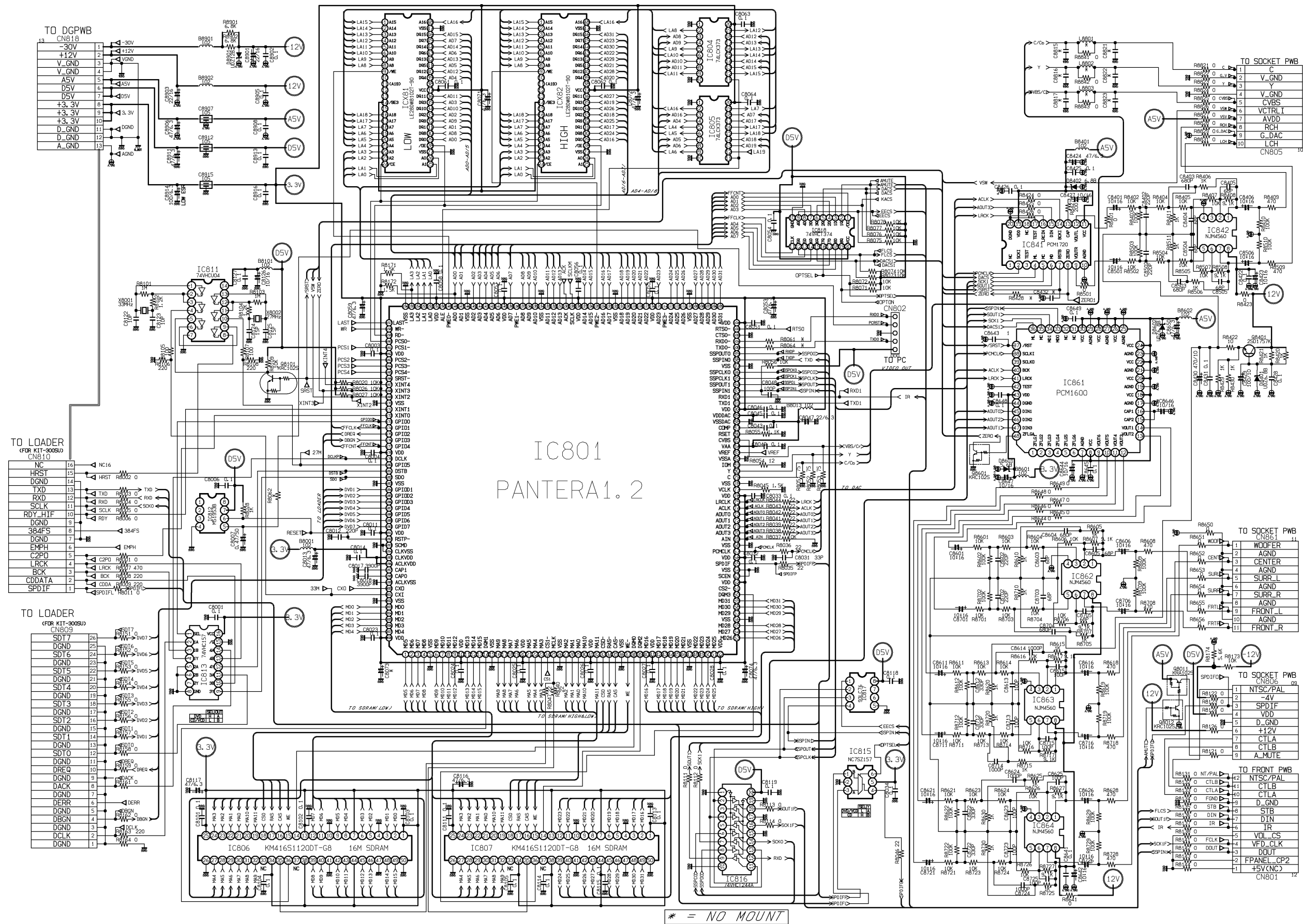

SCHEMATIC DIAGRAM (MAIN for US)

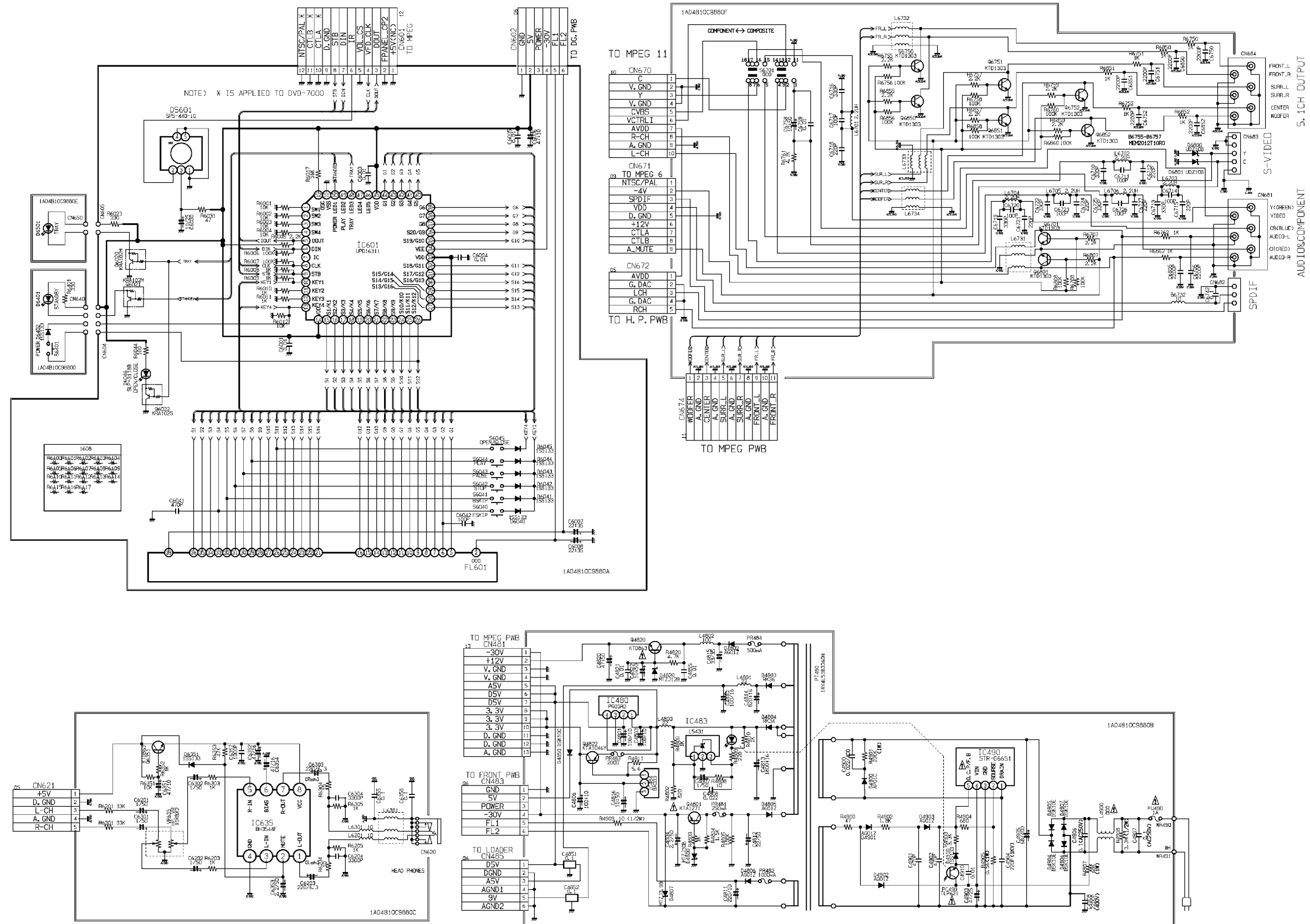

This is a basic schematic diagram.

PRODUCT SAFETY NOTICE

Each precaution in this manual should be followed during servicing. Components identified with the IEC symbol Δ in the parts list and the schematic diagram designated components in which safety can be of special significance. When replacing a component identified by Δ , use only the replacement parts designated, or parts with the same ratings of resistance, wattage or voltage that are designated in the parts list in this manual. Leakage-current or resistance measurements must be made to determine that exposed parts are acceptably insulated from the supply circuit before returning the product to the customer.

SCHEMATIC DIAGRAM (MAIN for XE)

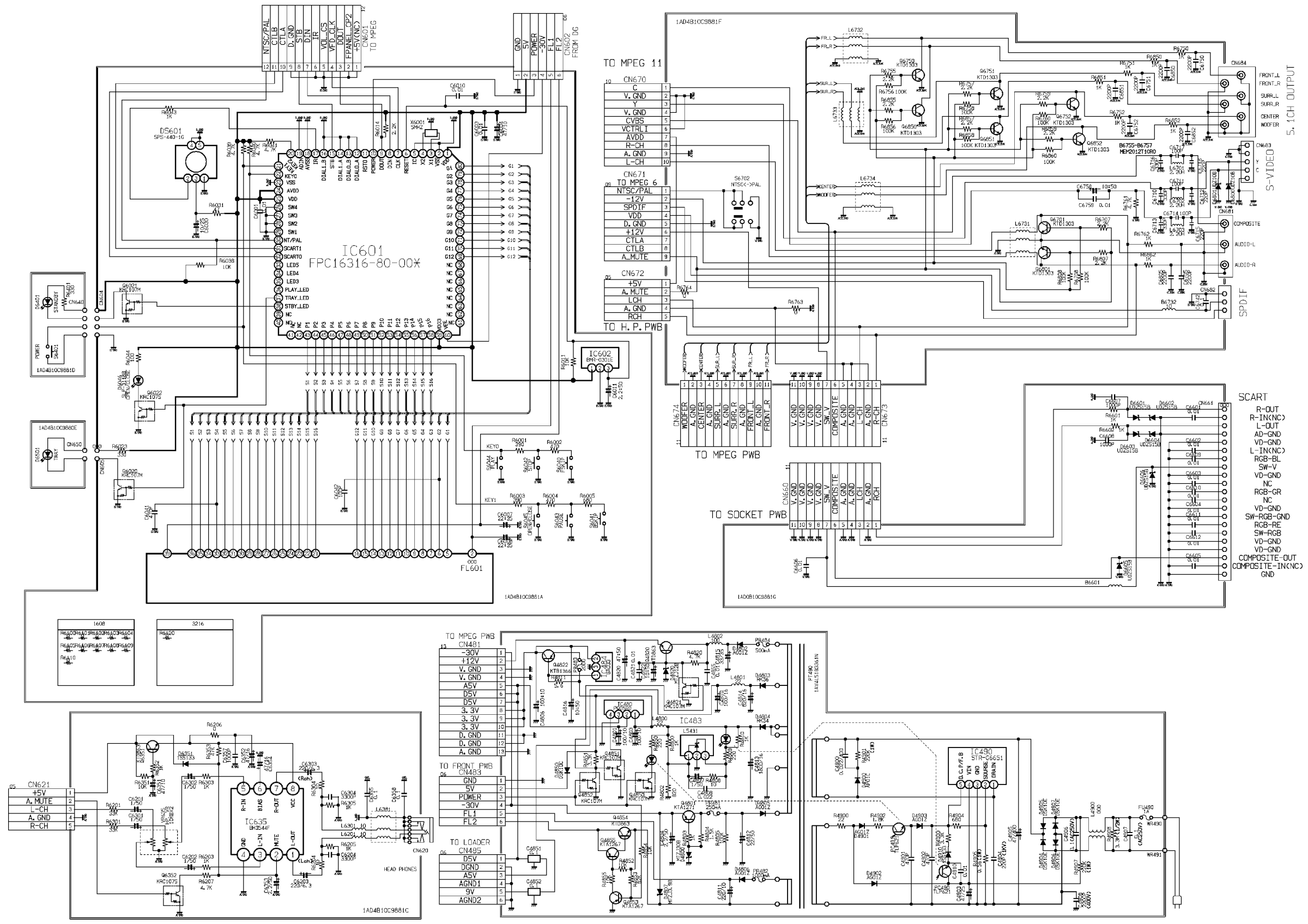

PRODUCT SAFETY NOTICE

Each precaution in this manual should be followed during servicing. Components identified with the IEC symbol Δ in the parts list and the schematic diagram designated components in which safety can be of special significance. When replacing a component identified by Δ , use only the replacement parts designated, or parts with the same ratings of resistance, wattage or voltage that are designated in the parts list in this manual. Leakage-current or resistance measurements must be made to determine that exposed parts are acceptably insulated from the supply circuit before returning the product to the customer.

WIRING DIAGRAM (DVD A SIDE for E type)

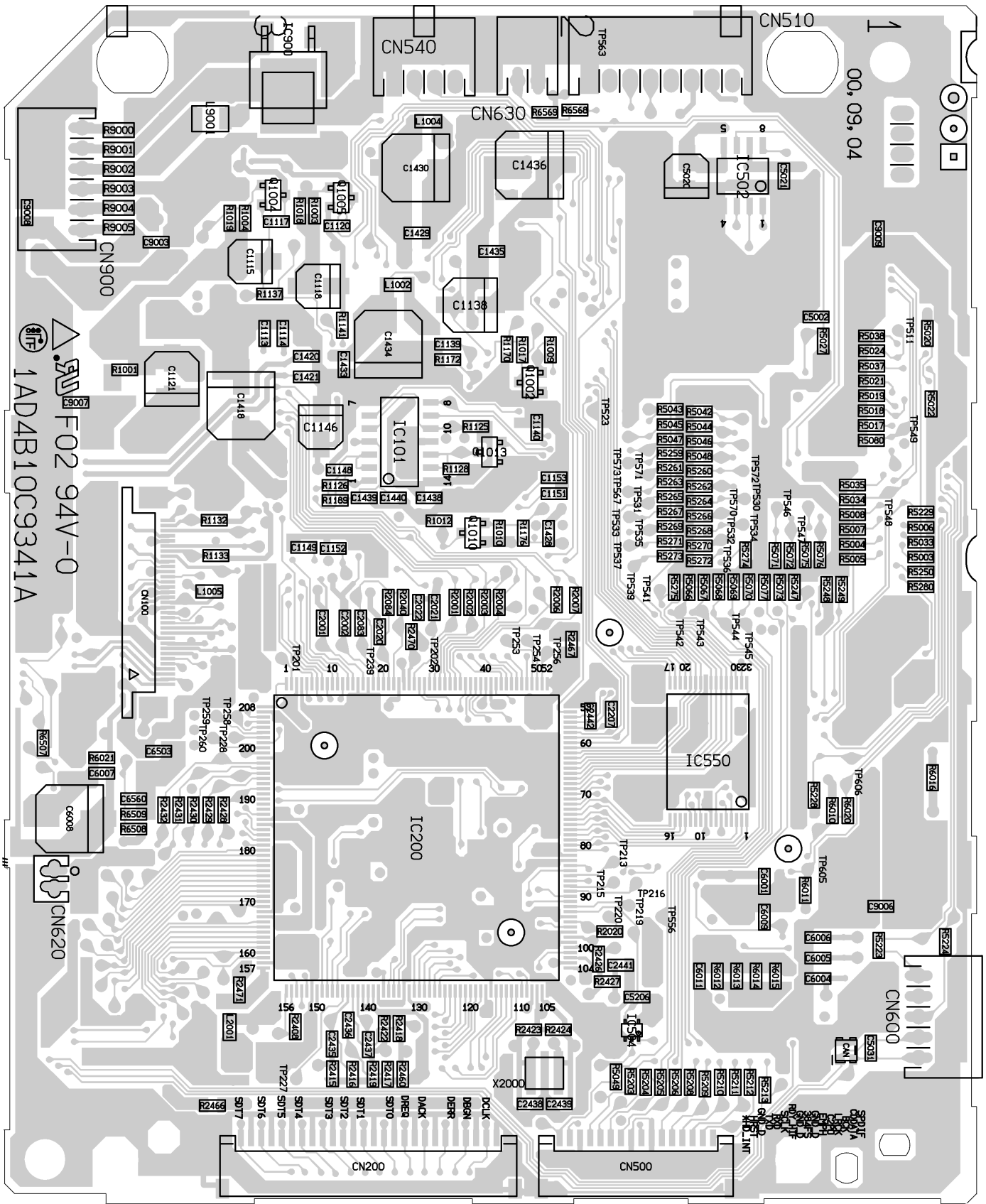

WIRING DIAGRAM (DVD B SIDE for E type)

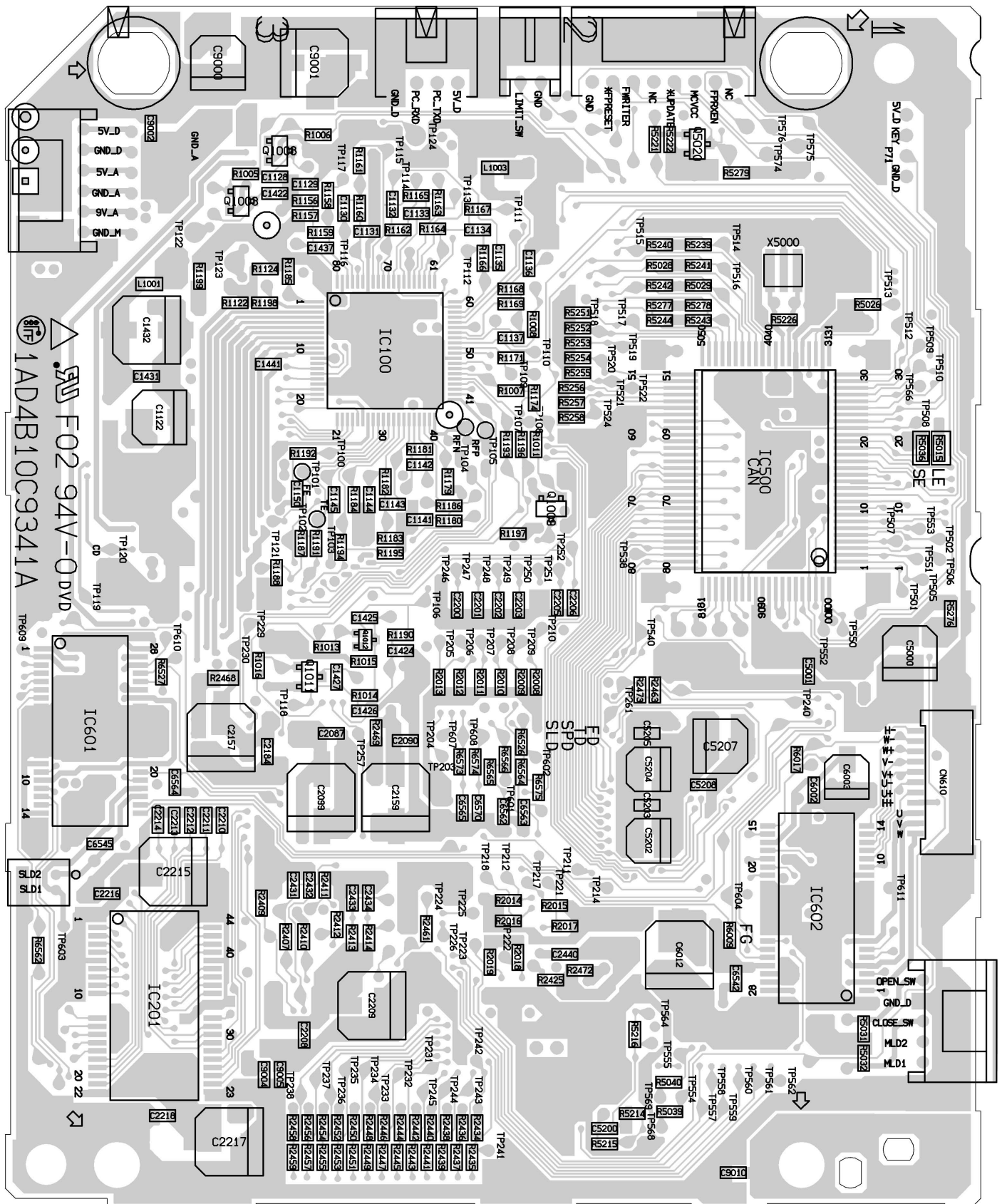

WIRING DIAGRAM (MPEG A SIDE)

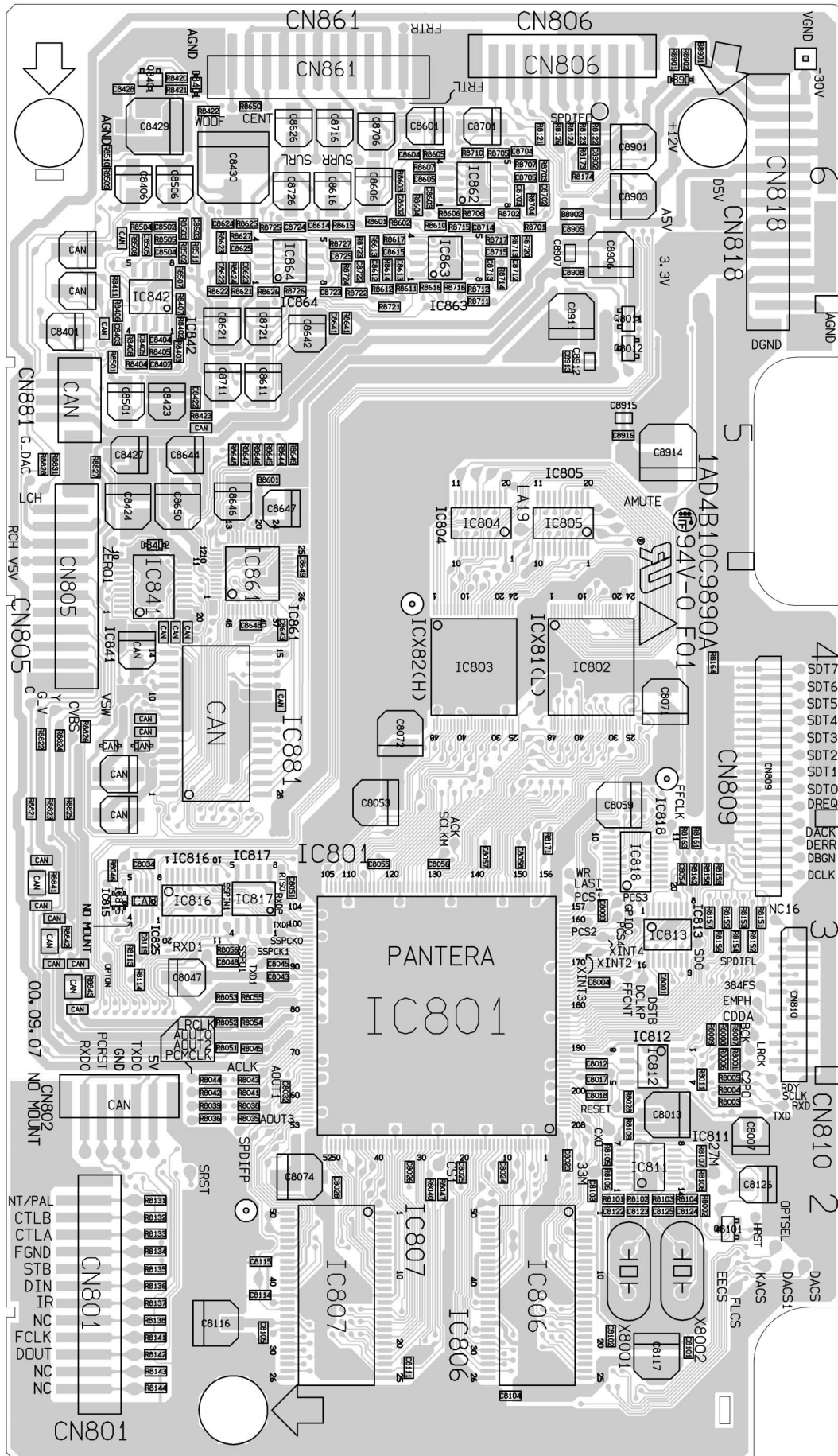

WIRING DIAGRAM (FRONT)

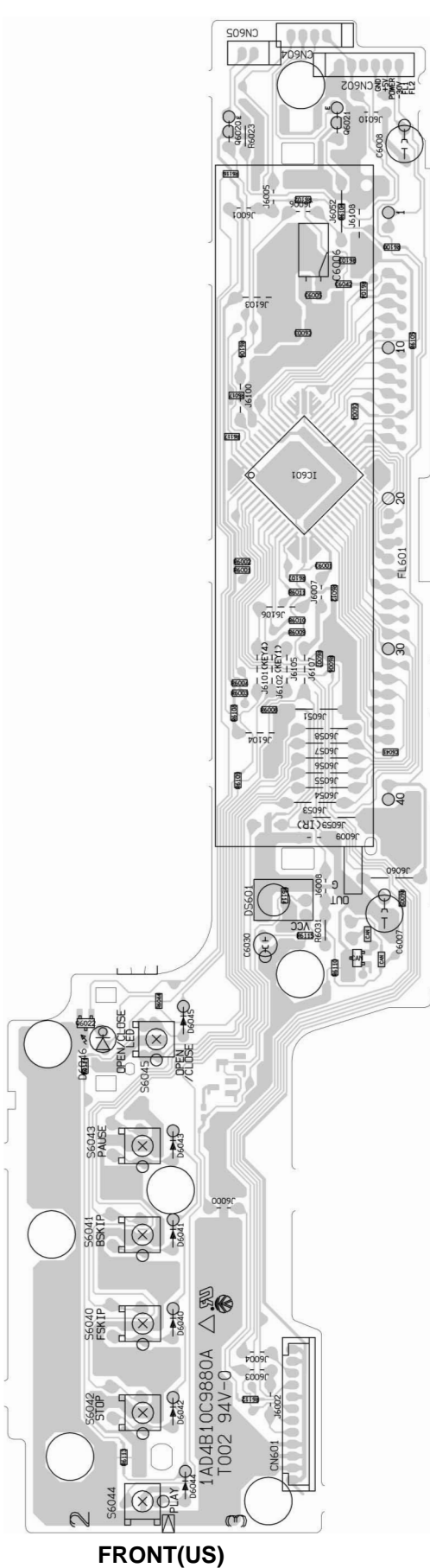

FRONT(US)

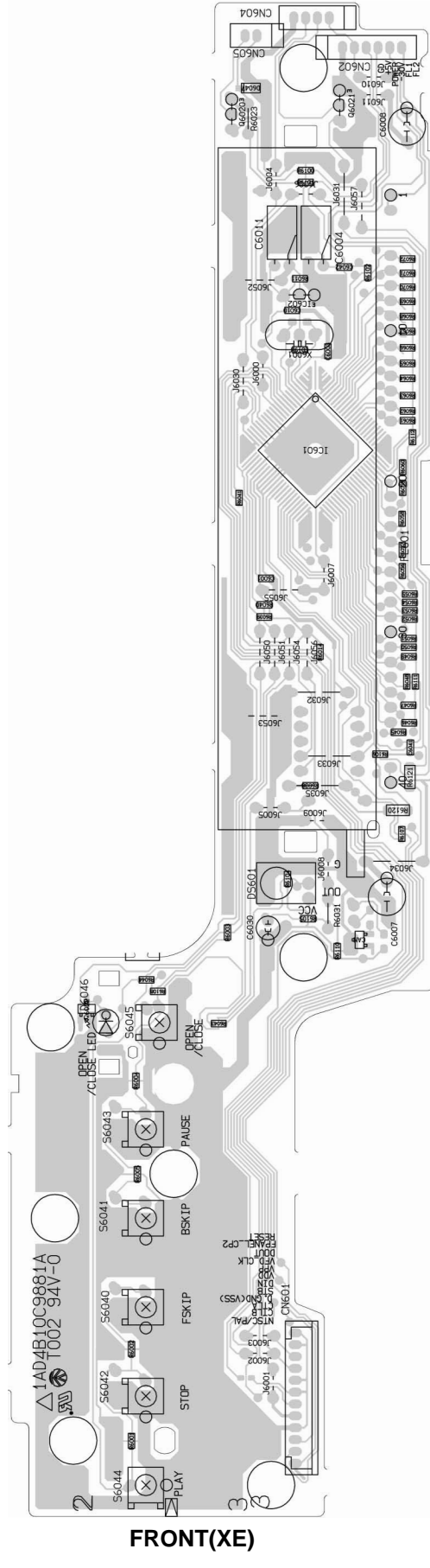

FRONT(XE)

WIRING DIAGRAM (POWER SW,HEADPHONE)

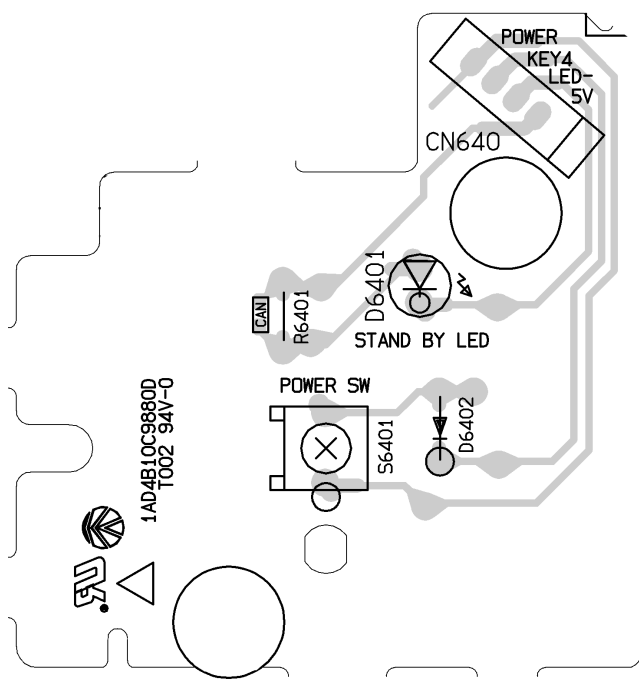

POWE SW(US)

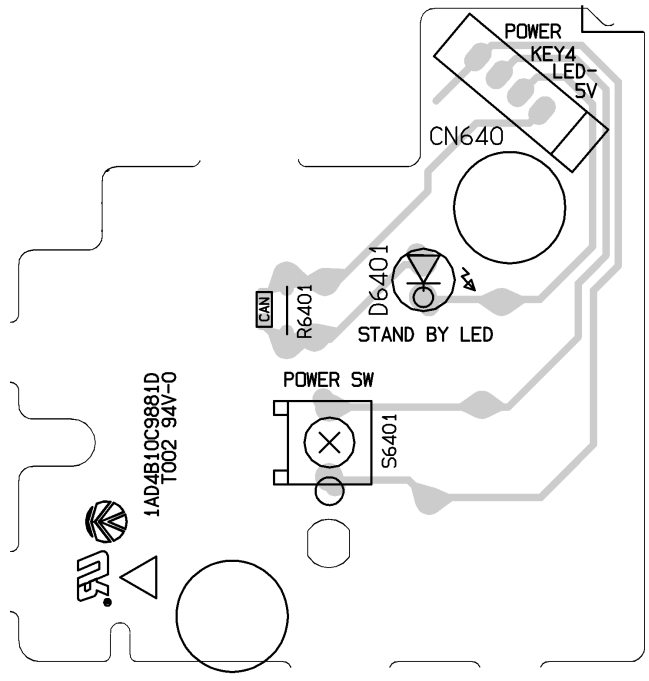

POWE SW(XE)

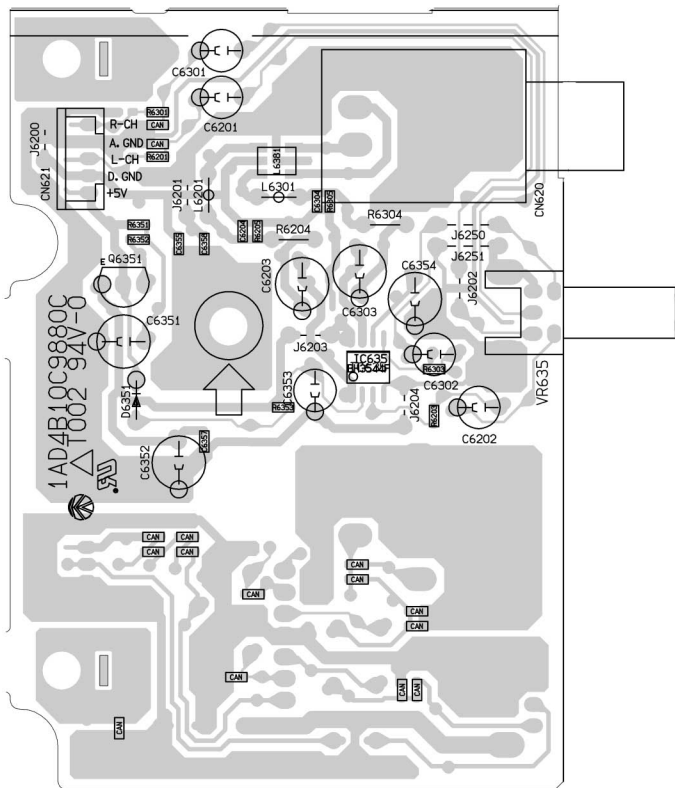

HEADPHONE(UIS)

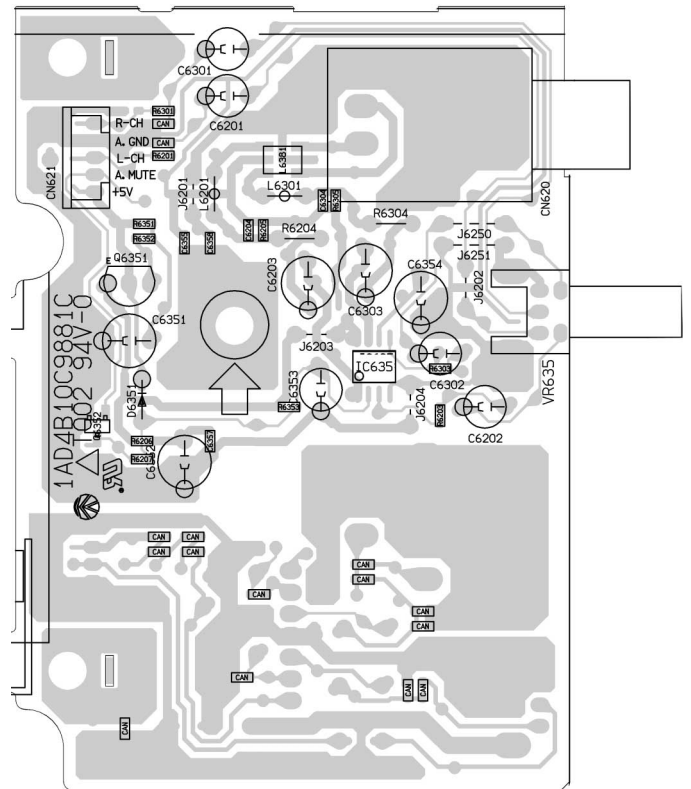

HEADPHONE(XE)