



SERVICE MANUAL  
**XPM-600**  
**XPM-900**  
**XPM-1200**  
**Power Amplifiers**

**CONTENT'S:**

**Connections & Operations:.....Page 2-5**

**Specifications:.....Page 6**

**Parts Lists:.....Page 8-20**

**PCBs:.....Page 21-22**

**Schematics:.....Page 23**



Gemini Sound Products Corp.  
120 Clover Place P.O. Box 6928  
Edison, NJ 08818-6928  
732-738-9003 (Phone) • 732-738-9006 (Fax)

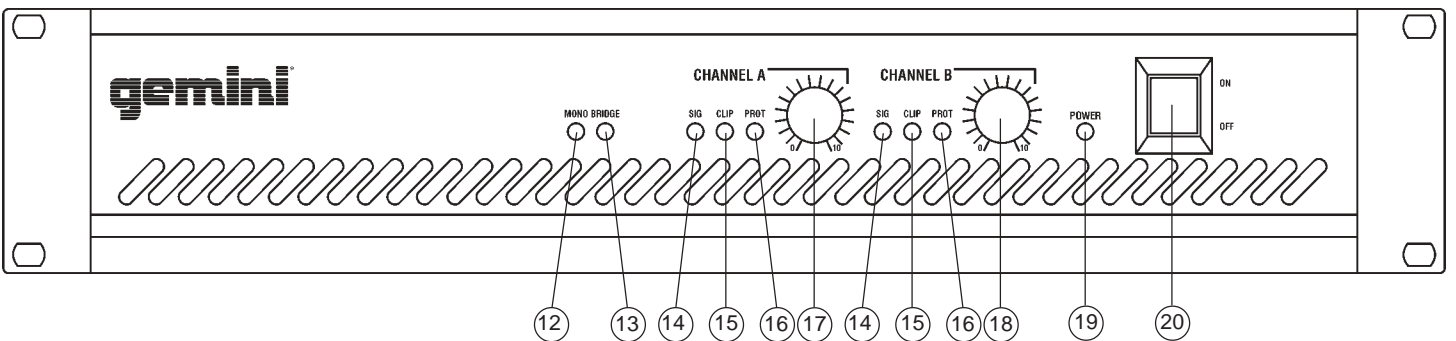
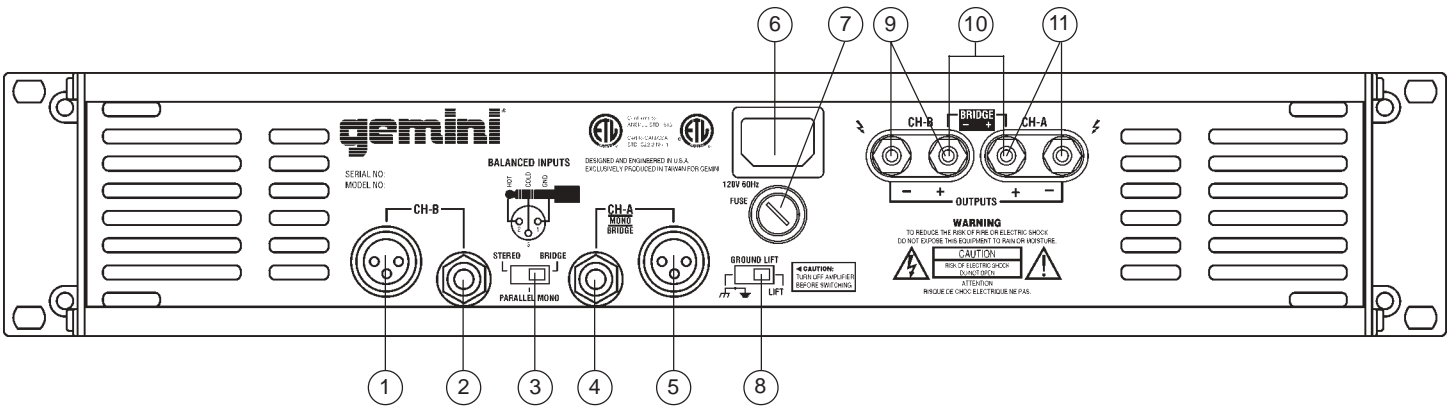
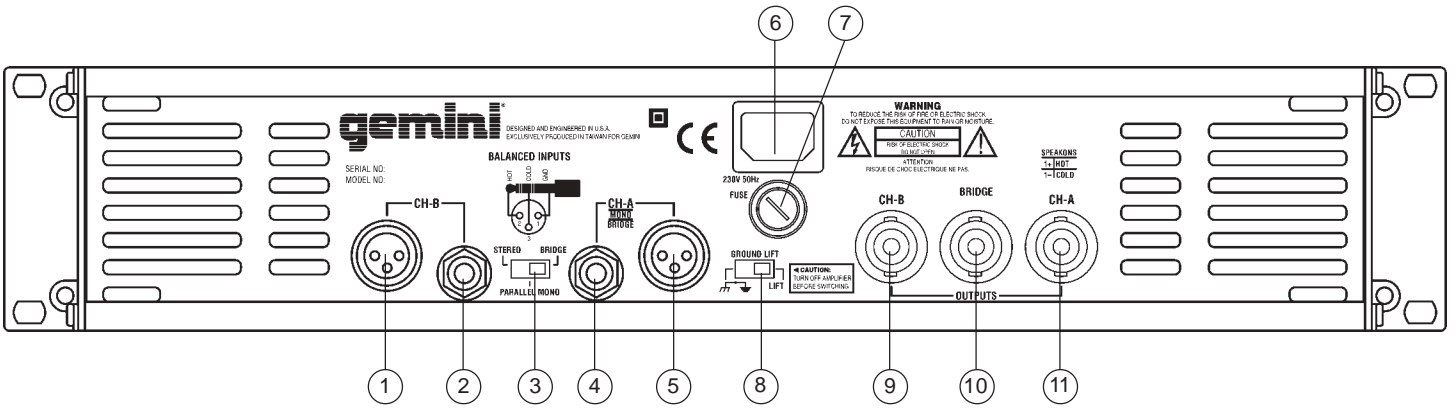

# Stereo

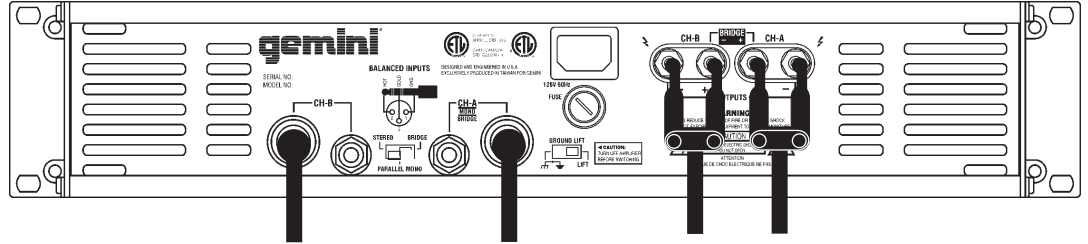
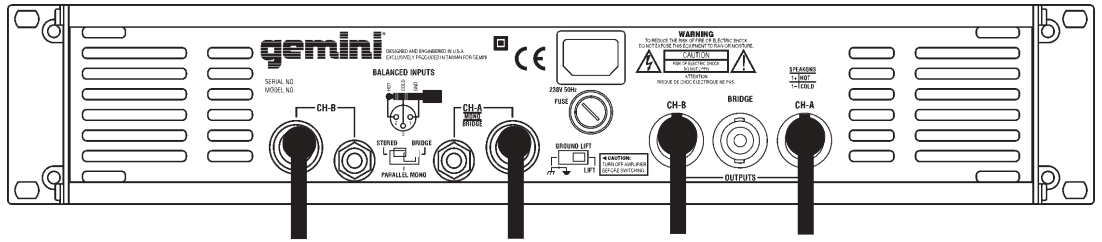

# Parallel Mono

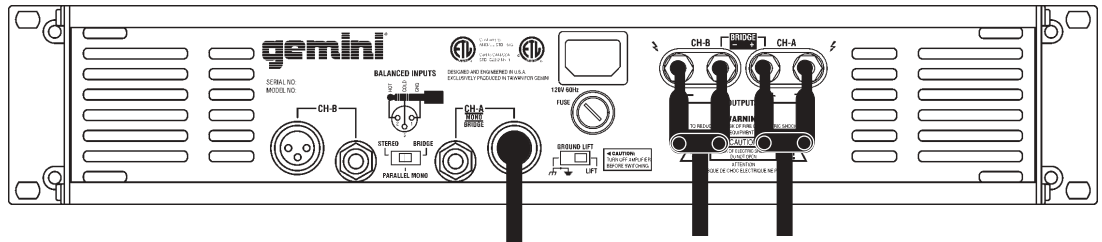
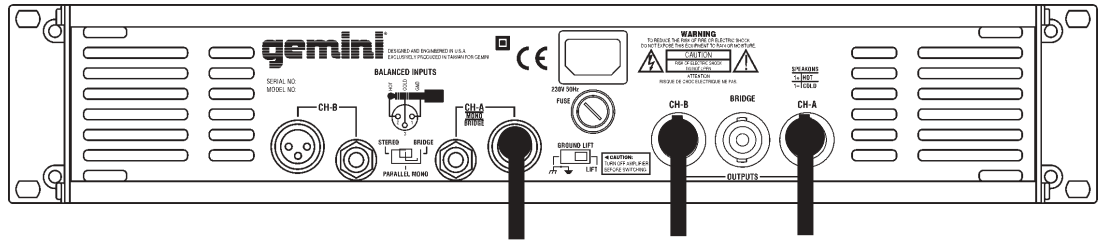

# Mono Bridge

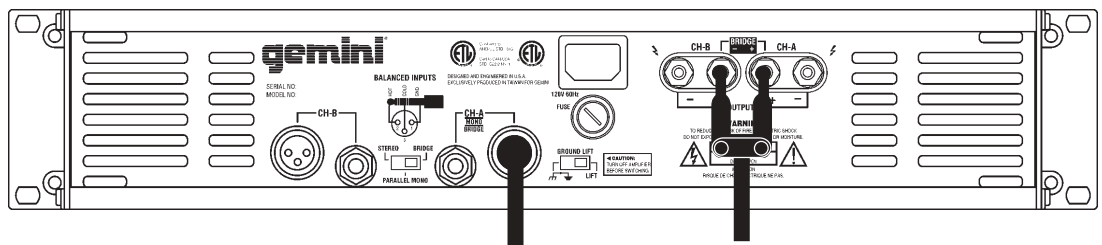
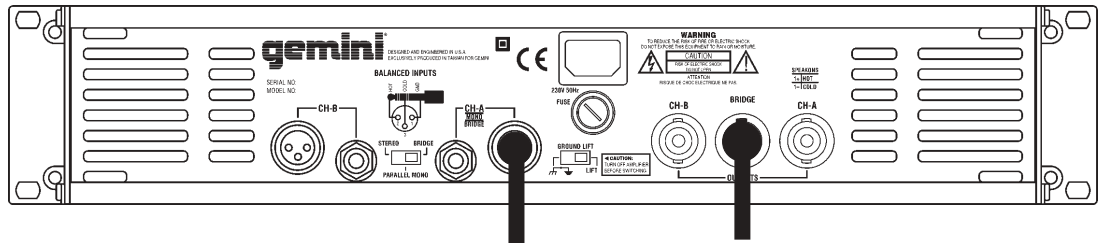

# Connections, Controls and Indicators

## Rear Panel

Note: 120V and 230V units have different types of output connectors on the rear panel.

### Input Section:

There are two parallel input connectors (one female XLR and one 1/4" jack) per channel. Either can be used as an input or as a link to chain amplifiers.

**XLR Input Jacks (1, 5):** electronically balanced inputs accept a standard XLR male connector. Pin 1 = shield/ground, pin 2 = hot or positive (+) and pin 3 = cold or negative (-).

**1/4" Phone Input Jacks (2, 4):** accept a balanced as well as an unbalanced line level signal. The unbalanced line uses a standard tip-sleeve connection. The tip is positive and the sleeve is negative/ground. The balanced line uses a tip-ring-sleeve connection. Tip = hot or positive (+), ring = cold or negative (-), and sleeve = shield/ground.

**Operation Mode Switch (3):** switch is used to set the unit for Stereo mode, Parallel Mono mode or Mono Bridge mode.

### AC Power Section:

**Fuse (7):** replace fuse with those of proper type and rating.

**Ground Lift Switch (8)** is used to lift the ground from the chassis. See the Ground Lift Switch Instructions for more detail.

**AC Cord Outlet (6)** is used to attach the power cord to the unit.

### Output Section:

Disconnect unit from the AC power source before making any connections. Pay close attention to polarity (shown on the back of the unit) when connecting your speakers. Connecting your speaker systems using the wrong polarity will not damage your speakers, but it will impact the quality of the sound (lack of bass and incorrect stereo image).

**Speaker Outputs for 120V Unit (9, 10, 11):** the speaker output jacks are 5-way binding posts that will accept a standard banana plugs, spade lugs or bare wire. Make sure that all the connections are clean when using bare wire connections. If any strands of wire from one connector touch the adjacent connector, the sound will be distorted, and your amplifier will overheat and go into protection mode.

**Speaker Outputs for 230V Unit (9, 10, 11):** Neutrik Speakon connectors are provided to connect speakers to the amplifier quickly and easily. They are high current rated and provide very stable and durable contacts. A third Speakon connector in the center is provided to be used if the amplifier is in the Mono Bridge mode. Every Speakon connector has pin 1- as negative and pin 1+ as positive.

NOTE: Total speaker impedance must not be lower than 4 Ohm per channel for Stereo and Parallel Mono modes, or 8 Ohm for Mono Bridge mode.

## Front Panel

**Power Switch (20):** turns the unit on and off.

**Power LED (19):** the power LED lights when the power is on. If the power LED does not light, refer to the trouble shooting guide.

**Mono LED (12):** the mono LED will light when you have set the rear panel **Operation Mode Switch (3)** for parallel mono operation. Always make sure that this switch is in the correct position and that all speaker connections have been made correctly for the mode of operation you wish to use before powering up the amplifier.

**Bridge LED (13):** the bridge LED will light when you have set the rear panel **Operation Mode Switch (3)** for mono bridge operation. Always make sure that this switch is in the correct position and that all speaker connections have been made correctly for the mode of operation you wish to use before powering up the amplifier.

**Signal LED (14):** the signal LEDs for each channel show when a signal is present. In Mono Bridge mode, both the channel A LED and the channel B LED will light in unison.

**Clip LED (15):** the amplifier has true clip LEDs to help you properly control the amplifier's output and achieve undistorted sound. The clip LEDs for each channel light when your signal level is so strong that the distortion reaches 1% THD. The clip LED should not remain constantly on or flash repeatedly during operation. For clean sound reproduction, the clip should only light occasionally for an instant. If the LED remains on or flashes repeatedly, you will hear distorted sound that can be damaging to your speaker systems. If this occurs, reduce the signal level by lowering the input level control for the channel that is clipping or reduce the level at the source. If the clip LED lights when no signal is present, it may indicate a RF signal on the output which may cause damage to speakers (the RF signal will not be audible). Please note that when you are using the amplifier in the Mono Bridge mode, both clip LEDs of the bridged channels will operate simultaneously.

**Protect LED (16):** when you first turn on the amplifier, the protect LEDs light briefly during a turn-on delay which indicates that the outputs are disconnected internally. There will be an audible click when the outputs reconnect and the protect LEDs will turn off. Otherwise, the protect LED indicates that there is a problem either in the amplifier's external connections, load or temperature conditions or its internal functions. If one of these situations occur, the amplifier senses the problem and automatically switches into protection mode. The LED will light to warn you of the trouble and the amplifier will stop working. If this occurs, switch off the amplifier and refer to the Trouble Shooting Guide. If the protect LED remains lit when resuming amplifier operation, do not use the amplifier and contact an authorized service technician.

**Level Controls (17, 18):** establish the input levels required for each channel. Only the **Channel A Level Control (17)** works in Mono Bridge mode.

## Operating Instructions

**THE AMPLIFIER'S POWER MUST BE TURNED OFF WHEN CHANGING MODES OF OPERATION.**

### Stereo Operation

The unit has two channels for stereo operation. Each channel provides a separate and discrete signal at the speaker outputs according to the signal received at the inputs. The following instructions are for applications with 4 Ohm or 8 Ohm speakers of matched power ratings.

1. With the power off, set the **OPERATION MODE SWITCH (3)** to the **STEREO** position. When the power is on, the Mono and Bridge LEDs on the front panel will not light. If these LEDs illuminate, you have the switch in the wrong position. Correct before continuing.
2. With the power off, connect your input cables to the channel A and B inputs using either the **XLR INPUT JACKS (1, 5)** or **1/4" INPUT JACKS (2, 4)** of each channel. The other channel A and channel B inputs can be used to link to an additional amplifier.
3. Connect the loudspeakers to the channel A and channel B **SPEAKER OUTPUTS (9, 11)**. **THE TOTAL SPEAKER LOAD MUST BE AT LEAST 4 OHMS PER CHANNEL.** If you try to operate at a lower impedance, the amplifier will go into protection mode and stop operation until you correct the load conditions.
4. With the **LEVEL CONTROLS (17, 18)** of both channels set to zero (fully counterclockwise), turn the **POWER SWITCH (20)** on. Apply a signal to the input of the amplifier. The level of the input signal should be as high as you will ever need it to be. This way, it will be as high above the amplifier's noise floor as possible, ensuring an excellent performance and signal to noise ratio. Adjust the **LEVEL CONTROLS** for each channel to achieve the desired maximum listening level. Note, when the clip LEDs light, there is distortion present in the amplifier's output section. If a clip LED remains on or flashes repeatedly, reduce the signal level by lowering the input level control for the channel that is clipping or reduce the level at the source.

## Parallel Mono Operation

Follow these instructions for Parallel Mono Operation using a single input cable, and you will have the same monophonic signal on both the channel A and the channel B outputs. Each channel's output is controlled independently by that channel's level control.

1. With the power off, set the **OPERATION MODE SWITCH (3)** to the **PARALLEL MONO** position. When the power is on, the **MONO LED (12)** on the front panel will light. If the LED does not illuminate, you have the switch in the wrong position. Correct before continuing.
2. With the power off, connect your input cables to the channel A input only using the either the **XLR INPUT JACK (5)** or **1/4" INPUT JACK (4)** of channel A. The other channel A input can be used to link to an additional amplifier.
3. Connect the loudspeakers to the channel A and channel B **SPEAKER OUTPUTS (9, 11)**. THE TOTAL SPEAKER LOAD MUST BE AT LEAST 4 OHMS PER CHANNEL. If you try to operate at less than 4 Ohms per channel, the amplifier will go into the protection mode and stop operation until you correct the load conditions.
4. With the **LEVEL CONTROLS (17, 18)** set to zero (fully counterclockwise), switch the power on. Apply a signal to the input. The level of the input signal should be as high as you will ever need it to be. This way, it will be as high above the amplifier's noise floor as possible, ensuring an excellent performance and signal to noise ratio. Adjust the **LEVEL CONTROLS** for each channel to achieve the desired maximum listening level. Note, when the clip LEDs light, there is distortion present in the amplifier's output section. If a clip LED remains on or flashes repeatedly, reduce the signal level by lowering the input level control for the channel that is clipping or reduce the level at the source.

## Mono Bridge Operation

Follow these instructions to bridge the unit's outputs. Bridging the amplifier converts the unit to a monophonic or single channel. The amplifier can be used with 8 Ohm or higher loads only in Mono Bridge mode. This mode is used to provide a higher voltage with greater headroom to your speaker. Before setting your amplifier for Mono Bridge operation, make sure that your speaker can handle the high power level provided by the amplifier in Mono Bridge mode. CAUTION: VOLTAGE OVER 100 VOLTS MAY BE PRODUCED AT THE BRIDGE OUTPUT TERMINALS IN THIS MODE.

1. With the power off, set the **OPERATION MODE SWITCH (3)** to the **BRIDGE** position. When the power is on, the **BRIDGE LED (13)** on the front panel will light. If the LED does not illuminate, you have the switch in the wrong position. Correct before continuing.
2. With the power off, connect your input cables to channel A input only using the either the **XLR INPUT JACK (5)** or **1/4" INPUT JACK (4)** of channel A. The other channel A input can be used to link to an additional amplifier.
3. Connect the loudspeaker to the **BRIDGE SPEAKER OUTPUT (10)** only. With a 230V unit, use the center speakon. With a 120V unit, use the two innermost red terminals. Be sure the polarity of your connections is correct. The total speaker load must be at least 8 Ohms or above. If you try to operate at less than 8 Ohms in the Mono Bridge mode, the amplifier will go into the protection mode and stop operation until you correct the load conditions.
4. With the **CHANNEL A LEVEL CONTROL (17)** set to zero (fully counterclockwise), switch the power on. Apply a signal to the input. The level of the input signal should be as high as you will ever need it to be. This way, it will be as high above the amplifier's noise floor as possible, ensuring an excellent performance and signal to noise ratio. Adjust the **LEVEL CONTROL (17)** for channel A to achieve the desired maximum listening level. Note, when the clip LEDs light, there is distortion present in the amplifier's output section. If a clip LED remains on or flashes repeatedly, reduce the signal level by lowering the input level control for channel A or reduce the level at the source. During Mono Bridge operation, the channel B level is inactive, however, both channels LEDs will flash simultaneously and show output conditions.

## Using the Ground Lift Switch

Depending on your system configuration, sometimes applying the ground will create a quieter signal path. Sometimes lifting the ground can eliminate ground loops and hum to create a quieter signal path.

1. With the power amp on, listen to the system in idle mode (no signal present) with the ground applied (the **GROUND LIFT SWITCH (8)** in the left position).
2. **Then turn the power off before moving the GROUND LIFT SWITCH (8)**. Lift the ground by moving the **GROUND LIFT SWITCH** to the right, turn the power back on and listen to determine which position will provide a signal devoid of background noise and hum. Keep the **GROUND LIFT SWITCH** in the ground position if the noise level remains the same in either position.

CAUTION: DO NOT TERMINATE THE AC GROUND ON THE POWER AMPLIFIER IN ANY WAY. TERMINATION OF THE AC GROUND CAN BE HAZARDOUS.

SYMPTOM	CAUSE	SOLUTION
<b>UNIT DOES NOT PRODUCE SOUND. POWER LED DOES NOT LIGHT.</b>	<ul style="list-style-type: none"> <li>• POWER SWITCH NOT IN ON POSITION.</li> <li>• POWER CABLE NOT CONNECTED TO AMPLIFIER OR TO OUTLET.</li> <li>• AC OUTLET NOT ACTIVE.</li> <li>• MAIN AMPLIFIER FUSE DEFECTIVE.</li> </ul>	<ul style="list-style-type: none"> <li>• MOVE POWER SWITCH TO ON POSITION.</li> <li>• CONNECT POWER CABLE TO AC SUPPLY.</li> <li>• CHECK CONDITION OF OUTLET.</li> <li>• REPLACE AMPLIFIER MAIN POWER FUSE ON REAR PANEL WITH CORRECT TYPE AND RATING.</li> </ul>
<b>POWER LED LIGHTS, BUT NO SOUND IS PRODUCED BY AMPLIFIER.</b>	<ul style="list-style-type: none"> <li>• NO INPUT SOURCE SIGNAL.</li> <li>• INPUT SOURCE NOT CONNECTED.</li> <li>• INPUT CONNECTING CABLE DEFECTIVE.</li> <li>• SPEAKER(S) NOT CONNECTED.</li> <li>• SPEAKER CABLE DEFECTIVE.</li> <li>• SPEAKER SYSTEM(S) INOPERATIVE.</li> <li>• AMPLIFIER'S LEVEL CONTROLS ARE SET TO ZERO.</li> </ul>	<ul style="list-style-type: none"> <li>• CHECK FOR PROPER FUNCTION OF INPUT SOURCE DEVICE.</li> <li>• CHECK INPUT CABLES AND CONNECTIONS. REPLACE QUESTIONABLE CABLES WITH KNOWN GOOD CABLES.</li> <li>• CHECK SPEAKER CABLES AND CONNECTIONS. REPLACE QUESTIONABLE CABLES WITH KNOWN GOOD CABLES.</li> <li>• CHECK OPERATING CONDITION AND STATUS OF SPEAKER SYSTEM(S). BE SURE THE LEVEL CONTROLS ARE PROPERLY SET.</li> </ul>
<b>SOUND IS PRESENT BUT VOLUME IS TOO LOW EVEN THOUGH SOURCE DEVICE IS SET TO A HIGH LEVEL.</b>	<ul style="list-style-type: none"> <li>• AMPLIFIER INPUT LEVEL CONTROLS ARE SET TOO LOW.</li> <li>• WRONG PIN CONNECTIONS IN CABLES.</li> </ul>	<ul style="list-style-type: none"> <li>• ADJUST LEVEL CONTROLS AS PER INSTRUCTIONS.</li> <li>• USE CORRECT CABLES (AS SHOWN ON BACK OF UNIT).</li> </ul>
<b>LOUD 50/60 HZ OR 100/120 HZ HUM IS HEARD AT ALL TIMES THROUGH THE SPEAKER SYSTEMS.</b>	<ul style="list-style-type: none"> <li>• IMPROPER OR DEFECTIVE GROUND CONNECTION AT INPUTS. IMPROPER OR DEFECTIVE GROUND AT INPUT SOURCE DEVICE(S).</li> <li>• IMPROPER OR DEFECTIVE GROUND CONNECTION ON AC OUTLET.</li> <li>• GROUND LOOP THROUGH AC LINE CONNECTION/RACK MOUNTING.</li> </ul>	<ul style="list-style-type: none"> <li>• CHECK FOR PROPER AC LINE GROUND ON POWER AMP AND ALL INPUT DEVICES.</li> <li>• CHECK INPUT CABLES FOR ALL SOURCE DEVICES AND SIGNAL PROCESSING AS WELL AS INPUT CABLES TO POWER AMPLIFIER. CHECK POSITION OF GROUND LIFT SWITCH AS PER INSTRUCTIONS FOR LIFTING THE GROUND.</li> <li>• NEVER LIFT THE AC LINE GROUND ON THE POWER AMPLIFIER. IF YOU ARE NOT TOTALLY FAMILIAR WITH GROUND LIFTING OR UNIFICATION PROCEDURES, DO NOT ATTEMPT THEM WITHOUT FIRST CONSULTING YOUR DEALER OR A QUALIFIED SOUND TECHNICIAN FOR MORE INFORMATION ON GROUNDING. IMPROPERLY DONE, SUCH PROCEDURES CAN POSE A SAFETY AND/OR FIRE HAZARD.</li> </ul>
<b>SOUND IS DISTORTED.</b>	<ul style="list-style-type: none"> <li>• DISTORTION OCCURRING IN SOURCE DEVICE.</li> <li>• INPUT LEVEL IS SET TOO HIGH.</li> </ul>	<ul style="list-style-type: none"> <li>• CHECK CLIP INDICATORS ON INPUT SOURCE DEVICES AND RESET LEVELS IF NECESSARY TO ELIMINATE DISTORTION.</li> <li>• ADJUST LEVEL CONTROLS AS PER INSTRUCTIONS.</li> </ul>
<b>PROTECT LED REMAINS LIT OR GOES ON AND OFF INTERMITTENTLY AFTER USING AMPLIFIER FOR A SHORT TIME.</b>	<ul style="list-style-type: none"> <li>• UNIT IS OPERATING AT EXCESSIVELY HIGH TEMPERATURE.</li> <li>• EXTREMELY LOW SPEAKER IMPEDANCE.</li> <li>• SHORT IN SPEAKER CONNECTORS, SPEAKER CABLE OR SPEAKER SYSTEM.</li> </ul>	<ul style="list-style-type: none"> <li>• CHECK THAT AMPLIFIER IS ADEQUATELY VENTILATED ON THE FRONT AND REAR PANELS WHERE THE AIR VENTS AND FANS ARE LOCATED. IF OVERHEATED, LET THE AMPLIFIER COOL DOWN BEFORE APPLYING AN INPUT SIGNAL.</li> <li>• CHECK THE POSITION OF OPERATION MODE SWITCH. BE SURE THAT THE SPEAKER CONNECTIONS ARE MADE IN ACCORDANCE WITH THE SWITCH SETTING.</li> <li>• VERIFY SPEAKER SYSTEM IMPEDANCES. BE SURE THE TOTAL SPEAKER SYSTEM IMPEDANCE IS AT LEAST 4 OHMS PER CHANNEL WHEN THE OPERATION MODE SWITCH IS IN THE STEREO POSITION OR PARALLEL MONO POSITION. IF THE SWITCH IS IN THE BRIDGE MODE, THE IMPEDANCE MUST BE AT LEAST 8 OHMS. IF YOU ARE NOT SURE OF YOUR TOTAL SPEAKER IMPEDANCE LOAD, CONTACT YOUR DEALER FOR MORE INFORMATION.</li> <li>• CHECK CONDITION OF SPEAKER CABLES.</li> <li>• IF USING BARE WIRE CONNECTIONS ON THE OUTPUTS OF THE AMPLIFIER, BE SURE THAT NO STRANDS FROM ONE CONNECTOR ARE TOUCHING ANY OTHER CONNECTOR.</li> </ul>
<b>FUSE BLOWS INTERMITTENTLY.</b>	<ul style="list-style-type: none"> <li>• SPEAKER LOAD IMPEDANCE IS TOO LOW.</li> <li>• TYPE OR RATING OF THE FUSE IS NOT CORRECT.</li> </ul>	<ul style="list-style-type: none"> <li>• CHECK FOR SHORTS ON THE OUTPUTS.</li> <li>• CHECK YOUR SPEAKER IMPEDANCE (INFO FROM DEALER).</li> <li>• CHECK THAT THE FUSE TYPE AND RATING IS CORRECT.</li> </ul>
<b>PROTECT LED(S) STAY ON WITH NO SPEAKERS CONNECTED AND WITH THE AMPLIFIER COOLED DOWN.</b>	<ul style="list-style-type: none"> <li>• FAILED AMPLIFIER.</li> </ul>	<ul style="list-style-type: none"> <li>• CONTACT THE GEMINI SERVICE DEPARTMENT OR YOUR AUTHORIZED DEALER TO SPEAK TO A QUALIFIED SERVICE TECHNICIAN. IN THE U.S.A. CALL TOLL FREE 1-800-476-8633</li> </ul>



# Specifications

Output Power EIA: 1kHz @ 1% THD

	<u>XPM-600</u>	<u>XPM-900</u>	<u>XPM-1200</u>
Single Channel 8Ω	230	310	400
Both Channels Driven 8Ω	200	280	360
Single Channel 4Ω	300	480	630
Both Channels Driven 4Ω	270	400	530
Mono Bridge 8Ω	550	800	1060

Dynamic Headroom:	<u>XPM-600</u>	<u>XPM-900</u>	<u>XPM-1200</u>
8Ω	1.4	1.4	1.3
4Ω	2.2	2.2	2.2

Frequency Response.....20 Hz - 60 kHz  
 Total Harmonic Distortion.....less than 0.1%, typical 0.03% at 1 kHz  
 Intermodulation Distortion.....less than 0.05% (SMPTE)  
 Signal to Noise Ratio.....100 dB below rated power, 8Ω  
 Damping Factor.....greater than 200 @ 8Ω  
 Slew Rate.....25 V/μS  
 Voltage Gain.....33 dB

Input Sensitivity (for rated power at 8 Ohm):

	<u>XPM-600</u>	<u>XPM-900</u>	<u>XPM-1200</u>
	0.9 Vrms	1.1 Vrms	1.2 Vrms

Input Impedance Unbalanced.....10 kOhms  
 Input Impedance Balanced.....20 kOhms

Power consumption:	<u>XPM-600</u>	<u>XPM-900</u>	<u>XPM-1200</u>
	700 VA	900 VA	1100 VA

Note: power consumption is given at rated power at 8Ω per channel, both channels driven.

AC Power Requirement:  
 (power connection is factory configured).....120V/ 60 Hz  
 230V/ 50 Hz

Indicators.....1 Power Indicator  
 1 Signal LED per channel  
 1 Clip LED per channel  
 1 Protect LED per channel  
 1 Mono LED  
 1 Bridge LED

Cooling.....2 Speed Dual Fan; Front-to-Rear Forced Air  
 Protection.....Short Circuit, DC, Thermal Cut-off, Sub/ultrasonic  
 Frequency Filters, In-rush Current Limiter, Turn-on Delay

Connectors:  
 Balanced/Unbalanced Inputs.....1/4" Jack  
 Balanced Inputs.....XLR Female Jack  
 Speaker Outputs (120V unit).....5-way binding posts  
 Speaker Outputs (230V unit).....Speakons (ch.A, ch.B and bridge)

Dimensions.....19" x 13.75" x 3.5" (483 x 350 x 89 mm)

Weight	<u>XPM-600</u>	<u>XPM-900</u>	<u>XPM-1200</u>
	25.8 lbs	29 lbs	31.2 lbs
	11.7 kg	13.2 kg	14.2 kg

\* Specifications and design are subject to change without notice for purpose of improvement.

# XPM-600

1)	102056543301	SPACER	XPM-900	PC	2
2)	102119214701	CARTON	XPM-600	PC	1
3)	102260018001	EXT.CARTON	XPM-600	PC	1
4)	103012005700	SPACER	1200x570m/m	PC	1
5)	105011008501	HOLDER	XPM-900	PC	2
6)	105032409601	WALL	XPM-900	PC	1
7)	105034608501	SILD PANEL	XPM-900	PC	2
8)	105242608601	BACK BOARD	XPM-600	PC	1
9)	105343431801	TOP COVER	XPM-900	PC	1
10)	105443431701	BOTTOM CABI	XPM-900	PC	1
11)	107042002501	AIRFILTER	420x25m/m XPM-900	PC	1
12)	107042004001	PVC COVER	XPM-600	PC	1
13)	1070ACS03501	ACS-3.5 PVC	RED	PC	5
14)	1070KG-010—	MOVEABLE BUSHING	KG-010	CM	2
15)	1070SCB-10—	SPACER SUPPORTS	SCB-10 XPM-900	PC	4
16)	1070SS-6—	SELF RETATINING	SPALERS SS-6	PC	1
17)	1070YJ-98—	NYLON CLAMPER	YJ-98	PC	1 2
18)	AL201AL50101	AL201/AL501	SJT W-A 14AWG 6FT	PC	1
19)	AO016D130—	3P AC INLET	AC-016D130 XPM-900	PC	1
20)	105006400001	6.4m/m	PIN	PC	6
21)	106203003003	RECTIFER HEAT	SINK XPB-1600	PC	1
22)	106201302001	HEAT SINK BLACK	13x20 XPM-900	PC	1
23)	1070LED-3.5-	LED SPACER	SUPPORT LED-3.5	PC	9
24)	700KBP060002	RECTIFIER KBP06	2A 600V	PC	1
25)	700MP3504W02	RECTIFIER MP3504W	35A 400V	PC	1
26)	CCN0A101250K	CERAMIC CAP	100P 250V	PC	6
27)	CCN0A680500J	CERAMIC CAP	68P 500V NPO 5%	PC	2
28)	COIL16115T6L	COIL	1.6x10.1x11.5T-6L XPM-900	PC	2
29)	ECL04700080M	ELEC CAP	4700u80v	PC	4
30)	ECS00010050M	ELEC CAP	10u50v	PC	4
31)	ECS00100025M	ELEC CAP	100u25v	PC	4
32)	ECS00100100M	ELEC CAP	100u100v	PC	4
33)	ECS00220016M	ELEC CAP	220u16v	PC	6
34)	ECS01000025M	ELEC CAP	1000u25v	PC	1
35)	ECS02200025M	ELEC CAP	2200u25v	PC	1
36)	ICNJM3404AD-	IC	NJM3404AD	PC	2
37)	ICTL072CP—	IC	TL072CP	PC	1
38)	JS1001025003	BASE	3P 2.5m/m	PC	2
39)	JS1001025012	BASE	12P 2.5m/m	PC	1
40)	JS1001R25002	BASE	2P JS-1001R-02	PC	2



41)	LDG050210030	LED 5m/m GREEN	PC	5
42)	LDR050410030	LDE 5m/m RED	PC	2
43)	LDY050610030	LDE 5m/m YELLOW	PC	2
44)	MJ0860250900	CONNOC JACK 086-25-90	PC	2
45)	MJCPJ-065---	JACK CPJ-065 XPM-900	PC	2
46)	MPMEA104250K	MEA .1u 250V 10%	PC	6
47)	MPMEF104250K	MEF .1u 250V 10%	PC	2
48)	NTM3x07x030Y	NUT 3m/m W/S (0J0010-030001)	PC	1
49)	RC0200A47005	RESISTORS 4.7 ohm 2W M	PC	2
50)	RC0201000005	RESISTORS 10 ohm 2W M	PC	2
51)	RC0202230005	RESISTORS 22 K 2W M	PC	2
52)	RC0204720005	RESISTORS 4.7 K 2W M	PC	2
53)	RC0205620005	RESISTORS 5.6 K 2W M	PC	2
54)	RL832---12	832-1C-C-12D XPM-900	PC	2
55)	SR01MS3x061B	MS 3x6 BLACK	PC	1
56)	SR01TP4x204Y	TP4x20 (1JBH6C-042021)	PC	1
57)	SWL-----1	SS004-P2430Em-PC10 XPM-900	PC	1
58)	SWS-----1	SS004-P022 BY-PF8	PC	1
59)	TRMJE340-0	MJE340	PC	2
60)	TRMJE350-0	MJE350	PC	2
61)	TRMPSA13-0	TR MPSA13	PC	2
62)	TRTIP122-0	TIP122	PC	1
63)	TRZ0103-0	TRIAC Z0103 MA1A600V RR-15	PC	2
64)	W20105135205	1015#14 GREEN XPM-900	PC	1
65)	W20105185205	1015#14 GREEN XPM-900	PC	1
66)	W20105235208	1015#14 GRAY XPM-900	PC	1
67)	W20105375202	1015#14 RED XPM-900	PC	1

XPM-600E

STEREO

MOSFET POWER AMPUFIER

=====		=====		=====	=====
=====		=====		=====	=====
68)	W20105375202	1015#14 RED	XPM-900	PC	1
69)	W2120A3000BB	1007#26 MIX	XPM-900	PC	1
70)	WS204x10x07W	SPRING	W/S.M4-L(2JS100-040050)	PC	1
71)	106202602001	ALUMINUM PLATE	26x20m/m t=3	PC	4
72)	106219207601	HEAT SINK	192x76x60 XPM-900	PC	2
73)	PTH9M222—E2	PTH9M04BE222TS2F333	XPM-900	PC	2
74)	PTH9M471—H1	PTH9M04BH471TS2F333	XPM-900	PC	2
75)	SR01MS3x061B	MS 3x6	BLACK	PC	4
76)	SR01MS3x161W	MS 3x16	(1JBHMC-031600)	PC	4
77)	SR01TP3x103B	TP 3x10	BLACK	PC	4
78)	SR03TP4x084B	FMT+W TP 4x8	BLACK	PC	8
79)	TRBUZ900NDP0	BUZ900NDP MOSFET	XPM-600	PC	2
80)	TRBUZ905DP-0	BUZ905DP MOSFET	XPM-600	PC	2
81)	WS132x08x10W	3.2x0.8x10	(2IFA032-081000)	PC	4
82)	WS203x08x05W	SPRING	W/S.M3-L(2JS100-030050)	PC	1 0
83)	2SA970BL—0	TR 2SA970	BL	PC	1 0
84)	2SC2240BL—0	TR 2SC2240	BL	PC	4
85)	6003501950	XPM-900 MAIN	PC BOARD T=2oz	PC	1
86)	700033050001	ZENER 3.3v	500mw	PC	6
87)	700075050001	ZENER 7.5V	500mw	PC	1
88)	700120050001	ZENER 12V	500mw	PC	6
89)	700150050001	ZENER 15V	500mw	PC	1
90)	700150100001	ZENER 15V	1W	PC	2
91)	7001N4004051	DIODE 1N4004		PC	6
92)	7001N4148051	DIODE 1N4148		PC	1 3
93)	MCT0A102100J	MYLAR CAP .001u	T	PC	2
94)	MCT0A153100J	MYLAR CAP .015u	T	PC	2
95)	MCT0A182100J	MYLAR CAP .0018u	T	PC	2
96)	MCT0A473100J	MYLAR CAP .047u	T	PC	1
97)	MPMSC104100J	MSC .1u 100V	5% T	PC	1 5
98)	RC0031010005	RESISTORS 100 ohm	1/4W T	PC	4
99)	RC0031020005	RESISTORS 1 K	1/4W T	PC	2 1
100)	RC0031030005	RESISTORS 10 K	1/4W T	PC	1 6

101)	RC0031040005	RESISTORS 100 K 1/4W T	PC	2
102)	RC0031050005	RESISTORS 1 M 1/4W T	PC	1
103)	RC0031520005	RESISTORS 1.5 K 1/4W T	PC	2
104)	RC0032020005	RESISTORS 2 K 1/4W T	PC	3
105)	RC0032210005	RESISTORS 220 ohm 1/4W T	PC	2
106)	RC0032230005	RESISTORS 22 K 1/4W T	PC	2
107)	RC0033030005	RESISTORS 30 K 1/4W T	PC	4
108)	RC0033040005	RESISTORS 300 K 1/4W T	PC	2
109)	RC0033320005	RESISTORS 3.3 K 1/4W T	PC	4
110)	RC0034700005	RESISTORS 47 ohm 1/4W T	PC	4
111)	RC0034730005	RESISTORS 47 K 1/4W T	PC	4
112)	RC0035110005	RESISTORS 510ohm 1/4W T	PC	4
113)	RC0036830005	RESISTORS 68 K 1/4W T	PC	4
114)	RC0038210005	RESISTORS 820 ohm 1/4W T	PC	2
115)	RC0038220005	RESISTORS 8.2 K 1/4W T	PC	2
116)	RC0050A10005	RESISTORS 1 ohm 1/2W T	PC	1
117)	RC0053030005	RESISTORS 30 K 1/2W T	PC	2
118)	RC0054730005	RESISTORS 47 K 1/2W T	PC	2
119)	RM0030K47501	RESISTORS 475 ohm 1/4W T	PC	2
120)	RM00310K0001	RESISTORS 10K 1% 1/4W T	PC	8
121)	105006400001	6.4m/m PIN	PC	2
122)	6000680600	XPM-900 POWER PC BOARD T=oz	PC	1
123)	MPMPX473275K	MPX .047u 275VAC 10%	PC	1
124)	NTC0120L	NTC 20A SCK-0120 XPM-900	PC	1
125)	RS0500122005	1.2 K 5W SQP TYPE	PC	1
126)	W2010G130051	1015#14 BROWN XPM-900E	PC	1
127)	W2010G180056	1015#14 BLUE XPM-900E	PC	1
128)	FAD012080001	SP802512H L=350m/m+XH	PC	2
129)	FH63032I	FUSE HOLD HTB-32I VDE TYPE	PC	1
130)	FS630ULC060F	FUSE 6x30 FAST/GLASS U/C 6A	PC	1
131)	FTSF-006	PLASTIC FOOT SF-006	PC	4
132)	IBXPM900—GI	MANUAL XPM-900 (GEMINI)	PC	1
133)	KB1819BL0001	KNOB 18x19 BLACK XPM-900	PC	2
134)	NTM8x17x080B	NUT 5/16 (0A0220-310005)	PC	1
135)	PB420215	PLOY BAG 8.5"x16.5"X0.05	PC	1
136)	PT130———2	TRANS. 130m/m XPM-600E 230V	PC	1
137)	SR01MS3x042B	MST 3x4 BLACK(1JPH1C-030424)	PC	2
138)	SR01MS3x061B	MS 3x6 BLACK(1JBHMC-030604)	PC	1 0
139)	SR01MS3x121B	MS 3x12 BLACK	PC	1

140)	SR01MS3x081W	MS 3x8	(1JPHMC-030800)	PC	1
141)	SR01MS4x061W	MS 4x6	(PLATING)	PC	1
142)	SR01MS4x082B	MST 4x8	BLACK (1JBH1C-040824)	PC	1 6
143)	SR01TP3x063B	TP 3x6	BLACK (1JBHCC-030625)	PC	6
144)	SR01TP3x103B	TP 3x10	BLACK (1JBHCC-031024)	PC	4
145)	SR03TP4x084B	FMT+W TP	4x8 (1JBP6C-040825)	PC	1 4
146)	SR10MS8x751B	5/16x3"	(1ATKMO-31C004)	PC	1
147)	SWP—————9	R22-22B-11B	XPM-900	PC	1
148)	VR16A1031501	16K4x1 L-15	XPM-900	PC	2
149)	W2010G445101	1015#14	BROWN XPM-900E	PC	1
150)	W2010G505106	1015#14	BLUE XPM-900E	PC	1
151)	W2010I12510A	1015#18	GR+YL	PC	1
152)	W20110120101	1015#14	BROWN XPM-900E	PC	1
153)	W5010A370032	2852#26	RED XPM-900	PC	1
154)	W5010A460038	2852#26	GRAY XPM-900	PC	1
155)	WDGEMINI	GEMINI WARRANTY CARD		PC	1
156)	WS407x03x09Y	EXT TOOTH	W/S. 3m/m	PC	1

4 6 5

## XPM-900

1 )	102056543301	SPACER	XPM-900	PC	2
2 )	102119214702	CARTON	XPM-900	PC	1
3 )	102260018002	EXT.CARTON	XPM-900	PC	1
4 )	103012005700	SPACER	1200x570m/m	PC	1
5 )	105011008501	HOLDER	XPM-900	PC	2
6 )	105032409601	WALL	XPM-900	PC	1
7 )	105034608501	SILD PANEL	XPM-900	PC	2
8 )	105242608603	BACK BOARD	XPM-900	PC	1
9 )	105343431801	TOP COVER	XPM-900	PC	1
10 )	105443431701	BOTTOM CABI	XPM-900	PC	1
11 )	107042002501	AIRFILTER	420x25m/m XPM-900	PC	1
12 )	107042004002	PVC COVER	XPM-900	PC	1
13 )	1070ACS03501	ACS-3.5 PVC	RED	PC	5
14 )	1070KG-010—	M0VEABLE BUSHING	KG-010	CM	2
15 )	1070SCB-10—	SPACER SUPPORTS	SCB-10 XPM-900	PC	4
16 )	1070SS-6—	SELF RETATINING	SPALERS SS-6	PC	1
17 )	1070YJ-98—	NYLON CLAMPER	YJ-98	PC	1 2
18 )	AL201AL50101	AL201/AL501 SJT	W-A 14AWG 6FT	PC	1
19 )	AO016D130—	3P AC INLET	AC-016D130 XPM-900	PC	1
20 )	2SA970BL—0	TR 2SA970	BL	PC	10
21 )	2SC2240BL—0	TR 2SC2240	BL	PC	4
22 )	6003501950—	XPM-900 MAIN	PC BOARD T=2oz	PC	1
23 )	700033050001	ZENER	3.3v 500mw	PC	6
24 )	700075050001	ZENER	7.5V 500mw	PC	1
25 )	700120050001	ZENER	12V 500mw	PC	6
26 )	700150050001	ZENER	15V 500mw	PC	1
27 )	700150100001	ZENER	15V 1W	PC	2
28 )	7001N4004051	DIODE	1N4004	PC	6
29 )	7001N4148051	DIODE	1N4148	PC	1 3
30 )	MCT0A102100J	MYLAR CAP	.001u T	PC	2
31 )	MCT0A153100J	MYLAR CAP	.015u T	PC	2
32 )	MCT0A182100J	MYLAR CAP	.0018u T	PC	2
33 )	MCT0A473100J	MYLAR CAP	.047u T	PC	1
34 )	MPMSC104100J	MSC	.1u 100V 5% T	PC	1 5
35 )	RC0031010005	RESISTORS	100 ohm 1/4W T	PC	4
36 )	RC0031020005	RESISTORS	1 K 1/4W T	PC	2 1
37 )	RC0031030005	RESISTORS	10 K 1/4W T	PC	1 6
38 )	RC0031040005	RESISTORS	100 K 1/4W T	PC	2
39 )	RC0031050005	RESISTORS	1 M 1/4W T	PC	1
40 )	RC0031520005	RESISTORS	1.5 K 1/4W T	PC	2

4 1 )	RC0032020005	RESISTORS 2 K 1/4W T	PC	3
4 2 )	RC0032210005	RESISTORS 220 ohm 1/4W T	PC	2
4 3 )	RC0032230005	RESISTORS 22 K 1/4W T	PC	2
4 4 )	RC0033030005	RESISTORS 30 K 1/4W T	PC	4
4 5 )	RC0033040005	RESISTORS 300 K 1/4W T	PC	2
4 6 )	RC0033320005	RESISTORS 3.3 K 1/4W T	PC	4
4 7 )	RC0034700005	RESISTORS 47 ohm 1/4W T	PC	4
4 8 )	RC0034730005	RESISTORS 47 K 1/4W T	PC	4
4 9 )	RC0035110005	RESISTORS 510ohm 1/4W T	PC	4
5 0 )	RC0036830005	RESISTORS 68 K 1/4W T	PC	4
5 1 )	RC0038210005	RESISTORS 820 ohm 1/4W T	PC	2
5 2 )	RC0038220005	RESISTORS 8.2 K 1/4W T	PC	2
5 3 )	RC0050A10005	RESISTORS 1 ohm 1/2W T	PC	1
5 4 )	RC0053030005	RESISTORS 30 K 1/2W T	PC	2
5 5 )	RC0054730005	RESISTORS 47 K 1/2W T	PC	2
5 6 )	RM0030K47501	RESISTORS 475 ohm 1/4W T	PC	2
5 7 )	RM00310K0001	RESISTORS 10K 1% 1/4W T	PC	8
5 8 )	105006400001	6.4m/m PIN	PC	6
5 9 )	106201302001	HEAT SINK BLACK 13x20 XPM-900	PC	1
6 0 )	106203003003	RECTIFIER HEAT SINK XPB-1600	PC	1
6 1 )	1070LED-3.5-	LED SPACER SUPPORT LED-3.5	PC	9
6 2 )	700KBP060002	RECTIFIER KBP06 2A 600V	PC	1
6 3 )	700MP3504W02	RECTIFIER MP3504W 35A 400V	PC	1
6 4 )	CCN0A101250K	CERAMIC CAP 100P 250V	PC	6
6 5 )	CCN0A680500J	CERAMIC CAP 68P 500V NPO 5%	PC	2
6 6 )	COIL16115T6L	COIL 1.6x10.1x11.5T-6L XPM-900	PC	2
6 7 )	ECL06800100M	ELEC CAP 6800u100v	PC	4
6 8 )	ECS00010050M	ELEC CAP 10u50v	PC	4
6 9 )	ECS00100025M	ELEC CAP 100u25v	PC	4
7 0 )	ECS00100100M	ELEC CAP 100u100v	PC	4
7 1 )	ECS00220016M	ELEC CAP 220u16v	PC	6
7 2 )	ECS01000025M	ELEC CAP 1000u25v	PC	1
7 3 )	ECS02200025M	ELEC CAP 2200u25v	PC	1
7 4 )	ICNJM3404AD-	IC NJM3404AD	PC	2
7 5 )	ICTL072CP--	IC TL072CP	PC	1
7 6 )	JS1001025003	BASE 3P 2.5m/m	PC	2
7 7 )	JS1001025012	BASE 12P 2.5m/m	PC	1
7 8 )	JS1001R25002	BASE 2P JS-1001R-02	PC	2
7 9 )	LDG050210030	LED 5m/m GREEN	PC	5
8 0 )	LDR050410030	LDE 5m/m RED	PC	2

81)	LDY050610030	LDE 5m/m YELLOW	PC	2
82)	MJ0860250900	CONNOC JACK 086-25-90	PC	2
83)	MJCPJ-065---	JACK CPJ-065 XPM-900	PC	2
84)	MPMEA104250K	MEA .1u 250V 10%	PC	6
85)	MPMEF104250K	MEF .1u 250V 10%	PC	2
86)	NTM3x07x030Y	NUT 3m/m W/S (0J0010-030001)	PC	1
87)	RC0200A47005	RESISTORS 4.7 ohm 2W M	PC	2
88)	RC0201000005	RESISTORS 10 ohm 2W M	PC	2
89)	RC0202230005	RESISTORS 22 K 2W M	PC	2
90)	RC0204720005	RESISTORS 4.7 K 2W M	PC	2
91)	RC0205620005	RESISTORS 5.6 K 2W M	PC	2
92)	RL832---12	832-1C-C-12D XPM-900	PC	2
93)	SR01MS3x061B	MS 3x6 BLACK	PC	1
94)	SR01TP4x204Y	TP4x20 (1JBH6C-042021)	PC	1
95)	SWL---1	SS004-P2430Em-PC10 XPM-900	PC	1
96)	SWS---1	SS004-P022 BY-PF8	PC	1
97)	TRMJJE340-0	MJE340	PC	2
98)	TRMJJE350-0	MJE350	PC	2
99)	TRMPSA13-0	TR MPSA13	PC	2
100)	TRTIP122-0	TIP122	PC	1
101)	TRZ0103---0	TRIAC Z0103 MA1A600V	PC	2
102)	W20105135205	1015#14 GREEN XPM-900	PC	1
103)	W20105185205	1015#14 GREEN XPM-900	PC	1
104)	W20105235208	1015#14 GRAY XPM-900	PC	1
105)	W20105375202	1015#14 RED XPM-900	PC	1
106)	W2120A3000BB	1007#26 MIX XPM-900	PC	1
107)	WS204x10x07W	SPRING W/S.M4-L(2JS100-040050)	PC	1
108)	106219207601	HEAT SINK 192x76x60 XPM-900	PC	2
109)	PTH9M222-E2	PTH9M04BE222TS2F333 XPM-900	PC	2
110)	PTH9M471-H1	PTH9M04BH471TS2F333 XPM-900	PC	2
111)	SR01MS3x061B	MS 3x6 BLACK	PC	4
112)	SR01MS3x121B	MS 3x12 BLACK	PC	12
113)	SR01TP3x103B	TP 3x10 BLACK	PC	4
114)	SR03TP4x084B	FMT+W TP 4x8 BLACK	PC	4
115)	TRBUZ901P-0	BUZ901P MOSFET XPM-900	PC	6
116)	TRBUZ906P-0	BUZ906P MOSFET XPM-900	PC	6
117)	WS132x08x10W	3.2x0.8x10 (2IFA032-081000)	PC	12
118)	WS203x08x05W	SPRING W/S.M3-L(2JS100-030050)	PC	16
119)	105006400001	6.4m/m PIN	PC	2
120)	6000680600-	XPM-900 POWER PC BOARD T=oz	PC	1



121)	MPMPX473275K	MPX .047u 275VAC 10%	PC	1
122)	NTC0120L	NTC 20A SCK-0120 XPM-900	PC	2
123)	RS0500122005	1.2 K 5W SQP TYPE	PC	1
124)	W2010G130050	1015#14 BLACK XPM-900U	PC	1
125)	W2010G180059	1015#14 WHITE XPM-900U	PC	1
126)	FAD012080001	SP802512H L=350m/m+XH	PC	2
127)	FH630207D	FUSE HOLD CQ-207D	PC	1
128)	FS630ULC120F	FUSE 6x30 FAST/GLASS U/C 12A	PC	1
129)	FTSF-006	PLASTIC FOOT SF-006	PC	4
130)	IBXPM900—GI	MANUAL XPM-900 (GEMINI)	PC	1
131)	KB1819BL0001	KNOB 18x19 BLACK XPM-900	PC	2
132)	NTM8x17x080B	NUT 5/16 (0A0220-310005)	PC	1
133)	PB420215	PLOY BAG 8.5"x16.5"X0.05	PC	1
134)	PT160——2	TRANS. 160m/m XPM-900U 120V	PC	1
135)	SPK1047R2001	WIN-1047R2 R/B XPM-900	PC	1
136)	SPK1047R2002	WTN-1047R2 B/R XPM-900	PC	1
137)	SPKCOVER—1	WIN-1047R2 COVER BLACK XPM-900	PC	1
138)	SPKCOVER—2	WIN-1047R2 COVER RED XPM-900	PC	1
139)	SR01MS3x042B	MST 3x4 BLACK(1JPH1C-030424)	PC	2
140)	SR01MS3x061B	MS 3x6 BLACK(1JBHMC-030604)	PC	10
141)	SR01MS3x081W	MS 3x8 (1JPHMC-030800)	PC	1
142)	SR01MS4x061W	MS 4x6 (PLATING)	PC	1
143)	SR01MS3x121B	MS 3x12 BLACK	PC	1
144)	SR01MS4x082B	MST 4x8 BLACK (1JBH1C-040824)	PC	16
145)	SR01TP3x063B	TP 3x6 BLACK (1JBHCC-030625)	PC	6
146)	SR01TP3x103B	TP 3x10 BLACK (1JBHCC-031024)	PC	4
147)	SR03TP4x084B	FMT+W TP 4x8 (1JBP6C-040825)	PC	14
148)	SR10MS8x751B	5/16x3" (1ATKMO-31C004)	PC	1
149)	SWP——9	R22-22B-11B XPM-900	PC	1
150)	VR16A1031501	16K4x1 L-15 XPM-900	PC	2
151)	W2010G445100	1015#14 BLACK XPM-900U	PC	1
152)	W2010G505109	1015#14 WHITE XPM-900U	PC	1
153)	W2010I12510A	1015#18 GR+YL PC1800	PC	1
154)	W20110120100	1015#14 BLACK XPM-900U	PC	1
155)	W5010A370032	2852#26 RED XPM-900	PC	1
156)	W5010A460038	2852#26 GRAY XPM-900	PC	1

## XPM-1200

1) 102056543301	SPACER XPM-900	FC	2
2) 102119214703	CARTON XPM-1200	FC	1
3) 102260018003	EXT.CARTON XPM-1200	FC	1
4) 103012005700	SPACER 1200x570m/m	FC	1
5) 105011008501	HOLDER XPM-900	FC	2
6) 105032409601	WALL XPM-900	FC	1
7) 105034608501	SILD PANEL XPM-900	FC	2
8) 105242608605	BACK BOARD XPM-1200	FC	1
9) 105343431801	TOP COVER XPM-900	FC	1
10) 105443431701	BOTTOM CABI XPM-900	FC	1
11) 107042002501	AIRFILTER 420x25m/m XPM-900	FC	1
12) 107042004003	PVC COVER XPM-1200	FC	1
13) 1070ACS03501	ACS-3.5 PVC RED	FC	5
14) 1070KG-010	MOVEABLE BUSHING KG-010	OM	2
15) 1070SCB-10	SPACER SUPPORTS SCB-10 XPM-900	FC	4
16) 1070SS-6	SELF RETATINING SPALERS SS-6	FC	1
17) 1070YJ-98	NYLON CLAMPER YJ-98	FC	12
18) AL201AL50101	AL201/AL501 SJT W-A 14AWG 6FT	FC	1
19) AO016D130	3P AC INLET AC-016D130 XPM-900	FC	1
20) 105006400001	6.4m/m PIN	FC	6
21) 106201302001	HEAT SINK BLACK 13x20 XPM-900	FC	1
22) 106203003003	RECTIFIER HEAT SINK XPB-1600	FC	1
23) 1070LED-3.5-	LED SPACER SUPPORT LED-3.5	FC	9
24) 700KBP060002	RECTIFIER KBP06 2A 600V	FC	1
25) 700MP3504W02	RECTIFIER MP3504W 35A 400V	FC	1
26) CCN0A101250K	CERAMIC CAP 100P 250V	FC	6
27) CCN0A680500J	CERAMIC CAP 68P 500V NPO 5%	FC	4
28) COIL16115T6L	COIL 1.6x10.1x11.5T-6L XPM-900	FC	2
29) ECL06800100M	ELEC CAP 6800u100v	FC	4
30) ECS00010050M	ELEC CAP 10u50v	FC	4
31) ECS00100025M	ELEC CAP 100u25v	FC	4
32) ECS00100100M	ELEC CAP 100u100v	FC	4
33) ECS00220016M	ELEC CAP 220u16v	FC	6
34) ECS01000025M	ELEC CAP 1000u25v	FC	1
35) ECS02200025M	ELEC CAP 2200u25v	FC	1
36) ICNJM3404AD-	IC NJM3404AD	FC	2
37) ICTL072CP	IC TL072CP	FC	1
38) JS1001025003	BASE 3P 2.5m/m	FC	2
39) JS1001025012	BASE 12P 2.5m/m	FC	1
40) JS1001R25002	BASE 2P JS-1001R-02	FC	2

41) LDG050210030	LED5m/m GREEN	FC	5
42) LDR050410030	LDE 5m/m RED	FC	2
43) LDY050610030	LDE 5m/m YELLOW	FC	2
44) MJ0860250900	CONNOC JACK 086-25-90	FC	2
45) MJCPJ-065---	JACK CPJ-065 XPM-900	FC	2
46) MPMEA104250K	MEA .1u 250V 10%	FC	6
47) MPMEF104250K	MEF .1u 250V 10%	FC	2
48) NTM3x07x030Y	NUT 3m/m W/S (0J0010-030001)	FC	1
49) RC0200A47005	RESISTORS 4.7 ohm 2W M	FC	2
50) RC0201000005	RESISTORS 10 ohm 2W M	FC	2
51) RC0202230005	RESISTORS 22 K 2W M	FC	2
52) RC0204720005	RESISTORS 4.7 K 2W M	FC	2
53) RC0205620005	RESISTORS 5.6 K 2W M	FC	2
54) RL832-----12	832-1C-C-12D XPM-900	FC	2
55) SR01MS3x061B	MS 3x6 BLACK	FC	1
56) SR01TP4x204Y	TP4x20 (1JBH6C-042021)	FC	1
57) SML-----1	SS004-P2430Em-PC10 XPM-900	FC	1
58) SWS-----1	SS004-P022 BY-PF8	FC	1
59) TRMJE340-0	MJE340	FC	2
60) TRMJE350-0	MJE350	FC	2
61) TRMPSA13-0	TRMPSA13	FC	2
62) TRTIP122-0	TIP122	FC	1
63) TRZ0103-0	TRIAC Z0103 MA1A600V RR-15	FC	2
64) W20105135205	1015#14 GREEN XPM-900	FC	1
65) W20105185205	1015#14 GREEN XPM-900	FC	1
66) W20105235208	1015#14 GRAY XPM-900	FC	1
67) W20105375202	1015#14 RED XPM-900	FC	1
68) W2120A3000BB	1007#26 MIX XPM-900	FC	1
69) WS204x10x07W	SPRING W/S.M4-L(2JS100-040050)	FC	1
70) 106219207601	HEAT SINK 192x76x60 XPM-900	FC	2
71) PTH9M222-E2	PTH9M04BE222TS2F333 XPM-900	FC	2
72) PTH9M471-H1	PTH9M04BH471TS2F333 XPM-900	FC	2
73) SR01MS3x061B	MS 3x6 BLACK	FC	4
74) SR01MS3x121B	MS 3x12 BLACK	FC	8
75) SR01TP3x103B	TP 3x10 BLACK	FC	4
76) SR03TP4x084B	FMT+W TP 4x8 BLACK	FC	4
77) TRBUZ901NDP0	BUZ901NDP MOSFET XPM-1200	FC	4
78) TRBUZ906DP-0	BUZ906DP MOSFET XPM-1200	FC	4
79) WS132x08x10W	3.2x0.8x10 (2IFA032-081000)	FC	8
80) WS203x08x05W	SPRING W/S.M3-L(2JS100-030050)	FC	12

81) 2SA970BL—0	TR 2SA970 BL	FC	10
82) 2SC2240BL—0	TR 2SC2240 BL	FC	4
83) 6003501950—	XPM-900 MAIN PC BOARD T=2oz	FC	1
84) 700033050001	ZENER 3.3v 500mw	FC	6
85) 700075050001	ZENER 7.5V 500mw	FC	1
86) 700120050001	ZENER 12V 500mw	FC	6
87) 700150050001	ZENER 15V 500mw	FC	1
88) 700150100001	ZENER 15V 1W	FC	2
89) 7001N4004051	DIODE 1N4004	FC	6
90) 7001N4148051	DIODE 1N4148	FC	13
91) MCT0A102100J	MYLAR CAP .001u T	FC	2
92) MCT0A153100J	MYLAR CAP .015u T	FC	2
93) MCT0A182100J	MYLAR CAP .0018u T	FC	2
94) MCT0A473100J	MYLAR CAP .047u T	FC	1
95) MPMSC104100J	MSC .1u 100V 5% T	FC	15
96) RC0031010005	RESISTORS 100 ohm 1/4W T	FC	4
97) RC0031020005	RESISTORS 1 K 1/4W T	FC	21
98) RC0031030005	RESISTORS 10 K 1/4W T	FC	16
99) RC0031040005	RESISTORS 100 K 1/4W T	FC	2
100) RC0031050005	RESISTORS 1 M 1/4W T	FC	1
101) RC0031520005	RESISTORS 1.5 K 1/4W T	FC	2
102) RC0032020005	RESISTORS 2 K 1/4W T	FC	3
103) RC0032210005	RESISTORS 220 ohm 1/4W T	FC	2
104) RC0032230005	RESISTORS 22 K 1/4W T	FC	2
105) RC0033030005	RESISTORS 30 K 1/4W T	FC	4
106) RC0033040005	RESISTORS 300 K 1/4W T	FC	2
107) RC0033320005	RESISTORS 3.3 K 1/4W T	FC	4
108) RC0034700005	RESISTORS 47 ohm 1/4W T	FC	4
109) RC0034730005	RESISTORS 47 K 1/4W T	FC	4
110) RC0035110005	RESISTORS 510ohm 1/4W T	FC	4
111) RC0036830005	RESISTORS 68 K 1/4W T	FC	4
112) RC0038210005	RESISTORS 820 ohm 1/4W T	FC	2
113) RC0038220005	RESISTORS 8.2 K 1/4W T	FC	2
114) RC0050A10005	RESISTORS 1 ohm 1/2W T	FC	1
115) RC0053030005	RESISTORS 30 K 1/2W T	FC	2
116) RC0054730005	RESISTORS 47 K 1/2W T	FC	2
117) RM0030K47501	RESISTORS 475 ohm 1/4W T	FC	2
118) RM00310K0001	RESISTORS 10K 1% 1/4W T	FC	8
119) 105006400001	6.4m/m PIN	FC	2
120) 6000680600—	XPM-900 POWER PC BOARD T=oz	FC	1

121) MPMPX473275K	MPX .047u 275VAC 10%	FC	1
122) NTC0120L—	NTC 20A SCK-0120 XPM-900	FC	2
123) RS0500122005	1.2 K 5W SQP TYPE	FC	1
124) W2010G130050	1015#14 BLACK XPM-900U	FC	1
125) W2010G180059	1015#14 WHITE XPM-900U	FC	1
126) FAD012080001	SP802512HL=350m/m+XH	FC	2
127) FH630207D—	FUSE HOLD CQ-207D	FC	1
128) FS630ULC150F	FUSE 6x30 FAST/CERAMIC U/C 15A	FC	1
129) FTSF-006—	PLASTIC FOOT SF-006	FC	4
130) IBXPM900—GI	MANUAL XPM-900 (GEMINI)	FC	1
131) KB1819BL0001	KNOB 18x19 BLACK XPM-900	FC	2
132) NTM8x17x080B	NUT 5/16 (0A0220-310005)	FC	1
133) PB420215—	PLOY BAG 8.5"x16.5"X0.05	FC	1
134) PT160—4	TRANS. 160m/m XPM-1200U 120V	FC	1
135) SPK1047R2001	WIN-1047R2 R/B XPM-900	FC	1
136) SPK1047R2002	WTN-1047R2 B/R XPM-900	FC	1
137) SPKCOVER—1	WIN-1047R2 COVER BLACK XPM-900	FC	1
138) SPKCOVER—2	WIN-1047R2 COVER RED XPM-900	FC	1
139) SR01MS3x042B	MST 3x4 BLACK(1JPH1C-030424)	FC	2
140) SR01MS3x061B	MS 3x6 BLACK(1JBHMC-030604)	FC	10
141) SR01MS3x081W	MS 3x8 (1JPHMC-030800)	FC	1
142) SR01MS3x121B	MS 3x12 BLACK	FC	1
143) SR01MS4x061W	MS 4x6 (PLATING)	FC	1
144) SR01MS4x082B	MST 4x8 BLACK (1JBH1C-040824)	FC	16
145) SR01TP3x063B	TP 3x6 BLACK (1JBHCC-030625)	FC	6
146) SR01TP3x103B	TP 3x10 BLACK (1JBHCC-031024)	FC	4
147) SR03TP4x084B	FMT+W TP 4x8 (1JBP6C-040825)	FC	14
148) SR10MS8x751B	5/16x3" (1ATKMO-31C004)V3000	FC	1
149) SWP—9	R22-22B-11B XPM-900	FC	1
150) VR16A1031501	16K4x1 L-15 XPM-900	FC	2
151) W2010G445100	1015#14 BLACK XPM-900U	FC	1
152) W2010G505109	1015#14 WHITE XPM-900U	FC	1
153) W2010I12510A	1015#18 GR+YL	FC	1
154) W20110120100	1015#14 BLACK XPM-900U	FC	1
155) W5010A370032	2852#26 RED XPM-900	FC	1
156) W5010A460038	2852#26 GRAY XPM-900	FC	1
157) WDGEMINI—	GEMINI WARRANTY CARD	FC	1
158) WS407x03x09Y	EXT TOOTH W/S. 3m/m	FC	1

# Main and Display PCBs

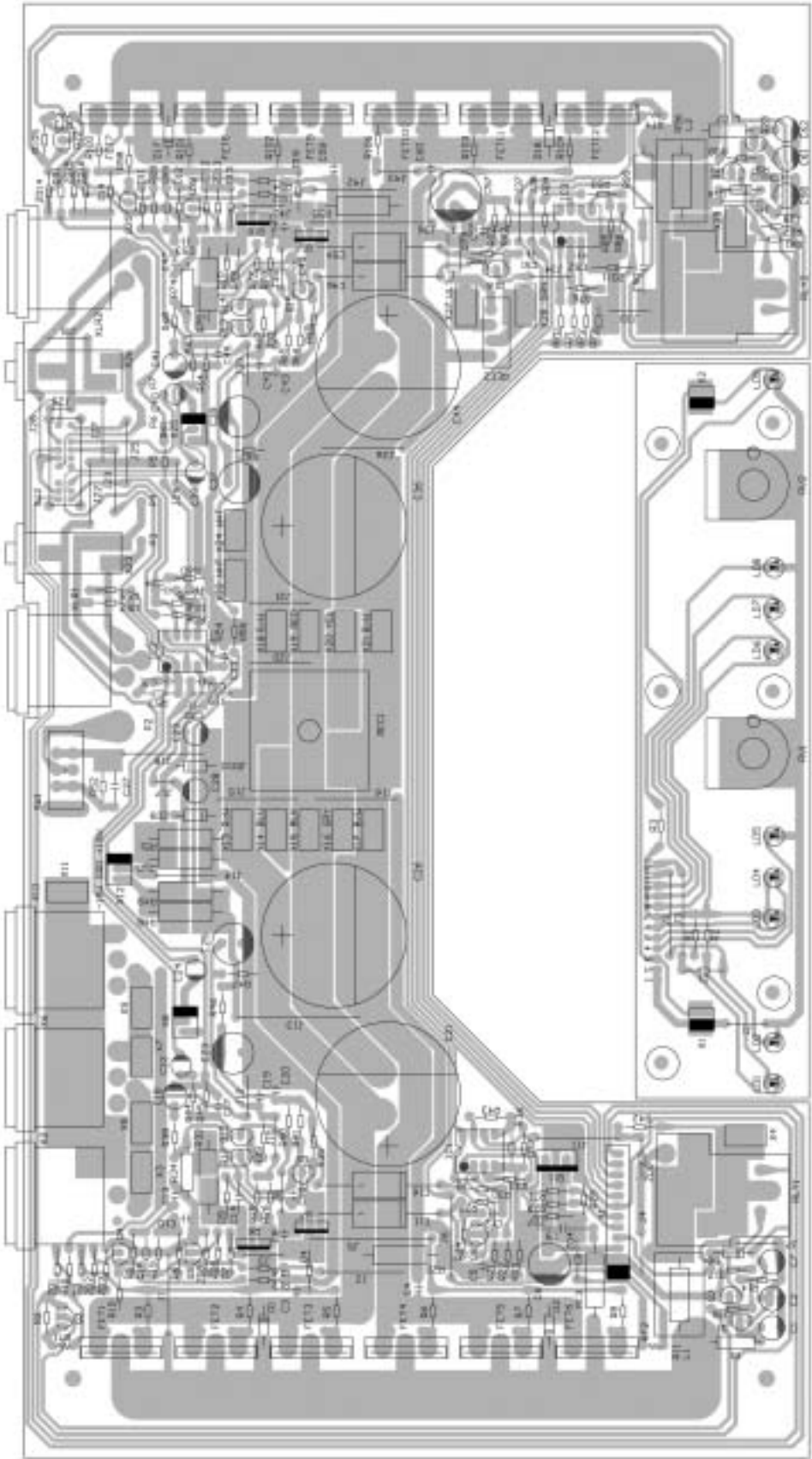

## Power PCB

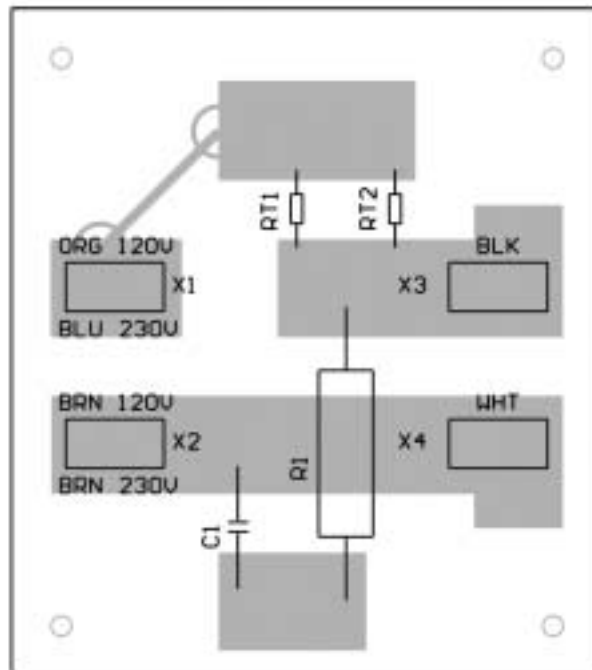



# Schematic

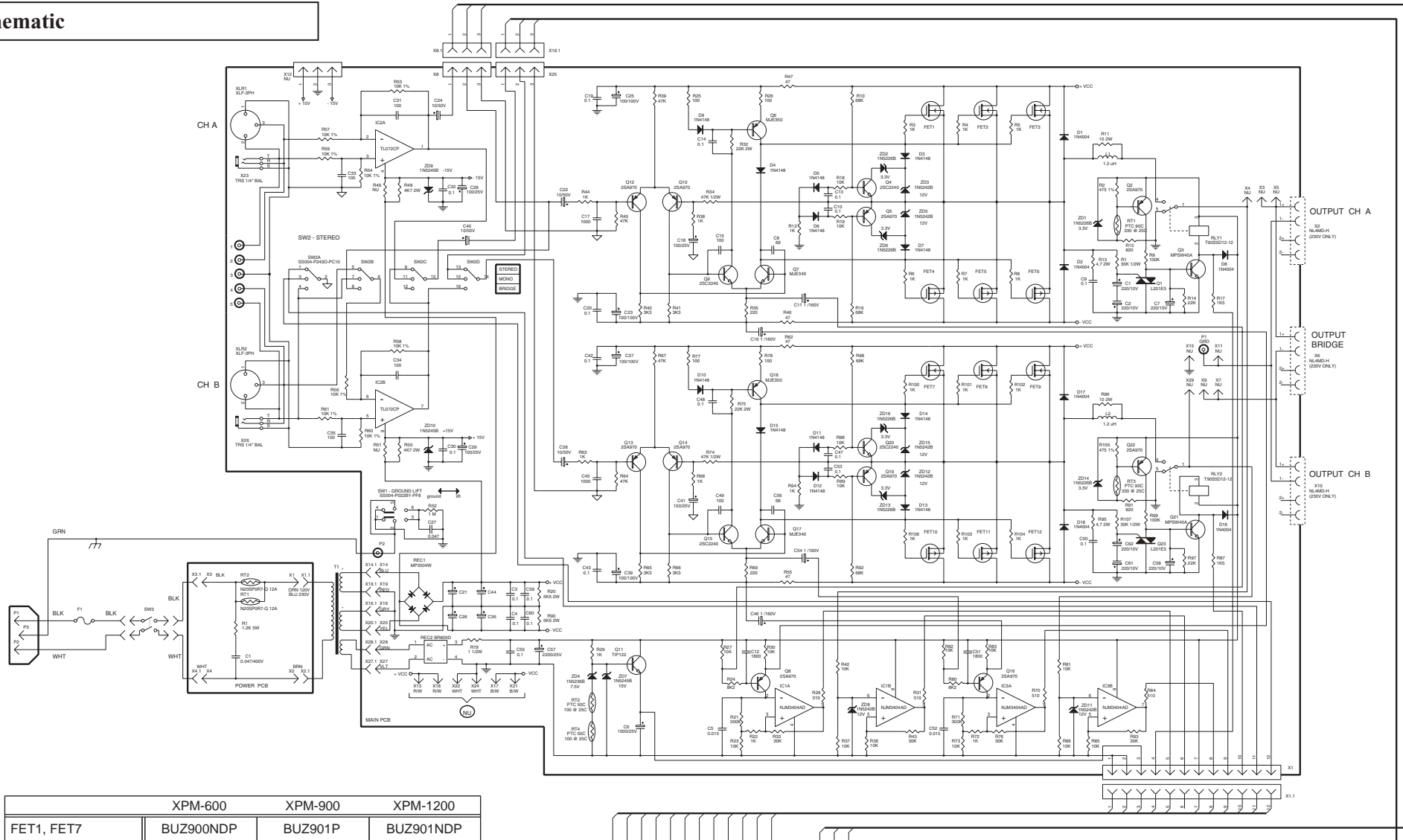

	XPM-600	XPM-900	XPM-1200
FET1, FET7	BUZ900NDP	BUZ901P	BUZ901NDP
FET2, FET8	not used	BUZ901P	not used
FET3, FET9	not used	BUZ901P	BUZ901NDP
FET4, FET10	not used	BUZ906P	not used
FET5, FET11	not used	BUZ906P	BUZ906DP
FET6, FET12	BUZ905DP	BUZ906P	BUZ906DP
C21, C26, C36, C44	4,700μ 100V	6,800μ 100V	6,800μ 100V
F1 / 120Vac	10A	12A	15A
F1 / 230Vac	6.3A	7A	10A
T1 / 120Vac	XPM-600U	XPM-900U	XPM-1200U
T1 / 230Vac	XPM-600E	XPM-900E	XPM-1200E

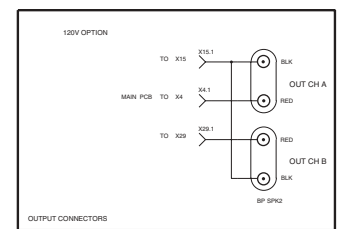
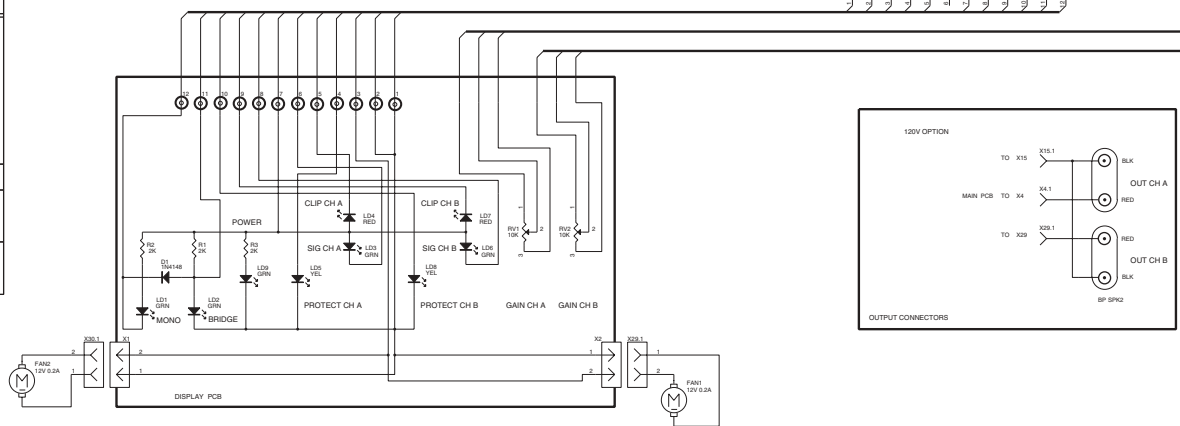



**In the USA: If you experience problems with this unit,  
call 1-732-738-9003 for Gemini Customer Service.**

**Do not attempt to return this equipment to your dealer.**

Parts of the design of this product may be protected by worldwide patents.

Information in this manual is subject to change without notice and does not represent a commitment on the part of the vendor. Gemini Sound Products Corp. shall not be liable for any loss or damage whatsoever arising from the use of information or any error contained in this manual.

No part of this manual may be reproduced, stored in a retrieval system or transmitted, in any form or by any means, electronic, electrical, mechanical, optical, chemical, including photocopying and recording, for any purpose without the express written permission of Gemini Sound Products Corp.

It is recommended that all maintenance and service on this product is performed by Gemini Sound Products Corp. or its authorized agents.

Gemini Sound Products Corp. will not accept liability for loss or damage caused by maintenance or repair performed by unauthorized personnel.

**Worldwide Headquarters • 120 Clover Place, Edison, NJ 08837 • USA  
Tel: (732) 738-9003 • Fax: (732) 738-9006**

France • G.S.L. France • 11, Avenue Leon Harmel, Z.I. Antony, 92160 Antony, France  
Tel: + 33 (0) 1 55 59 04 70 • Fax: + 33 (0) 1 55 59 04 80

Germany • Gemini Sound Products GmbH • Ottostrasse 6, 85757 Karlsfeld, Germany  
Tel: 08131 - 39171-0 • Fax: 08131 - 39171-9

UK • Gemini Sound Products • Unit C4 Hazleton Industrial Estate, Waterlooville, UK P08 9JU  
Tel: 087 087 00880 • Fax: 087 087 00990

Spain • Gemini Sound Products S.A. • Rosello, 516, Barcelona, Spain, 08026  
Tel: 349-3435-0814 • Fax: 3493-347-6961