

Montageanleitung für Transistoren / MOUNTING INSTRUCTIONS FOR TRANSISTORS /
 INSTRUCTIONS DE MONTAGE POUR LES TRANSISTORS / ISTRUZIONI DI MONTAGGIO PER I TRANSISTORI

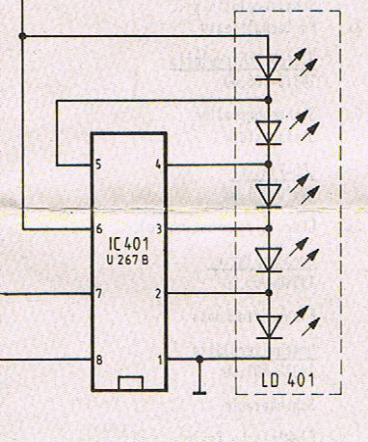
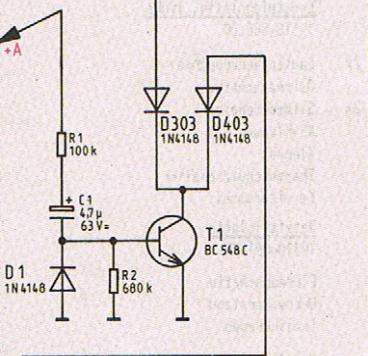
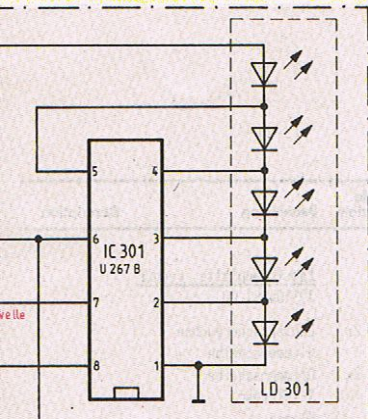

Änderungen vorbehalten
 ALTERATIONS / RESERVES
 MODIFICAZIONI / RISERVA DI MODIFICA

T114 / T214	9654 - 393.97
T115 / T215	9654 - 394.97
T116 / T216	9654 - 394.25
T117 / T217	9654 - 398.97
T109 / T209	9654 - 264.97
T108 / T208	9654 - 264.97

D101 / D201	9654 - 124.011021
D103 / D203	9654 - 172.97
D106 / D206	9654 - 172.97
D107 / D207	9654 - 172.97
D804 / D805	9654 - 370.97
D806 / D807	9654 - 370.97
D302 / D402	9654 - 303.97

SANS INDICATION CONTRAIRE LES VALEURS DE TENSION SONT MESUREES PAR
 RAPPORT AU CHASSIS A L'AIDE D'UN MILLIVOLTMETRE GRUNDIG (R1=10MΩ)
 ES VALEURS MESUREES SONT VALABLES POUR UNE TENSION SECTEUR NOMINALE
 EN ETAT NON-ECHAUFFE SANS SIGNAL A (1kHz) ET A UNE TEMPERATURE
 AMBIANTE DE 20°C

TENSIONS: BF

TENSIONI: MISURATE CON VOLTMETRO GRUNDIG (R1=10MΩ) VERSO MASSA, SALVO ALTRE
 INDICAZIONI

VALORI DI MISURA VALGONO PER UNA TENSIONE NOMINALE RILEVATA A
 FREDDO SENZA SEGNALE AD (1kHz) E AD UNA TEMPERATURA AMBIENTE DI 20°C

TENSIONI: BF

T116 / T117 / T216 / T217

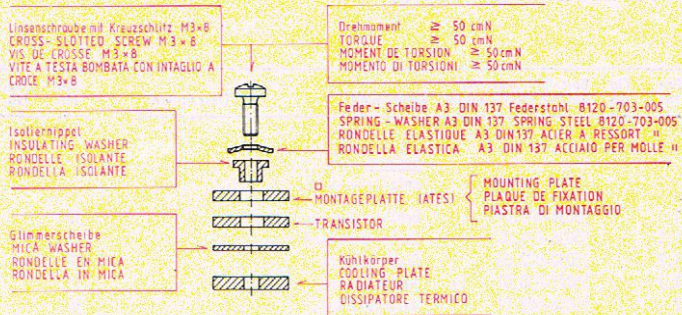

T114 / T115 / T214 / T215 / T113 / T211 / T904

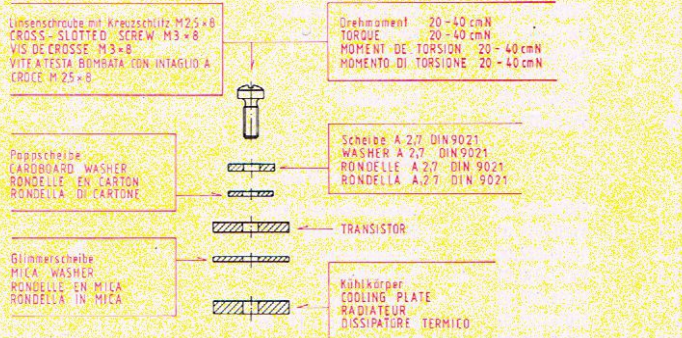

Achtung: Glimmerscheibe beidseitig mit Silikonfett P12 bestreichen (Wacker-Chemie-München)
 IMPORTANT: SLICKER MICA WASHER AT BOTH SIDES WITH SILICONE GREASE P12 (WACKER-CHEMIE MÜNCHEN)
 ATTENZIONE: LA RONDELLA IN MICA VA SPALMATA DA AMBO LE PARTI DI GRASSO AL SILICONE P12
 (WACKER - CHEMIE MÜNCHEN)

⚠️ Beweiszichtete Bauteile: Aus Sicherheitsgründen nur durch Originalbauteile ersetzen
 MARKED COMPONENTS: FOR SAFETY REASONS, REPLACE THESE COMPONENTS BY ORIGINAL COMPONENTS ONLY!
 COMPOSANTS REPRES: POUR DES RAISONS DE SECURITE, NE REMPLACER CES COMPOSANTS QUE PAR DES
 COMPOSANTS ORIGINAUX!
 I COMPONENTI CONTRASSEGNAI CON QUESTO SIMBOLO SONO DA SOSTITUIRE PER MOTIVI DI SICUREZZA SOLTANTO
 CON I PEZZI DI RICAMBIO ORIGINALI!

- * Abstand Widerstandskörper zur Druckplatte: 8mm
 DISTANCE OF RESISTANCE TO PRINTED BOARD: 8mm
 DISTANCE ENTRA RESISTANZA E PIASTRA IMPRINTA: 8mm
 DISTANZA TRA RESISTENZA E PIASTRA STAMPATA: 8mm
- Abstand Widerstandskörper zur Druckplatte: 6mm
- ⊗ Abstand Widerstandskörper zur Druckplatte: 12mm

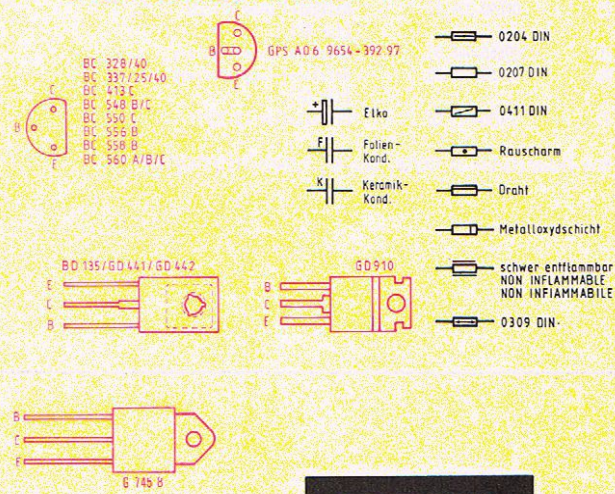

MA 100
 MA 100 GB
 MA 100 U
 (55036-906.00)

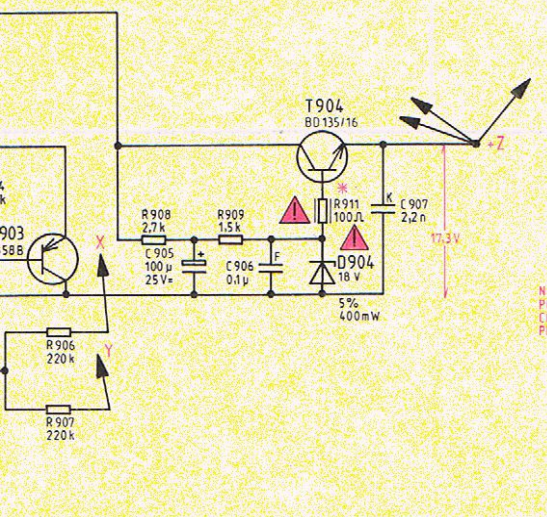
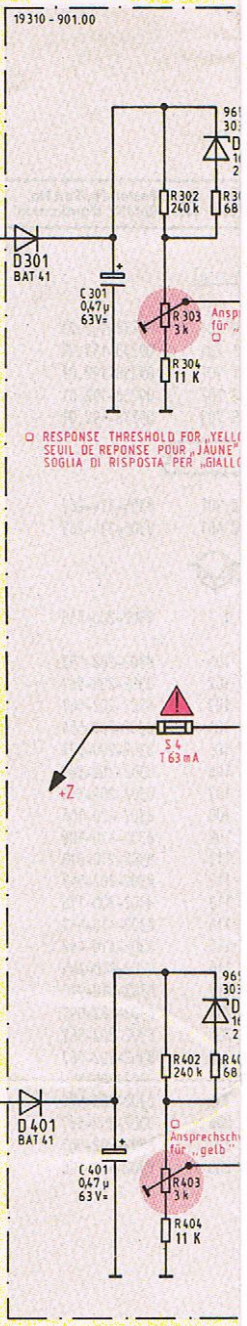
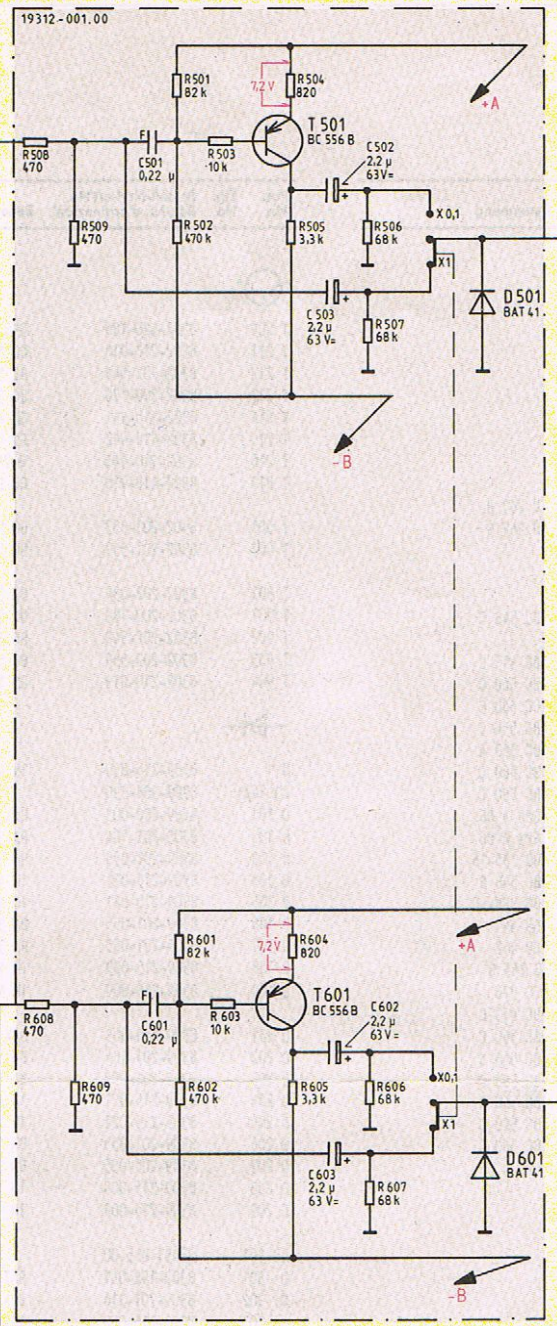
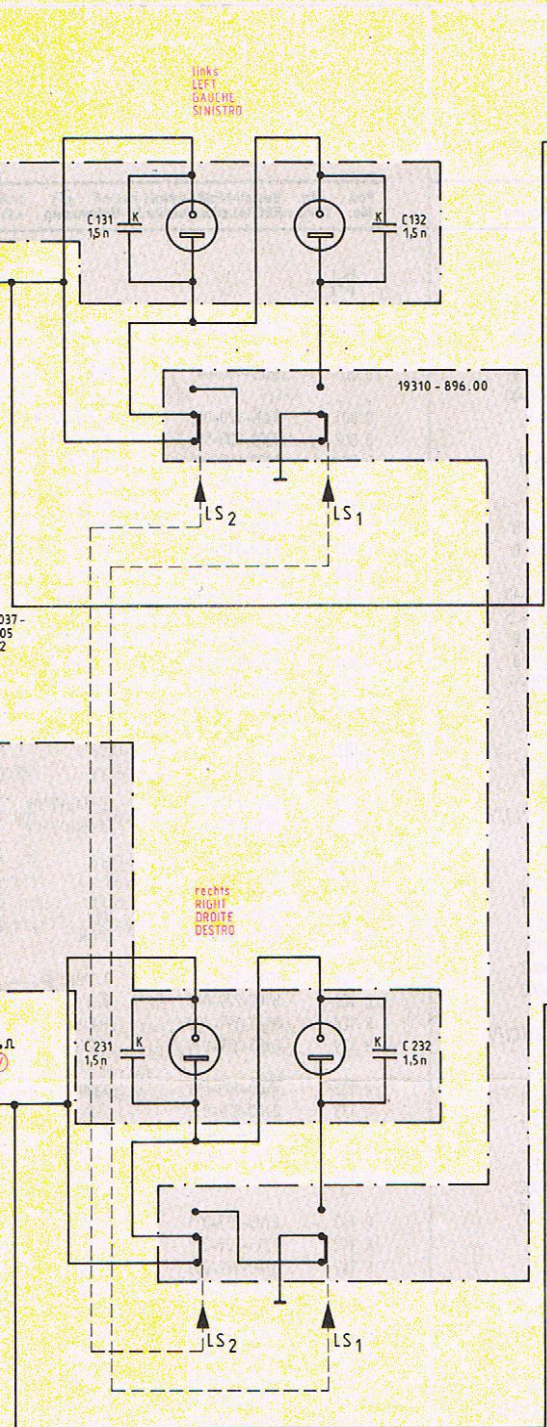

Plattenstromeinstellung mit R136,236 bei Nennspannung ohne RL
 Spannungsabfall von X nach Y auf 30mV ±10% einstellen

CLOSED-CIRCUIT ADJUSTMENT WITH R136,236 AT NOMINAL VOLTAGE W
 ADJUST VOLTAGE DROP FROM X TO Y FOR 30mV ±10%

REGLEGE DE COURANT DE REPOS AVEC R136,236 A TENSION NOMINALE
 REGLER LA CHUTE DE TENSION ENTRE X ET Y SUR 30mV ±10%

REGOLAZIONE CORRENTE RIPOSO CON R136,236 A TENSIONE NOMINALE S
 REGOLARE LA CADUTA DI TENSIONE DA X A Y SU 30mV ±10%

Spannungen mit Grundig-Millivoltmeter (Ri=10MΩ), falls nicht anders
 angegeben, gegen Masse gemessen
 Meßwerte gelten bei Nennspannung und im inoffiziell warmen
 Zustand ohne Signal bei (1kHz) bei 20°C Raumtemperatur.
 (NF - Spannungen)

VOLTAGES MEASURED WITH GRUNDIG MILLIVOLTMETER (Ri=10MΩ)
 AGAINST CHASSIS UNLESS OTHERWISE STATED.
 ALL MEASURED VALUES ARE VALID FOR NOMINAL VOLTAGE,
 INSTRUMENT NOT WARMED UP, NO SIGNAL APPLIED AT (1kHz) AT
 ROOM TEMPERATURE
 (AF - VOLTAGES)

131, 231,	905,	906,	907, 232, 132,	501, 601,	602, 603,	502, 503,	301, 401,
906, 907,	908,	909,	911,	508, 509, 608, 609,	601, 501, 602, 502,	503, 604, 504, 605, 505,	403, 302, 304, 405, 404, 303, 402, 305,

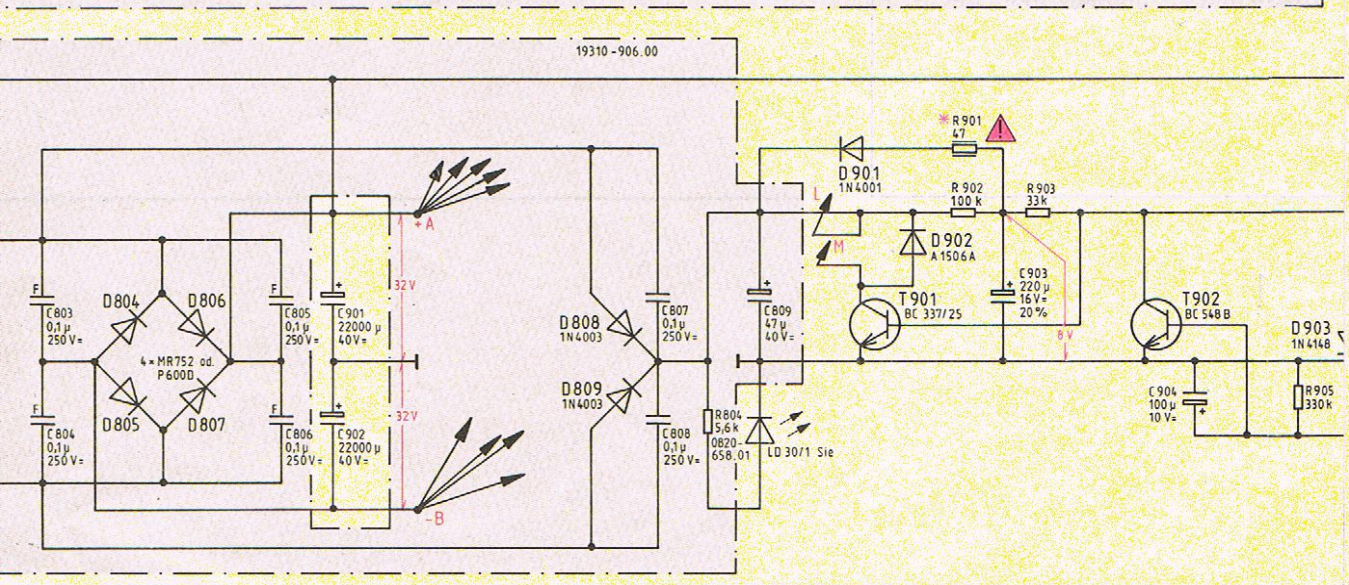
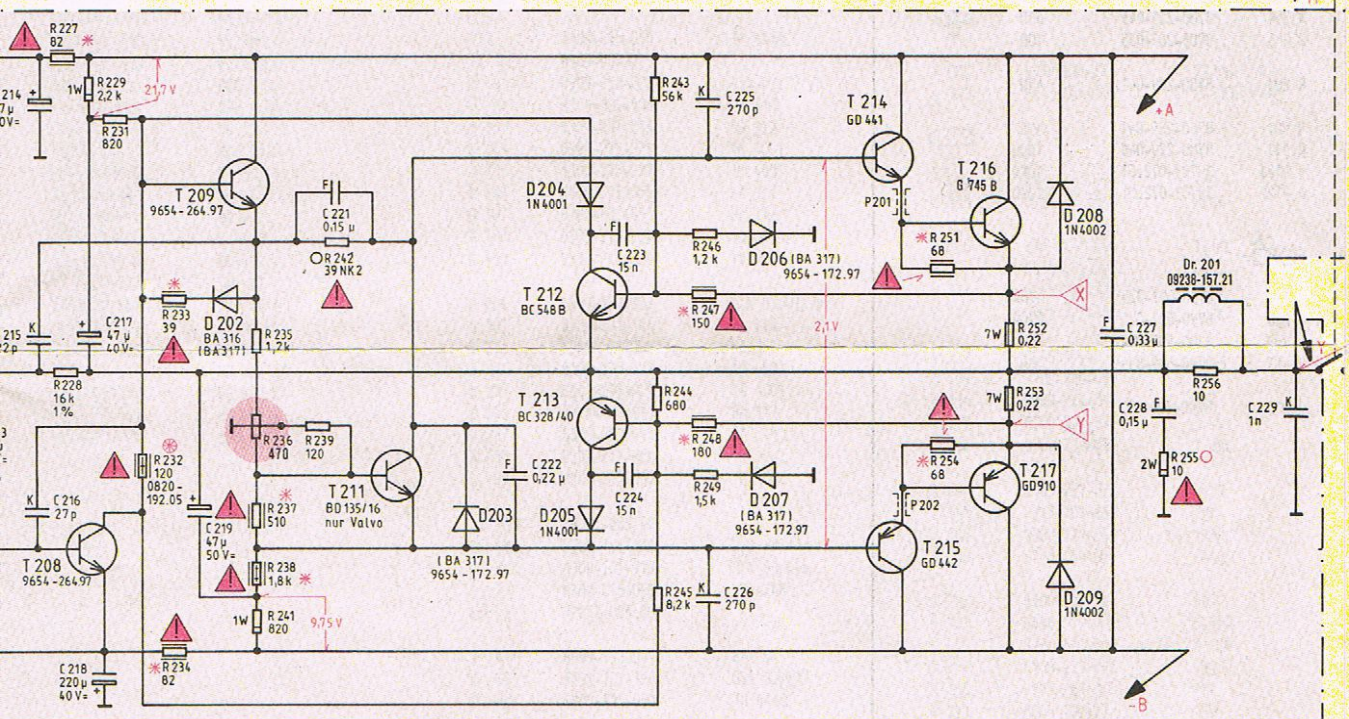
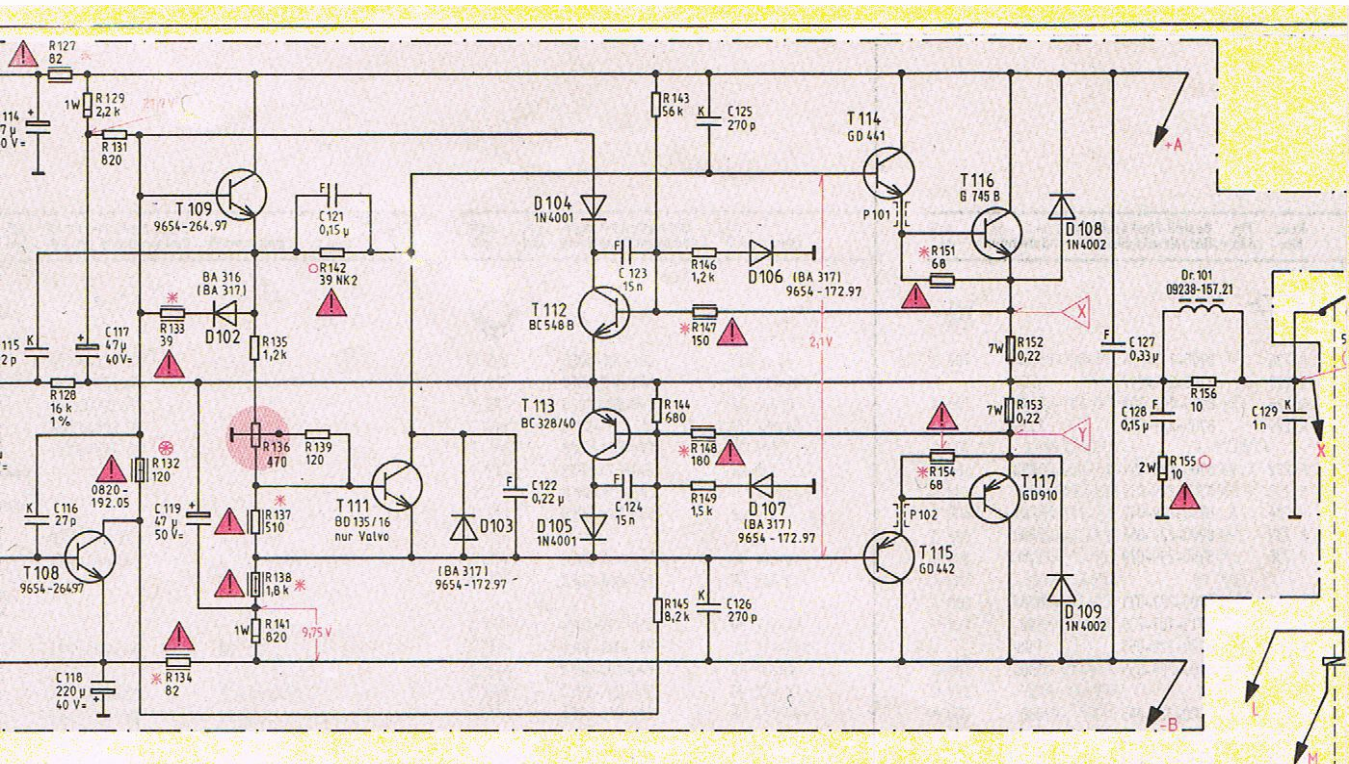

114, 214, 803, 115, 116, 117, 217, 218, 804, 215, 216, 118, 218,	119, 219, 805, 806, 901, 121, 902, 221,	122, 222,	124, 123, 807, 224, 223, 808,	125, 225, 809, 126, 226,	903,	127, 128, 904, 227, 228,	129, 229,
127, 227, 129, 131, 132, 133, 134, 128, 228, 229, 231, 232, 233, 234,	235, 135, 137, 237, 141, 139, 142, 236, 136, 138, 238, 241, 239, 242,		247, 143, 243, 804, 245, 147, 149, 249, 246, 144, 244, 145, 146, 148, 248,		151, 901, 251, 152, 903, 252, 154, 902, 254, 153, 253,	155, 156, 255, 256,	905,

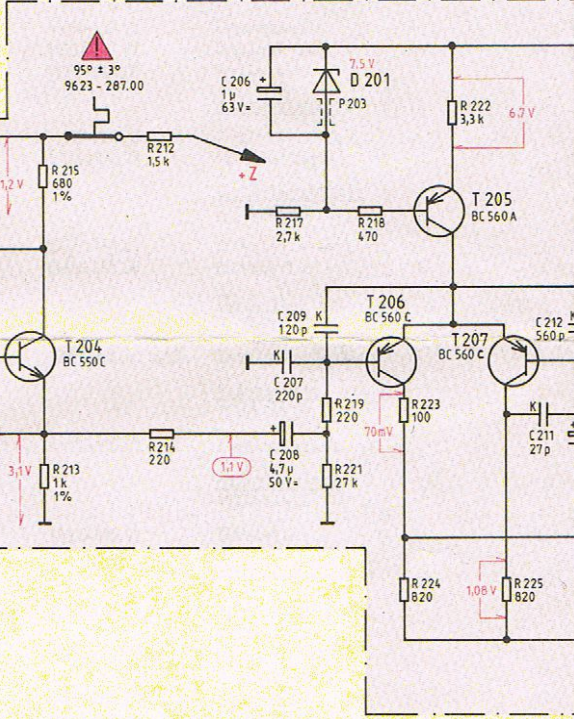
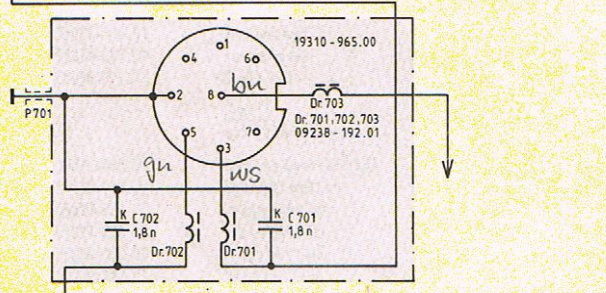
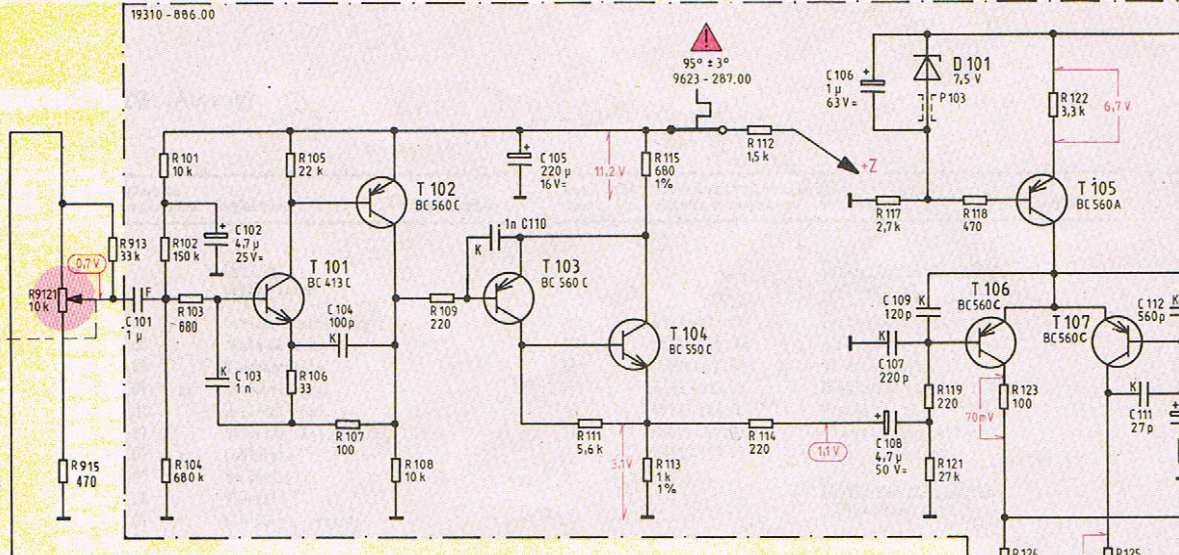

Potentiometer
LEVEL CONTROL
REGLAGE DE
NIVEAU
REGOLATORE
DI LIVELLO

Kanalgleichheit
CHANNEL
UNIFORMITY
EQUILIBRE DE
CANAUX
EQUILIBRIO DEI CANALI

P 101, 102, 201, 202 09647 - 002.97
P 103, 203 09647 - 022.97

Ferritperlen lackiert
FERRITE BEADS LACQUERED
PERLES FERRITES LAQUEES
PERLE DI FERRITE VERNICIATE (ISOLATE)

P 701 09647 - 021.97

[GB: 240 V ~]
U: 120 V AC

220 V ~
50/60 Hz
240 W bei Nennleistung
WITH NORMAL OUTPUT
AVEC PUISSANCE NOMINALE
CON POTENZA NOMINALE

ca. 19 W ohne Signal
WITHOUT SIGNAL
SENS SIGNAL
SENZA SEGNALE

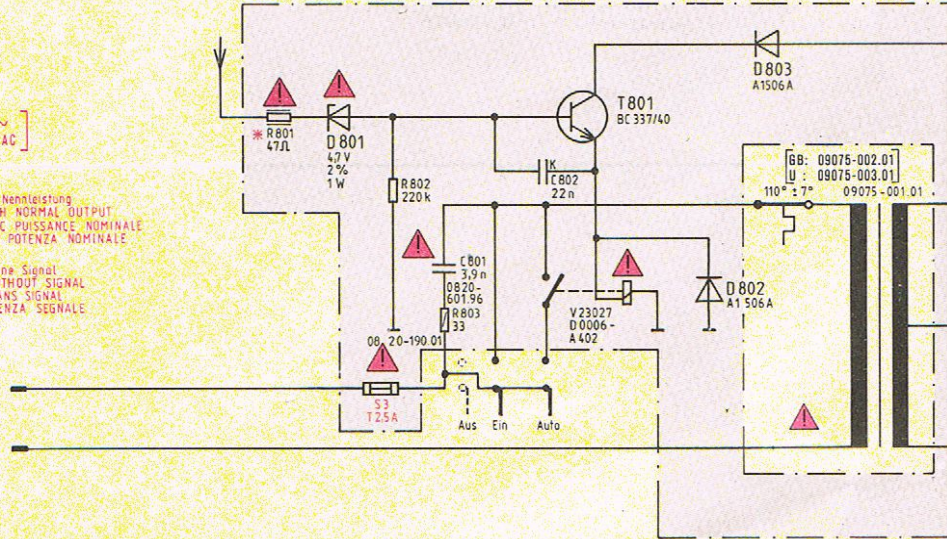

C	702, 201, 101,	202, 102, 203, 103,	701,	104, 204,	110, 210,	105, 205,	601,	802,	106, 107, 207, 109, 206, 108, 208, 209,	111, 211,				
R	916, 912, 913, 914, 104, 101, 201, 103,	205, 105, 207,	107, 207,	108, 208,	109, 209,	801,	111, 211,	802, 113, 213,	115, 803, 215, 212, 113, 213,	112, 214, 114,	117, 217,	119, 219, 118, 123, 223, 121, 221,	122, 222,	125, 225,

Ersatzteilliste (Auszug)

Pos. No.	Fig. No.	Bestell-Nr./Part No. Réf./Nr. d'ordinazioni	Benennung	Description	Pos. No.	Fig. No.	Bestell-Nr./Part No. Réf./Nr. d'ordinazioni	Benennung	Description	P
			<u>Gehäuse</u> metallfinish					<u>Endstufenplatte, rechts</u> 19310-881.00		
1		55036-005.01	Gehäuse-Oberteil kpl.		30		09626-878.01	2x Lautsprecherbuchse		
1.1		55036-034.00	Skala-Abdeckung		31		55036-026.00	Glimmerscheibe		
1.2		55030-022.00	Diodescheibe		32		09604-997.00	2x Glimmerscheibe		
1.3		55027-030.01	6x Tastenführung		35		59751-003.00	NF-Klammer		
2		55036-007.01	Unterteil kpl.		36		09623-260.00	Klemme		
2		55036-107.01	Unterteil kpl.(für GB)		37		09623-287.00	Thermoschutzschalter		
2.1		09667-007.01	4x Fußleiste		38		09238-157.21	Ferritdrossel		
3		55036-022.00	Vorderteil							
4		55036-021.00	Rückteil					<u>Endstufenplatte, links</u> 19310-886.00		
5		55036-011.01	Kühlkörper rechts							
6		55036-012.01	Kühlkörper links		40		09626-879.02	2x Lautsprecherbuchse		
7		09670-938.01	Drehknopf		41		55036-026.00	Glimmerscheibe		
8		55027-034.01	Tastenkноп		42		09604-997.00	2x Glimmerscheibe		
9		55036-037.01	Tastenkноп		45		59751-003.00	NF-Klammer		
10		55036-073.01	Skala kpl.		46		09623-260.00	Klemme		
			<u>Gehäuse</u> metallfinish-braun		47		09623-287.00	Thermoschutzschalter		
					48		09238-157.21	Ferritdrossel		
1		55036-005.02	Gehäuse-Oberteil kpl.					<u>Netzteilplatte</u> 19310-891.00		
1.1		55036-034.00	Skala-Abdeckung							
1.2		55030-022.00	Diodescheibe		60		50016-158.00	Elkomanschette		
1.3		55027-030.01	6x Tastenführung		61		19703-072.01	Drehwiderstand		
2		55036-007.02	Unterteil kpl.		62		55036-036.00	Isolierkappe		
2		55036-107.02	Unterteil kpl. (f. GB)					<u>Schalterplatte</u>		
2.1		09667-007.02	4x Fußleiste							
3		55036-022.00	Vorderteil		70		19310-896.00	Schalterplatte kpl.		
4		55036-021.00	Rückteil		70.1		19400-091.03	2x Fortschalttaste		
5		55036-011.01	Kühlkörper, rechts					<u>Gleichrichterplatte</u> 19310-906.00		
6		55036-012.01	Kühlkörper, links							
7		09670-938.02	Drehknopf							
8		55027-034.02	3x Tastenkноп		75		09621-113.03	6x Sicherungshalter		
9		55036-037.02	3x Tastenkноп		76		09666-489.00	Distanzstück		
10		55036-073.02	Skala kpl.					<u>LED-Platte</u> 19310-901.00		
			<u>Mechanische Teile</u>							
			<u>Chassis</u>		80		32051-085.00	2x Leuchtdiodenfassung kpl.		
20		09075-001.01	NETZTRAFO					<u>Buchsenplatte</u> 19310-965.00		
20		09075-002.01	Netztrafo (f. GB)							
20		09075-003.01	Netztrafo (f. U)							
21		09623-121.97	Thermoschalter		85		09623-218.01	Flanschsteckdose		
22		19400-080.02	Schiebetaste 3-fach					<u>Umschalterplatte</u> 19312-001.00		
23		55036-032.00	2x Abdeckung							
25		09690-434.11	Netzkabel m. Flachstecker							
25		09690-374.97	Netzkabel ohne Stecker (für GB)		90		19400-095.97	Schiebetaste		
26		09666-446.00	Netzkabel-Zugentlastung					<u>Elektrische Teile</u>		
26		09666-447.00	Netzkabel-Zugentlastung (für GB)				8312-001-311	Relais V 23037/ A 0005-A 402		
27		55030-023.00	Diodenhalter LD 30/1				8312-001-277	Relais V 23027/ D 0006-A 402		
			Mini-Endverstärker MA 100/GB, Sach-Nr. 9.55036-1147/2147/1167				09647-002.97	4x Ferritperle		
							09647-021.91	Ferritperle		
							09647-022.97	2x Ferritperle		
							09218-154.97	Ferritdrossel		

Fig. No. Bestell-Nr./Part No. Ref./Nr. d'ordinazioni Benennung

Pos. No. Fig. No. Bestell-Nr./Part No. Ref./Nr. d'ordinazioni Benennung

Pos. No. Fig. No. Bestell-Nr./Part No. Ref./Nr. d'ordinazioni Benennung

09238-157.21
09238-157.21
09238-192.01
09238-192.01
09238-192.01

8305-314-267 U 267 B
8305-314-267 U 267 B

8302-200-548 BC 548 C

8302-202-093 BC 413 C
8302-202-567 BC 560 C
8302-202-567 BC 560 C
8302-200-554 BC 550 C
8302-200-571 BC 560 A
8302-202-567 BC 560 C
8302-202-567 BC 560 C
8302-420-106 GPS A 06
8302-420-106 GPS A 06
8302-210-018 BD 135-16
8302-202-543 BC 548 B
8302-200-176 BC 328-40
8302-410-441 GD 441
8302-410-442 GD 442
8302-210-745 G 745 B
8302-410-910 GD 910
8302-202-093 BC 413 C
8302-202-567 BC 560 C
8302-202-567 BC 560 C
8302-200-554 BC 550 C
8302-200-571 BC 560 A
8302-202-567 BC 560 C
8302-202-567 BC 560 C
8302-420-106 GPS A 06



T 209 8302-420-106 GPS A 06
T 211 8302-210-018 BD 135-16
T 212 8302-202-543 BC 548 B
T 213 8302-200-176 BC 328-40
T 214 8302-410-441 GD 441
T 215 8302-410-442 GD 442
T 216 8302-210-745 G 745 B
T 217 8302-410-910 GD 910

T 501 8302-201-557 BC 556 B
T 601 8302-201-557 BC 556 B

T 801 8302-202-039 BC 337-40
T 901 8302-200-188 BC 337-25
T 902 8302-202-543 BC 548 B
T 903 8302-200-559 BC 558 B
T 904 8302-210-013 BD 135-16



D 1 8309-215-050 1N 4148
LD 30/1 8309-908-030
D 101 8309-650-003 BZX 83/C7/V5
D 102 8309-201-104 BA 316
D 103 8309-201-055 BA 317
D 104 8309-215-021 1N 4001
D 105 8309-215-021 1N 4001
D 106 8309-201-055 BA 317
D 107 8309-201-055 BA 317
D 108 8309-215-009 1N 4002
D 109 8309-215-009 1N 4002

D 201 8309-650-003 BZX 83/C7/V5
D 202 8309-201-104 BA 316
D 203 8309-201-055 BA 317
D 204 8309-215-021 1N 4001
D 205 8309-215-021 1N 4001
D 206 8309-201-055 BA 317
D 207 8309-201-055 BA 317
D 208 8309-215-009 1N 4002
D 209 8309-215-009 1N 4002

LD 301 32051-085.00
D 301 8309-198-041 BAT 41
D 302 8309-701-316 BZX 83/B16
D 303 8309-215-050 1N 4148
LD 304 32051-085.00

D 401 8309-198-041 BAT 41
D 402 8309-701-316 BZX 83/B16
D 403 8309-215-050 1N 4148



D 501 8309-198-041 BAT 41

D 601 8309-198-041 BAT 41

D 801 8309-720-047 4,7V/2%/1W
D 802 8309-000-506 A 1506 A
D 803 8309-000-506 A 1506 A
D 804 8309-712-752 MR 752
D 805 8309-712-752 MR 752
D 806 8309-712-752 MR 752
D 807 8309-712-752 MR 752
D 808 8309-215-030 1N 4003
D 809 8309-215-030 1N 4003

D 901 8309-215-021 1N 4001
D 902 8309-000-506 A 1506 A
D 903 8309-215-050 1N 4148
D 904 8309-701-120 BZX 83/C18



C 901 8410-001-125 22000µF/40V
C 902 8410-001-125 22000µF/40V



R 113 8765-197-273 1KΩ
R 115 8765-197-269 680Ω

R 126 8765-197-274 1,1KΩ
R 127 8700-229-047 82Ω
R 128 8765-197-302 15KΩ
R 129 8705-227-081 2,2KΩ

R 132 8700-195-051 120Ω
R 133 8700-229-039 39Ω
R 134 8700-229-047 82Ω
R 137 8700-229-066 510Ω
R 138 8700-239-079 1,8KΩ

R 141 8705-227-071 820Ω
R 142 8713-101-239 39Ω
R 147 8700-229-053 150Ω
R 148 8700-229-055 130Ω

R 151 8700-229-045 68Ω
R 152 8730-172-003 0,22Ω
R 153 8730-172-003 0,22Ω
R 154 8700-229-045 68Ω
R 155 8705-262-025 10Ω
R 213 8765-197-273 1KΩ
R 215 8765-197-269 680Ω

Pos. No.	Fig. No.	Bestell-Nr./Part No. Réf./Nr. d'ordinazioni	Benennung
----------	----------	--	-----------



R 226	8765-197-274	1,1KΩ
R 227	8700-229-047	82Ω
R 228	8765-197-302	16KΩ
R 229	8705-227-081	2,2KΩ
R 232	8700-195-051	120Ω
R 233	8700-229-039	39Ω
R 234	8700-229-047	82Ω
R 237	8700-229-066	510Ω
R 238	8700-239-079	1,8KΩ
R 241	8705-227-071	820Ω
R 242	8713-101-239	39Ω
R 247	8700-229-053	150Ω
R 248	8700-229-055	130Ω
R 251	8700-229-045	68Ω
R 252	8730-172-003	0,22Ω
R 253	8730-172-003	0,22Ω
R 254	8700-229-045	68Ω
R 255	8705-262-025	10Ω
R 801	8700-229-041	47Ω
R 901	8700-229-041	47Ω
R 911	8700-229-049	100Ω
R 9121	19703-072.01	10KΩ
R 9122	19703-072.01	10KΩ



R 136	8790-697-025	470Ω
R 236	8790-697-025	470Ω
R 303	8790-509-044	3KΩ
R 403	8790-509-044	3KΩ
R 917	8790-209-035	1KΩ