

Spannungen gemessen mit Grund  
Réglage du potentiomètre W 3 sans signal.  
Tension mesurée avec le réglage sur 1000 Hz.  
Tension mesurée sans signal.  
Tension mesurée avec le réglage sur 1000 Hz.  
Tension mesurée sans signal.  
Tension mesurée avec le réglage sur 1000 Hz.

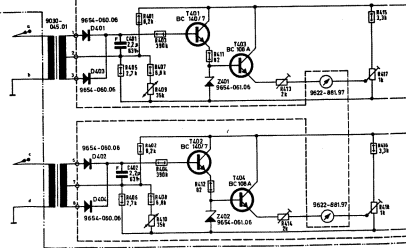

Änderungen vorbehalten      ALTERATIONS RESERVED      MODIFICATIONS RÉSERVÉES

Ref.	Designation	Value	Ref.	Designation	Value
1	...	...	101	...	...
2	...	...	102	...	...
3	...	...	103	...	...
4	...	...	104	...	...
5	...	...	105	...	...
6	...	...	106	...	...
7	...	...	107	...	...
8	...	...	108	...	...
9	...	...	109	...	...
10	...	...	110	...	...
11	...	...	111	...	...
12	...	...	112	...	...
13	...	...	113	...	...
14	...	...	114	...	...
15	...	...	115	...	...
16	...	...	116	...	...
17	...	...	117	...	...
18	...	...	118	...	...
19	...	...	119	...	...
20	...	...	120	...	...
21	...	...	121	...	...
22	...	...	122	...	...
23	...	...	123	...	...
24	...	...	124	...	...
25	...	...	125	...	...
26	...	...	126	...	...
27	...	...	127	...	...
28	...	...	128	...	...
29	...	...	129	...	...
30	...	...	130	...	...
31	...	...	131	...	...
32	...	...	132	...	...
33	...	...	133	...	...
34	...	...	134	...	...
35	...	...	135	...	...
36	...	...	136	...	...
37	...	...	137	...	...
38	...	...	138	...	...
39	...	...	139	...	...
40	...	...	140	...	...
41	...	...	141	...	...
42	...	...	142	...	...
43	...	...	143	...	...
44	...	...	144	...	...
45	...	...	145	...	...
46	...	...	146	...	...
47	...	...	147	...	...
48	...	...	148	...	...
49	...	...	149	...	...
50	...	...	150	...	...



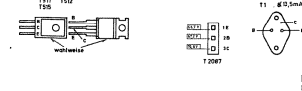
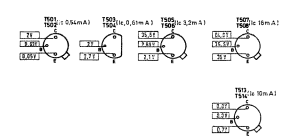
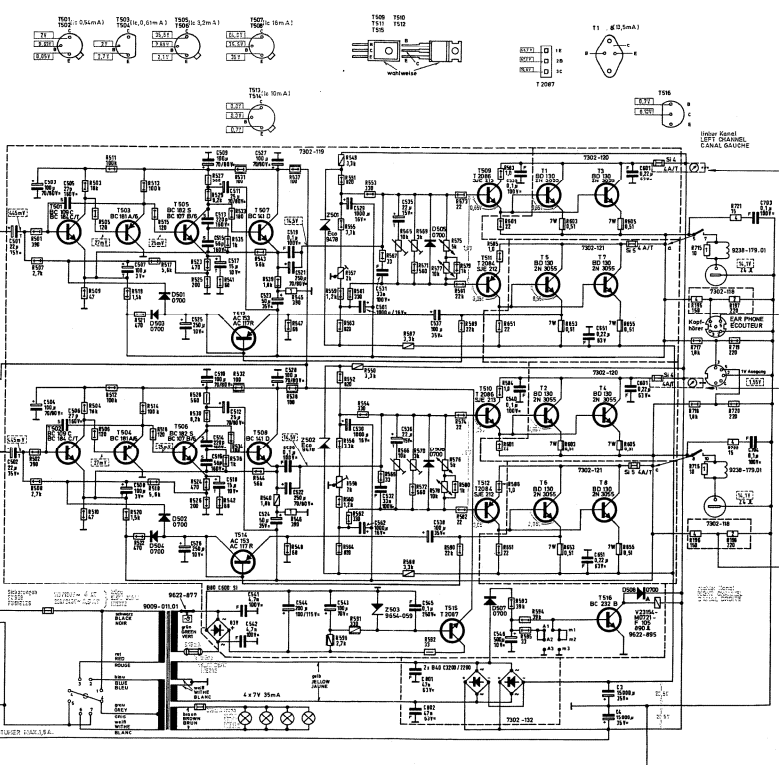

Reduzieren Sie die Leistung auf 10 Watt, wenn Sie nur einen Lautsprecher anschließen wollen. Reduzieren Sie die Leistung auf 5 Watt, wenn Sie nur einen Lautsprecher anschließen wollen. Reduzieren Sie die Leistung auf 2,5 Watt, wenn Sie nur einen Lautsprecher anschließen wollen. Reduzieren Sie die Leistung auf 1,25 Watt, wenn Sie nur einen Lautsprecher anschließen wollen. Reduzieren Sie die Leistung auf 0,625 Watt, wenn Sie nur einen Lautsprecher anschließen wollen.

Informational text in German, English, and French regarding the amplifier's features and usage instructions.

GRUNDIG WERKE GMBH FURTH (BAY.)

Hi-Fi-Stereo-Verstärker  
SV 140 + 200

(19-8009-000)

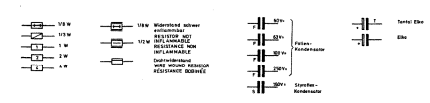

6X4	6X5	6X6	6X8	6X4	6X5	6X6	6X8	6X4	6X5	6X6	6X8	6X4	6X5	6X6	6X8	6X4	6X5	6X6	6X8
10W	15W	20W	25W	30W	35W	40W	45W	50W	10W	15W	20W	25W	30W	35W	40W	45W	50W	10W	15W

Endverstärkerplatte, auf die Lötseite gesehen

OUTPUT STAGE PRINTED CIRCUIT, SOLDER SIDE

PLAQUE DES ETAGES DE SORTIE, VUE COTE SOLDERIES

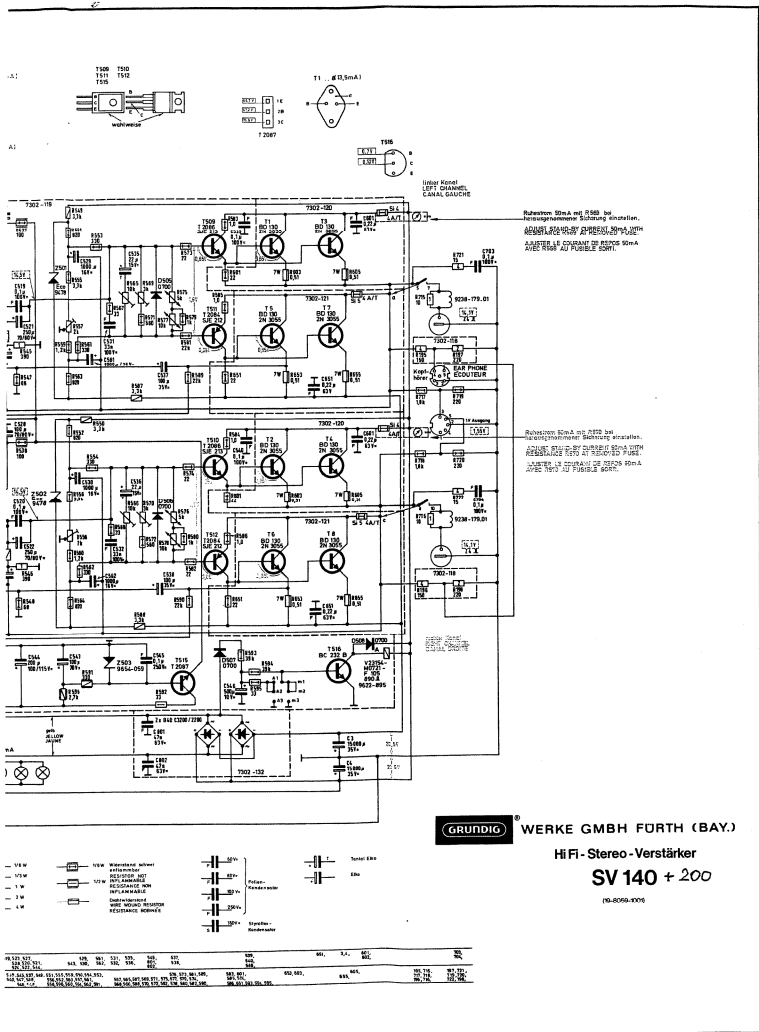
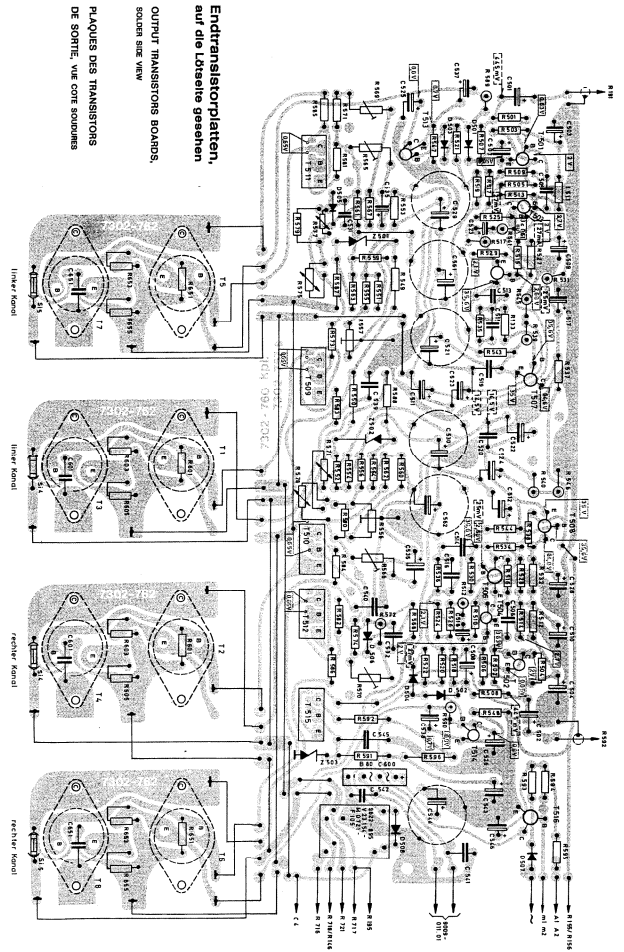

**Verstärkerplatte I**  
auf die Lötseite gesehen

AMPLIFIER BOARD I, SOLDER SIDE  
PLAQUE AMPLIFICATEUR I, VUE COTE SOUDURES

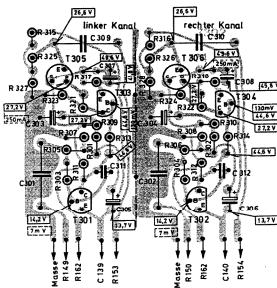

**Verstärkerplatte II**  
auf die Lötseite gesehen

AMPLIFIER BOARD II, SOLDER SIDE  
PLAQUE AMPLIFICATEUR II, VUE COTE SOUDURES

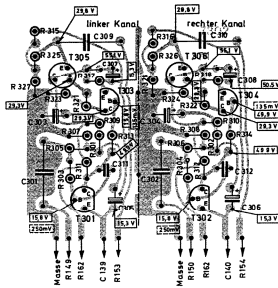

**Verstärkerplatte III**  
auf die Lötseite gesehen

AMPLIFIER BOARD III, SOLDER SIDE  
PLAQUE AMPLIFICATEUR III, VUE COTE SOUDURES

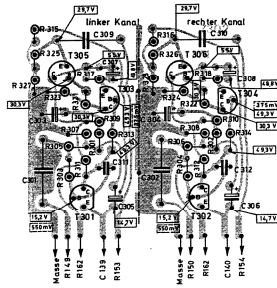

**Reglerplatte, auf die Bestückungsseite gesehen** CONTROL BOARD (VIEW FROM COMPONENT SIDE)

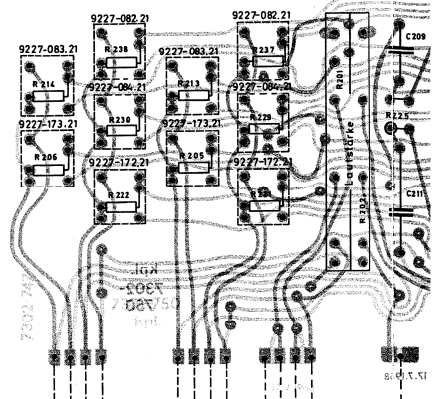

**Vorverstärkerplatte, auf die Lötseite gesehen**

PREAMPLIFIER BOARD, SOLDER SIDE  
PLAQUE DES ETAGES PREAMPLIS, VUE COTE SOUDURES

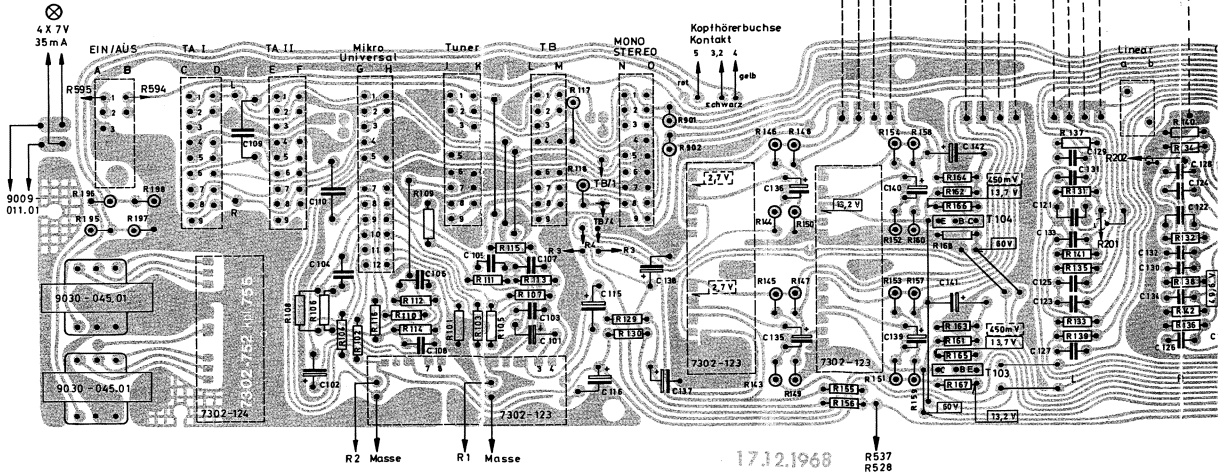

**Verstärkerplatte III  
auf die Lötseite gesehen**

AMPLIFIER BOARD III, SOLDER SIDE  
PLAQUE AMPLIFICATEUR III, VUE COTE SOUDURES

UOURES

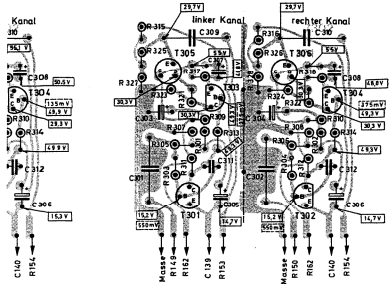

BOARD, SOLDER SIDE  
TAGES PREAMPLIS, VUE COTE SOUDURES

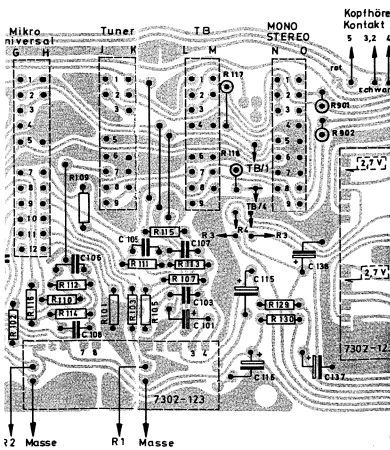

**Reglerplatte, auf die Bestückungsseite gesehen**

CONTROL BOARD, COMPONENT SIDE  
PLAQUE DE REGLAGE, VUE COTE COMPOSANTS

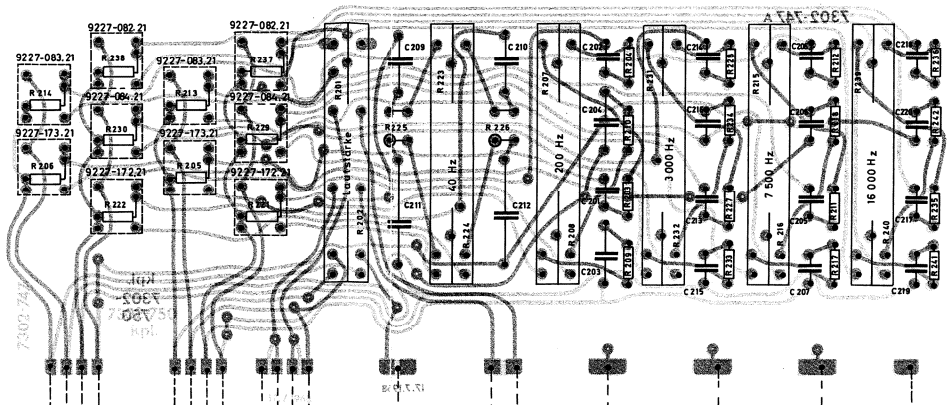

17.12.1968

R537  
R528

C 501

C 502

**Transistor - Lageplan** TRANSISTOR ARRANGEMENT SITUATION DES TRANSISTORS

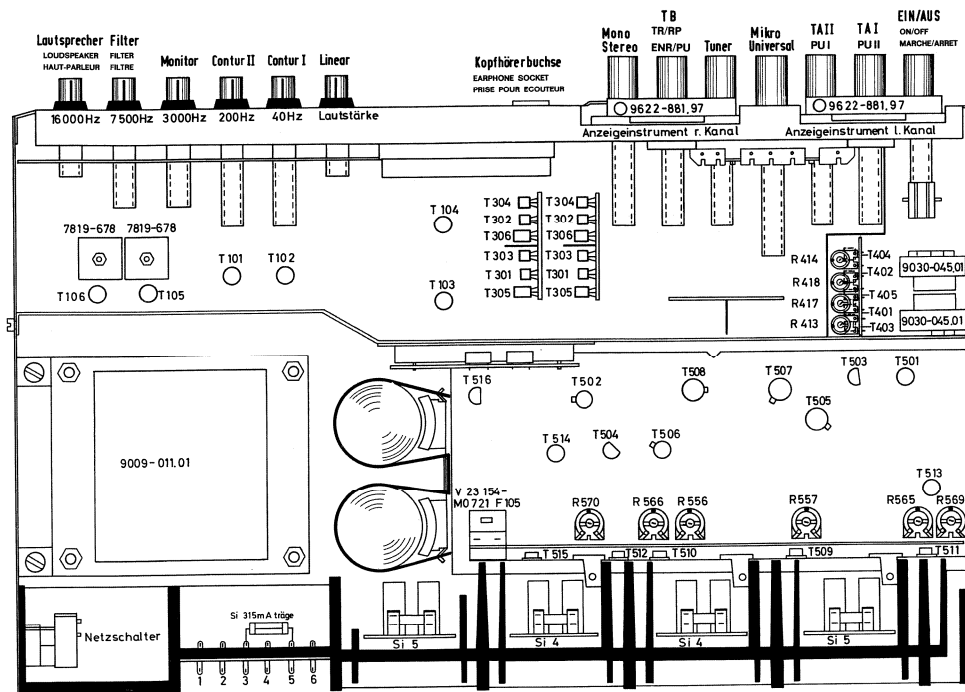

**Chassis - Rückansicht** REAR VIEW OF CHASSIS VUE ARRIERE DU CHASSIS

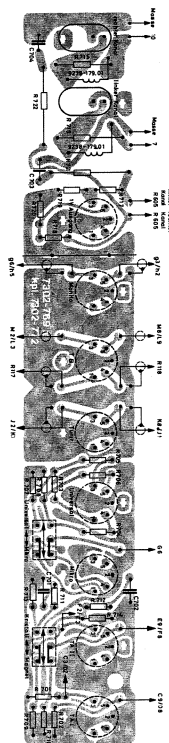
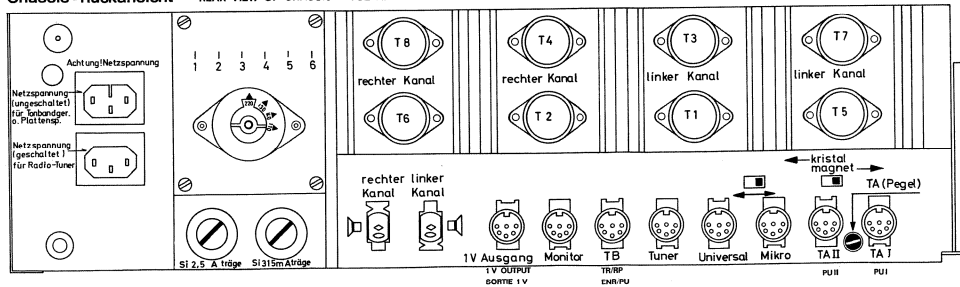

Durchschnittliche auf die Platine geschnitten  
 SOCKET PLATE, SOCKET BRG  
 PLATINE DES PHONES DE MONTAGEMENT, VUE COTE SOUSMARS

Instru  
 auf die  
 INSTRUME  
 PLATINE I

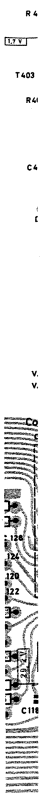

Änderungen vorbehalten  
 Alterations reserved  
 Modifications réservées

Aus technis  
 terial umges  
 BECAUSE O  
 BEGINNING  
 EN CONSIDI  
 LIEU DE MA

