

Ersatzteillisten und Explosionszeichnungen / Spare Parts Lists and Exploded Views

Explosionszeichnung / Exploded View R 1000 DPL

1

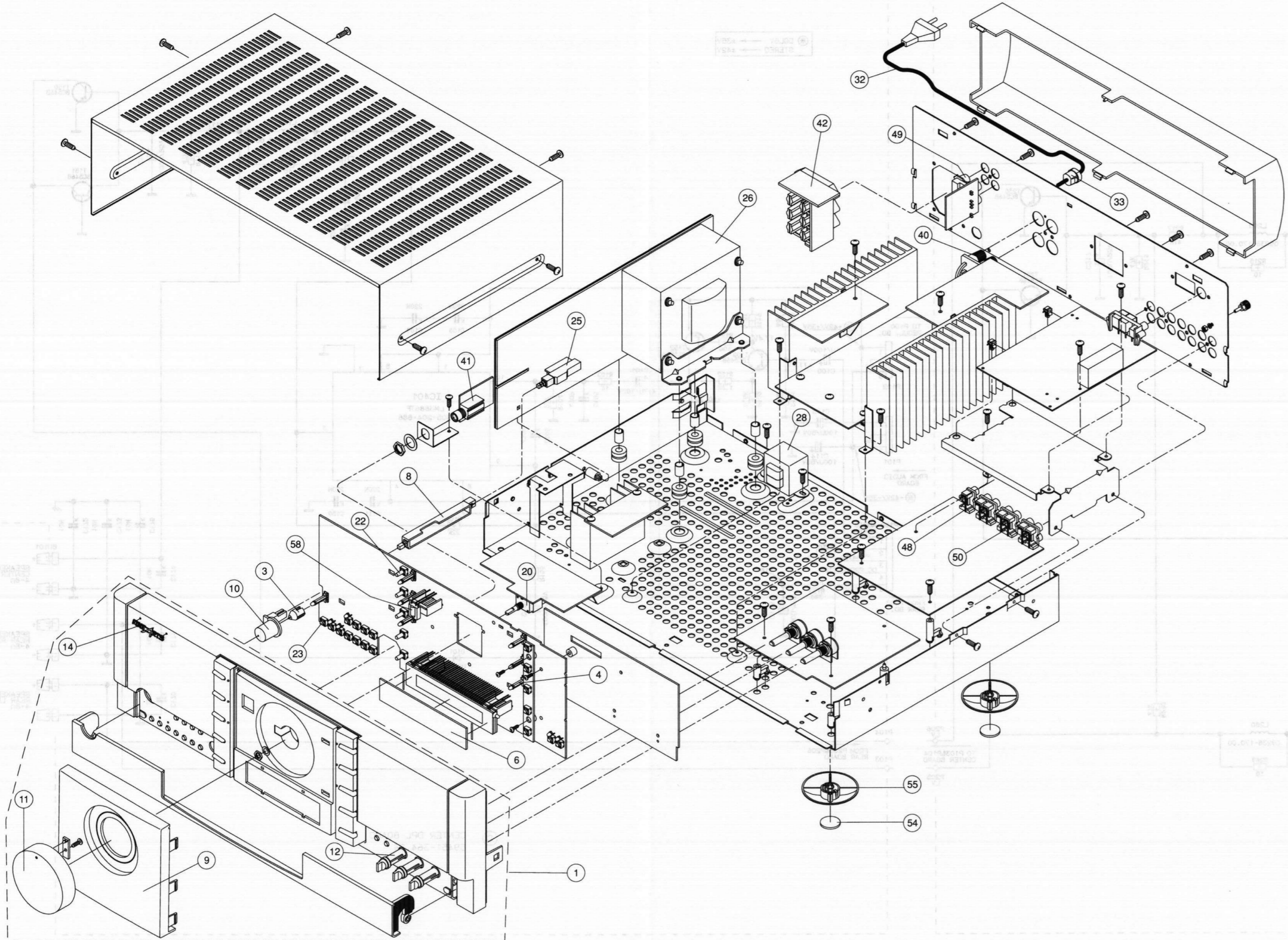

GRUNDIG Ersatzteilliste Spare Parts List

HIFI

Btx * 32700 #

R 1000 DPL

12 / 95

ERSETZT AUSGABE 7/95
SUBSTITUTE EDITION 7/95

SACH-NR. / PART NO.: 9.55351-8151
BESTELL-NR. / ORDER NO.: G.LF 0151

Table with columns: POS. NR., ABB. NR., SACHNUMMER, ANZ., BEZEICHNUNG, DESCRIPTION. Lists various parts like FRONTBLLENDE KPL, LED-LINSE, DISPLAY-HALTER, etc.

ÄNDERUNGEN VORBEHALTEN

SUBJECT TO ALTERATION

Table with columns: POS. NR., SACHNUMMER, BEZEICHNUNG, POS. NR., SACHNUMMER, BEZEICHNUNG. Lists various parts like DIODE 1N4148, Z DIODE 5.1 C 0.5W, etc.

ÄNDERUNGEN VORBEHALTEN

SUBJECT TO ALTERATION

Explosionszeichnung / Exploded View V 1000 DPL

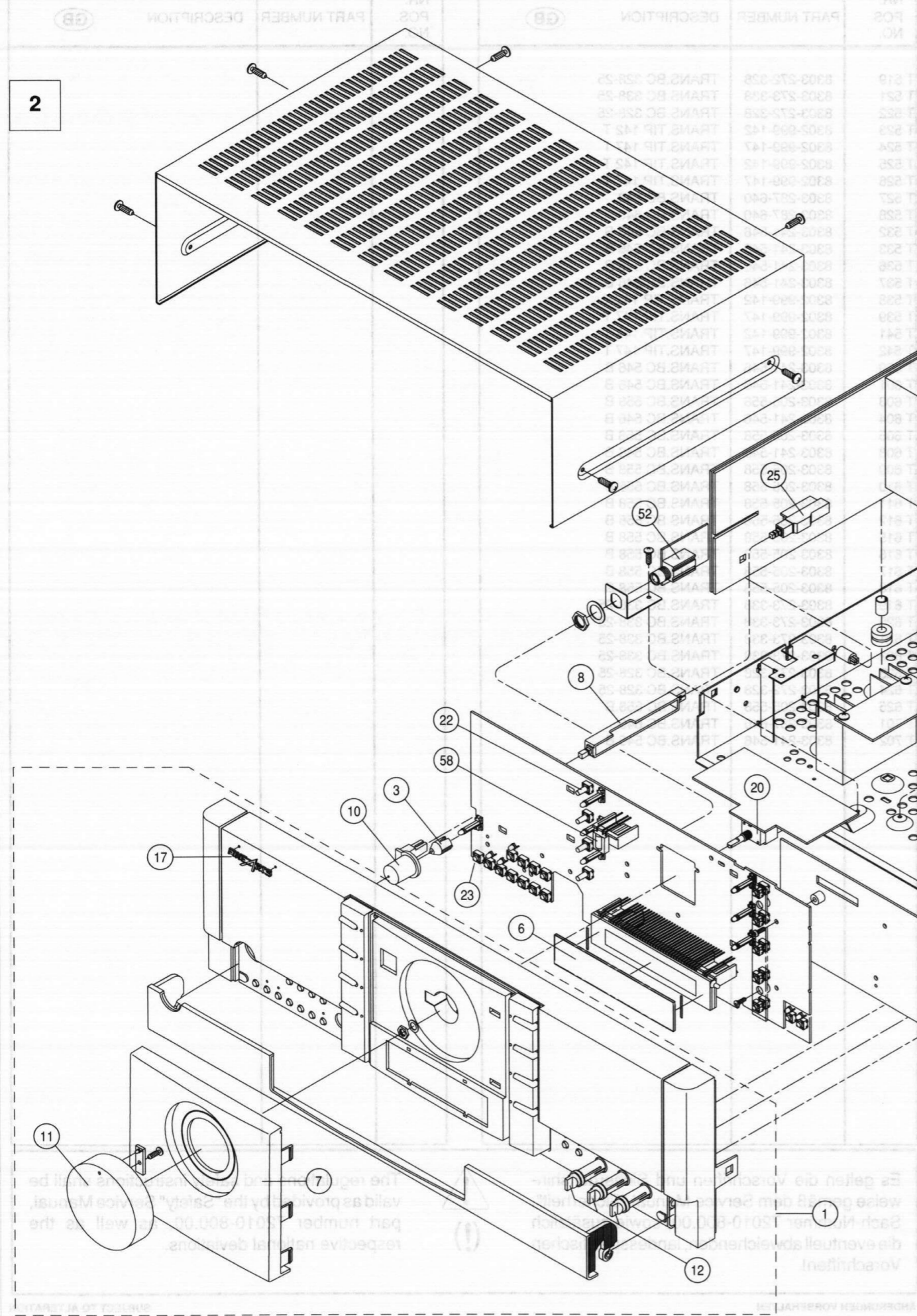



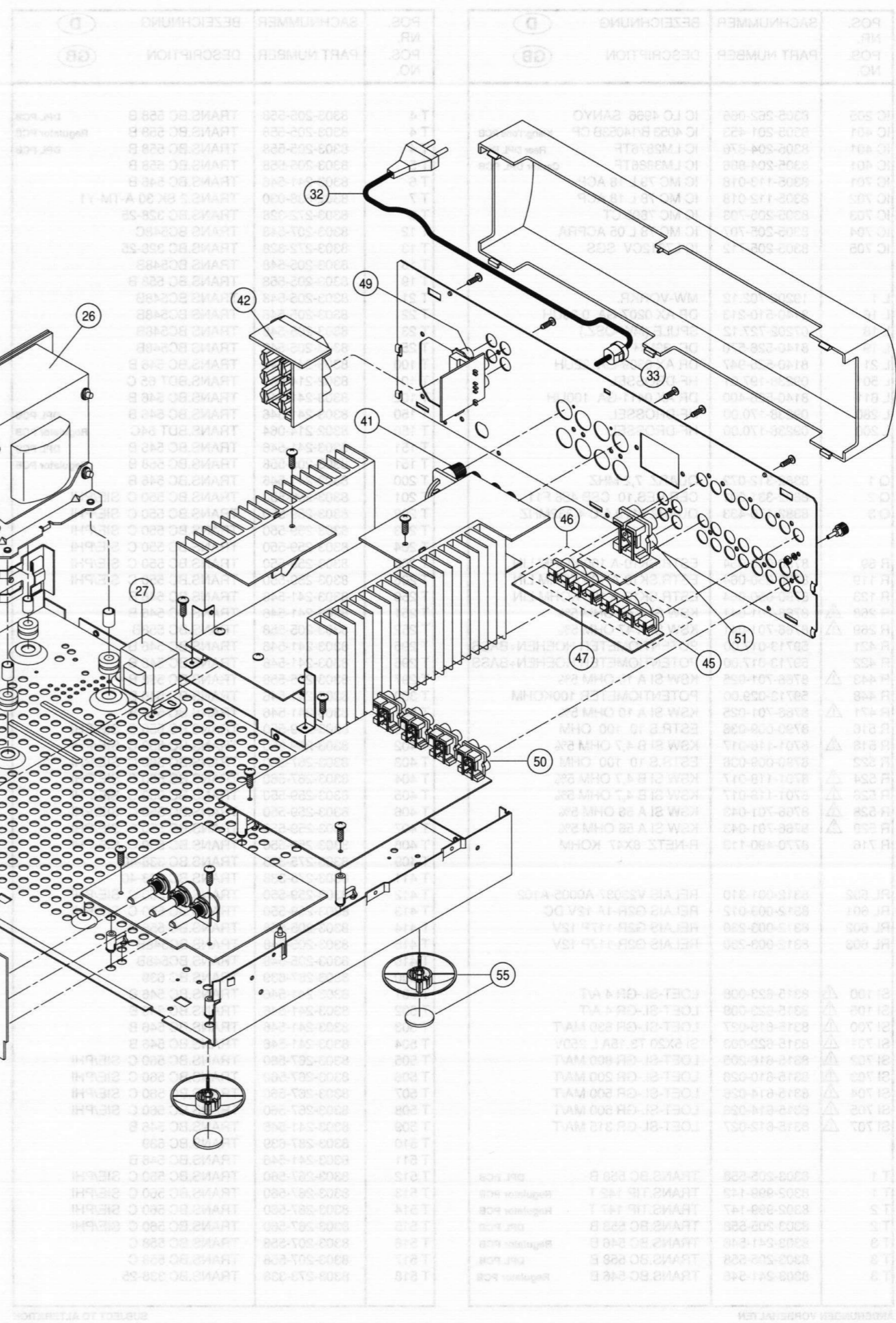



2



GRUNDIGErsatzteilliste
Spare Parts List**HIFI** 

ⓓ Btx * 32700 #

12 / 95**V 1000 DPL**ERSETZT AUSGABE 9/95
SUBSTITUTE EDITION 9/95SACH-NR. / PART NO.: 9.55343-8151
BESTELL-NR. / ORDER NO.: G.LE 0551

POS. NR. POS. NO.	ABB. NR. FIG. NO.	SACHNUMMER PART NUMBER	ANZ. QUA.	BEZEICHNUNG	ⓓ	DESCRIPTION	ⒼⒷ
0001.000	1	55343-500.01		FRONTBLLENDE KPL		FRONT MASK CPL	
0003.000	1	55301-250.00		LED-LINSE		LED LENS	
0004.000		55301-260.00	9	LED-HALTER		LED HOLDER	
0005.000		55301-215.00	2	DISPLAYHALTER		DISPLAY HOLDER	
0006.000	1	54527-348.01		FILTERFOLIE		FILTER FOIL	
0007.000	1	55309-254.06		DISPLAY LINSE		DISPLAY LENS	
0008.000	1	55301-206.01		STOESSEL		PUNCH SLIDE	
0010.000	1	55301-210.00		NETZTASTE		POWER KEY	
0011.000	1	55306-510.00		DREHKNOFF KPL		ROTARY KNOB CPL.	
0012.000	1	55306-221.00	3	KNOFF		KNOB	
0017.000	1	58003-059.01		GRUNDIG LOGO		GRUNDIG LOGO	
0020.000	1	59713-019.00		POTENTIOMETER/LAUTSTAERKE		POTENTIOMETER/VOLUME	
0022.000	1	29703-357.02	4	TASTSCHALTER		TACT SWITCH	
0023.000	1	8134-020-181	10	TASTSCHALTER		TACT SWITCH	
0025.000	1	59401-042.00		NETZSCHALTER		POWER SWITCH	
0026.000	1 	59430-038.01		TRAFO NETZ		POWER TRANSFORMER	
0028.000	1 	59430-027.01		TRAFO (STAND BY)		TRANSFORMER (STAND BY)	
0029.000		8134-023-009		THERMOSCHALTER 120 GRAD C		THERMAL SWITCH 120 DEGR.	
0030.000		29303-452.02		NETZSTECKER-UNTERTEIL KPL		MAINS PLUG LOWER PART	
0032.000	1 	8290-991-275		NETZKABEL KPL		MAINS CABLE	
0033.000	1	09666-451.00		NETZKABEL-ZUGENTLASTUNG		STRESS RELIEF	
0036.000		09621-113.02		SICHERUNGSHALTER		FUSE HOLDER	
0038.000		8134-023-002		THERMOSCHALTER 100 GRAD C		THERMAL SWITCH 100 DEGR.	
0040.000		59610-507.01		AUDIOPLATTE		AUDIO BOARD	
0041.000	1	39612-060.03	2	LAUTSPRECHER FEDERKLEMM.		LOUDSPEAKER SPRING JAMMIN	
0042.000	1	09626-904.00		LS-SCHRAUBKLEMME 4-FACH		LS SCREW CLAMP 4-FOLD	
0043.000	1	09626-904.00		AC-BUCHSE		AC SOCKET	
0044.000	1	55099-125.00		MASSEKLEMME		EARTHING CLAMP	
0045.000	1	59610-505.01		CINCHBUCHSE 3-FACH / GELB		CINCH SOCKET 3-FOLD / YELLOW	
0046.000	1	59610-505.02		CINCHBUCHSE 3-FACH / SCHWARZ		CINCH SOCKET 2-FOLD / BLACK	
0047.000	1	59610-506.01		CINCHBUCHSE 2-FACH / GELB		CINCH SOCKET 2-FOLD / YELLOW	
0049.000	1	09623-449.01		CINCHBUCHSE 4-FACH		CINCH SOCKET 4 FOLD	
0050.000	1	09623-449.02	4	CINCHBUCHSE 4-FACH		CINCH SOCKET 4 FOLD	
0051.000	1	09623-449.02		CINCHBUCHSE 4-FACH		CINCH SOCKET 4 FOLD	
0052.000	1	09621-146.00		STEREO-KOPFHÖRERBUCHSE		STEREO-HEAD SET SOCKET	
0055.000	1	55301-502.00	4	FUSS KPL		FOOT CPL.	
0058.000	1	59852-001.00		IR-EMPFAENGER TFMS 5360		IR RECEIVER TFMS 5360	
0060.000		59802-616.01		IR-GERBER		IR REMOTE CONTROL	
		55343-941.01		BEDIENUNGSANLEITUNG		INSTRUCTION MANUAL	
		72010-745.65		SERVICE MANUAL		SERVICE MANUAL	

ÄNDERUNGEN VORBEHALTEN

SUBJECT TO ALTERATION

POS. NR. POS. NO.	SACHNUMMER PART NUMBER	BEZEICHNUNG DESCRIPTION	(D) (GB)	POS. NR. POS. NO.	SACHNUMMER PART NUMBER	BEZEICHNUNG DESCRIPTION	(D) (GB)
C 552	8410-001-135	ELKO 1000UF 50V		D 610	8309-215-045	DIODE 1N4148	
C 553	8410-001-135	ELKO 1000UF 50V		D 611	8309-215-045	DIODE 1N4148	
C 702	8452-996-147	ELKO 1000UF 20% 25V		D 612	8309-944-411	LE DIODE TLHY 4405 BT12Z	
C 719	8660-197-042	SI-KERKO.A 3300PF 20%		D 613	8309-944-411	LE DIODE TLHY 4405 BT12Z	
C 720	8660-197-042	SI-KERKO.A 3300PF 20%		D 614	8309-944-411	LE DIODE TLHY 4405 BT12Z	
CIC 1	8305-208-450	IC M38173-M6-358FP		D 615	8309-944-411	LE DIODE TLHY 4405 BT12Z	
D 1	8309-215-045	DIODE 1N4148	DPL PCB	D 616	8309-720-052	Z DIODE 5,1 C 0,5W	
D 1	8309-720-052	Z DIODE 5,1 C 0,5W	Regulator PCB	D 617	8309-944-411	LE DIODE TLHY 4405 BT12Z	
D 2	8309-720-052	Z DIODE 5,1 C 0,5W		D 618	8309-944-411	LE DIODE TLHY 4405 BT12Z	
D 3	8309-215-045	DIODE 1N4148		D 701	8309-215-045	DIODE 1N4148	
D 4	8309-215-045	DIODE 1N4148		D 702	8309-215-045	DIODE 1N4148	
D 101	8309-720-052	Z DIODE 5,1 C 0,5W	Regulator PCB	D 703	8309-215-104	DIODE 1 N 4002 -GA	
D 101	8309-215-045	DIODE 1N4148	DPL PCB	D 704	8309-215-104	DIODE 1 N 4002 -GA	
D 150	8309-720-052	Z DIODE 5,1 C 0,5W		D 705	8309-215-104	DIODE 1 N 4002 -GA	
D 201	8309-215-045	DIODE 1N 4148	DPL PCB	D 706	8309-215-104	DIODE 1 N 4002 -GA	
D 401	8309-720-161	Z DIODE 16 B 0,5W		D 707	8309-215-104	DIODE 1 N 4002 -GA	
D 402	8309-215-045	DIODE 1N4148		D 708	8309-215-104	DIODE 1 N 4002 -GA	
D 501	8309-215-045	DIODE 1N4148		D 709	8309-215-104	DIODE 1 N 4002 -GA	
D 502	8309-215-045	DIODE 1N4148		D 710	8309-215-104	DIODE 1 N 4002 -GA	
D 503	8309-215-045	DIODE 1N4148		D 711	8309-215-104	DIODE 1 N 4002 -GA	
D 504	8309-215-045	DIODE 1N4148		D 712	8309-215-104	DIODE 1 N 4002 -GA	
D 505	8309-215-045	DIODE 1N4148		D 714	8309-215-104	DIODE 1 N 4002 -GA	
D 506	8309-215-045	DIODE 1N4148		D 715	8309-215-104	DIODE 1 N 4002 -GA	
D 507	8309-215-045	DIODE 1N4148		D 716	8309-215-104	DIODE 1 N 4002 -GA	
D 508	8309-215-045	DIODE 1N4148		D 717	8309-215-045	DIODE 1N4148	
D 509	8309-215-045	DIODE 1N4148		D 718	8309-720-119	Z DIODE 18 C 0,5W	
D 511	8309-215-045	DIODE 1N4148		D 719	8309-720-116	Z DIODE 15 C 0,5W	
D 516	8309-215-045	DIODE 1N4148		D 720	8309-215-045	DIODE 1N4148	
D 517	8309-215-045	DIODE 1N4148		D 721	8309-215-045	DIODE 1N4148	
D 518	8309-215-045	DIODE 1N4148		D 722	8309-215-045	DIODE 1N4148	
D 519	8309-215-045	DIODE 1N4148		D 723	8309-215-045	DIODE 1N4148	
D 521	8309-215-045	DIODE 1N4148		D 724	8309-215-045	DIODE 1N4148	
D 522	8309-215-045	DIODE 1N4148		D 725	8309-215-045	DIODE 1N4148	
D 523	8309-215-045	DIODE 1N4148		DP 600	59740-006.00	FLUORESCENZANZEIGE	
D 524	8309-215-045	DIODE 1N4148		F 11	8602-331-072	KERRES #72 2MHZ	
D 525	8309-712-752	DIODE MR 752 MOT		F 600	8602-331-086	CER.RES.86/13 CST 4.0 MGW	
D 526	8309-712-752	DIODE MR 752 MOT		CIC 1	8305-208-450	IC M38173-M6-358FP	Bedien-/Control
D 527	8309-712-752	DIODE MR 752 MOT		IC 1	8305-204-834	IC LM 833	Eingangswahl-/Input PCB
D 528	8309-712-752	DIODE MR 752 MOT		IC 1	8305-602-405	IC X 24C04 XICOR	Bedien-/Control PCB
D 536	8309-215-045	DIODE 1N4148		IC 2	59852-001.00	IR-EMPFAENGER	
D 537	8309-215-045	DIODE 1N4148		IC 2	8305-262-821	TFMS 5360	Bedien-/Control PCB
D 538	8309-215-045	DIODE 1N4148		IC 3	8305-103-242	IC LC 7821	Eingangswahl-/Input PCB
D 539	8309-215-045	DIODE 1N4148		IC 4	8305-201-453	IC BU 2042 ROHM	
D 541	8309-215-045	DIODE 1N4148		IC 101	8305-262-066	IC 4053 B/14053 B CP	
D 542	8309-215-045	DIODE 1N4148		IC 201	8305-204-876	IC LC 4966 SANYO	
D 543	8309-215-045	DIODE 1N4148		IC 201	8305-208-632	IC LM2876TF	DPL PCB
D 544	8309-215-045	DIODE 1N4148		IC 201	8305-208-632	IC M69032P MIT	DPL PCB
D 545	8309-215-045	DIODE 1N4148		IC 202	8305-847-313	SMD IC TDA 7313 D-013 TR	
D 547	8309-215-045	DIODE 1N4148		IC 203	8305-752-630	SMD IC M65830FP MIT	
D 600	8309-215-045	DIODE 1N4148		IC 204	8305-262-066	IC LC 4966 SANYO	
D 601	8309-215-045	DIODE 1N4148		IC 205	8305-262-066	IC LC 4966 SANYO	
D 601	8309-944-410	LE DIODE TLHY 4405 TFK		IC 206	8305-204-257	IC LM 258 P TID/PHI/MOT	
D 602	8309-215-045	DIODE 1N4148		IC 260	8305-262-066	IC LC 4966 SANYO	
D 602	8309-944-410	LE DIODE TLHY 4405 TFK		IC 401	8305-204-876	IC LM2876TF	DPL PCB
D 603	8309-215-045	DIODE 1N4148		IC 401	8305-204-886	IC LM3886TF	Klang/Tone PCB
D 604	8309-215-045	DIODE 1N4148		IC 701	8305-113-018	IC MC 79 L 18 ACP	
D 604	8309-944-410	LE DIODE TLHY 4405 TFK		IC 702	8305-112-018	IC MC 78 L 18 ACP	
D 605	8309-215-045	DIODE 1N4148		IC 703	8305-205-703	IC MC 7805 CT	
D 605	8309-944-410	LE DIODE TLHY 4405 TFK		IC 704	8305-205-707	IC MC 78 L 05 ACPRA	
D 606	8309-215-045	DIODE 1N4148		IC 705	8305-205-712	IC L7812CV SGS	
D 606	8309-944-410	LE DIODE TLHY 4405 TFK		L 200	09238-170.00	HF-DROSSEL	
D 607	8309-215-045	DIODE 1N4148		L 280	09238-170.00	HF-DROSSEL	
D 607	8309-944-410	LE DIODE TLHY 4405 TFK		L 501	09238-197.01	HF-DROSSEL	
D 608	8309-215-045	DIODE 1N4148					
D 608	8309-944-410	LE DIODE TLHY 4405 TFK					
D 609	8309-215-045	DIODE 1N4148					
D 609	8309-944-410	LE DIODE TLHY 4405 TFK					

POS. NR. POS. NO.	SACHNUMMER PART NUMBER	BEZEICHNUNG DESCRIPTION	(D) (GB)
L 611	8140-526-400	DR AX 0411-GA 100UH	
R 268 ▲	8766-701-041	KSW SI A 47 OHM 5%	
R 269 ▲	8766-701-041	KSW SI A 47 OHM 5%	
R 421	59713-017.00	POTENTIOMETER HOEHEN+BASS	
R 422	59713-017.00	POTENTIOMETER HOEHEN+BASS	
R 443 ▲	8766-701-025	KSW SI A 10 OHM 5%	
R 448	59713-029.00	POTENTIOMETER 100KOHM	
R 471 ▲	8766-701-025	KSW SI A 10 OHM 5%	
R 516	8790-009-036	ESTR.S 10 100 OHM	
R 518 ▲	8701-118-017	KSW SI B 4,7 OHM 5%	
R 522	8790-009-036	ESTR.S 10 100 OHM	
R 524 ▲	8701-118-017	KSW SI B 4,7 OHM 5%	
R 526 ▲	8701-118-017	KSW SI B 4,7 OHM 5%	
R 528 ▲	8766-701-043	KSW SI A 56 OHM 5%	
R 529 ▲	8766-701-043	KSW SI A 56 OHM 5%	
R 531 ▲	8701-118-017	KSW SI B 4,7 OHM 5%	
R 716	8770-490-113	R-NETZ 8X47 KOHM	
RL 501	8312-003-524	RELAIS G5Z 24VDC OMR	
RL 502	8312-003-524	RELAIS G5Z 24VDC OMR	
RL 601	8312-003-012	RELAIS G2R-1A 12V DC	
RL 602	8312-003-230	RELAIS G2R-117 12V	
RL 603	8312-003-230	RELAIS G2R-117 12V	
SI 100 ▲	8315-623-008	LOET-SI.-GR 4 A/T	
SI 105 ▲	8315-623-008	LOET-SI.-GR 4 A/T	
SI 700 ▲	8315-615-027	LOET-SI.-GR 630 AM/T	
SI 701 ▲	8315-622-003	SI 5X20 T3,15A L 250V	
SI 702 ▲	8315-616-205	LOET-SI.-GR 800 MA/T	
SI 703 ▲	8315-610-026	LOET-SI.-GR 200 MA/T	
SI 704 ▲	8315-614-026	LOET-SI.-GR 500 MA/T	
SI 705 ▲	8315-614-026	LOET-SI.-GR 500 MA/T	
SI 707 ▲	8315-612-027	LOET-SI.-GR 315 MA/T	
T 1	8303-205-558	TRANS.BC 558 B	DPL PCB
T 1	8302-999-142	TRANS.TIP 142 T	Regulator PCB
T 2	8302-999-147	TRANS.TIP 147 T	Regulator PCB
T 2	8303-205-558	TRANS.BC 558 B	DPL PCB
T 3	8303-241-546	TRANS.BC 546 B	Regulator PCB
T 3	8303-205-558	TRANS.BC 558 B	DPL PCB
T 4	8303-205-558	TRANS.BC 558 B	DPL PCB
T 4	8303-205-558	TRANS.BC 558 B	Regulator PCB
T 5	8303-205-558	TRANS.BC 558 B	
T 6	8303-241-546	TRANS.BC 546 B	
T 100	8303-241-546	TRANS.BC 546 B	
T 101	8303-241-546	TRANS.BC 546 B	
T 101	8302-214-065	TRANS.BDT 65 C	Regulator PCB
T 102	8303-205-558	TRANS.BC 558 B	
T 102	8303-241-546	TRANS.BC 546 B	Regulator PCB
T 103	8303-241-546	TRANS.BC 546 B	
T 121	8303-241-546	TRANS.BC 546 B	
T 131	8303-205-558	TRANS.BC 558 B	
T 132	8303-205-558	TRANS.BC 558 B	
T 150	8303-241-546	TRANS.BC 546 B	DPL PCB
T 150	8302-214-064	TRANS.BDT 64 C	Regulator PCB
T 151	8303-241-546	TRANS.BC 546 B	DPL PCB
T 151	8303-205-558	TRANS.BC 558 B	Regulator PCB
T 200	8303-241-546	TRANS.BC 546 B	
T 201	8303-259-550	TRANS.BC 550 C	SIE/PHI
T 202	8303-259-550	TRANS.BC 550 C	SIE/PHI
T 203	8303-259-550	TRANS.BC 550 C	SIE/PHI
T 204	8303-259-550	TRANS.BC 550 C	SIE/PHI
T 205	8303-259-550	TRANS.BC 550 C	SIE/PHI
T 206	8303-259-550	TRANS.BC 550 C	SIE/PHI
T 250	8303-241-546	TRANS.BC 546 B	
T 251	8303-241-546	TRANS.BC 546 B	

POS. NR. POS. NO.	SACHNUMMER PART NUMBER	BEZEICHNUNG DESCRIPTION	(D) (GB)
T 252	8303-205-558	TRANS.BC 558 B	Regulator PCB
T 295	8303-241-546	TRANS.BC 546 B	
T 296	8303-241-546	TRANS.BC 546 B	
T 297	8303-205-558	TRANS.BC 558 B	
T 300	8303-241-546	TRANS.BC 546 B	
T 301	8303-241-546	TRANS.BC 546 B	
T 401	8303-259-550	TRANS.BC 550 C	SIE/PHI
T 402	8303-259-550	TRANS.BC 550 C	SIE/PHI
T 403	8303-267-560	TRANS.BC 560 C	SIE/PHI
T 404	8303-267-560	TRANS.BC 560 C	SIE/PHI
T 405	8303-259-550	TRANS.BC 550 C	SIE/PHI
T 406	8303-259-550	TRANS.BC 550 C	SIE/PHI
T 407	8303-259-550	TRANS.BC 550 C	SIE/PHI
T 408	8303-259-550	TRANS.BC 550 C	SIE/PHI
T 409	8303-275-338	TRANS.BC 338-40	
T 411	8303-275-338	TRANS.BC 338-40	
T 412	8303-259-550	TRANS.BC 550 C	SIE/PHI
T 413	8303-259-550	TRANS.BC 550 C	SIE/PHI
T 414	8303-205-558	TRANS.BC 558 B	
T 415	8303-205-548	TRANS BC548B	
T 416	8303-205-548	TRANS BC548B	
T 500	8303-287-639	TRANS.BC 639	
T 501	8303-259-550	TRANS.BC 550 C	SIE/PHI
T 502	8303-259-550	TRANS.BC 550 C	SIE/PHI
T 503	8303-259-550	TRANS.BC 550 C	SIE/PHI
T 504	8303-259-550	TRANS.BC 550 C	SIE/PHI
T 505	8303-267-560	TRANS.BC 560 C	SIE/PHI
T 506	8303-267-560	TRANS.BC 560 C	SIE/PHI
T 507	8303-267-560	TRANS.BC 560 C	SIE/PHI
T 508	8303-267-560	TRANS.BC 560 C	SIE/PHI
T 509	8303-241-546	TRANS.BC 546 B	
T 510	8303-287-639	TRANS.BC 639	
T 511	8303-241-546	TRANS.BC 546 B	
T 512	8303-267-560	TRANS.BC 560 C	SIE/PHI
T 513	8303-267-560	TRANS.BC 560 C	SIE/PHI
T 514	8303-267-560	TRANS.BC 560 C	SIE/PHI
T 515	8303-267-560	TRANS.BC 560 C	SIE/PHI
T 516	8303-207-558	TRANS.BC 558 C	
T 517	8303-207-558	TRANS.BC 558 C	
T 518	8303-273-338	TRANS.BC 338-25	
T 519	8303-272-328	TRANS.BC 328-25	
T 521	8303-273-338	TRANS.BC 338-25	
T 522	8303-272-328	TRANS.BC 328-25	
T 523	8302-999-142	TRANS.TIP 142 T	
T 524	8302-999-147	TRANS.TIP 147 T	
T 525	8302-999-142	TRANS.TIP 142 T	
T 526	8302-999-147	TRANS.TIP 147 T	
T 527	8303-287-640	TRANS.BC 640	
T 528	8303-287-640	TRANS.BC 640	
T 532	8303-241-546	TRANS.BC 546 B	
T 533	8303-241-546	TRANS.BC 546 B	
T 534	8303-241-546	TRANS.BC 546 B	
T 535	8303-241-546	TRANS.BC 546 B	
T 536	8303-241-546	TRANS.BC 546 B	
T 537	8303-241-546	TRANS.BC 546 B	
T 538	8302-999-142	TRANS.TIP 142 T	
T 539	8302-999-147	TRANS.TIP 147 T	
T 541	8302-999-142	TRANS.TIP 142 T	
T 542	8302-999-147	TRANS.TIP 147 T	
T 600	8303-241-546	TRANS.BC 546 B	
T 601	8303-241-546	TRANS.BC 546 B	
T 603	8303-205-558	TRANS.BC 558 B	
T 604	8303-241-546	TRANS.BC 546 B	
T 605	8303-205-558	TRANS.BC 558 B	
T 606	8303-241-546	TRANS.BC 546 B	
T 607	8303-241-546	TRANS.BC 546 B	
T 608	8303-205-558	TRANS.BC 558 B	
T 609	8303-205-558	TRANS.BC 558 B	
T 610	8303-205-558	TRANS.BC 558 B	
T 611	8303-205-558	TRANS.BC 558 B	
T 612	8303-205-558	TRANS.BC 558 B	

POS. NR. POS. NO.	SACHNUMMER PART NUMBER	BEZEICHNUNG DESCRIPTION	(D) (GB)
T 615	8303-205-558	TRANS.BC 558 B	
T 616	8303-205-558	TRANS.BC 558 B	
T 617	8303-205-558	TRANS.BC 558 B	
T 618	8303-205-558	TRANS.BC 558 B	
T 619	8303-273-338	TRANS.BC 338-25	
T 620	8303-273-338	TRANS.BC 338-25	
T 621	8303-273-338	TRANS.BC 338-25	
T 622	8303-273-338	TRANS.BC 338-25	
T 623	8303-272-328	TRANS.BC 328-25	
T 624	8303-272-328	TRANS.BC 328-25	
T 701	8303-287-640	TRANS.BC 640	
T 702	8303-241-546	TRANS.BC 546 B	
T 703	8303-293-517	TRANS.BC 517	
T 704	8303-293-517	TRANS.BC 517	

POS. NR. POS. NO.	SACHNUMMER PART NUMBER	BEZEICHNUNG DESCRIPTION	(D) (GB)

Es gelten die Vorschriften und Sicherheitshinweise gemäß dem Service Manual "Sicherheit", Sach-Nummer 72010-800.00, sowie zusätzlich die eventuell abweichenden, landesspezifischen Vorschriften!



The regulations and safety instructions shall be valid as provided by the "Safety" Service Manual, part number 72010-800.00, as well as the respective national deviations.