

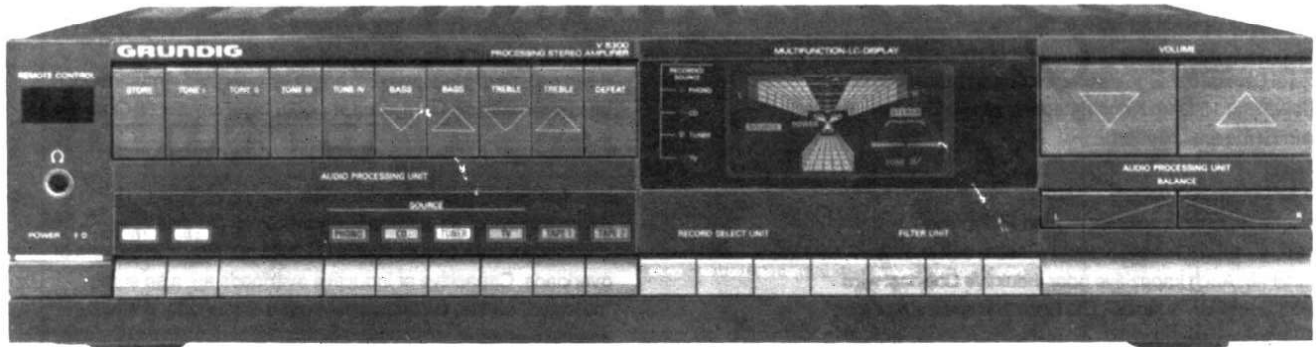

ⓓ Btx * 32700 #

12/86

V8300



Technische Daten

Technical Specification

Ausgangsleistungen (DIN 45500) Musikleistung/Nennleistung an 8 Ω:	Output Power (DIN 45500) Music Power/Nominal Power into 8 Ω:	2 x 120/70 W
Klirrfaktor (bei Nennleistung -1 dB)	Total Harmonic Distortion (at nominal power -1 dB)	≤ 0.01%
Intermodulation (bei Nennleistung -1 dB)	Intermodulation Distortion (at nominal power -1 dB)	≤ 0.05%
Dämpfungsfaktor (8 Ω) R _i = < 110 mΩ	Damping Factor (8 Ω) R _i = < 110 mΩ	≥ 72
Leistungsbandbreite	Power Bandwidth	≥ 5 Hz... ≤ 80 kHz
Übertragungsbereich Tuner, Tape, CD, TV: Phono:	Frequency Response Tuner, Tape, CD, TV: Phono (magn.):	< 5 Hz... > 40 kHz ≤ 3 dB 20 Hz... 40 kHz ≤ 3 dB
Übersprechdämpfung L-R (für 1kHz) Tuner, Tape, CD, TV: Phono:	Stereo Separation (for 1 kHz) Tuner, Tape, CD, TV: Phono:	80 dB 70 dB
Fremdspannungsabstand: a) bezogen auf Nennleistung Tuner, Tape, CD, TV: Phono: b) bezogen auf 2 x 50 mW an 8 Ω Tuner, Tape, CD, TV: Phono:	Signal-to-Noise Ratio (Unweighted): a) at nominal power Tuner, Tape, CD, TV: Phono: b) for 2 x 50 mW into 8 Ω Tuner, Tape, CD, TV: Phono:	IEC/DIN 92/88 dB 74/70 dB 67/63 dB 66/62 dB
Geräuschspannungsabstand a) bezogen auf Nennleistung Tuner, Tape, CD, TV: Phono: b) bezogen auf 2 x 50 mW an 8 Ω Tuner, Tape, CD, TV: Phono:	Signal-to-Noise Ratio (Weighted) a) at nominal power Tuner, Tape, CD, TV: Phono: b) for 2 x 50 mW into 8 Ω Tuner, Tape, CD, TV: Phono:	IEC/DIN 94/86 dB 79/71 dB 70/63 dB 70/62 dB
Eingangsempfindlichkeit (bei Nennleistung) Tuner, CD, TV: Tape: Phono:	Input Sensitivity (at nominal power) Tuner, CD, TV: Tape: Phono:	160 mV/50 kΩ 150 mV/60 kΩ 1.9 mV/47 kΩ

Technische Änderungen vorbehalten!

Subject to technical alterations

Das Gerät muß auch nach der Reparatur den Sicherheitsbestimmungen nach DIN / IEC 65 VDE 0860 entsprechen.

After the unit has been repaired, it should still meet the DIN/IEC 65 VDE 0860 safety requirements.

Die einzelnen Platten sind mit Buchstaben gekennzeichnet

The boards are identified by letters.

Anschließen der Lautsprecher

Um die Wiedergabequalität und Leistung des Gerätes voll nutzen zu können, sind entsprechend belastbare und hochwertige HiFi-Lautsprecherboxen erforderlich (mindestens 70 Watt Nennbelastbarkeit).

- Sie können zwei Lautsprechergruppen anschließen.
- Beide Gruppen, LS 1 und LS 2, lassen sich einzeln oder gemeinsam betreiben.

Schalten Sie immer nur eine LS-Gruppe ein, so sind Boxen mit 8 Ohm Nennimpedanz optimal angepaßt. Bei Werten darüber vermindert sich die Ausgangsleistung.

Wollen Sie zwei Lautsprechergruppen gleichzeitig betreiben, so sollten Sie Boxen mit 16 Ohm Nennimpedanz verwenden bzw. 8-Ohm-Boxen in Reihe anschließen.

Connection of Loudspeakers

In order to allow a maximum utilization of the quality of reproduction and power of the system, high-quality hifi loudspeaker boxes with appropriate power handling capacity (min.70 Watt rating) are required.

- Two groups of loudspeakers can be connected.
- Both groups, LS 1 and LS 2, can either be operated separately or simultaneously.

When selecting only one group of loudspeakers at a time boxes with 8 Ohm rated impedance ensure an optimum matching. Values beyond this rating cause a decrease of the output power.

If two groups of loudspeakers are to be operated simultaneously use boxes with 16 Ohm rated impedance or connect 8 Ohm boxes in series.

Eingebaute Schutzschaltungen

Die elektronische Automatik schaltet in allen Fällen von Überlastungen, also nicht nur bei Kurzschlüssen, den jeweils gestörten Kanal ab. Auch kapazitive oder induktive Überlast wird von der Automatik sicher "erkannt". Die Endtransistoren sind damit sicher vor Zerstörung geschützt.

Nehmen Sie die Lautstärke zurück, wenn durch Überlastung die Automatik immer wieder ansprechen sollte.

Zusätzlich sind je 1 Übertemperaturschalter an der Kühlschiene und am Netztransformator eingebaut, die bei Erreichen einer bestimmten Grenztemperatur das Gerät ausschalten. In beiden Fällen wird nach Beendigung der auslösenden Störung selbsttätig wieder eingeschaltet, wobei der Netztransformator eine längere Abkühlzeit braucht.

Außerdem hat der Verstärker Lautsprecher-Schutzschaltungen, die verhindern, daß bei defekter Endstufe Gleichspannung die wertvollen Boxen zerstört.

Incorporated Protective Circuits

Electronic switches automatically switch off the disturbed channel not only in case of short circuits but also in any event of overloads. Capacitive or inductive overloads are also surely "detected" so that the output transistors are reliably protected against damages.

Reduce the volume if the protective circuits react repeatedly to overloads.

Additionally, one excess-temperature switch each is incorporated in the heat sink and mains transformer to switch off the amplifier if the temperature reaches a certain limit. In both cases, the amplifier is switched on again automatically as soon as the cause of trouble is eliminated. The mains transformer requires a longer time, however, to cool down.

The amplifier is additionally equipped with special protective circuits for the loudspeaker to prevent damages to the valuable boxes caused by direct current from a defective output stage.

Testschalter / Displaytest

Sollte durch äußere Störeinflüsse (statische Aufladung bei Teppichböden oder aufgrund von Gewittern usw.) die Speicherelektronik des Verstärkers Fehlinformationen bekommen und sich das Gerät deshalb nicht mehr wie gewohnt einstellen lassen, so schalten Sie es aus und nach ca. 5 Sekunden wieder ein. Bringt das keine Abhilfe, so können Sie durch Betätigen eines kleinen Service-Testschalters den Verstärker auf seine Grundprogrammierung zurücksetzen. Für die Zeit dieser Schalterbetätigung leuchten dann im Display alle Anzeige-Segmente auf.

Zugänglich ist der Testschalter durch die Fuge rechts neben der Taste DEFEAT (etwas unterhalb der Tastenmitte). Verwenden Sie bitte dazu am besten eine Nadel oder auch eine aufgebogene Büroklammer.

Test Switch / Display test

Should the memory electronics of the amplifier receive incorrect data due to external disturbances (static charges from carpeted floors or thunderstorms) so that the amplifier defies all attempts to set it as usual switch it off for about 5 seconds, then switch it on again. If this measure does not produce a remedial effect reset the amplifier to its basic programming by operating a small service test switch. All segments of the display will light up as long as the switch is operated.

Access to the test switch is through the gap on the right of the DEFEAT button (just below the middle of the button). For this purpose, please use preferably a needle or a deformed paper clip.

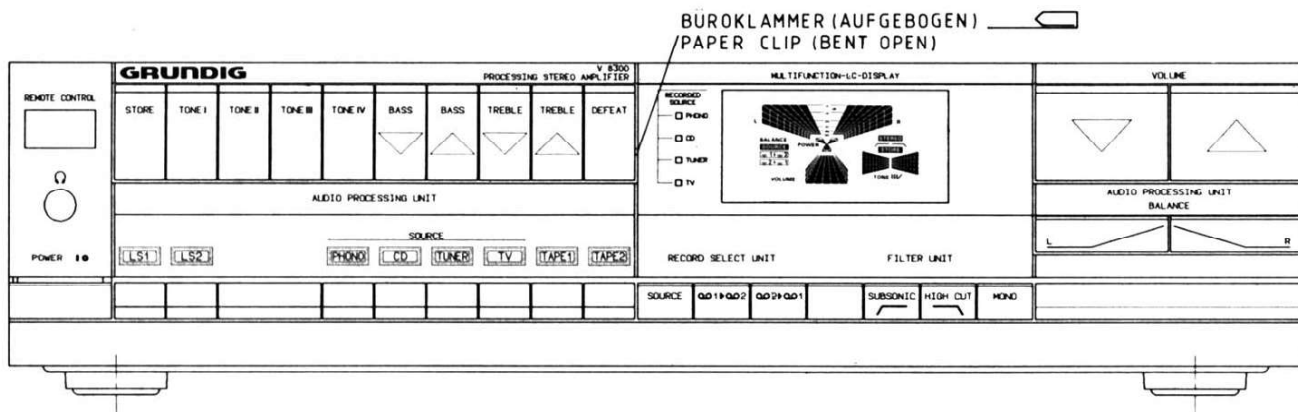

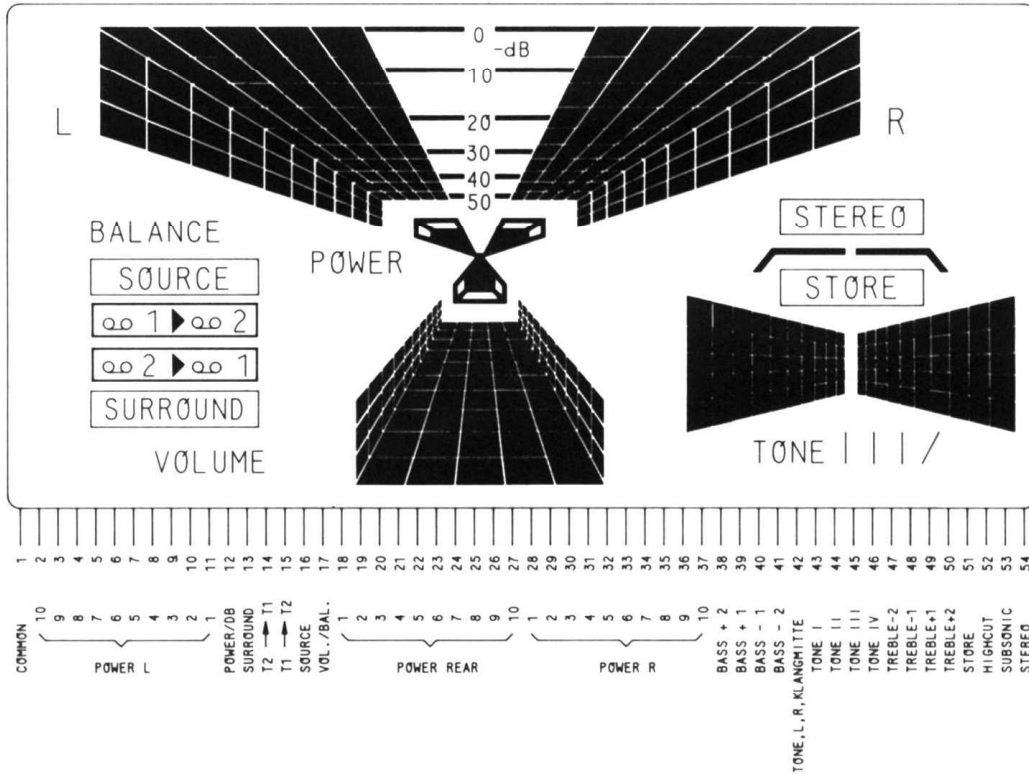

Ausbauhinweise

Frontblende

- 3 Schrauben **p** lösen.
- Frontblende nach vorne ziehen.

NF - Platte

- 5 Schrauben **a** herausschrauben.
- NF - Platte und Kühlkörper herausnehmen.

Netzteilplatte

- 4 Schrauben **c** herausschrauben.

Netztrafo

- 4 Schrauben **b** herausschrauben.

Disassembly Instructions

Front Panel

- Undo 3 screws **p**.
- Pull out the front panel.

AF Circuit Board

- Undo 5 screws **a**.
- Take out the AF board and the heat sink.

Power Supply Circuit Board

- Undo 4 screws **c**.

Mains Transformer

- Undo 4 screws **b**.

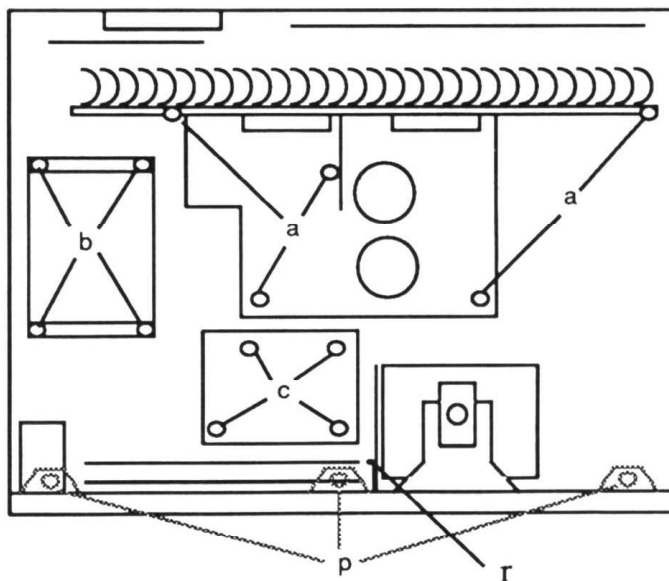

Tastenplatte 2

- 4 Schrauben h heraus-schrauben.

Lampenplatte

- Lampe LA1 um 90° drehen und herausnehmen.
- Lampenplatte über Rastnase aus den Führungen ziehen.

Display und Displayplatte

- 2 Schrauben o heraus-schrauben.

µP - Platte

- Frontplatte abschrauben.
- 4 Schrauben k heraus-schrauben.

Tastenplatte 1

- UP - Platte ausbauen.
- 13 Schrauben l heraus-schrauben.

Diodenplatte

- Frontblende abschrauben.
- 2 Schrauben r heraus-schrauben.

Kopfhörer - Buchsenplatte

- Schraube m heraus-schrauben.

Netzschalterplatte

- Netzschalter auslösen.
- Knopf vom Netzschalter abziehen.
- Frontplatte abschrauben.
- 2 Schrauben n heraus-schrauben.

Keyboard Unit 2

- Remove 4 screws h.

Lamp Circuit Board

- Turn lamp LA1 by 90° and remove it.
- Disengage the lamp circuit board from the latch and pull it out from its guides.

Display and Display Board

- Undo 2 screws o.

µP Circuit Board

- Unscrew the front panel.
- Undo 4 screws k.

Keyboard Unit 1

- Dismount the UP board.
- Undo 4 screws l.

Diode Circuit Board

- Unscrew the front panel.
- Undo 2 screws r.

Headphone Socket Board

- Undo screw m.

Power Switch Circuit Board

- Release the power switch.
- Pull off the button from the power switch.
- Unscrew the front panel.
- Undo 2 screws n.

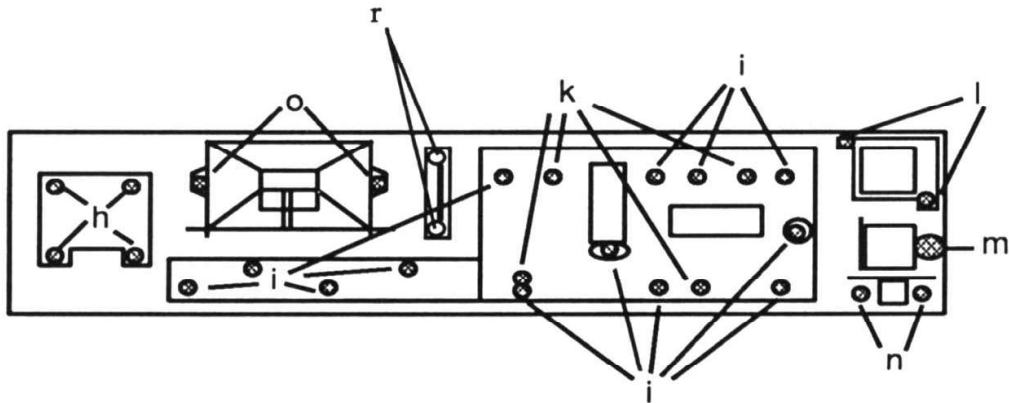

IR - Vorverstärker Baustein

- 2 Schrauben l heraus-schrauben.
- Baustein mit Halterung herausnehmen.
- Nase nach innen drücken.
- Baustein aus der Halterung ziehen.
- Beim Zusammenbau Masseverbindung (Lötstelle) wiederherstellen.

IR Preampfier Module

- Undo 2 screws l.
- Take out the module with its mounting.
- Push away the lug (inwards).
- Pull out the module from its mounting.
- Reestablish the connection to chassis (soldering joint) when reassembling.

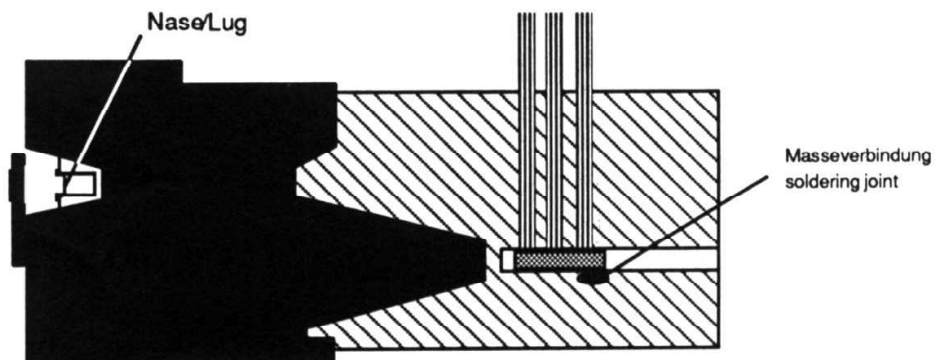

Gehäuse - Rückteil

- 3 Schrauben d heraus-schrauben.
- Rückteil abnehmen.

Buchsenplatte

- 4 Schrauben e und 2 Schrauben f heraus-schrauben.

Lautsprecher - Klemmenplatte

- Masseleitung ablöten.
- 2 Schrauben g heraus-schrauben.

Netzbuchsenplatte

- Gehäuse - Rückteil abnehmen.
- Netzbuchsen ablöten.

Rear Panel of Cabinet

- Undo 3 screws d.
- Remove the rear panel.

Socket Board

- Remove 4 screws e and 2 screws f.

Loudspeaker Terminal Board

- Unsolder the earthing wire.
- Undo 2 screws g.

Mains Socket Board

- Remove the rear of the cabinet.
- Unsolder the mains sockets.

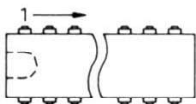
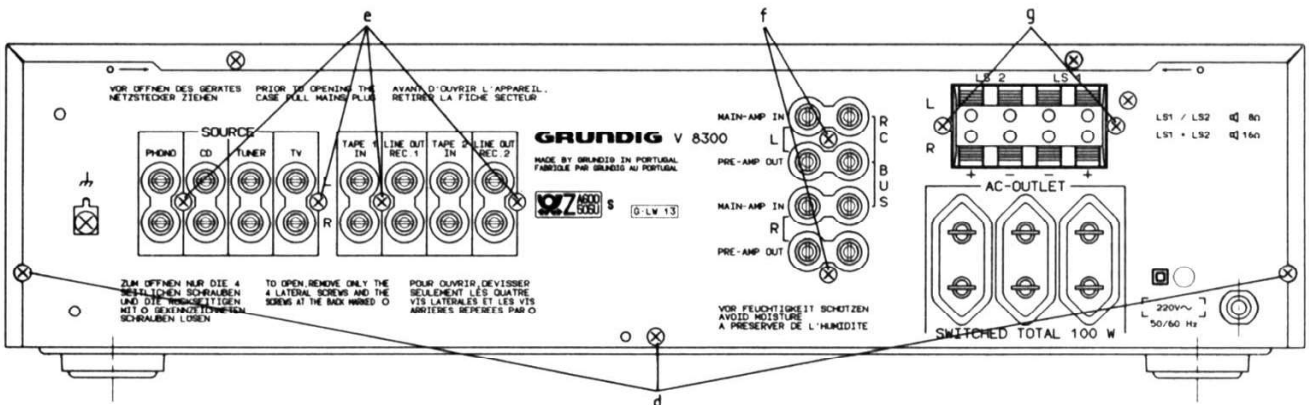

- 4099 B (MOS)
- SN74 LS 74N
- NMC 9306N (MOS)
- COP 420 RQM/N (MOR)
- COP 444 RQL/N (MOS)
- CX 789 (MOS)
- LM 339 N
- LM 833

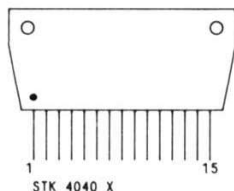

STK 4040 X

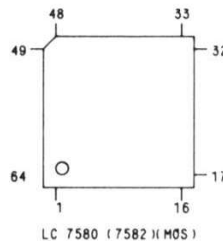

LC 7580 (7582) (MOS)

ACHTUNG!
VORSCHRIFTEN BEIM UMGANG MIT
MOS-Bauteilen BEACHTEN!
ATTENTION!
OBSERVE MOS COMPONENTS HANDLING
INSTRUCTIONS WHEN SERVICING!
ATTENTION!
LORS DE LA MANIPULATION DES
CIRCUITS MOS, RESPECTER LES
PRESCRIPTIONS MOS!
ATTENZIONE!
OSSERVARE LE RELATIVE PRESCRIZIONI
DURANTE I LAVORI CON COMPONENTI MOS!



E B C



BC328
BC546, BC548
BC556, BC558



B C E



BC637
BC639
BC640

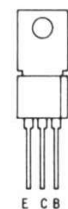

BD825
BD826

E C B

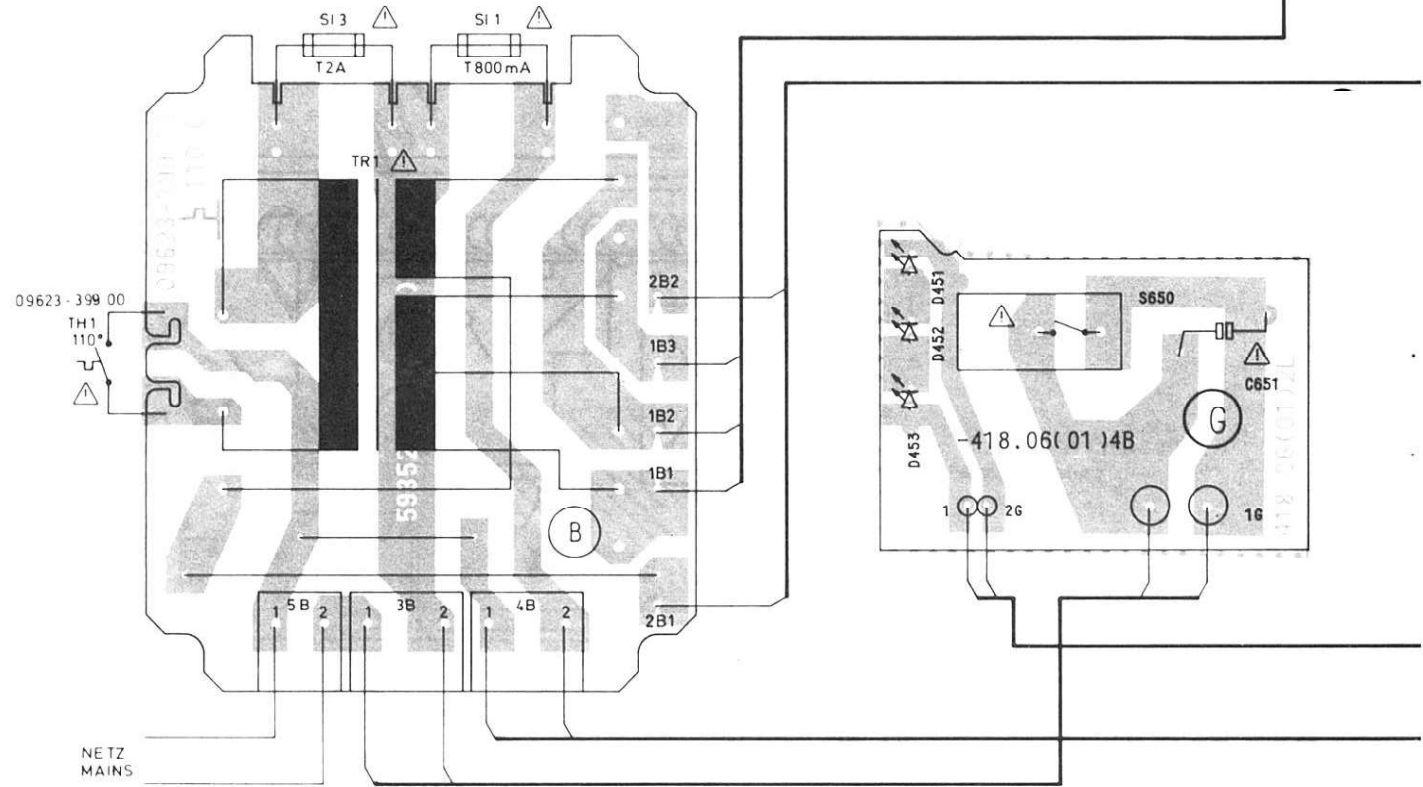
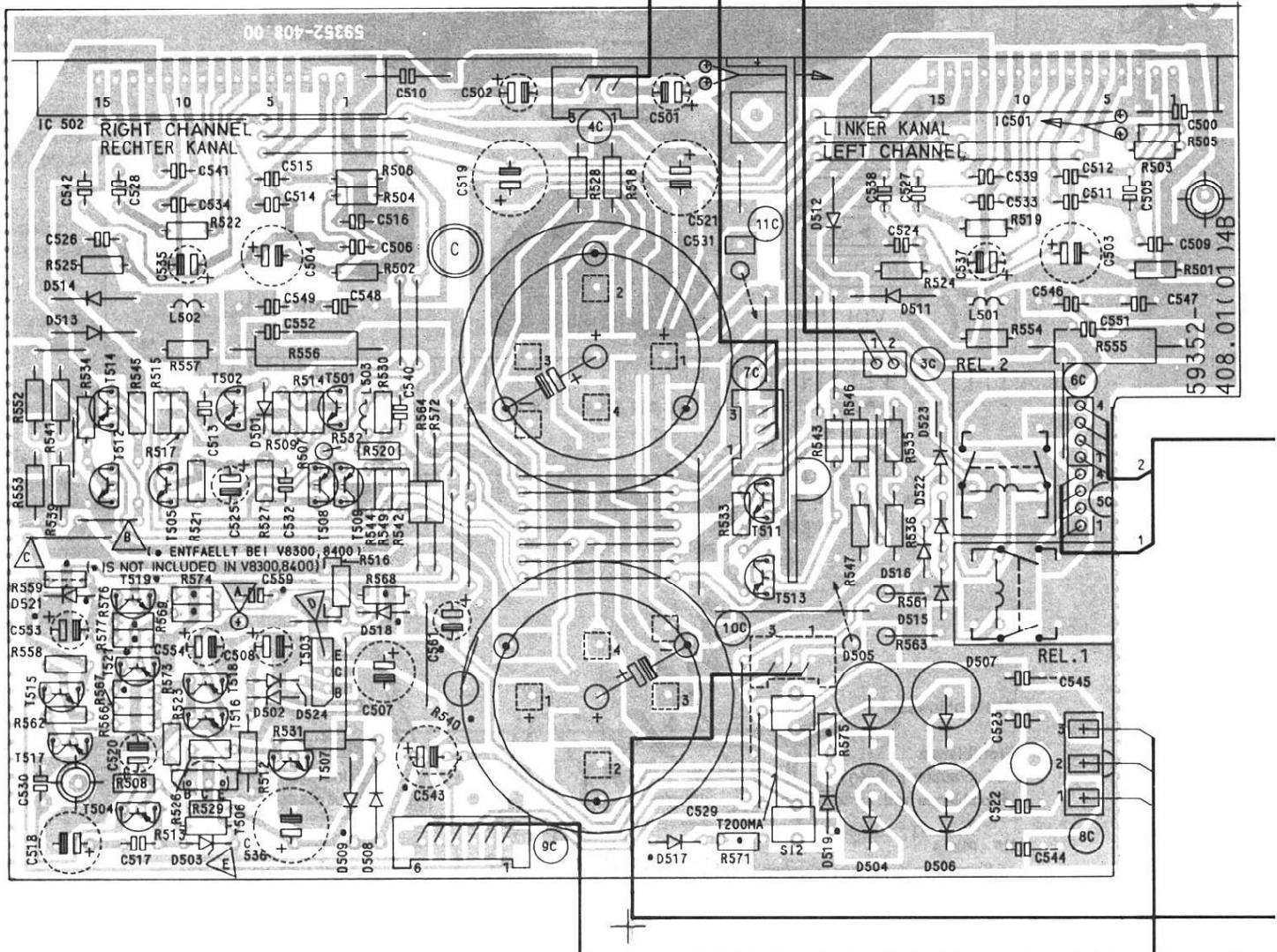
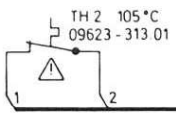

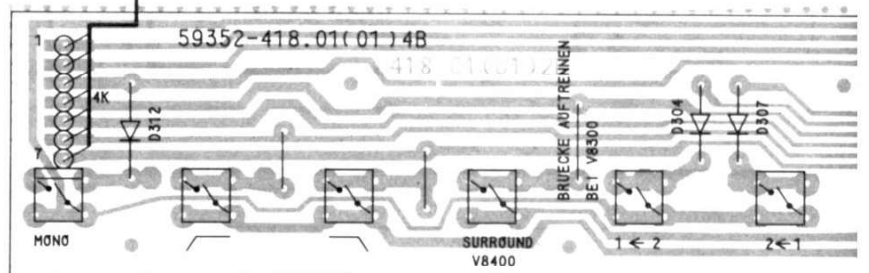
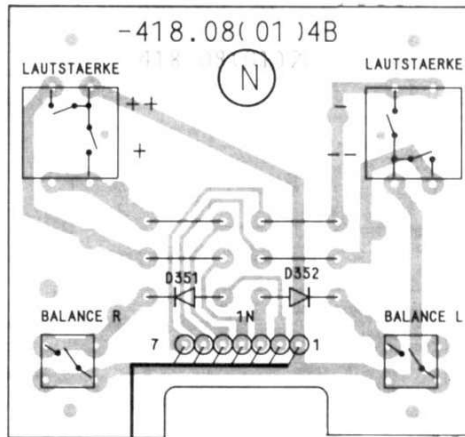
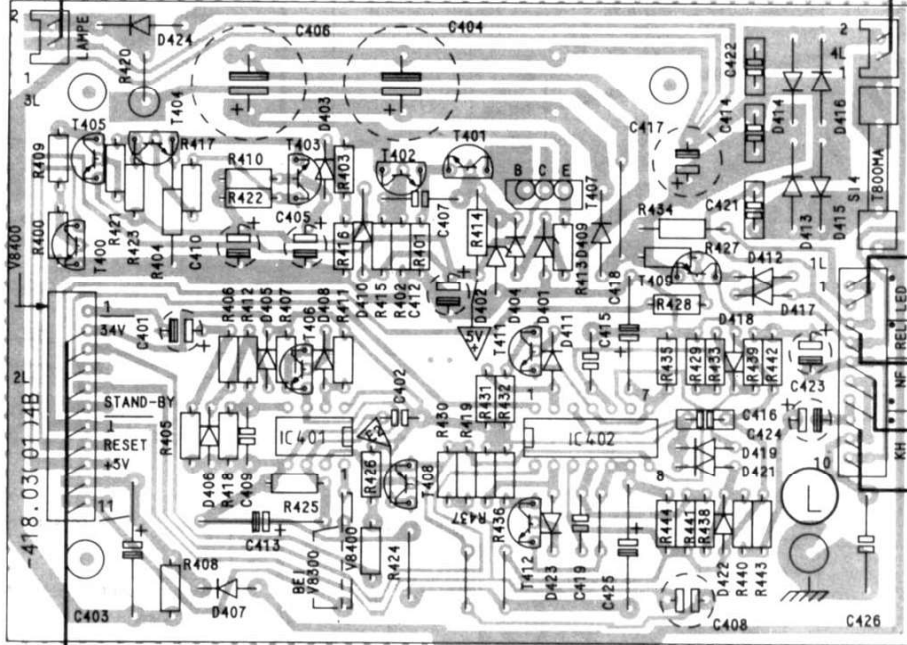
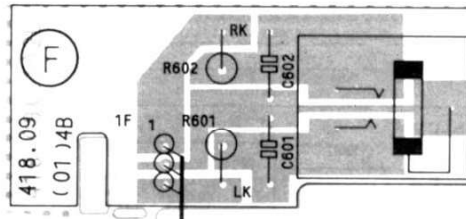
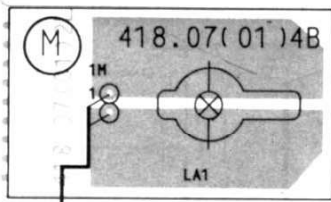

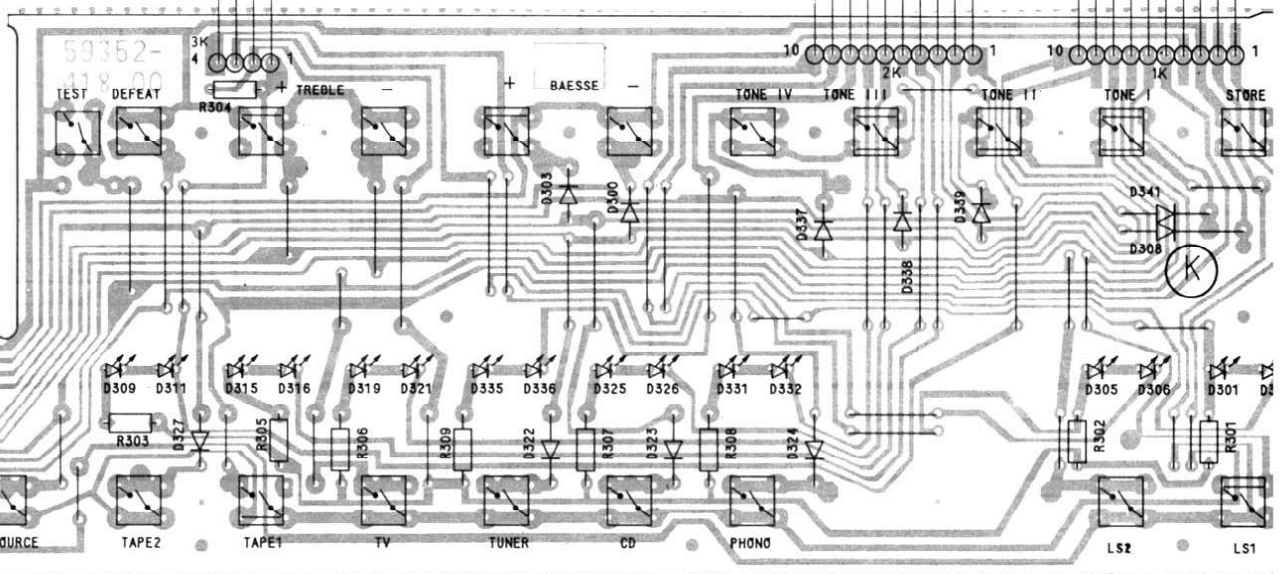
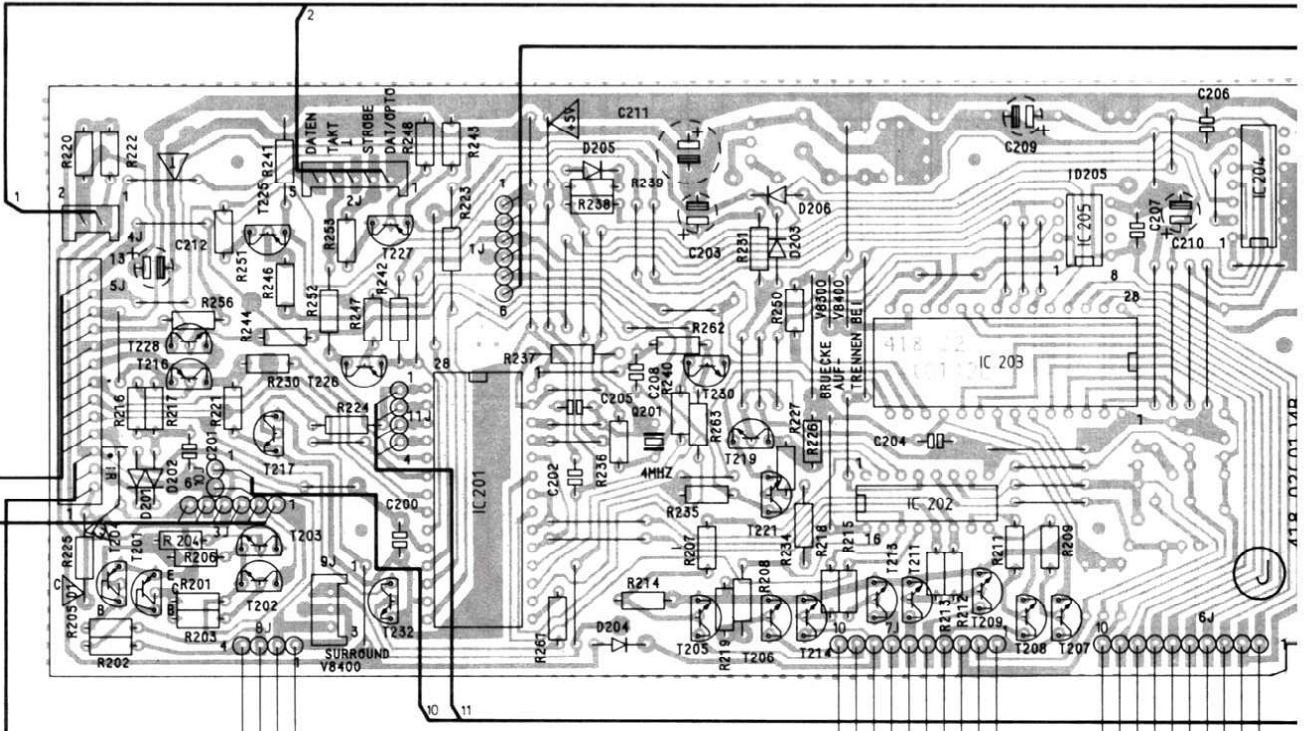
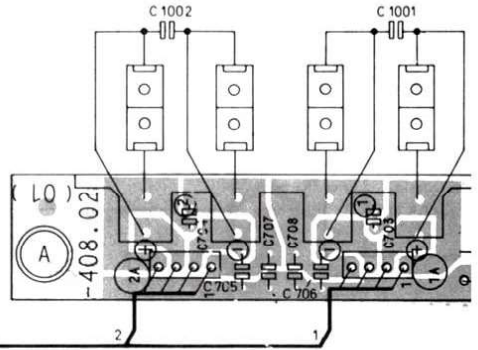
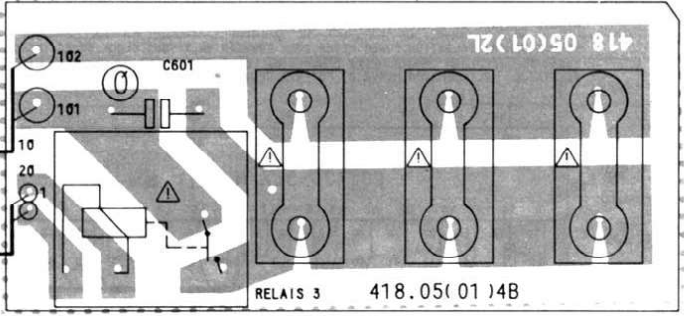

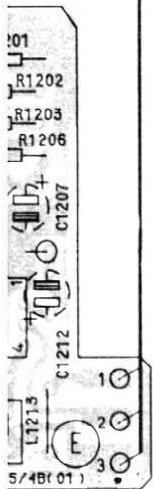
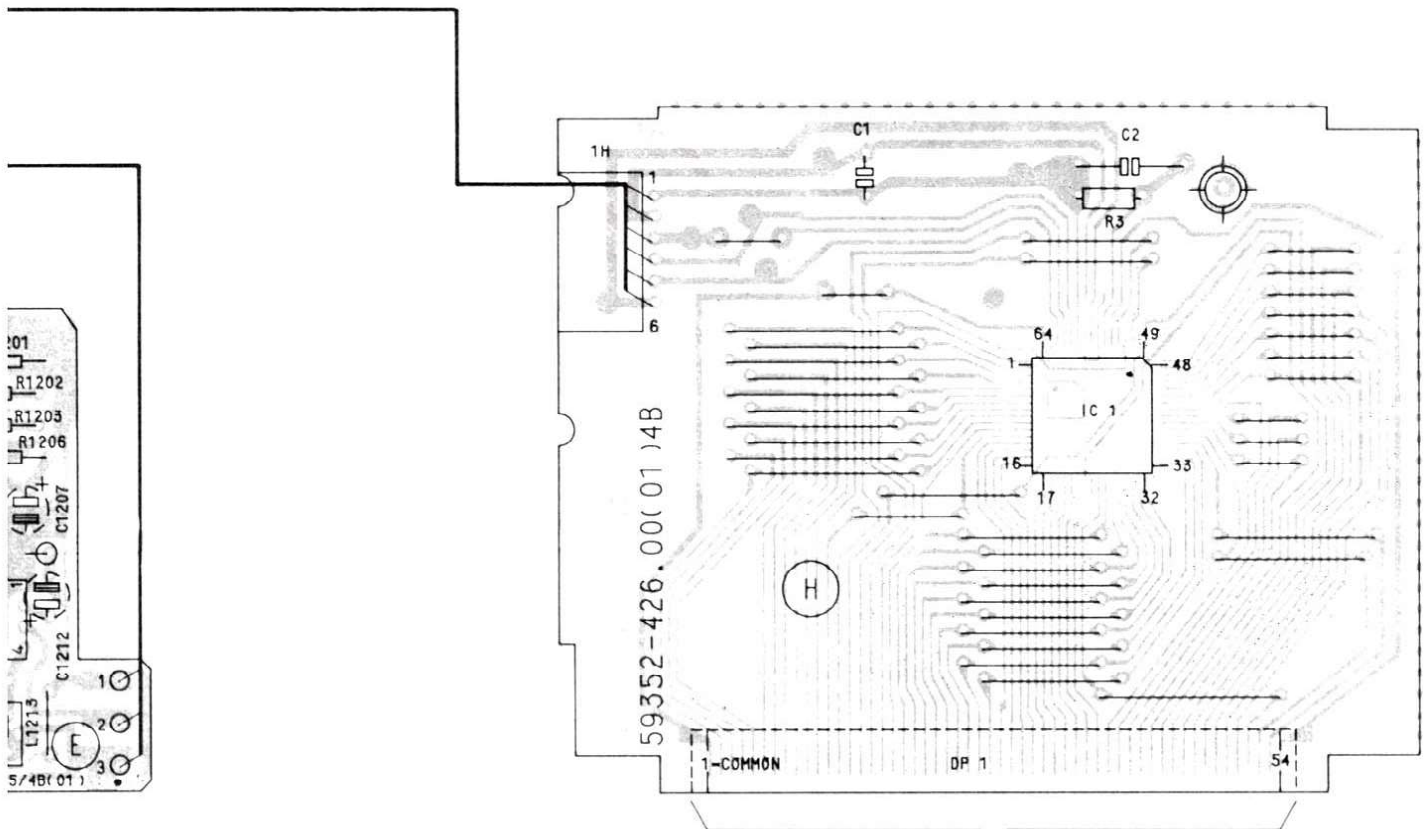
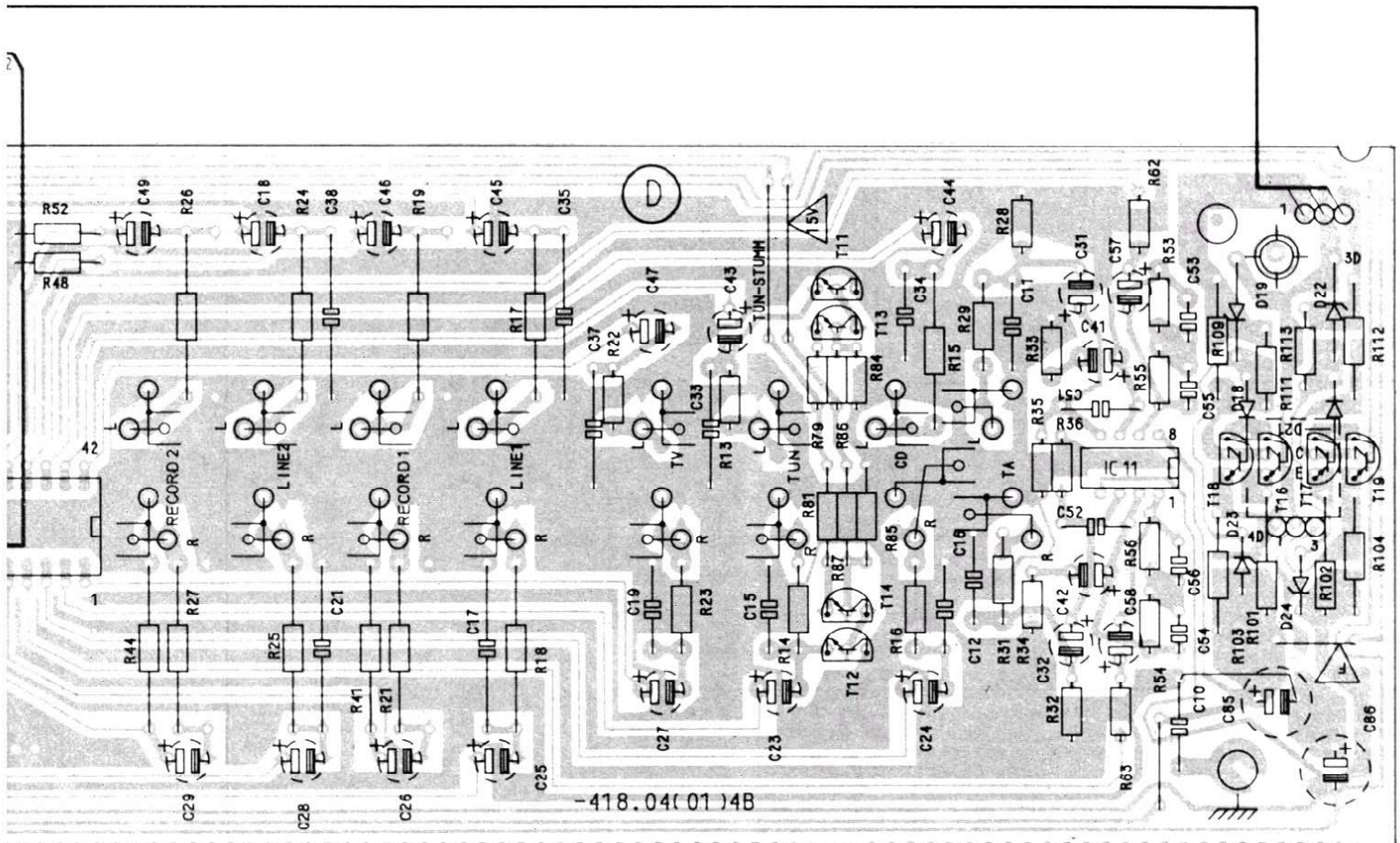

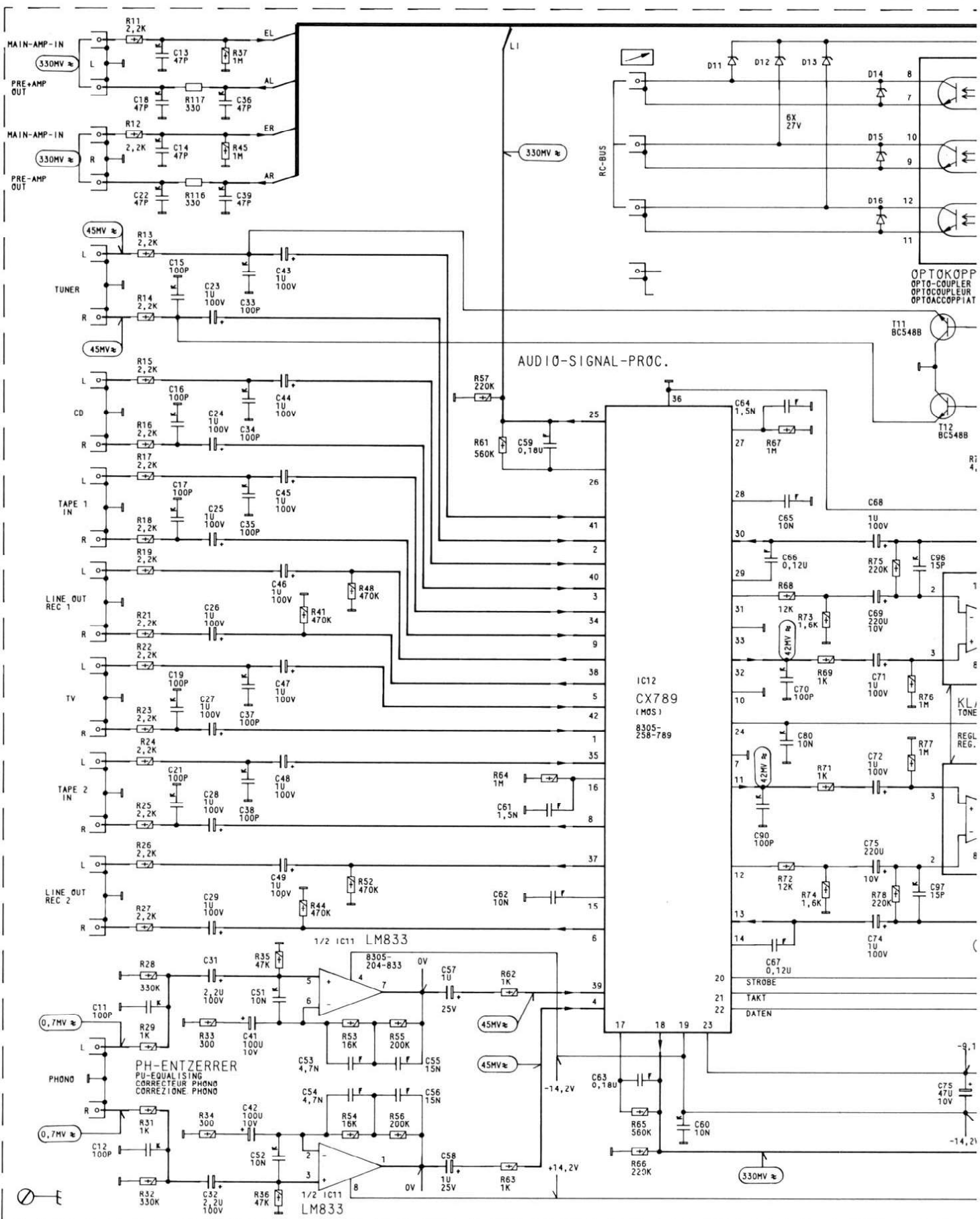

MESSPUNKTE
MEASURING POINTS

ABGLEICHPUNKTE
ALIGNMENT POINTS

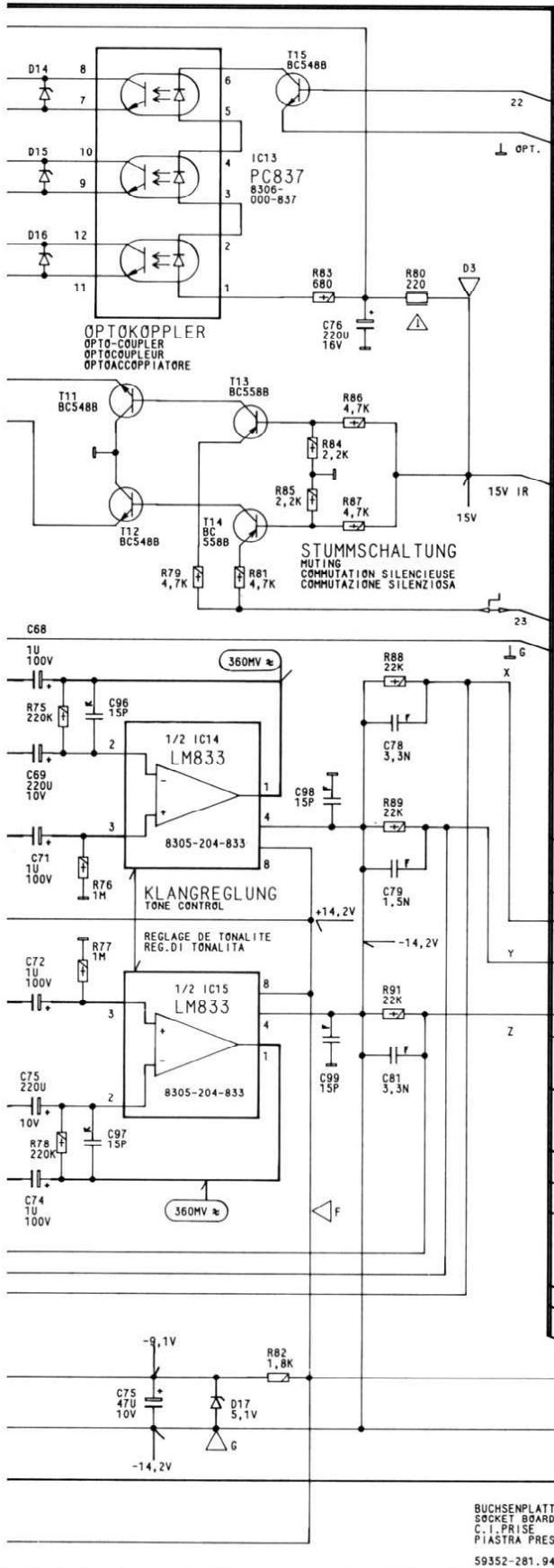

(D)

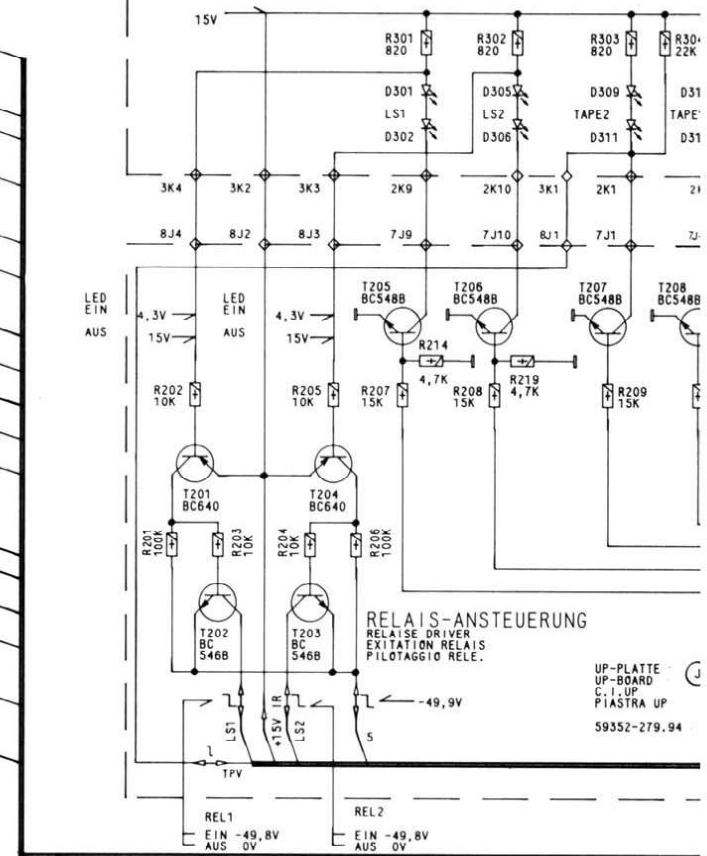
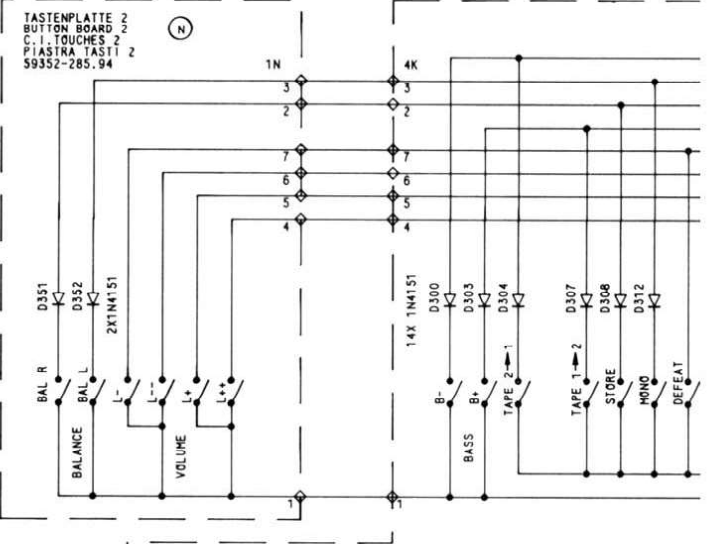
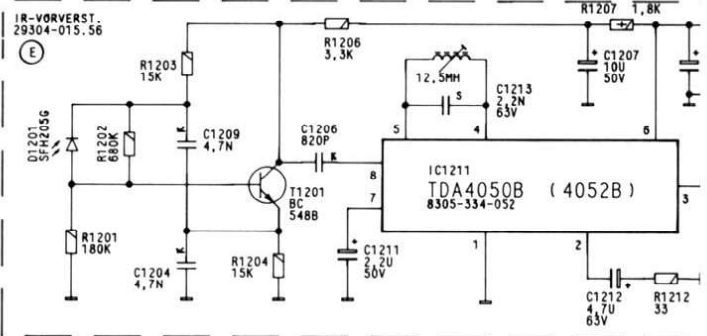

(J)

▽G ▽F ▽D3

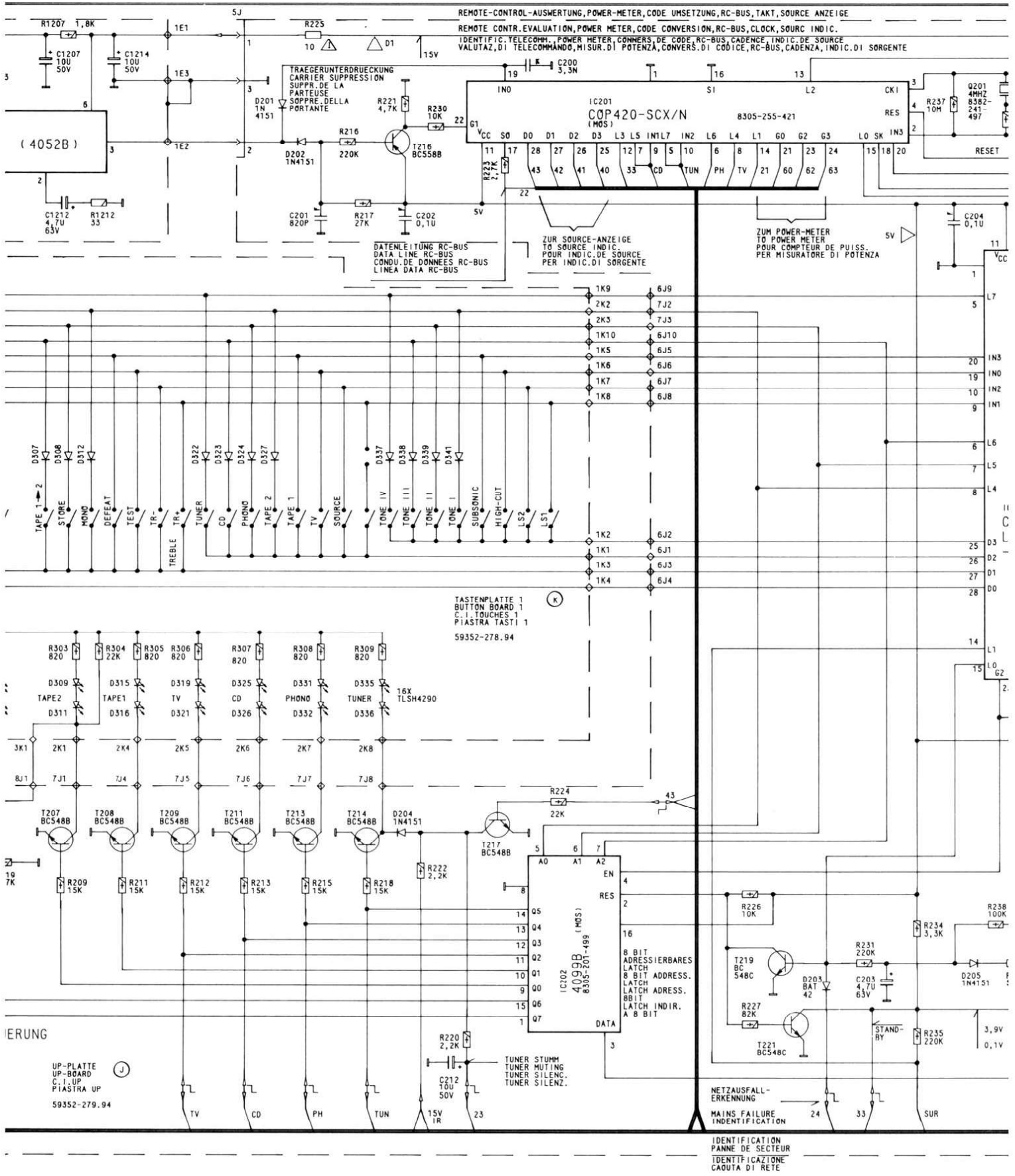

(H)
 DISPLAYPLATTE
 DISPL. BOARD
 C.I. DISPL.
 PIASTRA DISPL.
 59352-295.94

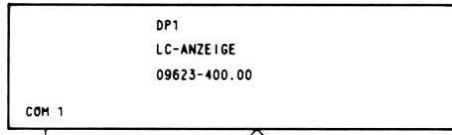

(L)
 NETZTEILPLATTE
 MAINS UNIT BOARD
 C.I. BLOC SECTEUR
 PIASTRA ALIMENTAT
 59352-707.94

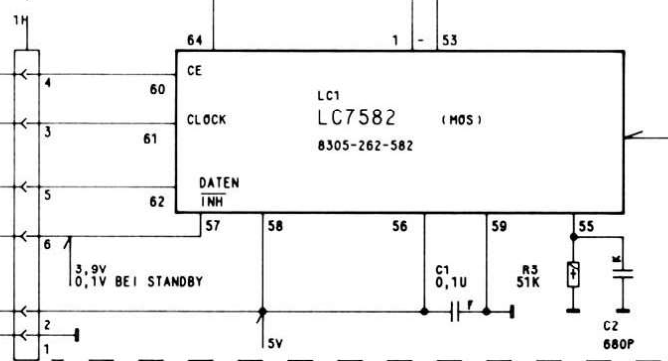

LC-DREIVER / DECODER
 LCD-DRIVER / DECODER
 LCD-DRIVER / DECODER
 LCD-PILOTA / DECODER

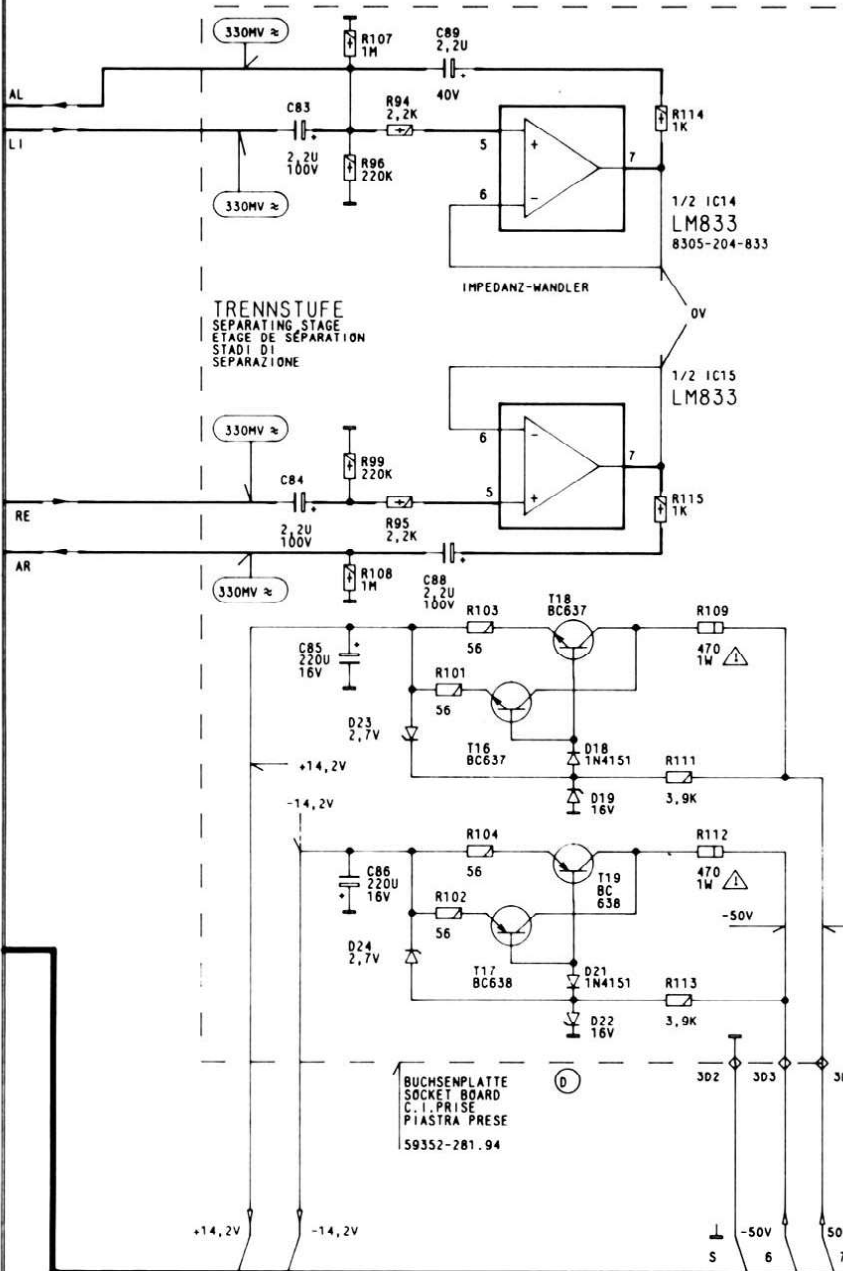

STAB. NETZTEIL
 MAINS UNIT
 BLOC SECTEUR STAB.
 ALIM. STAB.

(D)
 BUCHSENPLATTE
 SOCKET BOARD
 C.I. PRISE
 PIASTRA PRESE
 59352-281.94

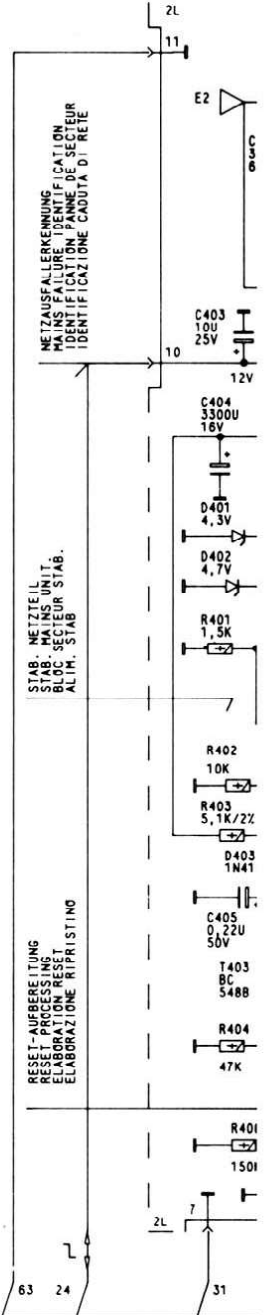

MESSPUNKTE
 MEASURING POINTS
 ABGLEICHPUNKTE
 ALIGNMENT POINTS

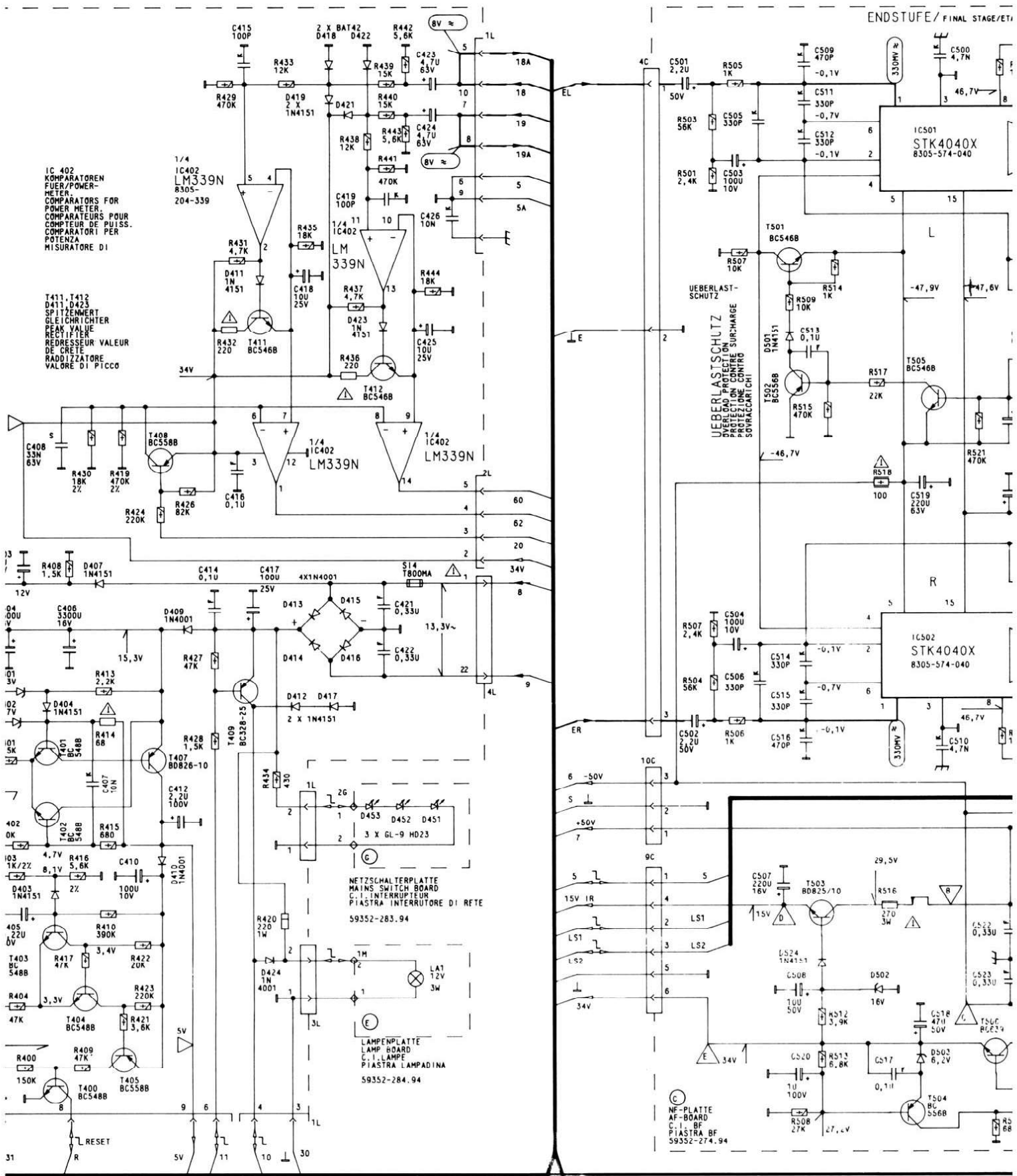

IC 402
KOMPARATOREN
FUER/POWER-
METER
COMPARATORS FOR
POWER METER
COMPARATEURS POUR
COMPTEUR DE PUISS.
COMPARATORI PER
POTENZA
MISURATORE DI

T411, T412
D411, D423
SPITZENWERT
GLEICHRICHTER
PEAK VALUE
RECTIFIER
REDRESSEUR VALEUR
DE CRETE
RADDIZZATORE
VALORE DI PICCO

NETZSCHALTERPLATTE
MANS SWITCH BOARD
C.I. INTERRUPTORE
PIASTRA INTERRUPTORE DI RETE
59352-283.94

LAMPENPLATTE
LAMP BOARD
C.I. LAMPE
PIASTRA LAMPADINA
59352-284.94

UEBERLASTSCHUTZ
OVERLOAD PROTECTION
PROTECTION CONTRE
SURCHARGE
SOVRAACCARICHI

ENDSTUFE/FINAL STAGE/ETI

CF-PLATTE
AF-BOARD
C.I. BF
PIASTRA BF
59352-274.94

STUFE / FINAL STAGE / ETAGE FINAL / STADIO FINALE

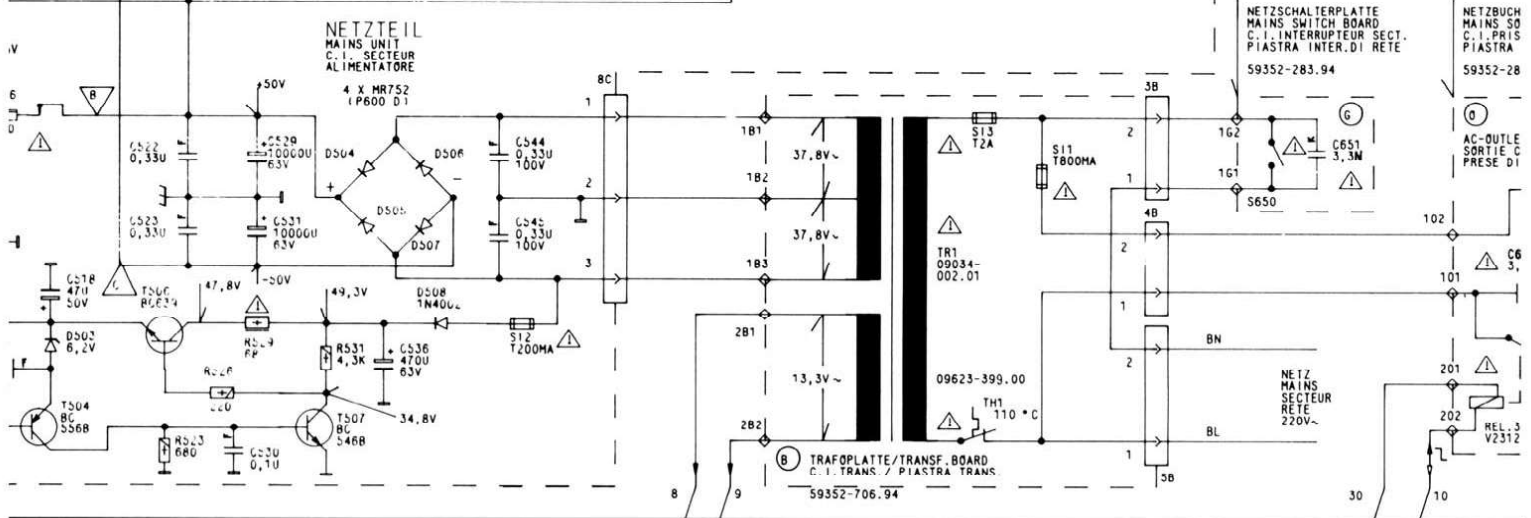
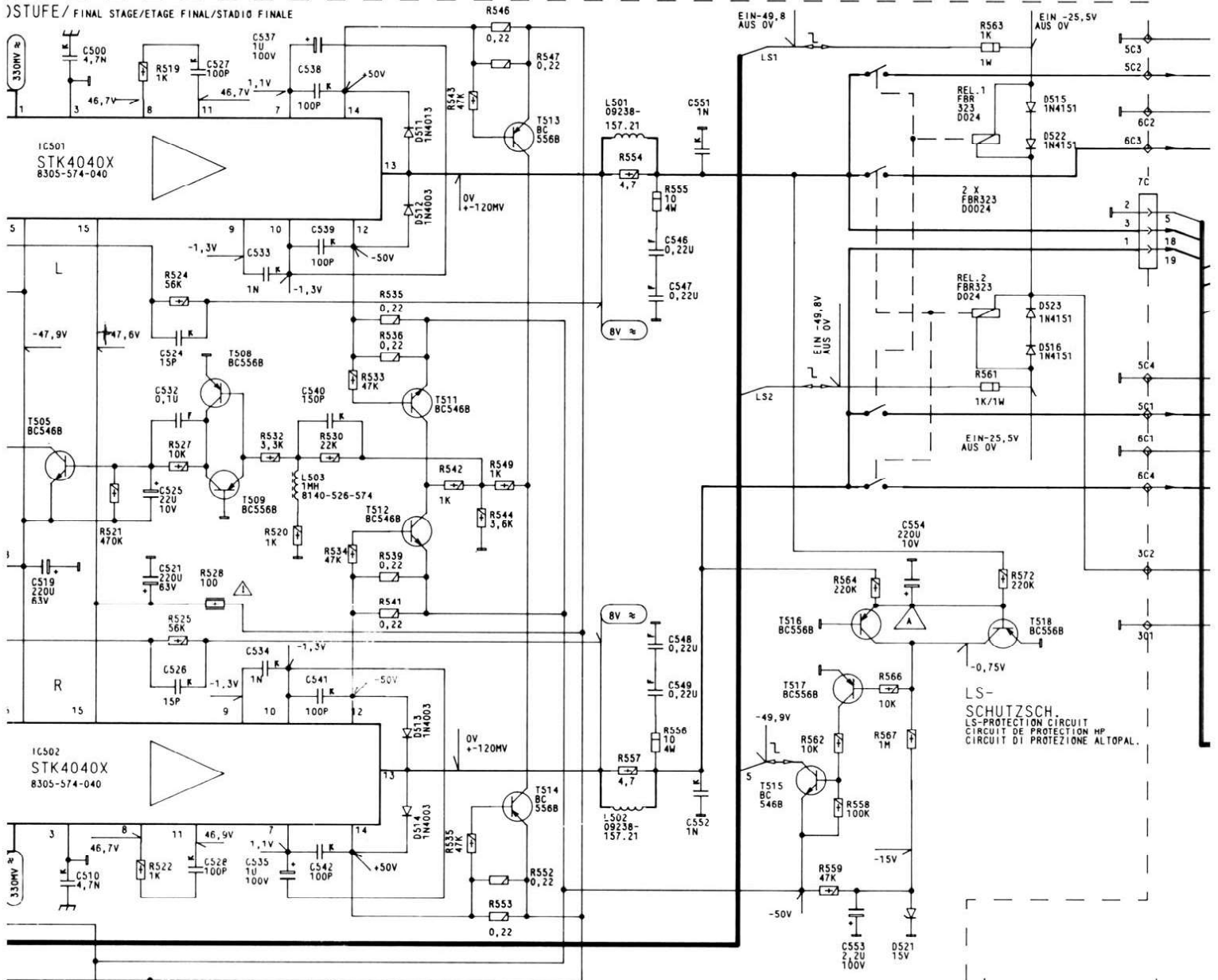

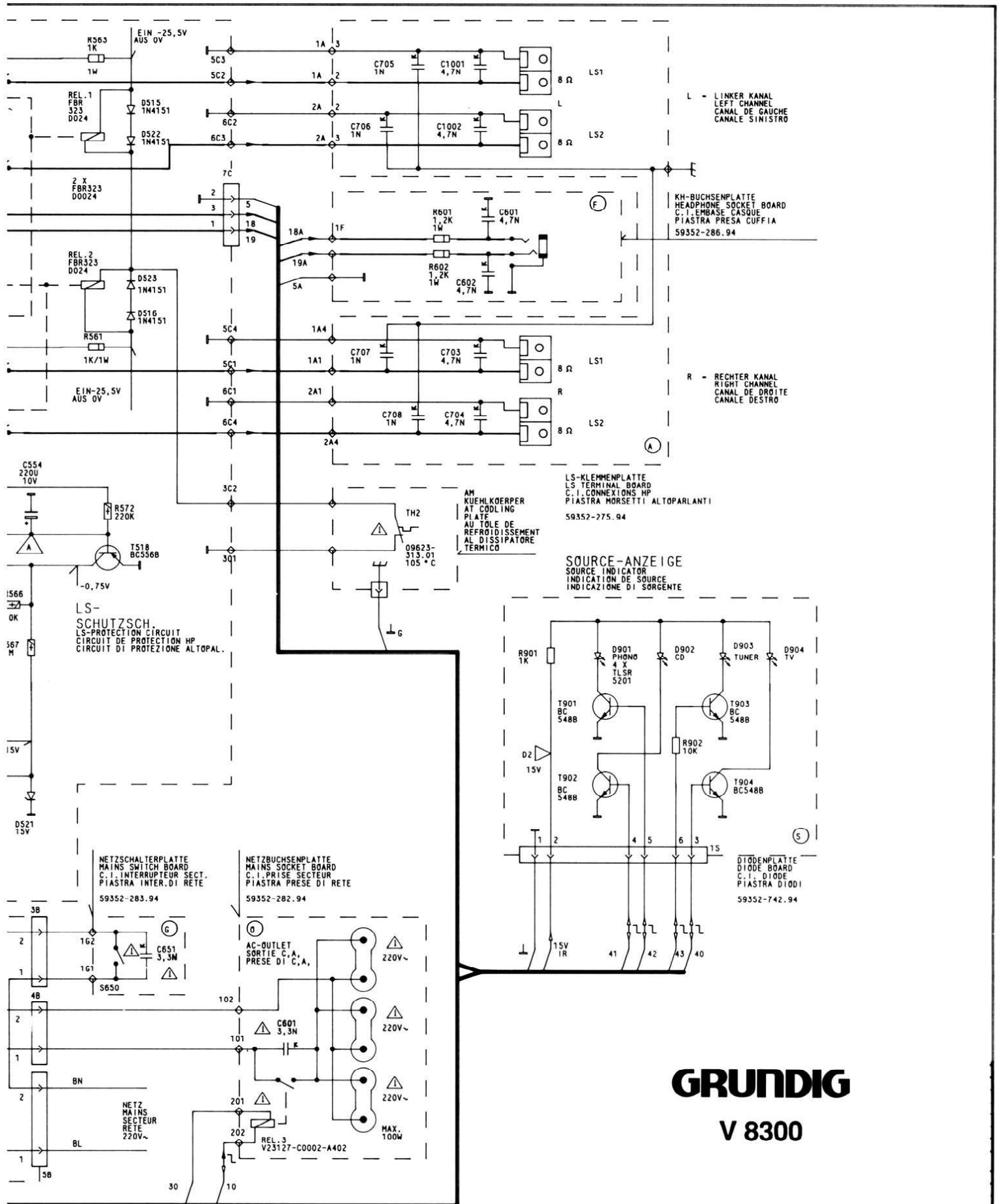

GRUNDIG
V 8300

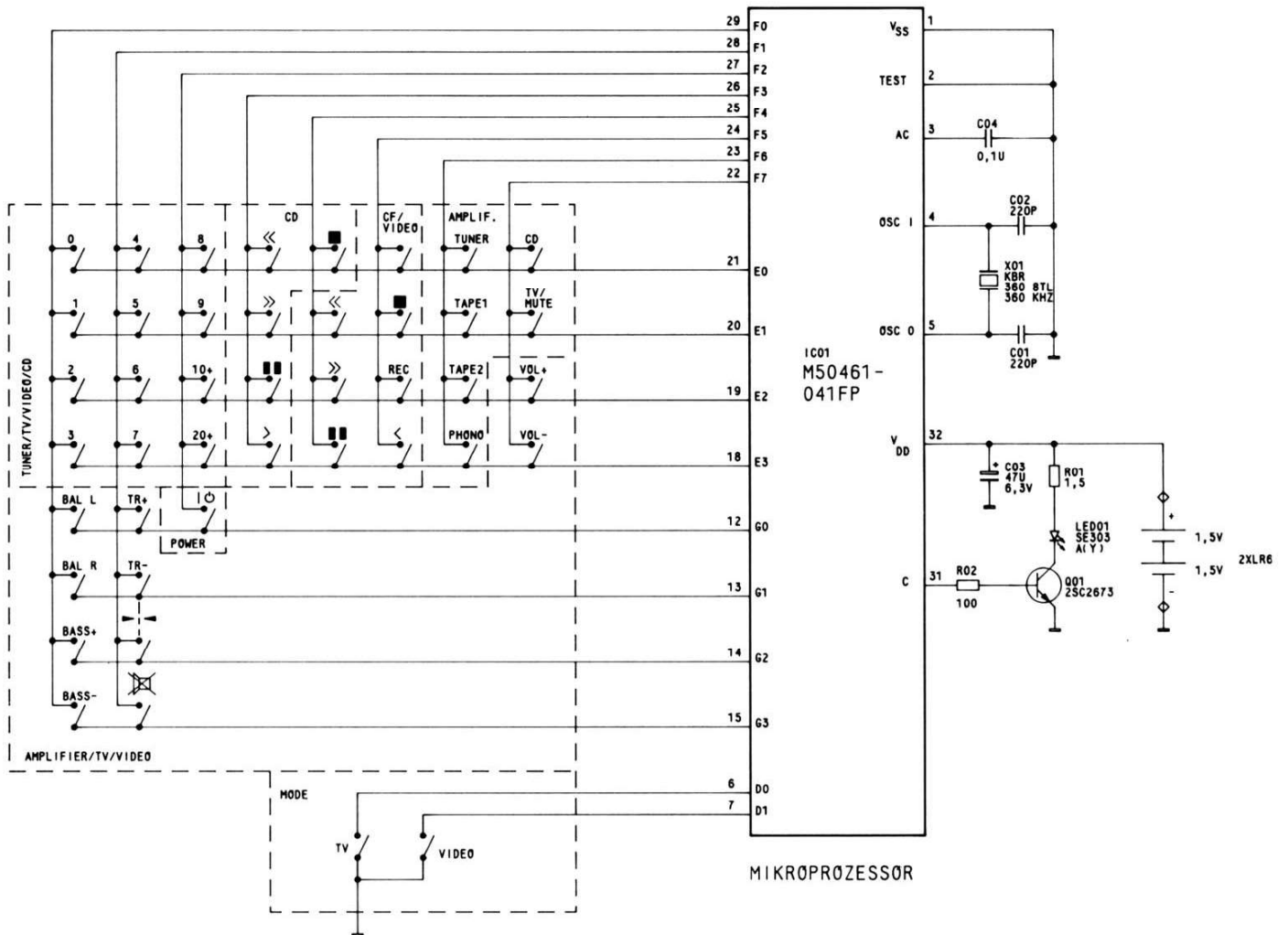

AENDERUNGEN VORBEHALTEN
SUBJECT TO ALTERATION
MODIFICAZIONI RISERVATE
CON RISERVA DI MODIFICA

- ⚠ FÜR DIE GERAETESICHERHEIT ABSOLUT NOTWENDIG UND ENTSPRECHEND DEN RICHTLINIEN DES VDE BZW. IEC. IM ERSATZFALL DÜRFEN NUR BAUTEILE MIT GLEICHER SPEZIFIKATION VERWENDET WERDEN.
- ⚠ ABSOLUTELY NECESSARY FOR THE SAFETY OF THE SET. THESE COMPONENTS MEET THE SAFETY REQUIREMENTS ACCORDING TO VDE OR IEC. RESP. AND MUST BE REPLACED BY PARTS OF SAME SPECIFICATION ONLY.
- ⚠ ABSOLUMENT NECESSAIRE POUR LA SECURITE DE L'APPAREIL ET CONFORME AUX REGULATIONS VDE ET IEC. EN CAS DE REMPLACEMENT. N'UTILISER QUE DES COMPOSANTS AVEC LES MEMES SPECIFICATIONS.
- ⚠ NECESSARI PER LA SICUREZZA DELL' APPARECCHIO E SONO CONFORMI ALLE NORMI DI SICUREZZA VDE E IEC. IN CASA DI SOSTITUZIONE IMPIEGARE QUINDI SOLTANTO PEZZI IN RICAMBIO ORIGINALI.

SPANNUNGEN MIT VOLTMETER (R1-10MΩ), FALLS NICHT ANDERS ANGEGEBEN, GEGEN MASSE GEMESSEN. MESSWERTE GELTEN BEI 220V~ NETZSPANNUNG.

IF NOT OTHERWISE INDICATED ALL VOLTAGES ARE MEASURED AGAINST CHASSIS WITH A VOLTMETER (R1-10MΩ). THE VALUES ARE VALID FOR 220V AC MAINS VOLTAGES.

SAUF INDICATION CONTRAIRE, LES TENSIONS SONT MEASUREES PAR RAPPORT AU CHASSIS AVEC UN VOLTMETRE (R1-10MΩ). LES VALEURS SONT VALABLES POUR UNE TENSION SECTEUR DE 220V~ CA.

TENSIONI MISURATE CON VOLTMETRO (R1-10MΩ), SALVE ALTRE INDICAZIONI, RIFERITE A MASSA. I VALORI DI MISURA VALGONO CON TENSIONE DI RETE DI 220V~.









NF-SPANNUNGEN BEI 2X8W AN 8 Ω -8V~ AM AUSGANG, 1KHZ, LAUTST. VOLL AUF, DEFEAT EIN, BALANCE MITTE, SUBSONIC UND HIGHCUT AUS, LAUTSPRECHERRELATS EIN.

AF VOLTAGES 2X8W INTO 8 Ω -8V~ AM OUTPUT 1KHZ, VOLUME FULLY UP, DEFEAT ON, BALANCE IN CENTRE SETTING, SUBSONIC AND HIGHCUT OFF, LOUDSPEAKER SWITCHES ON.













TENSIONI BF POUR 2X8W SUR 8 Ω -8V~ A LA SORTIE 1KHZ, VOLUME AU MAXIMUM, DEFEAT INSERTE, REGLAGES DE BALANCE EN POSITION MEDIANE, SUBSONIC ET HIGHCUT HORS SERVICE, COMMUTEUR HAUT-PARLEURS EN SERVICE.





TENSIONI BF ALL' USCITA CON 2X8W E 8 Ω -8V~ 1KHZ, VOLUME AL MASSIMO, DEFEAT INSERITI, BILANCIAMENTO AL CENTRO, SUBSONIC E HIGHCUT DISINSERITO, COMMUTATORI DEGLI ALTOPARLANT, INSERITI.

KONDENSATOR/CAPACITOR
CONDENSATEUR/CONDENSATORE

-  ELKO
ELECTROLYTIC
ELECTROLYTIQUE
Elettrolitico
-  TANTALUM ELKO
TANTALUM ELECTROLYTIC
ELECTROLYTIQUE AU TANTALE
Elettrolitico al tantalio
-  FOLIE
FOIL
A FEUILLE
A FOGLIA
-  KERAMIK
CERAMIC
CERAMIQUE
A CERAMICA
-  GLIMMER
MICA
AU MICA
A MICA
-  VIELSCHICHT
MULTILAYER
A COUCHES MULTIPLES
A PIU' STRATI
-  POLYPROPYLEN
(KS-KP)





WIDERSTAND/RESISTOR
RESISTANCE/RESISTENZA

-  KSW 0204 DIN
-  MSW 0204 DIN
-  KSW 0207 DIN
-  MSW 0207 DIN
-  KSW 0309 DIN
KSW 0411 DIN
-  KSW 0617 DIN
-  MSW 0309 DIN
-  NTC
-  DRAHT
WIRE
BOBINEE
A FILO
-  METALL OXYDSCHICHT
METAL OXIDE
A OXYDE METALLIQUE
AD OSSIDO METALLICO
-  RAUSCHARM
LOW NOISE
A SOUFFLE REDUIT
A BASSO RUMORE
-  SCHWER ENTFLAMMBAR
LOW FLAMMABILITY
PEU INFLAMMABLE
A BASSA INFLAMMABILITA
-  SICHERUNGSWIDERSTAND
SAFETY RESISTOR
FUSIBLE
DI SICUREZZA

-  GLEICHSPANNUNG
DC-VOLTAGE
TENSION CONTINUE
TENSION CONTINUA
-  WECHSELSPANNUNG
AC-VOLTAGE
TENSION ALTERNATIVE
TENSIONE ALTERNATA
-  REGELSPANNUNG
CONTROL VOLTAGE
TENSION DE REGLAGE
TENSIONE DI CONTROLLO
-  ABSTIMMSPANNUNG
TUNING VOLTAGE
TENSION DE SYNTONISATION
TENSIONE DI SINTONIA
-  SCHALTSPANNUNG
SWITCHING VOLTAGE
TENSION DE COMMUTATION
TENSIONE DI COMMUTAZIONE

Pos. No.	Fig. No.	Bestell-Nr./Part No. Réf./Nr. d'ordinazioni	Benennung	Description	Désignation	Denominazione
1		55098-500-01	Frontblende kpl.	Front panel compl.	Facade cpl.	Mascher.frontale cpl.
1,13		55092-220.01	Power-taste	Power-button	Touche secteur	Tasto di rete
3		55051-014.01	4x Fuß I	Foot I	Pied I	Piedino I
4		55051-015.00	4x Fuß	Foot	Pied	Piedino
5		09623-404.00	3x Kaltgerätedose N	Socket N	Embase N	Presà N
6		09666-449.00	Zugentlastung	Cord grip	Arretoiè cable	Fermacavo
7		8290-991.201	Netzkabel	Mains lead	Cable Sectuer	Cavo di rete
10		59400-305.00	27x Tipptaste	Pushbutton	Touche	Micro-tasto
11		59500-114.00	2x Doppelhub-Tippschalter	Pushbutton	Touche	Micro-tasto
12		59400-321.00	Netzschalter	Mains switch	Interrupteur Sect.	Interruttore di rete
13		09621-161.00	Federklemme 8 fach	Spring terminal (8-fold)	Recordement HP	Fermo anolla (8x)
14		29303-390.11	Kopfhörerbuchse	Ear phone socket	Prise Ecouteur	Presà cuffia
15		09623-405.00	3x Chinchbuchse	Cinchsocket	Embase Cinch	Presà cinch
16		09034-002.01	Netztrafo	Mains transformer	Transf. alim.	Transf. di rete
17		09602-298.00	4x Sicherungshalter	Fuse contact	Support fusible	Supporto fusibile
18		09623-399.00	Thermoschalter 110°C	Thermal cut-out 110°C	Disioncteur therm.110°C	Commutatore termico 110°C
20		09621-113.02	2x Sicherungshalter	Fuse contact	Supprt fusible	Supporto fusibile
21		09623-313.01	Thermoschalter 105°C	Thermal cut-out 105°C	Disioncteur therm.105°C	Commutatore termico
22		09618-138.00	Haltefeder	Holder spring	Support ressort	Molla di supporto
25		29304-015.56	IR-Vorverstärker	Preamplifier	Preamplifier	Preamplificatore
26		59800-709.01	IR-Geber	Remote control	Emetteur	Telecomando
27		55097-825.00	Display-Baustein	Module	Module	Modulo

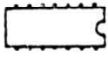
Pos. No.	Fig. No.	Bestell-Nr./Part No. Réf./Nr. d'ordinazioni	Benennung Description Désignation Denominazione
----------	----------	---	---

		09623-295.94	
			
L 11		8140-526.417	115 µH
L 12		8140-526.417	115 µH
L 501		09238-157.21	
L 502		09238-157.21	
L 503		8140-526-418	1 µH
L 1213		29503-910.55	
			
Rel 1		8312-003-324	FBR 323 D 024
Rel 2		8312-003-324	FBR 323 D 024
Rel 3		8312-027-102	V 23127 - C 0002
			
Q 201		8382-241-497	4 MHz
			
IC 1		8305-262-582	LC 7582
IC 11		8305-204-833	LM 833
IC 12		8305-258-789	CX 789
IC 13		8306-000-837	PC 837
IC 14		8305-204-833	LM 833
IC 15		8305-204-833	LM 833
IC 201		8305-255-421	COPN 420 RQM/N
IC 202		8305-201-499	4099 B
IC 203		8305-255-444	COP L 444 RQL/N
IC 204		8305-199-074	SN 74 LS
IC 205		8305-311-306	NMC 9306 N
IC 402		8305-204-339	LM 339 N
IC 501		8305-574-040	STK 4040 X
IC 502		8305-574-040	STK 4040 X
IC 1211		8305-334-052	TDA 4052
			
T 11		8302-202-543	BC 548 B
T 12		8302-202-543	BC 548 B
T 13		8302-200-559	BC 558 B
T 14		8302-200-559	BC 558 B
T 15		8302-202-543	BC 548 B
T 16		8302-200-637	BC 637
T 17		8302-200-638	BC 638
T 18		8302-200-637	BC 637
T 19		8302-200-638	BC 638
T 201		8302-200-640	BC 640
T 202		8302-200-542	BC 546 B
T 203		8302-200-542	BC 546 B
T 204		8302-200-640	BC 640
T 205		8302-202-543	BC 548 B
T 206		8302-202-543	BC 548 B
T 207		8302-202-543	BC 548 B
T 208		8302-202-543	BC 548 B
T 209		8302-202-543	BC 548 B
T 211		8302-202-543	BC 548 B



Pos. No.	Fig. No.	Bestell-Nr./Part No. Réf./Nr. d'ordinazioni	Benennung Description Désignation Denominazione
----------	----------	---	---



T 213		8302-202-543	BC 548 B
T 214		8302-202-543	BC 548 B
T 216		8302-200-559	BC 558 B
T 217		8302-202-543	BC 548 B
T 219		8302-202-543	BC 548 B
T 221		8302-202-543	BC 548 B
T 225		8302-200-559	BC 558 B
T 226		8302-200-559	BC 558 B
T 227		8302-200-559	BC 558 B
T 228		8302-202-543	BC 548 B
T 230		8302-202-543	BC 548 B
T 232		8302-202-543	BC 548 B
T 407		8302-210-834	BD 826-10
T 501		8302-200-542	BC 546 B
T 502		8302-501-557	BC 556 B
T 503		8302-210-821	BD 825-10
T 504		8302-501-557	BC 556 B
T 505		8302-200-542	BC 546 B
T 506		8302-202-639	BC 639
T 507		8302-200-542	BC 546 B
T 508		8302-501-557	BC 556 B
T 509		8302-501-557	BC 556 B
T 511		8302-200-542	BC 546 B
T 512		8302-200-542	BC 546 B
T 513		8302-501-557	BC 556 B
T 514		8302-501-557	BC 556 B
T 515		8302-200-542	BC 546 B
T 516		8302-501-557	BC 556 B
T 517		8302-501-557	BC 556 B
T 518		8302-501-557	BC 556 B
T 901		8302-202-543	BC 548 B
T 902		8302-202-543	BC 548 B
T 903		8302-202-543	BC 548 B
T 904		8302-202-543	BC 548 B
T 1204		8302-200-550	BC 549 B
			
D 11		8309-720-270	ZD 27 C
D 12		8309-720-270	ZD 27 C
D 13		8309-720-270	ZD 27 C
D 14		8309-720-270	ZD 27 C
D 15		8309-720-270	ZD 27 C
D 16		8309-720-270	ZD 27 C
D 17		8309-720-051	ZD 5.1 B
D 18		8309-215-041	1 N 4151
D 19		8309-720-160	ZD 16 C
D 21		8309-215-041	1 N 4151
D 22		8309-720-160	ZD 16 C
D 23		8309-720-028	ZD 2.7 B
D 24		8309-720-028	ZD 2.7 B
D 201		8309-215-041	1.N 4151
D 202		8309-215-041	1.N 4151
D 203		8309-202-146	BAT 42
D 204		8309-215-041	1 N 4151
D 205		8309-215-041	1 N 4151
D 206		8309-202-146	BAT 42
D 301		8309-944-240	TLSH 4290

Pos. No.	Fig. No.	Bestell-Nr./Part No. Réf./Nr. d'ordinazioni	Benennung Description Désignation Denominazione
----------	----------	---	---

D 302		8309-944-240	TLSH 4290
D 305		8309-944-240	TLSH 4290
D 306		8309-944-240	TLSH 4290
D 309		8309-944-240	TLSH 4290
D 311		8309-944-240	TLSH 4290
D 315		8309-944-240	TLSH 4290
D 316		8309-944-240	TLSH 4290
D 319		8309-944-240	TLSH 4290
D 321		8309-944-240	TLSH 4290
D 325		8309-944-240	TLSH 4290
D 326		8309-944-240	TLSH 4290
D 331		8309-944-240	TLSH 4290
D 332		8309-944-240	TLSH 4290
D 335		8309-944-240	TLSH 4290
D 336		8309-944-240	TLSH 4290
D 402		8309-720-046	ZD 4.7 B
D 451		8309-925-024	GL 9 HD 23
D 452		8309-925-024	GL 9 HD 23
D 453		8309-925-024	GL 9 HD 23
D 501		8309-215-050	1 N 4148
D 502		8309-720-161	ZD 16 B
D 503		8309-720-064	ZD 6.2 B
D 504		8309-712-752	MR 752
D 505		8309-712-752	MR 752
D 506		8309-712-752	MR 752
D 507		8309-712-752	MR 752
D 508		8309-215-009	1 N 4002
D 511		8309-215-030	1 N 4003
D 512		8309-215-030	1 N 4003
D 513		8309-215-030	1 N 4003
D 514		8309-215-030	1 N 4003
D 515		8309-215-050	1 N 4148
D 516		8309-215-050	1 N 4148
D 522		8309-215-050	1 N 4148
D 523		8309-215-050	1 N 4148
D 524		8309-215-050	1 N 4148
D 1201		8309-211-705	SFH 205 G
			
D 901		8309-921-525	TLSR 5201
D 902		8309-921-525	TLSR 5201
D 903		8309-921-525	TLSR 5201
D 904		8309-921-525	TLSR 5201

Pos. No.	Fig. No.	Bestell-Nr./Part No. Réf./Nr. d'ordinazioni	Benennung Description Désignation Denominazione
----------	----------	---	---

			
C 529		8414-006-055	10.000 µF/63 V
C 530		8414-006-055	10.000 µF/63 V
C 531		8414-006-055	10.000 µF/63 V
C 601		8660-097-241	3300 pF
C 651		8660-097-241	3300 pF

			
R 80		8700-217-057	220 Ω n.B.
R 109		8705-227-065	470 Ω
R 112		8705-227-065	470 Ω
R 225		8701-118-025	10 Ω
R 414		8766-701-045	68 Ω
R 420		8705-459-077	220 Ω
R 432		8766-701-057	220 Ω
R 436		8766-701-057	220 Ω
R 516		8730-239-059	3 W/ 270 Ω
R 518		8700-197-049	100 Ω
R 528		8700-197-049	100 Ω
R 529		8700-197-045	68 Ω
R 535		8765-097-985	0.22 Ω
R 536		8765-097-985	0.22 Ω
R 539		8765-097-985	0.22 Ω
R 541		8765-097-985	0.22 Ω
R 546		8765-097-985	0.22 Ω
R 547		8765-097-985	0.22 Ω
R 552		8765-097-985	0.22 Ω
R 553		8765-097-985	0.22 Ω
R 554		8765-097-017	4.7 Ω
R 555		8705-279-025	10 Ω
R 556		8705-279-025	10 Ω
R 557		8765-097-017	4.7 Ω
R 561		8705-327-273	1 K Ω
R 563		8705-327-273	1 K Ω
R 601		8705-459-075	1.2 K Ω
R 602		8705-459-075	1.2 K Ω

			
Si 1		8315-616-003	800 MA/T
Si 2		8315-610-002	200 MA/T
Si 3		8315-620-003	2 A/T
Si 4		8315-616-003	800 MA/T

			
LA 1		8136-490-123	12 V/3W

Bedienungsanleitung Instruction book Mode d'emploi
55098-941.01 55098-941.01 55098-941.01

Istruzioni d'uso
55098-941.01