

**THE**  
**hafler**  
**POWER AMPLIFIER**

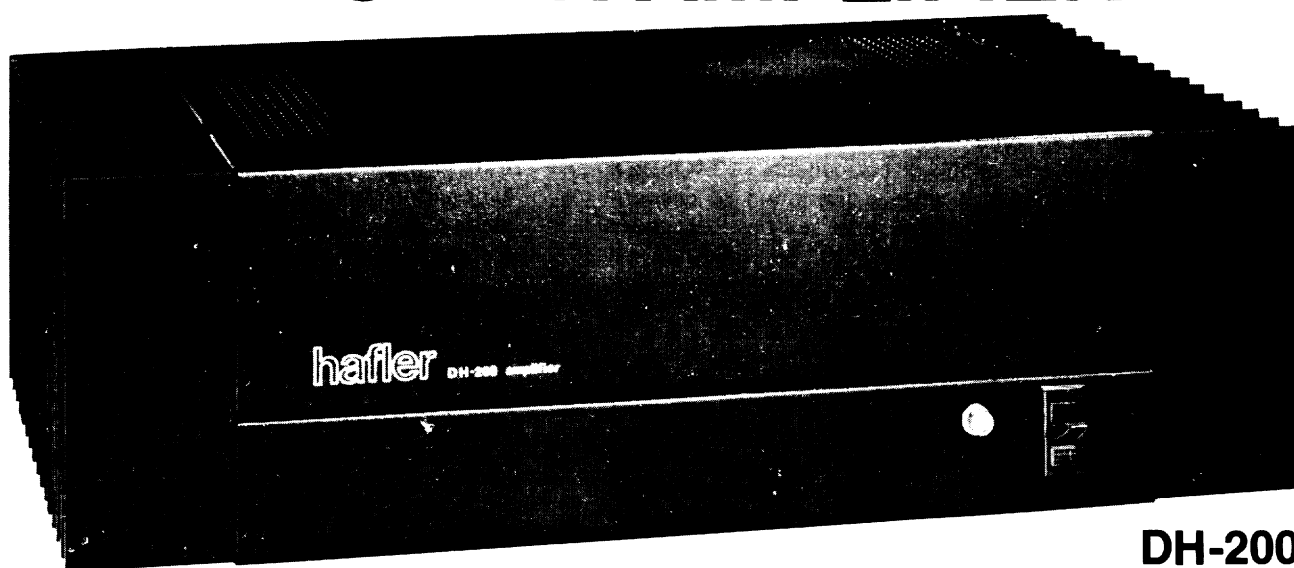

**DH-200**

**INSTRUCTIONS**  
**for ASSEMBLY**  
**and OPERATION**

929204

**\$3.00**

THE DAVID HAFLER COMPANY  
5910 Crescent Boulevard, Pennsauken, New Jersey 08109

Please refer to this serial  
number in all communications  
regarding this equipment.

## INTRODUCTION

The Hafler DH-200 is a two channel audio power amplifier designed to the very highest performance standards. It is available either as a kit, or fully assembled. Its 100 watt per channel power rating is sufficient for driving all loudspeakers in home applications, and its design provides extremely low distortion of all types. A combination of high performance, dependability and reliability, and moderate price is in the Hafler tradition of using the latest technology to provide outstanding value.

Combining the latest power MOSFET technology with uniquely simple and effective circuit topology reduces distortion of all types, and at all power levels, over the full audio frequency spectrum, to the vanishing point. In addition to its pace-setting performance achievements, the conservative mode of operation accomplishes a new high in long term reliability and exceptional resistance to abusive operating conditions. This is one of the direct benefits of MOSFET utilization in overcoming a serious limitation of conventional transistors — their tendency to self-destruct under other than normal operating conditions. So rugged is the DH-200 that it can deliver as much as ten amperes into a short circuit!

The speed — measured as the slew rate — of this design delivers unmatched transient linearity, revealing the most delicate shadings, textures and nuances of the music, surpassing the capabilities of the most revealing loudspeakers and cartridges by a wide margin. Coupled with its unconditional stability, and ability to deliver adequate power into any loudspeaker load, the result is absolute freedom from listening fatigue. The longer you listen to this phenomenal amplifier, the more certain you will be that you could not have made a better choice.

Though modest in cost, the DH-200 evidences the very finest electrical and mechanical design. It avoids costly frills and unnecessary gadgetry while providing quality sound and reliability based on top grade components conservatively operated.

The oversized power transformer and bridge rectifier; the massive heat sinks; the conservative operating levels of the MOSFET output devices — all are evidence of the design efforts to achieve exceptional reliability simultaneously with state of the art sonics and specifications. And this circuit is convertible (with an internal accessory bridging circuit board) to a high power monophonic amplifier with equivalent stability and specifications.

The fully complementary, symmetrical push-pull circuit, which is direct coupled throughout (except at the input), incorporates all silicon devices in a format which is directly related to the highly acclaimed DH-101 preamplifier. Its unique self-protecting output stage prevents the thermal runaway which is a common threat to solid state amplifiers. The ruggedness and conservative operation of the output stage allows the DH-200 to avoid the need for special protective circuits which could compromise audio performance. Basic protective systems provide maximum security against malfunction damage to the amplifier or the speaker: the AC line fuse, B+ fuses, thermal breakers, and loudspeaker fuses. Nothing hinders the essential purity of the audio signal.

Those who use these instructions to assemble the DH-200 kit will find that the left and right audio modules (printed circuit and heat sink assemblies) are preassembled and pretested. This greatly simplifies the kit assembly so that it can be done in only a few hours without special skills or know-how. Because of the modular arrangement, it is possible to operate on one channel if the other requires service, and obviates the need to return the entire amplifier in cases where one channel is inoperative.

Accessories for special applications include the input bridging circuit board for monophonic use; a panel for standard 19" rack mounting; and an alternative power transformer for international AC line voltages.

Through advanced engineering geared to the audio perfectionist, and an efficient no-frills approach, Hafler is making high technology high fidelity affordable.

## CONTENTS

Operation . . . . .	Page 3	AC Line Connections for Overseas Use . . . . .	12
Assembly Instructions . . . . .	4	Kit Parts List . . . . .	13
Wiring the Kit . . . . .	6	Schematic Diagram . . . . .	14
If Problems Arise . . . . .	10	Component Value Listing . . . . .	15
Service and Warranty . . . . .	11	Pictorial Diagram . . . . .	Insert

## INSTALLATION

The DH-200 is most likely to be installed out of sight in most applications, since its power may be controlled by the AC switching of most audio preamplifiers, like the Hafler DH-101. If your control unit does not provide switching capacity sufficient for the amplifier's 5 amp needs (plus other equipment it is also switching), you should use the amplifier's own power switch. In that case, turn on the preamplifier first; then turn the amplifier on a few seconds *after* the preamp has been turned on, to avoid any unnecessary turn-on transients from some preamplifiers. Likewise, switch the power amplifier off first.

If the amplifier is to be installed close to a record player, you should first check its position for freedom from hum pickup by the cartridge from the field radiated by the power transformer of the DH-200. Although the design of the transformer minimizes such radiation, certain cartridges are

more sensitive than others, and require separation from the amplifier. Check at a comparatively high volume setting, and while swinging the tone arm throughout its arc. Often a few inches additional spacing will eliminate the problem.

Be sure to provide sufficient *ventilation* for the amplifier. Unobstructed *air circulation* around the finned heat sinks and *above* the amplifier is important for long, trouble-free life. Never put anything on top of the cover perforations. It is normal for the top and the heat sinks to become warm in use.

It is expected that the amplifier will always be resting on its feet, which should be on a hard enough surface that air flow underneath is not obstructed. If it is mounted in a rack, or through a panel, the feet may be removed so long as adequate ventilation is provided through the bottom openings.

## OPERATION

The red pilot lamp which is integral with the power switch glows whenever the amplifier is turned on. A blown AC line fuse is the most likely cause if it is not illuminated when the amplifier is switched on.

The yellow lens is a high temperature indicator. While it is not likely that you will ever see it lighted, if it is, the amplifier will not produce sound. It indicates that one of the thermal breakers has shut down the amplifier because of excessive temperature rise in a heat sink. When the heat has dissipated in a few minutes, the amplifier should return to normal operation. If the lamp again lights, check for insufficient ventilation, or an excessive input signal, or an input which may have dangerous signal content (such as oscillation). Failing evidence of this, the amplifier may have malfunctioned. Because of the very large heat sinks, it is highly unlikely that any normal signal will cause the amplifier to overheat.

### Loudspeaker Fuse Selection

The DH-200 power amplifier is supplied with 2 amp fuses in the speaker lines. Experience has shown that since an overload must exist for a few seconds for a fuse to blow, a 2 amp fuse will protect most speaker systems, and only blow when overload occurs. Smaller fuses tend to blow too easily, and larger fuses do not adequately protect most speaker systems.

A pair of 5 amp fuses are also supplied as alternatives for the speaker fuse holders. These should be substituted if the power output of the amplifier is to be tested, or if the amplifier is to be operated at very high power levels into 4 ohm loads.

If the manufacturer of your speakers recommends a specific value of fuse for their protection, we suggest that you obtain 3AG fuses of that value and substitute them for the ones supplied.

### Loudspeaker Power Ratings

There are no U.S. standards for rating the power handling capabilities of loudspeakers. As a result the manufacturers' usual "music power" ratings, or suggested amplifier limits, are of only minimal help in determining safe operating levels with amplifiers which can deliver substantial amounts of power. You must take into consideration the type of music, and the levels you like, to provide long term trouble-free operation of your speaker choice, when you have a sizeable amplifier like the DH-200.

### Connections

#### AC

The AC power cord should be plugged into 120 volts, 60 Hz, on the switched output of a preamplifier which can provide at least 5 amps, or 600 watts. Then the amplifier power switch may be left on, and it will be controlled by the rest of the system. Or, it may be plugged into a 120 volt wall outlet, and switched on and off independently.

If your line voltage is different, be sure you have the alternate power transformer which can accommodate several line voltages, and be sure it is wired for your mains voltage as described later in this manual *before you plug in the amplifier*.

#### Input

Conventional shielded cables, such as those supplied with your preamplifier, provide the input signal to the sockets on the back panel of the DH-200. Be sure that the outer shield connection is secure, to avoid hum. The length of these cables (so as to permit remote location of the amplifier, if desired) is limited only by the output impedance of the preamplifier. If it is 1,000 ohms or less, as with the DH-101, for instance, cable lengths up to 100 feet are permissible without loss of performance. Special low capaci-

tance cables enable even greater distance between preamp and amplifier. It is desirable to keep the left and right input cables close together throughout their length to minimize the likelihood of hum pickup. Also, you should avoid running them parallel to AC cords — these should be crossed at right angles.

### Output

The loudspeakers (or headphones) connect to the red and black terminals in the center of the back panel. These binding posts provide several convenient alternative connecting methods. The screw cap may clamp the bared wire end, or a "spade lug" attached to it, but a better connection will be made by locating the hole drilled through the shaft of the terminal when the cap is unscrewed. Insert the twisted end of the bared wire so that the cap will clamp it in place. Always be sure that no strands of wire are unsecured, and that the bared end is not too long to risk contacting other elements. A soldered end or fitting is the safest solution.

These terminals also accept standard plug-in "banana pin connectors," including the double ones with standard 3/4" spacing, available from electronic supply houses. These are the most convenient, especially if you may wish to interchange speakers occasionally.

It is important to maintain correct phasing of the speakers when making their connections. Some speaker terminals are coded red and black, or + and -, etc. It is important that the "sense" of one speaker's connections match the others. If one is reversed, you will find that the sonic image has a "hole in the middle," and that it is deficient in bass. Speaker wire always identifies one conductor to make this easy. There may be a molded ridge in one lead, or the color of the insulation on one wire is different, or the wire itself may be color coded. If pin plugs are used, be sure they are

color coded, or that you follow the indexing mark on one side of the double connectors.

Select speaker wire of sufficient size to preserve the high damping factor (and excellent speaker control) of your amplifier. Standard 18 gauge lamp cord ("zipcord") is satisfactory for distances up to 30 feet for an 8 ohm speaker. As the distance increases, larger wire sizes are recommended. The next larger wire size is #16, and it is often preferred by perfectionists. If you have 4 ohm speakers, the maximum cable length for best results is halved.

The black output terminals are electrically connected to the chassis internally. Be certain that when the amplifier is operated in its normal stereo mode that the red output terminals are *never* connected together. In the special case when the amplifier has been internally modified for monophonic bridged operation, the output is taken from the two red terminals *only*. Then, the black terminals are left unconnected.

Headphones are normally operated from the loudspeaker outputs, but are usually connected through a junction box which provides switching from phones to speakers. Such a box usually provides some added resistance to reduce the sensitivity of the phones, and thus minimize the likelihood of hearing component noise, because of the low setting required at the volume control. Some headphone boxes utilize a "common ground" system which makes it particularly important that you carefully observe the proper connections. While the black ground terminals can be connected together, the red ones must not be.

Some headphones, such as electrostatic types, are less sensitive and may need little or no resistance in series for normal operation. These could be easily interchanged with the speakers through the use of double banana plugs.

## ASSEMBLY INSTRUCTIONS

There are three basic rules for success in electronic kit building:

1. Read the instructions carefully, and follow them in order.
2. Make secure solder connections which are bright and smooth.
3. Check your work carefully after each step.

The DH-200 preamplifier is a versatile component with sophisticated circuitry which has been made remarkably easy to build by individuals with many years of experience in the design and engineering of the finest performing audio kits, and in the preparation of their manuals.

Kit building should be fun, and we are certain you will find this to be so. Assembly will be faster, easier, and more enjoyable if you have someone help you by reading the steps aloud, selecting the required parts, and preparing the necessary wire lengths in advance as you proceed. Fatigue increases the risk of error, so take a break rather than push to early completion. There are relatively few separate components in this design, to make it easy to pack everything away, if need be.

Your work area should have good lighting, the proper tools, and a place where the large pictorial diagram can be tacked to the wall within easy reach for checking. The tools should include:

1. A 40 to 100 watt soldering iron with a 1/4" or smaller tip which reaches at least 600°F.
2. 60/40 (60% tin) ROSIN CORE solder, 1/16" diameter or smaller.
3. A damp sponge or cloth to wipe the hot tip of the iron.
4. A wire stripping tool for removing insulation. This can be a *single-edge* razor blade, but inexpensive stripping tools are safer, faster and easier.
5. A medium-blade screwdriver (about 1/4" wide).
6. Needle-nose pliers (a long, narrow tip).
7. Diagonal or side-cutting small pliers.
8. Large "gas" or "slip-joint" pliers.
9. A 1/4" "Spin-tite" nut driver may be helpful, but is not necessary.

A soldering "gun" is *not* recommended. The unfamiliar user is more likely to damage the etched circuit boards with its higher heat potential and unbalanced weight. Also, because he may not wait long enough for it to reach operating temperature each time it is switched on, poor solder connections are more likely. Pencil irons are much lighter and easier to use, and there is no waiting time when solder connections follow in sequence, as in kit building. Make sure you have a holder for it, though, and always unplug it when you take a break.

### Proper Soldering

There are four steps to making a good solder connection:

1. Make a good mechanical connection to hold the wire in position while heat and solder is applied.
2. Heat the *junction* of the wire and lug, or eyelet, with the bright, shiny tip of the iron.
3. After heating for a couple seconds, apply solder to the junction. It should melt immediately and flow smoothly around both surfaces.
4. Allow the connection to cool undisturbed.

Remember that the connection is made by the solder, not by mechanically attaching the wire to the terminal. Usually the wire is looped through the lug and crimped in place, but some prefer to just place it through the hole and rely on the stiffness of the wire to hold it while soldering. Eyelet connections, of course, are handled this way.

Good solder connections are *essential* for trouble-free, noise-free operation. A good solder joint does not require much solder around the conductors. Never "butter" partially melted solder on the joint, as it is useless. A good connection looks smooth and bright because the solder flows into every crevice when the parts are hot enough. The iron must have a bright, shiny tip to transfer heat easily to the junction. That's why the damp sponge should be used frequently to wipe the tip, and occasionally you must add a small amount of solder to the tip, too. If a connection is difficult to heat, "wet" the tip with a small blob of solder to provide a bigger contact surface to the joint. Once the solder flows around the conductors, any movement must be avoided for a few seconds to allow a good bond. When cool, check the connection by wiggling the wire. If in doubt, or if the connection is not shiny, re-heat the joint. Excess solder may be removed from a con-

nection by heating it and allowing the solder to flow onto the iron, which is then wiped on the sponge.

### ALL SOLDER USED MUST BE ROSIN CORE.

Never use acid core solder or any separate flux in electronic work. Silver solder is also not suitable. If in doubt about unmarked solder, always obtain a fresh supply of rosin core solder. We recommend 60/40 for easiest use. Do not confuse it with 40/60, which is harder to melt.

The general procedure is to use a hot iron for a short time to heat a connection, then add solder with the iron still in contact. Remove the solder once it flows, and then remove the iron. A cooler iron applied for a longer time is more likely to damage components, or lift the copper circuit pattern from the boards. A break in the etched circuit can be mended by simply soldering a small piece of wire across it. Do not allow much build-up of solder on the tip of the iron, or it may fall into adjacent circuitry.

When soldering to an eyelet on the board, insert the wire from the components side, and apply the iron to the bottom, leaving some bare wire exposed so that you can see that the eyelet is then filled with solder for a secure bond. A round wooden toothpick is suggested so that you can heat and clear an eyelet of solder if it hinders your inserting the wire. Some builders prefer to clear every eyelet first with a touch of the iron and toothpick. Others connect the lead by bringing it up to the center of the eyelet on top of the board, applying the iron from the bottom of the board, and pushing the lead in as the solder in the eyelet melts. If the wire has first been "tinned," usually no additional solder is necessary, but it is a good practice to push the wire through, and then back it up a bit, to be sure solder fills the eyelet from both sides. On the bottom of the board, make certain a bright, shiny flow is evident from the wire, across the eyelet, onto the circuit pattern on the board. It is *essential* that the eyelet be fully soldered to the circuitry, too.

"Tinning" refers to the process of applying a light coating of solder to the bared wire end. This keeps all the strands secured, and also makes a good connection easier. Simply touch the wire with the iron for a couple seconds, and apply solder. Allow the excess to flow away onto the iron. When properly done, the wire is uniformly bright, and no larger than before. The hookup wire supplied with this kit does not normally need tinning, for it is pre-tinned.

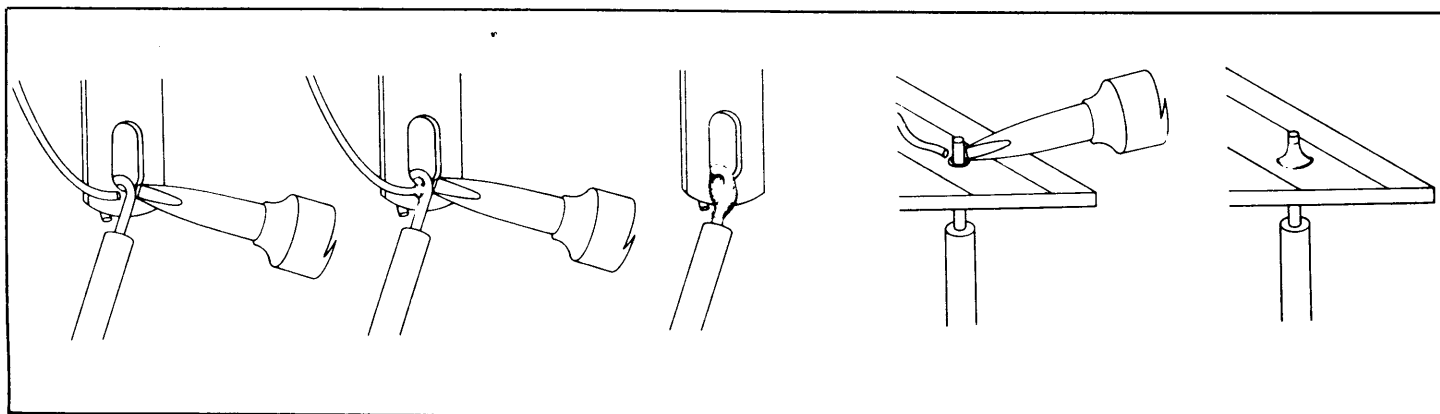

## Wiring the Kit

If any components are unfamiliar to you, checking the pictorial diagram should quickly identify them. Or, the quantities, and the process of elimination as you check the parts list, will help. The pictorial diagram is necessarily distorted to some extent for clarity, so that you can trace every wire in a single overall view for verification as you work. You may wish to check off on the diagram as you solder each location.

To "prepare" a wire means to cut the designated length from the coil of that color, and strip about 1/4" of insulation from each end. The wire supplied in the kit is #18, so you can set adjustable wire-strippers accordingly. The transformer leads are #16 or 18, and the line cord is #18. Be careful that you do not nick the wire when you strip it (that can happen more easily if you do not use wire strippers) for that weakens it. The wire supplied in this kit is "bonded stranded," which provides exceptional flexibility with resistance to breakage for easier use.

Whenever a connection is to be soldered, the instructions will so state, or indicate by the symbol (S). If more than one wire is to be soldered to the same point, they will be indicated by (S-2), (S-4), etc. If soldering is not called for, other connections have yet to be made to that terminal. They would be more difficult if the connection was already soldered. Every connection in the kit will be soldered when it is complete. After soldering a connection, it is best to clip off any excess lead length to minimize the possibility of a short circuit (as on switch lugs, where terminals are very close together), and for neatness.

Be sure that uninsulated wires cannot touch adjacent terminals or the chassis metalwork.

The symbol (#) indicates a connection is to be made to that point. When a lug number is specified without (#), it is simply a locating reference.

When the instructions call for twisting two or three wires together, the length of wire indicated anticipates a fairly tight, uniform twist by hand, of three full turns every two inches. If you find the wires too short, loosening the twist will gain some needed length.

Handle the circuit boards carefully. They represent a major part of the kit cost. Stand-up components, such as transistors, should be checked when you install the module, to be sure all leads are separated.

All of the active circuitry is contained on the PC-6 board, which has been carefully tested to assure that it meets every specification. Only the interconnection of power supply elements is left to the builder. Take the time to be accurate and neat, and you can be sure that your completed amplifier will meet the performance of a factory assembled unit, and can continue to perform properly for years to come. Check your work, and make sure the entire step has been completed before placing a check mark in the space provided, and continuing on to the next step.

KEP nuts have been supplied as a convenience. These have lockwashers attached, and the lockwasher always goes onto the screw first. If the sheet metal screws have hex heads, you may find it easier to first start them with a regular screwdriver, to set the thread, and then use the more convenient nut driver, if one is available.

## Mechanical Assembly

- When you unpack your kit, you will find that the transformer, large capacitors, and the output assemblies have been temporarily fastened to the chassis for safe shipment. Disengage these, and include this hardware with the rest when you check off the components against the parts list in the back of the manual. We recommend this check-off to be sure you have everything, and to enable you to identify any unfamiliar items by comparing them with the pictorial diagram. An egg carton is ideal for keeping hardware items separated.

A "set" of hardware includes one screw and one KEP nut (with its attached lockwasher). Always install the lockwasher side of the nut first. If the size of the hardware is not specified, use the #6 size. The smallest size is #4 and #10 the largest. Always insert the screw from the outside of the chassis.

It will simplify matters if you first separate the #4 nuts from the #6 nuts, which have the same outside dimensions. A #4 screw will pass through a #6 nut, aiding identification.

- Select the four rubber feet, four sets of hardware, and the chassis. Insert each screw through a foot so that the head is recessed, and install the feet on the outside at each corner hole.
- Select the two red output terminals. Install them in the sequence shown below, in the two center holes R2 and R3 at the rear of the chassis. Before you fully tighten the first nut, unscrew the cap to expose the hole drilled through the threaded shaft. Connection of loudspeaker wires will be easier if these holes are positioned vertically. A nail through the hole will keep it positioned while the hardware is tightened. Each connecting lug should point downward before the last nut is secured. Be sure both nuts on each terminal are **tight**, as they are difficult to reach when the amplifier is completed.

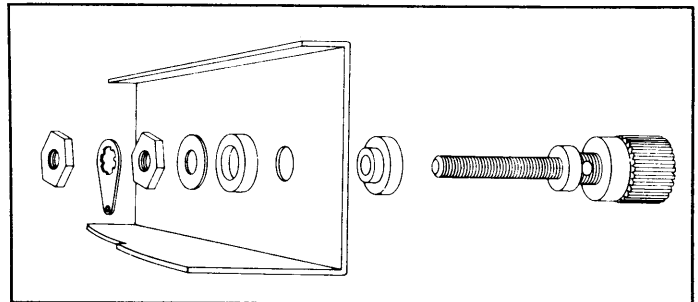

- Select the two black output terminals and install them on either side of the red ones, at B1 and B4. Be sure the shaft holes are vertical, the lugs point downward, and each nut is tight.
- Select the two round fuse holders, and two each 1/2" rubber washers, lockwashers and nuts. First install the rubber washer on the holder, so it will be outside the chassis, and then fasten the fuse holders at LF and RF, with the tip lugs pointing away from each other, toward the edge of the chassis.

- 6  Select the larger round input socket, its insulating disc, the solder lug with lockwasher teeth, two #4 screws, and the two nylon nuts. This socket will be installed at RS. The inside of the chassis at RS and LS has not been painted, so that a good ground connection can be made. It may be necessary to clean this with a solvent, or with an eraser, before the sockets are installed. Place the solder lug on the lower mounting screw inside the chassis, followed by the insulating disc, then the socket. Position the lug toward the edge of the chassis. The shorter ground lug on the socket should also be nearest this right edge. Secure this socket with the nylon nuts.
- 7  Select the other input socket and two sets of #4 hardware. Install it at LS after cleaning the unpainted area, with its short ground lug near the left edge of the chassis.
- 8  Select the four-lug rectifier block RB, the long #6 screw, and a nut. Install the rectifier in the center hole near the rear of the chassis, with the plus (+) terminal located over the tiny indexing hole at position four. Correct orientation of this rectifier is **essential** for proper wiring.
- 9  Select the single fuse clip, and one set of #4 hardware. Install the clip in the right front chassis hole FC, closest to the foot.
- 10  Select the two dual fuse clips and four sets of #4 hardware. Install these in the pairs of holes FL and FR on either side of the center of the chassis.
- 11  Select the two-lug terminal strip and one set of #4 hardware. Install it in the front hole TS, next to the single fuse clip. Note the position of the mounting lug (to the right) in the pictorial diagram.
- NOTE:** Kits provided with the multiple voltage power transformer for locations outside the United States which use a line (mains) voltage other than 120 VAC, are also supplied with a five-lug terminal strip which is to be installed in place of the two-lug strip, using an additional set of #4 hardware near the dual fuse clip.
- 12  Select the power switch. If it says "Carling," position it with lug #3 at the top. If it says "Chicago," position the small protruding plastic lug at the bottom. Snap it fully into the front chassis hole PS from the outside.
- A soldering iron will be used regularly for installing the wiring. Be sure you wipe its tip frequently with a damp cloth or sponge, as a bright tip will make connections easier with less likelihood of overheating components. If it is difficult to heat a connection in a couple of seconds, apply a small amount of fresh solder to the tip so it can flow around the connection and provide good heat transfer.
- Take the time to observe the direction each wire takes from its connecting lug, so that when you connect the first end, it will be pointing in the right direction. This makes the job neater, and assures that each wire is long enough.
- 13  Prepare a 6-1/2" green wire. Connect one end to dual fuse clip FL lug #1. Connect the other end to the other dual clip FR lug #1. (S).
- 14  Prepare a 6-1/2" white wire. Connect one end to FR lug #3. Connect the other end to FL lug #3. (S).
- 15  Select the 2.2 ohm (red-red-gold) resistor. Cut each lead to 1/2" or less. Connect one end to the separate solder lug installed under input socket RS. (S). Connect the other end to the short (ground) lug #2 of socket RS.
- 16  Prepare a 10" green wire and a 10" white wire. Twist these together uniformly (about three complete twists every two inches). Connect the green wire to the short RS lug #2. (S-2). Connect the white wire to RS lug #1. (S). Place these wires out of the way, over the edge of the chassis.
- 17  Select one of the .0047 mfd film capacitors. Cut each lead to 1/2", and connect one lead to fuse holder RF lug #1. Connect the other lead to RF lug #2.
- 18  Prepare two 8" white wires. Start with one wire projecting 3/4" beyond the other, and twist them uniformly together throughout their length. Connect the projecting end to RF lug #1. (S-2). Connect the corresponding end of the other wire to RF lug #2. (S-2). Place this pair over the edge of the chassis.
- 19  Prepare an 11" white wire and a 9" green wire. Starting with the white wire 3/4" longer than the green wire, twist them together to within one inch of the other end of the green wire. At the beginning end, connect the green wire to output terminal lug #B4. Connect the white wire to lug #R3. (S). Place these wires off to the right.
- 20  Prepare a 6" green wire. Connect one end to lug #B4. (S-2).
- 21  Prepare a 10" white wire and a 10" green wire. Twist them together, and connect the green wire to the short LS lug #1. (S). Connect the white wire to LS lug #2. (S). Place these wires to the left, over the edge of the chassis.
- 22  Select the remaining .0047 mfd film capacitor, and cut each lead to 1/2". Connect one lead to LF lug #1, and the other lead to LF lug #2.
- 23  Prepare two 7-1/2" white wires. Start with one wire 3/4" longer, and twist them together throughout their length. Connect the longer end to LF lug #2. (S-2). Connect the other wire to LF lug #1. (S-2). Place these wires off to the left.
- 24  Prepare a 9-1/2" white wire and a 10" green wire. Starting with the white wire 3/4" longer than the green wire, twist them together to within one inch of the other end of the white wire. At the beginning end, connect the green wire to output terminal lug #B1. Connect the white wire to lug #R2. (S). Place these wires off to the left.
- 25  Prepare a 6" green wire. Connect one end to lug #B1. (S-2).

26  Prepare two 20" white wires, and twist them together throughout their length. Six inches in from one end of the pair, cut **one** of the wires, and unwind it about 1-1/2" in each direction from the cut. Strip 1/4" of insulation from each of these cut ends. Place the longer portion of the wire along the lower front edge of the chassis, with the break at the single fuse clip. Connect one cut end to TS lug #2. Connect the other cut end to power switch lower lug #1. The unbroken wire of this pair may be placed under the power switch for neatness, and the free ends project from the front corners of the chassis.

27  Select the power transformer, four sets of 1/2" long #10 hardware, and the four flat washers. Position the transformer so that the red leads emerge near the center of the chassis. The black and black/white leads (and all of the brown leads as well, if it is the multiple voltage version) should project toward the power switch. Be sure no wires are pinched in the installation. Place the white twisted pair under the front chassis lip. Install a flat washer on each screw through a transformer foot before the nut is secured.

The transformer leads can be trimmed as desired for a neat job, but be sure you do not cut any of them too short (particularly if the multiple voltage version is used, and any change in the supply voltage is likely). Cutting the leads too short for re-use may void the transformer warranty, if it is thought to be defective. Alternate wiring diagrams for the optional multiple voltage version will be found elsewhere in this manual. If you have that transformer, consult them before wiring the transformer and power switch.

Be sure all strands of each transformer lead are tinned and soldered together before connection to a lug, so that there is no possibility of a stray strand touching anything but the intended lug.

28  Connect the black transformer lead to FC lug #2.

29  Prepare a 2" green wire. Connect one end to FC lug #2. (S-2). Connect the other end to PS top lug #3. (S).

30  Connect the black/white transformer lead to TS lug #2.

31  Select the yellow lamp assembly and the spring steel nut. Trim the lamp leads to 2", and install it from the outside at HT. The center of the nut curves away from the chassis when it is pressed over the lamp case. Be sure it is pressed fully home, so the lamp is tight.

32  Connect one lead of the lamp to TS lug #2. (S-3). Connect the other lamp lead to PS lower lug #1.

33  Select the .005 mfd disc capacitor, and trim its leads to 1/2" or less. Connect one lead to PS lug #1. (S-3). Connect the other lead to PS lug #2.

34  Select the AC line cord and the plastic strain relief. Separate the two conductors for 2-1/2". Cut 1-1/2" off of one of the two leads, and strip 1/4" of insulation from each lead. Twist the strands tightly, and tin each end. Nine-and-a-half inches from the longest end,

make a sharp "V" in the cord by bending it back sharply on itself. Install the strain relief as shown, with the small end of the strain relief nearest the stripped end of the line cord. Crimp the two halves of the strain relief around the wire at the "V" with heavy pliers, to partially form it before insertion into the back panel. Then grip the larger diameter of the strain relief with the tips of the pliers, squeeze it tightly, and insert the end of the cord and the strain relief through the back panel hole AC, from the outside. Note that the hole has a flat on one side, and the strain relief is installed accordingly. It snaps into position when fully inserted. Place the line cord under the other wires.

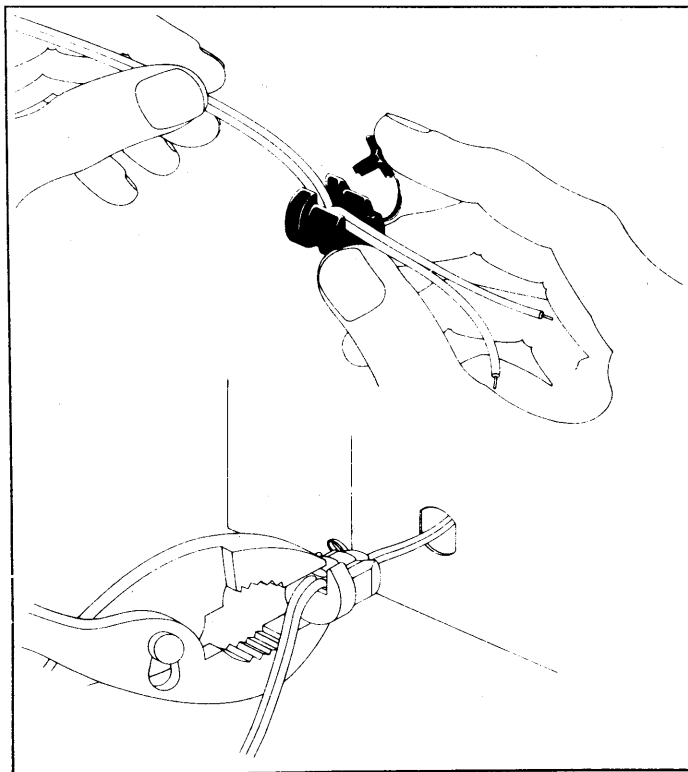

35  Connect the longer end of the line cord to PS lug #2. (S-2). Connect the shorter lead to FC lug #1. (S).

36  Select the two red transformer leads. Connect one lead to RB lug #2. Connect the other lead to RB lug #3.

37  Select the .01 mfd disc capacitor, and trim its leads to 3/4". Strip two 1/2" pieces of insulation from the white wire, and slide one piece over each of the disc capacitor leads. Connect one lead to RB lug #2. (S-2). Connect the other lead to RB lug #3. (S-2).

38  Prepare a 6" white wire. Connect one end to RB lug #4. (S). Be sure this is the (+) terminal of the rectifier.

39  Select one of the round capacitor brackets, two sets of #6 hardware, one of the 3/4" #10 screws and its nut, two short #10 SEMS screws (with lockwasher attached), two solder lugs, and one of the large capacitors. Insert the short screws through the solder lugs, and install them loosely in the capacitor terminals. Install the long screw in the bracket clamp, noting the direction of insertion in the pictorial diagram (to provide easy future access), and tighten that nut about half way. Place the assembly in position on the chassis, on



the right side, nearest the power switch. Install the two sets of hardware to secure the bracket to the chassis. If the bracket twists as the screws are tightened, first install the capacitor, and clamp it. Make sure the capacitor is tight against the chassis, and that its positive (+) terminal is toward the **right** side of the chassis before tightening the clamp. Position the lug on the (+) terminal (it will be painted red if it is not marked with a +) so it points forward toward the power switch, and tighten its screw. Point the negative terminal lug toward the rectifier block to the left, and tighten that screw. Make sure no wires are trapped by the bracket.

- 40  Select the remaining capacitor, its bracket, two sets of hardware, the long #10 hardware, the two short #10 screws, and the two solder lugs. Install this assembly as in the preceding step, but be sure the **positive** lug of the capacitor is nearest the **center**, pointing toward the other capacitor's negative lug. The negative lug of this second capacitor points forward.
- 41  Select the white wire from RB lug 4 (marked +) and connect it to CR lug #2.
- 42  Prepare a 4-3/4" white wire. Connect one end to FR lug #3. (S-2). Connect the other end to CR lug #2. (S-2).
- 43  Prepare a 6" green wire. Connect one end to RB lug #1. (S). Connect the other end to CL lug #1.
- 44  Prepare a 4-3/4" green wire. Connect one end to FL lug #1. (S-2). Connect the other end to CL lug #1. (S-2).
- 45  Remove all of the insulation from a 2-3/4" white wire. Connect one end to CL lug #2. (S). Connect the other end to CR lug #1. (S).
- 46  Connect the red/yellow transformer lead to the center of the bare wire between the capacitor lugs. (S).
- 47  Connect the separate green wire from output terminal B1 to the center of the bare wire, next to the transformer lead. (S).
- 48  Connect the separate green wire from B4 to the center of the bare wire also. (S).
- 49  Select the output assembly modules (the two major items in the kit). You will note that the only difference, which identifies the left or the right module, is the position of the thermal breaker, which is located between one pair of output transistors on the heat sink rib. Before connecting wires to these modules it is best that you take the time to make absolutely certain that each eyelet is well soldered to the circuitry on the back (inside) of the board. Add a little solder if necessary, but it is important that solder flow from the wire, across the eyelet, and onto the circuitry. Then if you wish to clear the center of the eyelet for easier insertion of the wire, use a round wooden toothpick after heating each eyelet. Now position the right module (with the breaker at the front when the long row of eyelets is next to the chassis) with the circuit board up, against the chassis.

Wires will be connected from the top of the board, and they must be soldered to the underside. Even though the connecting wires will be rather long when the amplifier is completed, they are just long enough to reach now, so working room is limited. It is best to heat the eyelet from below while the wire is inserted from above. That requires an iron with a small flat chisel tip — and some care on your part. It is easiest to melt a small blob of solder on the tip, and position it under the eyelet so that the solder blob, more than the tip itself, is heating the eyelet. If the eyelet is first filled with solder, and the wire end pushed all the way through the heated eyelet first, then withdrawn part way to expose a bit of the bare end above the board before the solder cools, you should have a firmly soldered connection if it cools undisturbed.

Always tin a wire that is to connect to an eyelet. After soldering, go back and check by twisting each wire, to make sure nothing moves on the other side of the board. Be careful, too, that you don't loosen existing connections to adjacent eyelets. For a bit better access to these connections, you may wish to remove the three mounting screws to allow the circuit board to be moved, but don't forget the nylon washers under the board.

- 50  Select one of the narrow numbered strips, and peel off the backing. This identifies the eyelet numbers, and should be placed along the bottom of the circuit board, with eyelet #14 nearest the power switch.
- 51  Prepare a 6" white wire. Connect one end to eyelet #4 of the circuit board. (S).
- 52  Prepare a 5-1/2" green wire. Connect one end to eyelet #13. (S). Make sure it **cannot** contact the transistor mounting screw near the underside.
- 53  Select the green and white twisted pair from the output terminals R3 and B4. Connect the shorter green wire to eyelet #6. (S).
- 54  Select the pair of white wires from RF. Connect the shorter wire to eyelet #8. (S). Connect the other wire to eyelet #11. (S).
- 55  Connect the remaining white wire from the green and white pair from the output terminals to eyelet #12. (S).
- 56  Connect the green wire from eyelet 13 to FR lug #2. (S).
- 57  Connect the white wire from eyelet 4 to FR lug #4. (S).
- 58  Select four of the long sheet metal screws. Take care to see that no wires are pinched in the process, while you tilt up and fasten the module to the end of the chassis.
- 59  Select the green and white pair from input socket RS. Connect the white wire to the top rear eyelet #1. (S). Connect the green wire to eyelet #2. (S). This pair will be specifically positioned later.
- 60  Select the white pair at the front. Tuck the excess wire into the corner of the chassis, and connect one lead to each of the lugs on the thermal breaker. Solder each.

- 61  Select the left output module, make sure all its eyelets are well soldered, and place it against the left side of the chassis, board up, breaker at the front.
- 62  Select the remaining strip of eyelet numbers, and install it with eyelet #3 at the front.
- 63  Prepare a 6-1/2" green wire. Connect one end to eyelet #13. (S). Be sure it cannot touch the transistor screw.
- 64  Prepare a 5-1/2" white wire. Connect one end to eyelet #4. (S).
- 65  Select the green and white pair from output terminals B1 and R2. Connect the shorter white wire to eyelet #12. (S)
- 66  Select the white pair from LF. Connect one wire to eyelet #11. (S). Connect the other wire to eyelet #8. (S).
- 67  Connect the remaining green wire from the output terminal pair to eyelet #6. (S).
- 68  Connect the white wire from eyelet 4 to FL lug #4. (S).
- 69  Connect the green wire from eyelet 13 to FL lug #2. (S).
- 70  Select four sheet metal screws and fasten the module to the chassis, making sure no wires are pinched.
- 71  Select the green and white pair from input socket LS. Connect the green wire to rear eyelet #2. (S). Connect the white wire to eyelet #1. (S).
- 72  Tuck the excess of the remaining white pair of wires into the left front corner of the chassis, and connect one wire to each lug of the thermal breaker. Solder each.
- 73  Select the 5 amp slo-blo fuse (a slo-blo fuse has distinctive internal construction) and install it in the single fuse clip FC.
- 74  Select four 5 amp regular fuses, and install them in the dual fuse clips FL and FR.
- 75  Select the two 2 amp fuses, and install them in the twist type fuse holders on the back panel. These fuses will provide reasonable protection for most speakers. See the Operation section of this manual for more detailed information. The remaining 5 amp fuses are alternates for the back panel holders for high power test purposes.
- 76  For lowest distortion performance, precise placement of some wires is important. The wires from the output terminals and the back panel fuse holders should be kept against the chassis. They should be positioned over to the input socket, and then straight forward to the board. The input socket pairs should be close to the chassis, but above the other pairs, straight to the center bottom of the circuit board, and then up the middle of the board about 1/2" out, right in the plane defined by the edges of the finned heat sinks. The wires to the dual

fuse clips should be kept away from the board and against the chassis, bringing the excess length forward of the fuses. The leads from the power supply capacitors should be kept away from each board. The green leads from the black output terminals to the power supply should be brought together throughout most of their length.

- 77  Check all your soldered connections — especially those on the fuse clip lugs, which are sometimes difficult to solder to. Clip off any excess bare wire which could short to adjacent lugs or the chassis. Pay particular attention to the stranded wires from the transformer and line cord, and check the power switch connections. Now turn the amplifier upside down and shake out any bits of wire or solder.
- 78  Slide the cover in place, and install it with the eight sheet metal screws.
- 79  Remove the backing from the serial number label, and apply it to the bottom at the center rear.

**CONGRATULATIONS!**  
**YOU HAVE COMPLETED ONE OF THE MOST**  
**TECHNOLOGICALLY ADVANCED AND SUPERB**  
**SOUNDING AMPLIFIERS EVER DESIGNED.**

### **IF PROBLEMS ARISE**

A great deal of care has gone into every Hafler amplifier, whether kit or factory assembled, to be sure that it meets or exceeds all its specifications before it is shipped to you. Every assembled amplifier must pass a battery of performance tests. In the kit, each output module assembly was in-circuit tested to similar standards. Since these modules comprise all of the active amplifier circuitry, save for the power supply, it reduces the likelihood of an internal problem to near zero, with careful assembly.

If you are certain the problem lies in the power amplifier, check first to see that the red pilot lamp is lighted. If it is on, and the yellow lamp is lighted, this indicates that the thermal safety breaker on one channel has shut down the amplifier because of excessive temperature. In this case, the heat sink will be very hot to the touch. After a few minutes to cool, the amplifier will commence operation automatically. If it soon shuts down again, and the amplifier has sufficient ventilation, the malfunction is either internal, or the result of an excessive (and very likely inaudible) input signal.

If neither lamp is lighted, the main fuse in the single fuse clip on the chassis is probably open. If a replacement 5 ampere, Slo-Blo fuse also blows, the amplifier needs service, and there is a power supply problem.

If a problem appears only in one channel of the amplifier, it may be isolated from the rest of the amplifier by removing the power supply fuses to that channel in the adjacent dual fuse clip. The other channel may then be operated monophonically. The Hafler company does not encourage local service of this amplifier. The one adjustment potentiometer is sealed at the factory at the operating point for lowest distortion, and you should not readjust it. The ad-

vanced design of this circuit means that some components will not likely be available locally, and alternative replacements are not recommended at all.

We recommend that a defective output module be separated from the amplifier, and returned for service at the factory. This reduces shipping weight and the likelihood of damage, and enables you to operate the other half if you wish. In this case, we suggest that the connecting wires be unsoldered at the eyelets; that each wire be tagged with the eyelet number (visible inside the board, along the edge — or see the board diagram in this manual); that the bare wire ends all be insulated; the dual power supply fuses for that channel be removed; and the wires to that thermal breaker on the heat sink fin be disconnected and temporarily **soldered together**, and insulated.

### SERVICE POLICY AND LIMITED WARRANTY

The DH-200 Power Amplifier has been carefully engineered to provide many years of use without requiring any maintenance or servicing.

Factory assembled units are subjected to several physical and electrical tests before shipment. The output circuit board assemblies of kit units are similarly tested prior to shipment. In spite of all this testing, shipping damage does occur, kits are not assembled properly or someone “goofs” and service and/or maintenance will be required. The David Hafler Co. provides complete service facilities at the factory to make any necessary repairs.

It is the owner's responsibility *to return or ship the unit freight prepaid to the factory service department. Units shipped freight collect will not be accepted. For units to be repaired under warranty a copy of the dated bill of sale must accompany the unit.*

Shipment should be made via UNITED PARCEL SERVICE. Parcel Post is not a safe way to ship electronic equipment. The factory will not be responsible for damage caused by parcel post shipment and repairs will be made at the owner's expense. When shipping your DH-200 be sure to insure it for the full value of an assembled amplifier.

Use the original carton and packing material to ship your amplifier. Enclose with the unit the following information:

1. Complete shipping address (Post Office Box numbers are often not acceptable).
2. The serial number.
3. Copy of dated bill of sale if repairs are to be made under warranty.
4. Description of the malfunction. If intermittent, please note.
5. We also suggest further identifying the unit as yours by putting a label on the bottom or tying a label with your name and address on the line cord.

All service work is guaranteed for 90 days.

Warranties apply to the original purchaser only. Warranties are void if:

1. The amplifier has been either physically or electrically abused or used for some purpose for which it was not designed.

2. The amplifier has been modified without factory authorization.

The transformer warranty is void if the leads have been cut too short for reuse. If you think a transformer is defective the leads must be unsoldered, not cut, for its return.

Technical assistance to help you locate the source of a problem may be obtained by writing the Technical Services Department. It is helpful to know the serial number of the unit and the results of any tests you have performed.

### SERVICING AN AMPLIFIER MODULE

If you are certain that the problem is confined to one of the amplifier modules (comprising the circuit board, heat sink, and output transistors), you may remove and return only the module for service. Be sure that the components on the circuit board are well protected — as by a surrounding sleeve of corrugated cardboard which rests against the heat sink, and projects beyond the components. Properly packed and insured for \$150, this assembly can be sent by parcel post, as well as UPS, if necessary. A service fee of \$20 must be sent with *every* module, since the fault may have been caused by a wiring error elsewhere. For this reason, too, and because we have no control over its proper reinstallation, the service warranty on a separate module is limited to assurance of its proper functioning when it leaves the service facility. All modules are tested before return to you. If you believe the fault is the factory's warranty responsibility, include the serial number and the *bill of sale*. If in our judgement the fault is entirely a manufacturing defect, a portion of the service fee will be refunded. Only a complete amplifier can be completely checked and given a service warranty.

### WARRANTY FOR KIT-BUILT UNITS

The parts in a DH-200 kit are warranted for a full year from the purchase date. If a defective component is found on a circuit board or in a kit, simply return the *individual* part to the factory prepaid together with the serial number and the date of purchase, and it will be replaced at no charge.

If you cannot locate what is wrong with your DH-200, return it to the factory with a copy of the dated bill of sale, and a check for \$40. If the sole cause of the problem is a defective part, the unit will be repaired and returned to you transportation prepaid, and your \$40 *less a charge for re-packaging and shipping* will be returned to you. If the problem is found to be an error in your assembly of the amplifier, the amplifier will be put in proper working order, tested to be sure it is meeting specifications, and returned to you (freight prepaid within the continental U.S.). Excess shipping charges for expedited service, or overseas delivery are your responsibility. At the sole discretion of the factory service department, if the time required for diagnosis, repair and testing, and the nature of the malfunction warrants it, a portion of the submitted repair fee may be rebated.

This warranty is void if the kit has not been completely assembled or if other than rosin core solder has been used. Units assembled with acid core solder or paste flux will be returned unserviced.

### WARRANTY FOR FACTORY ASSEMBLED UNITS

The DH-200 is warranted for a full year from the purchase date including parts and labor and normal shipping costs from the factory to the owner within the continental U.S. The owner is responsible for returning the unit to the factory and must submit a copy of the dated bill of sale.

This warranty gives you specific legal rights. You may also have other rights which vary from state to state.

## AC LINE CONNECTIONS FOR OVERSEAS USE

The power transformer supplied in DH-200 amplifiers sold in the USA is intended for 120 volt, 60 Hz operation only. For use in other countries, a multi-voltage transformer is available at higher cost. It has dual tapped primary windings which can be arranged in various series-parallel combinations for 100, 110, 120, 200, 220 and 240 volt 50 or 60 cycle lines. The schematic diagram details the wiring combinations which are represented pictorially here.

Note that a 5-lug terminal strip is required when the multi-voltage transformer is used. This, and the 100,000 ohm resistor which is sometimes needed to illuminate the pilot lamp, is supplied in kits which include the special transformer. If the amplifier is operated with 200 to 240 volt lines, the 5 amp line fuse which is supplied should be replaced with a 2-1/2 amp Slo-Blo type fuse.

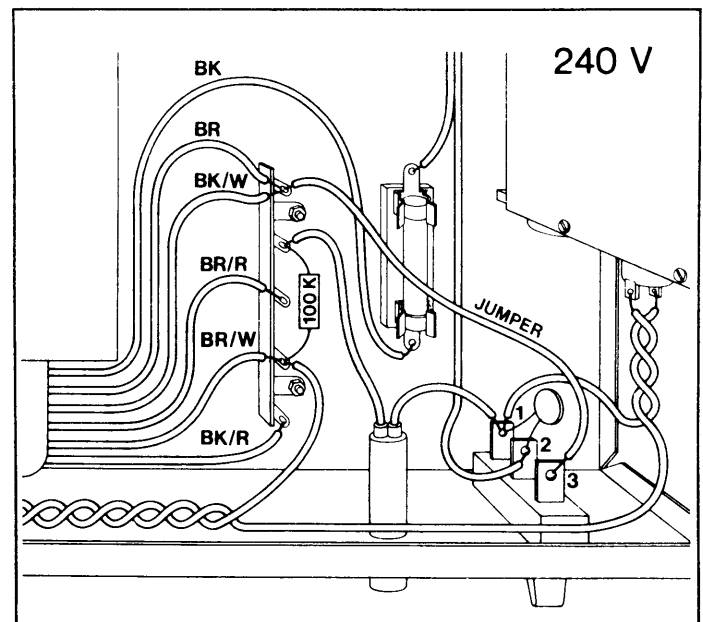
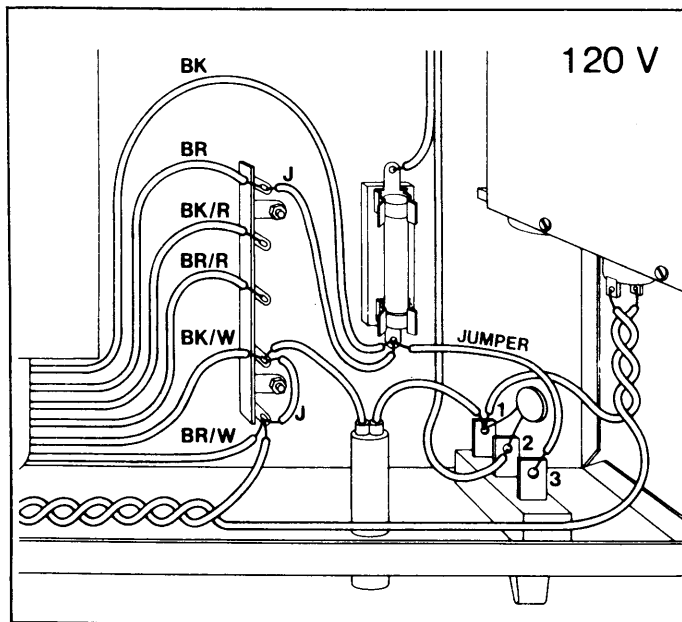
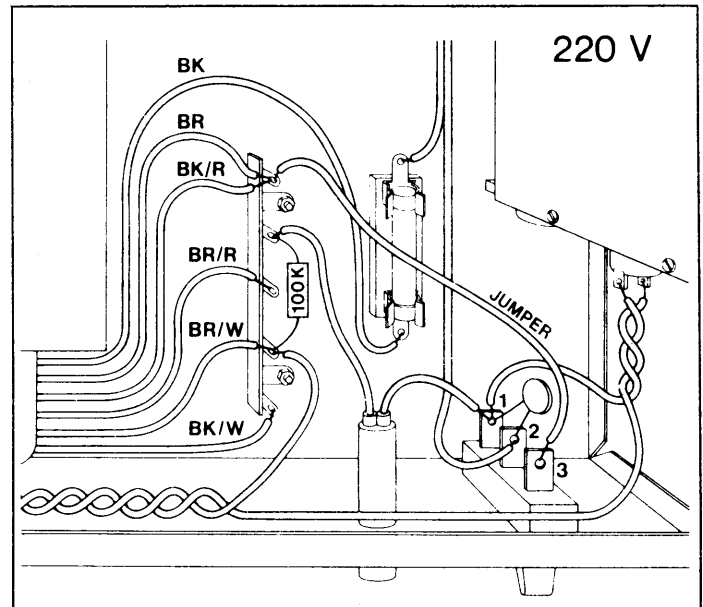
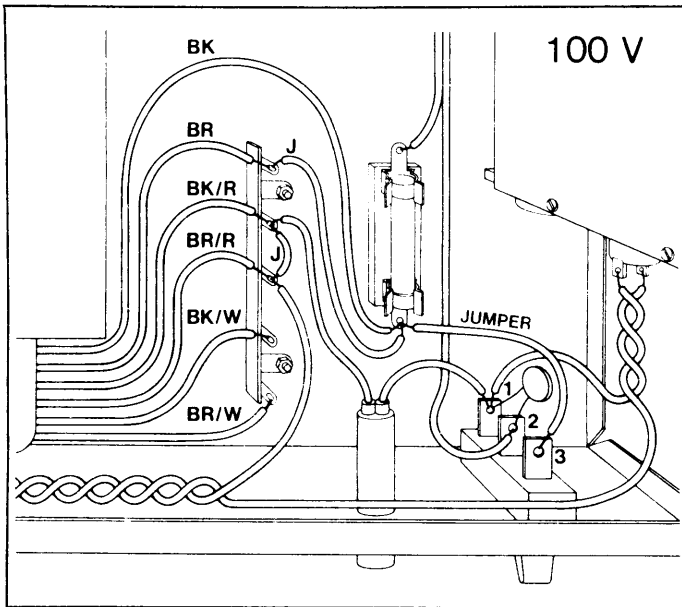
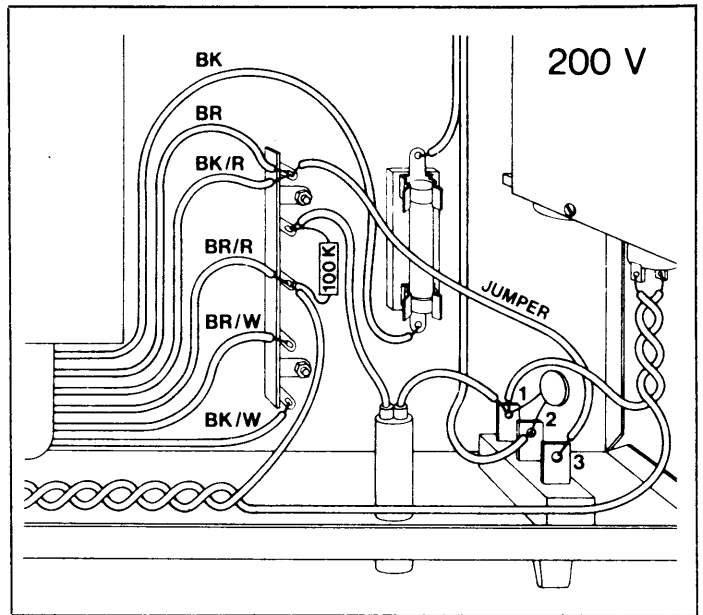

# KIT PARTS LIST

Minor variations may sometimes be encountered in value or appearance. These will not affect performance.

### Fuse Envelope

	Part No.
6 Fuse, 5 ampere	341050
1 Fuse, 5 ampere, Slo-Blo	342050
2 Fuse, 2 ampere	341020

### Hardware Envelope

	Part No.
1 Lug, solder type, internal tooth, #6	619308
4 Lug, solder type, #10	629508
8 Nut, #4-40 KEP	614245
9 Nut, #6-32 KEP	614345
4 Nut, #10-32 KEP	614565
2 Nut, #10-32 KEP, for clamp	614569
1 Nut, spring steel, Tinnerman type	610041
2 Nut, #4-40 nylon	694241
2 Nut, 1/2", for fuse holder	615074
10 Screw, machine, #4 x 5/16"	611255
8 Screw, machine, #6 x 1/2"	611385
4 Screw, machine, #10 x 1/2"	611585
2 Screw, machine, #10 x 3/4" for clamp	611579
4 Screw, #10 x 1/4", SEMS	611545
16 Screw, sheet metal, #6 x 1/2"	612387
1 Screw, machine, #6 x 3/4"	611375
4 Washer, flat 7/8"	616575
2 Washer, locking, internal tooth, 1/2" for fuse holder	617085
2 Washer, rubber, 1/2" for fuse holder	696081

1 Chassis	711007
1 Cover	711008
2 Capacitor, 10,000 mfd, 75V	294103
2 Bracket, round, for capacitor	717058
1 Diode rectifier block	544252
4 Feet, rubber	899757
2 Fuse holder, round	351003
1 Fuse clip, single	351002
2 Fuse clip, dual	352001
1 Indicator light assembly	526001
1 Input socket, round	351318
1 Input socket, narrow	351326
1 Insulator disk, round, for socket	815318
1 Label, serial number	808005
1 Line cord, with plug	322001
2 Output module assembly (1 each, left and right)	994001
2 Output terminal, black, with hardware	351005
2 Output terminal, red, with hardware	351006
1 Power switch	332001
1 Strain relief, plastic	895001
1 Terminal strip, 2 lug alternate 5 lug for international use	373181 377181
1 Transformer, power alternate for international use	464002 464003
1 Wire, white, #18	
1 Wire, green, #18	
1 Registration card	

### Small Parts Envelope

	Part No.
1 Capacitor, .01 mfd, disc	238103
1 Capacitor, .005 mfd (5000M), disc	238502
2 Capacitor, 0047 mfd film	264472
1 Resistor, 2.2 ohms	133022
2 Numbered strip, for eyelets	808101

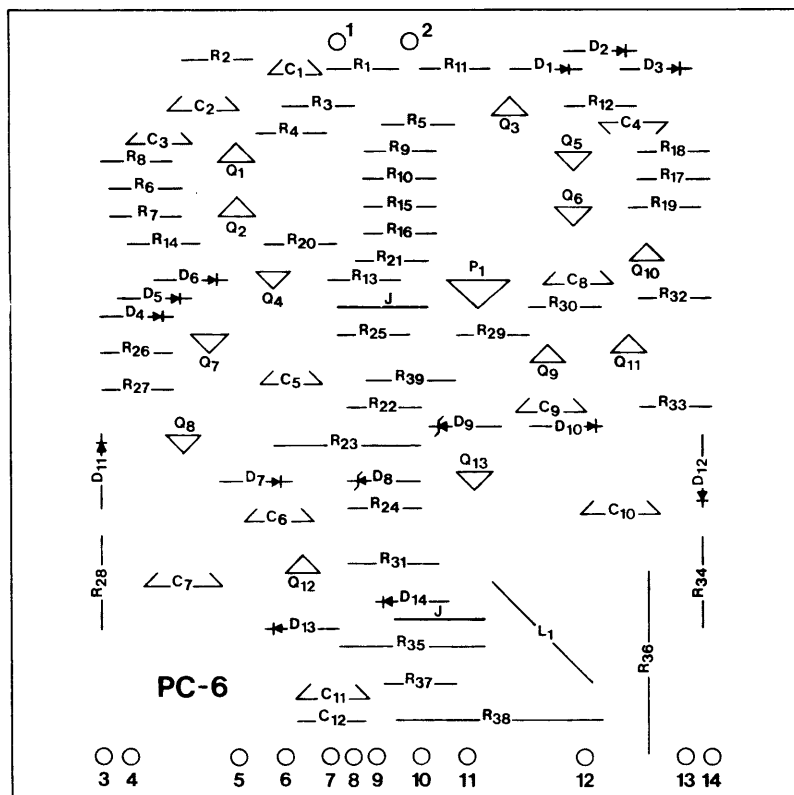

PC-6

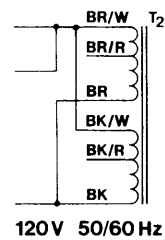
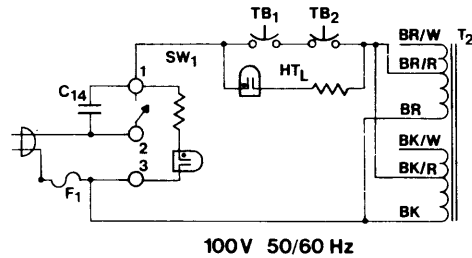
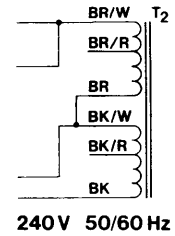
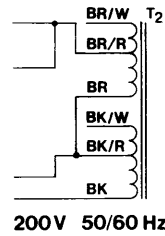
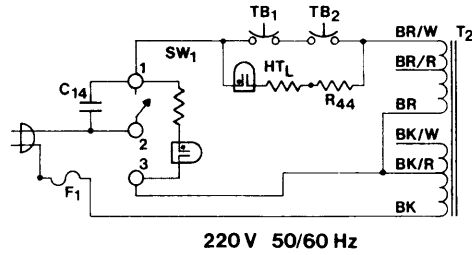
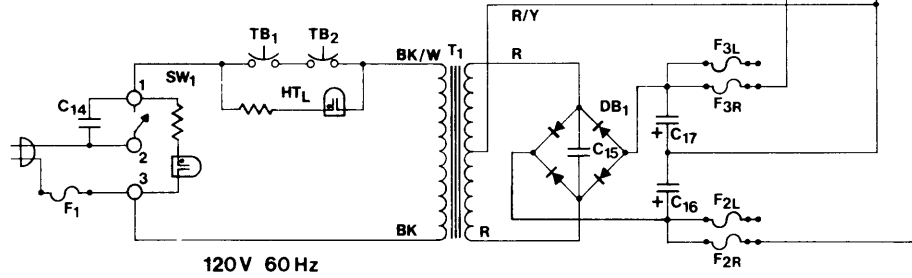
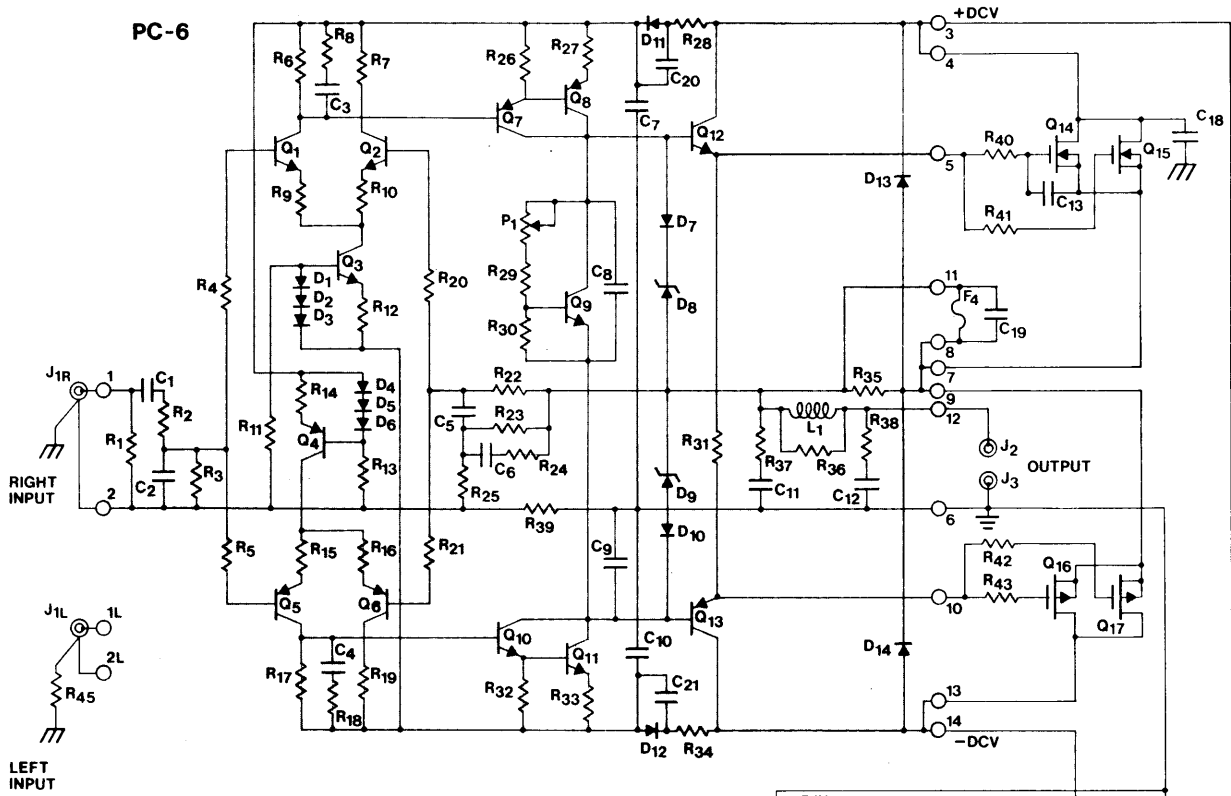

# SCHEMATIC DIAGRAM

© Copyright 1980. All rights reserved.

## COMPONENT VALUES

All resistors are 1/4 watt 5% carbon film unless otherwise noted.

R1	470,000 ohms	Part No. 139474	C1	10 mfd, 16 V, non-polarized electrolytic	203106
R2	2,200 ohms	139222	C2	390 pF, 500V, Mica	257391
R3	22,000 ohms	139223	C3	0.001 mfd, 100V, Film	264102
R4	100 ohms	139101	C4	0.001 mfd, 100V, Film	264102
R5	100 ohms	139101	C5	470 mfd, 6.3V, non-polarized electrolytic	202477
R6	2,200 ohms	139222	C6	270 pF, 500V, Mica	257271
R7	2,200 ohms	139222	C7	100 mfd, 80V, Electrolytic	294107
R8	330 ohms	139331	C8	0.1 mfd, 100V, Film	264104
R9	22 ohms	139220	C9	680 pF, 500V, Mica	257681
R10	22 ohms	139220	C10	100 mfd, 80V, Electrolytic	294107
R11	39,000 ohms	139393	C11	0.01 mfd, 100V, Film	264103
R12	560 ohms	139561	C12	0.1 mfd, 100V, Film	264104
R13	39,000 ohms	139393	C13	390 pF, 500V, Mica	257391
R14	560 ohms	139561	C14	0.005 mfd, 1000V, Disc	238502
R15	22 ohms	139220	C15	0.01 mfd, 1000V, Disc	238103
R16	22 ohms	139220	C16	10,000 mfd, 75V, Electrolytic	294103
R17	2,200 ohms	139222	C17	10.000 mfd, 75V, Electrolytic	294103
R18	330 ohms	139331	C18	680 pF, 500V, Mica	257680
R19	2,200 ohms	139222	C19	0.0047 mfd, 100V, Film	264472
R20	100 ohms	139101	C20	0.01 mfd, 100V, Film	264103
R21	100 ohms	139101	C21	0.01 mfd, 100V, Film	264103
R22	22,000 ohms	139223	D1	1N4148	544148
R23	2,200 ohms, 1 watt	136222	D2	1N4148	544148
R24	560 ohms	139561	D3	1N4148	544148
R25	100 ohms	139101	D4	1N4148	544148
R26	1,800 ohms	139182	D5	1N4148	544148
R27	100 ohms	139101	D6	1N4148	544148
R28	47 ohms, carbon comp.	119470	D7	1N4148	544148
R29	1,000 ohms	139102	D8	1N5240B	540510
R30	470 ohms	139471	D9	1N5240B	540510
R31	220 ohms, 1/2 watt	133221	D10	1N4148	544148
R32	1,800 ohms	139182	D11	1N4003	544102
R33	100 ohms	139101	D12	1N4003	544102
R34	47 ohms, carbon comp.	119470	D13	1N4003	544102
R35	2,200 ohms, 1 watt	136222	D14	1N4003	544102
R36	1 ohm, 5 watt, 10% w.w.	120010	DB1	Diode bridge	544252
R37	10 ohms	139100	Q1	2N5550	572550
R38	10 ohms, 2 watt	190100	Q2	2N5550	572550
R39	0.5 ohms, 1/2 watt	133509	Q3	2N5550	572550
R40	220 ohms, 1/2 watt	133221	Q4	2N5401	562401
R41	220 ohms, 1/2 watt	133221	Q5	2N5401	562401
R42	220 ohms, 1/2 watt	133221	Q6	2N5401	562401
R43	220 ohms, 1/2 watt	133221	Q7	2N5401	562401
R44	100,000 ohms, 1/2 watt	133104	Q8	2N5415	562415
R45	2.2 ohms, 1/2 watt	133022	Q9	NP2222	572222
P1	1,000 ohms trimpot	100102	Q10	2N5550	572550
F1	Fuse 5A Slo-Blo 3AG	342050	Q11	2N3440	572440
F2	Fuse 5A, 3AG	341050	Q12	2N3440	572440
F3	Fuse 5A, 3AG	341050	Q13	2N5415	562415
F4	Fuse 2A, 3AG	341020	Q14	2SK134	571134
T1	Power Transformer	464002	Q15	2SK134	571134
T2	Power Transformer, International	464003	Q16	2SJ49	561049
			Q17	2SJ49	561049

## SPECIFICATIONS

**Power Rating:** Less than 0.02% total harmonic distortion at any power level up to 100 watts continuous average power per channel into 8 ohms at any frequency between 20 Hz and 20 kHz with both channels driven.

**IM Distortion (SMPTE):** Less than 0.005% from 1 watt to 100 watts into 8 ohms.

**Typical THD at 100 watts into 8 ohms:**

1 kHz — 0.0015%  
10 kHz — 0.005%  
20 kHz — 0.012%

**Frequency Response into 8 ohms:**

— 3 dB, 1 Hz to 100 kHz at 1 watt  
± 0.5dB, 10 Hz to 40 kHz at 100 watts

**Typical Channel Separation:** 20 Hz: 66 dB  
1 kHz: 66 dB  
20 kHz: 60 dB

**Signal to Noise Ratio, unweighted:** Better than 100 dB at 100 watts into 8 ohms.

**Input Impedance:** 22,000 ohms.

**Input Sensitivity:** 1.5 volts rms for 100 watts into 8 ohms.

**Damping Factor:** 150 to 1 kHz into 8 ohms  
50 to 10 kHz into 8 ohms

**Rise Time:** 10 kHz, 60 volts peak to peak square wave,  
10% to 90% : 2.5  $\mu$ s.

**Slew Rate:** 10 kHz, 60 volts peak to peak square wave: 30  
V/ $\mu$ s.

**Semiconductor Complement:** 26 transistors, 8 power  
Mosfets, 24 diodes, 4 zener diodes, 1 diode bridge.

**Power Consumption:** Quiescent: 100 VA; 100 watts into  
8 ohms: 370 VA.

**Size:** 5-1/8" high, 16" wide, 10-1/2" deep.

**Net Weight:** 26 lbs. **Shipping Weight:** 30 lbs.

All Specifications are subject to change without notice.

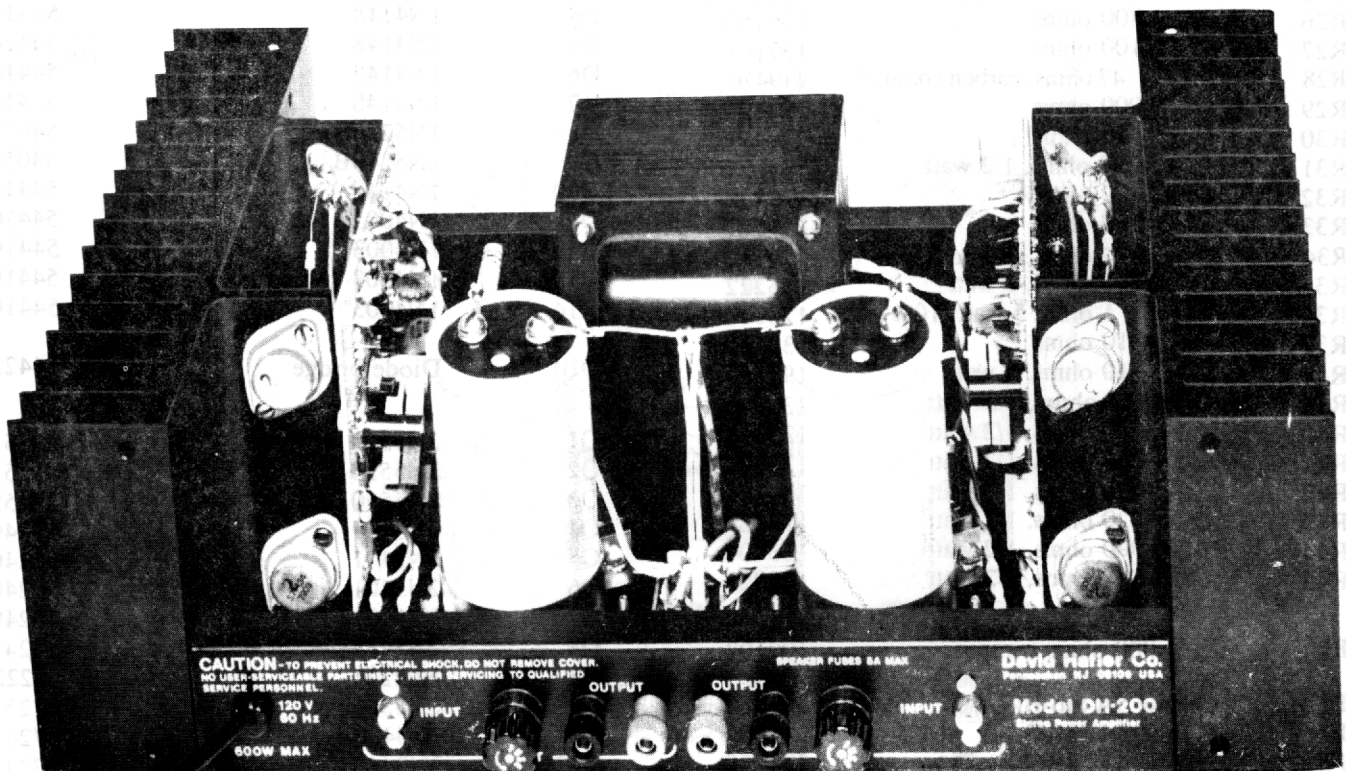



**HAFLER DH-200 STEREO POWER AMPLIFIER**  
**PICTORIAL DIAGRAM**

© COPYRIGHT 1980. ALL RIGHTS RESERVED

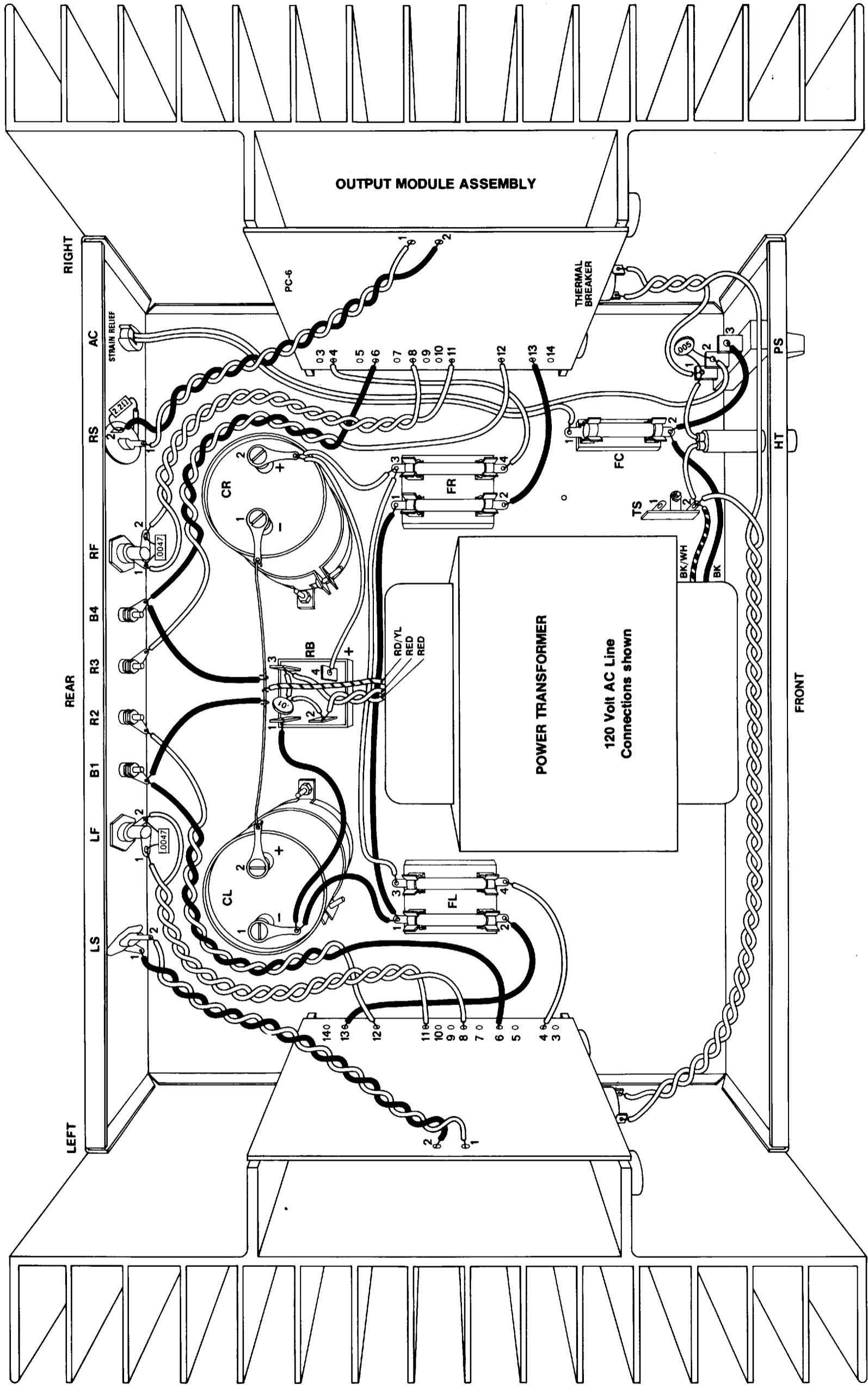

inches

0

1

2

3

4

5

6

7

8

9

10

11

12

13

14

15

16

0

1

2

3

4

5

6

7

8

9

centimeters

0

1

2

3

4

5

6

7

8

9

10

11

12

13

14

15

16

0

1

2

3

4

5

6

7

8

9

