

D E F G H I J K L M

PCB1 (MAIN)

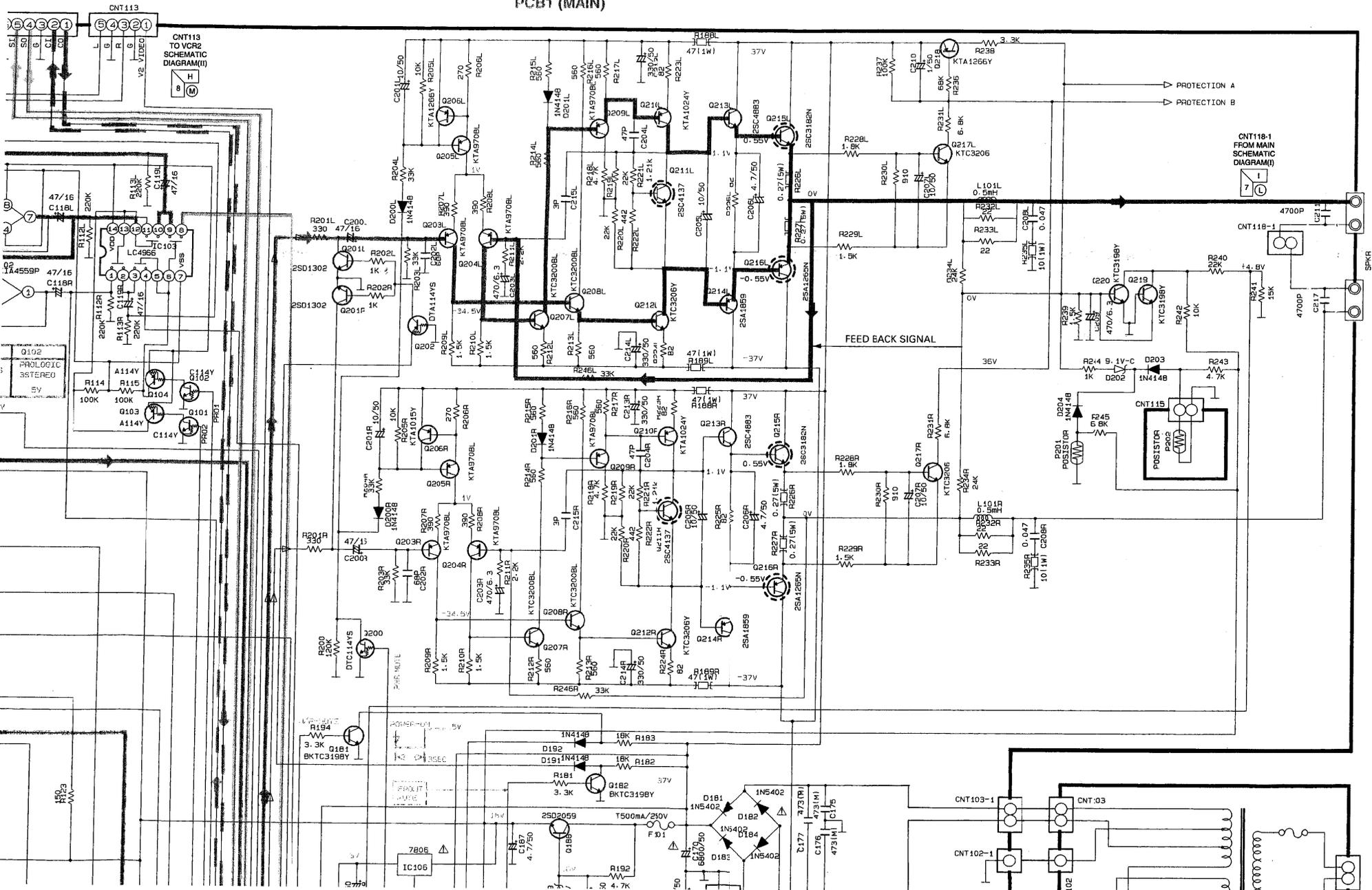

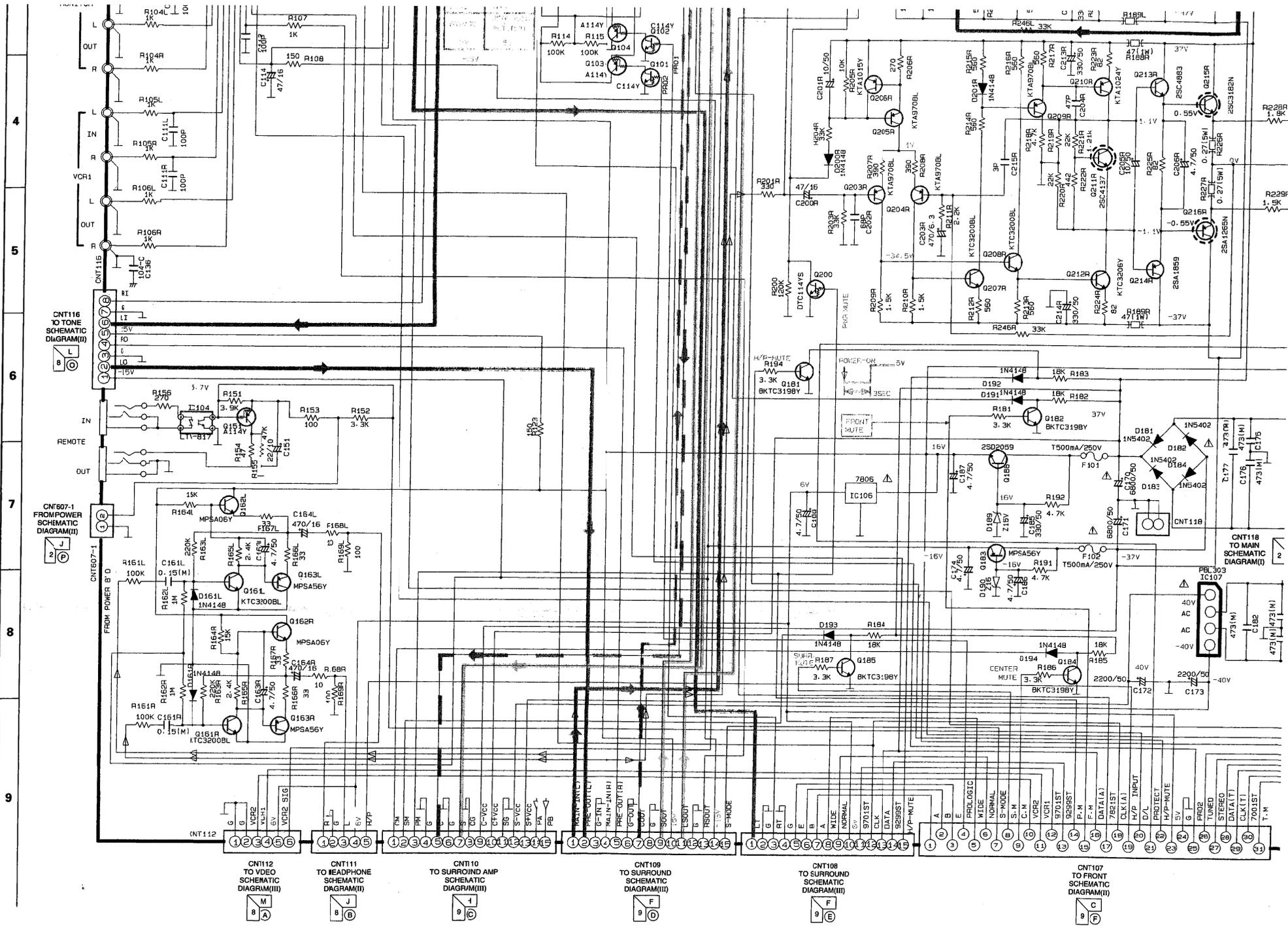

CNT116 TO TONE SCHEMATIC DIAGRAM(II)

CNT607-1 FROM POWER SCHEMATIC DIAGRAM(II)

CNT112 TO VIDEO SCHEMATIC DIAGRAM(II)

CNT111 TO HEADPHONE SCHEMATIC DIAGRAM(II)

CNT110 TO SURROUND AMP SCHEMATIC DIAGRAM(III)

CNT109 TO SURROUND SCHEMATIC DIAGRAM(III)

CNT108 TO SURROUND SCHEMATIC DIAGRAM(III)

CNT107 TO FRONT SCHEMATIC DIAGRAM(III)

4

5

6

7

8

9

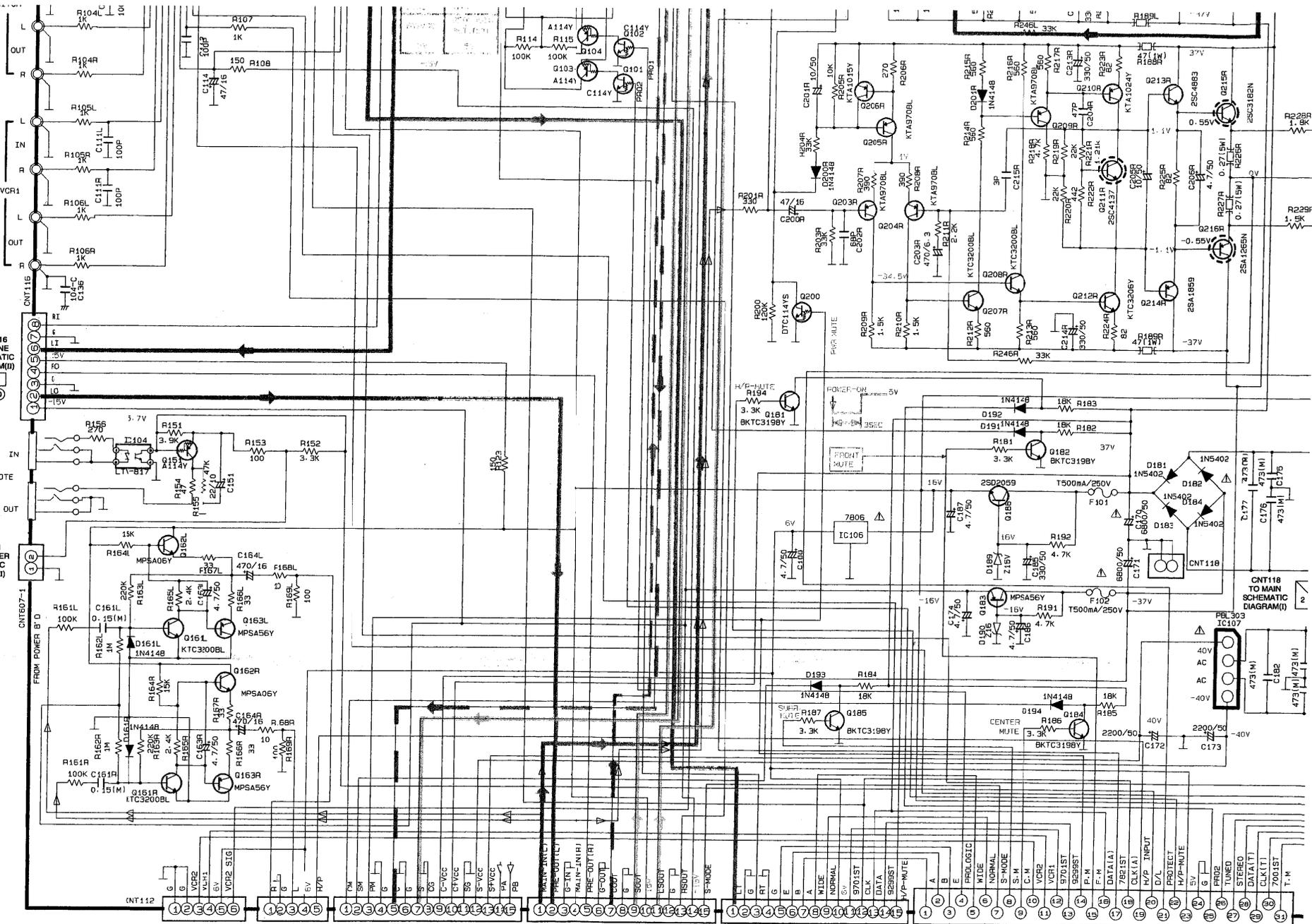

CNT116 TO TONE SCHEMATIC DIAGRAM(II)

CNT607-1 FROM POWER SCHEMATIC DIAGRAM(II)

CNT112 TO VIDEO SCHEMATIC DIAGRAM(II)

CNT111 TO HEADPHONE SCHEMATIC DIAGRAM(II)

CNT110 TO SURROUND AMP SCHEMATIC DIAGRAM(III)

CNT109 TO SURROUND SCHEMATIC DIAGRAM(III)

CNT108 TO SURROUND SCHEMATIC DIAGRAM(III)

CNT107 TO FRONT SCHEMATIC DIAGRAM(III)

4

5

6

7

8

9

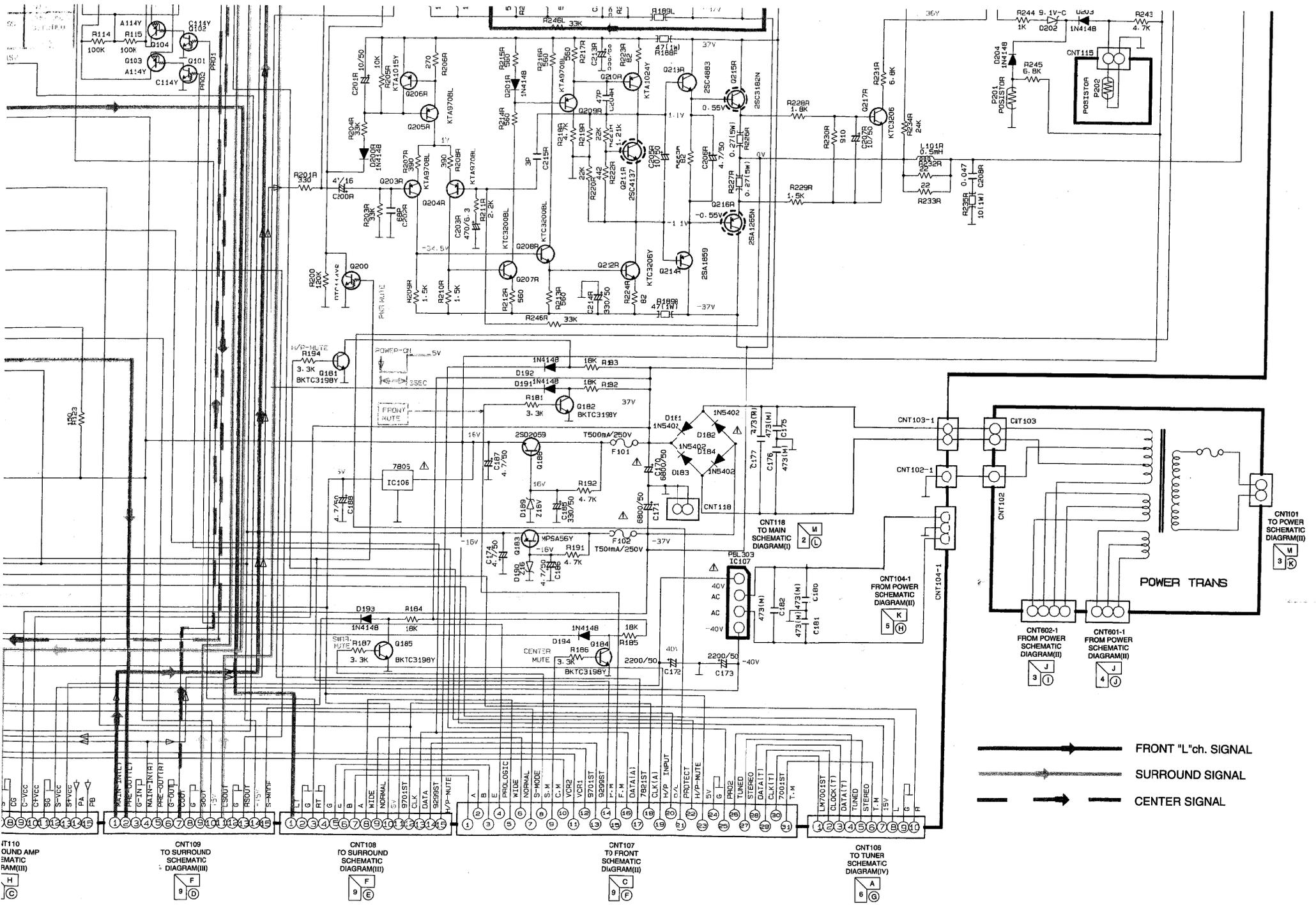

→ FRONT "L"ch. SIGNAL
 → SURROUND SIGNAL
 → CENTER SIGNAL

IC110
 QUND AMP
 EMATIC
 RAM(III)
 H C

CNT109
 TO SURROUND
 SCHEMATIC
 DIAGRAM(III)
 F D

CNT108
 TO SURROUND
 SCHEMATIC
 DIAGRAM(III)
 F E

CNT107
 TO FRONT
 SCHEMATIC
 DIAGRAM(III)
 C P

CNT106
 TO TUNER
 SCHEMATIC
 DIAGRAM(IV)
 A G

SCHEMATIC DIAGRAM II

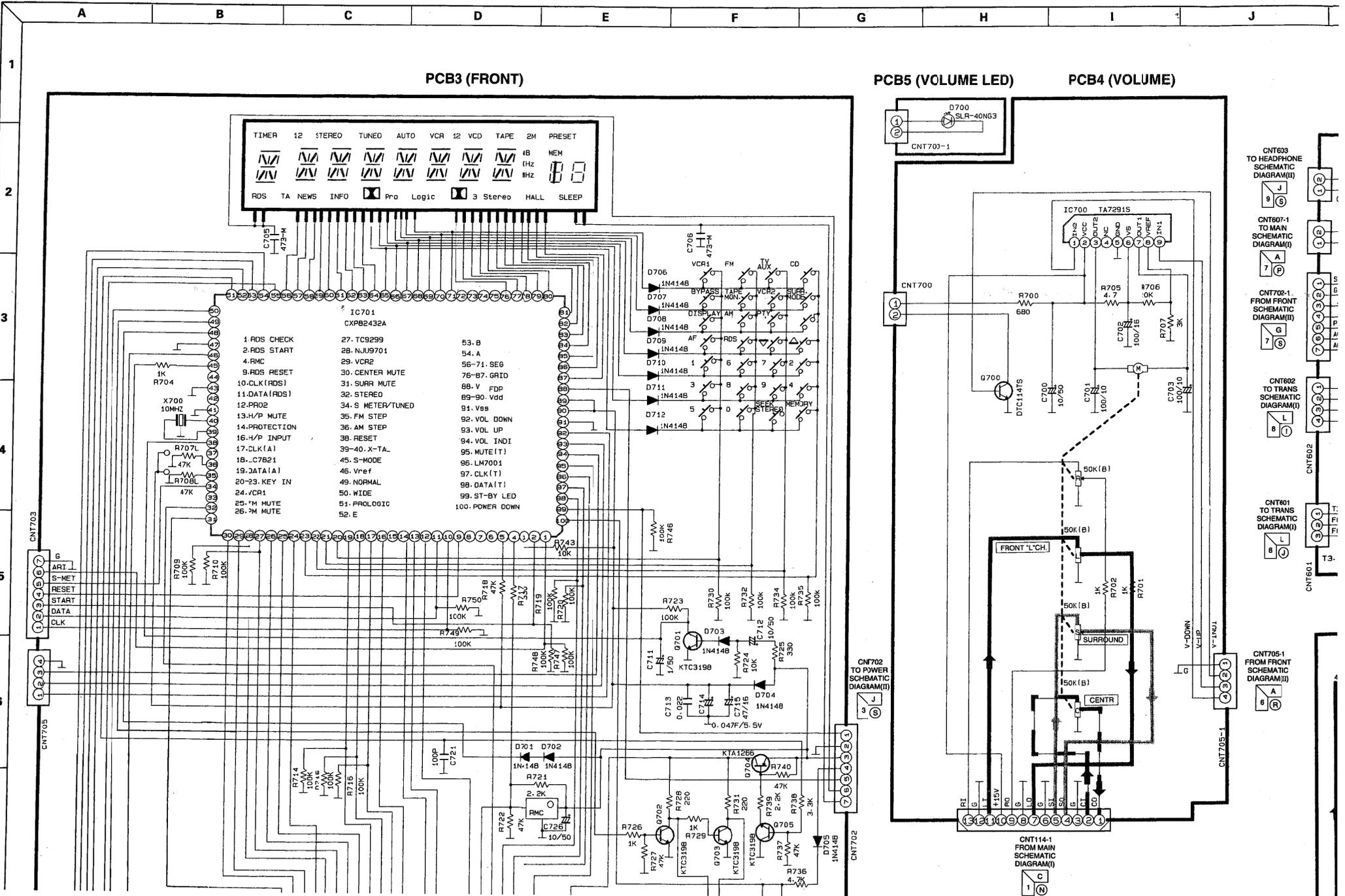

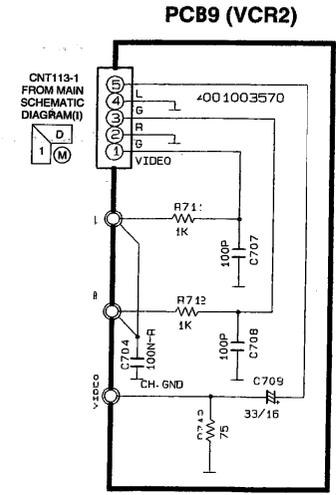
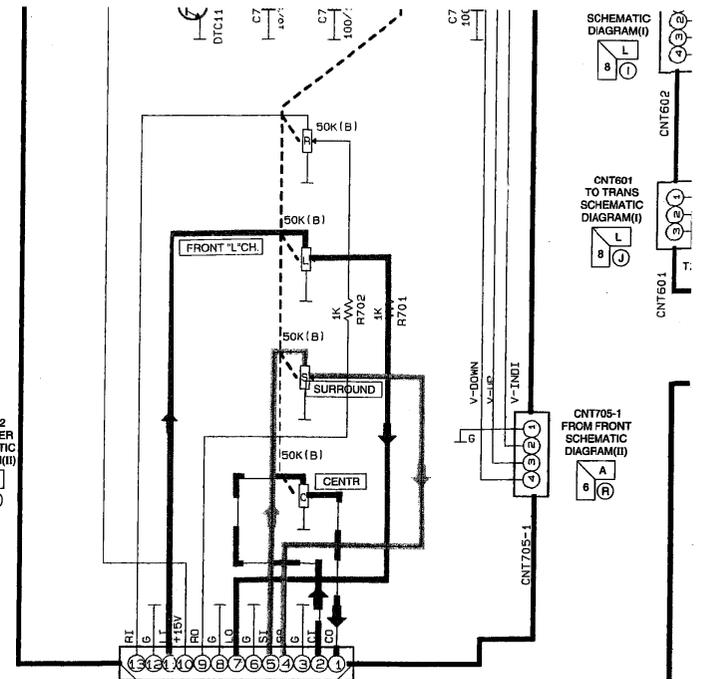
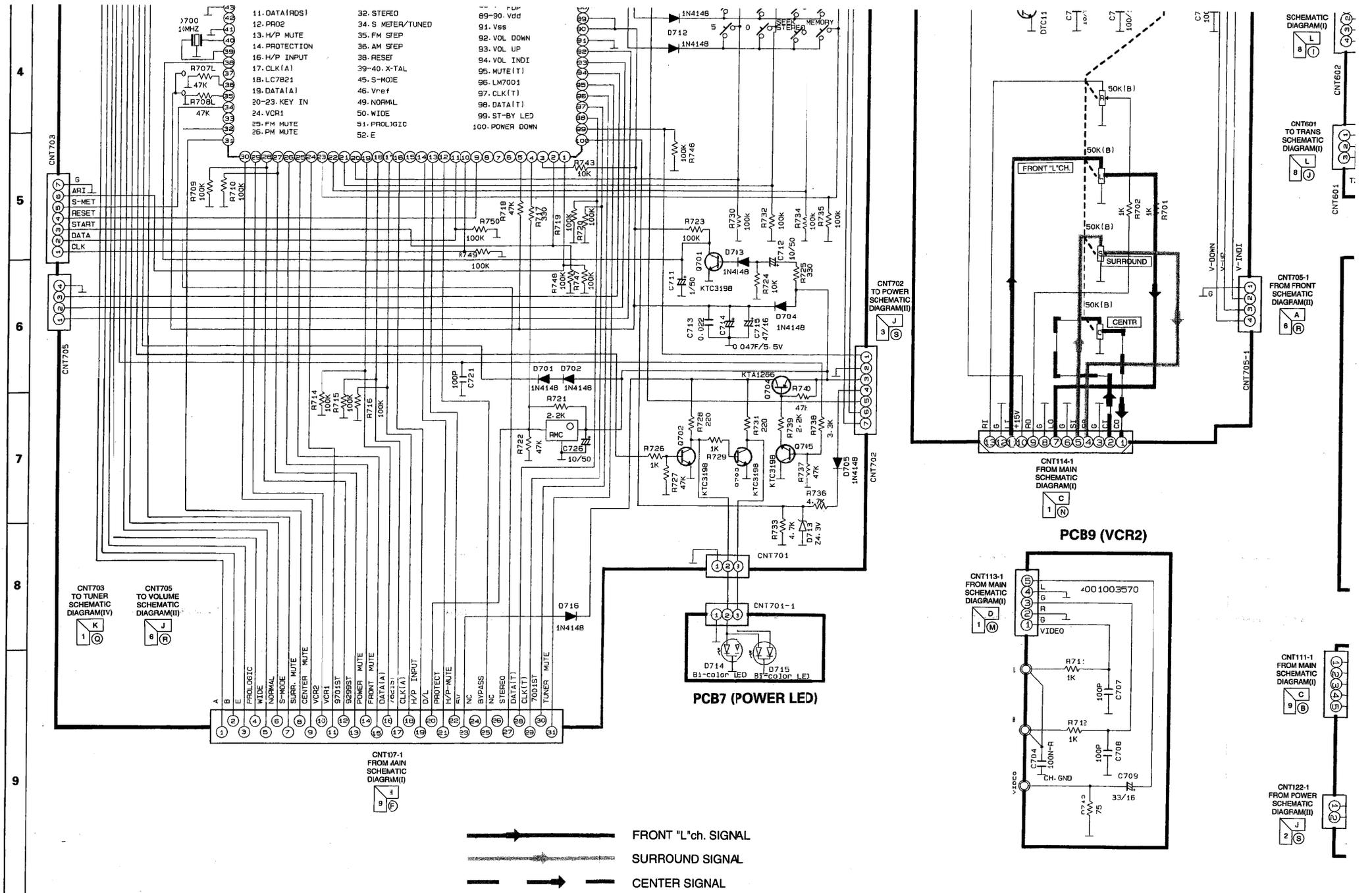

D E F G H I J K L M

PCB11 (SURROUND)

PCB10 (SURROUND AMP)

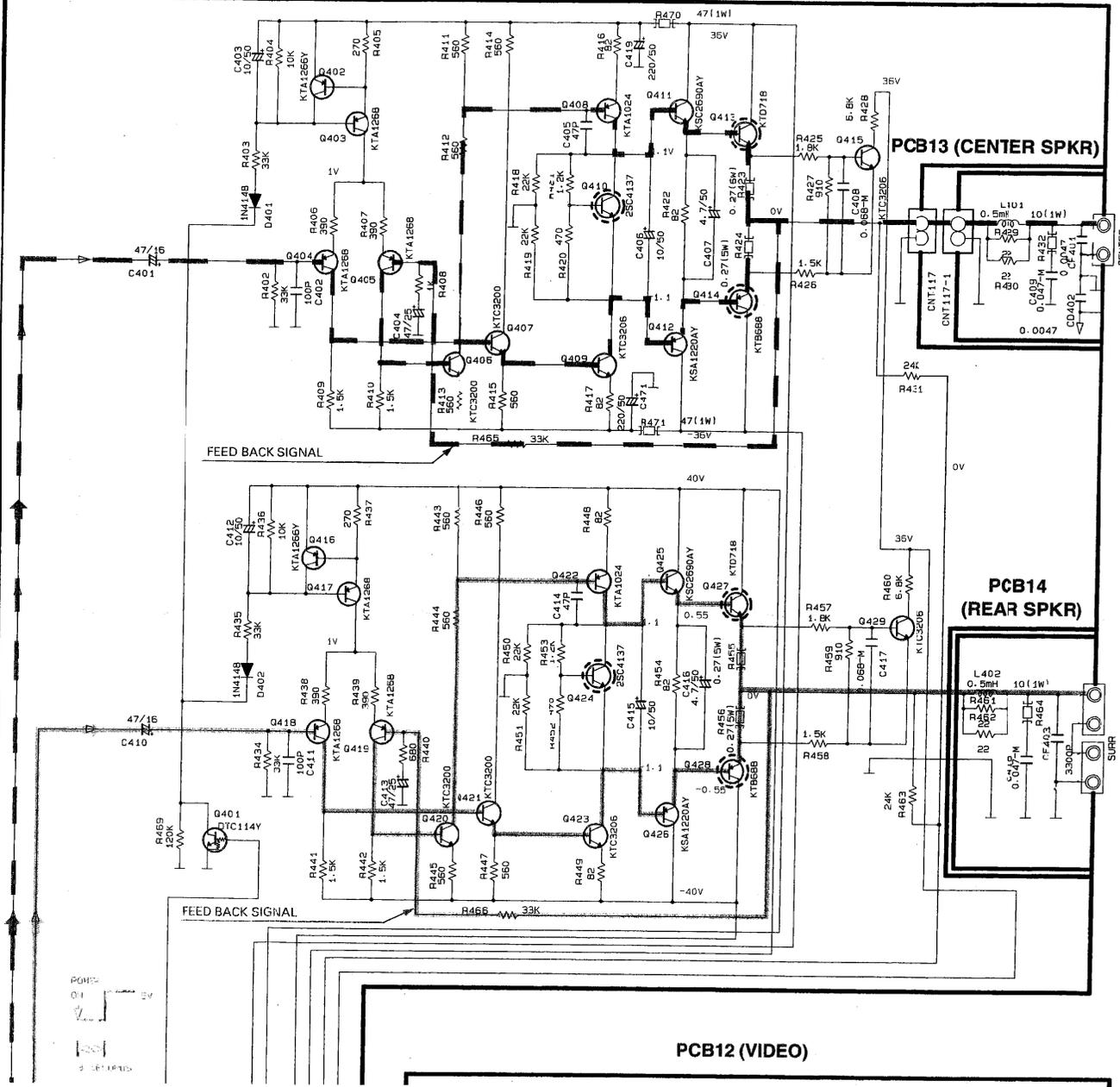
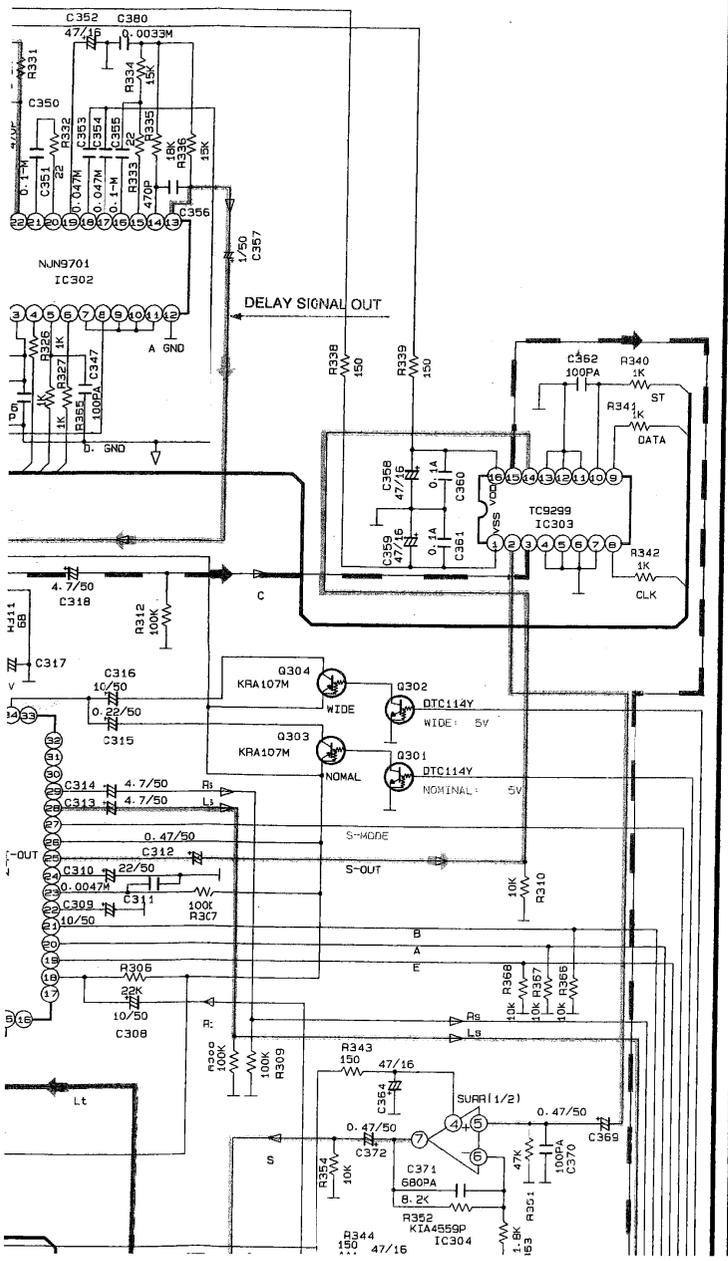

PCB12 (VIDEO)

4

5

6

7

8

9

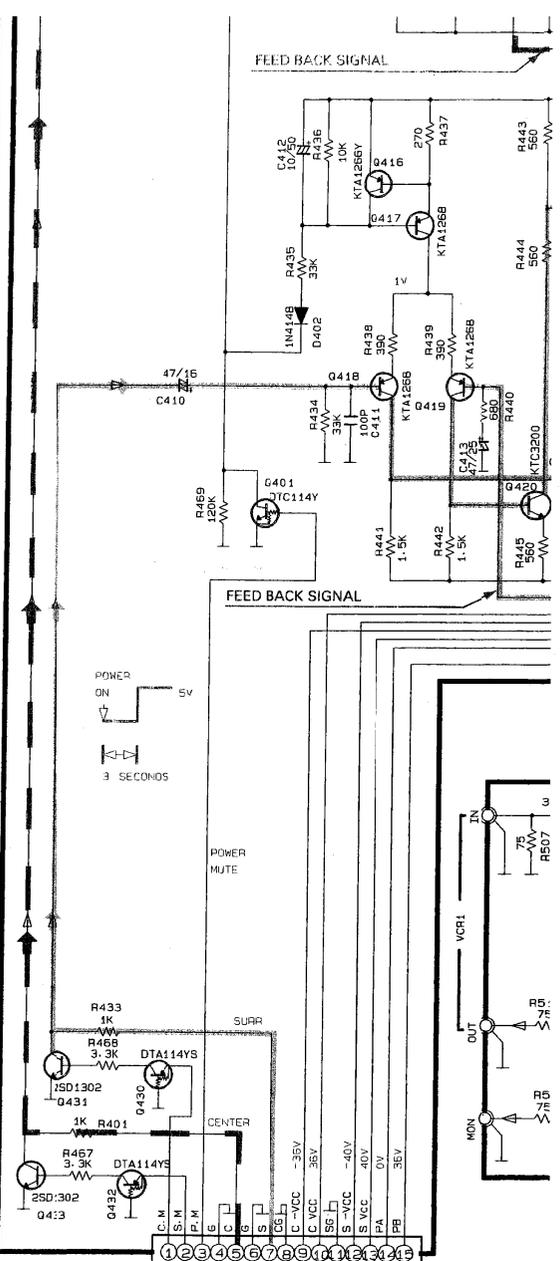
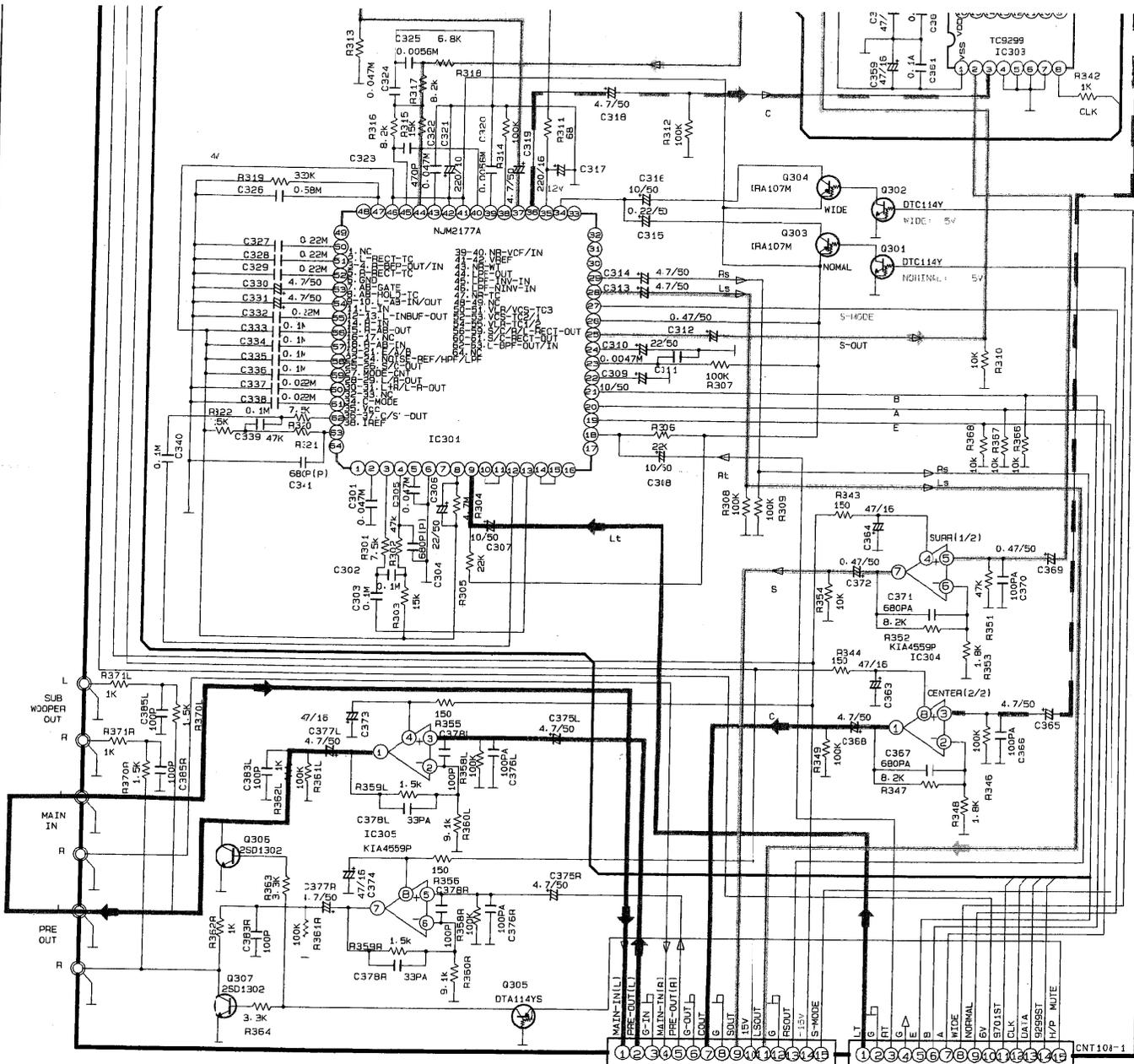

CNT108-1 FROM MAIN SCHEMATIC DIAGRAM(I)
 8 (D)

CNT108-1 FROM MAIN SCHEMATIC DIAGRAM(I)
 9 (E)

CNT110-1 FROM MAIN SCHEMATIC DIAGRAM(I)
 9 (C)

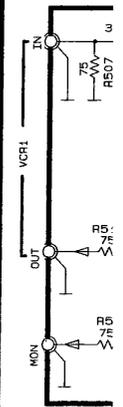

SCHEMATIC DIAGRAM IV

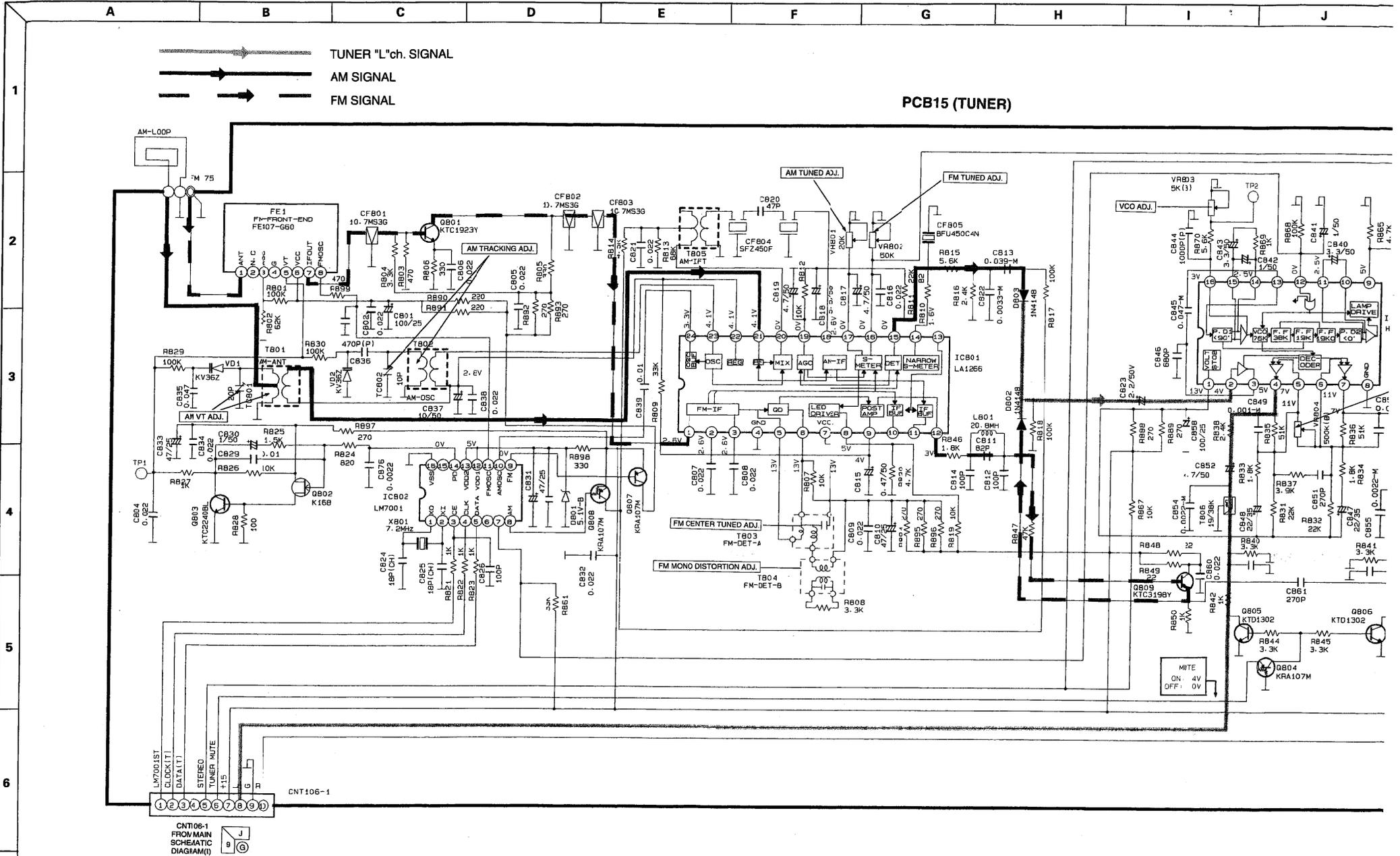

CNT106-1
FROM MAIN
SCHEMATIC
DIAGRAM(I)

E

F

G

H

I

J

K

L

M

PCB15 (TUNER)

CNT703-1
FROM FRONT
SCHEMATIC
DIAGRAM(II)

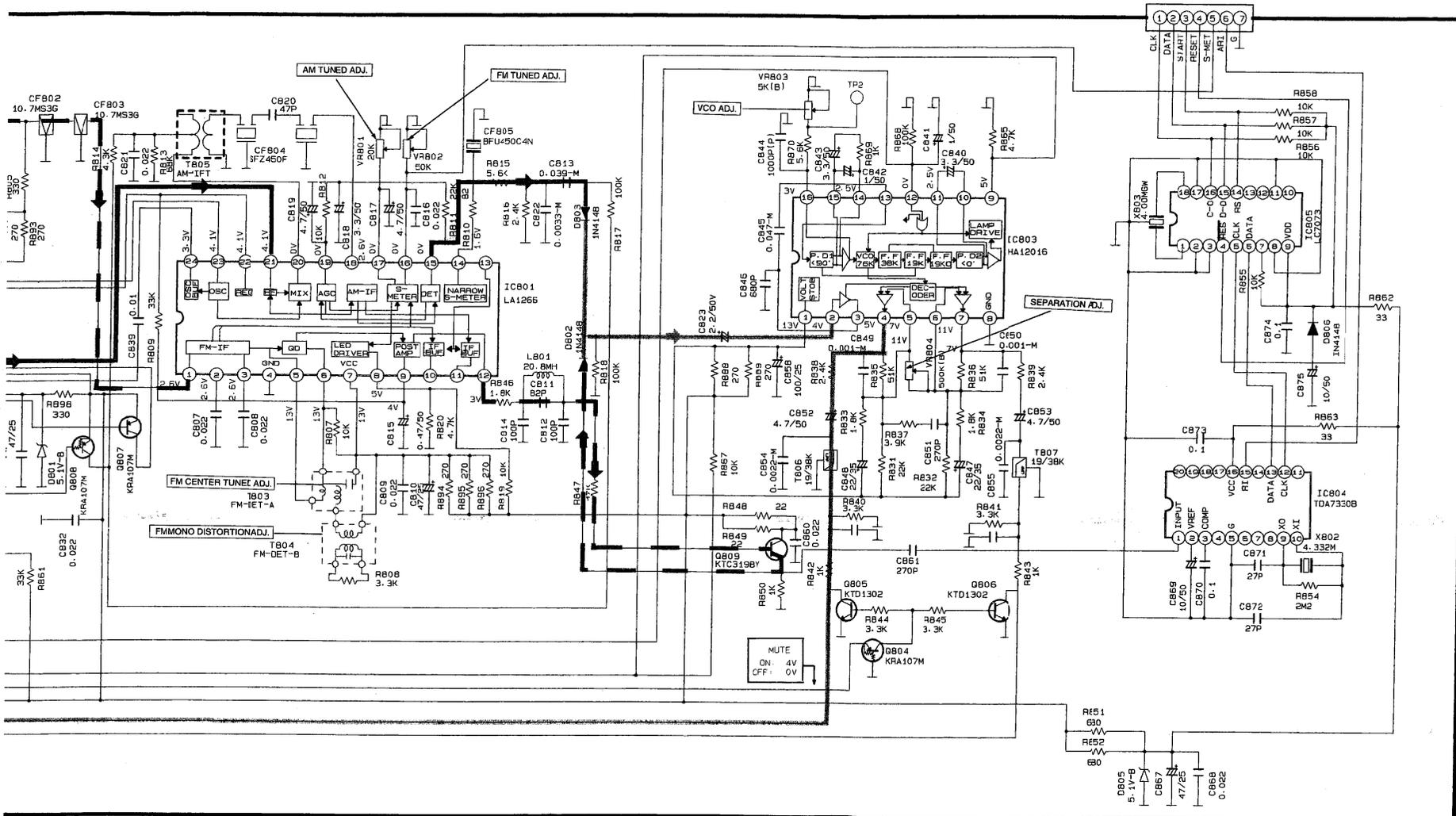

DB05 5.1V-B
CB67 47/25
CB68 0.022

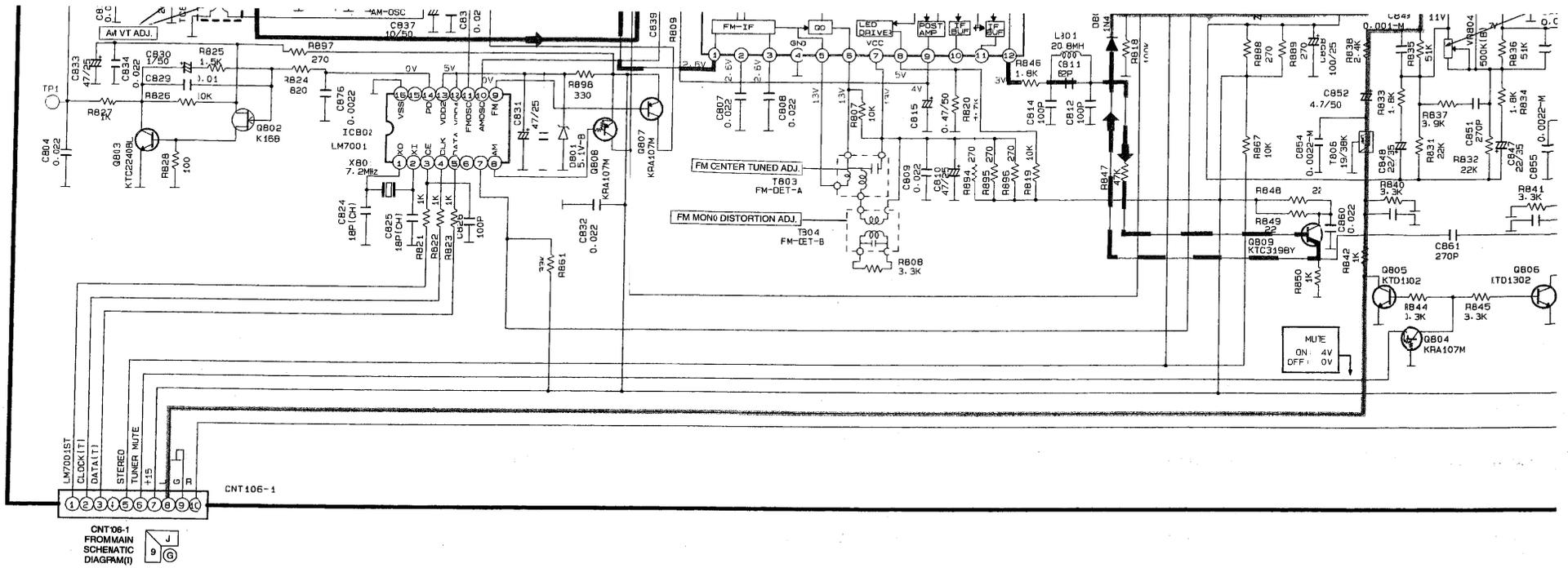

PIN CONNECTION DIAGRAM OF TRANSISTORS, IC'S AND DIODES.

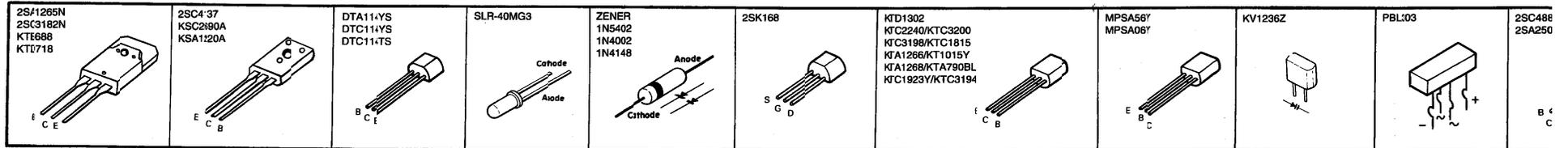

PIN CONNECTION DIAGRAM OF IC'S.

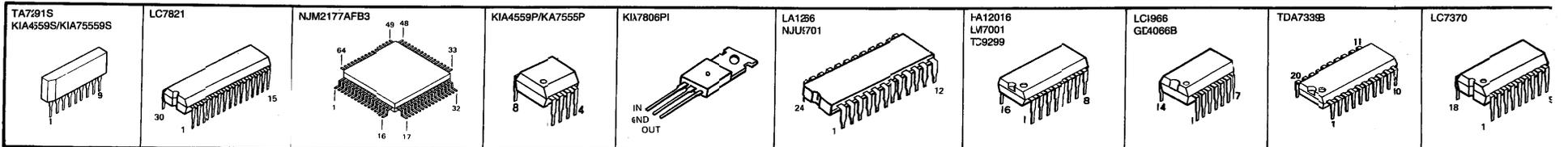

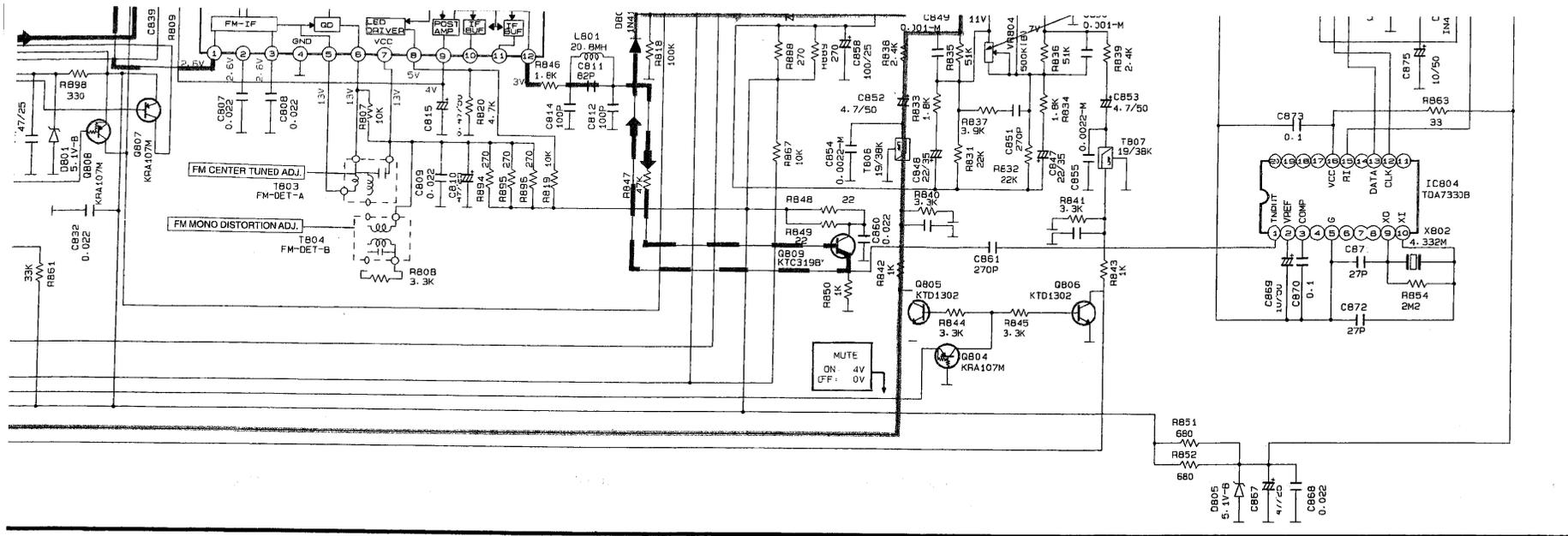

 ZENER 1N5402 1N4002 1N4148	25K168 	KTD1302 KTC2240/KTC3200 KTC3198/KTC:815 KTA1268/KTA115Y KTA1268/KTA:90BL KTC1923Y/KTC3194	MPSA56Y MPSA06Y 	KV1236Z 	PBL303 	2SC4883A 2SA2509Y/KTD2059Y 	KTC2229/KTC3206 KTA949/KTA1024 	SLR54MDW3
---	------------	--	------------------------	-------------	------------	-----------------------------------	---------------------------------------	---------------

IP/KIA7555P 	KIA7806PI 	LA1266 NJU9701 	HA12016 LM7001 TC9299 	LC4966 GD4066B 	TD/7339B 	LC7370
-----------------	---------------	-----------------------	---------------------------------	-----------------------	--------------	------------