

# HKTS 20/230, HKTS 30/230 – HKTS 30/WQ HKTS 60/230.

Surround loudspeaker systems with active subwoofer.  
Earlier versions with HKTS 200 SUB.  
Later versions with HKTS 210 SUB.



## CONTENTS

HKTS 20+30 USER GUIDE	2	HKTS 20+30WQ CENTER EXPL VIEW	40
HKTS 60 with 200 SUB USER GUIDE	13	HKTS 60 SAT EXPLODED VIEW	41
HKTS 60 with 210 SUB USER GUIDE	24	HKTS 200 SUB EXPLODED VIEW/PARTS	42
HKTS 20 SAT EXPLODED VIEW/PARTS	36	HKTS 200 PARTS LIST	43
HKTS 30 SAT EXPLODED VIEW/PARTS	37	HKTS 200 SCHEMATIC DIAGRAM	44
HKTS 30WQ SAT EXPLODED VIEW	38	HKTS 210 SUB EXPLODED VIEW/PARTS	45
HKTS 20+30 CENTER EXPLODED VIEW	39	HKTS 210 PARTS LIST	46
		HKTS 210 SCHEMATIC DIAGRAMS	47

# HKTS 20/HKTS 30

Home Theater Speaker System

User Guide  
English



**harman/kardon®**  
Designed to Entertain.™

# Harman Kardon® HKTS 20 / HKTS 30

## Introduction

Thank you for purchasing the Harman Kardon® HKTS20/HKTS30 speaker system, with which you're about to begin many years of listening enjoyment. The HKTS20/HKTS30 has been custom designed to provide all the excitement and power of the cinema experience in your own living room.

While sophisticated electronics and state-of-the-art speaker components are hard at work within the HKTS20 and HKTS30, hookup and operation are simple. Color-keyed cables and connections, and simple controls make the HKTS20/HKTS30 easy to use.

To obtain maximum enjoyment from your new home theater speaker system, we urge you to take a few minutes to read through this manual. This will help ensure that the connections you make to your receiver (or preamp/processor), amplifier and other devices are correct. In addition, a few minutes spent learning the functions of the various controls will enable you to take advantage of all the power and refinement the HKTS20/HKTS30 is able to deliver.

If you have any questions about this product, its installation or its operation, please contact your dealer, the best local source of information.

## Description and Features

The HKTS20/HKTS30 is a complete six-piece home theater speaker system that includes:

- An 8-inch, 200-watt powered subwoofer
- Four identical two-way video-shielded satellite speakers (the HKTS30 satellite speakers feature dual drivers) for the left and right front, and left and right rear (surround) speaker positions
- A dedicated, voice-matched, video-shielded, dual-driver center speaker
- Removable bases and wall-mount brackets for the satellite speakers and a wall-mount bracket for the center speaker
- All of the cables you need to connect all of the speakers to your receiver or preamp/processor and amplifier.

The speaker cables all use a color-coding system to conform to the Consumer Electronics Association (CEA) standard. This color-coding system minimizes confusion when connecting the speakers, especially when you are connecting them to a Harman Kardon receiver.

The HKTS200SUB subwoofer is equipped with a special LFE input that simplifies connection to receivers and preamp/processors with dedicated subwoofer outputs that carry low-frequency signals. Other conveniences include a level control, a phase switch for fine-tuning bass response to suit your listening environment and taste, and an efficient switching system that senses the presence of an audio signal and automatically switches the subwoofer from standby mode to on.

Wall-mount brackets are included for the satellite and center speakers, and shelf stands are included for the satellite speakers. Optional HKFS3 floorstands are available separately from your Harman Kardon dealer. Harman Kardon invented the high-fidelity receiver fifty years ago. With state-of-the-art features and time-honored circuit designs, the HKTS20/HKTS30 is a perfect complement to a Harman Kardon receiver, or any home theater system.

## Included

Four satellite speakers for front left/right and surround left/right (HKTS30 satellites shown)

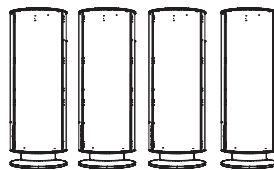

One powered subwoofer

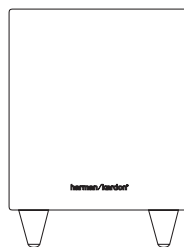

Four wall-mount brackets for satellite speakers

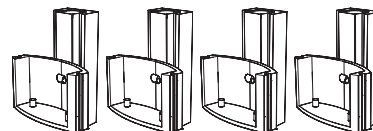

One wall-mount bracket for center speaker

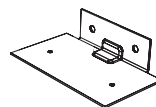

Four metal stop plates and screws (for satellite speaker wall-mount brackets)

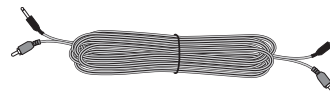
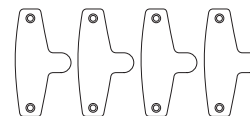

One combination LFE and trigger cable for connection to the subwoofer (LFE cable has purple connectors)

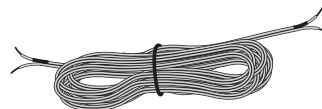

One 4-meter (13.1-foot) speaker cable for center speaker (green color bands)

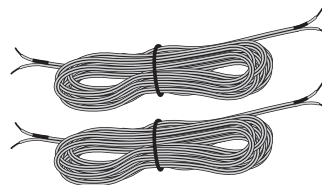

Two 5-meter (16.4-foot) speaker cables for front satellites (red and white color bands)

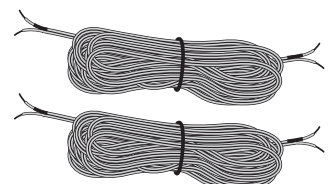

Two 10-meter (32.8-foot) speaker cables for rear satellites (gray and blue color bands)

# HKTS200SUB Rear-Panel Connections

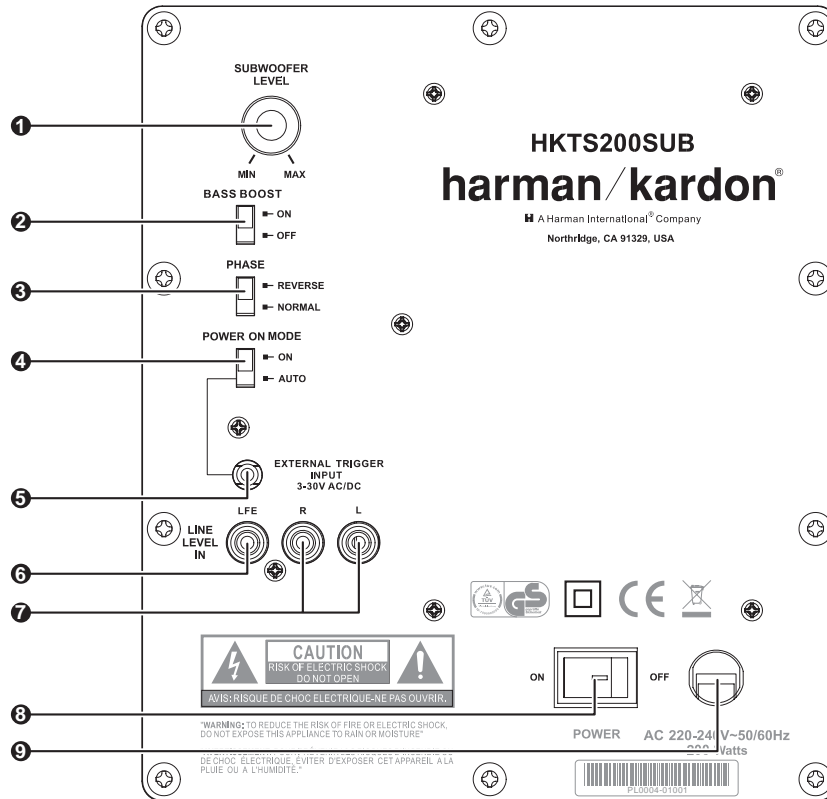

- 1 Subwoofer Level Control:** Use this control to adjust the HKTS200SUB's volume. Turn clockwise to increase the volume; turn counterclockwise to decrease the volume.
- 2 Bass Boost Switch:** Set this switch to **ON** to enhance the HKTS200SUB's low-frequency performance. Set this switch to **OFF** for normal low-frequency performance.
- 3 Phase Switch:** The Phase Switch **3** determines whether the HKTS200SUB's piston-like action moves in and out in phase with the satellite speakers. If the subwoofer were to play out of phase with the satellite speakers, the sound waves produced by the subwoofer could be canceled out, reducing bass performance and sonic impact. This phenomenon depends in part on the relative placement of all the speakers in the room. In most cases the Phase Switch **3** should be left in the **NORMAL** position. However, it does no harm to experiment, and you can leave the Phase Switch **3** in the position that maximizes bass response and impact.
- 4 Power On Mode Switch:** When set in the **AUTO** position and when the Power Switch **8** is set to **ON**, the HKTS200SUB will automatically turn itself on when it receives an audio signal, and will enter the standby mode once no audio signal has been received for about 15 minutes. When this switch is set in the **ON** position, the HKTS200SUB will remain on whether or not it is receiving an audio signal. An LED on the HKTS200SUB's top panel indicates whether the subwoofer is in the on or standby state:

  - When the LED is illuminated white, the HKTS200SUB is turned on.
  - When the LED is not illuminated, the HKTS200SUB is in standby mode.

When the Master Power Switch **8** is set to **OFF**, the LED will not be illuminated, no matter what setting the Power On Mode Switch **4** is in.
- 5 External Trigger Input:** Use the mini-plug of the supplied combination LFE and trigger cable to connect the External Trigger Input to the trigger output of another compatible component. Whenever a trigger signal between 3 and 30V (AC or DC) is detected, the HKTS200SUB's amplifier will turn on. The HKTS200SUB's amplifier will turn off after the trigger signal ceases. (This will occur even when the Power On Mode Switch **4** is in the **AUTO** position.)
- 6 Line-Level LFE In Connector:** Use the LFE (purple) connector of the supplied combination LFE and trigger cable to connect the Line-Level LFE In to the dedicated subwoofer output of a receiver or preamp/processor. This input bypasses the HKTS200SUB's internal crossover circuitry, so it should only be used with a subwoofer output that has been low-pass filtered. If your receiver or preamp/processor does not have a dedicated subwoofer output that is low-pass filtered you should use the HKTS200SUB's Line-Level L/R In Connectors **7** instead.
- 7 Line-Level L/R In Connectors:** Use these connectors if your receiver or preamp/processor does not have digital surround sound decoding or a subwoofer output that is low-pass filtered.

  - If your receiver or preamp/processor has a separate subwoofer output, use the LFE (purple) connector of the supplied combination LFE and trigger cable to connect it to either one of the HKTS200SUB's Line-Level L/R In Connectors.
  - If your receiver or preamp/processor does not have a separate subwoofer output, use two Y-adapters (not supplied). Connect an adapter's single end to the unit's preamp output for that channel. Connect one of the adapter's dual ends to the main amp input for that channel, and connect the adapter's other dual end to one of the HKTS200SUB's Line-Level L/R In Connectors. Repeat with the other Y-adapter, preamp channel, main amp input and HKTS200SUB Line-Level L/R In Connector.
- 8 Power Switch:** Set this switch in the **ON** position to turn the HKTS200SUB on. The subwoofer will then either be on or in standby mode, depending on the setting of the Power On Mode Switch **4**.
- 9 Power Cord (Non-Detachable):** After you have made and verified all subwoofer and speaker connections described in this manual, plug this cord into an active, *unswitched* electrical outlet for proper operation of the HKTS200SUB. DO NOT plug this cord into the accessory outlets found in some audio components.



# Speaker Placement

**NOTE:** The following speaker placement, mounting and connection instructions are identical for the HKTS20 and HKTS30 systems.

## Color-Coding System

The HKTS20 and HKTS30 use the channel color-coding system established by the CEA to make setting up your home theater speaker system as easy as possible. The HKTS20/ HKTS30 systems include speaker wires with color bands on each end.

Speaker Position	Wire Color Band
Front Left	White
Front Right	Red
Center	Green
Surround Left	Blue
Surround Right	Gray
Subwoofer	Purple

## Placing the Front Speakers

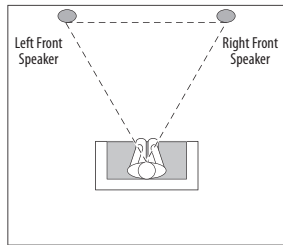

The front speakers should be placed the same distance from each other as they are from the listening position. They should be placed at about the same height from the floor as the listener's ears will be. They also can be angled toward the listener.

## Placing the Center Speaker

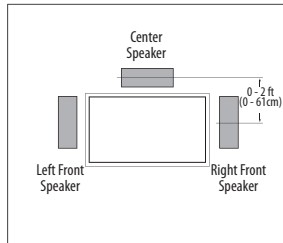

The center speaker should be placed slightly behind (farther away from the listener) the front left and right speakers. Its center should be no more than 2 feet (61cm) above or below the tweeters of the front left and right speakers. If you have a CRT television, it may be convenient to set the center speaker on top of the television set.

## Placing the Subwoofer

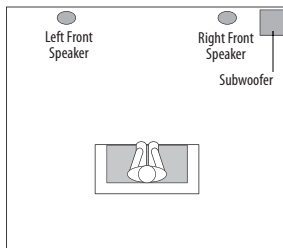

Since our ears do not hear directional sound at the low frequencies where the subwoofer operates, it will have good performance from just about any location in your room. However, the best bass reproduction is likely to be heard when the subwoofer is placed in a corner along the same wall as the front left and right speakers. You can experiment with subwoofer placement by temporarily placing it in the listening position and playing music with strong bass content. Move around to various locations in the room while the system is playing and listen until you find the location where the bass performance is best. Place the subwoofer in that location.

## Placing the Surround Speakers

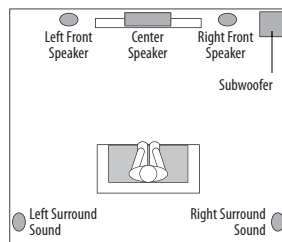
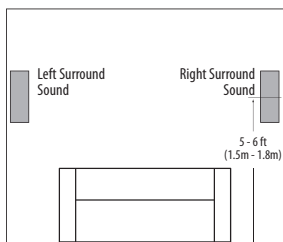

The two surround speakers should be placed slightly behind the listening position, facing each other and, ideally, should be 5–6 feet (1.5m–1.8m) from the floor. An alternate location would be on a wall behind the listening position, facing forward. The surround speakers should not call attention to themselves while they're playing. Experiment with their placement until you hear a diffuse, ambient sound accompanying the program material heard from the front left and right and center speakers.

## Mounting Options for Satellite and Center Speakers

### Shelf Placement

You can place the satellite and center speakers on shelves. The satellite speakers have built-in bases for shelf placement. You can also remove the bases if desired.

To remove a satellite speaker's base, pull it straight off the speaker, as shown in the illustration. Applying even pressure to both sides of the base will allow it to slide off smoothly.

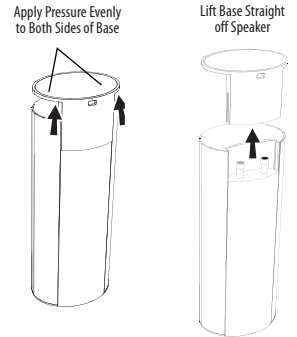

### Wall-Mounting: Satellite Speakers

**IMPORTANT:** Read the *Speaker Connections* section, on page 7, before wall-mounting the satellite speakers. You will need to insert the speaker wires through the wall mounts and connect the wires to the speakers during the process of installing the wall-mounts.

**NOTE:** If you are using your own speaker wire, it must be no thicker than the wire supplied with the speakers. Thicker wire will prevent the wall-mount bracket from sliding onto the speaker.

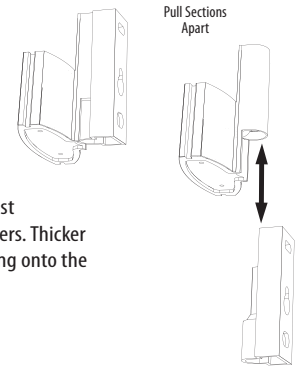

1. Decide on the location for the speaker (see *Speaker Placement*, opposite).
2. Remove the speaker's base as explained in *Shelf Placement*, above.
3. Disassemble the wall-mount bracket by sliding the two sections apart, as shown in the illustration.
4. Attach the wall portion of the wall-mount onto the wall using hardware that is appropriate for the wall's construction and materials. We recommend first anchoring the mount using its keyhole, then attaching it with another anchor through its top opening, as shown in the illustration. Note that the satellite speakers weigh 3.3 lb (1.5kg). Be sure to use hardware that can support this weight.

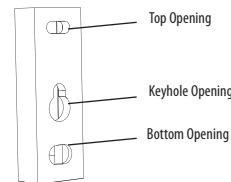

**NOTE:** If you're running the speaker wire through the wall you can bring it out directly behind the bracket location and insert it through the bottom opening in the wall portion of the wall-mount, as shown in the illustration. This will keep the wire completely hidden from view once the installation is complete.

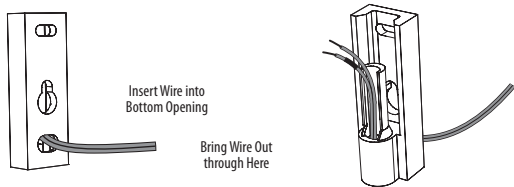

5. If you're not running the speaker wire through the wall, insert it through the wall portion of the wall-mount bracket as shown in the illustration.

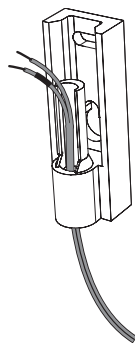

6. Pass the speaker wire through the speaker portion of the wall-mount as shown in the illustration.

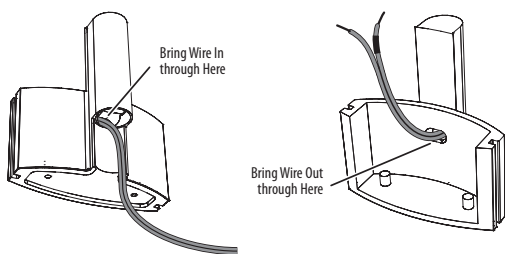

7. If you have not already removed the speaker's base, do so by pulling it straight off the speaker, as shown in the illustration. Applying even pressure to both sides of the base will allow it to slide off smoothly.

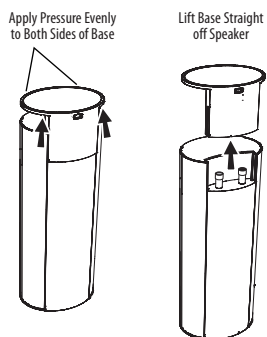

**CAUTION:** Before making speaker connections, be sure that your receiver or amplifier is turned OFF and preferably, its AC cord is unplugged from the AC outlet.

8. Connect the speaker wire to the speaker terminals as shown in the illustration:

- a) Press down on the top of the terminal to open the connection hole.
- b) Insert the wire's bare end all the way into the hole.
- c) Release the terminal to secure the wire.

Insert the conductor with the colored band into the speaker's red (+) terminal, and insert the other conductor into the speaker's black (-) terminal.

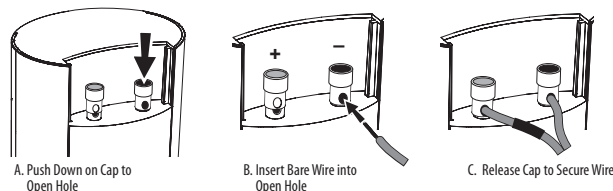

**IMPORTANT:** Make sure the (+) and (-) bare wires do not touch each other or the other terminal. Touching wires can cause a short circuit that can damage your receiver or amplifier.

9. Slide the speaker portion of wall-mount onto the speaker as shown in the illustration. Fit the grooves on the mount onto the rails in the speaker, and apply even pressure on both sides of the mount so it slides straight onto the speaker.

- Push the mount all the way onto the speaker until it snaps into place.
- Pull any slack speaker wire back through the mount as you slide the mount onto the speaker.

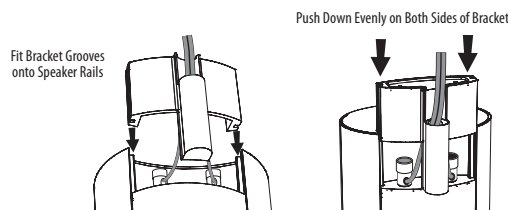

10. Slide the speaker onto the mount's wall section as shown in the illustration. Pull any slack speaker wire back through the mount's wall section.

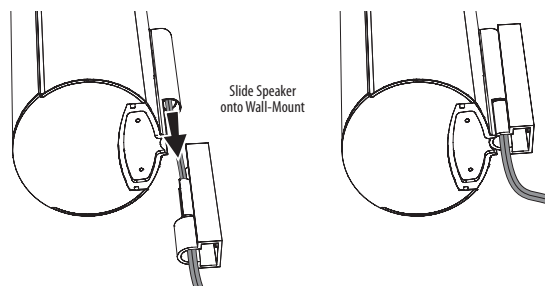

11. Fit the metal stop plate into the recess on the bottom of the mount with the pad facing the mount, and fasten it to the mount using two of the supplied screws. This will prevent the speaker from detaching from the bracket and will hold the speaker's position as you rotate it on the mount.

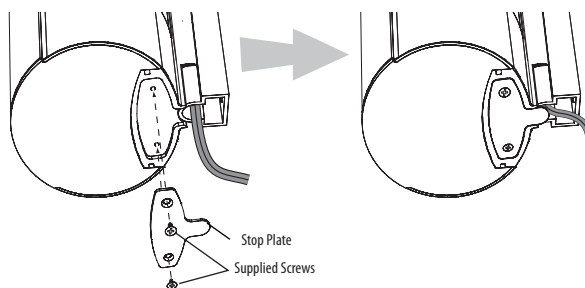

## Wall-Mounting: Center Speaker

1. Decide on the location for the speaker (see *Speaker Placement*, on page 5).
2. Attach the center speaker wall-mount bracket to the wall using hardware that is appropriate for the wall's construction and materials. Attach the anchors through the holes shown in the illustration.

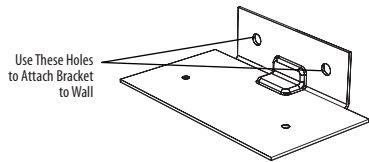

**NOTE:** The center speaker weighs 3.2 lb (1.45kg). Be sure to use hardware that can support this weight.

**CAUTION:** Before making speaker connections, be sure that your receiver or amplifier is turned OFF and preferably, its AC cord is unplugged from the AC power source.

3. Connect the speaker wire to the speaker terminals. Press down on the top of the terminal to open the connection hole, insert the wire's bare end all the way into the hole and release the terminal to secure the wire. Insert the conductor with the colored band into the speaker's *red* (+) terminal, and insert the other conductor into the speaker's *black* (-) terminal, as shown in the illustration.

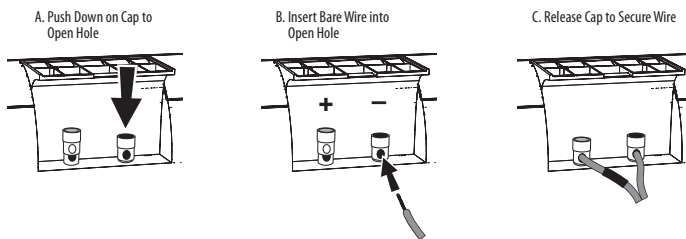

**IMPORTANT:** Make sure the (+) and (-) bare wires do not touch each other or the other terminal. Touching wires can cause a short circuit that can damage your receiver or amplifier.

4. Using two of the supplied screws, attach the center speaker to the wall-mount bracket, as shown in the illustration.

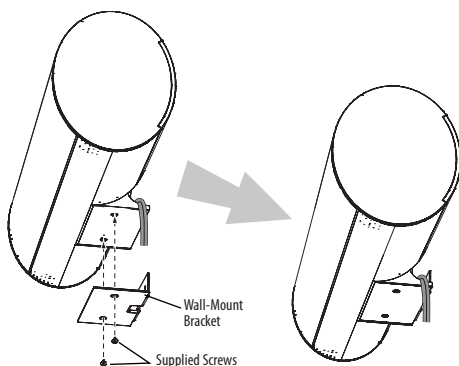

## Speaker Connections

**CAUTION:** Before making speaker connections, be sure that your receiver or amplifier is turned OFF and preferably, its AC cord is unplugged from the AC power outlet.

Speakers and receivers/amplifiers have corresponding (+) and (-) connection terminals. Most electronics manufacturers, including Harman Kardon, use *red* to denote the (+) terminal and *black* for the (-) terminal. Newer Harman Kardon receivers conform to the CEA standard and therefore use a color other than red to denote the (+) terminal for some speaker positions. See the table in *Color-Coding System*, on page 5.

Each speaker wire included with your system has colored bands at both ends of the (+) conductor, and the subwoofer cable has purple connectors that correspond to the color of the HKTS200SUB's LFE jack. This system helps ensure that the speaker in each location is connected to the correct receiver or amplifier terminals. In addition to the colored bands at each end, each speaker wire's (+) terminal has ribs molded into its insulation to help identify it.

It is very important to connect each speaker identically: (+) on the speaker to (+) on the receiver or amplifier, and (-) on the speaker to (-) on the receiver or amplifier. Miswiring one or more speakers results in thin sound, weak bass and a poor stereo image. With the advent of multichannel surround-sound systems, connecting all of the speakers in your system correctly is very important to achieving the proper ambience and directionality of the program material.

To connect the speaker wire to the terminals on the satellite and center speakers, press down on the top of the terminal to open the connection hole, insert the wire's bare end all the way into the hole and release the terminal to secure the wire. Insert the conductor with the colored band into the speaker's *red* (+) terminal, and insert the other conductor into the speaker's *black* (-) terminal, as shown in the illustration.

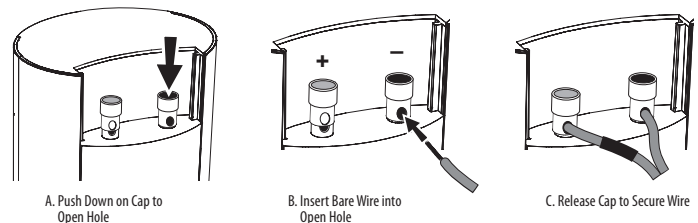

**IMPORTANT:** Make sure the (+) and (-) bare wires do not touch each other or the other terminal. Touching wires can cause a short circuit that can damage your receiver or amplifier.

## Connecting Satellite Speakers With Supplied Wall-Mount Brackets

Follow the instructions in *Wall-Mounting: Satellite Speakers*, on page 5, and *Wall-Mounting: Center Speaker*, opposite.

Connecting Satellite Speakers with Supplied Bases

1. Remove the speaker's base (see *Shelf Placement*, on page 5).
2. Pass the speaker wire through the opening in the speaker base.
3. Connect the speaker wire as described above.
4. Reattach the speaker's base as shown in the illustration.

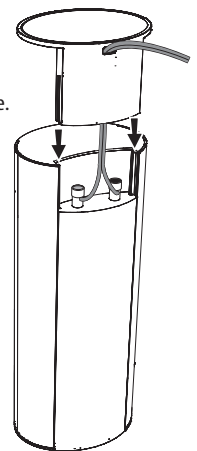

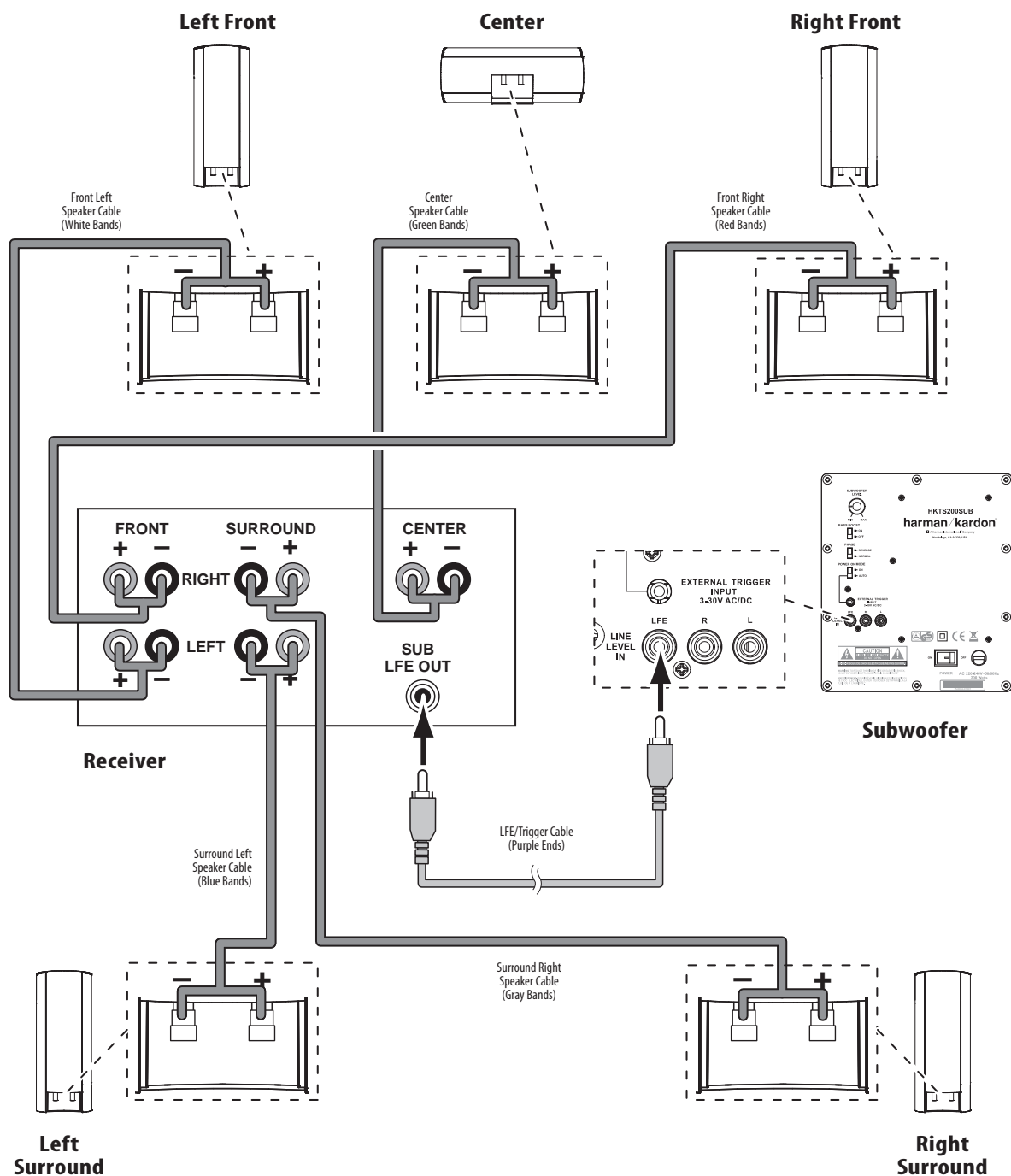

### Connecting the Subwoofer to a Receiver or Preamp/Processor With a Dedicated Subwoofer Output

Use this installation method for receivers and preamp/processors that have a dedicated subwoofer output with low-pass filtering (also called bass management). If the dedicated subwoofer output does not have low-pass filtering, follow the instructions in *Connecting the Subwoofer to a Receiver or Preamp/Processor With Line Outputs*, on page 9.

Use the LFE (purple) connector of the supplied combination LFE and trigger cable to connect the HKTS200SUB's Line-Level LFE In Jack ⑥ to the dedicated subwoofer output (or LFE output) of your receiver or preamp/processor.

Connect each satellite speaker and the center speaker to the corresponding speaker terminals on your receiver or amplifier.

In your receiver or preamp/processor's setup menu, configure it for *Subwoofer ON*, and set the front left, front right, center, and surround speakers to *Small*. After you have made and verified all connections, plug the HKTS200SUB's AC Power Cord ⑨ into an active AC outlet.



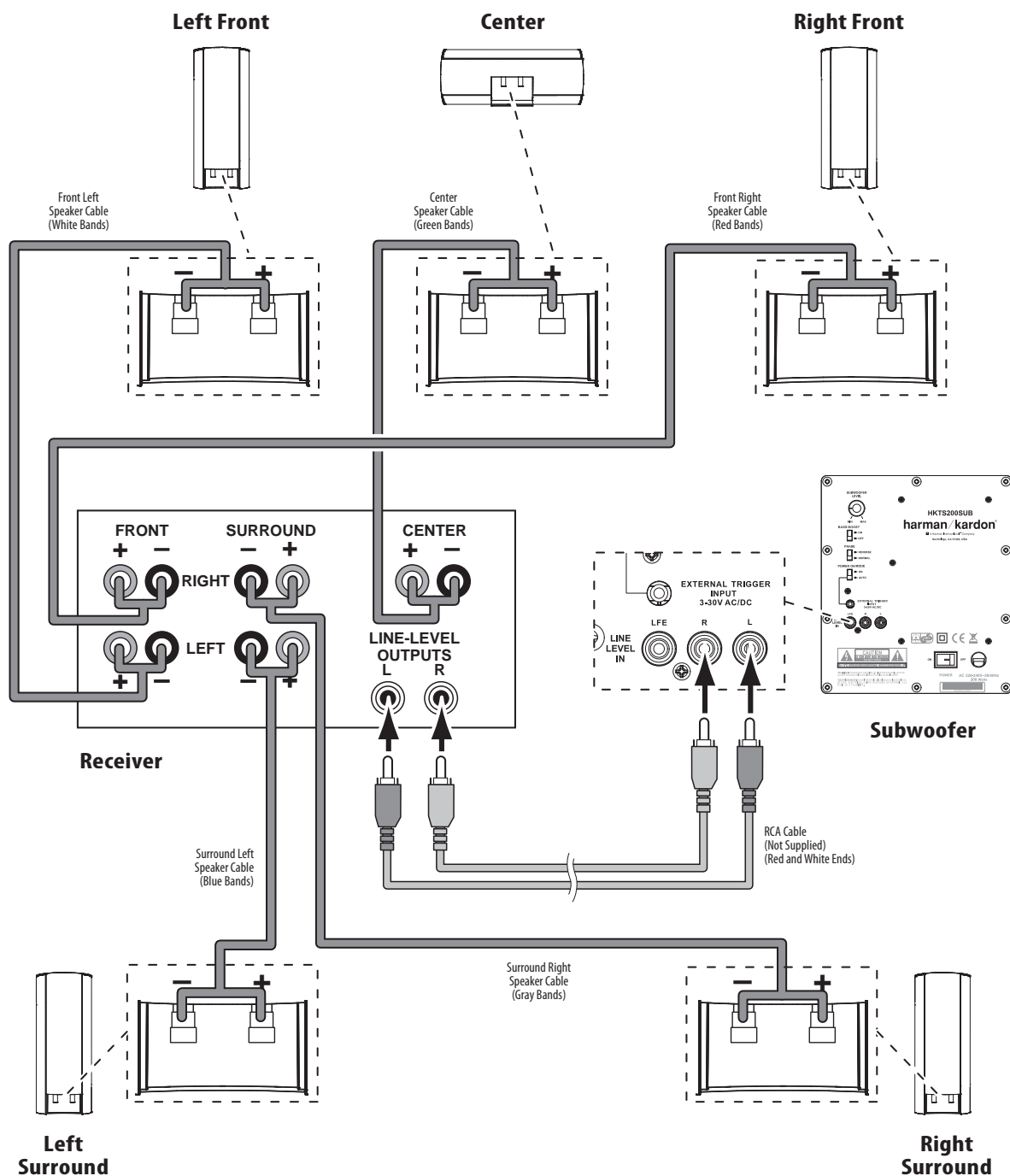

## Connecting the Subwoofer to a Receiver or Preamp/Processor With Line Outputs

Use this installation method for receivers and preamp/processors that do not have a dedicated subwoofer output, but do have preamp-level (volume-controlled) line outputs. If the receiver or preamp/processor has a dedicated subwoofer output with low-pass filtering, see *Connecting the Subwoofer to a Receiver or Preamp/Processor With a Dedicated Subwoofer Output*, on page 8.

If you're connecting to a receiver with left and right line outputs that are not connected to amplifier inputs, connect the LFE (purple) connector of the supplied combination LFE and trigger cable to one of those outputs and to either of the HKTS200SUB's **Line-Level L/R In Connectors** ⑦. Use a second RCA cable (not supplied) to connect the other receiver or preamp line output to the other of the HKTS200SUB's **Line-Level L/R In Connectors** ⑦.

If you're connecting to a receiver or preamp/processor with left and right line outputs that are connected to amplifier front left and right inputs, connect the single ends of Y-adapters (not supplied) to the receiver's or processor's left and right line outputs. Connect one of the Y-adapter's double ends to the HKTS200SUB's **Line-Level L/R In Connectors** ⑦, and connect the other double end to your amplifier's front left and right inputs.

Connect each satellite speaker and the center speaker to the corresponding speaker terminals on your receiver or amplifier.

In your receiver or preamp/processor's setup menu, configure it for *Subwoofer ON*, and set the front left, front right, center, and surround speakers to *Small*.

After you have made and verified all connections, plug the HKTS200SUB's **AC Power Cord** ⑨ into an active AC outlet.

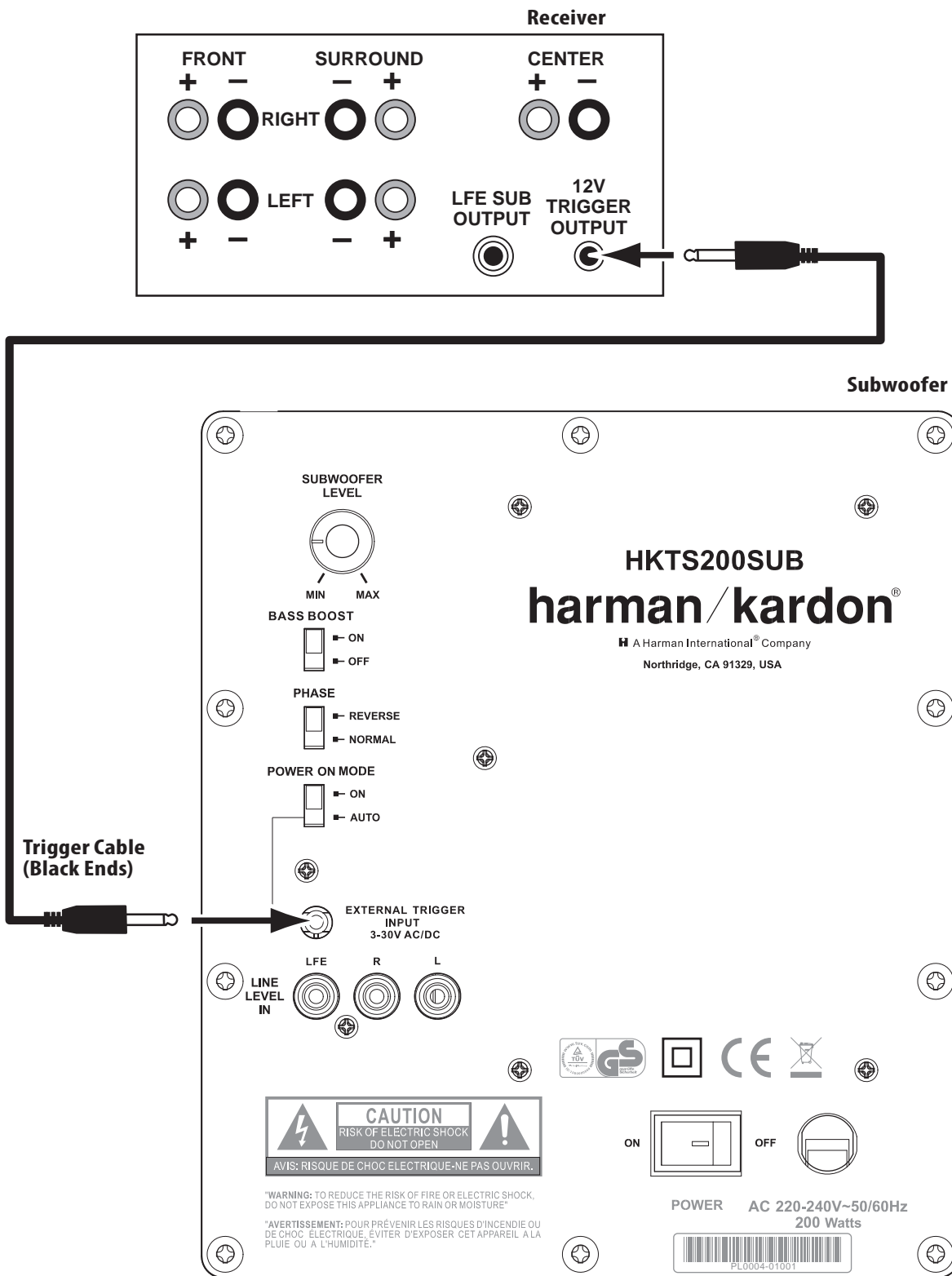

### Connecting to a Trigger Voltage Source

If your preamp/processor or another audio/video component has a trigger voltage connection that supplies between 3 and 30V (AC or DC), connect it to the HKTS200SUB's **External Trigger Input Connector** ⑤. If the component's trigger voltage connection has a 3.5mm mini jack you can use the supplied combination LFE/trigger cable to make the connection.

## Operation

### Turning the Subwoofer On and Off

Set the HKTS200SUB's Power Switch ③ to the **ON** position.

- If the **Power On Mode Switch ④** is set to **AUTO**, the HKTS200SUB will automatically turn itself on when it receives an audio signal, and it will go into standby mode when it has received no audio signal for 15 minutes. The HKTS200SUB's LED will illuminate white when the subwoofer is on, and will not be illuminated when the subwoofer is in standby.
- If the **Power On Mode Switch ④** is set to **ON**, the HKTS200SUB will remain on at all times. The HKTS200SUB's LED will illuminate white.
- If the **External Trigger Input Connector ⑤** is connected to a trigger voltage source, the HKTS200SUB will turn on whenever a trigger voltage is present, and will turn off after the trigger voltage ceases, regardless of the position of the **Power On Mode Switch ④**.

If you will be away from home for an extended period of time, or if you will not be using the subwoofer for an extended period, switch the **Power Switch ③** to the **OFF** Position.

### Subwoofer Adjustments: Volume

Use the **Subwoofer Level Control ①** to set the HKTS200SUB's volume. Turn the knob clockwise to increase the subwoofer's volume; turn the knob counterclockwise to decrease the subwoofer's volume.

### Subwoofer Adjustments: Phase

The **Phase Switch ②** determines whether the HKTS200SUB's piston-like action moves in and out in phase with the satellite speakers. If the subwoofer were to play out of phase with the satellite speakers, the sound waves produced by the subwoofer could be canceled out, reducing bass performance and sonic impact. This phenomenon depends in part on the relative placement of all the speakers in the room.

Although in most cases the **Phase Switch ②** should be left in the **NORMAL** position, there is no absolute correct setting for the **Phase Switch ②**. When the HKTS200SUB is properly in phase with the satellite speakers, the sound will be clearer and have maximum impact. This will make percussive sounds like drums, piano and plucked strings sound more lifelike. The best way to set the **Phase Switch ②** is to listen to music that you are familiar with and set the switch in the position that gives drums and other percussive sounds maximum impact.

### Subwoofer Adjustments: Bass Boost

When set to the **ON** position, the **Bass Boost Switch ②** enhances low-frequency performance, resulting in bass with more impact, which you may prefer while watching movies or listening to music. There is no harm in experimenting with this control – setting the switch to the **OFF** position will return normal low-frequency performance.

## Troubleshooting

### If there is no sound from *any* of the speakers:

- Check that the receiver/amplifier is on and a source is playing.
- Make sure that all wires and connections between the receiver/amplifier and the speakers are connected properly.
- Make sure none of the speaker wires is frayed, cut or punctured.
- Review the proper operation of your receiver/amplifier.

### If there is no sound coming from *one* speaker:

- Check that the balance control on your receiver/amplifier is not set all the way to one channel.
- Check your receiver/amplifier's speaker setup procedure to make sure that the speaker in question has been enabled and its volume level has not been turned all the way down.
- Make sure that all wires and connections between the receiver/amplifier and the speaker are connected properly.
- Make sure the speaker wires are not frayed, cut or punctured.

### If there is no sound coming from the *center* speaker:

- Check your receiver/amplifier's speaker setup procedure to make sure that the center speaker has been enabled and its volume level has not been turned all the way down.
- Make sure that all wires and connections between the receiver/amplifier and the center speaker are connected properly.
- Make sure the speaker wires are not frayed, cut or punctured.
- If your receiver is operating in Dolby® Pro Logic® mode, make sure that the center speaker is not set to Phantom.

### If there is no sound coming from the *surround* speakers:

- Check your receiver/amplifier's speaker setup procedure to make sure that the surround speakers have been enabled and their volume levels have not been turned all the way down.
- Make sure that all wires and connections between the receiver/amplifier and the surround speakers are connected properly.
- Make sure the speaker wires are not frayed, cut or punctured.
- Review proper operation of your receiver/processor and its surroundsound features.
- Make sure the movie or TV show you're watching has been recorded in a surroundsound mode. If it is not, check to see if your receiver/amplifier has a different surround-sound mode that you can use.
- Review the operation of your DVD player and the DVD jacket to make sure the DVD features the desired Dolby Digital or DTS® surround-sound mode, and that you have properly selected that mode using both the DVD player's menu and the disc's menu.

### If there is no sound coming from the *subwoofer*:

- Check that the subwoofer's **Power Cord ③** is plugged into a working AC outlet.
- Check that the subwoofer's **Power Switch ③** is in the **ON** position.
- Check that the **Subwoofer Level Control ①** is not turned all the way down (fully counterclockwise).
- Check the audio connection between your receiver/processor and the subwoofer.
- Check your receiver/amplifier's speaker setup procedure to make sure that the subwoofer has been enabled and its volume level has not been turned all the way down.

### If the system plays at low volumes but shuts off as volume is increased:

- Make sure that all wires and connections between the receiver/amplifier and the speakers are connected properly.
- Make sure none of the speaker wires is frayed, cut or punctured.
- If you're using more than one pair of main speakers, check to be sure that you're not operating the system below the receiver/amplifier's minimum impedance requirements.

# Specifications

## HKTS20 System

Frequency Response  
45Hz – 20kHz (-6dB)

### SAT-TS20 Satellites

Recommended Power  
10 ~ 80 watts

Impedance  
8 ohms nominal

Sensitivity  
83dB @ 2.83V/1 meter

Tweeter  
One 3/4" (19mm) dome, video-shielded

Midrange  
One 3" (75mm) driver, video-shielded

Dimensions – including stands (H x W x D)  
8-1/2" x 4-11/32" x 3-15/32"  
(216mm x 110mm x 88mm)

Weight  
2.1 lb (0.95kg)

## HKTS30 System

Frequency Response  
45Hz – 20kHz (-6dB)

### SAT-TS30 Satellites

Recommended Power  
10 ~ 120 watts

Impedance  
8 ohms nominal

Sensitivity  
86dB @ 2.83V/1 meter

Tweeter  
One 3/4" (19mm) dome, video-shielded

Midrange  
Dual 3" (75mm) drivers, video-shielded

Dimensions – including stands (H x W x D)  
11-25/32" x 4-11/32" x 3-15/32"  
(299mm x 110mm x 88mm)

Weight  
3.3 lb (1.5kg)

## Cen-TS20/30

Recommended Power  
10 ~ 120 watts

Impedance  
8 ohms nominal

Sensitivity  
86dB @ 2.83V/1 meter

Tweeter  
One 3/4" (19mm) dome, video-shielded

Midrange  
Dual 3" (75mm) drivers, video-shielded

Dimensions (H x W x D)  
4-11/32" x 10-11/32" x 3-15/32"  
(110mm x 272mm x 88mm)

Weight  
3.2 lb (1.45kg)

## HKTS200SUB Subwoofer

Input rating:  
AC 100–120V, 50/60 Hz, 200W or  
AC 220–240V, 50/60 Hz, 200W

Amplifier Power  
200 watts RMS

Bass  
8" woofer, sealed enclosure

External Trigger Input Voltage  
3 ~ 30 volts AC/DC

Dimensions (H x W x D)  
13-29/32" x 10-1/2" x 10-1/2"  
(353mm x 267mm x 267mm)

Gross Weight  
19.8 lb (9kg)

© 2009 Harman International Industries, Incorporated. All rights reserved.

Features, specifications and appearance are subject to change without notice.

Harman Kardon is a trademark of Harman International Industries, Incorporated, registered in the United States and/or other countries. Designed to Entertain is a trademark of Harman International Industries, Incorporated.

Dolby and Pro Logic are registered trademarks of Dolby Laboratories.

DTS is a registered trademark of Digital Theater Systems, Inc.

## Harman International

Harman Consumer Group, Inc.  
8500 Balboa Boulevard, Northridge, CA 91329 USA  
516.255.4545 (USA only)

[www.harmankardon.com](http://www.harmankardon.com)

Made in China

Part No. 444020-001, 444021-001



# HKTS 60BQ/230

Home theater speaker system

User Guide

- English.....
- Deutsch.....
- Suomi.....
- Français.....
- Italiano.....
- Español.....
- Svenska.....
- Русский.....
- Nederlands.....



**harman/kardon®**  
 Designed to Entertain.™

# Harman Kardon® HKTS 60

## Introduction

Thank you for purchasing the Harman Kardon® HKTS60 speaker system, with which you're about to begin many years of listening enjoyment. The HKTS60 has been custom designed to provide all the excitement and power of the cinema experience in your own living room.

While sophisticated electronics and state-of-the-art speaker components are hard at work within the HKTS60, hookup and operation are simple. Color-keyed cables and connections, and simple controls make the HKTS60 easy to use.

To obtain maximum enjoyment from your new home theater speaker system, we urge you to take a few minutes to read through this manual. This will help ensure that the connections you make to your receiver (or preamp/processor), amplifier and other devices are correct. In addition, a few minutes spent learning the functions of the various controls will enable you to take advantage of all the power and refinement the HKTS60 is able to deliver.

If you have any questions about this product, its installation or its operation, please contact your dealer, the best local source of information.

## Description and Features

The HKTS60 is a complete six-piece home theater speaker system that includes:

- An 8-inch, 200-watt powered subwoofer
- Four identical two-way video-shielded dual-driver satellite speakers for the left and right front, and left and right rear (surround) speaker positions
- A dedicated, voice-matched, video-shielded, dual-driver center speaker
- Removable bases and wall-mount brackets for the satellite speakers and a wall-mount bracket for the center speaker
- All of the cables you need to connect all of the speakers to your receiver or preamp/processor and amplifier.

The speaker cables all use a color-coding system to conform to the Consumer Electronics Association (CEA) standard. This color-coding system minimizes confusion when connecting the speakers, especially when you are connecting them to a Harman Kardon receiver.

The HKTS200SUB subwoofer is equipped with a special LFE input that simplifies connection to receivers and preamp/processors with dedicated subwoofer outputs that carry low-frequency signals. Other conveniences include a level control, a phase switch for fine-tuning bass response to suit your listening environment and taste, and an efficient switching system that senses the presence of an audio signal and automatically switches the subwoofer from standby mode to on.

Wall-mount brackets are included for the satellite and center speakers, and shelf stands are included for the satellite speakers. Optional HKFS3 floorstands are available separately from your Harman Kardon dealer. Harman Kardon invented the high-fidelity receiver fifty years ago. With state-of-the-art features and time-honored circuit designs, the HKTS60 is a perfect complement to a Harman Kardon receiver, or any home theater system.

## Included

Four satellite speakers for front left/right and surround left/right

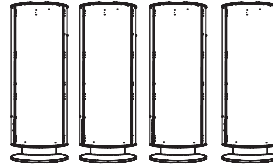

One center speaker



One powered subwoofer

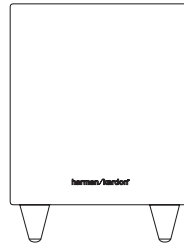

Four wall-mount brackets for satellite speakers

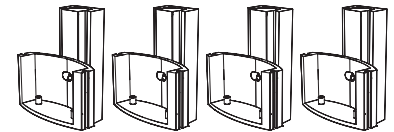

One wall-mount bracket for center speaker

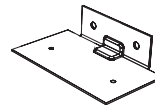

Four metal stop plates and screws (for satellite speaker wall-mount brackets)

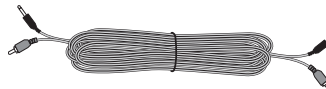
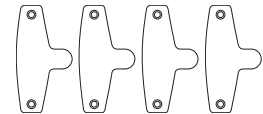

One combination LFE and trigger cable for connection to the subwoofer (LFE cable has purple connectors)



One 4-meter (13.1-foot) speaker cable for center speaker (green color bands)

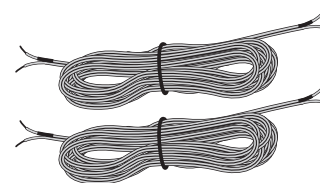

Two 5-meter (16.4-foot) speaker cables for front satellites (red and white color bands)

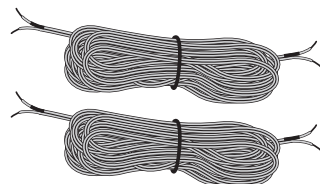

Two 10-meter (32.8-foot) speaker cables for rear satellites (gray and blue color bands)

## HKTS200SUB Rear-Panel Connections

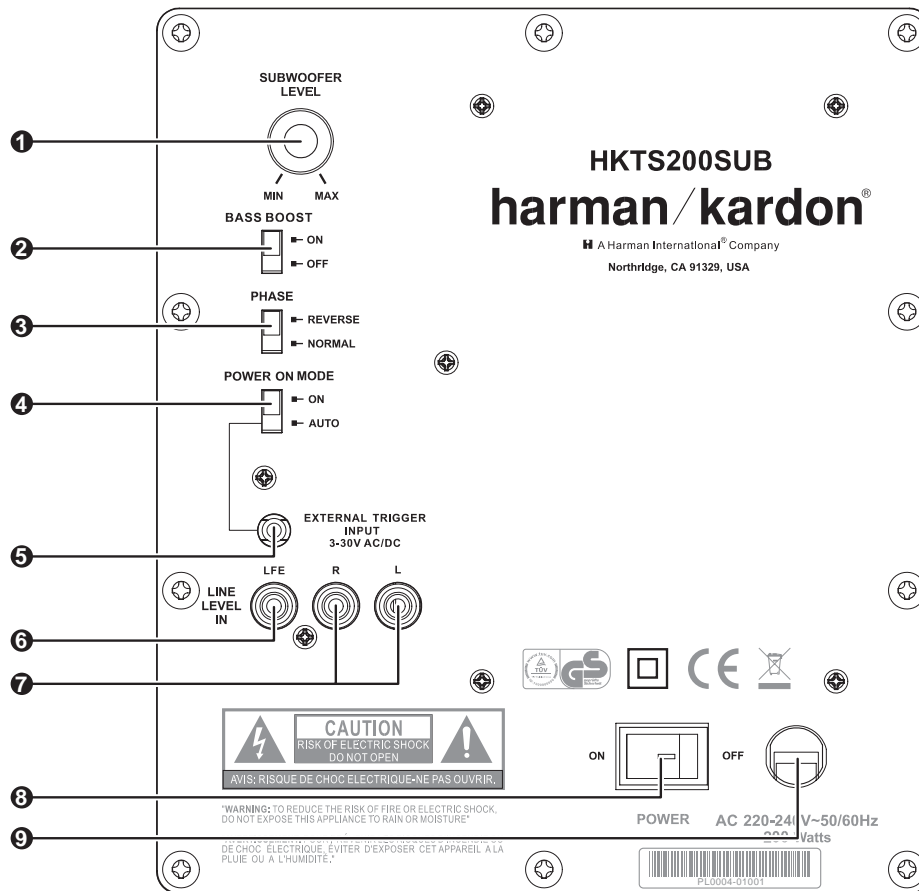

- 1 Subwoofer Level Control:** Use this control to adjust the HKTS200SUB's volume. Turn clockwise to increase the volume; turn counterclockwise to decrease the volume.
- 2 Bass Boost Switch:** Set this switch to **ON** to enhance the HKTS200SUB's low-frequency performance. Set this switch to **OFF** for normal low-frequency performance.
- 3 Phase Switch:** This determines whether the HKTS200SUB's piston-like action moves in and out in phase with the satellite speakers. If the subwoofer were to play out of phase with the satellite speakers, the sound waves produced by the subwoofer could be canceled out, reducing bass performance and sonic impact. This phenomenon depends in part on the relative placement of all the speakers in the room. In most cases the **Phase Switch** **3** should be left in the **NORMAL** position. However, it does no harm to experiment, and you can leave the **Phase Switch** **3** in the position that maximizes bass response and impact.
- 4 Power On Mode Switch:** When set in the **AUTO** position and when the **Power Switch** **8** is set to **ON**, the HKTS200SUB will automatically turn itself on when it receives an audio signal, and will enter the standby mode once no audio signal has been received for about 15 minutes. When this switch is set in the **ON** position, the HKTS200SUB will remain on whether or not it is receiving an audio signal.

An LED on the HKTS200SUB's top panel indicates whether the subwoofer is in the on or standby state:

  - When the LED is illuminated white, the HKTS200SUB is turned on.
  - When the LED is not illuminated, the HKTS200SUB is in standby mode.

When the **Master Power Switch** **8** is set to **OFF**, the LED will not be illuminated, no matter what setting the **Power On Mode Switch** **4** is in.
- 5 External Trigger Input:** Use the mini-plug of the supplied combination LFE and trigger cable to connect the **External Trigger Input** to the trigger output of another compatible component. Whenever a trigger signal between 3 and 30V (AC or DC) is detected, the HKTS200SUB's amplifier will turn on. The HKTS200SUB's amplifier will turn off after the trigger signal ceases. (This will occur even when the **Power On Mode Switch** **4** is in the **AUTO** position.)
- 6 Line-Level LFE In Connector:** Use the LFE (purple) connector of the supplied combination LFE and trigger cable to connect the **Line-Level LFE In** to the dedicated subwoofer output of a receiver or preamp/processor. This input bypasses the HKTS200SUB's internal crossover circuitry, so it should only be used with a subwoofer output that has been low-pass filtered. If your receiver or preamp/processor does not have a dedicated subwoofer output that is low-pass filtered you should use the HKTS200SUB's **Line-Level L/R In Connectors** **7** instead.
- 7 Line-Level L/R In Connectors:** Use these connectors if your receiver or preamp/processor does not have digital surround sound decoding or a subwoofer output that is low-pass filtered.

  - If your receiver or preamp/processor has a separate subwoofer output, use the LFE (purple) connector of the supplied combination LFE and trigger cable to connect it to either one of the HKTS200SUB's **Line-Level L/R In Connectors**.
  - If your receiver or preamp/processor does not have a separate subwoofer output, use two Y-adapters (not supplied). Connect an adapter's single end to the unit's preamp output for that channel. Connect one of the adapter's dual ends to the main amp input for that channel, and connect the adapter's other dual end to one of the HKTS200SUB's **Line-Level L/R In Connectors**. Repeat with the other Y-adapter, preamp channel, main amp input and HKTS200SUB **Line-Level L/R In Connector**.
- 8 Power Switch:** Set this switch in the **ON** position to turn the HKTS200SUB on. The subwoofer will then either be on or in standby mode, depending on the setting of the **Power On Mode Switch** **4**.
- 9 Power Cord (Non-Detachable):** After you have made and verified all subwoofer and speaker connections described in this manual, plug this cord into an active, *unswitched* electrical outlet for proper operation of the HKTS200SUB. **DO NOT** plug this cord into the accessory outlets found in some audio components.



# Speaker Placement

## Color-Coding System

The HKTS60 uses the channel color-coding system established by the CEA to make setting up your home theater speaker system as easy as possible. The HKTS60 system includes speaker wires with color bands on each end.

Speaker Position	Wire Color Band
Front Left	White
Front Right	Red
Center	Green
Surround Left	Blue
Surround Right	Gray
Subwoofer	Purple

### Placing the Front Speakers

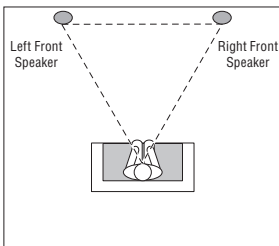

The front speakers should be placed the same distance from each other as they are from the listening position. They should be placed at about the same height from the floor as the listener's ears will be. They also can be angled toward the listener.

### Placing the Center Speaker

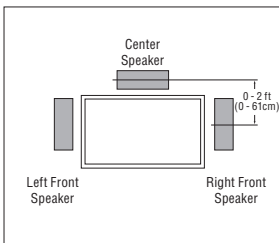

The center speaker should be placed slightly behind (farther away from the listener) the front left and right speakers. Its center should be no more than 2 feet (61cm) above or below the tweeters of the front left and right speakers. If you have a CRT television, it may be convenient to set the center speaker on top of the television set.

### Placing the Subwoofer

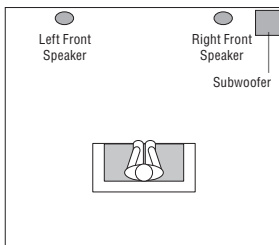

Since our ears do not hear directional sound at the low frequencies where the subwoofer operates, it will have good performance from just about any location in your room. However, the best bass reproduction is likely to be heard when the subwoofer is placed in a corner along the same wall as the front left and right speakers. You can experiment with subwoofer placement by temporarily placing it in the listening position and playing music with strong bass content. Move around to various locations in the room while the system is playing and listen until you find the location where the bass performance is best. Place the subwoofer in that location.

### Placing the Surround Speakers

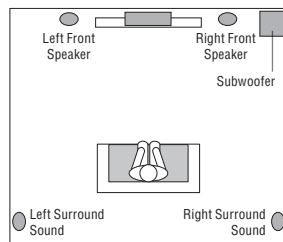
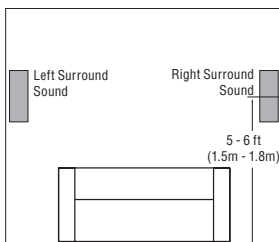

The two surround speakers should be placed slightly behind the listening position, facing each other and, ideally, should be 5–6 feet (1.5m–1.8m) from the floor. An alternate location would be on a wall behind the listening position, facing forward. The surround speakers should not call attention to themselves while they're playing. Experiment with their placement until you hear a diffuse, ambient sound accompanying the program material heard from the front left and right and center speakers.

## Mounting Options for Satellite and Center Speakers

### Shelf Placement

You can place the satellite and center speakers on shelves. The satellite speakers have built-in bases for shelf placement. You can also remove the bases if desired.

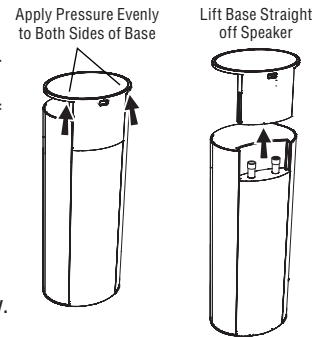

To remove a satellite speaker's base, pull it straight off the speaker, as shown in the illustration. Applying even pressure to both sides of the base will allow it to slide off smoothly.

### Wall-Mounting: Satellite Speakers

**IMPORTANT:** Read the *Speaker Connections* section, on page 7, before wall-mounting the satellite speakers. You will need to insert the speaker wires through the wall mounts and connect the wires to the speakers during the process of installing the wall-mounts.

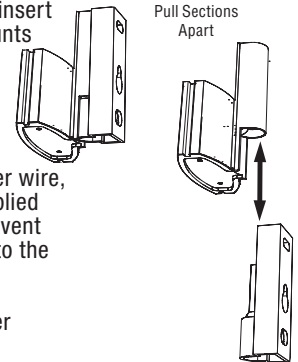

**NOTE:** If you are using your own speaker wire, it must be no thicker than the wire supplied with the speakers. Thicker wire will prevent the wall-mount bracket from sliding onto the speaker.

1. Decide on the location for the speaker (see *Speaker Placement*, opposite).
2. Remove the speaker's base as explained in *Shelf Placement*, above.
3. Disassemble the wall-mount bracket by sliding the two sections apart, as shown in the illustration.
4. Attach the wall portion of the wall-mount onto the wall using hardware that is appropriate for the wall's construction and materials. We recommend first anchoring the mount using its keyhole, then attaching it with another anchor through its top opening, as shown in the illustration. Note that the satellite speakers weigh 3.4 lb (1.55kg). Be sure to use hardware that can support this weight.

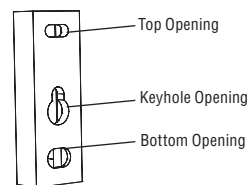



**NOTE:** If you're running the speaker wire through the wall you can bring it out directly behind the bracket location and insert it through the bottom opening in the wall portion of the wall-mount, as shown in the illustration. This will keep the wire completely hidden from view once the installation is complete.

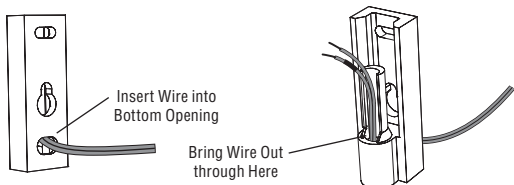

5. If you're not running the speaker wire through the wall, insert it through the wall portion of the wall-mount bracket as shown in the illustration.

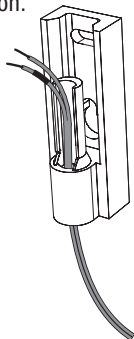

6. Pass the speaker wire through the speaker portion of the wall-mount as shown in the illustration.

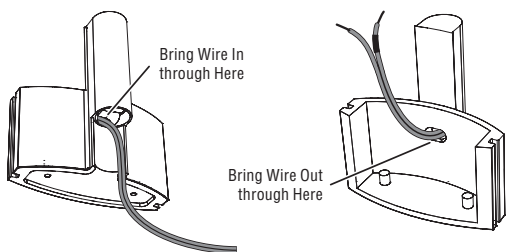

7. If you have not already removed the speaker's base, do so by pulling it straight off the speaker, as shown in the illustration. Applying even pressure to both sides of the base will allow it to slide off smoothly.

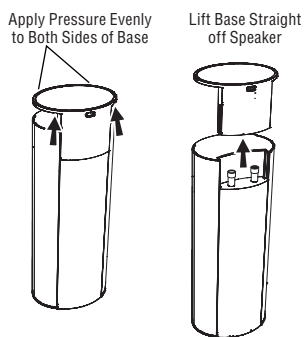

**CAUTION:** Before making speaker connections, be sure that your receiver or amplifier is turned OFF and preferably, its AC cord is unplugged from the AC outlet.

8. Connect the speaker wire to the speaker terminals as shown in the illustration:

- Press down on the top of the terminal to open the connection hole.
- Insert the wire's bare end all the way into the hole.
- Release the terminal to secure the wire.

Insert the conductor with the colored band into the speaker's *red (+)* terminal, and insert the other conductor into the speaker's *black (-)* terminal.

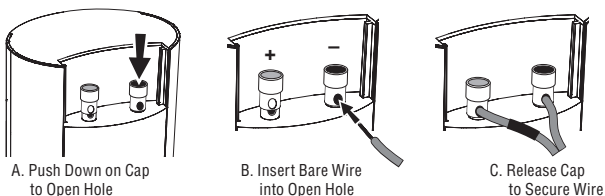

**IMPORTANT:** Make sure the (+) and (-) bare wires do not touch each other or the other terminal. Touching wires can cause a short circuit that can damage your receiver or amplifier.

9. Slide the speaker portion of wall-mount onto the speaker as shown in the illustration. Fit the grooves on the mount onto the rails in the speaker, and apply even pressure on both sides of the mount so it slides straight onto the speaker.

- Push the mount all the way onto the speaker until it snaps into place.
- Pull any slack speaker wire back through the mount as you slide the mount onto the speaker.

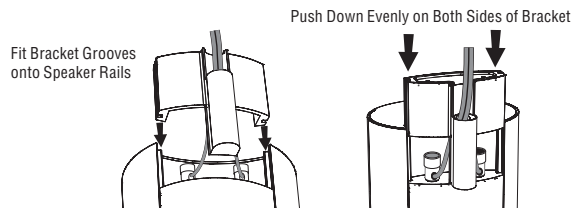

10. Slide the speaker onto the mount's wall section as shown in the illustration. Pull any slack speaker wire back through the mount's wall section.

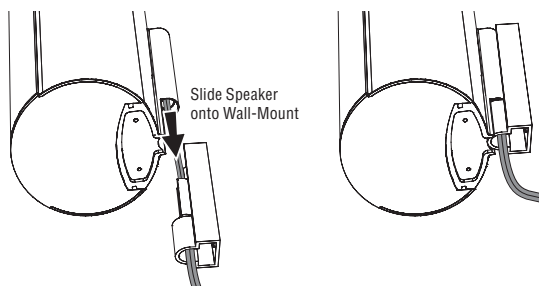

11. Fit the metal stop plate into the recess on the bottom of the mount with the pad facing the mount, and fasten it to the mount using two of the supplied screws. This will prevent the speaker from detaching from the bracket and will hold the speaker's position as you rotate it on the mount.

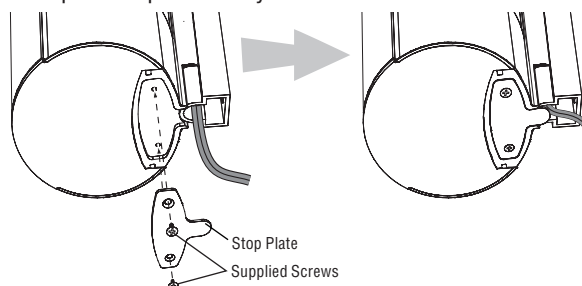

### Wall-Mounting: Center Speaker

1. Decide on the location for the speaker (see *Speaker Placement*, on page 5).
2. Attach the center speaker wall-mount bracket to the wall using hardware that is appropriate for the wall's construction and materials. Attach the anchors through the holes shown in the illustration.

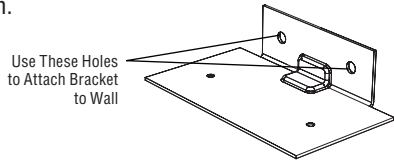

**NOTE:** The center speaker weighs 3.3 lb (1.5kg). Be sure to use hardware that can support this weight.

**CAUTION:** Before making speaker connections, be sure that your receiver or amplifier is turned OFF and preferably, its AC cord is unplugged from the AC power source.

3. Connect the speaker wire to the speaker terminals. Press down on the top of the terminal to open the connection hole, insert the wire's bare end all the way into the hole and release the terminal to secure the wire. Insert the conductor with the colored band into the speaker's *red* (+) terminal, and insert the other conductor into the speaker's *black* (-) terminal, as shown in the illustration.

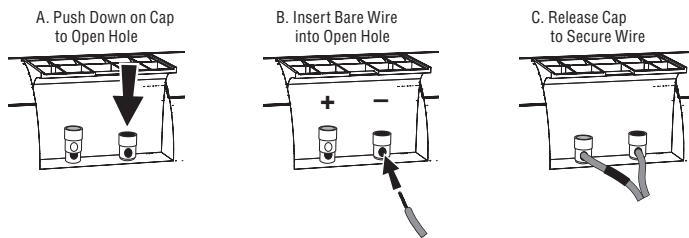

**Important:** Make sure the (+) and (-) bare wires do not touch each other or the other terminal. Touching wires can cause a short circuit that can damage your receiver or amplifier.

4. Using two of the supplied screws, attach the center speaker to the wall-mount bracket, as shown in the illustration.

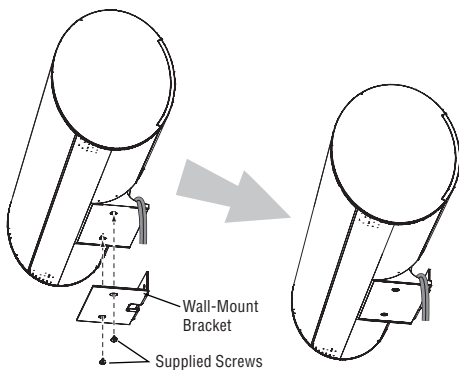

### Speaker Connections

**CAUTION:** Before making speaker connections, be sure that your receiver or amplifier is turned OFF and preferably, its AC cord is unplugged from the AC power outlet.

Speakers and receivers/amplifiers have corresponding (+) and (-) connection terminals. Most electronics manufacturers, including Harman Kardon, use *red* to denote the (+) terminal and *black* for the (-) terminal. Newer Harman Kardon receivers conform to the CEA standard and therefore use a color other than red to denote the (+) terminal for some speaker positions. See the table in *Color-Coding System*, on page 5.

Each speaker wire included with your system has colored bands at both ends of the (+) conductor, and the subwoofer cable has purple connectors that correspond to the color of the HKTS200SUB's LFE jack. This system helps ensure that the speaker in each location is connected to the correct receiver or amplifier terminals. In addition to the colored bands at each end, each speaker wire's (+) terminal has ribs molded into its insulation to help identify it.

It is very important to connect each speaker identically: (+) on the speaker to (+) on the receiver or amplifier, and (-) on the speaker to (-) on the receiver or amplifier. Miswiring one or more speakers results in thin sound, weak bass and a poor stereo image. With the advent of multichannel surround-sound systems, connecting all of the speakers in your system correctly is very important to achieving the proper ambience and directionality of the program material.

To connect the speaker wire to the terminals on the satellite and center speakers, press down on the top of the terminal to open the connection hole, insert the wire's bare end all the way into the hole and release the terminal to secure the wire. Insert the conductor with the colored band into the speaker's *red* (+) terminal, and insert the other conductor into the speaker's *black* (-) terminal, as shown in the illustration.

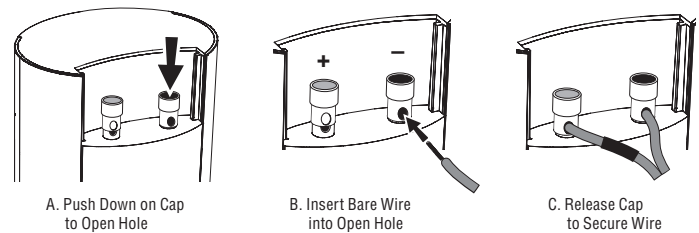

**IMPORTANT:** Make sure the (+) and (-) bare wires do not touch each other or the other terminal. Touching wires can cause a short circuit that can damage your receiver or amplifier.

### Connecting Satellite Speakers With Supplied Wall-Mount Brackets

Follow the instructions in *Wall-Mounting: Satellite Speakers*, on page 5, and *Wall-Mounting: Center Speaker*, opposite.

Connecting Satellite Speakers with Supplied Bases

1. Remove the speaker's base (see *Shelf Placement*, on page 5).
2. Pass the speaker wire through the opening in the speaker base.
3. Connect the speaker wire as described above.
4. Reattach the speaker's base as shown in the illustration.

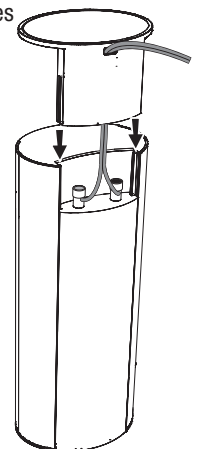

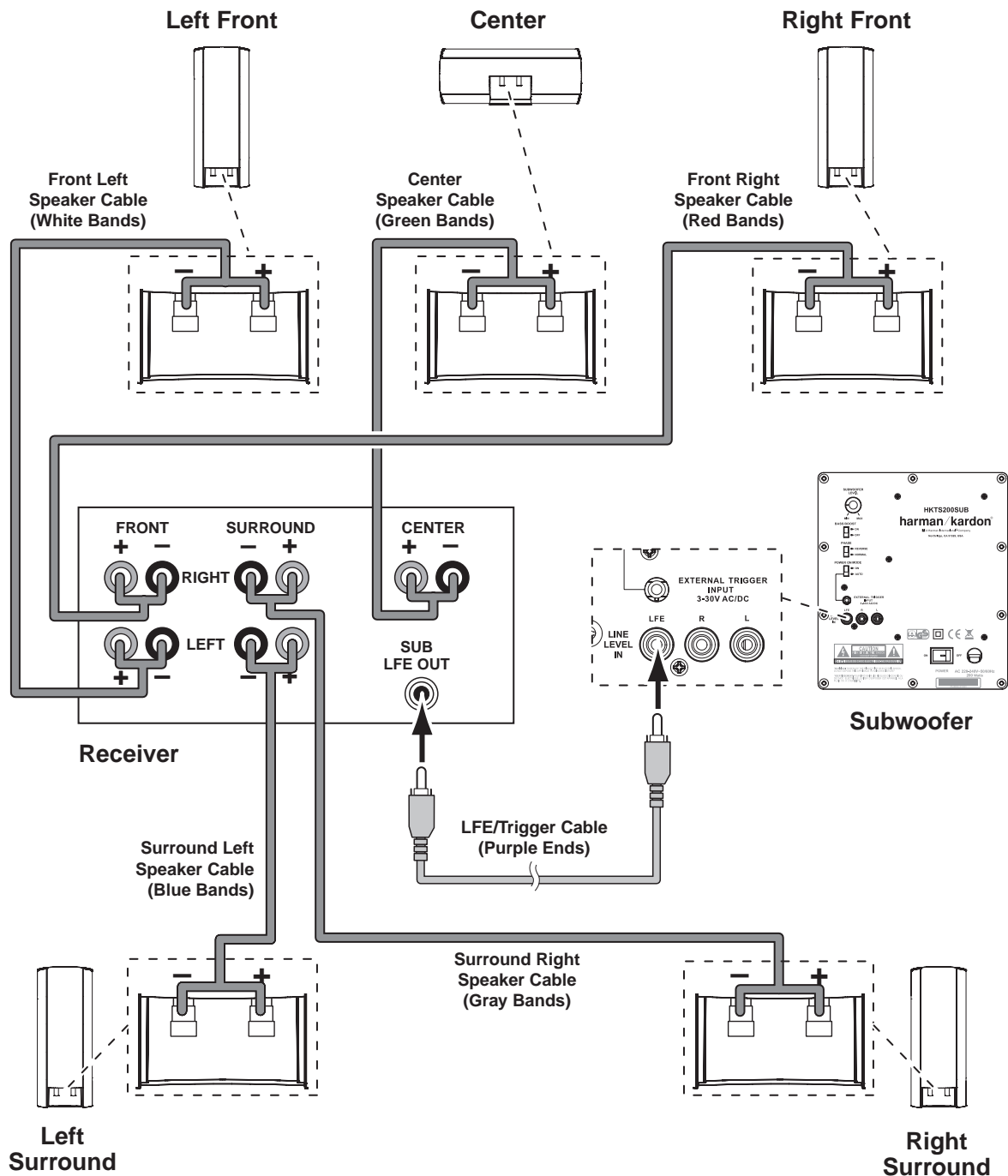

### Connecting the Subwoofer to a Receiver or Preamp/Processor With a Dedicated Subwoofer Output

Use this installation method for receivers and preamp/processors that have a dedicated subwoofer output with low-pass filtering (also called bass management). If the dedicated subwoofer output does not have low-pass filtering, follow the instructions in *Connecting the Subwoofer to a Receiver or Preamp/Processor With Line Outputs*, on page 9.

Use the LFE (purple) connector of the supplied combination LFE and trigger cable to connect the HKTS200SUB's **Line-Level LFE In Jack** to the dedicated subwoofer output (or LFE output) of your receiver or preamp/processor.

Connect each satellite speaker and the center speaker to the corresponding speaker terminals on your receiver or amplifier.

In your receiver or preamp/processor's setup menu, configure it for *Subwoofer ON*, and set the front left, front right, center, and surround speakers to *Small*. After you have made and verified all connections, plug the HKTS200SUB's **AC Power Cord** into an active AC outlet.

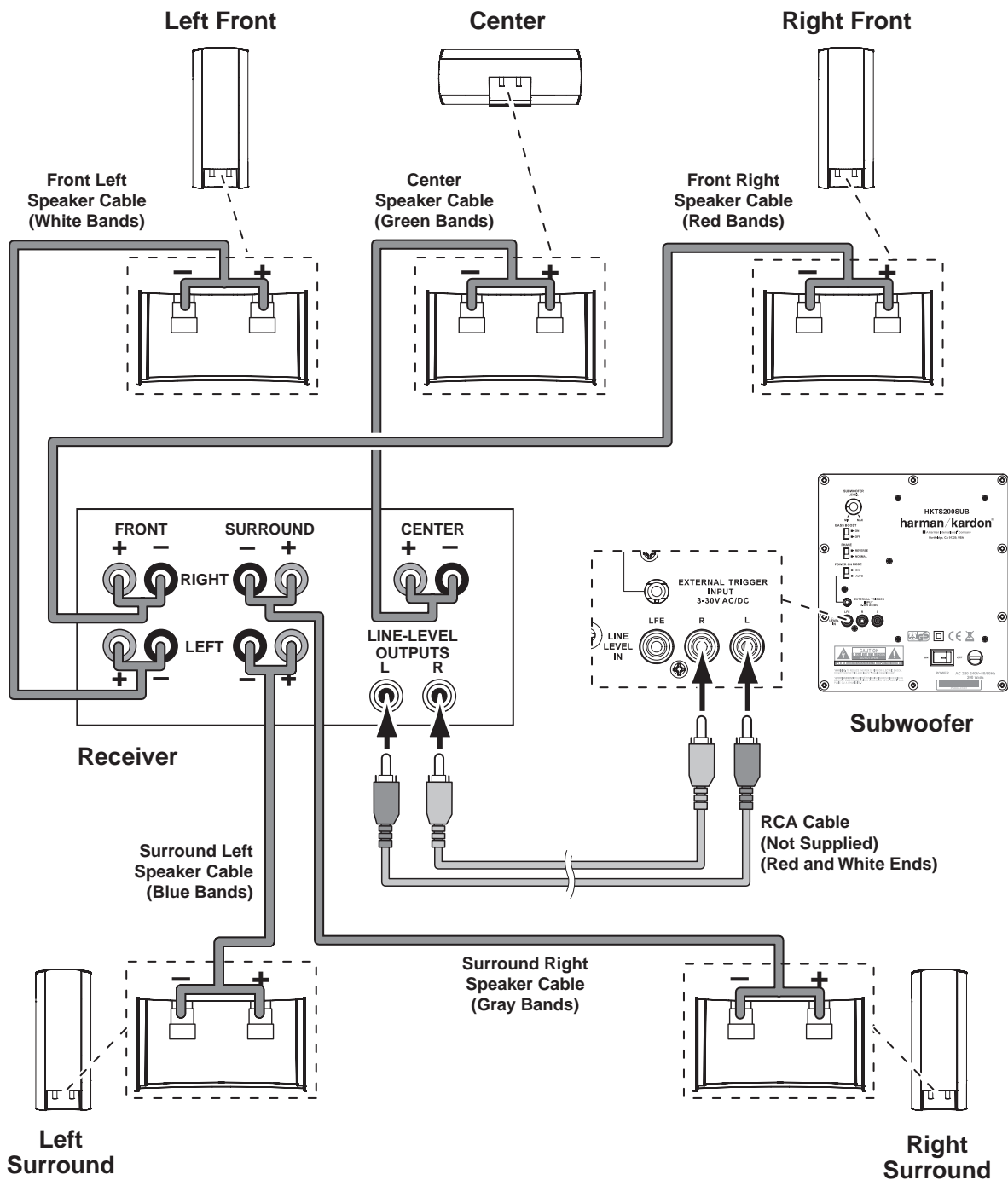

### Connecting the Subwoofer to a Receiver or Preamp/Processor With Line Outputs

Use this installation method for receivers and preamp/processors that do not have a dedicated subwoofer output, but do have preamp-level (volume-controlled) line outputs. If the receiver or preamp/processor has a dedicated subwoofer output with low-pass filtering, see *Connecting the Subwoofer to a Receiver or Preamp/Processor With a Dedicated Subwoofer Output*, on page 8.

If you're connecting to a receiver with left and right line outputs that are not connected to amplifier inputs, connect the LFE (purple) connector of the supplied combination LFE and trigger cable to one of those outputs and to either of the HKTS200SUB's **Line-Level L/R In Connectors** ⑦. Use a second RCA cable (not supplied) to connect the other receiver or preamp line output to the other of the HKTS200SUB's **Line-Level L/R In Connectors** ⑦.

If you're connecting to a receiver or preamp/processor with left and right line outputs that are connected to amplifier front left and right

inputs, connect the single ends of Y-adapters (not supplied) to the receiver's or processor's left and right line outputs. Connect one of the Y-adapter's double ends to the HKTS200SUB's **Line-Level L/R In Connectors** ⑦, and connect the other double end to your amplifier's front left and right inputs.

Connect each satellite speaker and the center speaker to the corresponding speaker terminals on your receiver or amplifier.

In your receiver or preamp/processor's setup menu, configure it for *Subwoofer ON*, and set the front left, front right, center, and surround speakers to *Small*.

After you have made and verified all connections, plug the HKTS200SUB's AC Power Cord ⑨ into an active AC outlet.



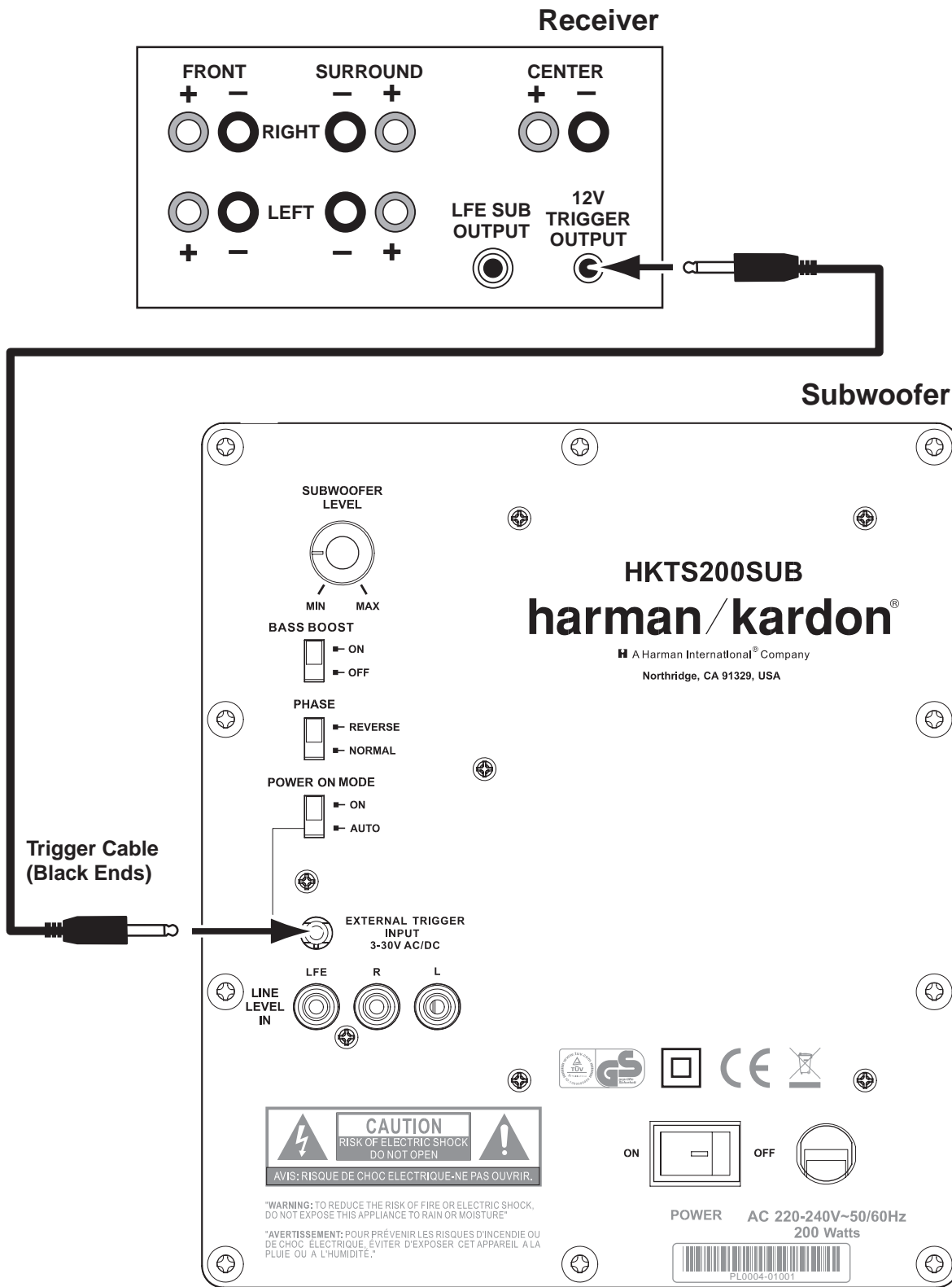

**Connecting to a Trigger Voltage Source**

If your preamp/processor or another audio/video component has a trigger voltage connection that supplies between 3 and 30V (AC or DC), connect it to the HKTS200SUB's **External Trigger Input Connector 6**. If the component's trigger voltage connection has a 3.5mm mini jack you can use the supplied combination LFE/trigger cable to make the connection.

## Operation

### Turning the Subwoofer On and Off

Set the HKTS200SUB's **Power Switch** ③ to the **ON** position.

- If the **Power On Mode Switch** ④ is set to **AUTO**, the HKTS200SUB will automatically turn itself on when it receives an audio signal, and it will go into standby mode when it has received no audio signal for 15 minutes. The HKTS200 SUB's LED will illuminate white when the subwoofer is on, and will not be illuminated when the subwoofer is in standby.

- If the **Power On Mode Switch** ④ is set to **ON**, the HKTS200SUB will remain on at all times. The HKTS200 SUB's LED will illuminate white.

- If the **External Trigger Input Connector** ⑤ is connected to a trigger voltage source, the HKTS200SUB will turn on whenever a trigger voltage is present, and will turn off after the trigger voltage ceases, regardless of the position of the **Power On Mode Switch** ④.

If you will be away from home for an extended period of time, or if you will not be using the subwoofer for an extended period, switch the **Power Switch** ③ to the **OFF** Position.

### Subwoofer Adjustments: Volume

Use the **Subwoofer Level Control** ① to set the HKTS200SUB's volume. Turn the knob clockwise to increase the subwoofer's volume; turn the knob counterclockwise to decrease the subwoofer's volume.

### Subwoofer Adjustments: Phase

The **Phase Switch** ③ determines whether the HKTS200SUB's piston-like action moves in and out in phase with the satellite speakers. If the subwoofer were to play out of phase with the satellite speakers, the sound waves produced by the subwoofer could be canceled out, reducing bass performance and sonic impact. This phenomenon depends in part on the relative placement of all the speakers in the room.

Although in most cases the **Phase Switch** ③ should be left in the **NORMAL** position, there is no absolute correct setting for the **Phase Switch** ③. When the HKTS200SUB is properly in phase with the satellite speakers, the sound will be clearer and have maximum impact. This will make percussive sounds like drums, piano and plucked strings sound more lifelike. The best way to set the **Phase Switch** ③ is to listen to music that you are familiar with and set the switch in the position that gives drums and other percussive sounds maximum impact.

### Subwoofer Adjustments: Bass Boost

When set to the **ON** position, the **Bass Boost Switch** ② enhances low-frequency performance, resulting in bass with more impact, which you may prefer while watching movies or listening to music. There is no harm in experimenting with this control – setting the switch to the **OFF** position will return normal low-frequency performance.

## Troubleshooting

### If there is no sound from *any* of the speakers:

- Check that the receiver/amplifier is on and a source is playing.
- Make sure that all wires and connections between the receiver/amplifier and the speakers are connected properly.
- Make sure none of the speaker wires is frayed, cut or punctured.
- Review the proper operation of your receiver/amplifier.

### If there is no sound coming from *one* speaker:

- Check that the balance control on your receiver/amplifier is not set all the way to one channel.
- Check your receiver/amplifier's speaker setup procedure to make sure that the speaker in question has been enabled and its volume level has not been turned all the way down.
- Make sure that all wires and connections between the receiver/amplifier and the speaker are connected properly.
- Make sure the speaker wires are not frayed, cut or punctured.

### If there is no sound coming from the *center* speaker:

- Check your receiver/amplifier's speaker setup procedure to make sure that the center speaker has been enabled and its volume level has not been turned all the way down.
- Make sure that all wires and connections between the receiver/amplifier and the center speaker are connected properly.
- Make sure the speaker wires are not frayed, cut or punctured.
- If your receiver is operating in Dolby® Pro Logic® mode, make sure that the center speaker is not set to Phantom.

### If there is no sound coming from the *surround* speakers:

- Check your receiver/amplifier's speaker setup procedure to make sure that the surround speakers have been enabled and their volume levels have not been turned all the way down.
- Make sure that all wires and connections between the receiver/amplifier and the surround speakers are connected properly.
- Make sure the speaker wires are not frayed, cut or punctured.
- Review proper operation of your receiver/processor and its surround-sound features.
- Make sure the movie or TV show you're watching has been recorded in a surround-sound mode. If it is not, check to see if your receiver/amplifier has a different surround-sound mode that you can use.
- Review the operation of your DVD player and the DVD jacket to make sure the DVD features the desired Dolby Digital or DTS® surround-sound mode, and that you have properly selected that mode using both the DVD player's menu and the disc's menu.

### If there is no sound coming from the *subwoofer*:

- Check that the subwoofer's **Power Cord** ⑥ is plugged into a working AC outlet.
- Check that the subwoofer's **Power Switch** ③ is in the **ON** position.
- Check that the **Subwoofer Level Control** ① is not turned all the way down (fully counterclockwise).
- Check the audio connection between your receiver/processor and the subwoofer.
- Check your receiver/amplifier's speaker setup procedure to make sure that the subwoofer has been enabled and its volume level has not been turned all the way down.

### If the system plays at low volumes but shuts off as volume is increased:

- Make sure that all wires and connections between the receiver/amplifier and the speakers are connected properly.
- Make sure none of the speaker wires is frayed, cut or punctured.
- If you're using more than one pair of main speakers, check to be sure that you're not operating the system below the receiver/amplifier's minimum impedance requirements.

## Specifications

### HKTS60 System

Frequency Response  
45Hz – 20kHz (-6dB)

### SAT-TS60 Satellites

Recommended Power  
20 ~ 150 watts

Impedance  
8 ohms nominal

Sensitivity  
83dB @ 2.83V/1 meter

Tweeter  
One 1" (25mm) CMMD Lite dome,  
video-shielded

Midrange  
Dual 3" (75mm) flat-diaphragm drivers,  
video-shielded

Dimensions – including stands (H x W x D)  
11-25/32" x 4-11/32" x 3-15/32"  
(299mm x 110mm x 88mm)

Weight  
3.4 lb (1.55kg)

### CEN-TS60

Recommended Power  
20 ~ 150 watts

Impedance  
8 ohms nominal

Sensitivity  
83dB @ 2.83V/1 meter

Tweeter  
One 1" (25mm) CMMD Lite dome,  
video-shielded

Midrange  
Dual 3" (75mm) flat-diaphragm  
drivers, video-shielded

Dimensions (H x W x D)  
4-11/32" x 10-11/32" x 3-15/32"  
(110mm x 272mm x 88mm)

Weight  
3.3 lb (1.5kg)

### HKTS200SUB Subwoofer

Input rating:  
AC 100–120V, 50/60 Hz, 200W or  
AC 220–240V, 50/60 Hz, 200W

Amplifier Power  
200 watts RMS

Bass  
8" woofer, sealed enclosure

External Trigger Input Voltage  
3 ~ 30 volts AC/DC

Dimensions (H x W x D)  
13-29/32" x 10-1/2" x 10-1/2"  
(353mm x 267mm x 267mm)

Gross Weight  
19.8 lb (9kg)

## **H** Harman International

Harman Consumer Group, Inc.  
8500 Balboa Boulevard, Northridge, CA 91329 USA  
516.255.4545 (USA only)

[www.harmankardon.com](http://www.harmankardon.com)

Made in P.R.C.

© 2009 Harman International Industries, Incorporated. All rights reserved.

Features, specifications and appearance are subject to change without notice.

Harman Kardon is a trademark of Harman International Industries, Incorporated, registered in the United States and/or other countries. Designed to Entertain is a trademark of Harman International Industries, Incorporated.

Dolby and Pro Logic are registered trademarks of Dolby Laboratories.

DTS is a registered trademark of Digital Theater Systems, Inc.

Part # 444024-001

# HKTS 60BQ/230

Home Theater Speaker System

Owner's Manual

ENGLISH



**harman/kardon**  
by HARMAN

# HKTS 60BQ/230

## Introduction, Description and Features, Included Items

### Introduction

Thank you for purchasing the harman kardon HKTS 60BQ speaker system, with which you're about to begin many years of listening enjoyment. The HKTS 60BQ has been custom designed to provide all the excitement and power of the cinema experience in your own living room.

While sophisticated electronics and state-of-the-art speaker components are hard at work within the HKTS 60BQ, hookup and operation are simple. Color-keyed cables and connections, and simple controls make the HKTS 60BQ easy to use.

To obtain maximum enjoyment from your new home theater speaker system, we urge you to take a few minutes to read through this manual. This will help ensure that the connections you make to your receiver (or preamp/processor), amplifier and other devices are correct. In addition, a few minutes spent learning the functions of the various controls will enable you to take advantage of all the power and refinement the HKTS 60BQ is able to deliver.

If you have any questions about this product, its installation or its operation, please contact your dealer. They are your best local source of information.

### Description and Features

The HKTS 60BQ is a complete six-piece home theater speaker system that includes:

- A 200-watt powered subwoofer with an 8-inch (200mm) low-frequency transducer
- Four identical two-way video-shielded dual-driver satellite speakers for the left and right front, and left and right rear (surround) speaker positions
- A dedicated, voice-matched, video-shielded, dual-driver center speaker
- Removable bases and wall-mount brackets for the satellite speakers and a wall-mount bracket for the center speaker
- All of the cables you need to connect all of the speakers to your receiver or preamp/processor and amplifier.

The speaker cables all use a color-coding system to conform to the Consumer Electronics Association (CEA®) standard. This color-coding system minimizes confusion when connecting the speakers, especially when the HKTS 60BQ system is used with a harman kardon receiver.

We have equipped the HKTS 210SUB subwoofer with a special input (labeled LFE) that simplifies connection to receivers and preamp/processors with dedicated subwoofer outputs that carry low-frequency signals. Other conveniences include a level control, a phase switch for fine-tuning bass response to suit your listening environment and taste, and an efficient switching system that senses the presence of an audio signal and automatically switches the subwoofer from standby mode to on.

We have included wall-mount brackets for the satellite and centre speakers and shelf stands for the satellite speakers. Optional HTFS 3 floor stands are available separately from your harman kardon dealer.

harman kardon invented the high-fidelity receiver fifty years ago. With state-of-the-art features and time-honored circuit designs, the HKTS 60BQ is a perfect complement to a harman kardon receiver, or any home theater system.

### Included Items

Four satellite speakers for front left/right and surround left/right

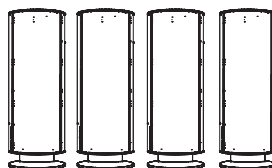

One center speaker



One powered subwoofer

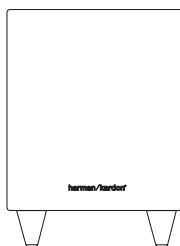

Four wall-mount brackets for satellite speakers

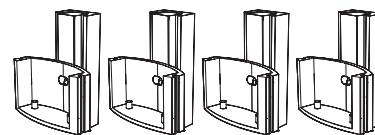

One wall-mount bracket for center speaker

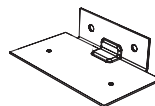

Four metal stop plates and screws (for satellite speaker wall-mount brackets)

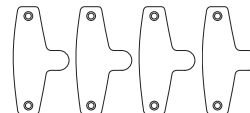

One combination LFE and trigger cable for connection to the subwoofer (LFE cable has purple connectors)

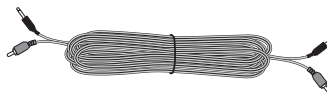

One 4-meter (13.1-foot) speaker cable for center speaker (green color bands)



Two 5-meter (16.4-foot) speaker cables for front satellites (red and white color bands)

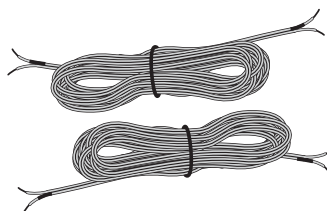

Two 10-meter (32.8-foot) speaker cables for rear satellites (gray and blue color bands)

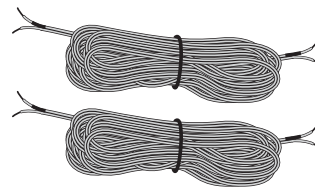



## HKTS 60BQ/230

## HKTS 210SUB Rear-Panel Connections, Color-Coding System

## HKTS 210SUB Rear-Panel Connections

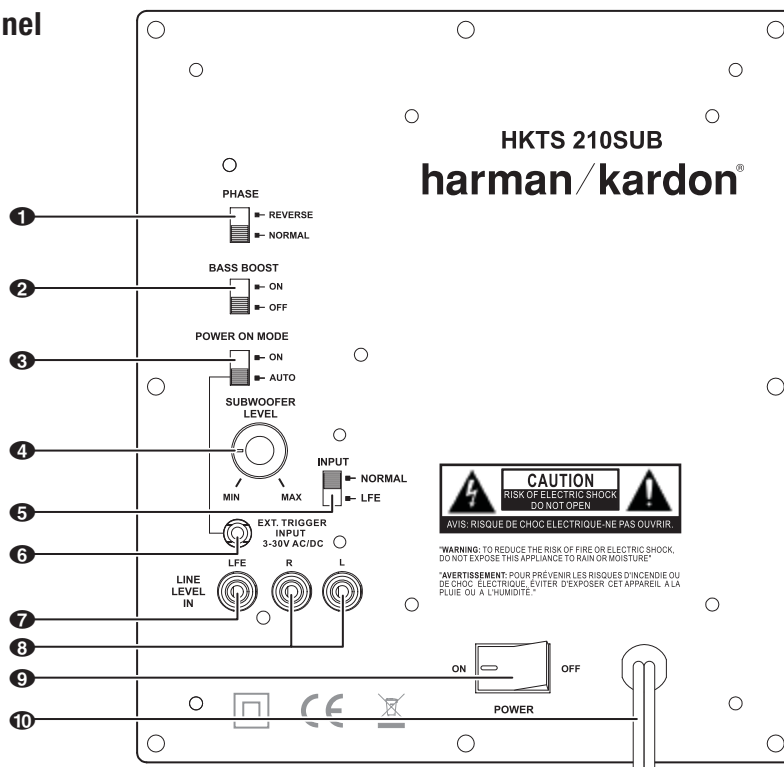

- 1 Phase switch:** The Phase switch **1** determines whether the HKTS 210SUB's piston-like action moves in and out in phase with the satellite speakers. If the subwoofer were to play out of phase with the satellite speakers, the sound waves produced by the subwoofer could be canceled out, reducing bass performance and sonic impact. This phenomenon depends in part on the relative placement of all the speakers in the room. In most cases the Phase switch **1** should be left in the NORMAL position. However, it does no harm to experiment, and you can leave the Phase switch **1** in the position that maximizes bass response and impact.
- 2 Bass Boost switch:** Set this switch to ON to enhance the HKTS 210SUB's low-frequency performance. Set this switch to OFF for normal low-frequency performance.
- 3 Power On Mode switch:** If this switch is set in the AUTO position and the Power switch **9** is set to ON, the HKTS 210SUB will automatically turn itself on when it receives an audio signal and will enter the standby mode once no audio signal has been received for about 15 minutes. When this switch is set in the ON position, the HKTS 210SUB will remain on whether or not it is receiving an audio signal. An LED on the HKTS 210SUB's top panel indicates whether the subwoofer is in the on or standby state:
  - When the LED glows white, the HKTS 210SUB is turned on.
  - When the LED is not illuminated, the HKTS 210SUB is in standby mode.
 When the Power switch **9** is set to OFF, the LED will not be illuminated, no matter what setting the Power On Mode switch **3** is in.
- 4 Subwoofer Level control:** Use this control to adjust the HKTS 210SUB's volume. Turn clockwise to increase the volume; turn counterclockwise to decrease the volume.
- 5 Input Mode switch:** When this switch is in the "Normal" setting, the input signal from the Line-Level L/R In connectors **8** is active. When this switch is in the "LFE" setting, the input signal from the Line-Level LFE In connector **7** is active.
- 6 External Trigger input:** Use the mini-plug of the supplied combination LFE and trigger cable to connect the External Trigger input to the trigger output of another compatible component. Whenever a trigger signal between 3V and 30V (AC or DC) is detected by the HKTS 210SUB, its amplifier will turn on. The HKTS 210SUB's amplifier will turn off after the trigger signal ceases. (This will occur even when the Power On Mode switch **3** is in the AUTO position.)
- 7 Line-Level LFE In connector:** The signal from this connector bypasses the subwoofer's internal low-pass crossover. When you're connecting the subwoofer to the dedicated subwoofer output of a receiver/processor that has its own low-pass crossover network, use the Line-Level LFE In connector **7** and set the subwoofer's Input Mode switch **5** in the "LFE" position.
- 8 Line-Level L/R In connectors:** The signals from these connectors pass through the subwoofer's internal low-pass crossover. When you're connecting the subwoofer to the preamp or subwoofer outputs of a receiver/processor that does not have its own low-pass crossover network, use both Line-Level L/R In connectors **8** and set the Input Mode switch **5** in the "Normal" position. If your receiver/processor has only one subwoofer output, you can use either the L or R connector.
- 9 Power switch:** Set this switch in the ON position to turn the HKTS 210SUB on. The subwoofer will then either be on or in standby mode, depending on the setting of the Power On Mode switch **3**.
- 10 Power cord (non-detachable):** After you have made and verified all subwoofer and speaker connections described in this manual, plug this cord into an active, unswitched electrical outlet for proper operation of the HKTS 210SUB. DO NOT plug this cord into the accessory outlets found in some audio components.

## Color-Coding System

The HKTS 60BQ use the channel color-coding system established by the CEA to make setting up your home theater speaker system as easy as possible. The HKTS 60BQ systems include speaker wires with color bands on each end.

Speaker Position	Wire Color Band
Front Left	White
Front Right	Red
Center	Green
Surround Left	Blue
Surround Right	Gray
Subwoofer	Purple

# HKTS 60BQ/230

## Speaker Placement, Mounting Options

### Speaker Placement

#### Placing the Front Speakers

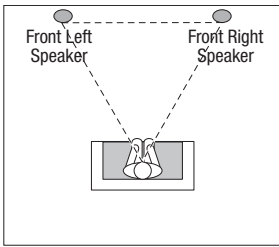

The front speakers should be placed the same distance from each other as they are from the listening position. They should be placed at about the same height from the floor as the listener's ears will be. They also can be angled toward the listener.

#### Placing the Center Speaker

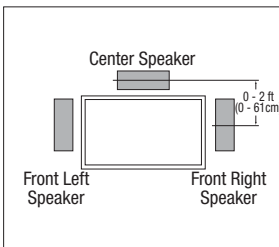

The center speaker should be placed slightly behind (farther away from the listener) the front left and right speakers. Its center should be no more than 2 feet (61cm) above or below the tweeters of the front left and right speakers. If you have a CRT television, it may be convenient to set the center speaker on top of the television set.

#### Placing the Subwoofer

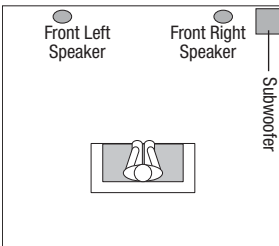

Since our ears do not hear directional sound at the low frequencies where the subwoofer operates, it will have good performance from just about any location in your room. However, the best bass reproduction is likely to be heard when the subwoofer is placed in a corner along the same wall as the front left and right speakers. You can experiment with subwoofer placement by temporarily placing it in the listening position and playing music with strong bass content. Move around to various locations in the room while the system is playing and listen until you find the location where the bass performance is best. Place the subwoofer in that location.

#### Placing the Surround Speakers

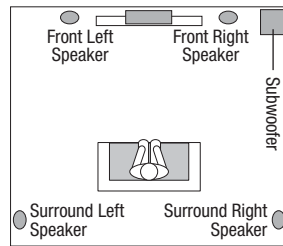
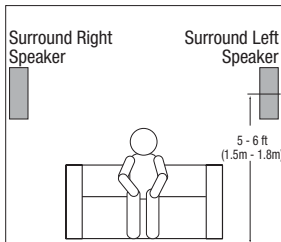

The two surround speakers should be placed slightly behind the listening position, facing each other and, ideally, should be 5-6 feet (1.5m-1.8m) from the floor. An alternate location would be on a wall behind the listening position, facing forward. The surround speakers should not call attention to themselves while they're playing. Experiment with their placement until you hear a diffuse, ambient sound accompanying the program material heard from the front left and right and center speakers.

### Mounting Options for Satellite and Centre Speakers

#### Shelf Placement

You can place the satellite and centre speakers on shelves. The satellite speakers have built-in bases for shelf placement. You can also remove the bases.

To remove a satellite speaker's base, pull it straight off the speaker, as shown in the illustration. Applying even pressure to both sides of the base will allow it to slide off smoothly.

Apply Pressure Evenly to Both Sides of Base



Lift Base Straight off Speaker

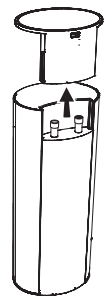

#### Wall-Mounting: Satellite Speakers

**IMPORTANT:** Read the *Speaker Connections* section, on page 8, before wall-mounting the satellite speakers. You will need to insert the speaker wires through the wall-mount brackets and connect the wires to the speakers during the process of installing the brackets.

**NOTE:** If you are using your own speaker wire, it must be no thicker than the wire supplied with the speakers. Thicker wire will prevent the bracket from sliding onto the speaker.

1. Decide on the location for the speaker.
2. Remove the speaker's base as explained in Shelf Placement, above.
3. Disassemble the wall-mount bracket by sliding the two sections apart, as shown in the illustration.
4. Attach the wall portion of the wall-mount bracket onto the wall using hardware that is appropriate for the wall's construction and materials. We recommend first anchoring the bracket using its keyhole, then attaching it with another anchor through its top opening, as shown in the illustration. Note that the satellite speakers weigh 1.55kg (3.4 lb). Be sure to use hardware that can support this weight.

Pull Sections Apart

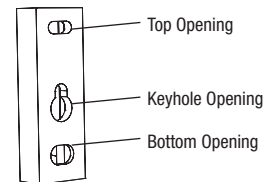
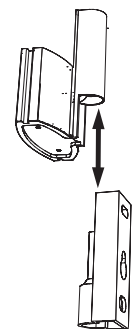
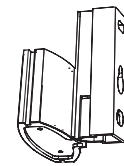

# HKTS 60BQ/230

## Mounting Options

**NOTE:** If you're running the speaker wire through the wall, you can bring it out directly behind the bracket location and insert it through the bottom opening in the wall portion of the bracket, as shown in the illustration. Running the wire in this way will keep the wire completely hidden from view once the installation is complete.

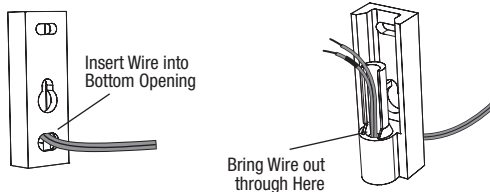

5. If you're not running the speaker wire through the wall, insert it through the wall portion of the bracket, as shown in the illustration.



6. Pass the speaker wire through the speaker portion of the wall-mount bracket, as shown in the illustration.

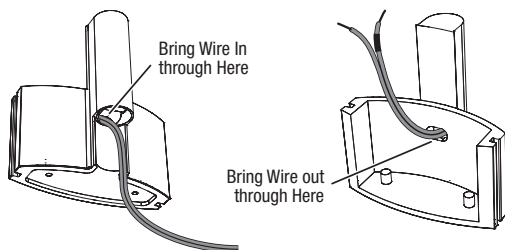

7. If you have not already removed the speaker's base, do so by pulling it straight off the speaker, as shown in the illustration. Applying even pressure to both sides of the base will allow it to slide off smoothly.

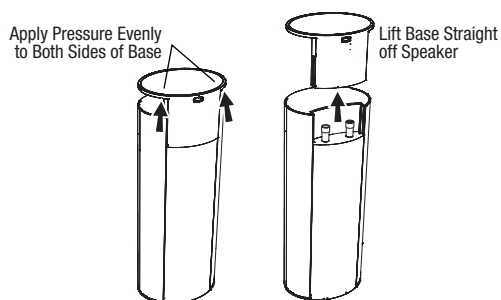

**CAUTION:** Before making speaker connections, be sure that your receiver or amplifier is turned OFF and its AC cord is unplugged from the AC outlet.

8. Connect the speaker wire to the speaker terminals as shown in the illustration:
- Press down on the top of the terminal to open the connection hole.
  - Insert the wire's bare end all the way into the hole.
  - Release the terminal to secure the wire.

Insert the conductor with the coloured band into the speaker's red (+) terminal, and insert the other conductor into the speaker's black (-) terminal.

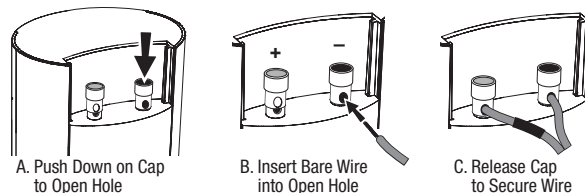

**IMPORTANT:** Make sure the (+) and (-) bare wires do not touch each other or the other terminal. Touching wires can cause a short circuit that can damage your receiver or amplifier.

9. Slide the speaker portion of the wall-mount bracket onto the speaker as shown in the illustration. Fit the grooves on the bracket onto the rails in the speaker, and apply even pressure on both sides of the bracket so it slides straight onto the speaker.
- Push the bracket all the way onto the speaker until it snaps into place.
  - Pull any slack speaker wire back through the bracket as you slide the bracket onto the speaker.

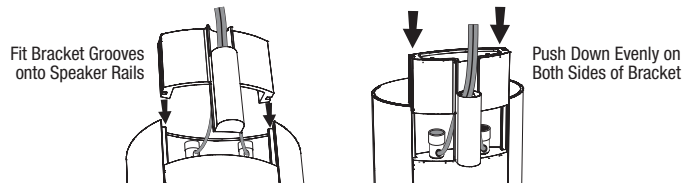

10. Slide the speaker onto the bracket's wall section, as shown in the illustration. Pull any slack speaker wire back through the bracket's wall section.

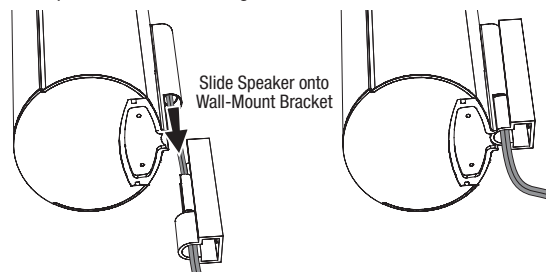

11. Fit the metal stop plate into the recess on the bottom of the bracket with the pad facing the bracket, and fasten it to the bracket using two of the supplied screws. Fastening it will prevent the speaker from detaching from the bracket and will hold the speaker's position as you rotate it.

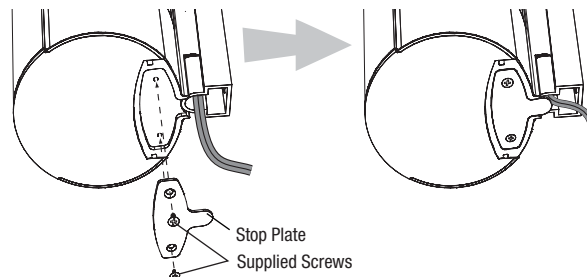

# HKTS 60BQ/230

## Mounting Options, Speaker Connections

### Wall-Mounting: Centre Speaker

1. Decide on the location for the speaker.
2. Attach the centre speaker wall-mount bracket to the wall using hardware that is appropriate for the wall's construction and materials. Attach the anchors through the holes shown in the illustration.

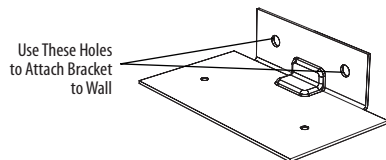

**NOTE:** The centre speaker weighs 1.5kg (3.3 lb). Be sure to use hardware that can support this weight.

**CAUTION:** Before making speaker connections, be sure that your receiver or amplifier is turned OFF and its AC cord is unplugged from the AC power source.

3. Connect the speaker wire to the speaker terminals. Press down on the top of the terminal to open the connection hole, insert the wire's bare end all the way into the hole and release the terminal to secure the wire. Insert the conductor with the coloured band into the speaker's red (+) terminal, and insert the other conductor into the speaker's black (-) terminal, as shown in the illustration.

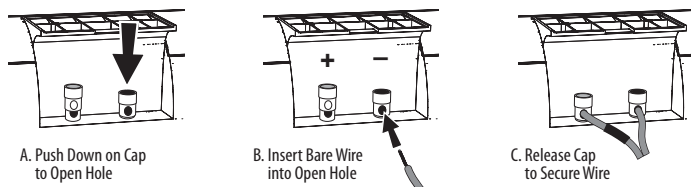

**IMPORTANT:** Make sure the (+) and (-) bare wires do not touch each other or the other terminal. Touching wires can cause a short circuit that can damage your receiver or amplifier.

4. Using two of the supplied screws, attach the centre speaker to the bracket, as shown in the illustration.

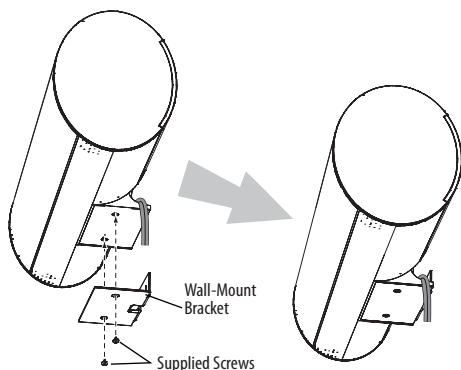

### Speaker Connections

**CAUTION:** Before making speaker connections, be sure that your receiver or amplifier is turned OFF and its AC cord is unplugged from the AC power outlet.

Speakers and receivers/amplifiers have corresponding (+) and (-) connection terminals. Most electronics makers, including harman kardon engineers, use red to denote the (+) terminal and black for the (-) terminal. Newer harman kardon receivers conform to the CEA standard and therefore use a colour other than red to denote the (+) terminal for some speaker positions. See the table in *Colour-Coding System*, on page 5.

Each speaker wire included with your system has coloured bands at both ends of the (+) conductor, and the subwoofer cable has purple connectors that correspond to the colour of the HKTS 210SUB's LFE jack. This system helps ensure that the speaker in each location is connected to the correct receiver or amplifier terminals. In addition to the coloured bands at each end, each speaker wire's (+) terminal has ribs moulded into its insulation to help you identify it.

It is very important to connect each speaker identically: (+) on the speaker to (+) on the receiver or amplifier, and (-) on the speaker to (-) on the receiver or amplifier. Miswiring one or more speakers results in thin sound, weak bass and a poor stereo image. With the advent of multichannel surround-sound systems, connecting all of the speakers in your system correctly is very important to achieving the proper ambience and directionality of the program material.

To connect the speaker wire to the terminals on the satellite and centre speakers, press down on the top of the terminal to open the connection hole, insert the wire's bare end all the way into the hole, and release the terminal to secure the wire. Insert the conductor with the coloured band into the speaker's red (+) terminal, and insert the other conductor into the speaker's black (-) terminal, as shown in the illustration.

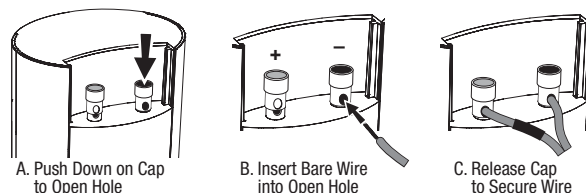

**IMPORTANT:** Make sure the (+) and (-) bare wires do not touch each other or the other terminal. Touching wires can cause a short circuit that can damage your receiver or amplifier.

### Connecting Satellite Speakers With Supplied Wall-Mount Brackets

Follow the instructions in *Wall-Mounting: Satellite Speakers*, on page 6, and *Wall-Mounting: Centre Speaker*, opposite.

### Connecting Satellite Speakers with Supplied Bases

1. Remove the speaker's base (see *Shelf Placement*, on page 6).
2. Pass the speaker wire through the opening in the speaker's base.
3. Connect the speaker wire as described above.
4. Reattach the speaker's base, as shown in the illustration.

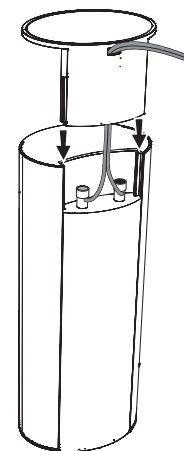

## HKTS 60BQ/230

## Speaker Connections

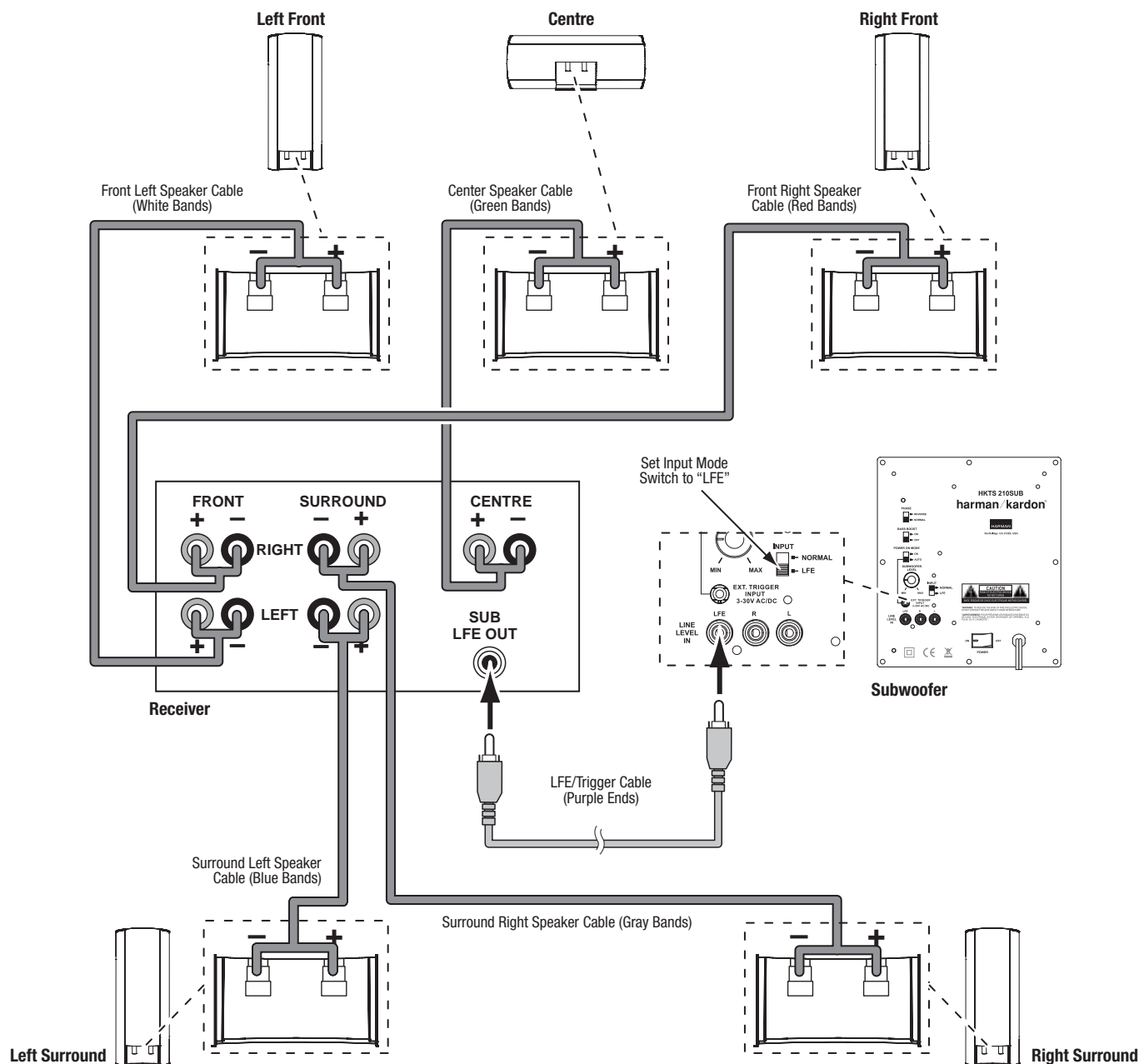

### Connecting the Subwoofer to a Receiver or Preamp/Processor with a Dedicated Subwoofer Output

Use this installation method for receivers and preamp/processors that have a dedicated subwoofer output with low-pass filtering (also called bass management). If the dedicated subwoofer output does not have low-pass filtering, follow the instructions in Connecting the Subwoofer to a Receiver or Preamp/Processor *With Line Outputs*, on page 10.

Use the LFE (purple) connector of the supplied combination LFE and trigger cable to connect the HKTS 210SUB's **Line-Level LFE In** connector 7 to the dedicated subwoofer output (or LFE output) of your receiver or preamp/processor. Set the subwoofer's **Input Mode switch** 5 to the "LFE" position.

Connect each satellite speaker and the center speaker to the corresponding speaker terminals on your receiver or amplifier.

In your receiver or preamp/processor's setup menu, configure the receiver or preamp/processor for "Subwoofer ON," and set the front, center and surround speakers to "Small." After you have made and verified all connections, plug the HKTS 210SUB's **AC Power cord** 10 into an active AC outlet.



# HKTS 60BQ/230

## Speaker Connections

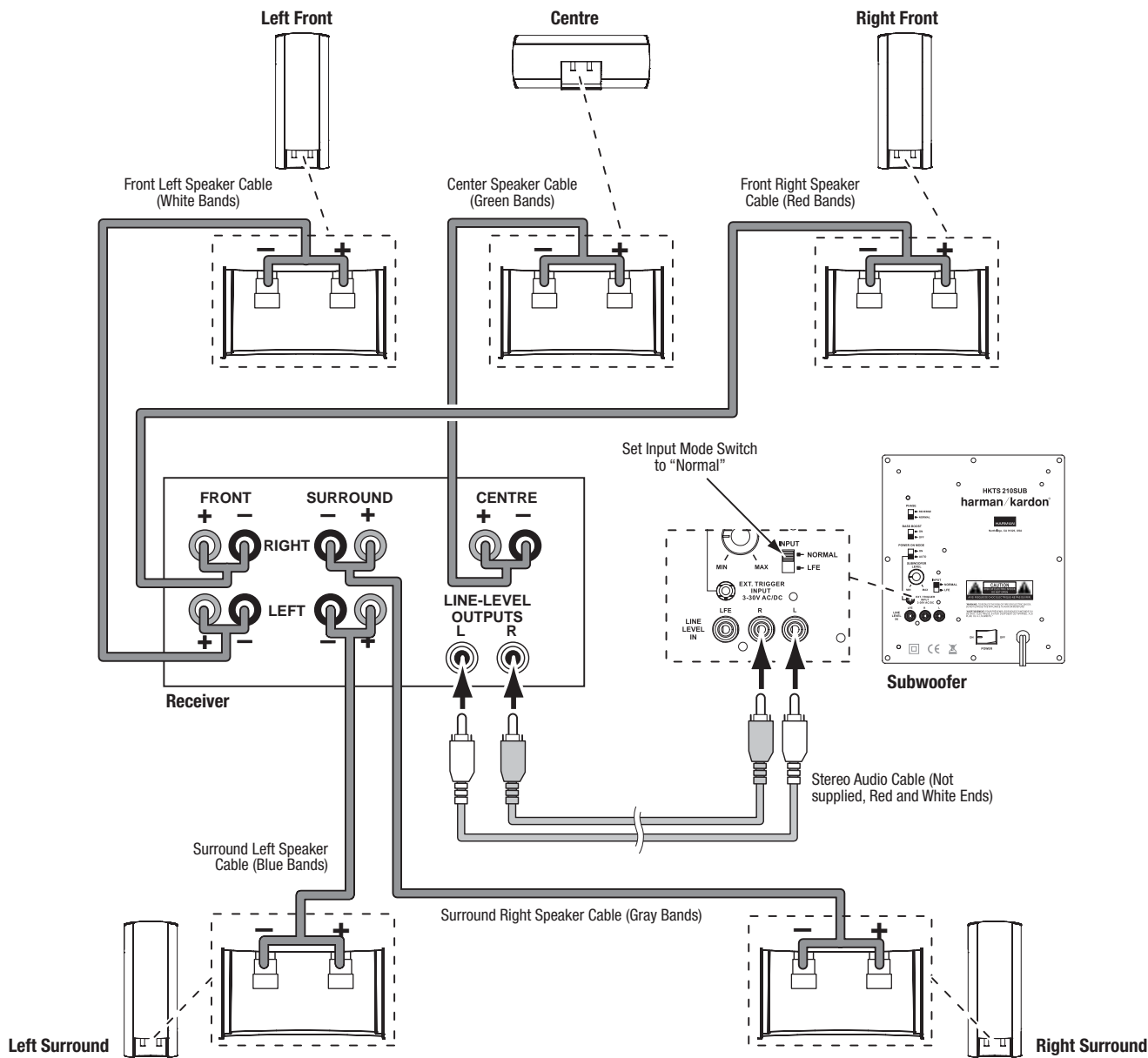

### Connecting the Subwoofer to a Receiver or Preamp/Processor with Line Outputs

Use this installation method for receivers and preamp/processors that do not have a dedicated subwoofer output but do have preamp-level (volume-controlled) line outputs. If the receiver or preamp/processor has a dedicated subwoofer output with low-pass filtering, see *Connecting the Subwoofer to a Receiver or Preamp/Processor With a Dedicated Subwoofer Output*, on page 9.

If you're connecting to a receiver with left and right line outputs that are not connected to amplifier inputs, connect the LFE (purple) connector of the supplied combination LFE and trigger cable to one of those outputs and to either of the HKTS 210SUB's **Line-Level L/R In Connectors ③**. Use a second RCA cable (not supplied) to connect the other receiver or preamp line output to the other of the HKTS 210SUB's **Line-Level L/R In Connectors ③**.

If you're connecting to a receiver or preamp/processor with left and right line outputs that are connected to amplifier front left and front right inputs, connect the single line outputs. Connect one of the Y-adapter's double ends to the HKTS 210SUB's **Line-Level L/R In Connectors ③**, and connect the other double end to your amplifier's front left and right inputs.

Connect each satellite speaker and the centre speaker to the corresponding speaker terminals on your receiver or amplifier.

After you have made and verified all connections, plug the HKTS 210SUB's **AC Power Cord ⑩** into an active AC outlet.

# HKTS 60BQ/230

## Speaker Connections

ENGLISH

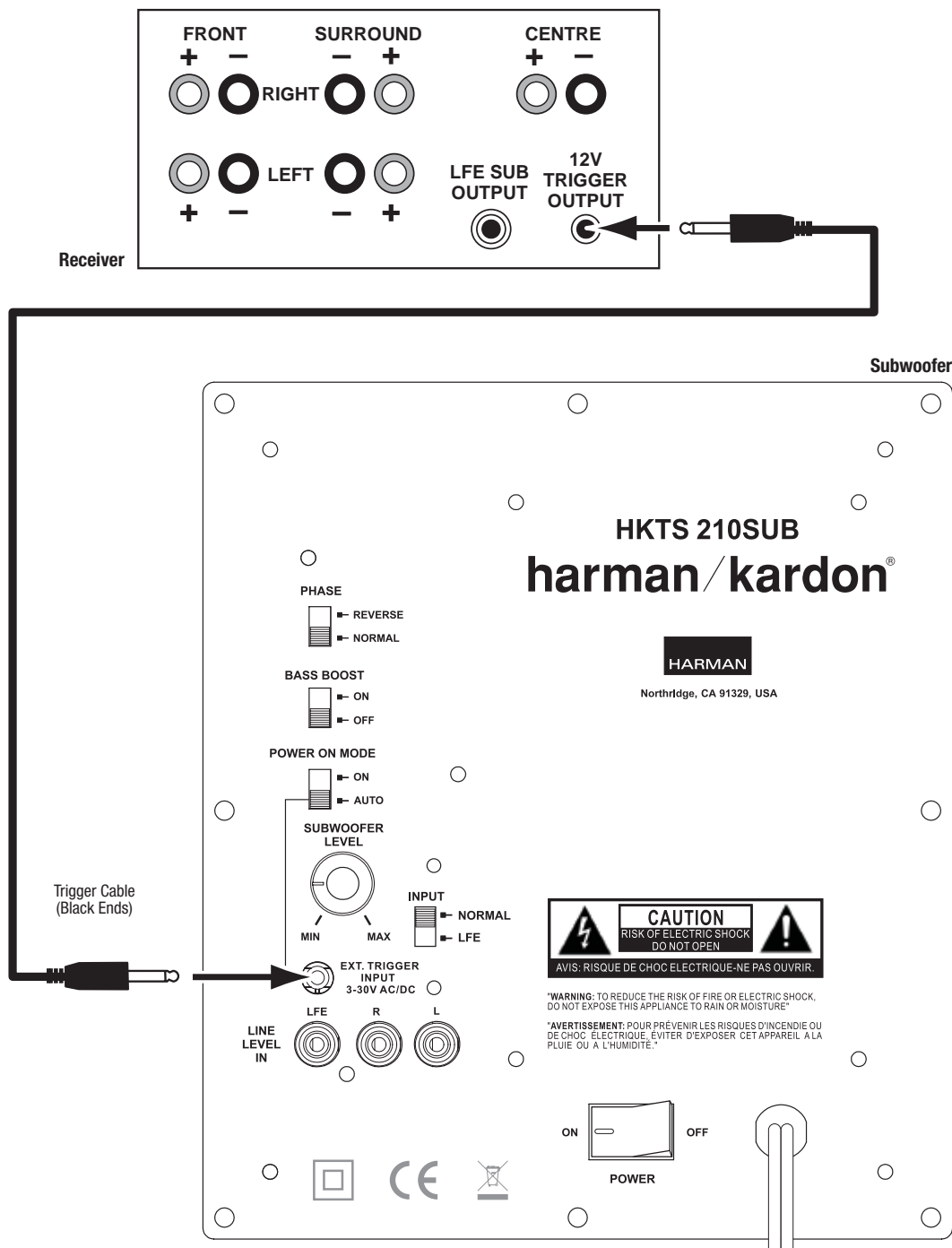

### Connecting to a Trigger-Voltage Source

If your preamp/processor or another audio/video component has a trigger-voltage connection that supplies between 3V and 30V (AC or DC), connect it to the HKTS 210SUB's **External Trigger Input 6**. If the component's trigger-voltage connection has a 3.5mm mini jack, you can use the supplied combination LFE/trigger cable to make the connection.

**NOTE:** Please do not connect the subwoofer ON/OFF trigger cable to the Remote Control Output (IR Out) of your home cinema system or surround receiver. Doing so could lead to malfunction.

# HKTS 60BQ/230

## Operation

### Operation

#### Turning the Subwoofer On and Off

Set the HKTS 210SUB's **Power Switch 9** to the **ON** position.

- If the **Power On Mode Switch 3** is set to **AUTO**, the HKTS 210SUB will automatically turn itself on when it receives an audio signal, and it will go into the standby mode after it has received no audio signal for 15 minutes. The HKTS 210SUB's LED will glow white when the subwoofer is on and will not be illuminated when the subwoofer is in standby.
- If the **Power On Mode Switch 3** is set to **ON**, the HKTS 210SUB will remain on at all times. The HKTS 210SUB's LED will glow white.
- If the **External Trigger Input 6** is connected to a trigger-voltage source, the HKTS 210SUB will turn on whenever a trigger voltage is present and will enter the standby mode after the trigger voltage ceases, regardless of the position of the **Power On Mode Switch 3**.

If you will be away from home for an extended period of time, or if you will not be using the subwoofer for an extended period, switch the **Power Switch 9** to the **OFF** Position.

#### Subwoofer Adjustments: Volume

Use the **Subwoofer Level Control 4** to set the HKTS 210SUB's volume. Turn the knob clockwise to increase the subwoofer's volume; turn the knob counterclockwise to decrease the subwoofer's volume.

#### Subwoofer Adjustments: Phase

The **Phase Switch 1** determines whether the HKTS 210SUB's piston-like action moves in and out in phase with the satellite speakers. If the subwoofer were to play out of phase with the satellite speakers, the sound waves from the satellites could cancel out sound waves from the subwoofer, reducing bass performance and sonic impact. This phenomenon depends in part on the placement of all the speakers in the room.

Although in most cases the **Phase Switch 1** should be left in the **NORMAL** position, there is no absolutely correct setting for the **Phase Switch 1**. When the HKTS 210SUB is properly in phase with the satellite speakers, the audio will be clearer, have maximum impact and make percussive sounds like drums, piano and plucked strings sound more lifelike. The best way to set the **Phase Switch 1** is to listen to music that you know well and set the switch in the position that gives drums and other percussive sounds maximum impact.

#### Subwoofer Adjustments: Bass Boost

When set to the **ON** position, the **Bass Boost Switch 2** enhances low-frequency performance, resulting in bass with more impact, which you may prefer while watching movies or listening to music. There is no harm in experimenting with this control. Setting the switch to the **OFF** position will return normal low-frequency performance.

## HKTS 60BQ/230

## Troubleshooting

**Troubleshooting**

This unit is designed for trouble-free operation. Most problems that users encounter are due to operating errors. So if you have a problem, first check this list for a possible solution. If the problem persists, consult your authorized harman kardon service centre.

Problem	Solution
If there is no sound from <i>any</i> of the speakers:	<ul style="list-style-type: none"> <li>• Check that the receiver/amplifier is on and a source is playing.</li> <li>• Make sure that all wires and connections between the receiver/amplifier and the speakers are connected properly.</li> <li>• Make sure none of the speaker wires is frayed, cut or punctured.</li> <li>• Review the proper operation of your receiver/amplifier.</li> </ul>
If there is no sound coming from <i>one speaker</i> :	<ul style="list-style-type: none"> <li>• Check that the balance control on your receiver/amplifier is not set all the way to one channel.</li> <li>• Check your receiver/amplifier's speaker setup procedure to make sure that the speaker in question has been enabled and its volume level has not been turned all the way down.</li> <li>• Make sure that all wires and connections between the receiver/amplifier and the speaker are connected properly.</li> <li>• Make sure the speaker wires are not frayed, cut or punctured.</li> </ul>
If there is no sound coming from the <i>center speaker</i> :	<ul style="list-style-type: none"> <li>• Check your receiver/amplifier's speaker setup procedure to make sure that the center speaker has been enabled and its volume level has not been turned all the way down.</li> <li>• Make sure that all wires and connections between the receiver/amplifier and the center speaker are connected properly.</li> <li>• Make sure the speaker wires are not frayed, cut or punctured.</li> <li>• If your receiver is operating in Dolby® Pro Logic® mode, make sure that the center speaker is not set to Phantom.</li> </ul>

You can find additional troubleshooting information in the FAQs link on the Support page at [www.harmankardon.com](http://www.harmankardon.com).

# HKTS 60BQ/230

## Specifications

### Specifications

#### HKTS 60BQ/230 System

Frequency Response	45Hz – 20kHz (-6dB)
--------------------	---------------------

#### SAT-TS60 Satellites

Recommended Power	20 ~ 150 watts
-------------------	----------------

Impedance	8 ohms nominal
-----------	----------------

Sensitivity	83dB @ 2.83V/1 meter
-------------	----------------------

Tweeter	One 1" (25mm) CMMD Lite dome, video-shielded
---------	--

Midrange	Dual 3" (75mm) flat-diaphragm drivers, video-shielded
----------	---

Dimensions – including stands (H x W x D)	299mm x 110mm x 88mm (11-25/32" x 4-11/32" x 3-15/32")
--	---

Weight	1.5 kg (3.4 lb)
--------	-----------------

#### CEN-TS60

Recommended Power	20 ~ 150 watts
-------------------	----------------

Impedance	8 ohms nominal
-----------	----------------

Sensitivity	83dB @ 2.83V/1 meter
-------------	----------------------

Tweeter	One 1" (25mm) CMMD Lite dome, video-shielded
---------	--

Midrange	Dual 3" (75mm) flat-diaphragm drivers, video-shielded
----------	---

Dimensions (H x W x D)	110mm x 272mm x 88mm (4-11/32" x 10-11/32" x 3-15/32" )
------------------------	--

Weight	1.5kg (3.3 lb)
--------	----------------

#### HKTS 210SUB Subwoofer

Power requirement	AC 100–120V, 50/60 Hz, 200W (USA)
	AC 220–240V, 50/60 Hz, 200W (EU)

Amplifier Power	200 watts RMS
-----------------	---------------

Woofer	8" (200mm) woofer, sealed enclosure
--------	-------------------------------------

External Trigger Input Voltage	3 ~ 30 volts AC/DC
--------------------------------	--------------------

Dimensions (H x W x D)	353mm x 267mm x 267mm (13-29/32" x 10-1/2" x 10-1/2")
------------------------	--

Weight	9.0 kg (19.8 lb)
--------	------------------



# HKTS20Sat Exploded drawing

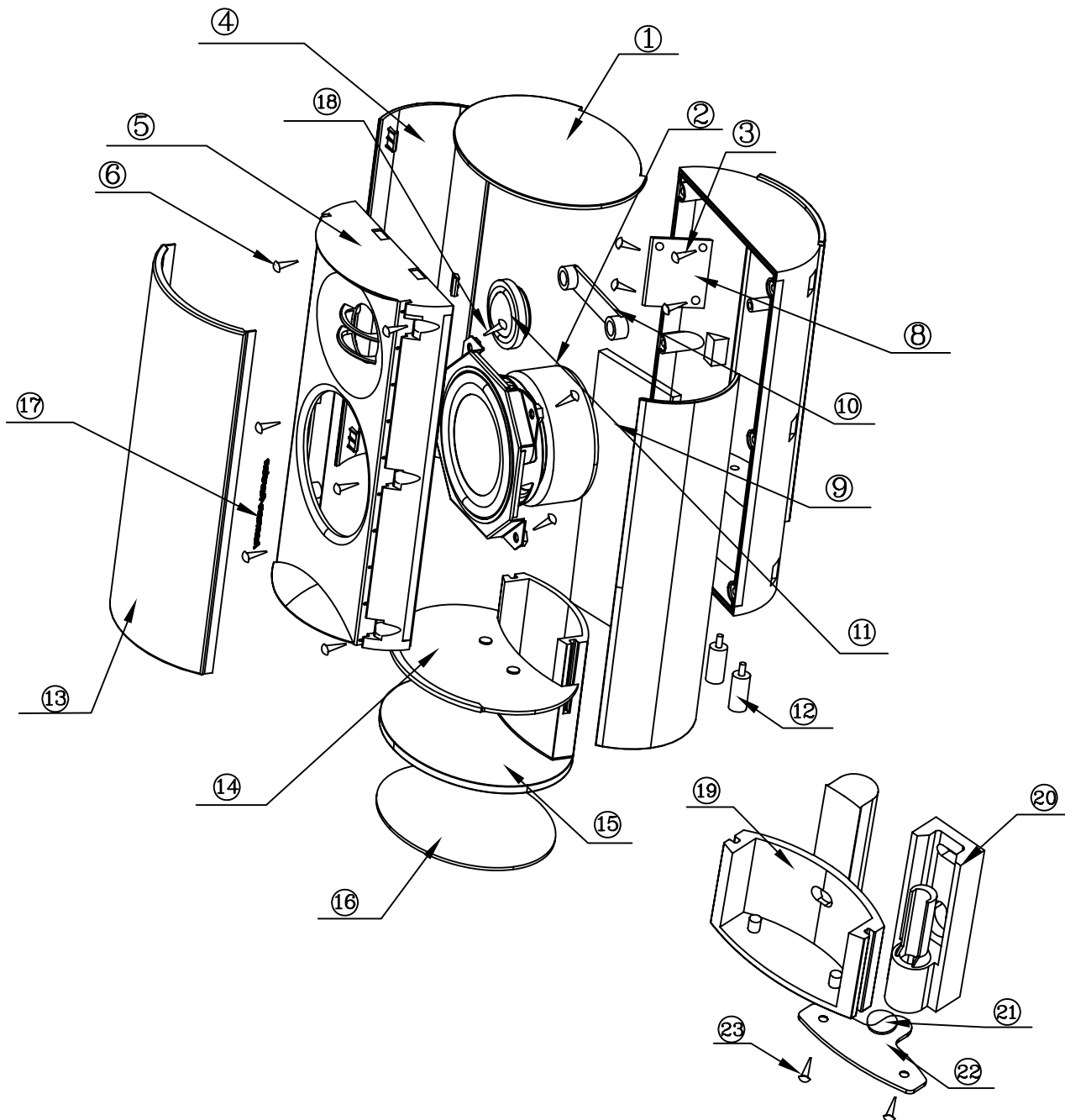

#	Decription	ST Part number	UOM
①	TOP Cover	TP-80326-01	1
②	Woofer	080F40001	1
③	Screw	SR-0504-08B	4
④	Side Panel	BP-80326-02	2
⑤	Front Baffle	FP-80326-01P	1
⑥	Screw	SR-0504-12D	8
⑦	Rear Enclosure	RP-80326-01P	1
⑧	Crossover	FL-80326-01	1
⑨	Damping foam	FT-80326-01	1
⑩	Tweeter Bridge	MY-0546-01	1
⑪	Tweeter	020D9855	1
⑫	Terminal	TM-0438-01	1
⑬	Grille	NT-80326-01	1
⑭	Bottom Cover	BP-80326-01	1
⑮	Stand Base	SB-80326-01P	1
⑯	Rubber pad	CR-80326-01	1
⑰	Logo	AL-80326-01	1
⑱	Screw	SR-2704-10B	4
⑲	Stand Pole	SP-80326-01P	1
⑳	Stand Pole	SP-80326-02P	1
㉑	Rubber Pad	PK-80326-02	1
㉒	Steel Plate	SP-80326-03	1
㉓	Screw	SR-1403-08	2

# HKTS30 Sat Exploded drawing

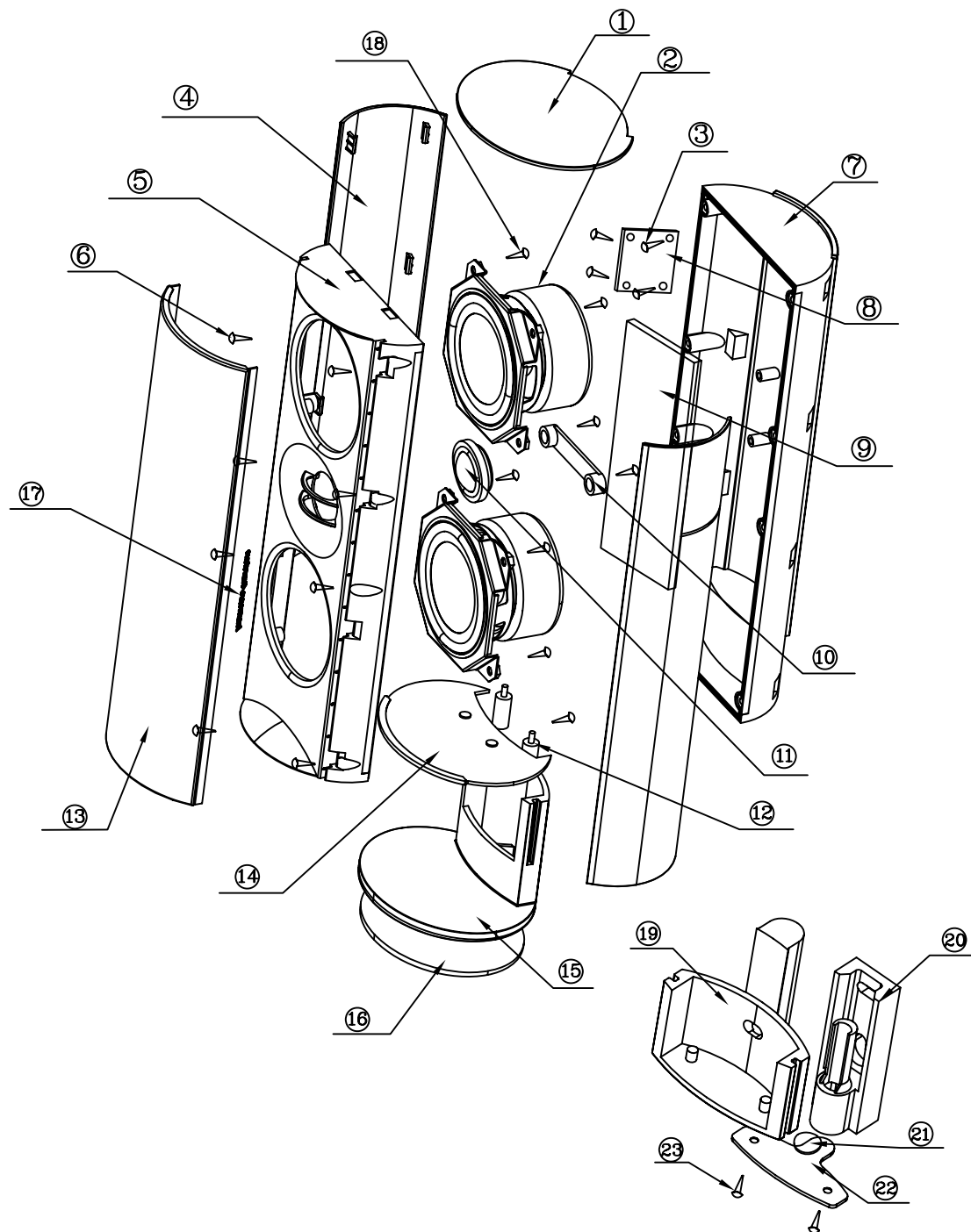

#	Decription	ST Part number	UOM
①	TOP Cover	TP-80326-01	1
②	Woofers	080F40002	2
③	Screw	SR-0504-08B	4
④	Side Panel	BP-80327-01	2
⑤	Front Baffle	FP-80327-01P	1
⑥	Screw	SR-0504-12D	10
⑦	Rear Enclosure	RP-80327-01P	1
⑧	Crossover	FL-80327-01	1
⑨	Damping foam	FT-80327-01	1
⑩	Tweeter Bridge	MY-0546-01	1
⑪	Tweeter	020D9855	1
⑫	Terminal	TM-0438-01	1
⑬	Grille	NT-80327-01	1
⑭	Bottom Cover	BP-80326-01	1
⑮	Stand Base	SB-80326-01P	1
⑯	Rubber pad	CR-80326-01	1
⑰	Logo	AL-80326-01	1
⑱	Stand Pole	SP-80326-01P	1
⑳	Stand Pole	SP-80326-02P	1
㉑	Rubber Pad	PK-80326-02	1
㉒	Steel Plate	SP-80326-03	1
㉓	Screw	SR-1403-08	2

# HKTS30 WQ Sat Exploded drawing

NOTE: WHITE VERSION.

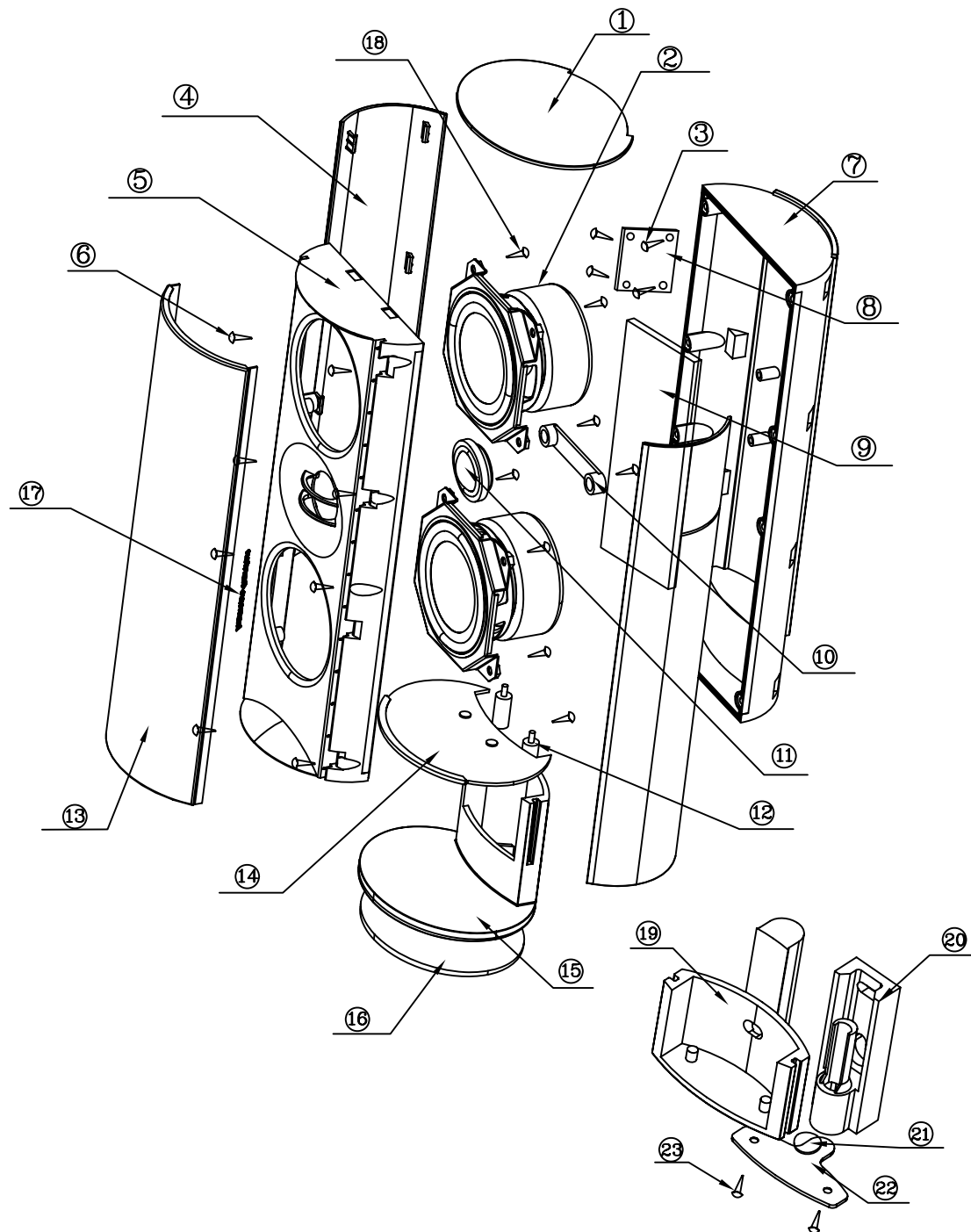

#	Decription	ST Part number	UOM
①	TOP Cover	TP-80326-02P	1
②	Woofers	080F40002	2
③	Screw	SR-0504-08B	4
④	Side Panel	BP-80327-02P	2
⑤	Front Baffle	FP-80327-01P	1
⑥	Screw	SR-0504-12D	10
⑦	Rear Enclosure	RP-80327-02P	1
⑧	Crossover	FL-80327-01	1
⑨	Damping foam	FT-80327-01	1
⑩	Tweeter Bridge	MY-0546-01	1
⑪	Tweeter	020D9855	1
⑫	Terminal	TM-0438-01	1
⑬	Grille	NT-80327-02	1
⑭	Bottom Cover	BP-80326-03P	1
⑮	Stand Base	SB-80326-02P	1
⑯	Rubber pad	CR-80326-01	1
⑰	Logo	AL-80326-01	1
⑱	Stand Pole	SP-80326-04P	1
⑳	Stand Pole	SP-80326-05P	1
㉑	Rubber Pad	PK-80326-02	1
㉒	Steel Plate	SP-80326-06	1
㉓	Screw	SR-1403-08	2

# HKTS20/30 Center Exploded drawing

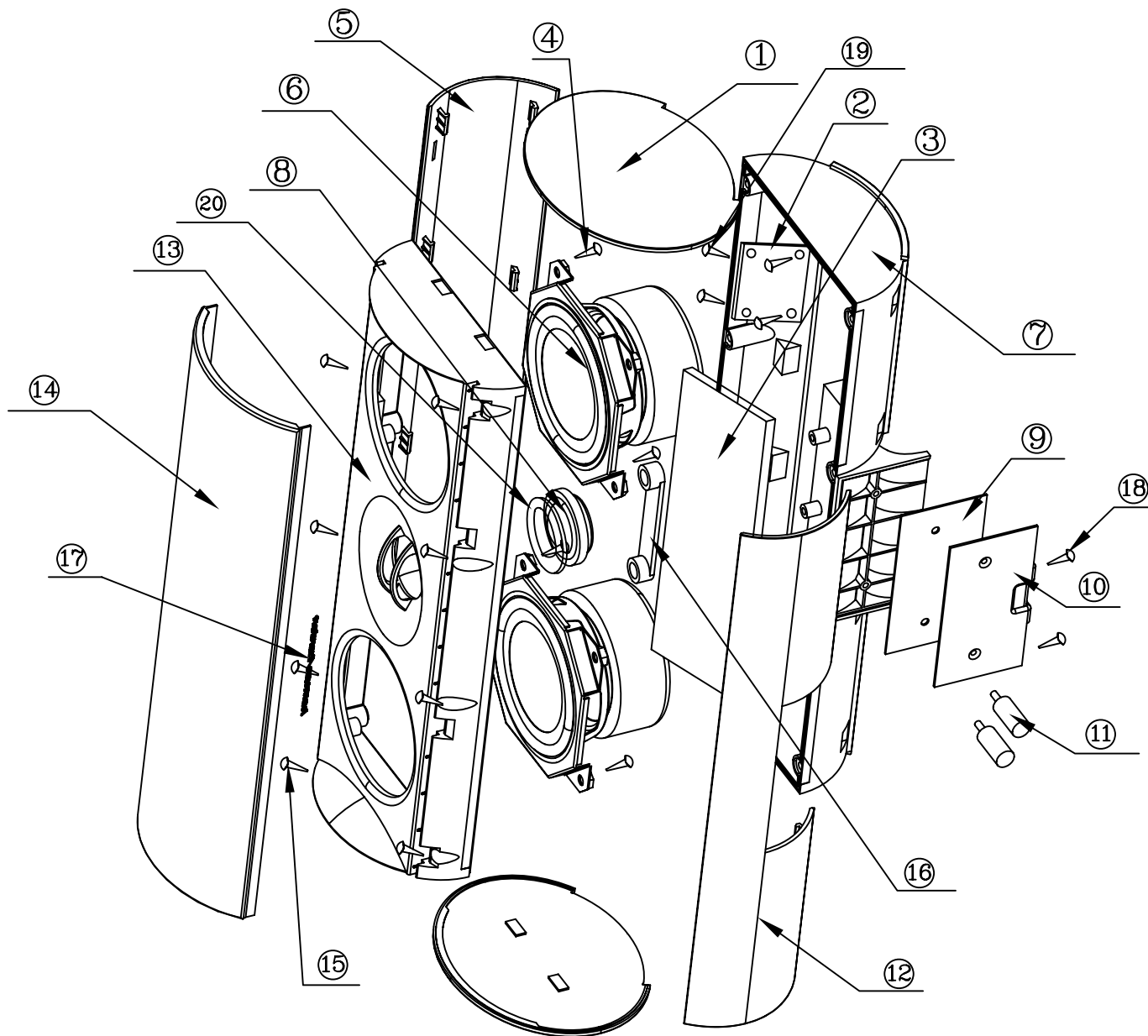

#	Description	ST Part number	UOM
①	Side Panel	TP-80326-01	2
②	Crossover	FL-80328-01S	1
③	Damping foam	FT-80327-01	1
④	Screw	SR-2704-10B	8
⑤	TOP Cover	BP-80328-01	1
⑥	Woofers	080F40002	2
⑦	Rear Enclosure	RP-80328-01P	1
⑧	Tweeter	020D9855	1
⑨	Gasket	PK-80328-01	1
⑩	Steel Plate	SP-80328-03	1
⑪	Terminal	TM-0438-01	1
⑫	Bottom Cover	BP-80328-02	1
⑬	Front Baffle	FP-80328-01P	1
⑭	Grille	NT-80327-01	1
⑮	Screw	SR-0504-12D	10
⑯	Tweeter Bridge	MY-0546-01	1
⑰	Logo	AL-80326-01	1
⑱	Screw	SR-1403-08B	4
⑳	Gasket	PK-0411-01	1

# HKTS20/30 WQ Center Exploded drawing

NOTE: WHITE VERSION.

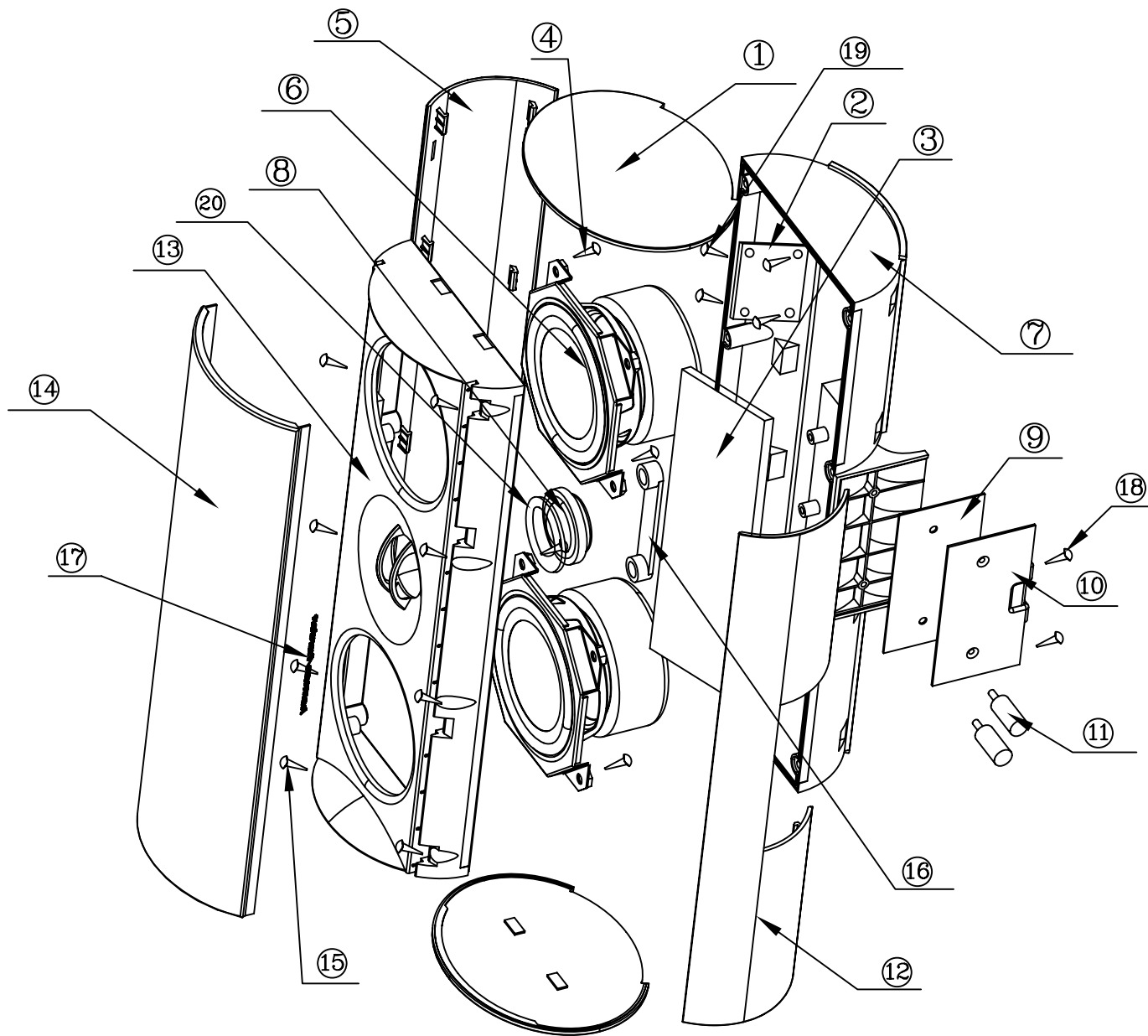

#	Description	ST Part number	UOM
①	Side Panel	TP-80326-02P	2
②	Crossover	FL-80328-01S	1
③	Damping foam	FT-80327-01	1
④	Screw	SR-2704-10B	8
⑤	TOP Cover	BP-80328-03P	1
⑥	Woofers	080F40002	2
⑦	Rear Enclosure	RP-80328-02P	1
⑧	Tweeter	020D9855	1
⑨	Gasket	PK-80328-01	1
⑩	Steel Plate	SP-80328-04	1
⑪	Terminal	TM-0438-01	1
⑫	Bottom Cover	BP-80328-04P	1
⑬	Front Baffle	FP-80328-01P	1
⑭	Grille	NT-80327-02	1
⑮	Screw	SR-0504-12D	10
⑯	Tweeter Bridge	MY-0546-01	1
⑰	Logo	AL-80326-01	1
⑱	Screw	SR-1403-08B	4
⑳	Gasket	PK-0411-01	1



# HKTS60 Sat Exploded drawing

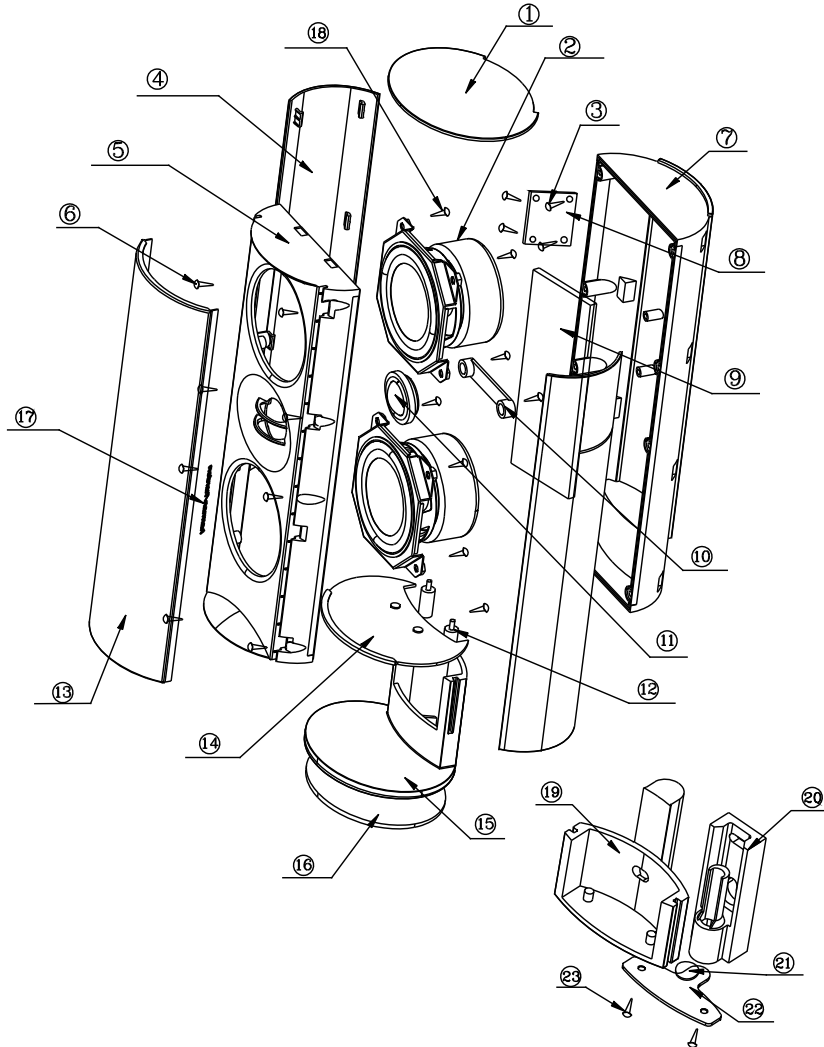

#	Description	ST Part number	UOM
①	TOP Cover	TP-80326-01	1
②	Woofer	Q80F40003	2
③	Screw	SR-0504-08B	4
④	Side Panel	BP-80327-01	2
⑤	Front Baffle	FP-80329-01P	1
⑥	Screw	SR-0504-12D	10
⑦	Rear Enclosure	RP-80327-01P	1
⑧	Crossover	FL-80329-01	1
⑨	Damping foam	FT-80327-01	1
⑩	Tweeter Bridge	MY-0546-01	1
⑪	Tweeter	025D40901	1
⑫	Terminal	TM-0438-01	1
⑬	Grille	NT-80327-01	1
⑭	Bottom Cover	BP-80326-01	1
⑮	Stand Base	SB-80326-01P	1
⑯	Rubber pad	CR-80326-01	1
⑰	Logo	AL-80326-01	1
⑱	Screw	SR-2704-10B	8
⑲	Stand Pole	SP-80326-01P	1
⑳	Stand Pole	SP-80326-02P	1
㉑	Rubber Pad	PK-80326-02	1
㉒	Steel Plate	SP-80326-03	1
㉓	Screw	SR-1403-08	2

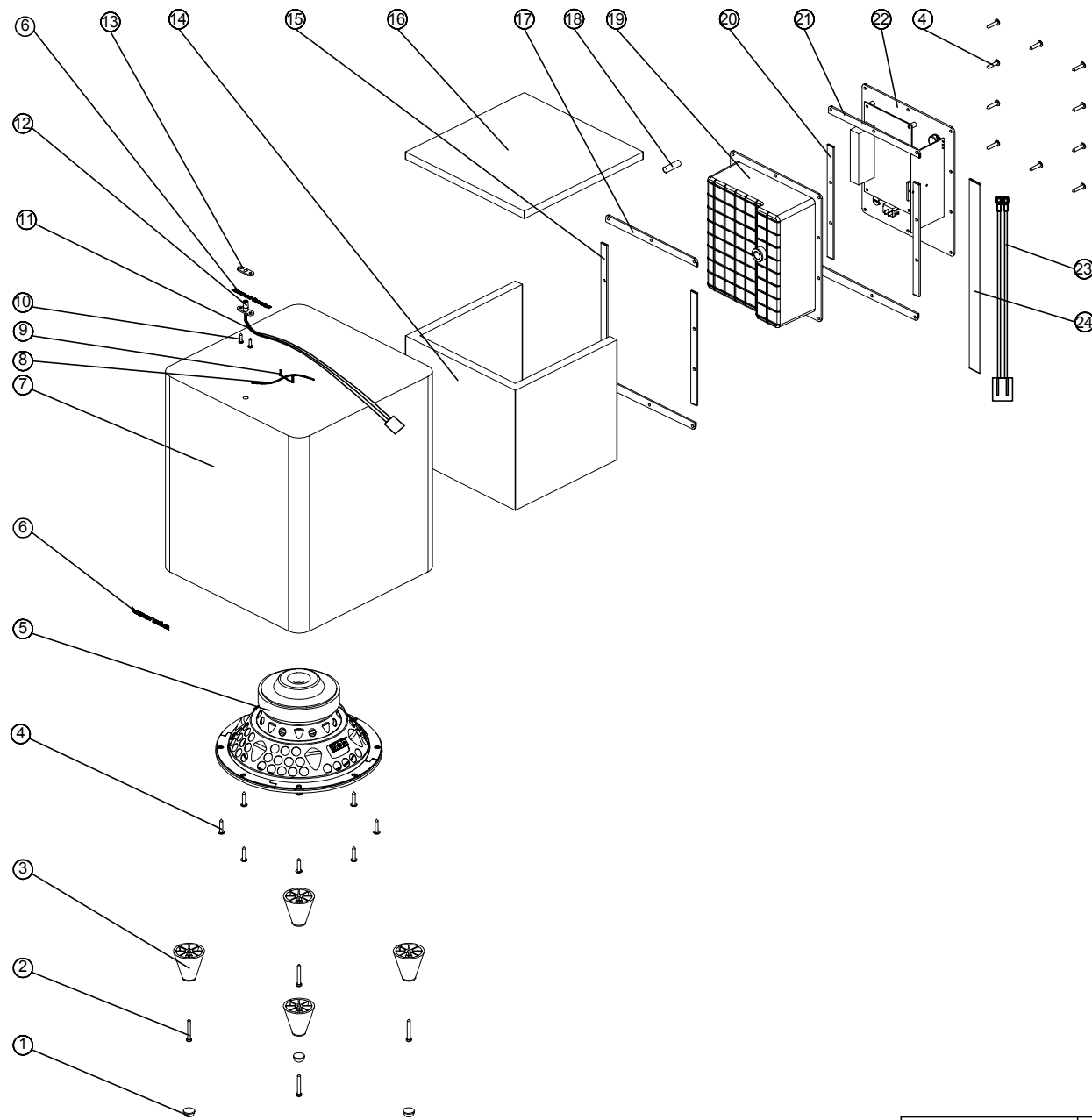

⚠				
⚠				
⚠				
⚠				

24	EVA FOAM	IVEA00152-0001	L700.0XW30.0XT3.0 单面背胶	2
23	Speaker Cable	VWT502421-0300	2P 300mm 2468#18 RED/BLACK	1
22	AMP ASSMEBLY	ASLA00341-0002	HKTS200SUB 230V	1
21	SEAL PE PAD	IVHA12002-0001	L176XW11.0XT1 单面背胶	2
20	SEAL PE PAD	IVHA12002-0002	L178XW11.0XT2 单面背胶	2
19	AMP Rear Cover	BPVA00032-0001	L173.4XW198.4XH79.5MM	1
18	BUTYL TAPE	XBT090001-M000	L20.0XØ9.0	1
17	Amp Rear Cover EVA	IVEA00168-0002	L178XW11.0XT2 单面背胶	2
16	Wadding	IVMA20001-0027	L235XW235XT10MM	1
15	Amp Rear Cover EVA	IVEA00168-0001	L176XW11.0XT2 单面背胶	2
14	Wadding	IVMA20001-0026	L660XW240XT10MM	1
13	EVA PAD	IVEA00178-0001	L28XW9.5XT1.5 BLACK 单面背胶3#	1
12	LED Cup	BPNA00008-0001	Ø6.8XØ3.2XL9.0 ABS HB	1
11	LED Cup Base	BPSA02012-0001	L28*W9.5*H10.1MM ABS HB	1
10	BLUE LED CABLE	VOT050001-0010	2P 350mm RED/BLACK	1
10	Screw	HSBA70051-3120	BT3.0XL12 Steel 1018	2
9	STAPLE	XNJA21206-0011	L11.2XH5.7XT1.3X(12X6)MM	4
8	WIRE TIE	DWT000012-0900	L90.0	1
7	Cabinet	ASLA00340-0001	L304.8XW266.7XD266.7 MDF E1	1
6	Logo	GALA00198-0001	L70XW7.2XT0.5 CHROME PLATING	2
5	WF 8"	FSBA2B080-0401	8" 4OHM 200W	1
4	Screw	HSBA50431-3201	BT4.0XL20 Steel 1018	18
3	Foot	BPEA00006-0001	Ø42XH42 SATIN BLACK PAINTED	4
2	Screw	HSPA50352-4300	BT4.0XL30 Steel 1018	4
1	Rubber Feet	BRFA00049-0001	Ø15XH9.0MM SILICON 60-65度	4

Item NO.	Part Name	Part NO.	Description	Qty.	Total
----------	-----------	----------	-------------	------	-------

				Tolerance					. Model NO.	
				Angular ±0.25°					HKTS200SUB	
Quotation	Version NO.:	Scale:	Unit:	Dimension	F	G	H	J	ANWAHKTS3-4310	
	00	1:1	MM	0-8	±0.05	±0.1	±0.1	±0.2		
Sample	Sheet:	Checked By	Approved By	8-25	±0.08	±0.15	±0.15	±0.3	Part NO. HKTS3LZY0-0001	
	1/1			25-80	±0.12	±0.2	±0.25	±0.4		
Tooling				80-250	±0.25	±0.3	±0.4	±0.6	Drawing NO. HKTS3LZY0-0001	
				250-800	±0.5	±0.6	±0.8	±1.0		
Official Issue				800-2500	±1.0	±1.0	±1.5	±1.7	Page 42 of 49	
				2500~	±2.0	±2.0	±3.0	±3.0		

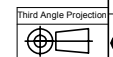

**Model name:** HKTS200 SUB\230V for HKTS 20 and 30 systems

Component No.	Description	UOM	Usage(pcs)
HSBA50431-3201	SCREW T4.0x2.85PxL20MM CED COATING	PC	18
HSPA50352-4300	SCREW T4.0x2.85PxL30MM BLACK ZINC	PC	4
HSBA70051-3120	GP SCREW STEEL BLACK ZINC	PC	2
BRFA00049-0001	HKTS30-RUBBER FEET	PC	4
BPVA00032-0001	AMP REAR COVER	PC	1
GALA00198-0001	HKTS30-Logo AL	PC	2
BPNA00008-0001	HKTS30-LED Cup	PC	1
BPEA00006-0001	HKTS30-FOOT ABS HB	PC	4
IVEA00168-0001	EVA BLACK	PC	2
IVEA00168-0002	EVA BLACK	PC	2
XBT090001-M000	BUTYL TAPE DIA 9.0 (2.5M/1R)	M	
XNL000003-0002	HOT MELT GLUE #1-286 D11.2mm	KG	
XNL500006-0001	PVC GLUE	KG	
XNJA21206-0011	STAPLE FOR C803/5/7/9 STEEL PLATE ZINC	PC	4
DWT000012-0900	GP WIRE TIE GT-90M 90mm	PC	2
XTP020300-0001	PE PROTECTIVE SHEET W300xT0.05mm	RL	
XNB000008-0001	THINNER MEK 丁酮 18L/PAILFUL	L	
IVHA12002-0001	HKTS30-SEAL PE PAD	PC	2
IVHA12002-0002	HKTS30-SEAL PE PAD	PC	2
VOT050001-0010	BLUE LED CABLE 2P 350mm RED/BLACK	PC	1
BPSA02012-0001	HKTS30-LED Cup Base	PC	1
VWT502421-0300	GP WIRE TERM 2P 380mm RED/BLACK	PC	1
XGLA00102-0001	704 BLACK SILICON GLUE 1pcs=90g	PC	
XAD050010-0001	DOUBLE SIDE TAPE W10mmxL50M/RL	RL	
IVEA00178-0001	EVA PAD	PC	1
IVEA00152-0001	SPONGE L700*W30*T3.0 GRAY 单面背胶	PC	2
ASLA00340-0001	CABINET ASSY FOR HKTS30	PC	1
IVMA20001-0026	WADDING 杂布棉	PC	1
IVMA20001-0027	WADDING 杂布棉	PC	1
ASLA00340-0004	ACCESSORY ASSY FOR HKTS30	PC	1
IVAA02036-0001	PE BAG For WIRE	PC	1
VRC202001-0010	RCA CABLE UL2547 24AWG BLACK/PURPLE	PC	1
APKA00116-0001	PACKING ASSY FOR HKTS30 230V	PC	1
ITFA30086-0001	HKTS30-TOP POLYFOAM	PC	1
ITFA30086-0002	HKTS30-BOTTOM POLYFOAM	PC	1
IVSA10047-0001	NON WEAVE BAG	PC	1
ICCA00227-0001	HKTS30-CARTON BOX 230V	PC	1
XAD030060-0001	OPP TAPE W60mmxL60YD 100RL/BOX	RL	
IVHA04022-0001	EPE PAD	PC	1
XTP020020-0002	PE PROTECTIVE SHEET L100xW20xT0.05mm	PC	2
YLBA18028-0001	BAR+SERIAL LABEL HKTS200 230V 一式四份	SET	1
YLBA18029-0001	BAR+SERIAL AMP LABEL FOR HKTS200 230V	PC	1
DOT040004-0001	DESICCANT 5G/BAG	BAG	4
IVAA02034-0001	PE BAG	PC	1
IVAA07021-0001	SOFT BAG	PC	1
IVHA02016-0001	SOFT SHEET(单面附膜)	PC	2
IVHA02016-M000	SOFT(单面附膜)	M	
FSA2B080-0401	HKTS30 SUBWOOFER DRIVER	PC	1
ASLA00341-0002	AMPLIFIER ASS'Y 230V HKTS30	PC	1

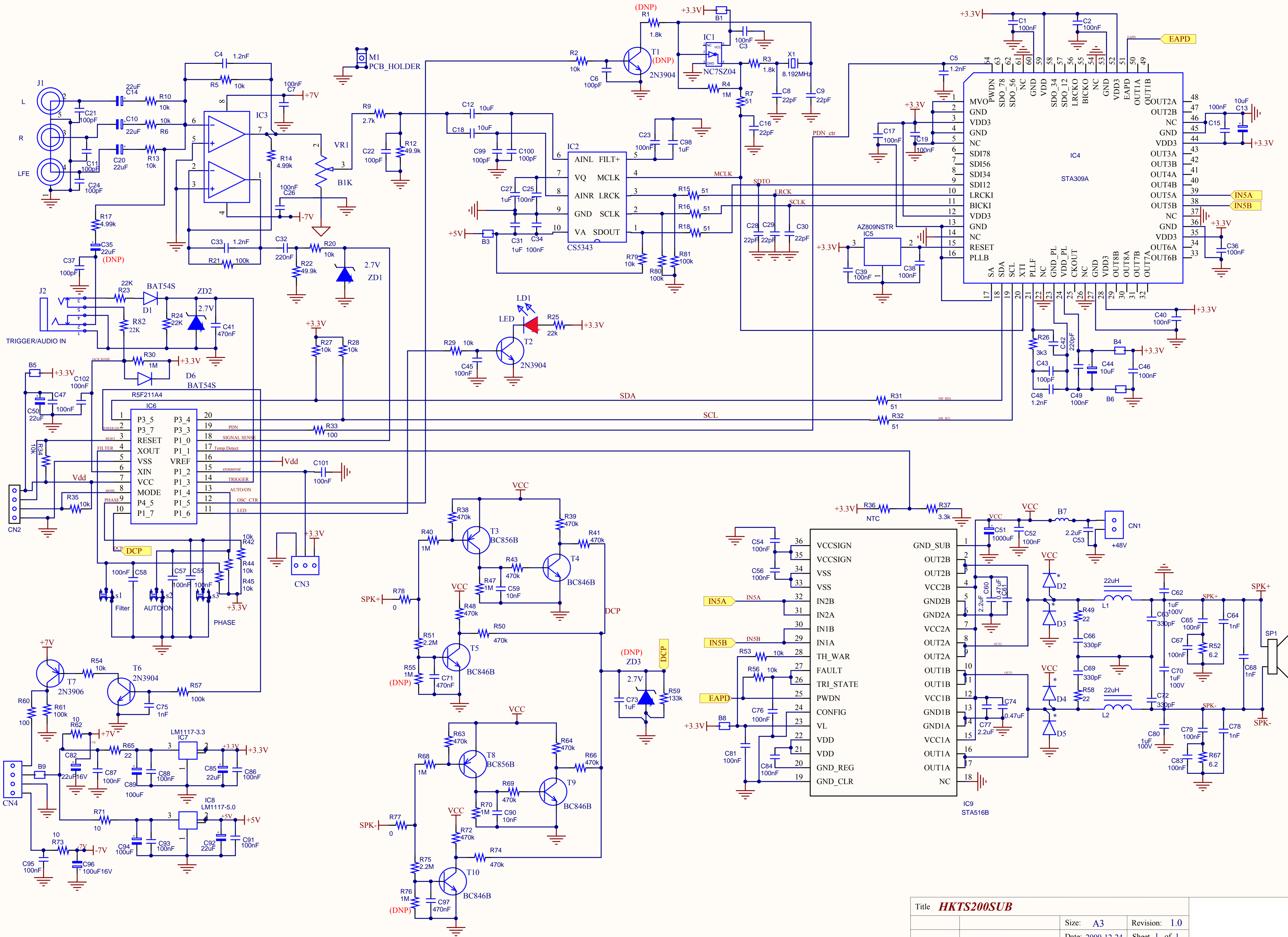

Title	<b>HKTS200SUB</b>		
Size	A3	Revision	1.0
Date	2009-12-24	Sheet	1 of 1
File:	E:\Work\HKTS\SCH2.SchDoc		

Date	Editions	Page	Exploded View Instruction	Client: harman/kardon
2010.09.27	1	1		Model: HKTS210SUB/230

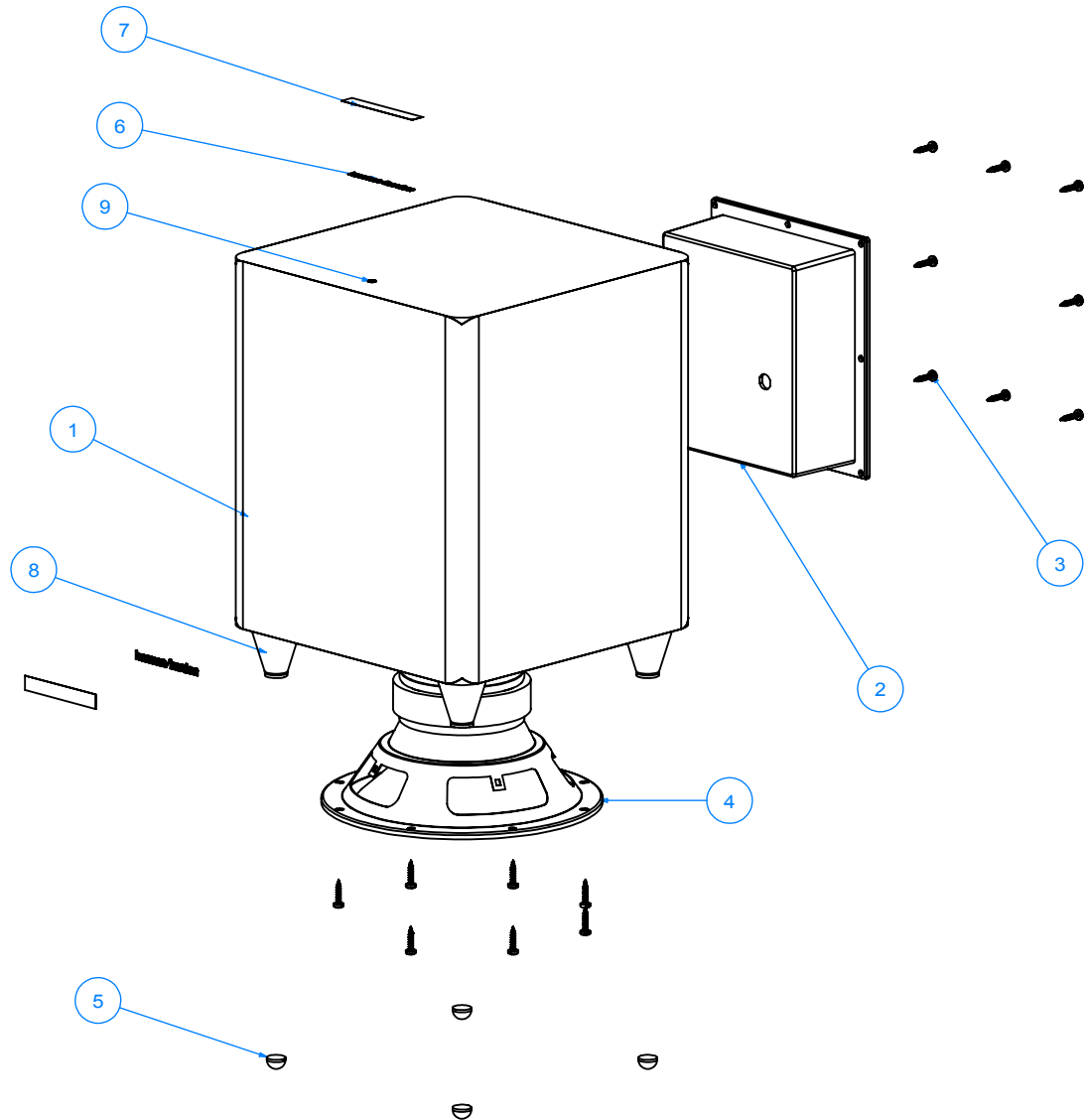

Item	Part Name	Description	Q'ty
1	241-080-05531-0BAE	Cabinet	1
2	010-0N20-05317-E	Amplifier	1
3	352-FM04020D605-E	Screw	16
4	24MR11DZA-DW01-E	8" Subwoofer	1
5	320-SR-05226-0BAE	Rubber Feet	4
6	316-AG-00557-E	LogoBadge	2
7	413-000-05591-E	Static Label	2
8	321-ABS-05141-0BAE	Plastic Feet	4
9	162-A025D023-E	LED+Cable	1

3				Apvd. By	Check. By	Dsgn. By
2						
1						
0	A0	2010.09.27				
ISSUE	REVISIONS	DATE	NAME			

<b>HKTS210SUB parts list</b>		
<b>Part Number</b>	<b>DESCRIPTION</b>	<b>SAP Description</b>
010-0N20-05317-E	AMPLIFIER, COMPLETE	
050-A05317A-E	SMD PCB ASS'Y HKTS210/230 POWER-AMP	
051-A05317D-E	HKTS210/230 LFE SW assy	LFE SWITCH ASSY HKTS210/230 SUB
051-A05317A-E	PCB ASSY HKTS210/230 POWER AMP	POWERAMP PCB ASSSY HKTS210/230 SUB
050-A05317B-E	SMD PCB ASS'Y HKTS210/230 PSU	
051-A05317C-E	PCB ASSY HKTS210/230 CONTROL BOARD	CONTROL BOARD PCB ASSY HKTS210/230
051-A05317B-E	PCB ASS'Y HKTS210/230 PSU PCB ASSY	POWER SUPPLY HKTS210/230 SUB
152-V60202603-E	POWER CABLE, 6FT SPO21A HO3VVH2-F	
156-H220050-E	HEATSHRINK TUE 22ø 55MM	
162-5025D009-E	+ 2.5 CONNECTOR	
162-A013D011-E	3.96 HOUSING 3 205 0.8T TERMINAL	
162-A042D002-E	3.96 HOUSING 3 250 #250 # 205 TERMINAL	
163-11009-E	NYLON TIE 100MM CLEARCOLOR	
180-P3024DB-E	ROCKER SIWTCH 3024-DB	
302-AL-05293-1BAE	AMP PANEL + SILK SCREEN	REAR PANEL +SILKSCREEN HKTS210/230 SUB
306-ABS-05175-0BAE	REAR HOUSING FOR AMP	
311-ABS-00028-0BAE	KNOB	KNOB REAR HKTS210/230 SUB
323-A;-05202-0LAE	HEATSINK	
335-NYL-00002-0BAE	POWER CORD	PWR CORD GROMMET
24MR11DZA-DW01-E	WOOFER	WOOFER 8"
165-550005500-E	SIGNAL CABLE ( 5 M, RCA + 3.5ø PIN )	SIGNAL CABLE 5 M RCA 3.5ø PIN HKTS210/230
241-080-05531-0BAE	WOOD CABINET	
316-AG-00557-E	LOGO	LOGO "HK"
283-001-05347-0WAE	NON-WOVEN CLOTH BAG	
431-000-07204-E	STYROFOAM(TOP/BOTTOM)	
402-000-06417-E	BEAUTY CARTON	
406-000-06259-E	OM	



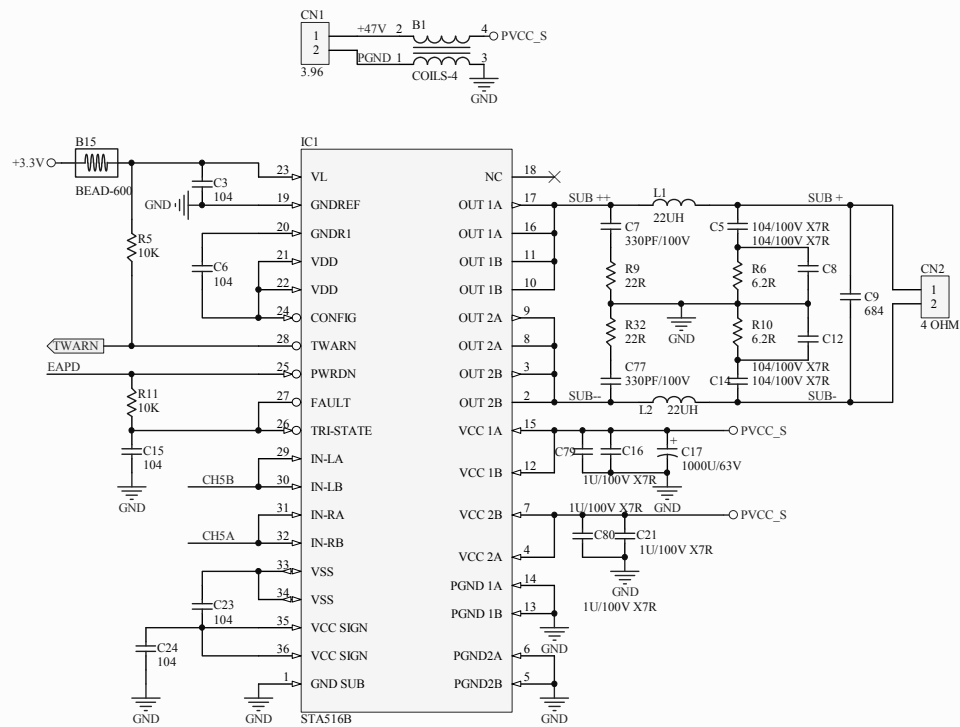
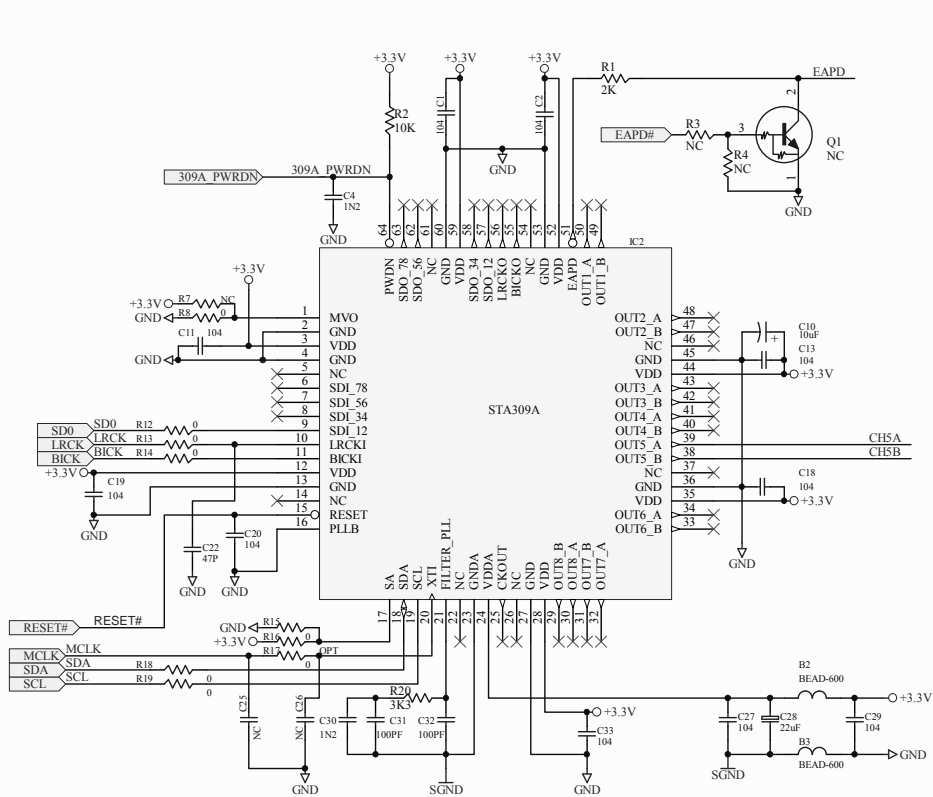

Title HKTS210SUB		
Size A3	Number	Revision
Date: 2010/8/3	Sheet of	
File: D:\HKTS210\DV1\AMP_DV1.SCHDOC	Drawn By:	

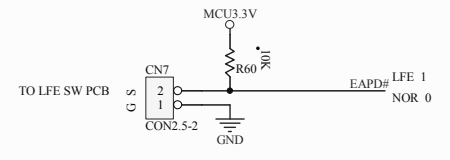
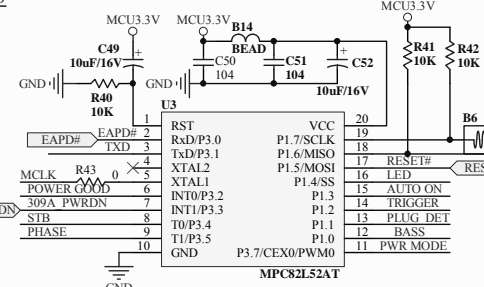
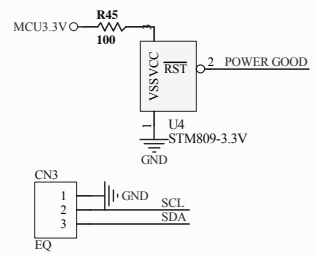
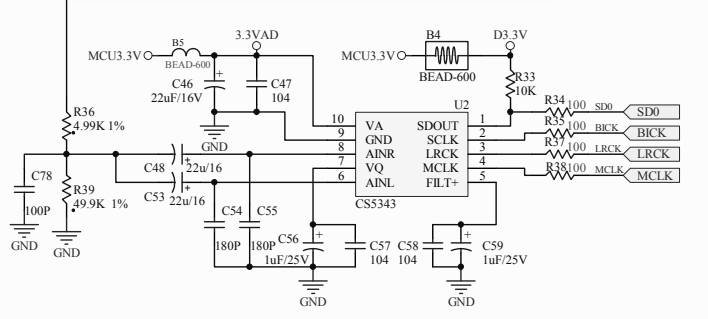
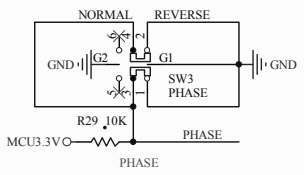
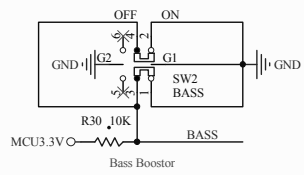
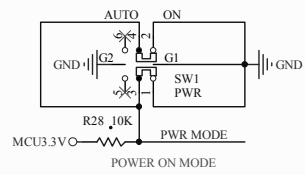
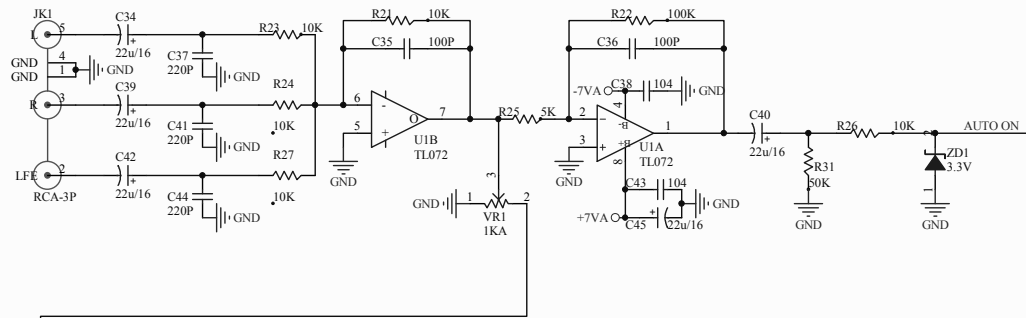

PLUG_DET	0	0	0	1	1
TIGGER	0	0	0	0	1
PWR MODE	(AUTO)	(AUTO)	(0)	(0)	(X)
AUTO ON	1	0	X	X	X
STB	1	0	1	0	1
LED	1	0	1	0	1

AUTO OFF TIME=15 MIN

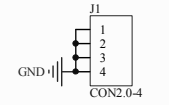
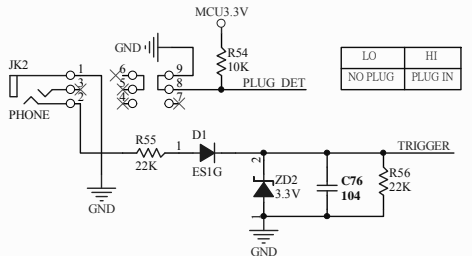
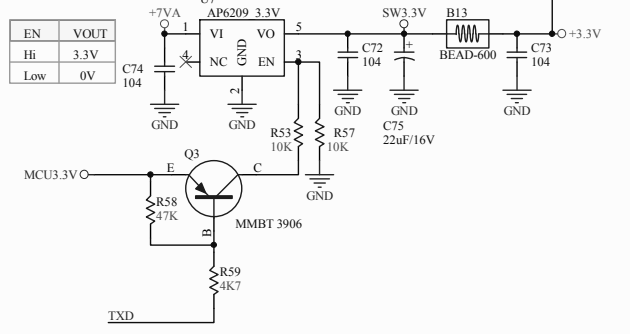
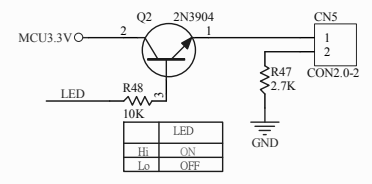
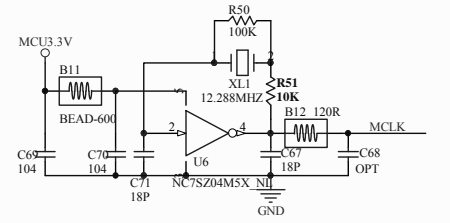
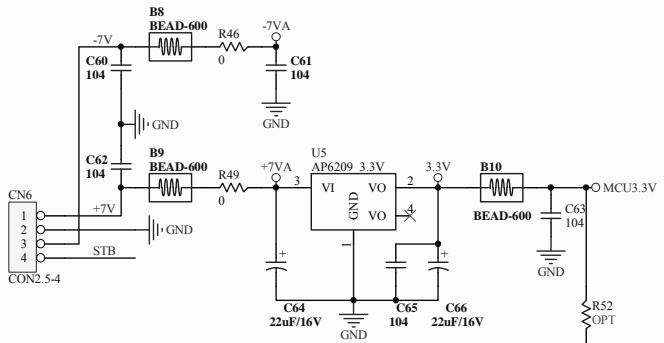

1

2

3

4

A

A

B

B

C

C

D

D

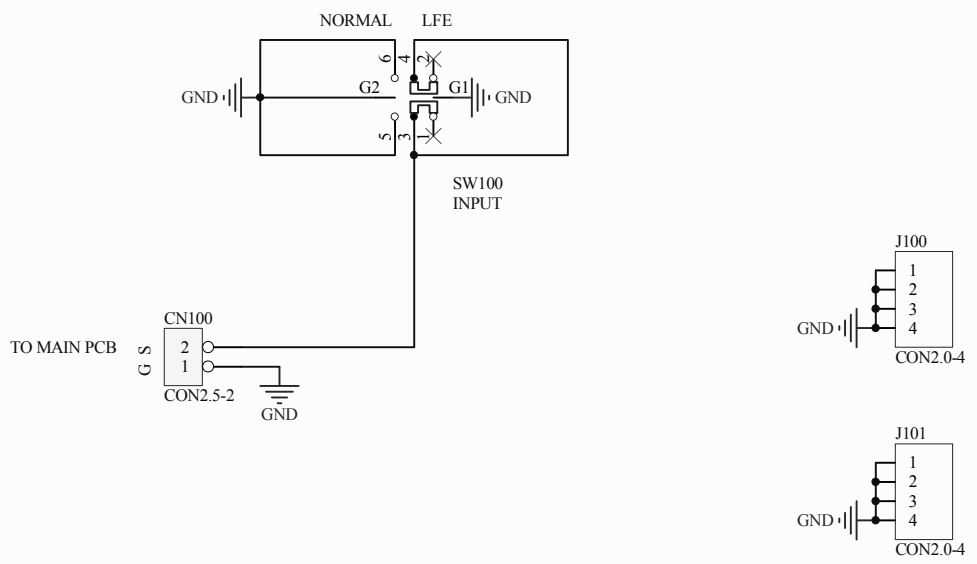

Title		
Size A4	Number	Revision
Date:	2010/8/3	Sheet of
File:	D:\HKTS210\DV1\LFE_SW.SchDoc	Drawn By:

1

2

3

4