

Assembly
and
Operation
of the



GENERAL COVERAGE RECEIVER

Model GR-78



HEATH COMPANY
BENTON HARBOR, MICHIGAN 49022

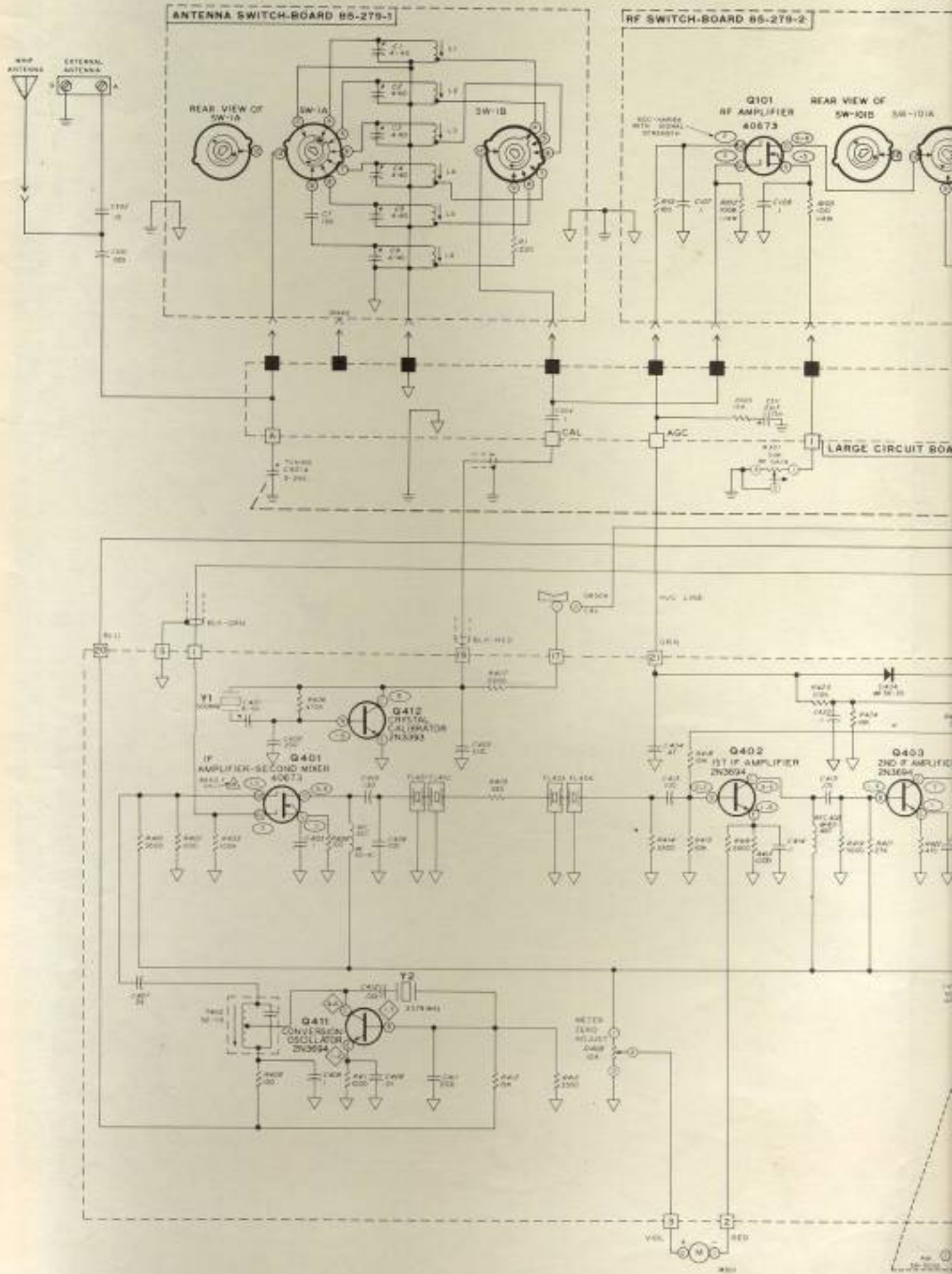

INTRODUCTION

The Heathkit Model GR-78 General Coverage Receiver is designed primarily for amateur and shortwave listener use. Many new circuit components and design concepts have been used to provide the user with a portable receiver having many features of higher priced units.

Six bands provide coverage from 190 kHz to 30 MHz, with double conversion on the 18 to 30 MHz band. An AM-CW/SSB switch enables the operator to select AM (amplitude modulation), CW (continuous wave), or SSB (single sideband) reception. The Receiver features calibrated bandspread for either the major shortwave broadcast bands or the amateur bands.

This compact, lightweight Receiver operates from an internal rechargeable nickel-cadmium battery for portable operation. The battery can be charged from a 120/240 VAC or 12 to 15 VDC power source. The battery recharges when the receiver is turned OFF and connected to one of these power sources.

For night readings, two front panel lamps are included with a spring-return Light switch to conserve battery life.

Other features include a collapsible carrying handle, built-in 500 kHz crystal calibrator, operation from a built-in whip antenna or external antenna, an automatic noise limiter circuit, flywheel tuning, and no-adjust ceramic IF filters for sharp selectivity. Plug-in, modular switch-boards contain the band switching circuits (antenna, RF amplifier, mixer, and oscillator) and provide easy assembly and service. The all solid-state circuitry includes thirteen silicon transistors, five of which are high gain FET's (field-effect transistors); and two germanium transistors. A separate FET product detector provides superior CW and SSB reception. A transformerless audio output circuit, combined with the solid-state circuits, minimizes current drain. The rugged construction and convenient operation are sure to provide you with many hours of dependable use and relaxed enjoyment.

Refer to the "Kit Builders Guide" for additional information on unpacking, parts identification, tools, wiring, soldering, and step-by-step assembly procedures.

INITIAL TESTS

NOTE: A VTVM or a VOM will be necessary to perform the resistance and voltage tests in this section of the Manual. A VOM having an impedance lower than 20 k Ω /volt should not be used for the tests.

RESISTANCE TEST

(X) Position all front panel switches and controls in the following positions:

BANDSPREAD—fully counterclockwise.
AF GAIN—OFF (black knob).
RF GAIN—fully clockwise (silver knob).
RCV-STBY—RCV position.
CAL—to position opposite CAL.
AM-CW/SSB—CW/SSB position.
AVC-MVC—MVC position.
ANL-OFF—OFF position.
BAND—band A position.
MAIN TUNING—fully counterclockwise.

(X) Position the METER ADJUST control on receiver circuit board—rotate control fully clockwise and then 1/4 turn counterclockwise when viewed from the rear of the Receiver. See Figure 4 (fold-out from Page 73).

Refer to Figure 1 (fold-out from Page 69) for the following steps.

NOTE: The following tests are performed to be sure that the Kit has been wired properly and that no short circuits exist in the supply circuits. If the proper results are not obtained, refer to the "In Case of Difficulty" section of the Manual.

(X) Connect the meter common lead to the chassis and touch the ohms lead to the 5-1/4" white hookup wire extending from hole 12 in the receiver circuit board as shown.

(X) The meter should indicate approximately 120 Ω .

(X) Turn on the Receiver. There should be no change in the meter indication. Then turn OFF the Receiver.

(X) Disconnect the ohms lead from the white wire.

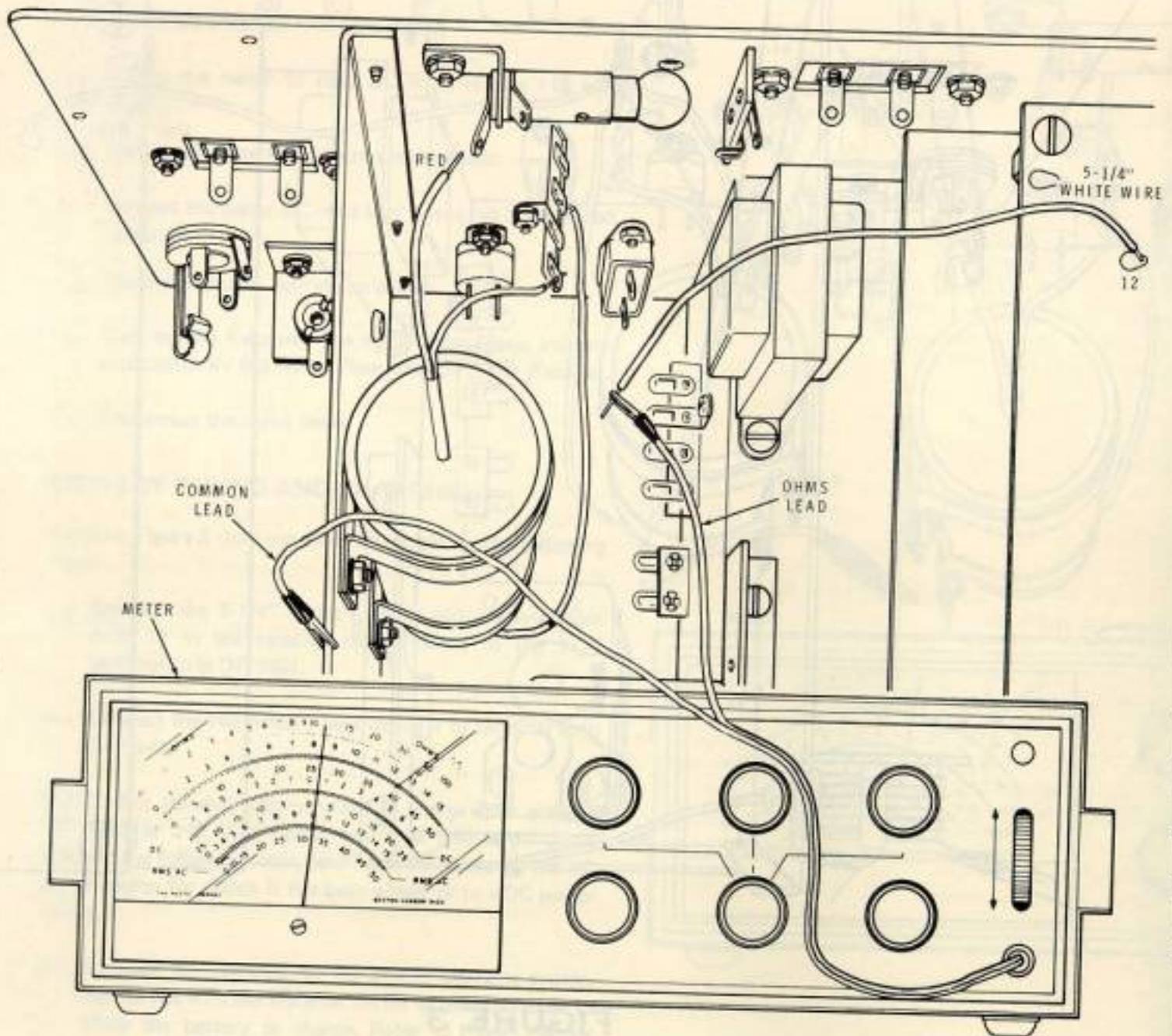

FIGURE 1

METER ADJUSTMENT AND NOISE TEST

Refer to Figure 4 (fold-out from Page 73) for the following steps.

NOTE: If you do not obtain the correct results in any of the following tests, turn OFF the Receiver and refer to the In Case of Difficulty section of the Manual.

- (1) Connect the speaker leads.
- (2) Turn on the Receiver. Adjust the METER ADJUST control with a small screwdriver so the meter needle is between the 0 (zero) and the 1 (one) on the scale. You should hear background noise. (You should also be able to increase and decrease the noise with the AF GAIN control.)
- (3) Now increase the AF GAIN control until the background noise is louder than the average listening level.
- (4) Touch the metal tip of a small screwdriver to the indicated end of the resistor shown in the Figure. Then place your finger against the metal shaft of the screwdriver. The background noise should increase slightly.
- (5) Place the AM-CW/SSB switch in the AM position. The background noise should decrease in volume.
- (6) Place the ANL-OFF switch in the ANL position. There should be a further decrease in the background noise volume.
- (7) Press the LIGHT switch. Both panel lamps should light.
- (8) Place the RCV-STBY switch in the STBY position. The background noise should stop. Then turn the switch to the RCV position.
- (9) Turn the Receiver off.

This completes the Initial Tests section of the Manual.

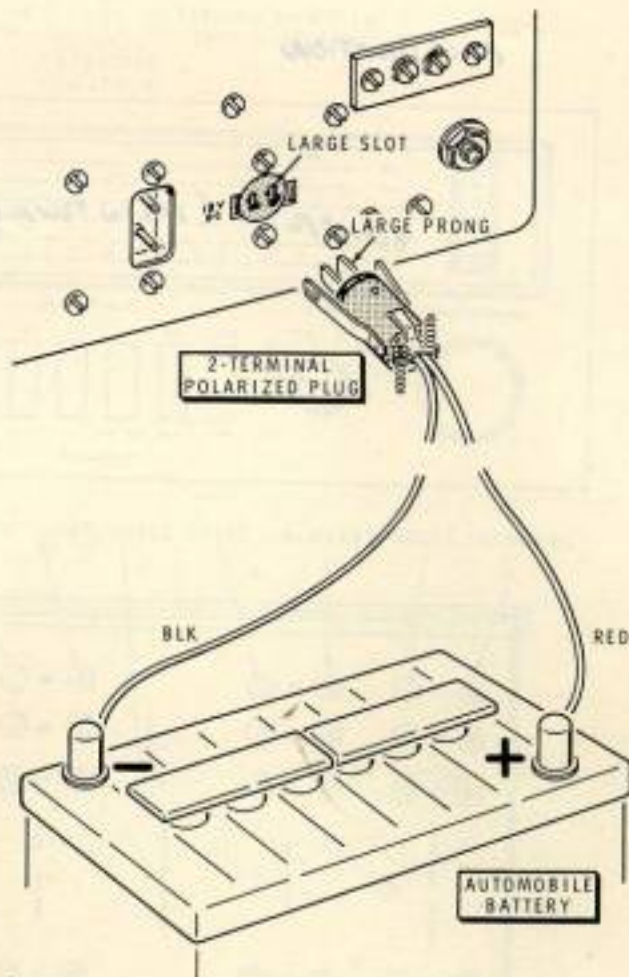

Figure 3-A

ALIGNMENT

Refer to Figure 4 for the following steps.

NOTE: In the following step, be sure the dial pointer lines up properly on the dial so the Receiver will be properly aligned. It may be necessary to adjust the position of the pointer slightly.

() Rotate the MAIN TUNING control fully clockwise. The pointer should line up with the ends of the six white lines at the right end of the dial. Crimp the dial pointer tabs on the dial cord as shown in inset drawing #1 on Figure 4. Now turn the MAIN TUNING dial fully counterclockwise. The main tuning capacitor plates should be fully meshed and the dial pointer should be even with the ends of the white lines at the left end of the dial. Check to make sure that this alignment is correct or the Receiver's calibration will be incorrect.

() Install the antenna in antenna bushing DD.

() Make sure the speaker wires are connected to the speaker.

() Position the cabinet top on the chassis by carefully sliding the cabinet top over the whip antenna and pushing it into position. Be careful the antenna grommet does not get pushed from the hole.

() Temporarily secure the cabinet top with two #6 x 1/4" sheet metal screws at the location shown in inset drawing #2 on Figure 4.

FIGURE 5

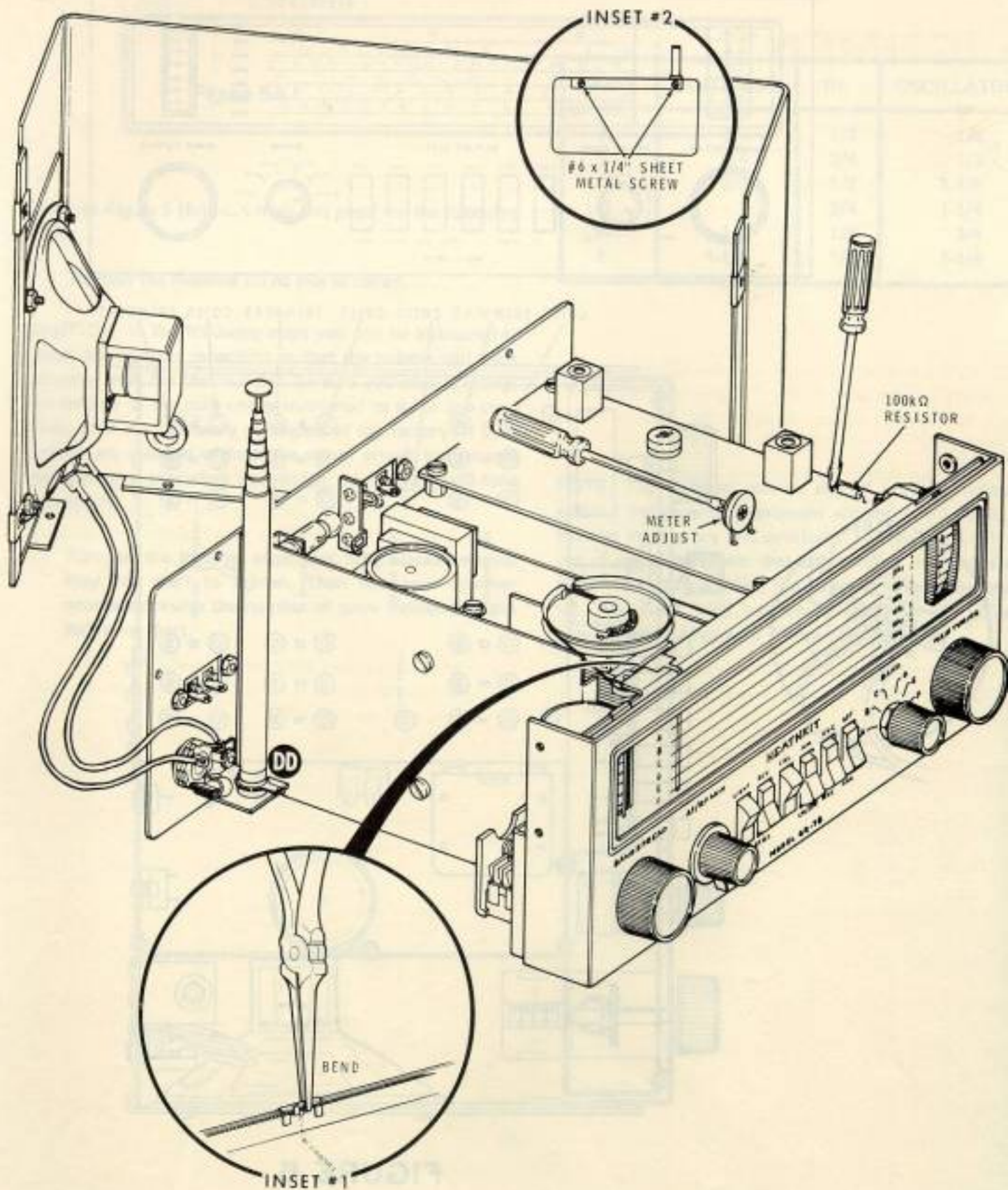

FIGURE 4

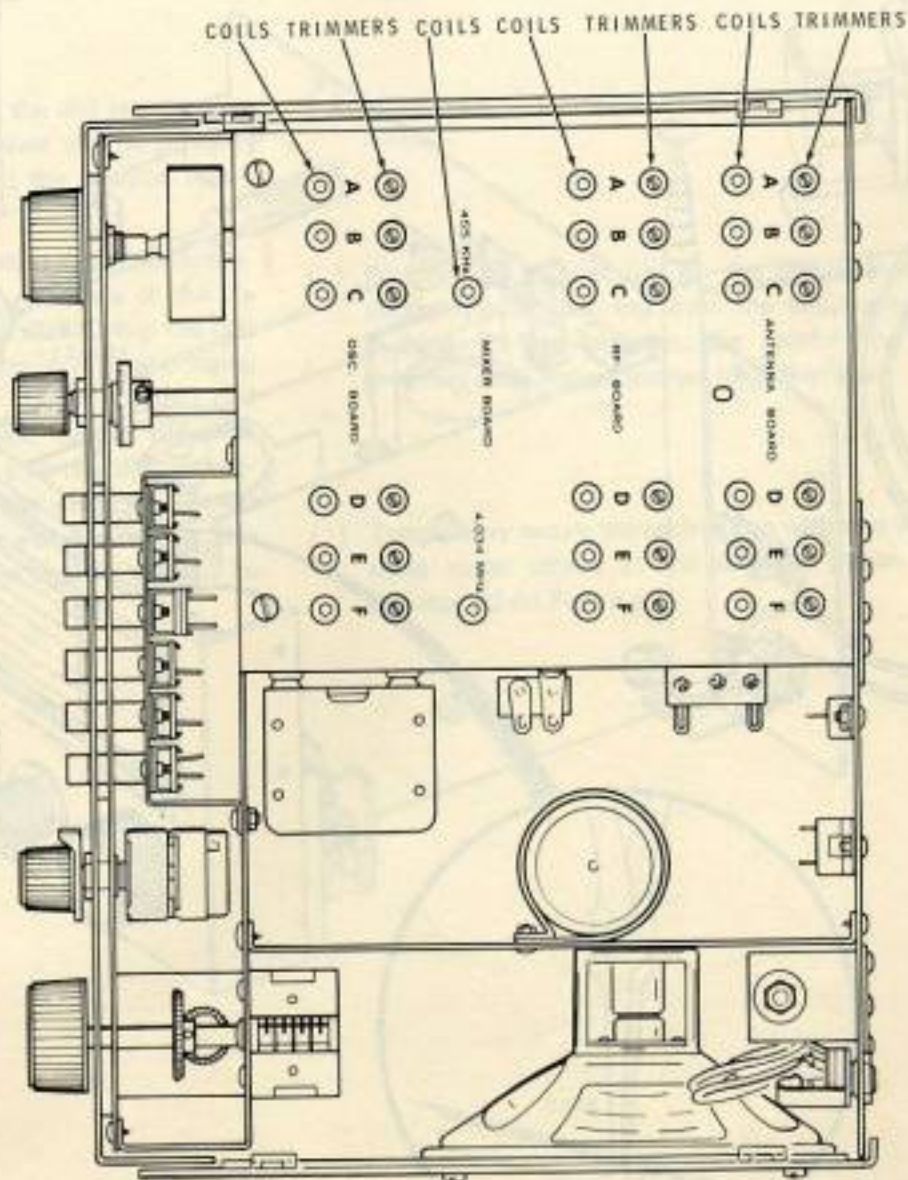
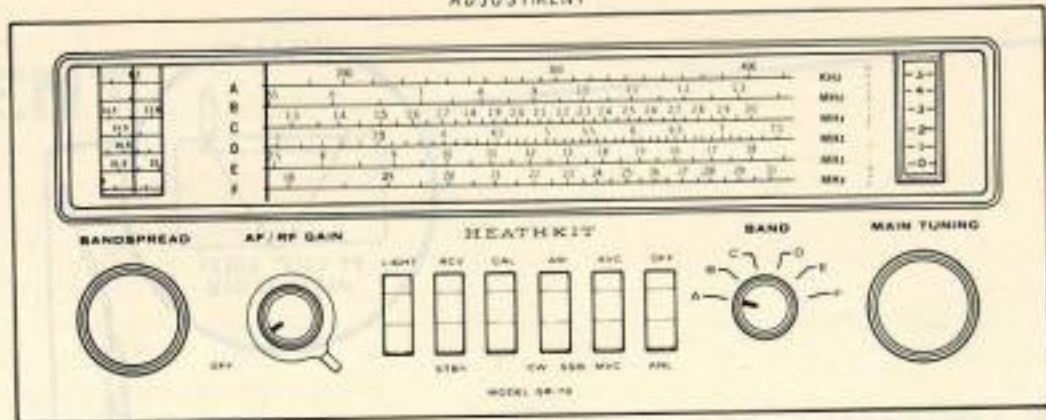
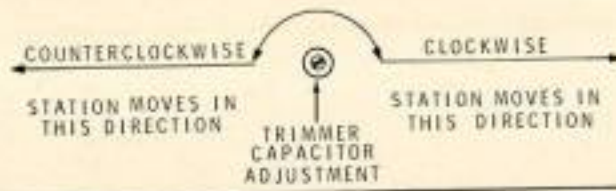

FIGURE 5

ALIGNMENT

Re

NC up ali po ()

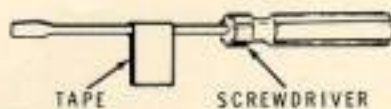

Figure 5A

Refer to Figure 5 (fold-out from this page) for the following steps.

- () Position the Receiver on its side as shown.

CAUTION: In the following steps you will be instructed to preset the trimmer capacitors so that the pointer will track properly with the dial number. Be sure you do not change the settings of the coils unless instructed to do so in a step. These coils are accurately prealigned at the factory. If their settings are changed without the use of proper instruments and alignment procedure knowledge, the Receiver will tune improperly.

- () Turn all the trimmer capacitors fully clockwise until they just start to tighten. Then turn each trimmer counterclockwise the number of turns indicated in the following chart.

This can be done quite accurately by placing a length of tape on a screwdriver as shown in Figure 5A.

BAND	ANTENNA	RF	OSCILLATOR
A	1/4	1/4	1/8
B	3/4	3/4	1/3
C	2/3	1/2	1-1/8
D	1	3/4	1-1/4
E	1/3	1/3	3/4
F	1-1/4	1/2	1-1/4

NOTE: The Receiver can be aligned with instruments or without instruments. Instrument alignment will result in an increase in accuracy and sensitivity. However, it requires the use of an RF generator that can deliver a modulated signal from 190 kHz to 30 MHz. If a generator is available, proceed to "Alignment With Instrument" on Page 77. Otherwise proceed with "Alignment Without Instruments."

ALIGNMENT WITHOUT INSTRUMENTS

The alignment without instruments is accomplished by using signals of known frequencies from radio stations. For best results, use an external antenna. If an external antenna is not already available, refer to "Antenna Installation" on Page 89.

In the following steps, only the trimmer capacitors will be adjusted. The coils are preadjusted and should not be changed. The ANT and RF trimmers will be adjusted for peak (strongest) signals using the Relative Signal meter in the Receiver. If the signal is too weak for a good meter indication, it will be necessary to adjust the trimmers for the loudest signal from the speaker. The OSC trimmers will be adjusted so that the received station appears at the proper frequency on the dial.

A station near the high end of the band should be selected for best results. Refer to the following information concerning station location and identification for bands A through F.

BAND A

Refer to Page 91 in this Manual and to Page 3 in the "Heathkit Logs and Charts" book supplied with the Kit. Select a weather information station in your area, or call a local airport to see if there is a low-frequency navigation beacon station operating near your location.

BAND B

Refer to your newspaper for some local broadcast stations that can be received in your area. For best results, choose a station near the high frequency end of the band.

BANDS C THROUGH F

These bands can be aligned by using broadcast stations between 1.3 to 1.6 MHz, or one of the following types of stations:

The United States Government operates two radio stations that give standard time and frequency signals: WWV in Boulder, Colorado, and WWVH in Hawaii. These stations transmit on the following frequencies: 2.5 MHz, 5 MHz, 10 MHz, 15 MHz, 20 MHz, and 25 MHz. The transmitted signals include a ticking sound (one-second time ticks), 440 Hz and 600 Hz audio tones, station identification in International Morse Code, voice, or voice and Morse Code time signals. These signals are usually best received early in the morning or late at night.

The other types of stations are a marine station, radiotelephone, an amateur radio or CB station. If you or a friend has a marine radiotelephone and know what the transmitting frequency is, it can be used to align band C. The amateur radio station can be used to align bands C through F. The CB station can be used to align band F only. If one of these two types of stations is used, the pointer on the Receiver main tuning dial must be set to the exact frequency of the transmitting station.

() Set the controls and switches as follows:

BANDSPREAD—Fully counterclockwise.
 AF GAIN—OFF.
 RF GAIN—Fully clockwise.
 RCV-STBY—RCV.
 CAL—To position opposite CAL.
 AM-CW/SSB—AM.
 AVC-MVC—AVC.
 ANL-OFF—OFF.
 BAND—Band B.
 TUNING—Fully clockwise.

() Turn the Receiver on and set the AF GAIN control to the desired listening level.

NOTE: It is desirable to align band B first, because of the greater number of stations to choose from. Align all six bands using the following chart.

TRIMMER CAPACITOR ADJUSTMENT	PROCEDURE FOR BANDS A, B, C, D, E, AND F.
<p style="text-align: center;">OSCILLATOR</p>	<p>Tune in a station with a known frequency near the high frequency (right) end of the band. Check the dial to see if the pointer is exactly on, above, or below the correct transmitting frequency of the station. If the pointer is exactly on the correct frequency, proceed to the antenna trimmer adjustment. If the pointer is above the correct frequency, proceed with step A. If the pointer is below the correct frequency, proceed to step B.</p> <p>NOTE: When turning an oscillator trimmer capacitor counterclockwise, the station will move toward the low frequency (left) end of the dial. Turning the oscillator trimmer capacitor clockwise will move the station toward the high frequency (right) end of the dial. In the following steps, you will be instructed to turn the trimmer capacitors counterclockwise or clockwise. Read each step and understand it before performing the step.</p> <p>A. If the pointer is above the correct frequency, turn the TUNING control counterclockwise until the pointer indicates the correct transmitting frequency of the station. Now turn the oscillator trimmer capacitor slowly in a counterclockwise direction until you can hear the station again. Now proceed to the antenna trimmer adjustment.</p> <p>B. If the pointer is below the correct frequency, turn the TUNING control clockwise until the pointer indicates the correct transmitting frequency of the station. Now turn the oscillator trimmer capacitor slowly in a clockwise direction until you can hear the station again. Now proceed to the antenna trimmer adjustment.</p> <p>Tune in the station for a maximum meter reading. Check to be sure the pointer is exactly over the correct transmitting frequency. If the pointer is not, repeat this adjustment.</p>
<p>NOTE: If you are not satisfied with the alignment at this time, you can turn the oscillator trimmer capacitor clockwise until it is snug. Then return to the start of the Alignment section and begin again.</p>	

ANTENNA	Adjust slowly for a maximum meter needle reading. When the meter needle is approaching full-scale (toward 5), turn the RF GAIN control counterclockwise until a half scale reading is obtained.
RF	Adjust slowly for a maximum meter reading.

- () Adjust the 455 kHz mixer coil for a maximum meter indication with the Receiver tuned to any station on band B.
- () Adjust the 4.034 MHz mixer coil for a maximum meter indication with the Receiver tuned to any station on band F. This should take no more than a full rotation in either direction. If you do not obtain this peak within one full rotation in either direction, you may

have the oscillator set to an image frequency. Return the oscillator trimmer capacitor until the same station is received at a different oscillator trimmer setting. Then repeak the mixer coil.

- () Turn the Receiver off.

This completes the "Alignment Without Instruments."

Proceed to the BFO Alignment on Page 80.

ALIGNMENT WITH INSTRUMENTS

NOTE: To perform the steps in this section, it is necessary to have a signal generator that is capable of delivering a modulated signal within a frequency range of 190 kHz to 30 MHz.

- () Refer to Figure 5 (fold-out from Page 74) for the following steps.
- () Set the controls and switches of the Receiver as follows:

BANDSPREAD—Fully counterclockwise.
 AF GAIN—OFF.
 RF GAIN—Fully clockwise.
 RCV-STBY—RCV.
 CAL—To position opposite CAL.
 AM-CW/SSB—AM.
 AVC-MVC—AVC.
 ANL-OFF—OFF.
 BAND—Band A.
 TUNING—Fully clockwise.

- () Refer to the inset drawing in the Figure and connect the generator to the EXTERNAL ANT terminals on the rear panel of the Receiver.

- () Be sure the whip antenna is fully collapsed.

- () Turn on the signal generator and allow it to warm up.

NOTE: In all alignment steps, as the adjustments peak, reduce the signal generator's output to the lowest possible level so as not to overload the Receiver. A good output level will result in a midscale reading on the signal strength meter.

Since the antenna (ANT), RF, mixer, and oscillator (OSC) coils have been pretuned at the factory, only a slight adjustment should be required to peak them. Perform the steps in the following Alignment Chart. Use the alignment tool furnished with the Kit to adjust the coils.

ALIGNMENT CHART

	TUNE SIGNAL GENERATOR TO:	SET BAND SWITCH TO:	SET RECEIVER DIAL TO:	ADJUST FOR MAXIMUM METER READING
1.	400 kHz NOTE: It may be necessary to use a high signal output from the generator for steps 1, 3, 6, 8, 11, 13, 16, 19, 21, and 25.	A	400 kHz	Band A OSC trimmer until tone is heard
2.	400 kHz	A	400 kHz	A ANTENNA trimmer A RF trimmer 455 kHz MIXER coil
3.	200 kHz	A	200 kHz	A OSC coil until tone is heard
4.	200 kHz	A	200 kHz	A ANTENNA coil A RF coil
5.	Repeat steps 1 through 4 until no further improvement is noticed.			
6.	1.3 MHz	B	1.3 MHz	B OSC trimmer until tone is heard
7.	1.3 MHz	B	1.3 MHz	B ANTENNA trimmer B RF trimmer
8.	.6 MHz	B	.6 MHz	B OSC coil until tone is heard
9.	.6 MHz	B	.6 MHz	B ANTENNA coil B RF coil
10.	Repeat steps 6 through 9 until no further improvement is noticed.			
11.	3.0 MHz	C	3.0 MHz	C OSC trimmer until tone is heard
12.	3.0 MHz	C	3.0 MHz	C ANTENNA trimmer C RF trimmer 455 kHz Mixer coil
13.	1.3 MHz	C	1.3 MHz	C OSC coil until tone is heard
14.	1.3 MHz	C	1.3 MHz	C ANTENNA coil C RF coil

TUNE SIGNAL GENERATOR TO:		SET BAND SWITCH TO:	SET RECEIVER DIAL TO:	ADJUST FOR MAXIMUM METER READING
15.	Repeat steps 11 through 14 until no further improvement is noticed.			
16.	7 MHz	D	7 MHz	D OSC trimmer until tone is heard
17.	7 MHz	D	7 MHz	D ANTENNA trimmer D RF trimmer
18.	Leave the Receiver set at 7 MHz. Tune the signal generator to 7.910 MHz and increase its output. A second signal should be audible; this is the image frequency. The signal should be down in magnitude when the circuit is correctly aligned. Tune the signal generator to 6.09 MHz. If the alignment signal is heard at this frequency, the oscillator is incorrectly set 455 kHz below the incoming signal. If this should occur, decrease the trimmer capacity by turning the Band D OSC trimmer counterclockwise until the second signal is heard and peaked on the meter.			
19.	3.0 MHz	D	3.0 MHz	D OSC coil until tone is heard
20.	3.0 MHz	D	3.0 MHz	D ANTENNA coil D RF coil
21.	Repeat steps 16, 17, 19, and 20 until no further improvement is noticed.			
22.	18 MHz	E	18 MHz	E OSC trimmer until tone is heard
23.	17 MHz	E	17 MHz	E ANTENNA trimmer E RF trimmer
24.	Leave the Receiver set at 17 MHz. Tune the signal generator to 16.09 MHz. A second signal should be audible; this is the image frequency. The signal should be down in magnitude when the circuit is correctly aligned. Tune the signal generator to 17.91 MHz. If the alignment signal is heard at this frequency, the oscillator is incorrectly set 455 kHz above the incoming signal. If this should occur, increase the trimmer capacity by turning the Band E OSC trimmer clockwise until the second signal is heard and peaked on the meter.			
25.	8 MHz	E	8 MHz	E OSC coil until tone is heard
26.	8 MHz	E	8 MHz	E ANTENNA coil E RF coil
27.	Repeat steps 22, 23, 25, and 26 until no further improvement is noticed.			
28.	30 MHz	F	30 MHz	F OSC trimmer until tone is heard

TUNE SIGNAL GENERATOR TO:	SET BAND SWITCH TO:	SET RECEIVER DIAL TO:	ADJUST FOR MAXIMUM METER READING
29. 30 MHz	F	30 MHz	F ANTENNA trimmer F RF trimmer 4.034 MHz mixer coil NOTE: If you do not obtain this peak within one full rotation in either direction, you may have the oscillator set to an image frequency. Retune the oscillator trimmer capacitor for another tone and then repeak the mixer coil.
30. 18 MHz	F	18 MHz	F OSC coil until tone is heard
31. 18 MHz	F	18 MHz	F ANTENNA coil F RF coil
32. Repeat steps 28 through 31 until no further improvement is noticed.			

This completes the Alignment With Instruments. Proceed to the BFO Alignment.

BFO ALIGNMENT

Refer to Figure 6 for the following steps.

- () Remove the cabinet top from the chassis.
- () Set the controls and switches as follows:
 - BANDSPREAD—fully counterclockwise.
 - AF GAIN—OFF.
 - RF GAIN—fully clockwise.
 - RCV-STBY—RCV.
 - CAL—to position opposite CAL.
 - AM-CW/SSB—AM.
 - AVC-MVC—AVC.
 - ANL-OFF—OFF.
 - BAND—to Band B position.
- () Make sure the speaker is connected to the chassis.
- () Turn on the Receiver.

- () Tune in a broadcast station with the TUNING control until a maximum reading is indicated on the meter.
- () Place the AM-CW/SSB switch in the CW/SSB position. A loud tone or squeal should be heard from the speaker.

NOTE: Do not rotate the slug more than one turn in either direction when making the following alignment.

- () Insert the alignment tool in the slug of BFO coil T401. Slowly rotate the alignment tool in one direction and listen for a decrease in pitch and volume of the tone. If the volume and pitch seem to increase, rotate the alignment tool in the opposite direction. Slowly rotate the alignment tool until the tone stops or sounds like an intermittent growl (zero beat).

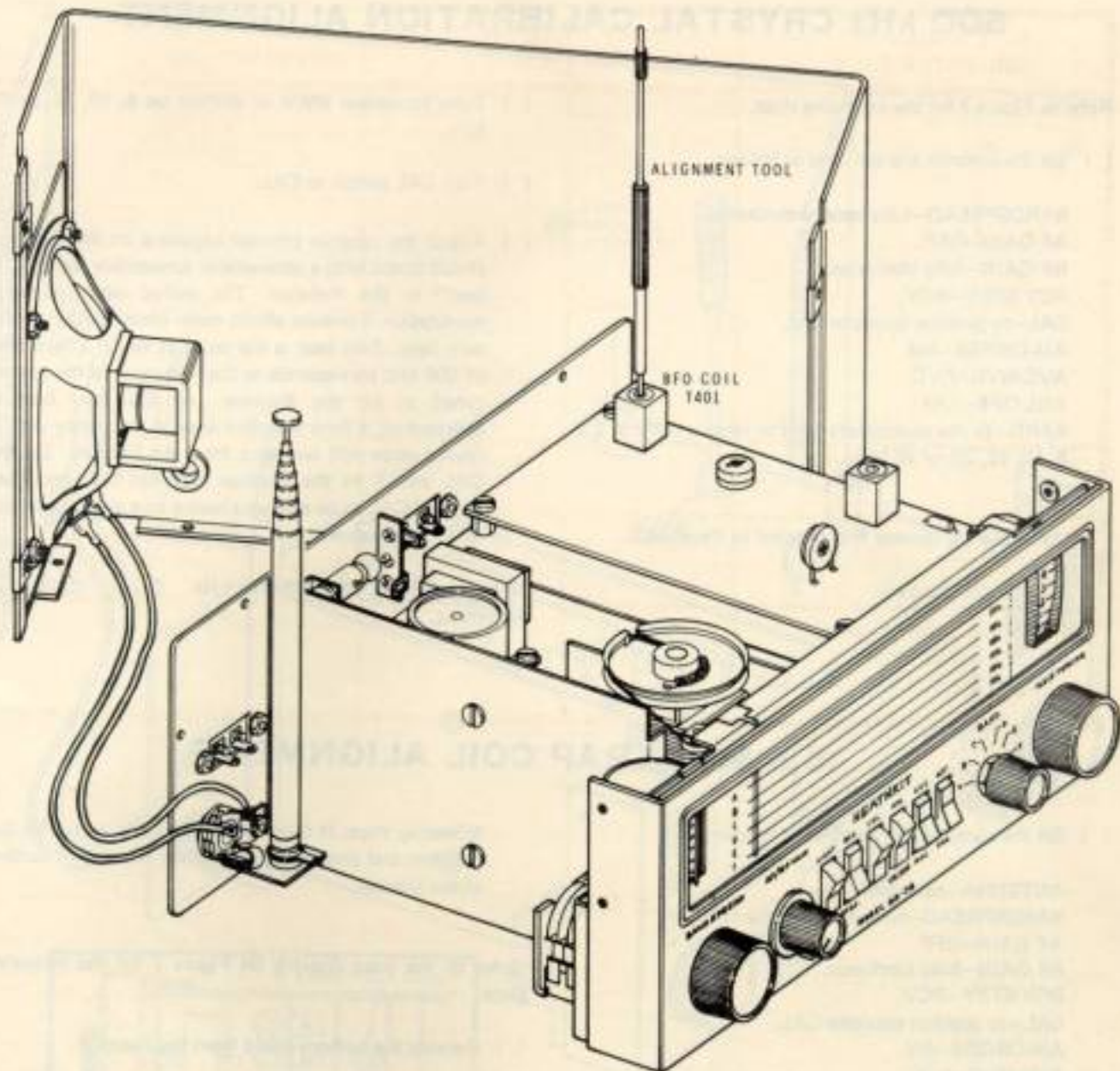

Figure 6

- () Tune through the zero beat signal with the TUNING control. The tone should be equal on both sides of the zero beat.
- () Place the AM-CW/SSB switch in the AM position. The growl should no longer be heard.

- () Turn off the Receiver.

This completes the BFO Alignment. Proceed to the "500 kHz Crystal Calibration Alignment" on Page 82.

500 kHz CRYSTAL CALIBRATION ALIGNMENT

Refer to Figure 7 for the following steps.

- () Set the controls and switches as follows:

BANDSPREAD—fully counterclockwise.
 AF GAIN—OFF.
 RF GAIN—fully clockwise.
 RCV-STBY—RCV.
 CAL—to position opposite CAL.
 AM-CW/SSB—AM.
 AVC-MVC—AVC.
 ANL-OFF—ANL.
 BAND—to the appropriate band to receive WWV at 2.5, 5, 10, 15, 20, or 25 MHz.

- () Make sure the speaker is connected to the chassis.
 () Turn on the Receiver.

- () Tune to station WWV or WWVH on 5, 10, 15, or 20 MHz.
 () Turn CAL switch to CAL.
 () Adjust the ceramic trimmer capacitor on the Receiver circuit board with a nonmetallic screwdriver for a "zero beat" in the Receiver. The period when no tone modulation is present allows easier identification of the zero beat. Zero beat is the point at which a harmonic of 500 kHz corresponds to the frequency of the station tuned in on the Receiver. As the zero beat is approached, a tone that decreases in frequency until it finally stops will be heard from the Receiver. Set the CAL switch to the position opposite CAL and then back to CAL to be sure you have a true zero beat. Turn OFF the Receiver.

This completes the "500 kHz Crystal Calibration Alignment."

5.5 MHz TRAP COIL ALIGNMENT

- () Set the controls and switches as follows:

ANTENNA—collapsed.
 BANDSPREAD—fully counterclockwise.
 AF GAIN—OFF.
 RF GAIN—fully clockwise.
 RCV-STBY—RCV.
 CAL—to position opposite CAL.
 AM-CW/SSB—AM.
 AVC-MVC—AVC.
 ANL-OFF—OFF.
 BAND—D.

- () Make sure the speaker is connected.
 () Turn the Receiver on and tune slowly back-and-forth between 5 MHz and 6 MHz. If there is a noted rise in the meter indication around 5.5 MHz, proceed with the

following steps. If there is no noted rise, turn OFF the Receiver and proceed to the "Final Assembly" section of the Manual.

Refer to the inset drawing on Figure 7 for the following steps.

- () Remove the bottom shield from the Receiver.
 () Adjust the 5.5 MHz trap coil for a null on the meter.
 () Turn off the Receiver.
 () Replace the bottom shield.

This completes the 5.5 MHz Trap Coil Alignment. Proceed to the "Final Assembly" section.

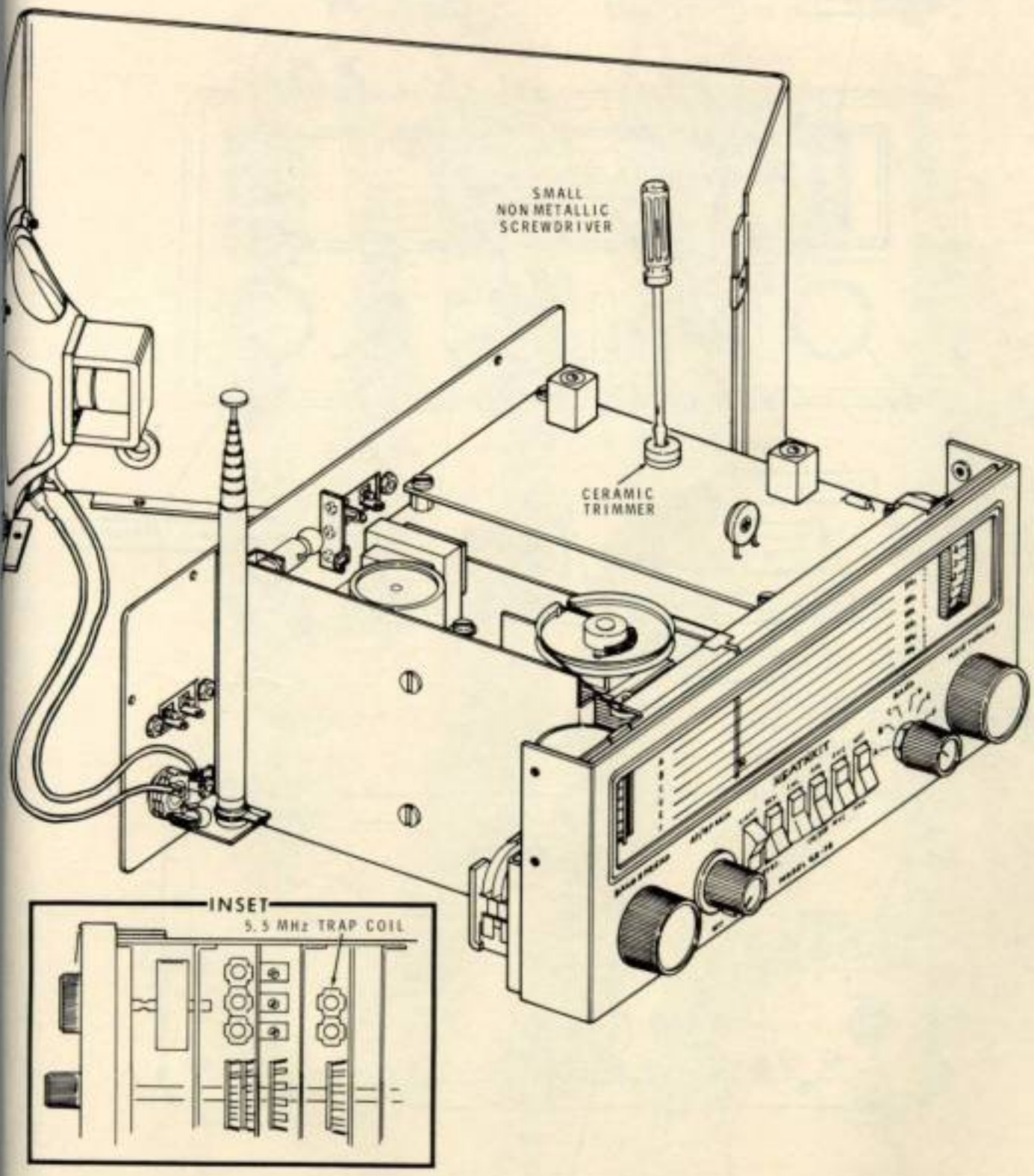

Figure 7

FINAL ASSEMBLY

Refer to Pictorial 6-20 for the following steps.

- () Carefully peel away the backing paper from the blue and white identification label. Then press the label onto the chassis in the position shown. Be sure to refer to the numbers on the label in any communications you have with the Heath Company about this kit.
- () Cut each of the two fiber spacers into three equal strips. Remove the paper backing from the strips and press the three strips on each end of the bezel as shown.
- () Install the bezel over the front panel with two 6-32 x 1/4" flat head screws in the lower holes of the bezel. Be careful not to scratch the bezel while completing the following steps.
- () Position the cabinet top over the chassis as shown. Then set the cabinet top on the chassis. Install 6-32 x 5/16" screws through the cabinet top and into the top holes of the bezel. Be sure the speaker wires are connected to the speaker.

Refer to Pictorial 6-21 for the following steps.

- () Position the Receiver as shown.
- () Mount the cabinet top to the rear panel with #6 x 1/4" sheet metal screws.

- () Position the cabinet bottom as shown in the Pictorial.
- () Position the Receiver in the cabinet bottom and make sure it is seated properly. Then mount the cabinet bottom to the cabinet top with four 6-32 x 1/4" screws.
- () Finish mounting the cabinet bottom with two #6 x 1/4" sheet metal screws into the rear panel.



Detail 6-21A

- () Refer to Detail 6-21A and mount a foot at each corner on the bottom of the Receiver. Peel away the protective paper on each foot and stick it into place as shown.
- () Remove the paper backing from the Warning label. Press the label onto the bottom of the cabinet bottom.

This completes the assembly of your General Coverage Receiver. Proceed to the "Operation" section of the Manual.

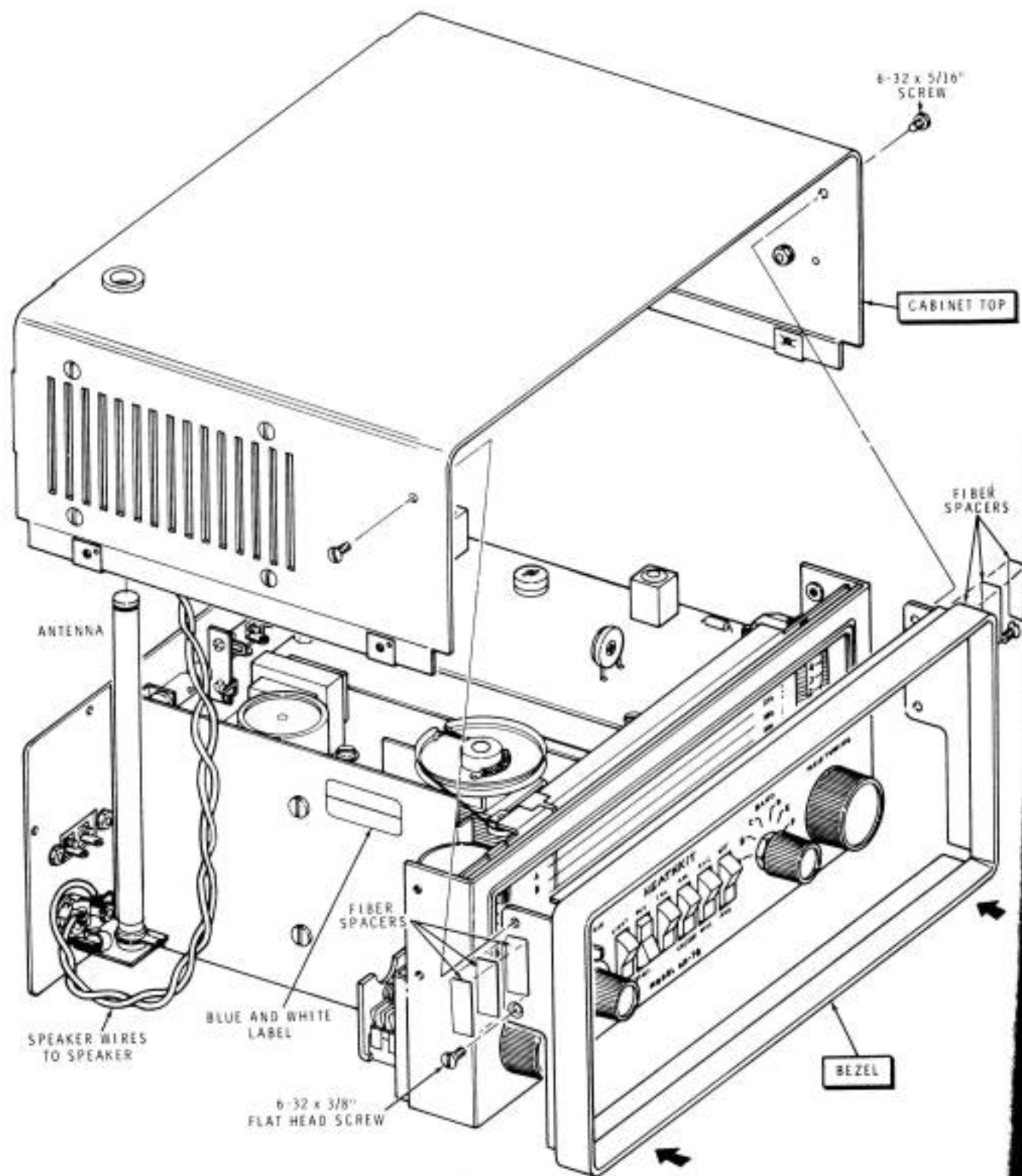

PICTORIAL 6-20

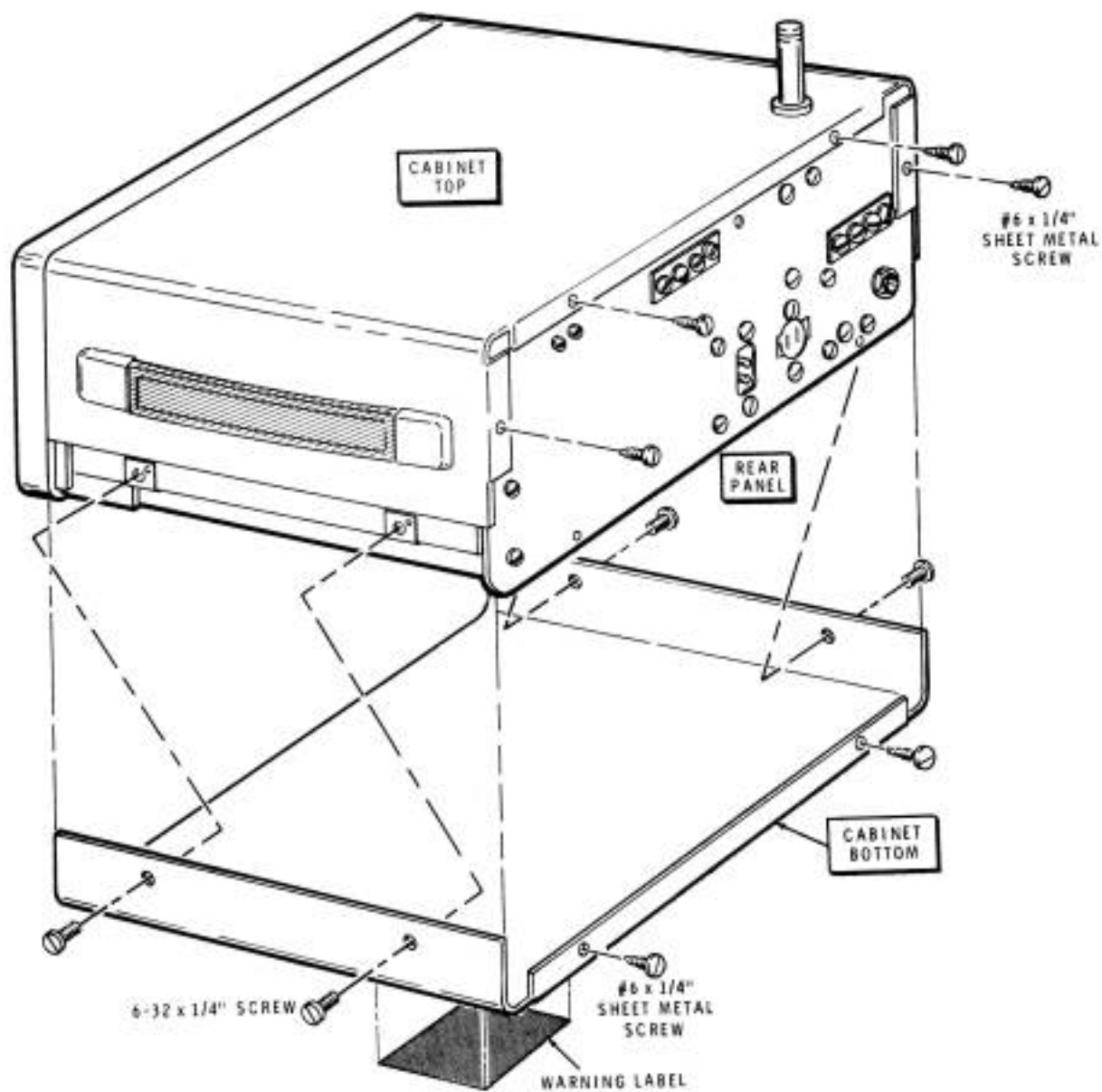

PICTORIAL 6-21

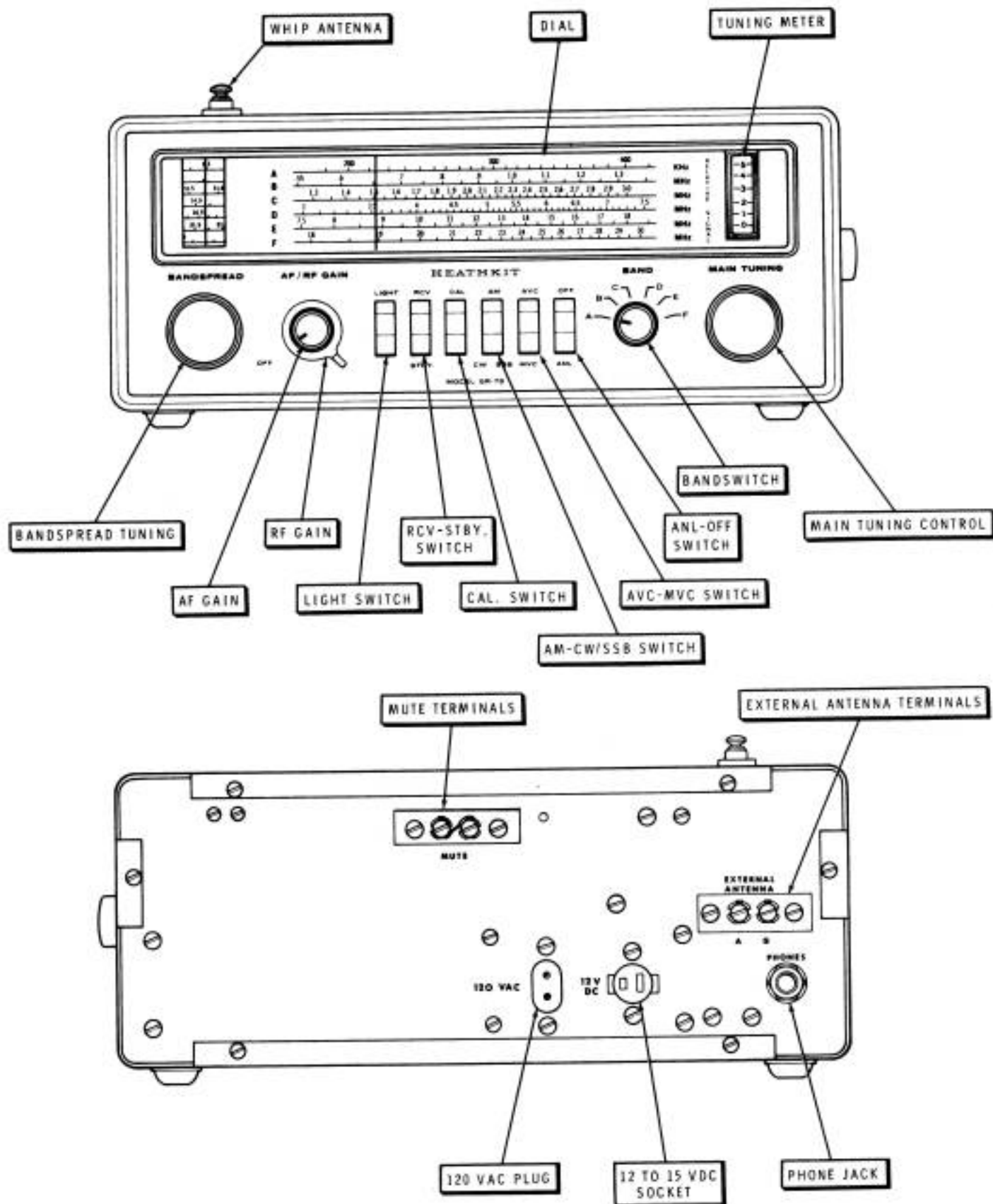

FIGURE 8

OPERATION

Before attempting to use the Receiver, carefully read the front and rear panel explanations to learn the functions of each of the controls, switches, and connectors.

FRONT AND REAR PANEL CONTROLS AND SWITCHES

Refer to Figure 8 (fold-out from Page 86) and the following information for a description of control and switch functions.

RF GAIN—Turns the Receiver on or OFF. Varies the loudness of the sound from the speaker or headphones by controlling the amount of audio amplifier gain.

RF GAIN—Varies the loudness of the sound from the speaker or headphones by controlling the amount of RF amplifier gain. NOTE: It may be desirable to set this control toward full counterclockwise on strong SSB signals for best fidelity. Normally it will be set at or near its full clockwise position.

MCW/SSB—Selects the following types of reception: AM (amplitude modulation), SSB (single sideband) or CW (continuous wave).

BAND—Selects one of six frequency bands: A, B, C, D, E, or

MAIN TUNING—Tunes the Receiver to the desired station.

BANDSPREAD—A fine tuning adjustment that is used in conjunction with the Main Tuning to help separate close-together signals on crowded frequency bands. This control is normally left in fully CCW position when not in use, since it affects the main dial calibration. To use the vibrated BANDSPREAD, set the MAIN TUNING dial to

one of the frequencies shown on the right side of the bandspread scale. Now tune with the Bandspread for expanded frequency coverage. It will seldom be necessary to use this control on Bands A and B.

AVC/MVC—Automatic Volume Control. The AVC circuit automatically adjusts the volume level to compensate for changes in signal strength. It also reduces the effect of "blasting" when a strong signal is tuned in. Leave this switch in the AVC position except when listening to very weak stations and then the MVC position should be used. This will allow manual volume control of the RF stage. Distortion will occur, however, if a strong station is received when the AF Gain control is fully clockwise.

ANL-OFF—Automatic Noise Limiter. Limits static and ignition noise when in the ANL position. Turn this switch to ANL only when noise limiter action is desired. When a strong signal is tuned in, turn the switch to OFF to prevent distortion.

RCV/STBY—This switch has two positions; RCV (receive) and STBY (standby). For normal Receiver operation, use the RCV position. To keep the Receiver ready for instant use, switch to the STBY position.

TUNING METER—Provides meter indication for precise signal tuning. AVC-MVC switch must be set to the AVC position to allow this meter to be used. For maximum meter deflection the RF GAIN must be in the full clockwise position.

OPERATION

Before attempting to use the Receiver, carefully read the front and rear panel explanations to learn the functions of each of the controls, switches, and connectors.

FRONT AND REAR PANEL CONTROLS AND SWITCHES

Refer to Figure 8 (fold-out from Page 86) and the following information for a description of control and switch functions.

AF GAIN—Turns the Receiver on or OFF. Varies the loudness of the sound from the speaker or headphones by controlling the amount of audio amplifier gain.

RF GAIN—Varies the loudness of the sound from the speaker or headphones by controlling the amount of RF amplifier gain. NOTE: It may be desirable to set this control toward full counterclockwise on strong SSB signals for best fidelity. Normally it will be set at or near its full clockwise position.

AM-CW/SSB—Selects the following types of reception: AM (amplitude modulation), SSB (single sideband) or CW (continuous wave).

BAND—Selects one of six frequency bands: A, B, C, D, E, or F.

MAIN TUNING—Tunes the Receiver to the desired station.

BANDSPREAD—A fine tuning adjustment that is used in conjunction with the Main Tuning to help separate close-together signals on crowded frequency bands. This control is normally left in fully CCW position when not in use, since it affects the main dial calibration. To use the calibrated BANDSPREAD, set the MAIN TUNING dial to

one of the frequencies shown on the right side of the bandspread scale. Now tune with the Bandspread for expanded frequency coverage. It will seldom be necessary to use this control on Bands A and B.

AVC/MVC—Automatic Volume Control. The AVC circuit automatically adjusts the volume level to compensate for changes in signal strength. It also reduces the effect of "blasting" when a strong signal is tuned in. Leave this switch in the AVC position except when listening to very weak stations and then the MVC position should be used. This will allow manual volume control of the RF stage. Distortion will occur, however, if a strong station is received when the AF Gain control is fully clockwise.

ANL-OFF—Automatic Noise Limiter. Limits static and ignition noise when in the ANL position. Turn this switch to ANL only when noise limiter action is desired. When a strong signal is tuned in, turn the switch to OFF to prevent distortion.

RCV/STBY—This switch has two positions; RCV (receive) and STBY (standby). For normal Receiver operation, use the RCV position. To keep the Receiver ready for instant use, switch to the STBY position.

TUNING METER—Provides meter indication for precise signal tuning. AVC-MVC switch must be set to the AVC position to allow this meter to be used. For maximum meter deflection the RF GAIN must be in the full clockwise position.

CAL—The calibrate switch turns on a 500 kHz crystal oscillator which provides calibrate signals every 500 kHz along the dial.

LIGHT SWITCH—A spring return switch that turns on the panel lamps. Returns to off by spring action to conserve battery power.

120 VAC Socket—Provides for connection to 120 VAC charging source (or 240 VAC, depending on how the Receiver is wired).

12 VDC Socket—Provides for connection for 12 to 15 VDC charging source.

PHONE JACK—For headphones or external speaker. The speaker is automatically disconnected when phone plug is inserted.

TUNING AM SIGNALS

The Receiver controls should be set as follows:

AF GAIN—On (turn clockwise to a comfortable listening level).

AM-CW/SSB—AM.

BAND SWITCH—Desired band.

RF GAIN—Full on (clockwise).

ANL-OFF—OFF (unless excess noise is present).

AVC-MVC—AVC (unless copying a weak signal).

Tune the signal to peak the reading on the tuning meter, then adjust AF GAIN control for desired output level. If the signal is extremely strong, turn the RF GAIN control counterclockwise to reduce possible distortion.

TUNING SSB OR CW SIGNALS

The Receiver controls should be set as follows:

AF GAIN—On (turn clockwise to a comfortable listening level).

AM-CW/SSB—CW/SSB.

BAND SWITCH—Desired band.

RF GAIN—Fully clockwise.

ANL-OFF—OFF (unless excessive noise is present).

AVC-MVC—AVC (unless copying a weak signal).

Tune in a SSB signal. The signal will have a "quacking" sound to it. Tuning these signals will require practice due to the narrow bandwidth of the signals. Very slow tuning is required, and the RF Gain may also have to be adjusted when listening to a strong station.

FIXED STATION RECEIVER

When using this Receiver with a transmitter, the muting terminals on the rear of the chassis should be used. These terminals are in the B+ lead to the audio preamplifier.

Using an external switch or a relay, the terminals 1 and 2 of the muting terminals should be open (disconnected) during the transmit period and closed (connected) during the receive period. The jumper wire used in normal operation must be removed for this type of operation.

In using this Receiver as the station receiver in close proximity to a transmitter, it is desirable to short the External Antenna terminal to ground during transmit conditions. Otherwise excessive signal to the "front end" of the Receiver may cause failure of the RF amplifier transistor.

You may notice a slight hum when the Receiver is turned on and the AC line cord is plugged in. This hum can be eliminated by disconnecting the line cord.

BATTERY LIFE AND RECHARGING

The Receiver operates from an internal rechargeable nickel-cadmium battery. The battery can be charged from 120 VAC, 240 VAC, or 12 to 15 VDC. Separate power cords are supplied for AC or DC charging voltages and each cord has a separate power socket on the rear panel. Only one power cord should be connected at a time. When either power cord is used, the battery is always being trickle charged when the Receiver is OFF. This keeps the battery fully charged.

Battery life can be extended if you use the dial lamp only when necessary, and then only briefly. To check for a weak battery, tune to a radio station of moderate strength. Then, while watching the TUNING meter, press the LIGHT switch. If the meter needle drops more than 1/8", the battery needs recharging.

Depending on the charging voltage, the battery is always being charged at 20 to 25 mA when the built-in trickle charging circuit is connected to 120 VAC, 240 VAC, or 12 to 15 VDC with the front panel switch OFF. At this charge rate, a full battery charge will be maintained if the Receiver is used an average of 8 hours daily at a normal listening level. If the Receiver will not be used for 30 days or more, disconnect the external power source.

The battery is electrically divided in half for charging from AC. When the AC power cord is plugged into a power outlet, the AC voltage from the secondary of transformer T501 is applied through diode D501 on one-half cycle to charge

one-half of the battery. On the other half cycle, the voltage is applied through diode D502 to charge the other half of the battery.

The battery can also be charged from 12 to 15 VDC. When the DC power cord is connected to a power source, the DC voltage is applied through diode D503, pilot lamp PL-503 and resistor R503 to the battery. The diode protects the battery from being discharged in case the external DC charging voltage is connected backwards. The pilot lamp (seen through the small hole in the rear panel) and resistor function primarily as a DC charging current limiter. The lamp may not necessarily be lit.

Charging From an AC Power Source

Plug the AC power cord into a 120 VAC or 240 VAC power outlet depending how the Receiver was wired. The battery will charge automatically as long as the power cord is plugged in and the Receiver is turned off. If the battery was completely run down (approximately 9.0 volts), this process takes about 36 hours. If it was not completely run down, approximately 1-1/2 hours of charging for each hour the battery was used since the last charge will restore the battery to full charge. However the battery should be recharged occasionally for a period of 24 hours to insure that all the cells of the battery reach full charge. The battery can be trickle charged for several days without being harmed. A full charge can be accomplished only if the Receiver is turned off.

Charging From a DC Power Source

CAUTION: If the Receiver is connected to a 12 to 15 VDC POSITIVE GROUND power source, the Receiver chassis must not touch the chassis or ground side of the power source.

Connect the DC power cord to a 12 to 15 VDC power source. When the front panel switch is OFF the battery will charge automatically at the given rate as long as the power cord is connected to the power source. Depending on the type of power source; such as a storage battery, or a car or boat generator; the charging voltage can vary from 12 VDC to 15 VDC. If the battery was completely run down (approximately 9.0 volts), this process takes from 30 hours for a 13.5 VDC power source to 20 hours for a 15 VDC power source. If it was not completely run down, approximately 1-1/2 hours of charging for each hour the battery was used since the last charge will restore the battery to full charge. However, the battery should be fully recharged occasionally for approximately 24 hours to insure

that all the cells of the battery reach full charge. The battery can be trickle charged for 30 days without being harmed. The front panel switch must be OFF to accomplish a full charge in the above given times.

VOLTAGE	CHARGING RATE
12 VDC	15 mA
13.5 VDC	25 mA
15 VDC	35 mA

ANTENNA INSTALLATION

An external antenna and a ground system are necessary for good longwave reception on Band A and good shortwave reception on Bands C, D, E, and F. The antenna will also greatly improve reception on Bands B and C, the standard broadcast bands.

The following information includes three types of antennas: long-wire, dipole, and inverted-V dipole. Read the information concerning each antenna and then follow the installation instructions for the one that best suits your needs. The Heathkit Model GRA-72 SWL Receiving Antenna would make an adequate long-wire, dipole, or inverted-V antenna.

Antenna Types

Dipole—This is a directional antenna designed for shortwave reception. The directional feature means that signals are received best when the antenna is turned broadside to the transmitting station (when the ends of the antenna do not point toward the transmitting station).

Inverted-V Dipole—This is a nondirectional antenna designed for shortwave reception. The nondirectional feature means that this antenna will receive signals equally well from all directions. Therefore, it is often possible to receive more stations with this antenna than you would with the straight dipole antenna.

Dipole or Inverted-V Dipole Installation

An antenna 100 feet long will give good reception from 3 to 15 megahertz, with the best reception being near 5 megahertz. Use the following formula if you want to compute the length of an antenna that will have its best reception at another frequency.

$$\text{length (feet)} = \frac{468}{\text{frequency (megahertz)}}$$

The following material is needed for this antenna installation:

Antenna — A length of bare wire. NOTE: The length of wire should be slightly longer to allow for fastening to the insulators. The finished antenna length should be exactly as per the formula.

Lead-in — RG-58AU or RG-174U coaxial cable. The length depends upon the height of your antenna and the location of your Receiver.

Ground wire — Same type as antenna wire. The length depends upon the distance between the Receiver and the grounding surface.

Insulators — Three ceramic or glass, approximately 2-1/2" long.

Ground rod — One 6 or 8 foot length, 3/8" diameter. NOTE: A ground rod is not needed if an alternate ground, such as a cold water pipe in your house is used.

Clamp — One for ground rod.

Lightning arrester — One for lead-in cable.

NOTE: For dipole installation, refer to steps 1A through 12.

For inverted - V dipole, refer to steps 1B through 12.

1A. Locate two supports that are fairly high from the ground and 50 to 100 feet apart. One support could be your house and the other a pole. A dipole antenna can be suspended between the two supports as shown in Figure 9.



Figure 9

- 1B. Locate three supports that are fairly high off the ground. The center support should be 20 to 100 feet from the ground and both end supports over 10 feet from the ground. Note that the angle between the center support and the antenna wires should be over 45 degrees. An inverted - V antenna can be suspended between the three supports as shown in Figure 10.
2. Cut the antenna wire in half. Fasten one end of one wire to an insulator. Then fasten one end of the other wire to the other end of the same insulator.

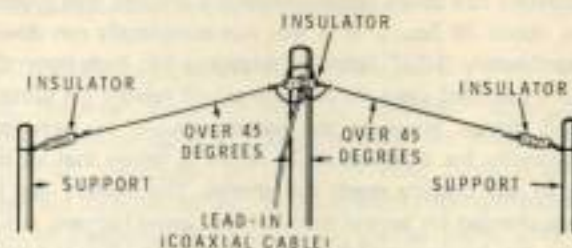

Figure 10

3. Fasten the remaining two insulators to the ends of the antenna wire.
4. Prepare one end of the lead-in cable so that you will have a 3" center lead and a 3" shield lead.
5. Refer to Figure 11 and fasten the prepared end of the cable to the center insulator (for support). Then solder the center lead of the cable to the antenna wire on one side of the insulator. Solder the shield to the antenna wire on the other side of the insulator.
6. Use this step for inverted - V dipole only. Fasten the insulator just prepared to the center support.
7. Fasten an insulator to each end support.
8. Route the lead-in wire into the house at your Receiver location.

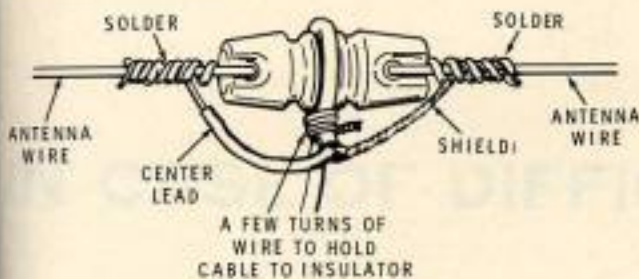

Figure 11

9. Prepare the end of the lead-in and connect it to the EXTERNAL ANTENNA terminals on the back of the Receiver: Connect the center lead to the A terminal and the shield lead to the G terminal.
10. Drive the ground rod into the ground leaving about 6" sticking up above the soil. Pick a convenient location as close as possible to the Receiver. This will enable you to keep the ground wire that will be installed in the following step, as short as possible.
11. Attach a wire from EXTERNAL ANTENNA terminal G to the clamp on the ground rod.
12. Follow the instructions that come with the lightning arrester and fasten it to the lead-in cable and ground.

RECEPTION GUIDE

BAND	FREQUENCY	TIME	ZONE
80 M	3.5 MHz	Morning, evening	Local (Amateur)
49 M	6 MHz	Evening	Latin America and Europe
41 M	7 MHz	Evening	Europe
40 M	7 MHz	Late afternoon, Evening	Europe
40 M	7 MHz	Morning	United States (Amateur)
31 M	9 MHz	Morning	Asia and Australia
31 M	9 MHz	Afternoon	Europe and Africa
31 M	9 MHz	Evening	Europe and Latin America
25 M	11 MHz	Morning	Asia and Australia
25 M	11 MHz	Evening	Latin America
20 M	14 MHz	Late morning, afternoon	United States, Foreign, (Amateur)
19 M	15 MHz	Late morning, afternoon	Europe and North America
19 M	15 MHz	Evening	North and Latin America
16 M	17 MHz	Afternoon	Europe
	17 MHz	All day	United States
	17 MHz	Evening	South America
13 M	20 MHz	Afternoon	Europe
	20 MHz	All day	United States
	20 MHz	Evening	South America
11 M	27 MHz	All day	Local (Citizen's Band)
10 M	28 MHz	Morning	Europe
	28 MHz	Evening	Central America, United States (Amateur), Asia

These reception conditions prevail in the spring and fall of the year. They are also subject to varying atmospheric conditions, sunspot activities, and to some extent, weather conditions. In the winter, reception generally will be best on the lower frequency bands. In summer, reception will be better on higher frequency bands. In addition to the above information, you will find the Heathkit Logs And Charts book, included with your Kit, helpful in locating stations. NOTE: Your Receiver will not receive all of the stations included in the book. The book has been provided only as a reference.

IN CASE OF DIFFICULTY

This section of the Manual is divided into two parts. The first part, titled General Troubleshooting Information, describes what to do about any difficulties that may occur right after the Receiver is assembled. The second part, a Troubleshooting Chart, lists a number of possible difficulties

that could arise, and lists several possible causes.

Before starting any troubleshooting procedure, try to narrow the problem down to a specific area by trying the various functions of the Receiver.

GENERAL TROUBLESHOOTING INFORMATION

The following paragraphs deal with the types of difficulties that may show up right after a kit is assembled. These difficulties are most likely to be caused by assembly errors or faulty soldering. These checks will help you locate any error of this type that might have been made.

NOTE: In an extreme case where you are unable to resolve a difficulty, refer to the "Customer Service" information inside the rear cover of the Manual. Your Warranty is located inside the front cover.

1. Recheck the wiring. It is frequently helpful to have a friend check your work. Someone who is not familiar with the unit may notice something consistently overlooked by the builder.
2. About 90% of the kits that are returned for repair do not function properly due to poor connections and soldering. Therefore, many troubles can be eliminated by reheating all connections to make sure that they are soldered as described in the soldering section of the Kit Builders Guide.
3. Check the values of the parts. Be sure that the proper parts have been wired into each circuit, as shown in the pictorial diagrams and as called out in the wiring instructions.
4. Check for bits of solder, wire ends, or other foreign matter which may be lodged in the wiring.
5. Check for solder bridges between circuit board foils.
6. If, after careful checks, the trouble is still not located and a voltmeter is available, check the voltages in the circuits of your General Coverage Receiver against those shown on the Voltage Charts (Pages 103, 104, and 105) and Schematic (fold-out from Page 117). **NOTE:** All voltage readings were taken with an 11 megohm input voltmeter. Voltages may vary as much as $\pm 20\%$.
7. A review of the Circuit Description and a study of the Schematic Diagram may also help you locate a difficulty in the Receiver. Refer to the X-Ray Views of the circuit boards on Page 101 to help locate parts.

TROUBLESHOOTING CHART

DIFFICULTY	POSSIBLE CAUSE
Initial resistance check shows short circuit.	<ol style="list-style-type: none"> 1. Trimmers installed upside down. 2. Power supply B+ circuit shorted to ground. 3. Solder bridge between foils on circuit board. 4. Trimmer capacitors shorted to adjacent foils.
Receiver dead.	<ol style="list-style-type: none"> 1. Shorting springs not removed from Q101, Q201, or Q401. 2. Dead battery, requires charging. 3. Shorted B+ circuit. 4. Mute jumper not connected. 5. RCV/STBY switch in STBY position.
Low sensitivity.	<ol style="list-style-type: none"> 1. Low battery voltage, requires charging. 2. Receiver misaligned. 3. Trimmer capacitors shorted to adjacent foils. 4. Transistors Q101, Q201, Q301, Q401, and/or Q405 installed incorrectly.
Sound distorted.	<ol style="list-style-type: none"> 1. Low battery voltage. 2. Received signal distorted. 3. AF or RF gain controls set too high. 4. Transistors Q408 or Q409.
Distortion on strong stations.	<ol style="list-style-type: none"> 1. See "Sound distorted." 2. AVC switch in MVC position. 3. Too close to station.
Noisy when tuning or dead at one end on all bands.	<ol style="list-style-type: none"> 1. Tuning capacitor plates bent or dirty.
Single-sideband signals sound low or high pitched.	<ol style="list-style-type: none"> 1. Signal not tuned in properly. 2. Transformer T401 not aligned properly.
A low howl from the speaker on strong stations, especially on Bands E and F.	<ol style="list-style-type: none"> 1. Flat braid connected to tuning capacitor not flexible. 2. Lead from bandspread capacitor to tuning capacitor too long.
Tuning meter inoperative.	<ol style="list-style-type: none"> 1. AVC switch in MVC position. 2. Resistor R408 misadjusted. 3. Meter.
Dim panel lights.	<ol style="list-style-type: none"> 1. Low battery voltage. 2. Resistor R504 wrong value.

SPECIFICATIONS

Frequency Coverage	Band A: 200 kHz to 400 kHz Band B: 550 kHz to 1300 kHz Band C: 1.3 MHz to 3.0 MHz Band D: 3.0 MHz to 7.5 MHz Band E: 7.5 MHz to 18.0 MHz Band F: 18.0 MHz to 30 MHz
Meter	Indicates relative signal strength
Intermediate Frequency	Band A through E: 455 kHz Band F: 455 kHz and 4034 kHz

	<u>AM</u>		<u>CW/SSB</u>	
	<u>Low End</u>	<u>High End</u>	<u>Low End</u>	<u>High End</u>
Sensitivity*	Band A: 10 μ v	3 μ v	6 μ v	2 μ v
	Band B: 3	1	2	.7
	Band C: 3	.6	1.5	.4
	Band D: 2	.3	2	.2
	Band E: 3	.2	3	.2
	Band F: 2	.3	2	.2

Image Rejection	Band A 65 dB or more Band B 60 dB or more Band C 48 dB or more Band D 35 dB or more Band E 25 dB or more Band F 35 dB or more
-----------------------	--

Selectivity 7 \pm 1 kHz wide, 6 dB down

Audio Output 300 milliwatts

Crystal Calibrator 500 kHz

*Signal level for 10 dB signal-plus-noise to noise ratio.

Battery Charge Rate

The battery is always being charged at 20 to 25 mA when the built-in trickle charging circuit is connected to an external power source with the Receiver turned off. A full battery charge will be maintained if the Receiver is connected to an external power source and used an average of 8 hours daily at a normal listening level.

<u>VOLTAGE</u>	<u>CHARGE RATE</u>
120/240 VAC	22 mA
12 VDC	15 mA
13.5 VDC	25 mA
15 VDC	35 mA

Battery Drain

65 mA at 50 mW audio output level.
 40 mA at no audio output.
 When the Receiver is not connected to an external power source, battery life at full charge is approximately 8 hours at a normal listening level.

Panel Controls

- Bandspread
- AF Gain-Off
- RF Gain
- Panel light
- RCV-STBY
- CAL
- AM-CW/SSB
- AVC-MVC
- ANL-OFF
- Bandswitch
- Main Tuning

Rear Panel

- Muting
- External Antenna
- 12 VDC Receptacle
- 120 VAC Receptacle
- Phone Jack

Weight

10 lbs.

Overall Size

6-1/4" high x 11-1/2" wide x 9" deep

The Heath Company reserves the right to discontinue products and to change specifications at any time without incurring any obligation to incorporate new features in products previously sold.

CIRCUIT DESCRIPTION

Refer to the Block Diagram (fold-out from Page 99) and to the Schematic Diagram (fold-out from Page 117) while reading this description. The Bandswitch will be considered to be in Band A position.

RF AMPLIFIER

The RF signals received from the built-in whip antenna, or external antenna, are coupled to the input tuned circuit for Band A. This tuned circuit consists of antenna coil L1, trimmer capacitor C1, and the first section of tuning capacitor C501A. The input signal is then coupled from a tap on coil L1 to gate 1 of field effect transistor Q101. Bias voltage for Q101 is obtained from the AVC amplifier and is applied to gate 2. Source resistor R103 and RF Gain control R501 provide the proper drain current for normal operation (with R501 fully clockwise). Turning the RF Gain control changes the amount of current flowing, thereby varying the gain. The amplified signal from Q101 is fed to a tap on RF coil L101, which along with trimmer capacitor C101 and tuning capacitor C501B form the input tuned circuit of first mixer stage Q201.

FIRST MIXER

Transistor Q201 is a dual-gate silicon field effect transistor (FET). The mixer features excellent freedom from cross modulation or overloading and oscillator "pulling" on strong signals. The amplified signal from Q101 is applied to gate 1 of Q201 through capacitor C111. The local oscillator signal from Q301 is applied to gate 2 of Q201, which is biased by resistors R203 and R204. Source resistor R205 establishes the DC operating point. The incoming signal and the oscillator signal are heterodyned (mixed) in Q201, resulting in the IF frequency and mixer products. On Bands A through E, the output of Q201 is fed to a tap on coil L201 which resonates with capacitor C201 to provide a 455 kHz output signal. On Band F, the output from Q201 is fed to coil L202, which resonates with capacitor C202 to provide a 4.034 MHz output signal.

SECOND MIXER/IF AMP

The output from the first mixer, Q201, is coupled through capacitor C205 to gate 1 of field effect transistor Q401, which operates as an IF amplifier on Bands A through E and as a mixer providing double conversion on Band F. Operating bias is provided on gate 2 by resistors R401 and R402. When the bandswitch is in Band F position, a 3.579 MHz injection signal from Conversion Oscillator Q411 is applied to gate 2 of Q401. This signal combines with the 4.034 MHz signal from the first mixer, Q201, and results in an output signal of 455 kHz plus the mixer product frequencies. This output signal is coupled through capacitor C410 to ceramic passband filters FL401 through FL404. These filters shape the passband and attenuate all frequencies, except the IF frequency of 455 kHz. This IF signal is coupled to the base of the first IF Amplifier stage, Q402.

Bias for Q402 is obtained from a voltage divider network, consisting of resistors R415 and R418. Resistor R431 supplies an AVC (automatic volume control) voltage from the AVC Amplifier, Q404, which corresponds to changes in the incoming signal strength.

IF amplifier stage Q402 also contains the circuit for the relative signal strength meter. The meter is connected between the emitter of Q402 and the meter zero adjust control R408. Control R408 is connected to a positive DC supply voltage, and it can be adjusted to give a zero indication on the meter. When the average level of the incoming RF signal increases, the AVC voltage decreases, causing the positive voltage at the base of transistor Q402 to decrease. This causes the current flowing through Q402 to decrease and causes a corresponding voltage drop across the emitter resistor R417. This varying voltage is read on the meter, which monitors AVC action and provides a visual method of indicating relative signal strength.

The amplified IF signal from Q402 is coupled through capacitor C415 to the base of second IF Amplifier Q403. Base bias for Q403 is obtained by a voltage divider consisting of resistors R419 and R421. Transistor Q403 is stabilized by emitter resistor R422 which is bypassed by capacitor C416 to ground. The amplified output of Q403 is applied across the collector load resistor R426 and is coupled through capacitor C418 to the following stages.

LOCAL OSCILLATOR

The local oscillator, Q301, is a single-gate silicon field effect transistor (FET). The oscillator tuned circuit consists of coil L301, trimmer capacitor C301 and tuning capacitor C501C. Oscillator injection voltage is coupled through capacitor C308 to gate 2 of mixer Q201. This Hartley oscillator is designed to operate 455 kHz higher in frequency than the received radio signal on Bands A, B, C, and D, 455 kHz lower in frequency on Band E; and 4.034 MHz higher on Band F.

AVC AMPLIFIER

A portion of the amplified signal from transistor Q403 is coupled through capacitor C421 to the base of the AVC (automatic volume control) Amplifier C404. This signal is rectified by the base-emitter portion of Q404 and a positive voltage drop is developed across the load resistor R432. This voltage causes a collector current to flow and a resultant drop in collector voltage that corresponds to the changes in signal strength. This varying DC voltage is applied as bias to IF Amplifier Q402, thereby controlling its gain.

A portion of the amplified signal from IF Amplifier Q403 is also coupled through capacitor C419 to diodes D403 and D404. These two diodes form a voltage doubler circuit which provides AVC voltage for RF amplifier Q101. Resistors R423, R424, and R425 establish the correct

forward bias point for gate 2 of field effect transistor Q101 under no signal conditions. When a signal is received, the bias changes from a positive voltage, through zero, to a negative voltage. This voltage varies, depending upon the signal strength. Resistor R505 and capacitor C511 form an AVC timing circuit.

DETECTORS

A portion of the output signal from IF amplifier Q403 is applied to AM detector D401 for AM operation. This output signal is also applied through capacitor C429 to gate 1 of product detector Q405 for CW (continuous wave), or SSB (single sideband) reception. Q405 is a dual-gate silicon field effect transistor (FET) which exhibits excellent isolation between gate 1 and gate 2, eliminating BFO oscillator "pulling" or overloading on very strong signals. Gate 2 of transistor Q405 is biased by a voltage divider consisting of resistors R433 and R434.

Injection voltage from BFO oscillator Q410 is applied to gate 2 of product detector Q405 when the front panel switch is in the CW/SSB position. The IF signal and the BFO signal are combined (mixed) in the transistor. The resultant output is an audio signal that is developed across resistor R441 and coupled through capacitor C433 to the AM-CW/SSB switch SW503B.

BFO

Transistor Q410 is a Colpitts oscillator which is extremely stable over wide ranges of temperature. Capacitors C425 and C426 provide the proper feedback for oscillation and form a tuned circuit with T401 to resonate at 455 kHz. Resistors R437 and R438 form a voltage divider and apply DC biasing to the base of Q410. Emitter resistor R436 provides temperature stabilization for the transistor. Injection voltage is coupled to gate 2 of product detector Q405, through capacitor C424. The BFO is actuated by the AM-CW/SSB switch in the CW/SSB position. This switch applies DC operating voltage to the circuit through RFC 403.

CONVERSION OSCILLATOR

Transistor Q411 and its associated circuitry form the 3.579 MHz heterodyne oscillator, which is used to provide double conversion on Band F only. Injection voltage is coupled through capacitor C407 to gate 2 of Q401 which is operated as a mixer on Band F only.

ANL

The detected audio is connected from the AM-CW/SSB switch to the AF Gain control R505 by one of two paths, depending upon the position of ANL (automatic noise limiter) switch SW506. When the ANL switch is in the OFF position, the audio signal is routed through capacitor C436 to capacitor C439 which is connected to the AF Gain control. When the ANL switch is in the ANL position, the audio signal is routed through the automatic noise limiter circuitry instead of capacitor C436.

The detected audio signal is prevented from flowing through resistors R445 and R446. These two resistors, along with capacitor C438, form an audio filter that stops the audio signal, but allows a small DC voltage to pass through. This small DC voltage biases the cathode of diode D402. The audio signal then passes through resistor R444, diode D402, and capacitor C439 to AF GAIN control R505. The diode clips the peaks of the audio signal, thus limiting noise spikes.

AUDIO AMPLIFIER

The audio signal from AF Gain control R505 is coupled through capacitor C441 to the base of audio preamplifier transistor Q406. Resistors R449 and R451 form a voltage divider to provide the correct bias to Q406. DC operating bias is obtained from the RCV/STBY switch through resistor R449. The audio output from Q406 is developed across the load resistor R454 and direct coupled to the second audio driver transistor Q407.

The output of Q407 is also direct coupled to the audio output transistors Q408 and Q409, which operate as a complementary pair. Bias voltage for the output transistors is obtained from resistors R455 and R456. Audio output is coupled from the emitter resistors R457 and R458 through capacitor C446 to the 16 ohm speaker or headphone jack. A portion of the output is fed back to the emitter of preamplifier Q406 through resistor R453 and capacitor C444 to aid stabilization and minimize distortion.

CRYSTAL CALIBRATOR

Transistor Q412, crystal Y1, and the associated circuitry form a 500 kHz calibration oscillator which is switched on by the front panel Cal switch, SW504. This 500 kHz oscillator provides accurate calibration markings every 500 kHz for dial calibration.

CHARGING CIRCUIT

The battery is electrically divided in half for charging from AC. When the AC power cord is plugged into a power outlet, the AC voltage from the secondary of transformer T501 is applied through diode D501 on one-half cycle to charge one-half of the battery. On the other half cycle the voltage is applied through diode D502 to charge the other half of the battery.

The battery can also be charged from 12 to 15 VDC. When the DC power cord is connected to a power source, the DC voltage is applied through diode D503, pilot lamp PL-502, and resistor R503 to the battery. The diode protects the battery from being discharged in case the external DC charging voltage is connected backwards. The pilot lamp and resistor function primarily as a DC charging current limiter. The lamp may not necessarily be lit.

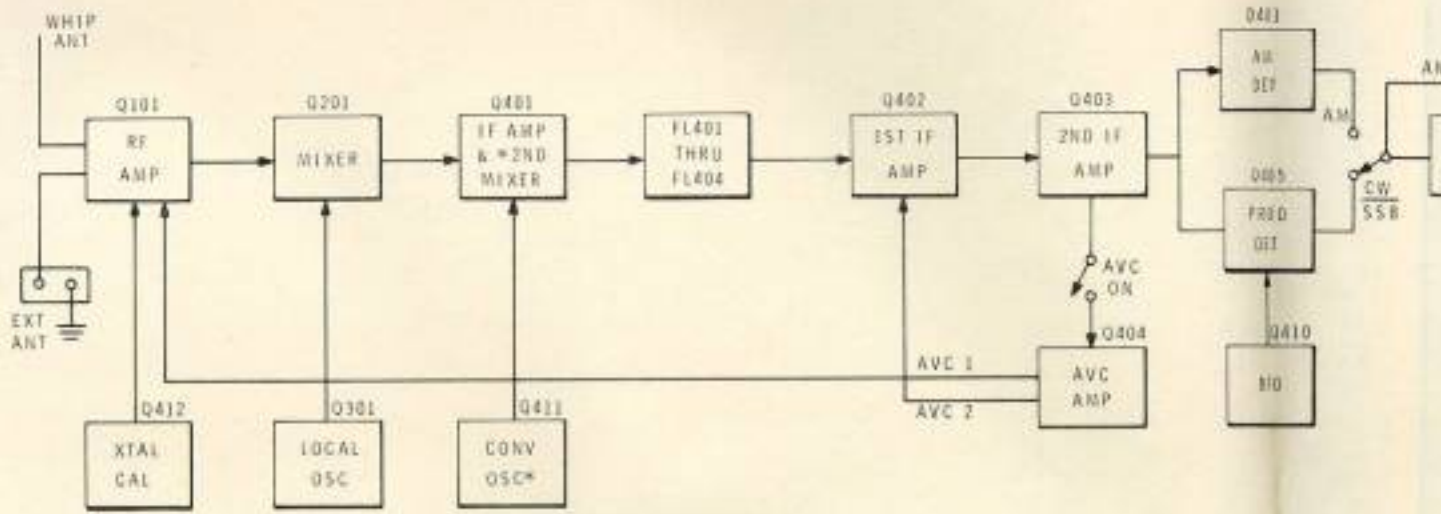

* BAND F ONLY

BLOCK DIAGRAM

CIRCUIT BOARD X-RAY VIEWS

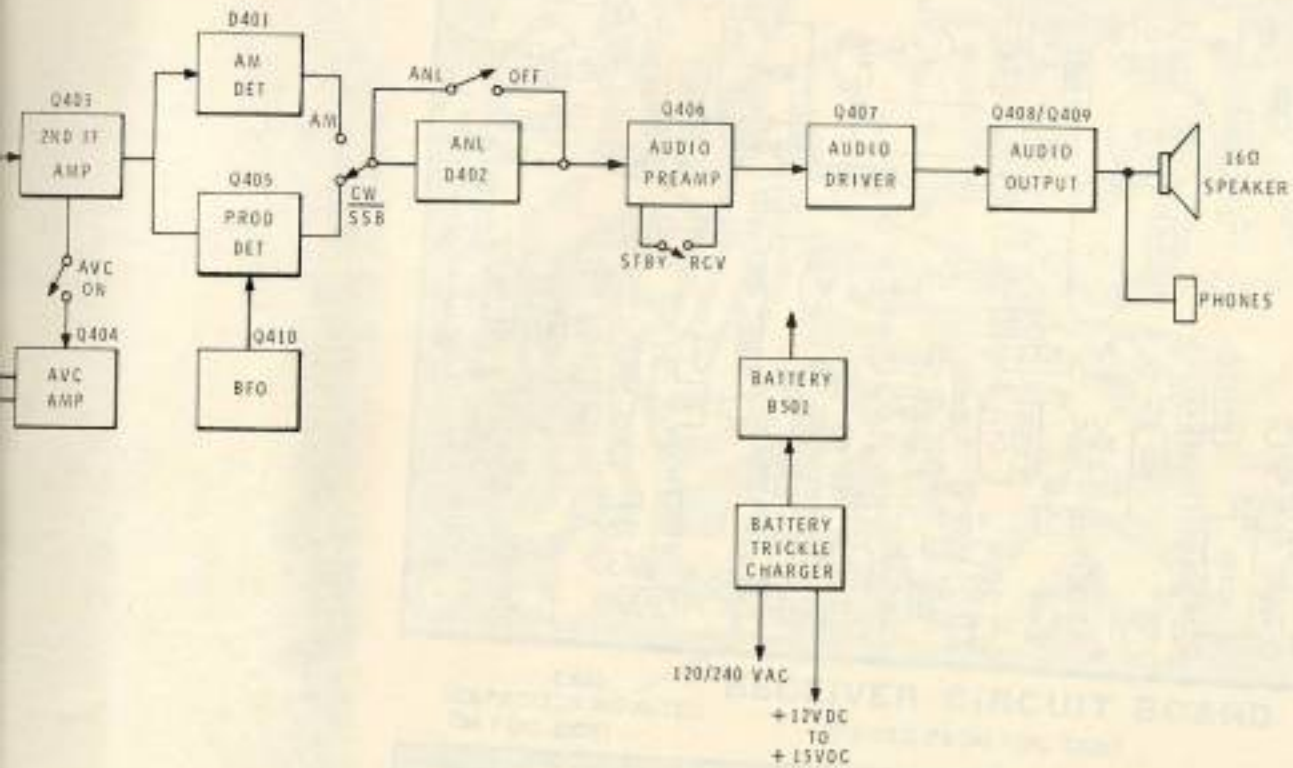

CK DIAGRAM

RECEIVER CIRCUIT BOARD

CIRCUIT BOARD X-RAY VIEWS

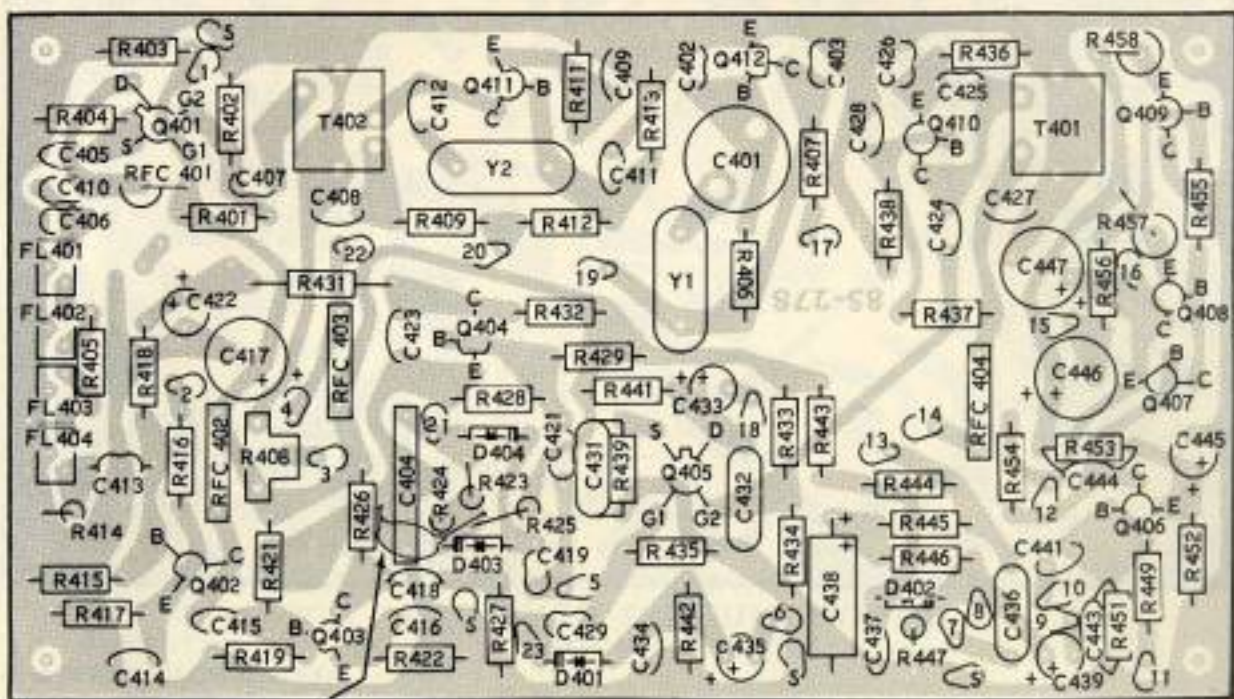

RECEIVER CIRCUIT BOARD

C420
(CAPACITOR MOUNTED
ON FOIL SIDE)

(VIEWED FROM FOIL SIDE)

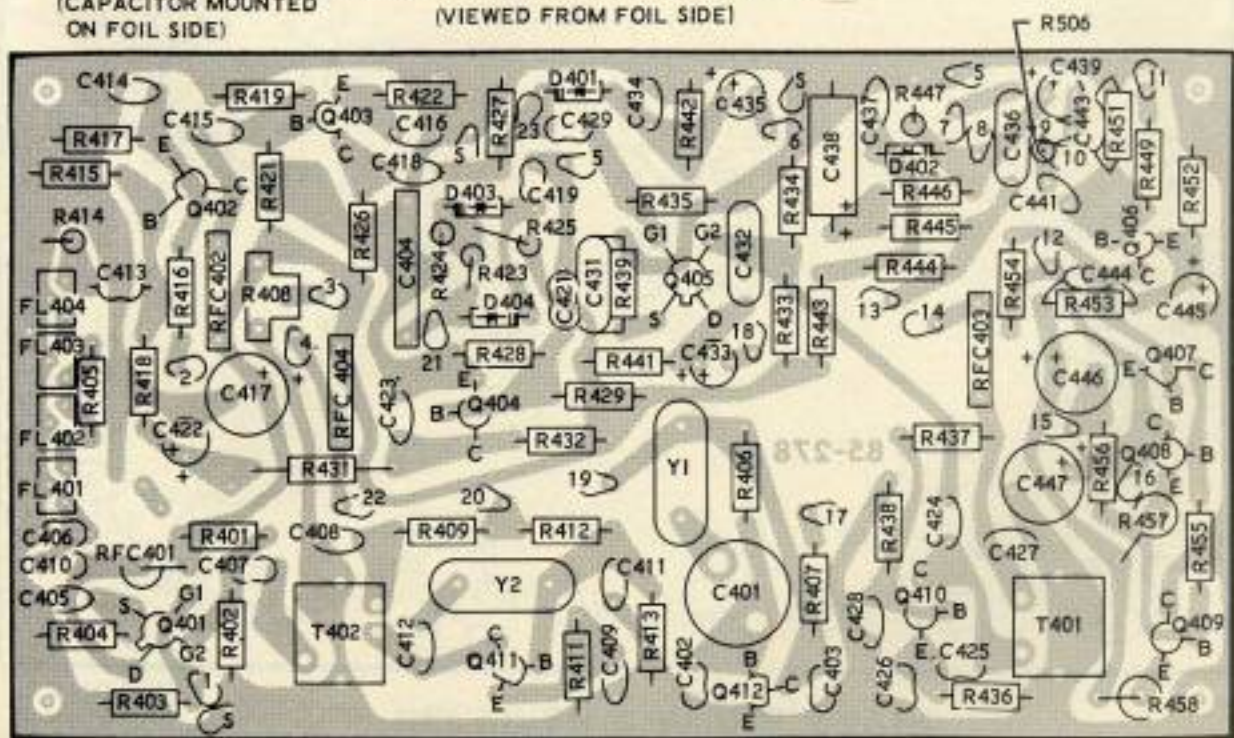

RECEIVER CIRCUIT BOARD

(VIEWED FROM COMPONENT SIDE)

VOLTAGE CHARTS

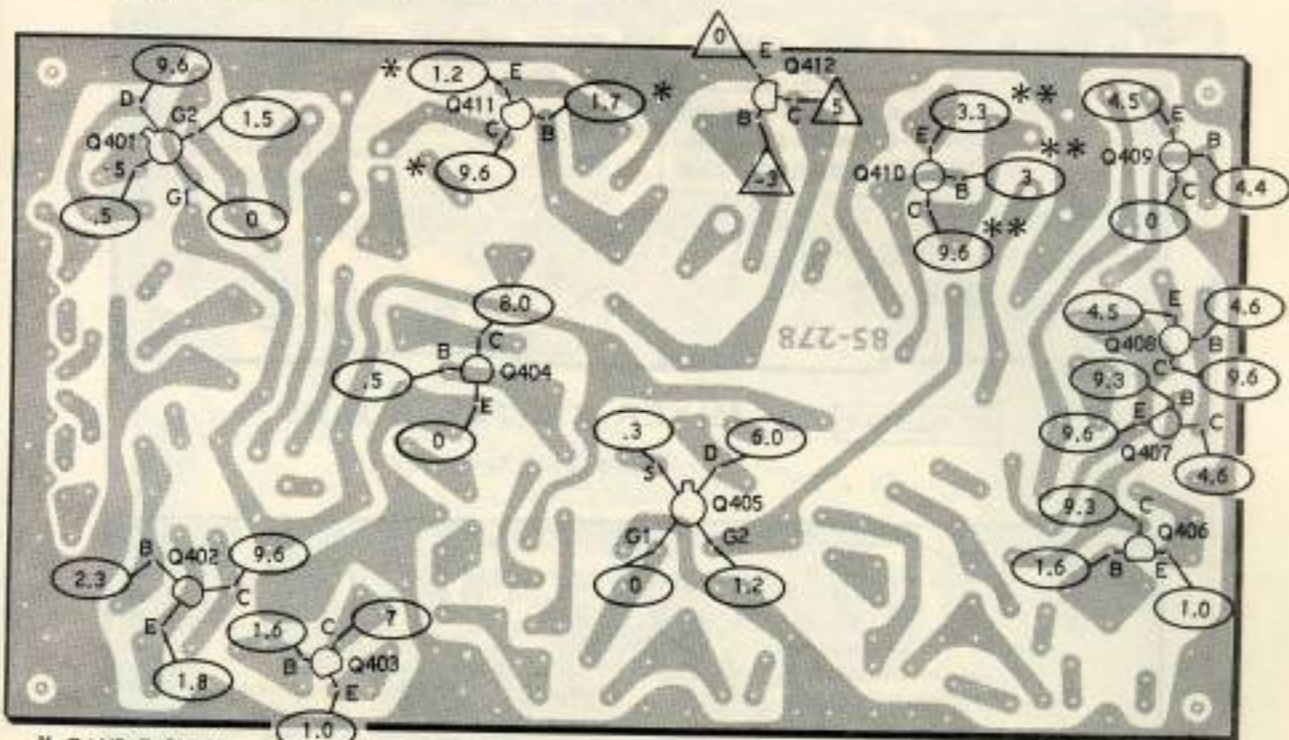

RECEIVER CIRCUIT BOARD
(VIEWED FROM FOIL SIDE)

- * BAND F ONLY
- △ CALIBRATE ONLY
- ** SWITCH IN CW/SSB MODE

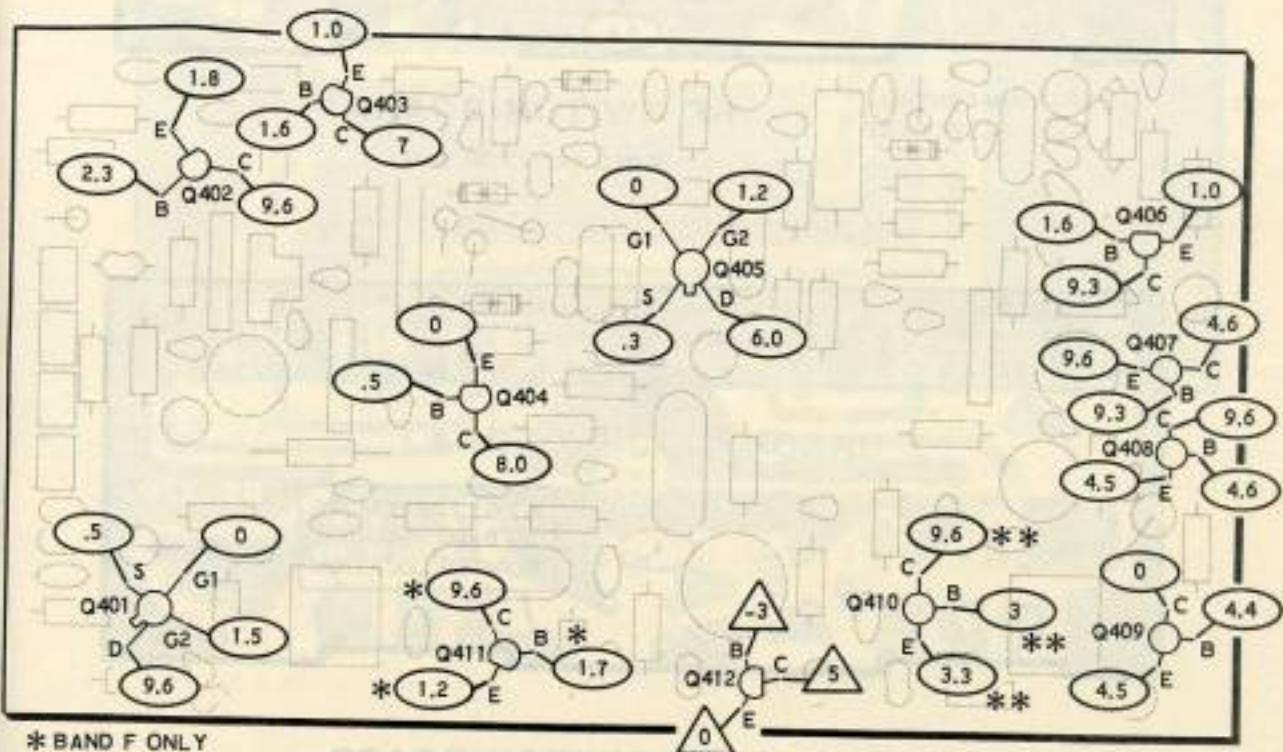

RECEIVER CIRCUIT BOARD
(VIEWED FROM COMPONENT SIDE)

- * BAND F ONLY
- △ CALIBRATE ONLY
- ** SWITCH IN CW/SSB MODE



DC

RF VOLTAGE

MIXER SWITCH-BOARD

(VIEWED FROM FOIL SIDE)



RF GAIN CONTROL
FULLY CLOCKWISE

RF SWITCH-BOARD

(VIEWED FROM FOIL SIDE)

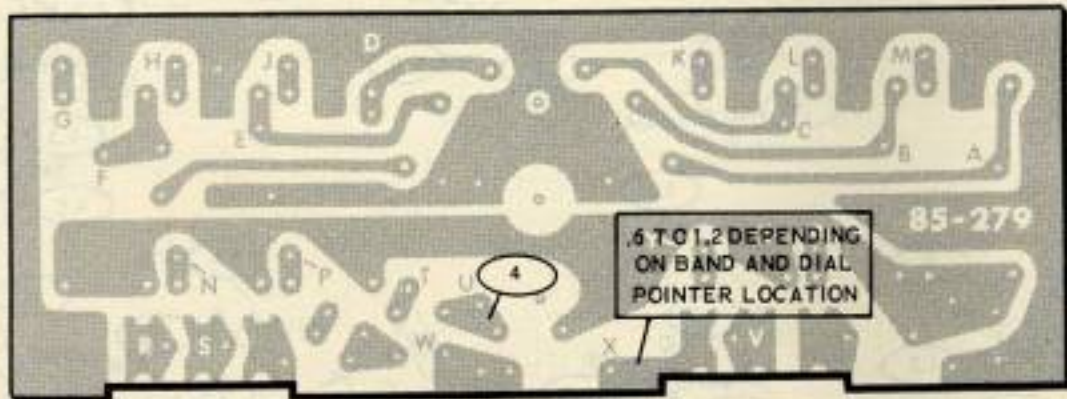

OSCILLATOR SWITCH-BOARD

(VIEWED FROM FOIL SIDE)

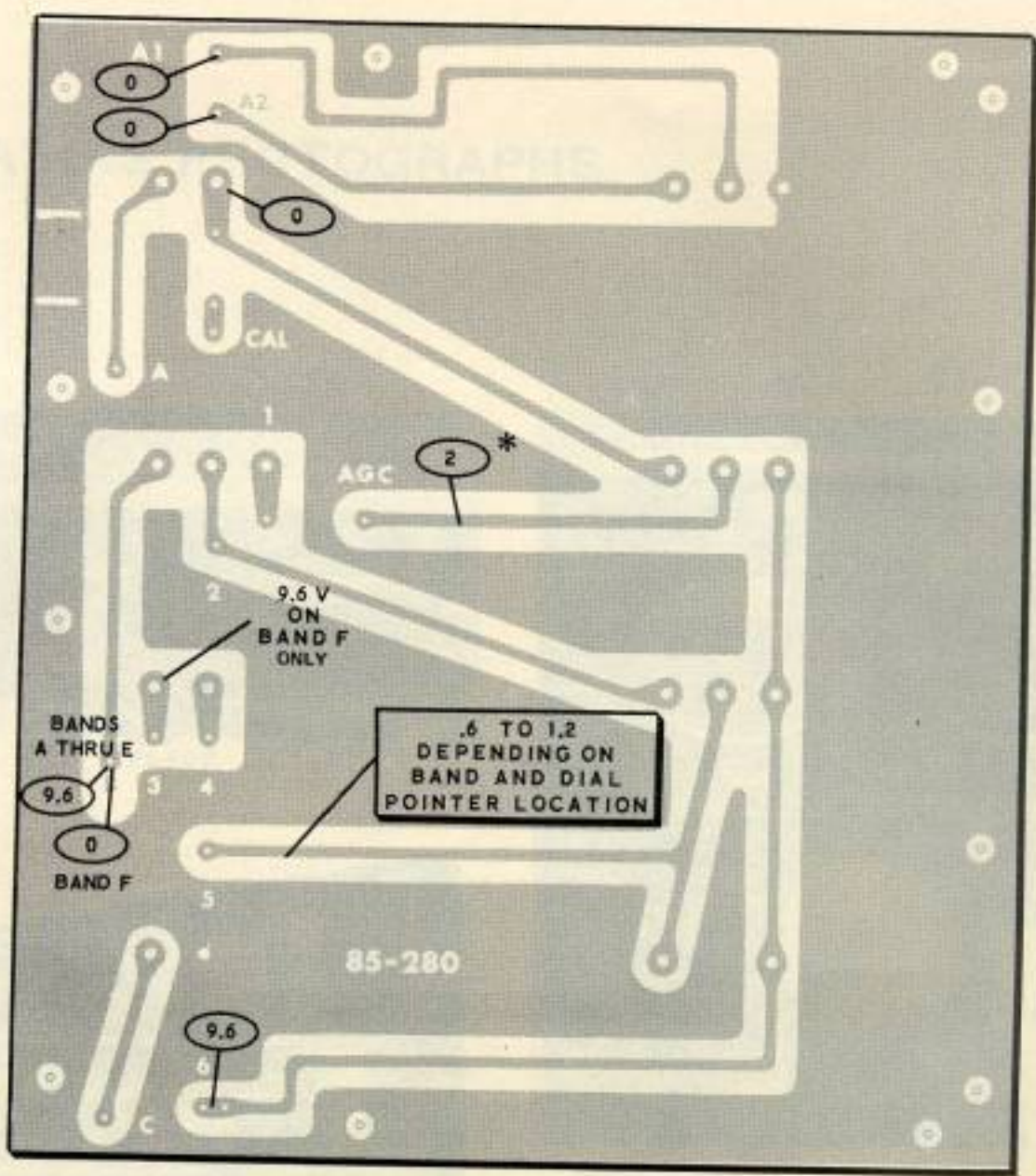

LARGE CIRCUIT BOARD

(VIEWED FROM FOIL SIDE)

* VARIES WITH SIGNAL STRENGTH

CHASSIS PHOTOGRAPHS



M501 PL502 C506



R505 C511



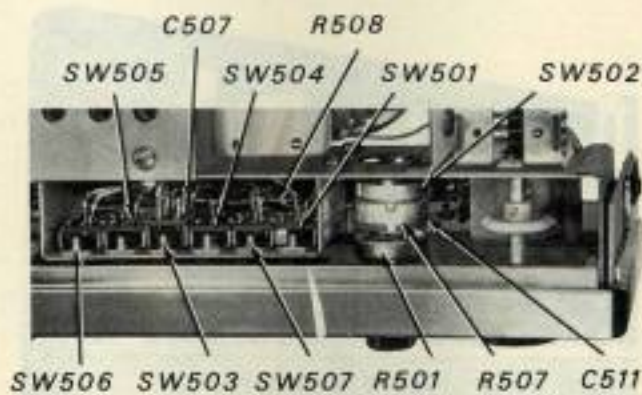
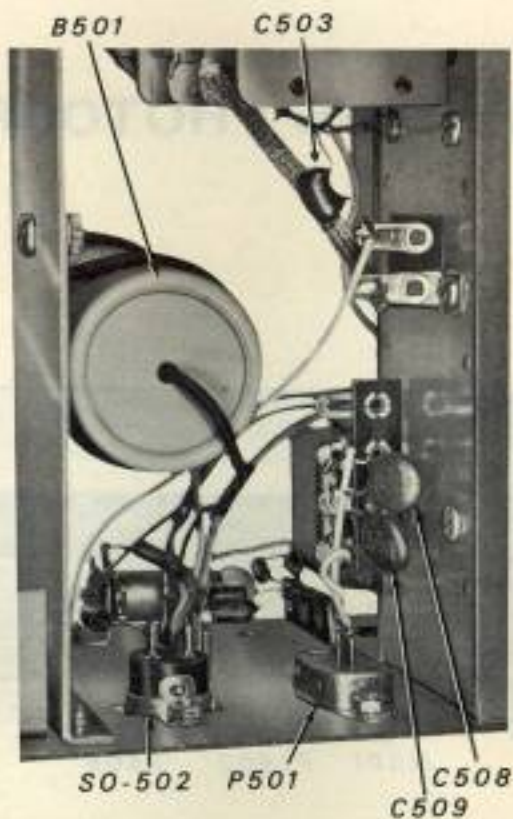
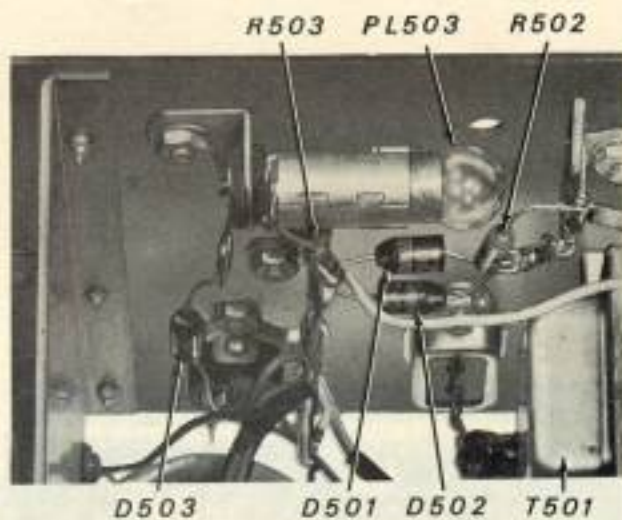

ANTENNA SWITCH-BOARD (#85-279-1)

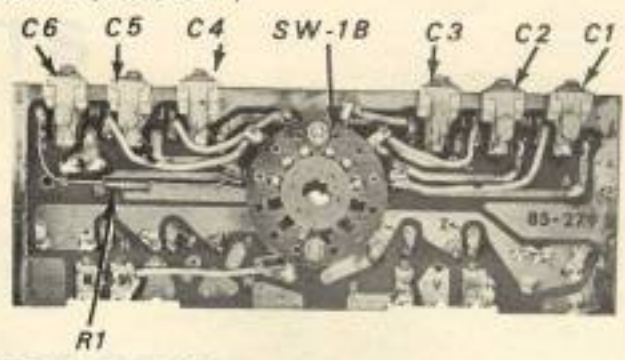
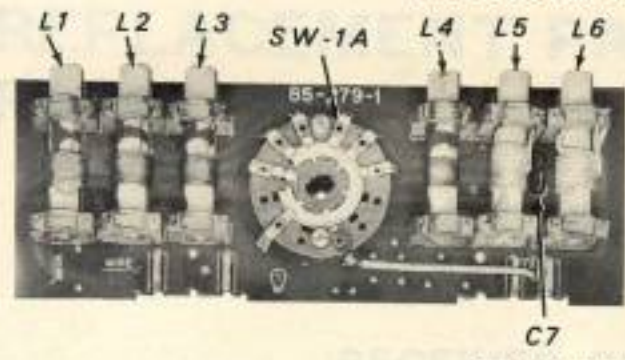

RF SWITCH-BOARD (#85-279-2)

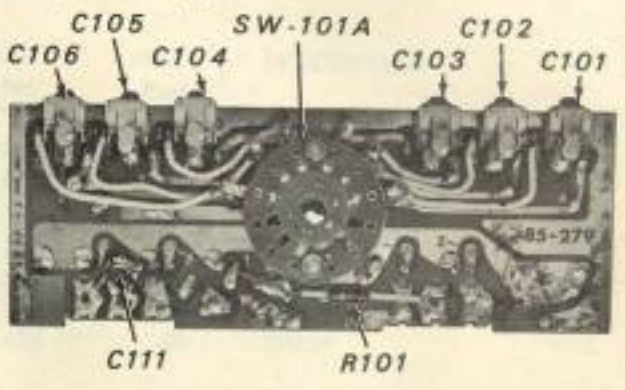
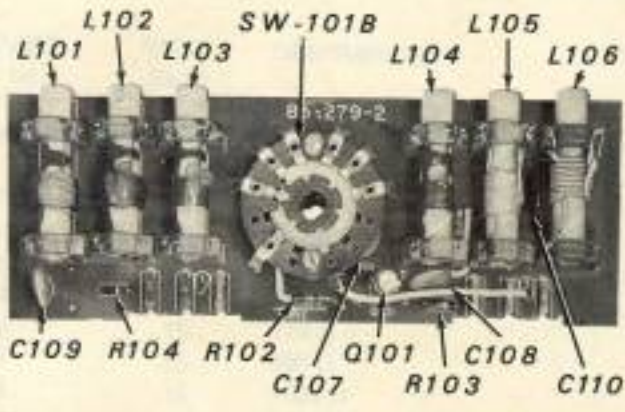

MIXER SWITCH-BOARD (#85-279-12)

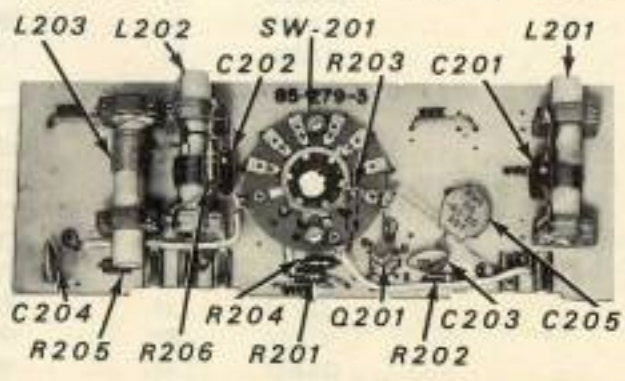

OSCILLATOR SWITCH-BOARD (#85-279-13)

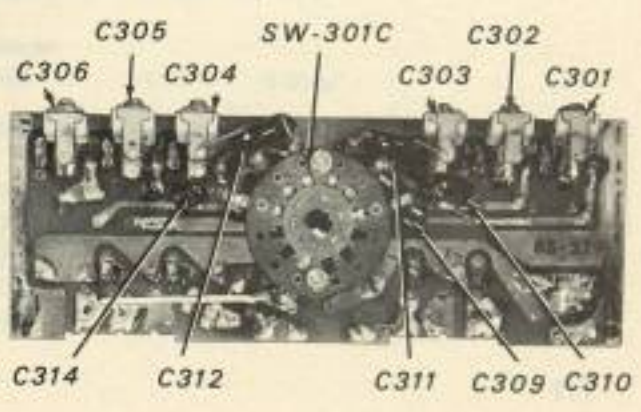
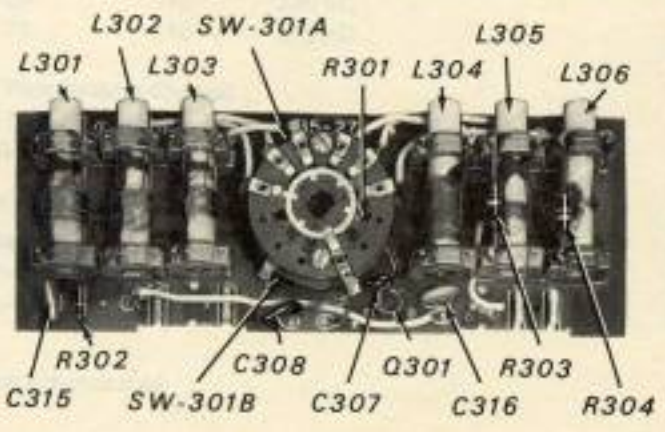

REPLACEMENT PARTS PRICE LIST

To order a replacement part, use the Parts Order Form furnished with this kit. If a Parts Order Form is not available, refer to "Replacement Parts" inside the rear cover of the Manual.

RECEIVER CIRCUIT BOARD

PART No.	PRICE Each	DESCRIPTION	PART No.	PRICE Each	DESCRIPTION
RESISTORS-CONTROL			Mica (cont'd.)		
1/2 Watt Resistors			20-102	.25	100 pF
1-103	.15	33 Ω	20-104	.25	130 pF
1-3	.15	100 Ω	20-164	.45	180 pF
1-4	.15	330 Ω	20-139	.40	330 pF
1-6	.15	470 Ω	20-106	.45	390 pF
1-7	.15	680 Ω	20-134	.90	680 pF
1-9	.15	1000 Ω	Ceramic		
1-11	.15	1500 Ω	21-61	.15	6.8 pF
1-44	.15	2200 Ω	21-21	.15	200 pF
1-89	.15	2400 Ω	21-140	.15	.001 μ F
1-14	.15	3300 Ω	21-47	.15	.01 μ F
1-18	.15	5600 Ω	21-143	.30	.05 μ F
1-73	.15	8200 Ω	21-95	.25	.1 μ F
1-20	.15	10 k Ω	Mylar		
1-109	.20	12 k Ω	27-60	.40	.22 μ F
1-21	.15	15 k Ω	27-61	.60	.47 μ F
1-23	.15	27 k Ω	Electrolytic		
1-24	.15	33 k Ω	25-123	.60	2 μ F
1-25	.15	47 k Ω	25-115	.60	10 μ F
1-60	.15	68 k Ω	25-117	.75	100 μ F
1-26	.15	100 k Ω	Trimmer		
1-27	.15	150 k Ω	31-36	1.40	8-50 pF
1-29	.15	220 k Ω	TRANSISTORS-DIODES		
1-33	.15	470 k Ω	417-274	2.30	40673 transistor
2 Watt Resistor-Control			417-171	.75	2N3694 transistor
3-7-2	.50	1 Ω	417-118	.40	2N3393 transistor
10-241	1.00	10 k Ω control	417-201	.50	X29A829 transistor
CAPACITORS			56-26	.40	1N191 diode
Mica					
20-130	.25	12 pF			
20-77	.25	24 pF			

PART No.	PRICE Each	DESCRIPTION	PART No.	PRICE Each	DESCRIPTION
Transistors-Diodes (cont'd.)			Miscellaneous (cont'd.)		
117-6	3.10	Packaged transistor set	40-487	1.00	300 μ H inductor
consisting of:			52-118	.90	BFO coil
417-121	1.25	2N2430 transistor	52-119	1.15	Band F conversion oscillator coil
417-122	1.35	2N2431 transistor	215-19	.15	Heat sink
MISCELLANEOUS			344-59	.05/ft	White wire
404-238	2.25	3579.545 kHz crystal	85-278-5	3.60	Circuit board
404-367	8.10	500 kHz crystal	331-6	.25	Solder
404-399	.60	455 kHz ceramic filter		2.00	Manual (See front cover for part number.)
45-47	1.00	2 mH RF choke			

ANTENNA SWITCH-BOARD

PART No.	PRICE Each	DESCRIPTION	PART No.	PRICE Each	DESCRIPTION
1-45	.15	220 Ω 1/2 watt resistor	40-873	1.00	Coil
20-149	.40	150 pF	40-874	1.00	Coil
31-54	.55	4-40 pF	40-875	1.00	Coil
40-870	1.05	Coil	63-570	3.40	2-wafer bandswitch
40-871	1.00	Coil	432-77	.15	Ladder of connectors
40-872	1.00	Coil	490-5	.15	Nut starter
			85-279-1	2.20	Switch-Board

RF SWITCH-BOARD

PART No.	PRICE Each	DESCRIPTION	PART No.	PRICE Each	DESCRIPTION
1-1-12	.15	100 Ω 1/4 watt resistor	40-878	1.00	Coil
1-32-12	.15	100 k Ω 1/4 watt resistor	40-879	1.00	Coil
1-3	.15	100 Ω 1/2 watt resistor	40-880	1.00	Coil
20-130	.25	12 pF mica capacitor	40-881	1.00	Coil
20-149	.40	150 pF mica capacitor	63-570	3.40	2-wafer bandswitch
21-95	.25	.1 μ F ceramic capacitor	417-274	2.30	40673 transistor
31-52	.60	8-60 pF mica trimmer capacitor	432-77	.15	Ladder of connectors
40-876	1.05	Coil	85-279-2	2.20	Switch-Board
40-877	1.00	Coil			

MIXER SWITCH-BOARD

PART No.	PRICE Each	DESCRIPTION	PART No.	PRICE Each	DESCRIPTION
1-1-12	.10	100 Ω 1/4 watt resistor	21-95	.25	.1 μ F ceramic capacitor
1-2-12	.10	1000 Ω 1/4 watt resistor	40-650	1.00	Coil
1-26-12	.10	5600 Ω 1/4 watt resistor	40-888	1.00	Coil
1-45-12	.10	22 k Ω 1/4 watt resistor	40-889	1.00	Coil
1-32-12	.10	100 k Ω 1/4 watt resistor	63-546	2.20	Single wafer bandswitch
1-21	.10	15 k Ω 1/2 watt resistor	417-274	2.30	40673 transistor
20-149	.25	150 pF mica capacitor	432-77	.15	Ladder of connectors
20-111	.25	230 pF mica capacitor	85-279-12	2.20	Switch-Board
20-128	.35	470 pF mica capacitor			
21-143	.15	.05 μ F ceramic capacitor			

OSCILLATOR SWITCH-BOARD

PART No.	PRICE Each	DESCRIPTION	PART No.	PRICE Each	DESCRIPTION
1-1-12	.10	100 Ω 1/4 watt resistor	31-54	.35	4-40 pF mica trimmer capacitor
1-18-12	.10	470 k Ω 1/4 watt resistor	31-52	.40	8-60 pF mica trimmer capacitor
1-18	.10	5600 Ω 1/2 watt resistor	40-882	.65	Coil
20-130	.15	12 pF mica capacitor	40-883	.65	Coil
20-102	.15	100 pF mica capacitor	40-884	.60	Coil
20-111	.20	230 pF mica capacitor	40-885	.55	Coil
20-128	.35	470 pF mica capacitor	40-1003	.55	Coil
20-127	.40	1300 pF mica capacitor	40-887	.55	Coil
20-129	.90	2700 pF mica capacitor	63-571	2.80	3-wafer bandswitch
21-95	.15	.1 μ F ceramic capacitor	417-169	1.50	MPF105 transistor
31-56	.30	1.5-20 pF mica trimmer capacitor	432-77	.10	Ladder of connectors
			85-279-13	1.45	Switch-Board

CHASSIS

PART No.	PRICE Each	DESCRIPTION	PART No.	PRICE Each	DESCRIPTION
1/2 WATT RESISTORS-CONTROL			Jack-Sockets-Plug (cont'd.)		
1-103	.15	33 Ω	434-88	.15	Lamp socket
1-1	.15	47 Ω	432-32	.50	2-terminal polarized socket
1-2	.15	68 Ω	432-29	1.20	2-terminal polarized plug
1-3	.15	100 Ω	CONNECTORS-TERMINAL STRIPS		
1-9	.15	1000 Ω	432-102	.35	5-pin Switch-Board connector
1-20	.15	10 k Ω	431-2	.15	2-lug terminal strip
14-7	3.35	50 k Ω and 5 k Ω dual control with SPST switch	431-6	.15	2-lug screw type terminal strip
CAPACITORS			431-16	.15	2-lug terminal strip
20-130	.25	12 pF mica	431-40	.15	4-lug terminal strip
20-102	.25	100 pF mica	431-62	.15	3-lug miniature terminal strip
21-71	.20	.001 μ F 1.4 kV ceramic	HARDWARE		
21-143	.30	.05 μ F ceramic	#4 Hardware		
25-123	.60	2 μ F electrolytic	250-156	.05	4-40 x 1/8" setscrew
25-98	.40	50 μ F electrolytic	250-52	.05	4-40 x 1/4" screw
25-157	.85	500 μ F electrolytic	250-4	.05	4-40 x 3/8" screw
28-2	.15	1.0 pF phenolic	252-2	.05	4-40 nut
26-143	11.20	290-290-259 pF variable	254-9	.05	Small lockwasher
26-127	6.45	7-18.7 μ F variable	#6 Hardware		
DIODE-LAMPS			250-138	.05	6-32 x 3/16" screw
57-65	.30	Silicon diode	250-116	.05	6-32 x 1/4" black screw
412-17	.20	#53 lamp	250-56	.05	6-32 x 1/4" screw
412-31	.75	#2114D lamp	250-170	.05	#6 x 1/4" sheet metal screw
SWITCHES-TRANSFORMER			250-432	.05	6-32 x 5/16" screw
60-48	.85	DPDT rocker switch	250-100	.05	6-32 x 5/16" setscrew
60-46	1.35	SPST rocker switch with spring return	250-89	.05	6-32 x 3/8" screw
54-226	4.75	Power transformer	250-32	.05	6-32 x 3/8" flat head screw
GROMMETS-CLAMPS			250-162	.05	6-32 x 1/2" screw
73-4	.15	5/16" rubber grommet	252-3	.05	6-32 nut
73-27	.15	1/2" plastic grommet (consisting of 2 pieces)	252-22	.05	#6 speednut
73-52	.15	1/4" plastic grommet	253-60	.05	#6 flat washer
207-58	.25	Battery clamp	254-1	.05	#6 lockwasher
JACK-SOCKETS-PLUG			259-1	.05	#6 solder lug
436-4	.40	3-terminal phone jack	#8 Hardware		
432-4	.15	AC power plug	250-16	.05	8-32 x 3/16" setscrew
			250-43	.05	8-32 x 1/4" setscrew
			250-22	.10	8-32 x 7/16" setscrew
			250-137	.05	8-32 x 3/8" screw
			252-4	.05	8-32 nut
			253-9	.05	#8 flat washer
			254-2	.05	#8 lockwasher











PART No.	PRICE Each	DESCRIPTION	PART No.	PRICE Each	DESCRIPTION
Control Hardware			Sheet Metal Parts (cont'd.)		
252-7	.05	Control nut	206-408	.60	Speaker shield
253-10	.05	Control flat washer	206-410	1.30	Receiver board shield
254-5	.05	Control lockwasher	205-611	.85	Bottom shield
259-10	.05	Control solder lug			
Antenna Hardware			MISCELLANEOUS MECHANICAL PARTS		
252-39	.05	Antenna nut	209-55	.60	Speaker grille
253-50	.05	Nylon shoulder washer	211-35	2.25	Handle
253-49	.10	Nylon flat washer	349-3	.05/ft	Dial cord
455-31	.40	Antenna bushing	451-61	.40	36 tooth nylon gear
259-12	.05	Antenna solder lug	451-62	.40	48 tooth nylon gear
Bushings-Collar			453-2	.25	Bandspread shaft
455-13	.20	1/4" bandspread bushing	453-172	.85	Tuning shaft
455-9	.35	3/8" tuning bushing	453-198	1.90	Bandswitch shaft
455-11	.15	Split bushing	454-12	.85	Flywheel
455-15	.15	Bandswitch collar	100-452	2.50	Capacitor pulley
Miscellaneous Hardware			462-140	.50	Large knob
100-302	.35	Tuning pulley	462-159	.55	Small knob
204-9	.15	Angle bracket	462-240	.90	Lever knob
250-175	.05	2-56 x 3/8" screw	463-32	.30	Bandspread dial pointer
250-305	.20	6-32 x 9/16" stud	463-49	.60	Main dial pointer
252-51	.05	2-56 nut			
253-11	.05	E washer	MISCELLANEOUS ELECTRICAL PARTS		
253-39	.05	1/4" flat washer	85-280	5.85	Large circuit board
255-2	.05	7/32" metal spacer	89-3	.90	Line cord
255-23	.10	6-32 x 15/32" tapped spacer	134-187	4.15	Wire harness
258-1	.05	Spring	142-42	4.20	Antenna
261-34	.10	Foot	344-15	.05/ft	Black stranded wire
266-142	.75	Switch detent	344-16	.05/ft	Red stranded wire
432-66	.15	Speaker connector	345-1	.10/ft	Braid
SHEET METAL PARTS			401-135	5.00	Speaker
90-421	3.40	Cabinet top	407-135	5.85	Meter
90-422	1.95	Cabinet bottom	418-23	29.70	Battery
210-41	9.35	Bezel	GENERAL		
100-805	1.90	Front panel	75-93	.15	Fiber spacer
100-734	1.20	Front subpanel	390-252	.25	Bandspread label - amateur bands
203-556	1.35	Rear panel	390-253	.25	Bandspread label - short-wave bands
204-889	.70	Main support bracket	390-1112	.15	Warning label
100-735	4.10	Right chassis end	464-53	3.35	Plastic dial window
100-736	4.10	Left chassis end	490-1	.15	Alignment tool
100-737	.75	Bandspread dial drum	490-23	.15	Allen wrench
204-892	.15	Bandspread bracket	500-7	.80	Heathkit logs and chart book
204-890	.55	Switch bracket			
204-891	.90	Capacitor bracket			
204-923	1.25	Antenna bracket			
206-409	.40	Switchboard shield			

**SCHEMATIC OF THE
HEATHKIT®
GENERAL COVERAGE RECEIVER
MODEL GR-78**

NOTES:

1. COMPONENT PART NUMBERS ARE IN THE FOLLOWING GROUPS:

1-99	ANTENNA SWITCH-BOARD.
100-199	RF SWITCH-BOARD.
200-299	MIXER SWITCH-BOARD.
300-399	OSCILLATOR SWITCH-BOARD.
400-499	RECEIVER CIRCUIT BOARD.
500-599	CHASSIS.
2. ALL RESISTORS ARE 1/2 WATT UNLESS MARKED OTHERWISE.
3. CAPACITOR VALUES LESS THAN 1 ARE IN μ F. VALUES OF 1 AND ABOVE ARE IN PF UNLESS MARKED OTHERWISE.
4. BANDSWITCH WAFERS ARE IN BAND A POSITION AS VIEWED FROM THE KNOB END OF THE SWITCH SHAFT.
5. VOLTAGE MEASUREMENTS ARE MADE WITH THE SWITCHES AND CONTROLS IN THE FOLLOWING POSITIONS:

RF GAIN	-	FULLY CLOCKWISE.
METER ADJUST	-	1/4 TURN CLOCKWISE.
AM-CW/SSB	-	CW/SSB POSITION.
ANL-OFF	-	ANL POSITION.
BAND	-	BAND A POSITION.
TUNING	-	ANY DIAL LOCATION.
6.  THIS SYMBOL INDICATES A POSITIVE DC VOLTAGE MEASUREMENT TAKEN WITH AN 11 MEGOHM INPUT VOLTMETER FROM THE POINT INDICATED TO CHASSIS GROUND. VOLTAGES MAY VARY $\pm 20\%$.
7.  THIS SYMBOL INDICATES AN RF VOLTAGE.
8.  THIS SYMBOL INDICATES A CIRCUIT BOARD GROUND.
9.  THIS SYMBOL INDICATES A CHASSIS GROUND.
10.  THIS SYMBOL INDICATES CONNECTING POINTS TO THE CIRCUIT BOARD.
11.  THIS SYMBOL INDICATES A SWITCH-BOARD CONNECTOR PIN.
12.  THIS SYMBOL INDICATES A CLOCKWISE ROTATION OF CONTROLS AS VIEWED FROM THE KNOB END OF THE SHAFT.
13.  THIS SYMBOL INDICATES A ROCKER SWITCH.
14.  THIS SYMBOL INDICATES THE GROUND CONNECTIONS MADE BY THE SWITCH-BOARD GUIDES.
15. THE DOTS ON SOME SWITCH ROTORS INDICATES A CONNECTION FROM THE CONTACT ON THE FRONT OF THE ROTOR TO A CONTACT ON THE REAR OF THE ROTOR.
16.  THIS SYMBOL INDICATES A DC VOLTAGE THAT VARIES DEPENDING ON BAND AND DIAL POINTER LOCATION.
17.  THIS SYMBOL INDICATES A VOLTAGE IN BAND F ONLY.
18. * SWITCH IN CW/SSB POSITION.

OSCILLATOR SWITCH-BOARD 85-278-13

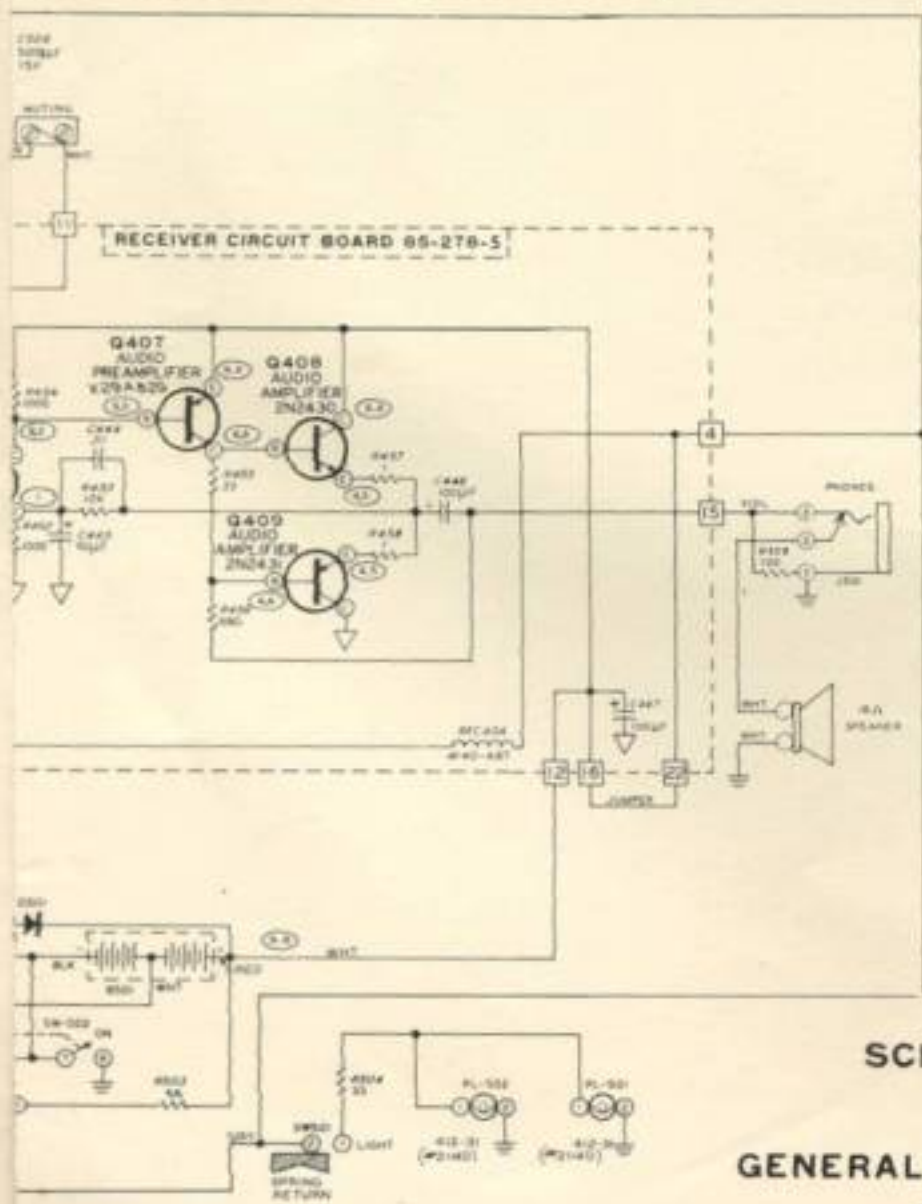
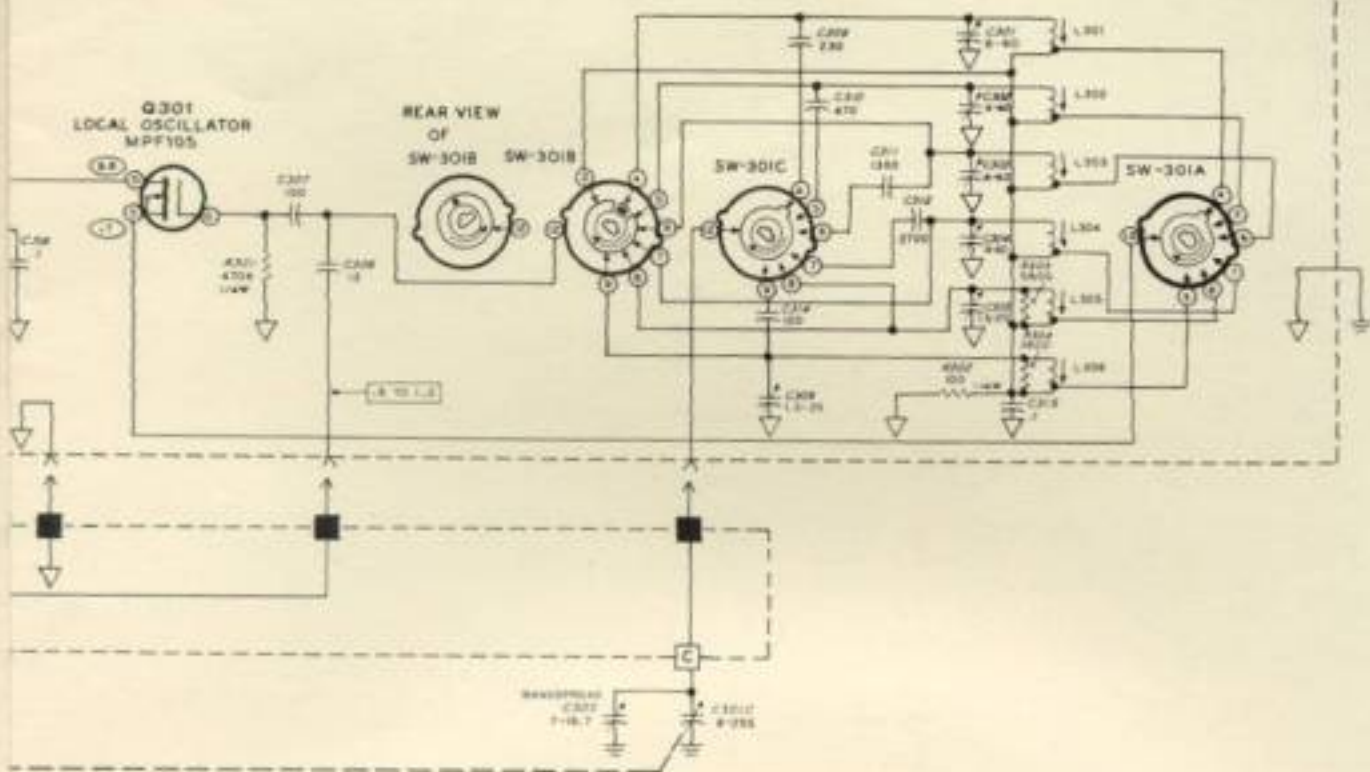

**SCHEMATIC OF THE
HEATHKIT®
GENERAL COVERAGE RECEIVER
MODEL GR-78**

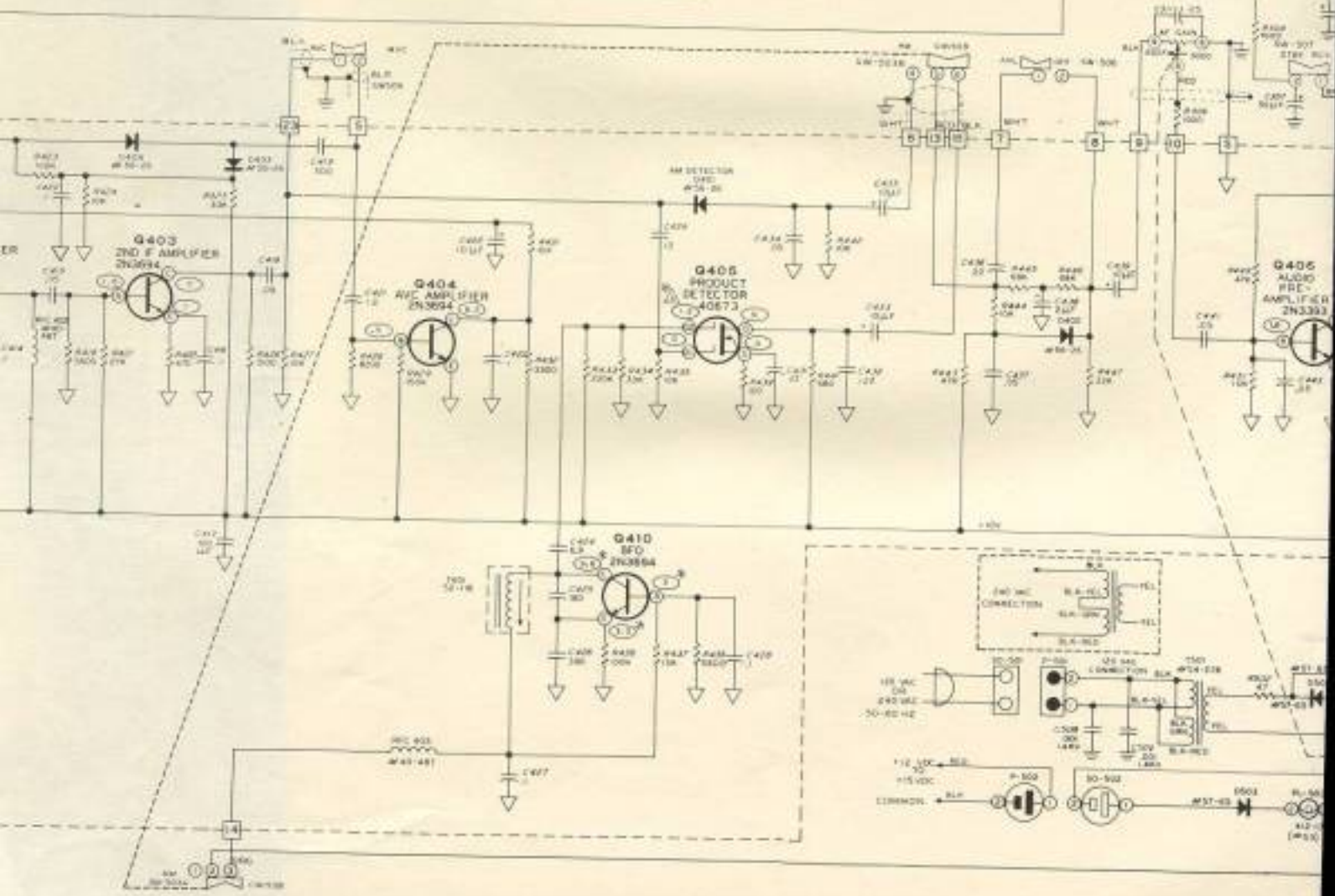
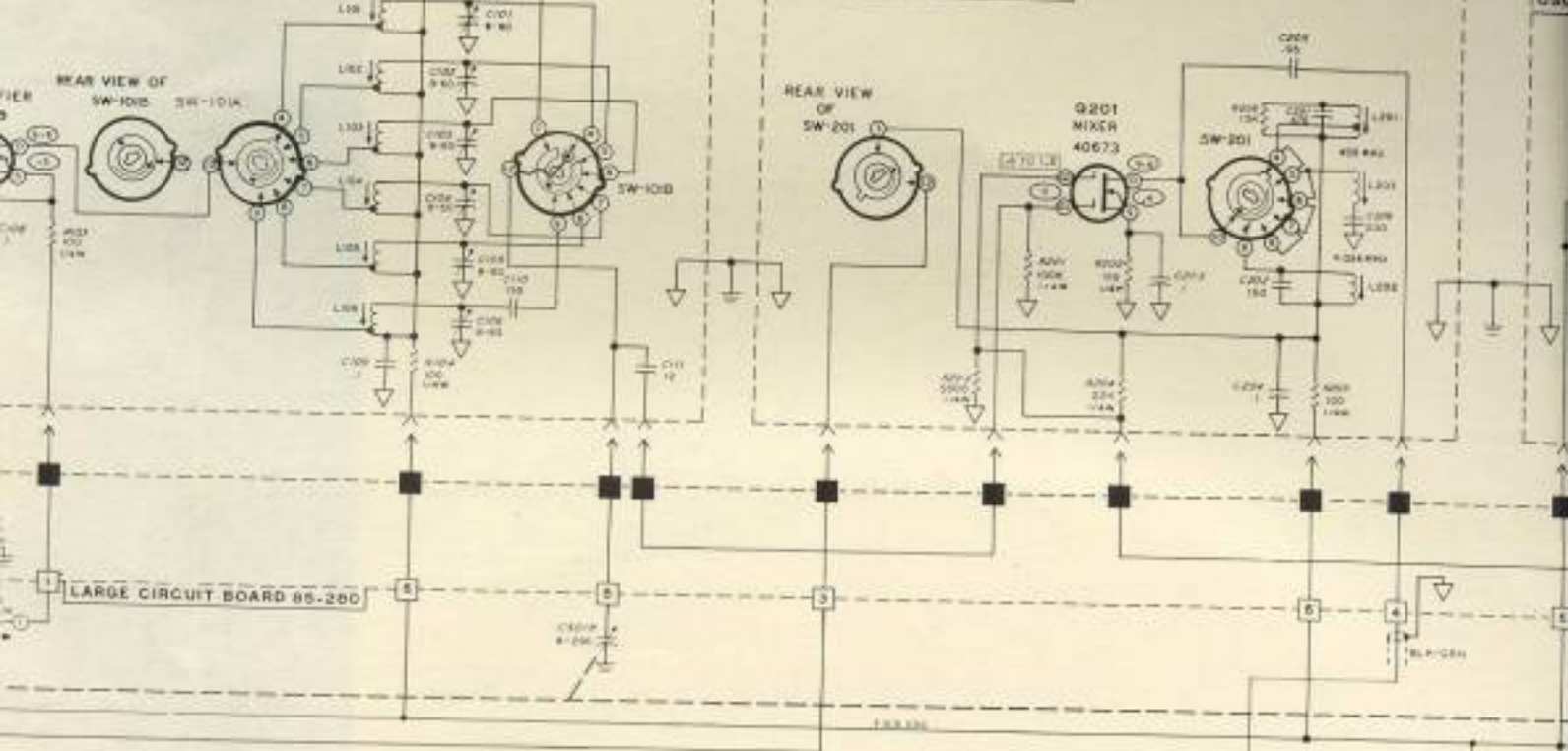

TABLE OF CONTENTS

Introduction	3	Initial Tests	6
Unpacking Instructions	5	Alignment	7
Circuit Boards		Alignment Without Instruments	7
Receiver Circuit Boards Parts List	7	Alignment With Instruments	7
Step-By-Step Assembly	9	Alignment Chart	7
Antenna Switch-Board Parts List	17	BFO Alignment	8
Step-By-Step Assembly	18	500 kHz Crystal Calibration Alignment	8
RF Switch-Board Parts List	22	5.5 MHz Trap Coil Alignment	8
Step-By-Step Assembly	23	Final Assembly	8
Mixer Switch-Board Parts List	26	Operation	8
Step-By-Step Assembly	27	Front and Rear Panel Controls and Switches	8
Oscillator Switch-Board Parts List	30	In Case of Difficulty	
Step-By-Step Assembly	31	General Troubleshooting Information	9
		Troubleshooting Chart	9
		Specifications	9
Chassis		Circuit Description	9
Parts List	37	Circuit Board X-Ray Views	10
Step-By-Step Assembly	40	Voltage Charts	10
Chassis Subassembly	40	Chassis Photographs	10
Switch-Board Installation	42	Replacement Parts Price List	11
Wire Harness Installation	45	Schematic. . .(fold-out from page)	11
Receiver Circuit Board Installation	46	Warranty	Inside front cover
Chassis Wiring	48	Customer Service	Inside rear cover
Alternate Line Voltage Wiring	48		
Rear Panel Parts Mounting and Wiring	49		
Front Panel Parts Mounting and Wiring	58		
Cabinet Top Parts Mounting	67		
DC Power Cable Wiring	68		