

# Scott 320R,330R/RL

## ADJUSTMENT

### Equipment Required

Audio signal generator.  
Level meter.  
Oscilloscope.  
Digital frequency counter, 0 – 100 kHz.  
FM multiplex signal generator.  
Circuit tester, 20 kohm/V.

### FM RF Tracking

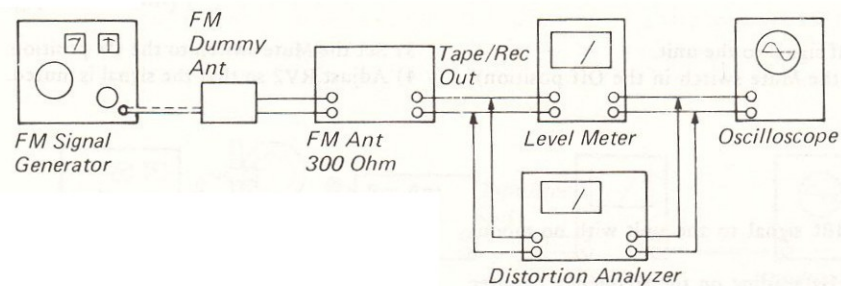

- 1) Apply 90 MHz, 1 kHz and 100% modulated, 65 dBf signal with 75 kHz deviation to the FM antenna terminal.
- 2) Tune the unit to 90 MHz.
- 3) Observe the oscilloscope connected to the Tape/Rec output terminal for symmetrical sine wave. If failed, adjust T3.
- 4) Adjust T1, and T2 for maximum level meter reading

- (connected in parallel with the oscilloscope).
- 5) Readjust the signal generator for 106 MHz, and retune unit.
- 6) Repeat step 3), if failed, adjust the trimming capacitor, CTc.
- 7) Adjust the trimming capacitors, CTa and CTb.

### FM IF Amplifier

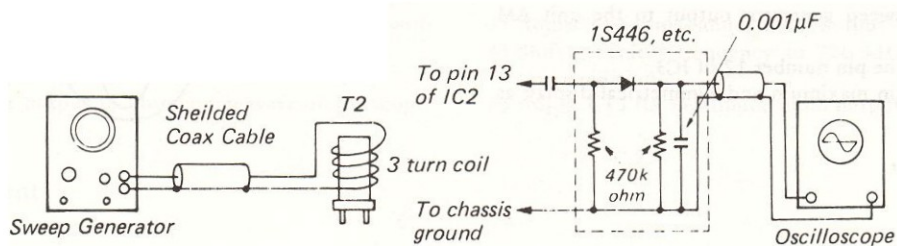

- 1) Mute the FM local oscillator by shorting CV3.
- 2) Connect oscilloscope to pin #13 of IC2.
- 3) Apply 10.7 MHz signal from the sweep generator to T2 in the manner as shown as above.
- 4) Adjust T4 for correct figure as shown. It may be necessary to increase or decrease the sweep generator output for adjustment convenience.



Correct



Incorrect,  
as too low



Incorrect,  
as too narrow

### Tuning Meter

- 1) Remove signal generator output from the unit.
- 2) Adjust T5 for exact center reading on the FM Center Tun-

ing meter.

### IF Distortion

- 1) Apply 98 MHz, 1 kHz and 100% modulated, 65 dBf signal to the unit.

- 2) Adjust T6 for minimum distortion on the distortion analyzer connected to the Tape/Rec output terminal.

### FM Signal Strength Meter [330R/RL only]

- 1) Apply 98 MHz, 90 dBf signal to the unit.
- 2) Tune the unit for 98 MHz.

- 3) Adjust RV1 for 90% reading on the signal strength meter.

### Mute Circuit

- 1) Apply 98 MHz, 20 dBf signal to the unit.
- 2) Tune the unit (with the Mute switch in the Off position).

- 3) Set the Mute switch to the On position.
- 4) Adjust RV2 so that the signal is muted.

### Pilot Signal (76 kHz)

- 1) Apply 98 MHz, 65 dBf signal to the unit with no modulation.
- 2) Adjust RV4 for 76 kHz reading on the frequency counter

connected between TP and chassis ground. A deviation of  $\pm 200$  Hz is acceptable.

### Stereo Separation

- 1) Apply 98 MHz, 65 dBf **left channel** signal to the unit modulated with 1 kHz, 9% pilot signal of 6.75 kHz deviation.
- 2) Connect a digital voltmeter to the **right channel** Tape/Rec output terminal.
- 3) Adjust RV3 for minimum leakage (minimum level) on the voltmeter.

- 4) Apply 98 MHz, 65 dBf **right channel** signal to the unit modulated same as step 1).
- 5) Move digital voltmeter to the **left channel** Tape/Rec output terminal.
- 6) Adjust RV3 for minimum level.

### AM IF Amplifier

- 1) Apply 455 kHz sweep generator output to the unit AM antenna terminal.
- 2) Connect scope to the pin number 12 of IC3.
- 3) Adjust T8 to obtain maximum and symmetrical display as shown.



### AM (MW) Tracking

- 1) Apply 600 kHz, 30% modulated with 1 kHz to the AM bar antenna. See test setup figure (Distance between the AM bar antenna and emitting loop antenna should be 2 feet).
- 2) Adjust signal generator output so that a sine wave appears on the scope.
- 3) Adjust T9 for maximum audio output on the digital volt-

- meter connected parallel with the scope. When turning core, always adjust signal generator output to maintain proper level. Do not change voltmeter range. Moreover, always keep the generator output as low as possible to avoid AGC action and to keep the measurements accurate.
- 4) Adjust the AM loopstick antenna core for maximum output

## Scott 320R,330R/RL

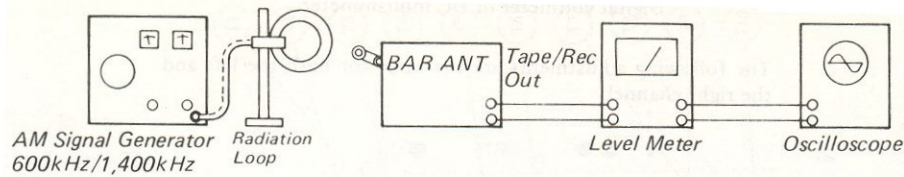

- reading on the voltmeter.
- Shift generator frequency to 1,400 kHz with same modulation condition.
  - Repeat 2).

- Adjust CTe (CT5, 330RL) for maximum voltmeter reading.
- Adjust CTd (CT4, 330RL) for maximum reading on the voltmeter.
- Repeat above procedure again.

### Long Wave Tracking [330RL only]

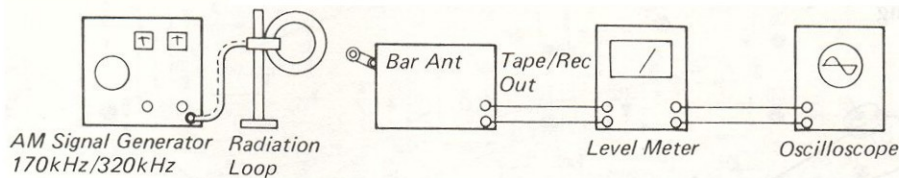

- Apply 170 kHz generator output modulated 30% with 400 Hz. See test set-up figure. Set two antennas in a distance of 2 foot. Set the EXT antenna switch to INT position.
- Adjust T10 and then long wave loop stick antenna core for maximum output from the speaker output terminal.
- Shift generator frequency to 320 kHz with same modulation condition.

- Adjust CT5 (paralleled with C78) for maximum output from the speaker output terminal.
- Adjust CT2 (On PSAZ024COX) for maximum output from the speaker output terminal.
- Repeat above procedure.

### External Long Wave Antenna Tuning [330RL Only]

- Apply 170 kHz generator output modulated 30% with 400 Hz audio. Set the EXT antenna switch to EXT position.
- Adjust generator output to observe sine wave on the scope.

- Adjust T1 for maximum audio output.
- Shift generator frequency to 320 kHz with same modulation condition.
- Adjust CT3 for maximum audio output.

### Audio Adjustment

#### Equipment Required

Audio signal generator.  
DC voltmeter.



Speaker load resistors, 8 ohm, 100 watt.  
Digital voltmeter or DC milliammeter.

The following adjustments are the same for both the left and the right channel.

### Bias Adjustment

- 1) Connect 8 ohm resistors to the speaker A terminals, and set the Speaker A switch to on position.
- 2) Turn the Volume control fully counter-clockwise.
- 3) Turn RV7 fully counterclockwise.
- 4) Depending on available equipment, use A or B:
  - A. Set digital voltmeter to most sensitive voltage range. Connect probes across R219 and R221 (Voltmeter bias test points, L channel). Turn unit on. Let it idle for at least one minute. Adjust RV7 for 40 mV across the resistors.
  - B. With unit off, remove jumper between PC board terminals JK and JK, and connect ammeter, set to 100 mA range. Turn unit on and left it idle for at least one minute. Adjust RV7 for 40 mA.
- 5) Perform the same procedure for the right channel, except measure voltage across R220 and R222 (voltmeter bias test points, R channel) or replace jumper from JL to JL with ammeter. Adjustment is made with RV8.
- 6) Leave the amplifier on for about 30 minutes, then recheck measurement. A tolerance of  $\pm 25\%$  is acceptable. Re-adjust if necessary.

### Dial Cord Stringing

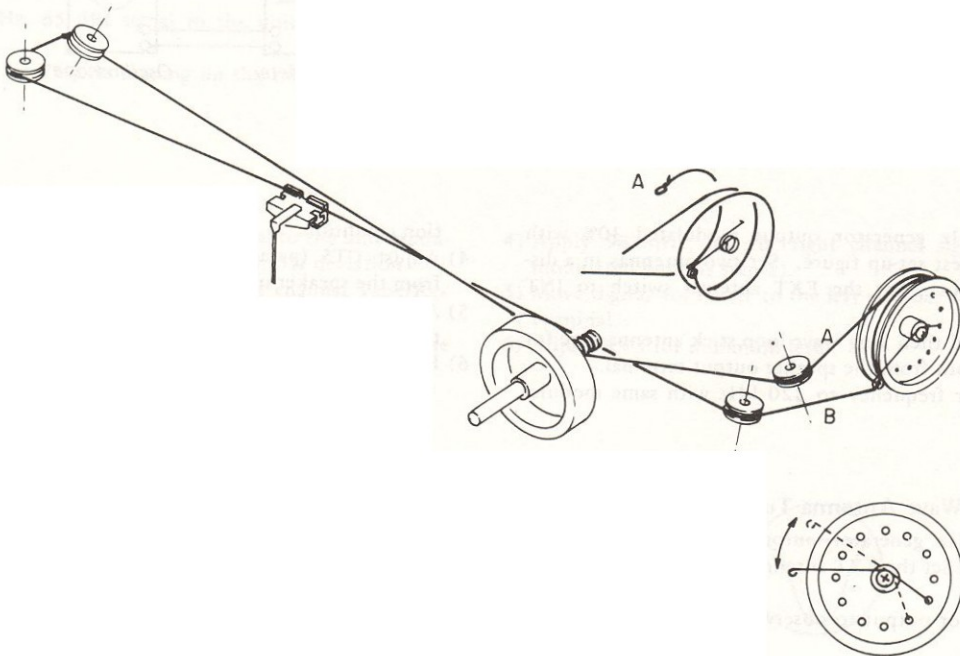

- 1) Loosen the screw securing the drum to the variable capacitor shaft.
- 2) Tie the end of the cord "A" as shown to the fixing protrusion on the drum.
- 3) Wind the cord two turns around the drum then thread it through the rollers, etc, following the illustration.
- 4) Tie the end of the cord to the coiled spring so that the proper tension of the dial cord is obtained.
- 5) Align the pointer position for the correct frequency indication on the tuning dial.
- 6) Secure the screw on the drum.



# Scott 320R,330R/RL

## Adjustment Location

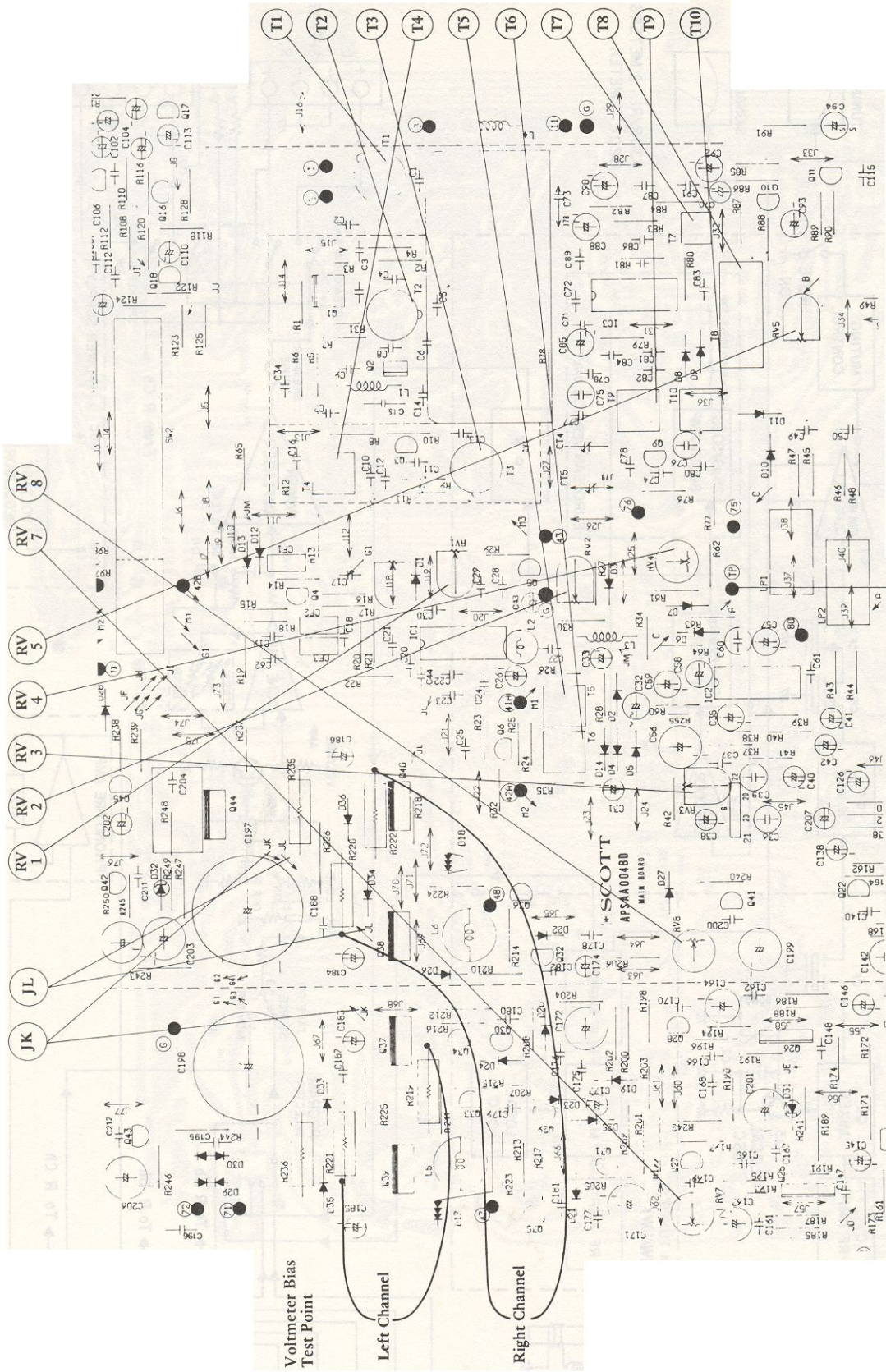

Voltmeter Bias Test Point

Left Channel

Right Channel

Used For Pilot Signal [76 kHz] Adjustment.

TP



# BLOCK DIAGRAM 330R/RL/320R

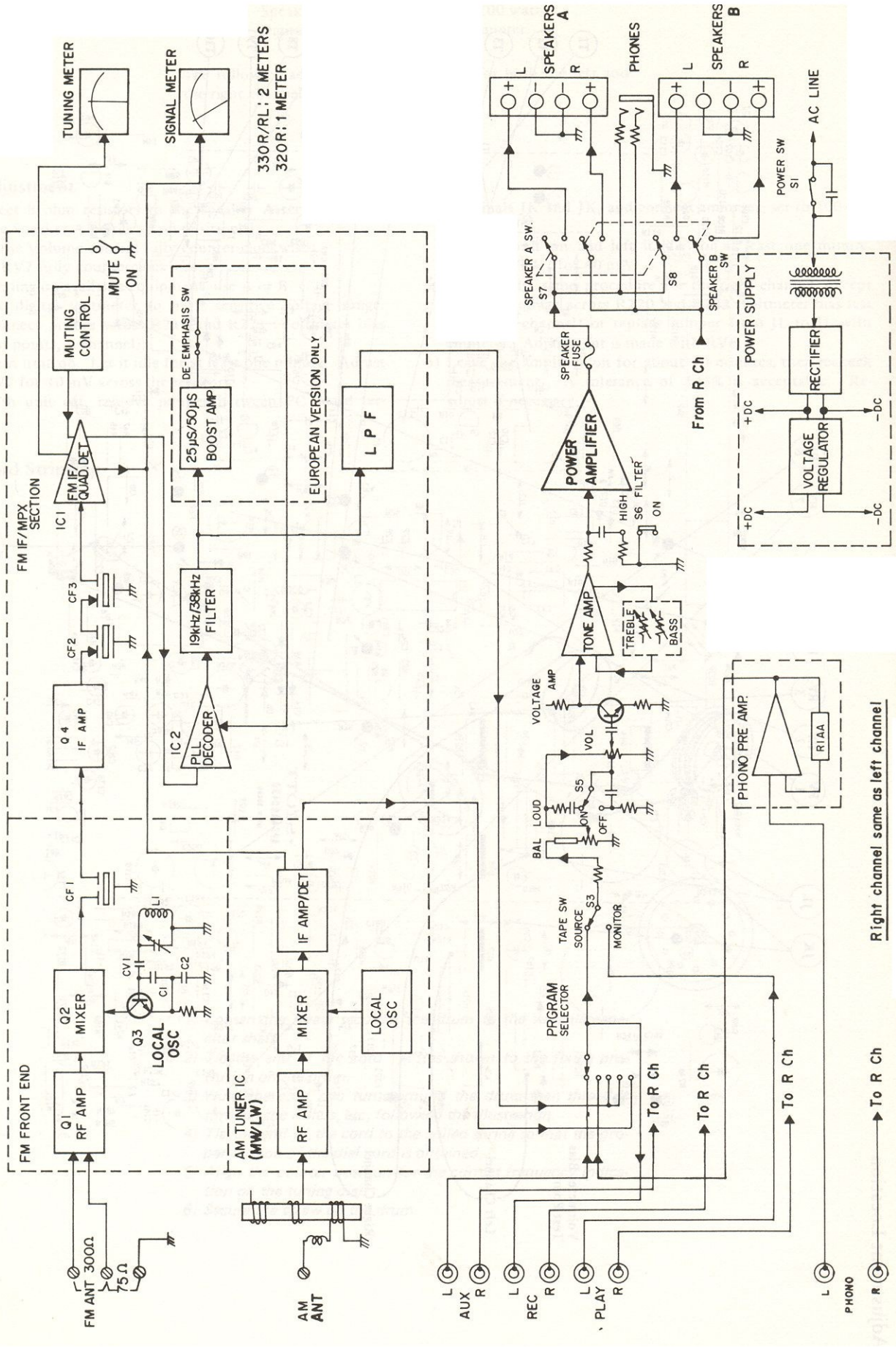

Right channel same as left channel



# SCHEMATIC DIAGRAM: 320R

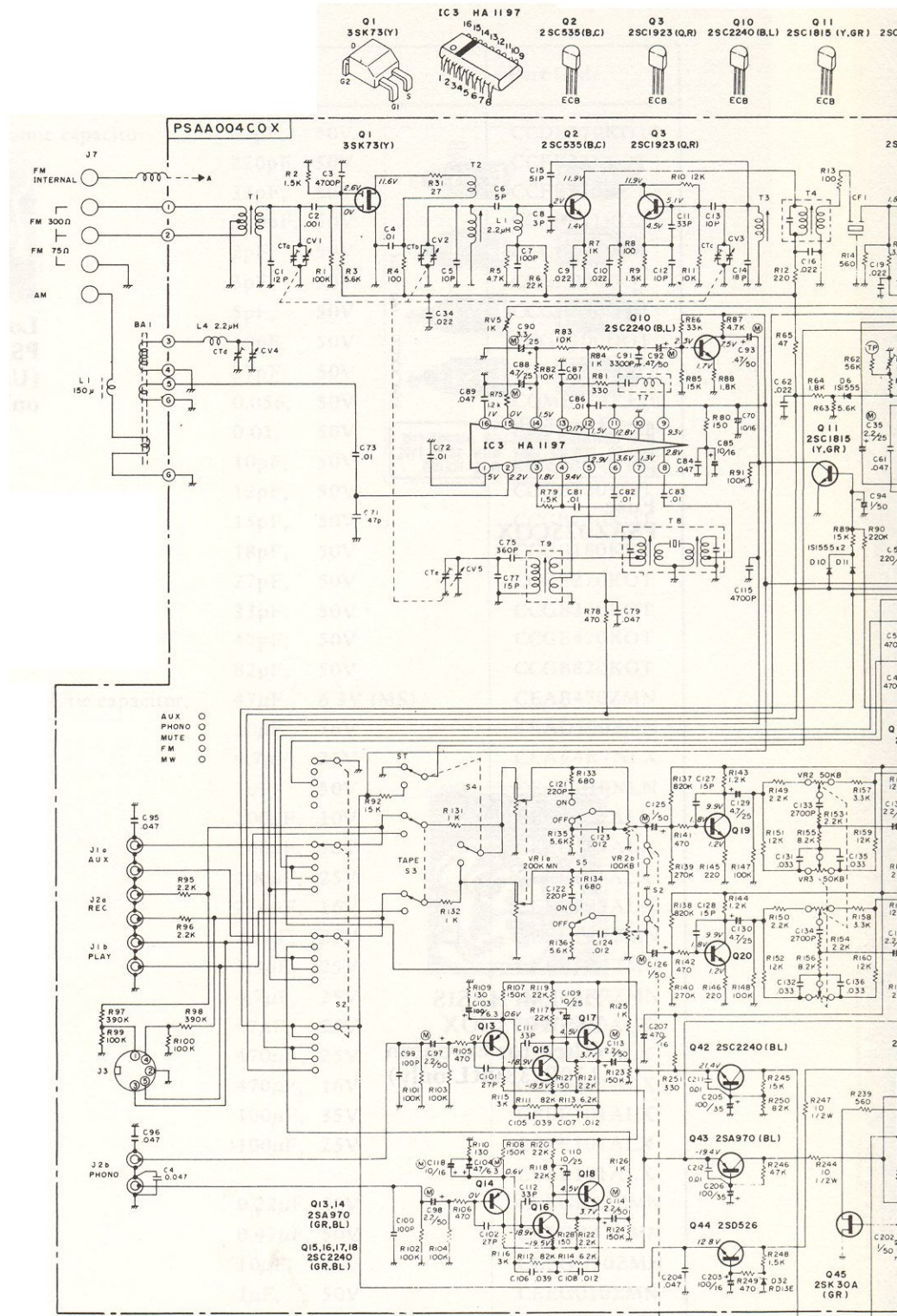

NOTE 1 ALL VOLTAGES MEASURED FROM COMMON NEGATIVE CHASSIS GROUND WITH VTVM AT NO SIGNAL  
 2 CAPACITORS VALUES ARE IN  $\mu$ F UNLESS OTHERWISE NOTED  $\mu$  = PICO FARAD  
 3 RESISTORS VALUES ARE IN OHM K = K OHM 4 VOLTAGES IN | | WHEN MUTE ON  
 5 VOLTAGES IN | | WHEN AM

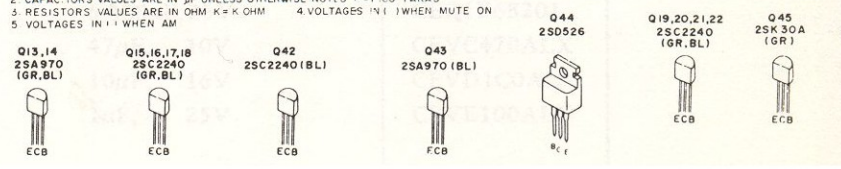



Q11 2SC1815 (Y,GR)  
Q4 2SC1923 (Q,R)

IC1 HA1137W

IC2 HA1196

Q5 2SC1815 (Y,GR)

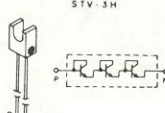
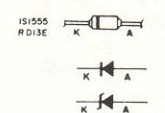
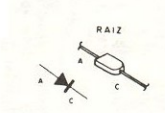
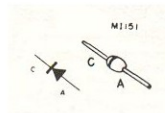
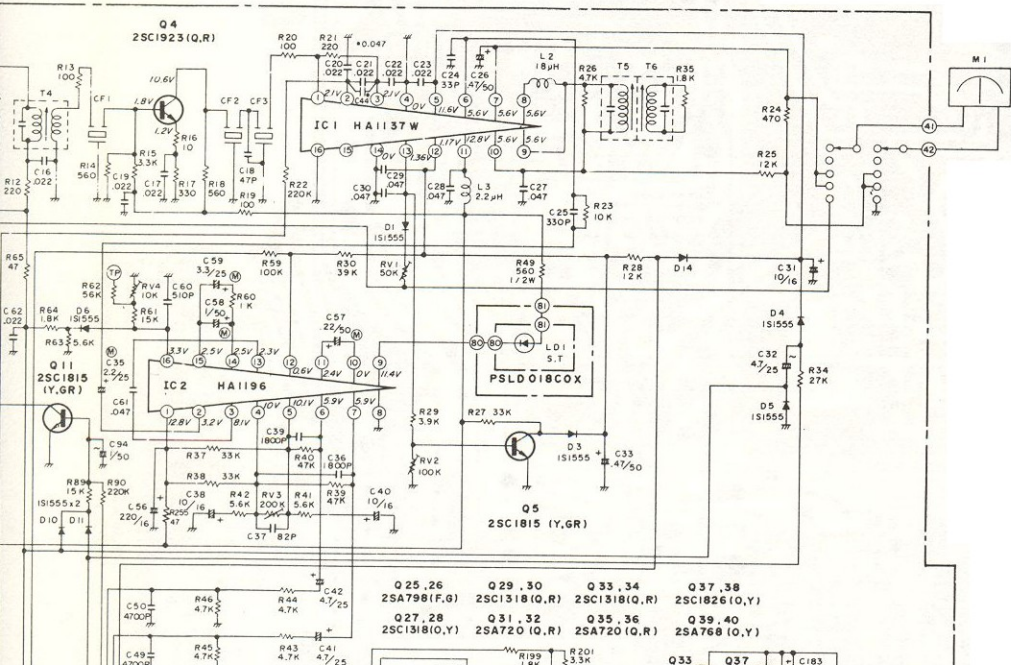
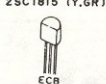
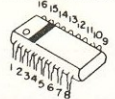
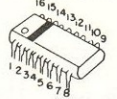
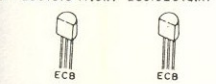

Q25, 26 2SA798 (F,G)    Q29, 30 2SC1318 (Q,R)    Q33, 34 2SC1318 (Q,R)    Q37, 38 2SC1826 (O,Y)  
Q27, 28 2SC1318 (O,Y)    Q31, 32 2SA720 (Q,R)    Q35, 36 2SA720 (Q,R)    Q39, 40 2SA768 (O,Y)

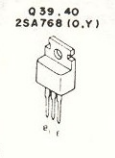
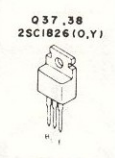
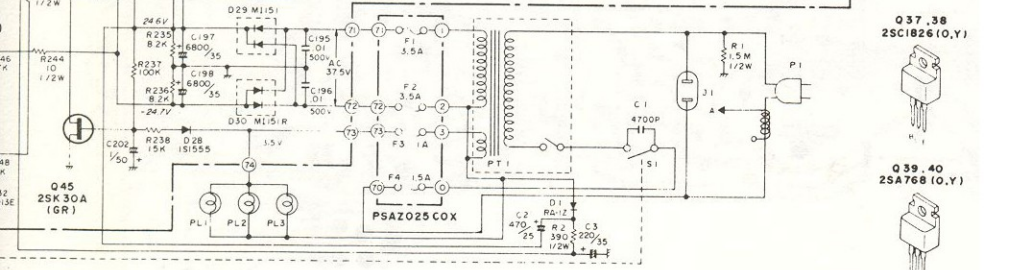
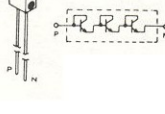
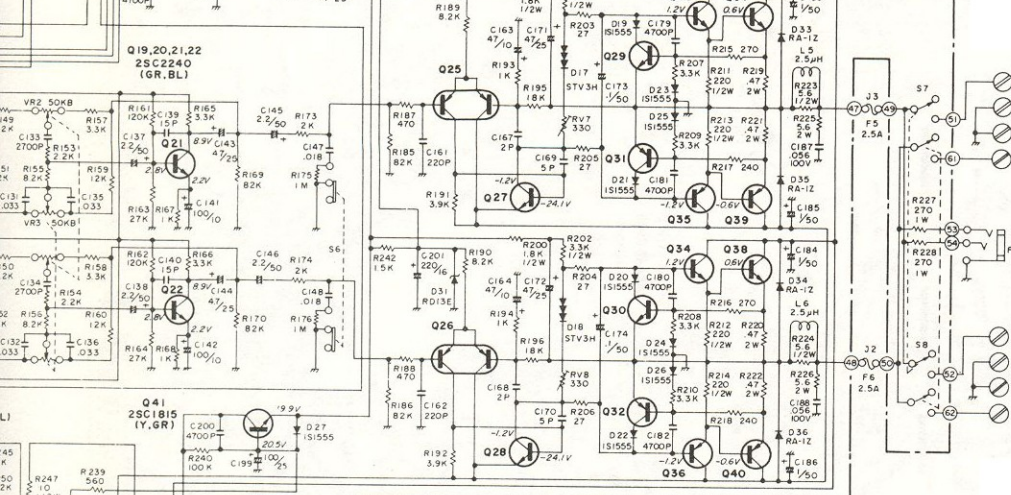

Q45 2SK30A (GR)    Q41 2SC1815 (Y,GR)    Q25, 26 2SA798 (F,G)    Q27, 28 2SC1318 (O,Y)    Q29, 30 2SC1318 (Q,R)    Q31, 32 2SA720 (Q,R)    Q33, 34 2SC1318 (Q,R)    Q35, 36 2SA720 (Q,R)





# SCHEMATIC DIAGRAM: 320R

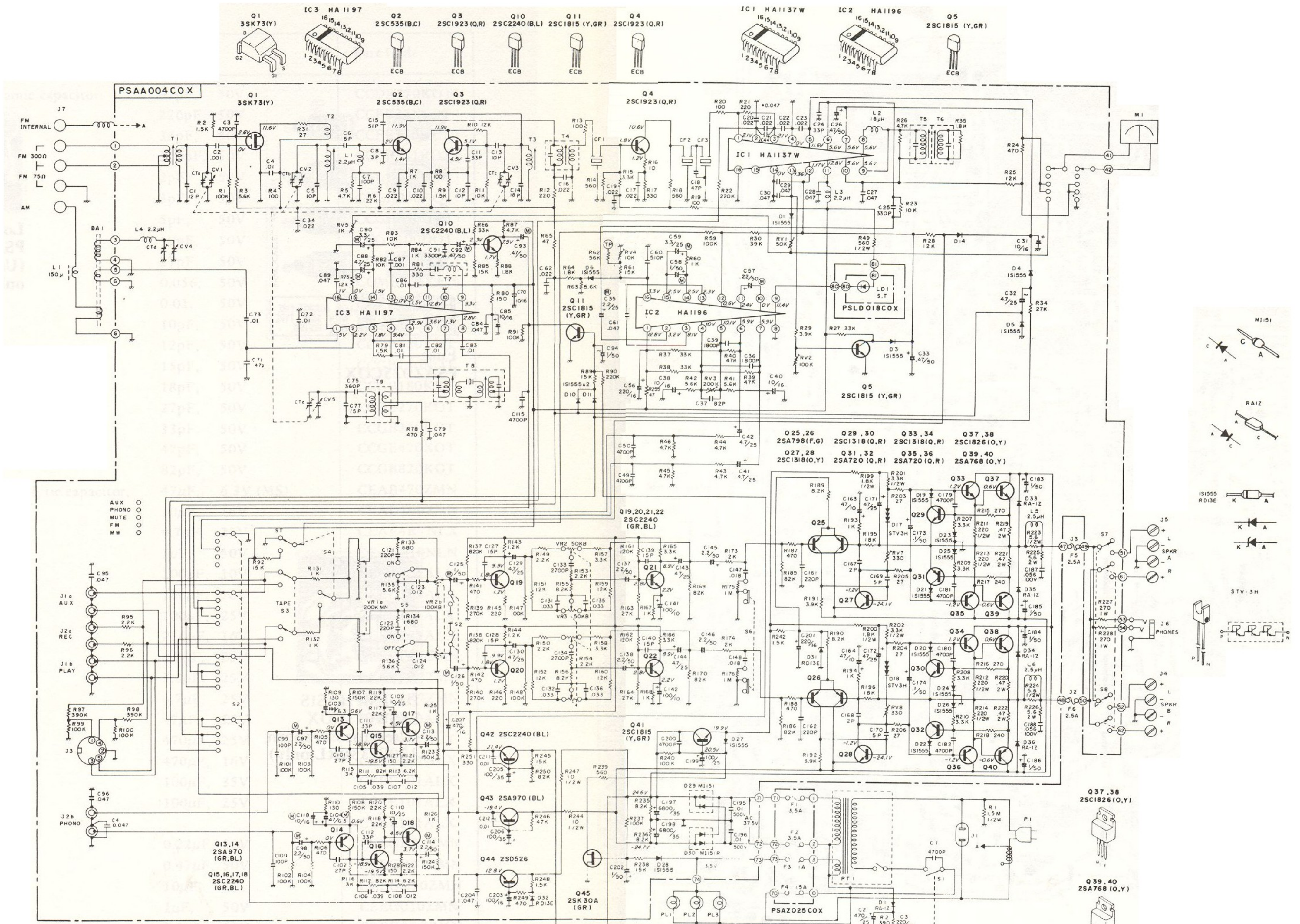

NOTE 1 ALL VOLTAGES MEASURED FROM COMMON NEGATIVE CHASSIS GROUND WITH VTVM AT NO SIGNAL.  
 2 CAPACITORS VALUES ARE IN  $\mu$ F UNLESS OTHERWISE NOTED P=PICO FARAD  
 3 RESISTORS VALUES ARE IN OHM K=K OHM 4 VOLTAGES IN  $\mu$ V WHEN MUTE ON  
 5 VOLTAGES IN  $\mu$ V WHEN AM

- |                               |  |                     |                    |               |                                     |                       |                           |                         |                          |                          |                         |                          |                         |
|-------------------------------|--|---------------------|--------------------|---------------|-------------------------------------|-----------------------|---------------------------|-------------------------|--------------------------|--------------------------|-------------------------|--------------------------|-------------------------|
| Q13, 14<br>2SA970<br>(GR, BL) | Q15, 16, 17, 18<br>2SC2240<br>(GR, BL) | Q42<br>2SC2240 (BL) | Q43<br>2SA970 (BL) | Q44<br>2SD526 | Q19, 20, 21, 22<br>2SC2240 (GR, BL) | Q45<br>2SK30A<br>(GR) | Q41<br>2SC1815<br>(Y, GR) | Q25, 26<br>2SA798(F, G) | Q27, 28<br>2SC1318(O, Y) | Q29, 30<br>2SC1318(O, R) | Q31, 32<br>2SA720(O, R) | Q33, 34<br>2SC1318(O, R) | Q35, 36<br>2SA720(O, R) |
|-------------------------------|--|---------------------|--------------------|---------------|-------------------------------------|-----------------------|---------------------------|-------------------------|--------------------------|--------------------------|-------------------------|--------------------------|-------------------------|

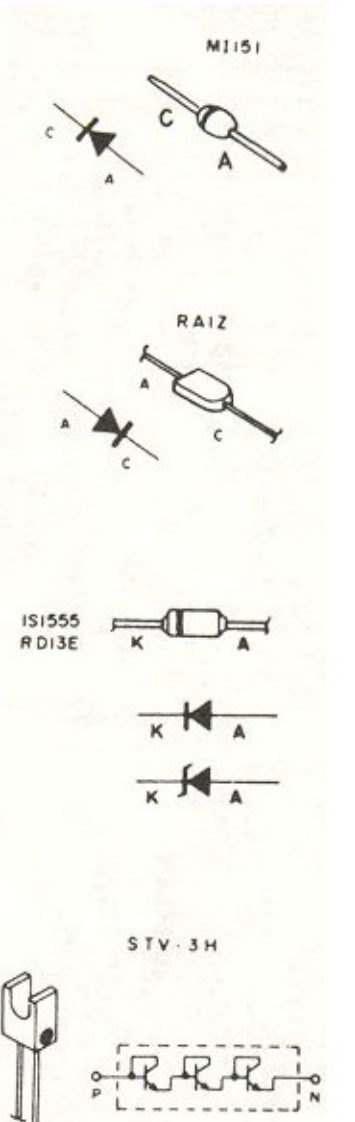



Scott 320R,330R/RL

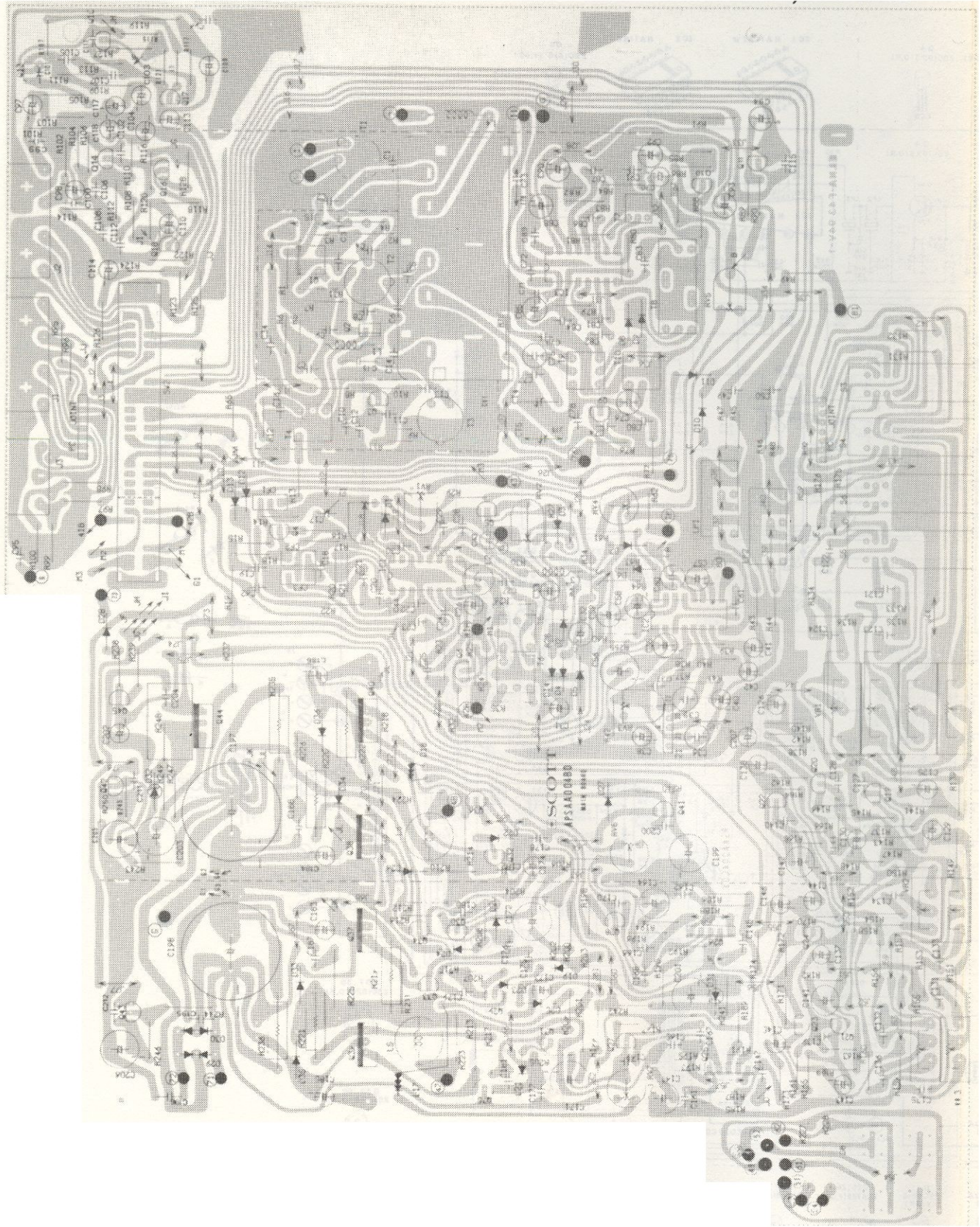



(Parts Location Diagram Continued)

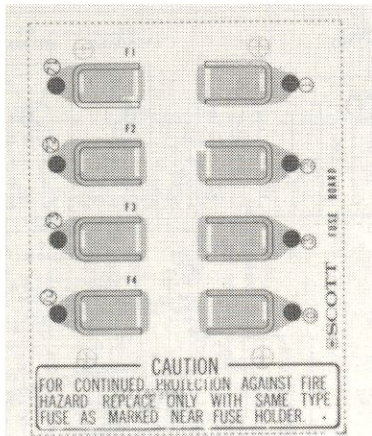

Fuse  
PSAZ025COX

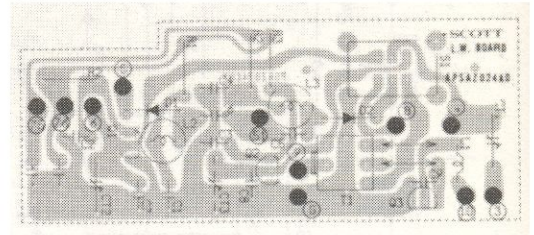

Long Wave  
PSAZ024COX  
(Used for 330RL  
only)

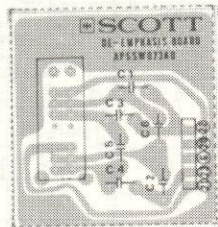

DE-EMPHASIS  
PSSW073COX  
(Used for European  
330R/330RL only)

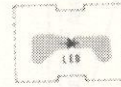

Stereo Indicator  
PSLD018COX

# REPLACEMENT PARTS LIST: 320R(330R/RL)

FM, AM, IF PC Board [PSAA004COX]

Symbol No.	Description	Part Code
C71	Ceramic capacitor, 47pF, 50V	CCDB470KOT
C121, 122, 161, 162	" 220pF, 50V	CCFB221KOT
C11	" 33pF, 50V	CCFB330KCT
C25	" 330pF, 50V	CCFB331KOT
C167, 168	" 2pF, 50V	CCGB020COT
C8	" 3pF, 50V	CCGB030DOT
C6, 169, 170	" 5pF, 50V	CCGB050DOT
C12, 13	" 10pF, 50V	CCGB100DOT
C37 (European 330R only)	" 27pF, 50V	CC6B270KOT
C91 (330RL only)	" 0.056, 50V	CQMB563KEH
C73 (330RL only)	" 0.01, 50V	CKFB103MDT
C7, 99, 100	" 10pF, 50V	CCGB100DOT
C1	" 12pF, 50V	CCGB120KOT
C77, 127, 128, 139, 140	" 15pF, 50V	CCGB150KOT
C14	" 18pF, 50V	CCGB180KRT
C101, 102	" 27pF, 50V	CCGB270KOT
C24, 111, 112	" 33pF, 50V	CCGB330KOT
C78 (330RL only)	" 47pF, 50V	CCGB470KOT
C37	" 82pF, 50V	CCGB820KOT
C103, 104 (*)	Electrolytic capacitor, 47 $\mu$ F, 6.3V (MS)	CEAB470ZMN
C117, 118 (**)	" 10 $\mu$ F, 16V	CEAD100ZMN
C32	" 4.7 $\mu$ F, 25V	CEAE4R7NLX
C94	" 1 $\mu$ F, 50V	CEAG010NLN
C141, 142	" 100 $\mu$ F, 10V	CEEC1C1ALX
C203	" 100 $\mu$ F, 16V	CEED101ALX
C205/206 (320R only)	" 100 $\mu$ F, 25V	CEEE101ALX
C56, 201	" 220 $\mu$ F, 16V	CEED221ALX
C35	" 2.2 $\mu$ F, 25V	CEEE2R2ZMN
D59, 90	" 3.3 $\mu$ F, 25V	CEEE3R3ZMN
C88	" 4.7 $\mu$ F, 25V	CEEE4R7ZMN
C171, 172	" 47 $\mu$ F, 25V	CEEE470ALX
C207	" 470 $\mu$ F, 25V	CEEE471ALX
C207 (320R only)	" 470 $\mu$ F, 16V	CEED471ALX
C199 (330R/RL)	" 100 $\mu$ F, 35V	CEEF101ALX
C199 (320R)	" 100 $\mu$ F, 25V	CEEE101ALX
C205/206 (330R/RL only)	"	CEEE101ALX
C57	" 0.22 $\mu$ F, 50V	CEEGR22ZMN
C26, 33, 92	" 0.47 $\mu$ F, 50V	CEEGR47ZMN
C93, 70	" 10 $\mu$ F, 16V	CEEGD10ZMN
C58, 125, 126	" 1 $\mu$ F, 50V	CEEG010ZMN
C97, 98, 113, 114	" 2.2 $\mu$ F, 50V	CEEG2R2ZMN
C197, 198	" 6,800 $\mu$ F, 25V	CEQ1F68201
C163, 164	" 47 $\mu$ F, 10V	CEVC470ALX
C31, 78, 40, 85	" 10 $\mu$ F, 16V	CEVD1C0ALX
C109, 110	" 1 $\mu$ F, 25V	CEVE100ALX

\* C103/104 are 100  $\mu$ F/6.3V for units produced for US/Canada with part code of CEAB101ALX.

\*\* C117/118 are deleted from units produced for US/Canada.



Symbol No.	Description		Part Code
C41, 42, 129, 130, 143, 144, 202 (330R/RL)	Electrolytic capacitor,	4.7 $\mu$ F, 25V	CEVE4R7A1X
C202 (320R)	"	1 $\mu$ F, 50V	CEVG010ALX
C45, 173, 174, 183-186	"	1 $\mu$ F, 50V	CEVG010ALX
C137, 138, 145, 146	"	2.2 $\mu$ F, 50V	CEVG2R2ALX
C43	"	10 $\mu$ F, 16V	CEVD100ALX
C15	Mini capacitor,	0.51pF, 500V	CG2HR51KNN
C195, 196, 73 (320R/330R only)	Ceramic capacitor,	0.01 $\mu$ F, 500V	CKDE103PEM
C4, 72, 74 (330RL only), 81-83	"	0.01 $\mu$ F, 50V	CKFB103ZFT
C211, 212	"	0.01 $\mu$ F, 50V	CKFB103ZFT
C9, 10, 16, 17, 19-23, 34, 62	"	0.022 $\mu$ F, 50V	CKFB223ZFT
C3, 115	"	4,700pF, 50V	CKFB472KBT
C200	"	4,700pF, 50V	CKFB472MDT
C204, 27-30, 28-30, 44, 61, 79, 80 (330RL only), 84, 89, 95, 96, 204	"	0.047 $\mu$ F, 50V	CKFB473ZFT
C2	"	1,000pF, 50V	CKGB102KBT
C179-182	"	4,700pF, 50V	CKGB472ZFT
C49/50 (330R/RL)	"	680pF, 50V	CKGB681KBT
C49/50 (320R)	Mylar capacitor,	0.047 $\mu$ F, 50V	CQMB472KEH
C87	"	1,000pF, 50V	CQMB102KEH
C86	"	0.01 $\mu$ F, 50V	CQMB103KEH
C107, 108	" (AWS),	0.012 $\mu$ F, 50V	CQMB123GEH
C123, 124	"	0.12 $\mu$ F, 50V	CQMB124KEH
C147, 148	"	0.018 $\mu$ F, 50V	CQMB183KEH
C133, 134	"	2,700pF, 50V	CQMB272KEH
C131, 132, 135, 136	"	0.033 $\mu$ F, 50V	CQMB333KEH
C105, 106	" (AWS),	0.039 $\mu$ F, 50V	CQMB393GEH
C91 (330RL only)	"	0.0033 $\mu$ F, 50V	CQMB563KEH
C187, 188	Polypropylene capacitor,	0.056 $\mu$ F, 100V	CQMC563KEH
C36/39 (330RL only)	Styroflex capacitor,	1,100pF, 100V	CQSC112JCF
C76 (330RL only)	"	160pF, 100V	CQSC161JCF
C75	"	360pF, 100V	CQSC361JCF
C36/39 (European 330R only), 60	"	510pF, 100V	CQSC511JCF
CT4 (330RL only)	Trimming capacitor,	8p	CTX1080P06
CT5 (330RL only)	"	15p	CTX1150P01
CV (330RL)	Variable capacitor,	5 gung, Tuning	CVA2333G03
CV (330R/320R)	"		VCA2333G02
T8	IFT + ceramic filter,	455 kHz	FBR455A18Q



# SCHEMATIC DIAGRAM: 330R

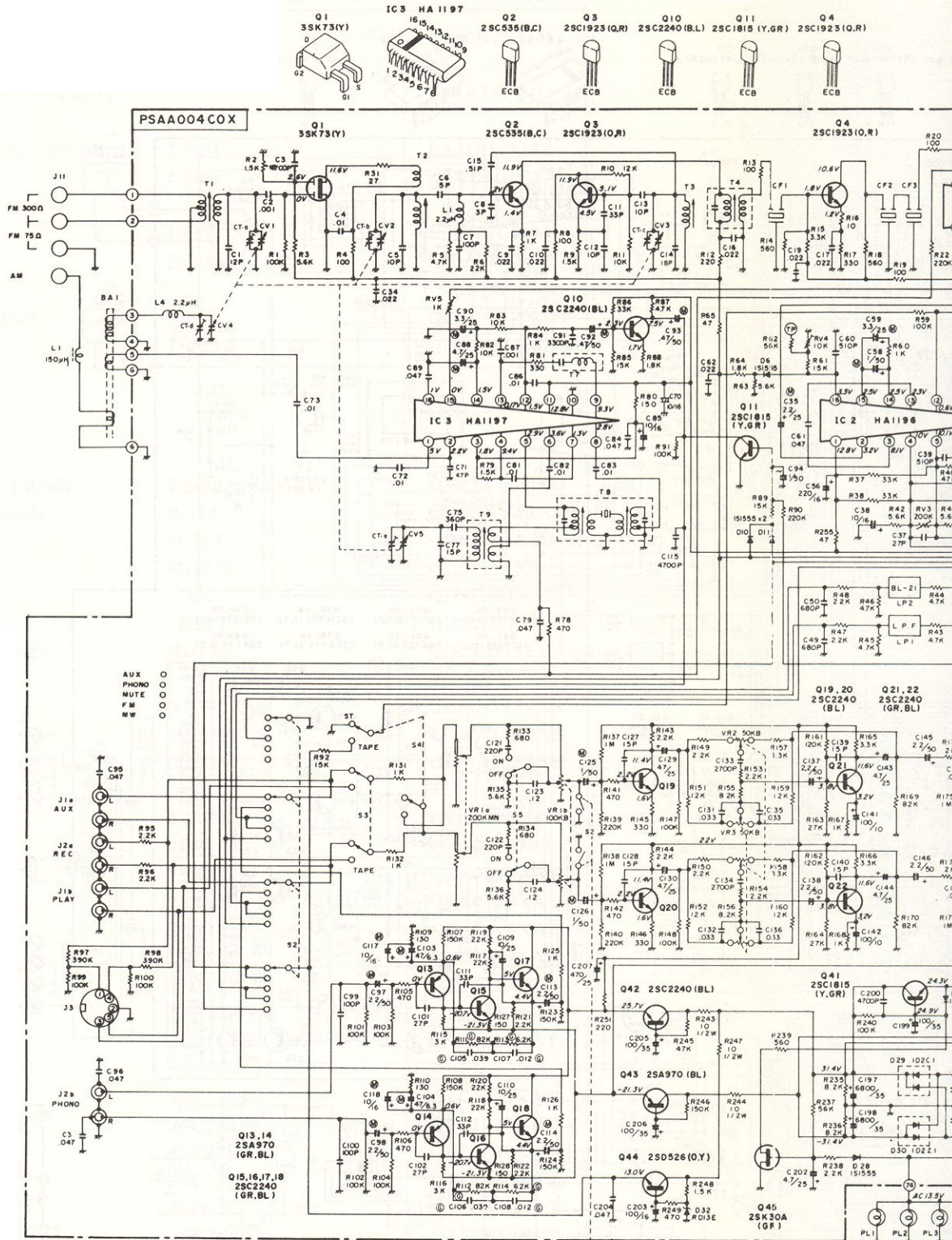

NOTE: 1. ALL VOLTAGES MEASURED FROM COMMON NEGATIVE CHASSIS GROUND WITH VTVM AT NO SIGNAL.  
 2. CAPACITORS VALUES ARE IN µF UNLESS OTHERWISE NOTED P = PICO FARAD  
 3. RESISTORS VALUES ARE IN OHM K = K OHM 4. VOLTAGES IN ( ) WHEN MUTE ON  
 5. VOLTAGES IN ( ) WHEN AM

- |                             |                                    |                     |                    |               |                                    |                       |                          |                       |
|-----------------------------|------------------------------------|---------------------|--------------------|---------------|------------------------------------|-----------------------|--------------------------|-----------------------|
| Q13,14<br>2SA970<br>(GR,BL) | Q15,16,17,18<br>2SC2240<br>(GR,BL) | Q42<br>2SC2240 (BL) | Q43<br>2SA970 (BL) | Q44<br>2SD526 | Q19,20,21,22<br>2SC2240<br>(GR,BL) | Q45<br>2SK30A<br>(GR) | Q41<br>2SC1815<br>(Y,GR) | Q25,26<br>2SA798(F,P) |
|-----------------------------|------------------------------------|---------------------|--------------------|---------------|------------------------------------|-----------------------|--------------------------|-----------------------|





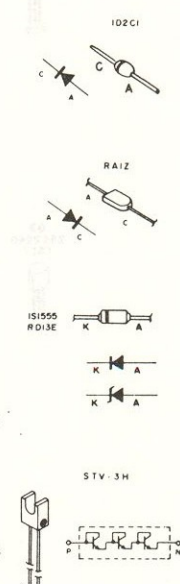
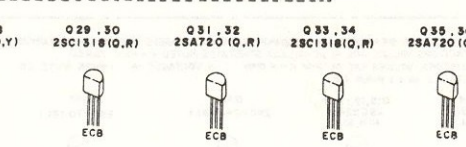
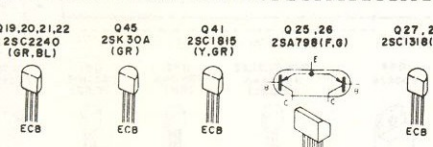
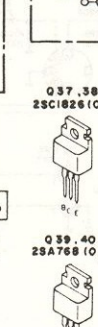
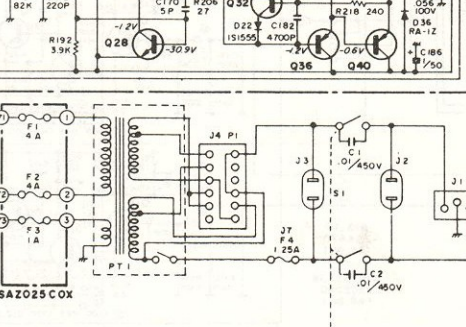
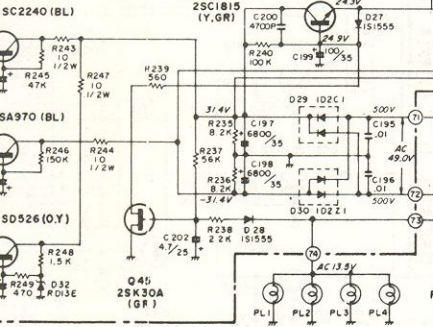
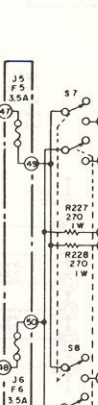
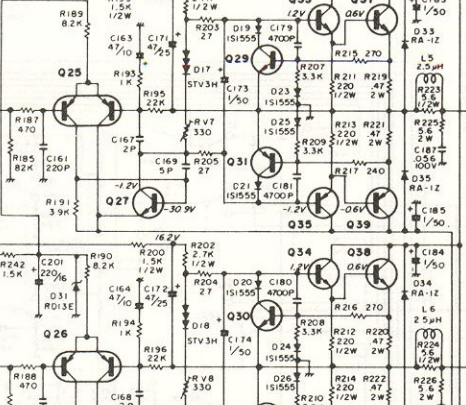
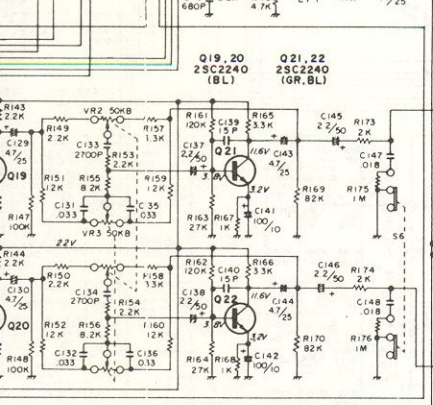
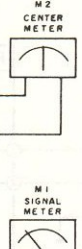
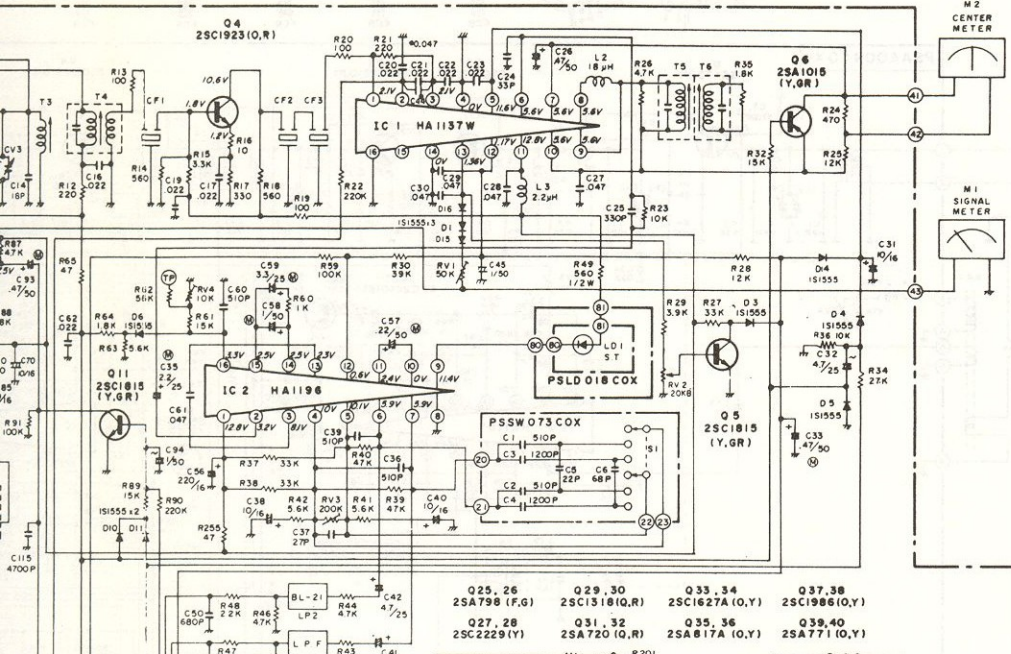
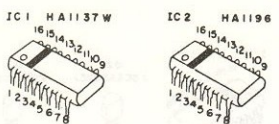
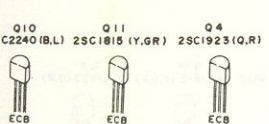







# SCHEMATIC DIAGRAM: 330RL

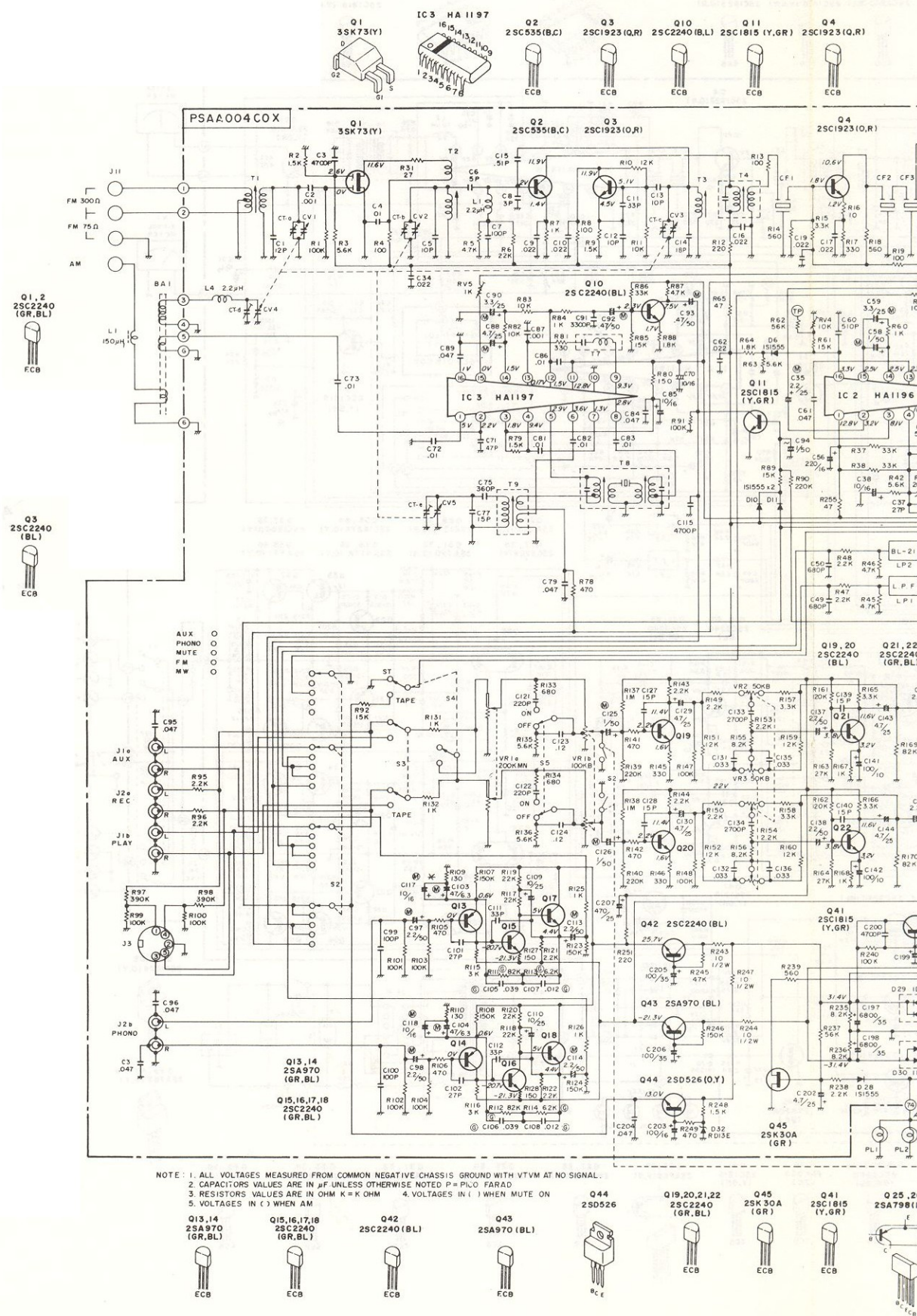

NOTE: 1. ALL VOLTAGES MEASURED FROM COMMON NEGATIVE CHASSIS GROUND WITH VTVM AT NO SIGNAL.  
 2. CAPACITORS VALUES ARE IN μF UNLESS OTHERWISE NOTED P=PICOFARAD  
 3. RESISTORS VALUES ARE IN OHM K=K OHM 4. VOLTAGES IN ( ) WHEN MUTE ON  
 5. VOLTAGES IN ( ) WHEN AM

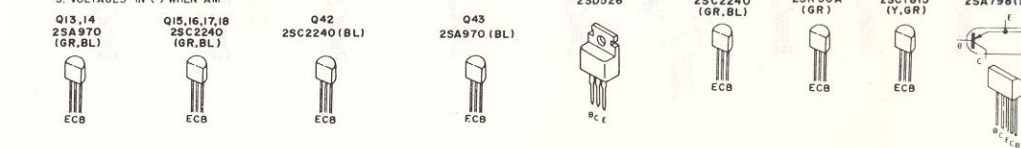

\*C117/118 and C103/104 are each replaced with 100 μF/6.3V capacitor for units produced for US/Canada.



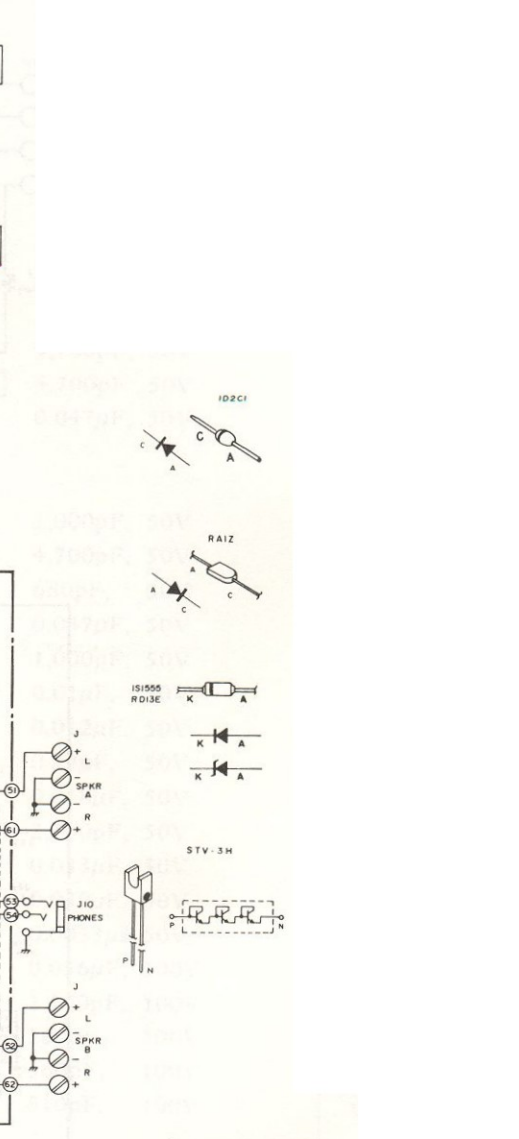
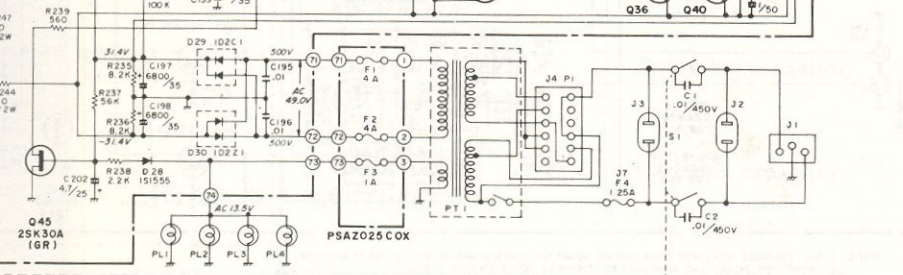
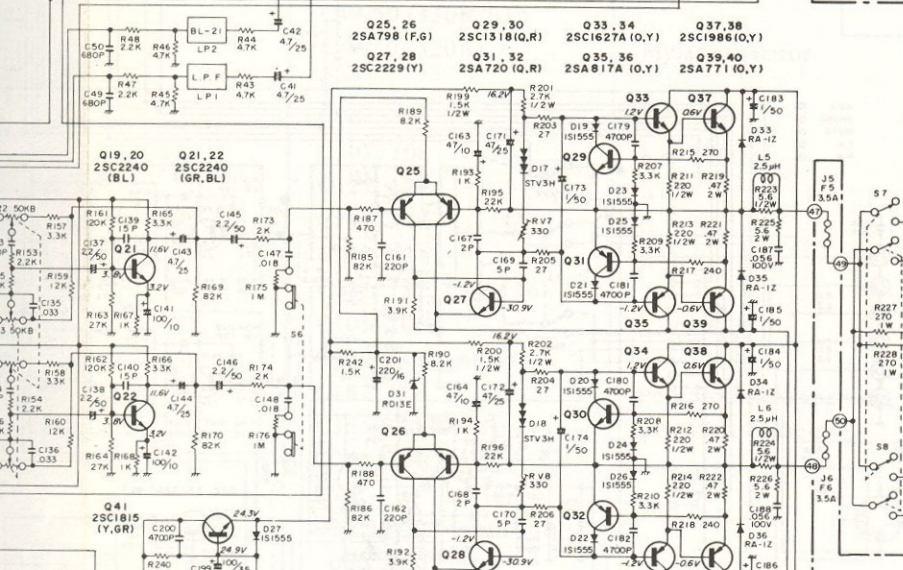
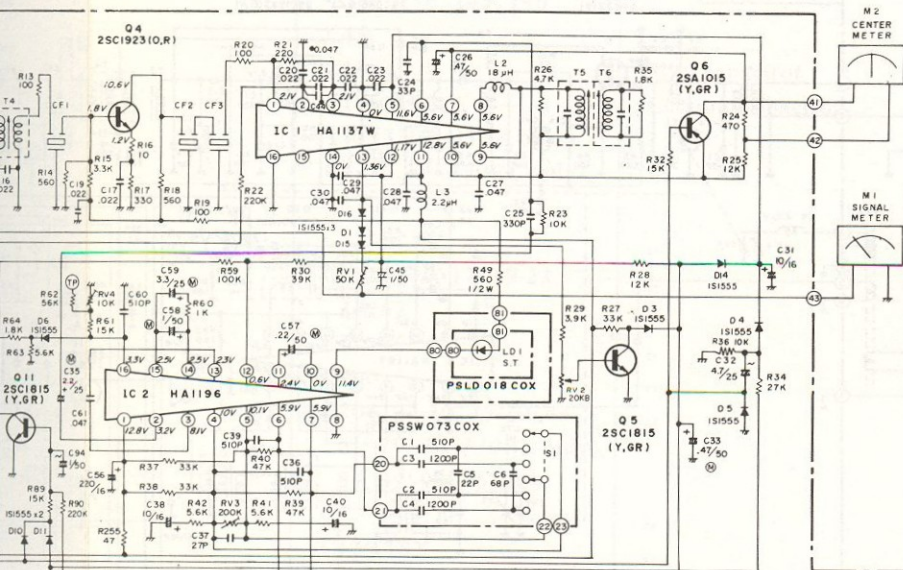
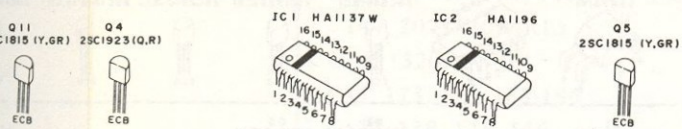

**AC Input Circuit of Units for US/Canada.**

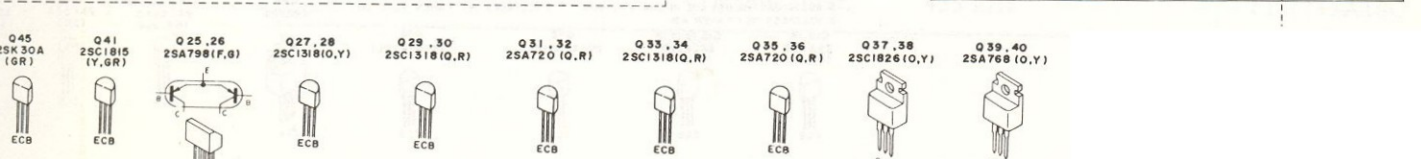
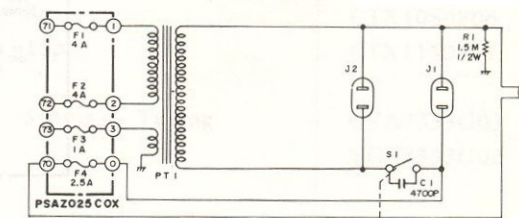



# SCHEMATIC DIAGRAM: 330RL

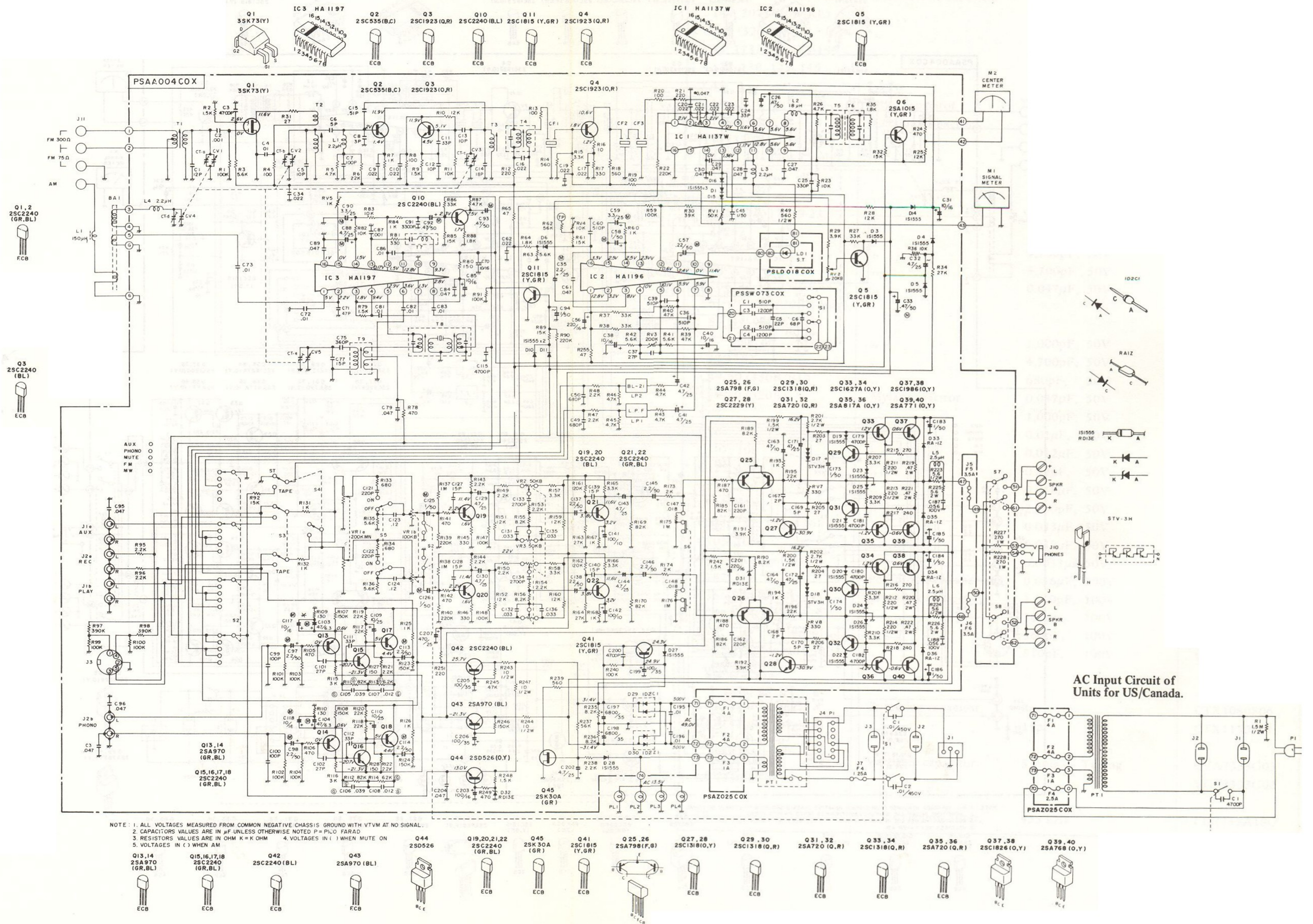

2. CAPACITOR VALUES ARE IN μF UNLESS OTHERWISE NOTED P= PICO FARAD

3. RESISTOR VALUES ARE IN OHM K=K OHM 4. VOLTAGES IN ( ) WHEN MUTE ON

5. VOLTAGES IN ( ) WHEN AM

\*C117/118 and C103/104 are each replaced with 100 μF/6.3V capacitor for units produced for US/Canada.



## Scott 320R,330R/RL

Symbol No.	Description	Part Code
CF1-3	Ceramic filter, 10.7MHz	FB10R7F14M
LP1, 2 (320R only)	19/38kHz MPX filter	FJRR38L04C
L5, 6	Choke coil, 5P output, 2.5μH	LA3QH1323B
L1, 3, 4 (320R/330R only)	RFC, 2.2μH	LCADA3038A
L2	" 1.8μH	LF180JC01K
L7 (330RL only)	" 56mH	LF563KC01S
D33-86	Silicon diode, RA1Z	QDSRA1ZXXD
D1 (330R/RL only), 3-6, 8/9 (330RL only), 10, 11, 12/13 (330RL only), 14, 19-28, 29/30 (330R/RL only), 31, 32	" 1S1555	QDSS1555XT
D17, 18	Transistor diode, 3-gang, STV-4H	QVESTV3HXD
D33-36	Silicon diode, RA1Z	QDSRA1ZXXD
D29 (320R only)	" M1151	QDS1151X3D
D30 (320R only)	" M1152R	QDS1151R3D
D29	" 1D2C1	QDS1D2C1XT
D30	" 1D2Z1	QDS1D2Z1XT
D31, 32	Zenner diode, RD13E	QDZRD13EXA
IC1	IC, HA1137W	QQMA1137AB
IC2	" HA1196	QQMA1196AB
IC3	" HA1197	QQMA1197AB
Q31, 32	Transistor, 2SA720	QTA0720XBN
Q25, 26	" 2SA798	QTA0798XEE
Q35, 36 (330R/RL only)	" 2SA817A	QTA0817AAT
Q13, 14, 43	" 2SA970	QTA0970XAT
Q6 (330R/RL only)	" 2SA1015	QTA1015XAT
Q2	" 2SC535	QTC0535XAB
Q29, 30	" 2SC1318	QTC1318XDN
Q33, 34 (330R/RL only)	" 2SC1627A	QTC1627AAT
Q5, 9, (330RL only) 11, 41	" 2SC1815	QTC1815XAT
Q3, 4	" 2SC1923	QTC1923XAT
Q27, 28 (330R/RL)	" 2SC2229	QTC2229XBT
Q15-18, 21, 22	" 2SC2240	QTC2240XAT
Q10, 19, 20, 42	" 2SC2240	QTC2240XBT
Q44	" 2SD526	QTD0526XAT
Q45	" 2SK30 (A)	QTK0030XBT
Q1	" 3SK73	QTLC073XAT



Symbol No.	Description	Part Code
Q27/28/33/34 (320R only)	Transistor, 2SL1318	QTC1318XDN
Q35/36 (320R only)	.. 2SA720	QTA0720XBN
R219-222	Cement resistor, 2W, 0.47 ohm	RF02SKR47B
R199, 200 (330R/RL)	MOF resistor, 1/2W, 1.5k ohm	RGHANJ152N
R199, 200 (320R)	.. ..	RGHANJ152N
R211-214	.. 1/2W, 220 ohm	RGHANJ221N
R243 (330R/RL only), 244, 247	.. 1/2W, 10 ohm	RXHANJ100N
R201, 202 (330R/RL)	.. 1/2W, 2.7k ohm	RGHANJ272N
R201, 202 (320R)	.. 1/2W, 3.3k ohm	RGHANJ332N
R49	.. 1/2W, 560 ohm	RGHANJ561N
R227, 228	.. 1W 270 ohm	RG1ANJ271N
RV5	Trimming VR, 1k (A)	RPGNB10201
RV2	.. 20k (A)	RPGNB20301
RV3	.. 200k (A)	RPGNB20401
R223-226	MOF resistor, 1/2W, 5.6 ohm	RXHANJ5R6N
R227, 228	.. 1W, 270 ohm	RG1ANJ271N
RV1 (330R/RL only)	Trimming VR, 50k (A)	RPGNB50301
RV4	.. 10k (A)	RPJNB10302
RV7, 8	.. 330 (A)	RPJNB33101
VR1	VR, 200k (MN)/100k (B), Volume/Balance	RVGA204X07
VR2, 3	VR, 50k (B), Treble/Bass	RVGA503B05
R225, 226	MOF resistor, 2W, 5.6 ohm	RX2ANJ5R6N
S2 (330RL)	Rotary switch, 4p/6t, Program select	SH040604UN
S2 (330R)	.. 4p/5t, ..	SH040504UN
S2 (320R)	.. 6p/5t, ..	SH060503UN
S3-6	Slide switch, 2p/2t, Tape monitor, etc.	SL020215ZB
S7, 8	.. 4p/2t, Speaker On/Off	SL040208ZB
T2	RFT, FM RF amp. to mixer	TRA7JZ002S
T3	RFT, FM local osc.	TRA7JZ003S
T1	RFT, FM antenna input	TRA7J2004S
T7	IFT, 455kHz	TR07BM001M
T4	IFT, 10.7MHz	TR10MA002S
T5	IFT, 10.7MHz	TR10MM013M
T6	IFT, 10.7MHz	TR10MM014M
T9	RFT, AM local osc.	TR10MZ002M
T10 (330RL only)	RFT, Long wave local osc.	TR10MZ003M



## Scott 320R,330R/RL

Symbol No.	Description	Part Code
J3	DIN-type socket, Tape Rec/Play	YJD05S011Z
J1, 2	RCA jacks, Phono/AUX/Tape Rec-Play	YJP04S016U

### LW PC Board [PSAZ024COX (330RL Only)]

C7	Ceramic capacitor, 8pF, 50V	CCGB080DOT
C5, 6, 9	" 0.01 $\mu$ F, 50V	CKFB103MDT
C2, 3	" 0.01 $\mu$ F, 50V	CKFB103ZFT
C1, 4	" 0.022 $\mu$ F, 50V	CKFB223ZFT
CT1-3	Trimming capacitor, 8pF	CTX1080P06
L2, 3	RFC, 10mH	LF103KC01S
L1	" 150 $\mu$ H	LF151KA01T
D1, 2	Silicon diode, 1S1555	QDSS1555XT
Q1, 2	Transistor, 2SC2240	QTC2240XAT
Q3	" 2SC2240	QTC2240XBT
S1	Slide switch, 2p/25, INT-EXT Ant	SSC20233ZA
T1	RFT, Long wave RF amp	TR10MZ001M

### Fuse PC Board [PSAZ025COX] (See following Main Chassis parts for fuses mounted)

	Fuse housing	YHF0P0003Z
--	--------------	------------

### Stereo Indicator [PSLD018COX]

LD1	LED AR5531	QLAR5531KR
-----	------------	------------

### Electrical Parts On Main Chassis

<b>320R</b>		
Q37, 38	Transistor, 2SC1826	QTC1826XAD
Q39, 40	" 2SA768	QTA0768XAD
P1	AC cord + AC plug, UL listed	ACAC029U1A
J1	AC accessory outlet	YJA020005U
J2, 3	Fuse holder	YHF1S3006U
J4, 5	Speaker output terminal, 4p	YTD04S005U
J6	Headphone jack, stereo, 1/4"	YJS03S016Z



Symbol No.	Description	Part Code
J7	Antenna terminal, 5p	YTD05S006U
J8	Ground terminal	YTD01S001U
S1	Lever switch, UL listed, Power	SL020216UB
S2	Leaf switch, audio mute	SF020202ZE
PT1	Power transformer, Youth	TPE78A001Y
BA1	FM antenna balun	TEAR155E01
D1	Silicon diode, RA-1Z	QDSRA1ZXXD
M1	Meter, Signal/Center-Tune, 500 $\mu$ A	ZMJ2052N02
PL1-3	Lamp, 14V, 80mA	ZPA148103U
L1	RFC, 150 $\mu$ A, AM antenna	LF151KA01T
C1	Ceramic capacitor, 4,700p, 1.4kVDC	CKDX472PMM
C2	Electrolytic capacitor, 470, 25V	CEAE471ALX
C3	" 220, 35V	CEAF221ALX
C4	Ceramic capacitor, 0.047	CKDB473ZFM
R2	Metal oxide resistor, 390, 1/2W	RGHANJ391N
F1, 2	Fuse, 3.5A UL listed	ZFBQ35201U
F3	" 1A UL listed	ZFBQ10202U
F4	" 1.5A UL listed	ZFBQ15201U
F5, 6	" 2.5A UL listed	ZFBQ25206V
<b>330R (US/Canada)</b>		
Q37, 38	Transistor, 2SC1986	QTC1986XBD
Q39, 40	" 2SA771	QTA0771XBD
P1	AC cord + AC plug, UL listed	ACAC029ULA
J1, 2	AC accessory outlet	YJA020005U
J3, 4	Fuse holder	YHF1S3006U
J5, 6	Speaker output terminal	YTD04S005U
J7	Headphone jack, stereo, 1/4"	YJS03S006Z
J8	Antenna terminal, 5p	YTD04S005U
J9	Ground terminal	YTD01S001U
S1	Lever switch, UL listed, Power	SL020216UB
S2	Leaf switch, audio mute	SF020202ZE
PT1	Power transformer, Youth	TPE78A002Y
BA1	FM antenna balun	TEAR155E01
M1	Meter, 500 $\mu$ A, Signal	ZMG2052N02
M2	" $\pm$ 250 $\mu$ A, Center-Tune	ZMF4052K02
PL1-4	Lamp, 14V, 80mA	ZPA148103U
L1	RFC, 150 $\mu$ A, AM antenna	LF151KA01T
C1	Ceramic capacitor, 4,700p, 1.4kVDC	CKDX472PMM
C2	" 0.047	CKDB473ZFM
F1, 2	Fuse, 4A, UL listed	ZFBQ40202U
F3	" 1A, UL listed	ZFBQ10202U
F4	" 2.5A, UL listed	ZFBQ25201U



## Scott 320R,330R/RL

Symbol No.	Description	Part Code
F5, 6	Fuse, 3A, UL listed	ZFBQ30205V
<b>330R (Europe)</b>		
Q37, 38	Transistor, 2SC1986	QTC1986XBD
Q39, 40	" 2SA771	QTA0771XBD
J1	AC receptacle, 3 phase	YJA03S002U
J2, 3	AC accessory outlet	YJA020005U
J4	Voltage selector, receptacle	YJZ10S001U
P1	" plug	YPZ06S004U
J5, 6	Fuse holder, Speaker	YHF1S3006U
J7	" AC protect	YHF1S3001U
J8, 9	Speaker output terminal, 4p	YTD04S005U
J10	Headphone jack, stereo, 1/4"	YJS03S016Z
J12	Ground terminal	YTD01S001U
PT1	Power transformer, Youth	TPE78A003Y
J11	Antenna terminal, 4p	YTD04S005U
S1	Lever switch, UL listed, Power	SL020216UB
S2	Leaf switch, audio mute	SF020202ZE
BA1	AM antenna balun	TEAR155E01
M1	Meter, 500 $\mu$ A, Signal	ZMG2052N02
M2	" $\pm$ 250 $\mu$ A, Center-Tune	ZMG4052K02
PL1-4	Lamp, 14V, 80mA	ZPA148103U
L1	AM antenna input, 150 $\mu$ H	LF151KA01T
C1, 2	Oil-paper capacitor, 0.01, 450VAC	CNST103MAN
C3	Ceramic capacitor, 0.047	CKDB473ZFM
F1, 2	Fuse, 4A, secondary	ZFBQ40201Z
F3	" 1A	ZFBQ10206V
F4	" 1.25A	ZFBQ13202Z
F5, 6	" 3A, Speaker	ZFBQ30205V
<b>330RL</b>		
Q37, 38	Transistor, 2SC1986	QTC1986XBD
Q39, 40	" 2SA771	QTA0771XBD
J1	AC receptacle, 3 phase	YJA03S002U
J2, 3	AC accessory outlet	YJA02S005U
J4	Voltage selector, receptacle	YJZ10S001U
P1	" plug	YPZ06S004U
J5, 6	Fuse holder, Speaker	YHF1S3006U
J7	" AC protect	YHF1S3001U
J8, 9	Speaker output terminal	YTD04S005U
J10	Headphone jack, stereo, 1/4W	YJS03S016Z
J11	Antenna terminal, 4p	YTD04S005U
S1	Lever switch, UL listed, Power	SL020216UB



Symbol No.	Description	Part Code
S2	Leaf switch, audio mute	TEAR200M01
J12	Ground terminal	YTD01S001U
PT1	Power transformer, Youth	TPE78A003Y
M1	Meter, 500 $\mu$ A, Signal	ZMG2052N02
M2	„ $\pm$ 250 $\mu$ A, Center-Tune	ZMF4052K02
PL1-4	Lamp, 14V, 80mA	ZPA148103U
L1	RFC, 2.2 $\mu$ H, long wave section	LCADA3038A
C1, 2	Oil-paper capacitor, 0.01, 450VAC	CNST103MAN
C3	Ceramic capacitor, 0.047	CKDB473ZFM
F1, 2	Fuse, 4A, secondary	ZFBQ40201Z
F3	„ 1A	ZFBQ10206V
F4	„ 1.25A	ZFBQ13202Z
F5, 6	„ 3A	ZFBQ30205V

### Mechanical Parts

	Description	Part Code
	Escutcheon: 320R	AM320R**01
	330R	AM330R**01
	330RL	AM330RL*01
	Front chassis	MB972SL003
	Main chassis	MU865SL001
	Rear panel: 320R	MB972SE047
	European 330R	MB972SE045
	US/Canada 330R	MB972SE046
	330RL	MB972SE048
	Bridge chassis	MU853SL001
	Dial scale: 320R/330R	VS848AC003
	330RL	VS848AC004
	Tuning flywheel	AVFLYWL009
	Bottom plate	MS986SL003
	Foot, for above	VM280EB001
	Cabinet: 320R/US/Canada 330R	MU893SX001
	European 330R/330RL	MU893SX012
	Knob, Tuning	MN386AA026
	„ Volume	MN296XA003
	„ Balance	MN296XA002
	„ Program Select	MN376AA019
	„ Tone	MN276XA029
	„ Power	VN370SX001
	„ lever switches	VN360SX001
	Dial pointer	MJ311BC001