

22

ARCHIVE COPY
DO NOT REMOVE

Service Manual AM/FM Stereo Receivers

355R

375R

385R

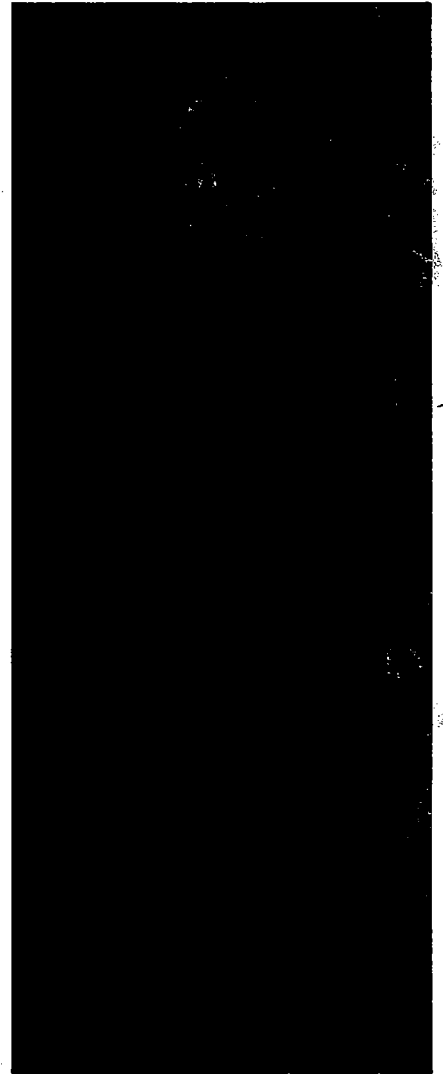
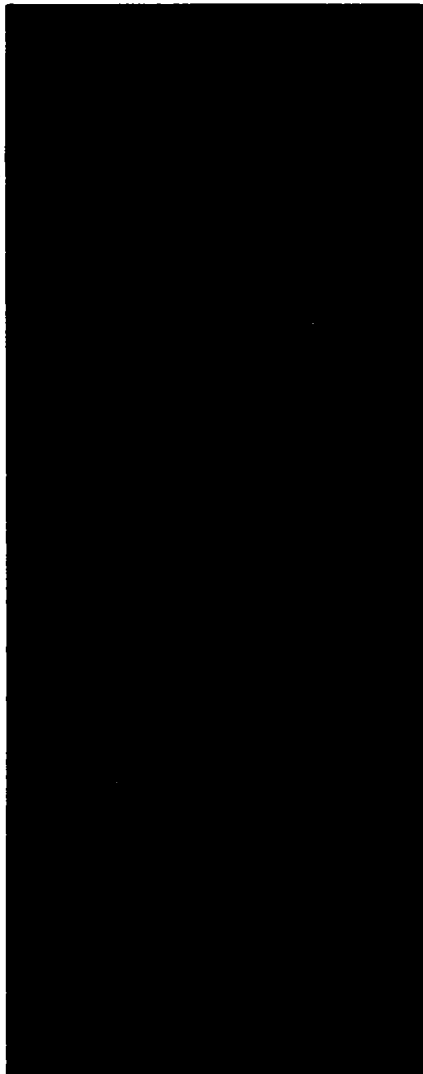

 **SCOTT**[®]
The Name to listen to.

H. H. SCOTT, INC., 20 Commerce Way, Woburn, Mass. 01888 Tel. (617) 933-8800

CONTENTS

PAGE

1. Specifications and revision information.
3. Circuit description, tuner section.
4. Circuit description, tuning indicators.
6. Circuit description, audio amplifier.
7. Circuit description, protection and power meters.
8. Circuit description, temperature sensors.
8. Test procedures.
11. Fluorescent indicator panel lead codes.
14. Parts location diagrams.
17. Circuit diagrams.
20. Exploded view and Notes.
21. Parts list.
32. Troubleshooting guide.

CAUTION NOTICE

The following safety precautions must be followed to assure continued reliability and safety against fire and shock hazard:

1. Replacement parts used during servicing of this appliance must have identical characteristics as those offered and recommended by H. H. Scott, Inc. In the interest of continued product safety we refer in particular to those safety critical components shown on the Replacement Parts List identified by the IEC Symbol "△".
2. A dielectric test is to be performed on each appliance following the re-assembly and before returning the unit to the customer.
3. The dielectric test to be performed on H. H. Scott, Inc. electric components serviced in the United States and Canada for use in these countries shall consist of not less than the following:*
 - 1) A dielectric tester designed to have an output voltage that (1) has a sinusoidal wave form, (2) has a frequency that is within the range of 40-70 Hz, and (3) has a peak value of the waveform that is not less than 1.3 and not more than 1.5 times the root-mean-square value.
 - 1a) The sensitivity of the test equipment shall be such that when a 120,000-ohm resistor is connected across the output, the test equipment does not indicate unacceptable performance for any output voltage less than the specified test voltage, and does indicate unacceptable performance for any output voltage equal to or greater than the specified test voltage. The calibrating resistor is to be adjusted as close to 120,000 ohms as instrumentation accuracy can provide, but not more than 120,000 ohms.
 - 2) The tester is to be connected per the instructions enclosed with the instrument, or as follows:
 - a. The tester is connected to the power line receptacle and the power switch is turned on.
 - b. Sufficient time is allowed for the tester supply to stabilize and then the output voltage is adjusted for 1080 V.
 - c. Leads of the tester, usually marked GND and HV, are connected between chassis ground and both blades of the male plug of the power cord.
 - d. Switch tester to "test" and observe leakage indicator.

*Dielectric tests made by service personnel in countries other than USA and Canada must use test equipment and procedures specified by the safety agency serving that country.

COPYRIGHT H.H. SCOTT ELECTRONICS®

Printed in U.S.A. 11/82 029-1175-049

H.H. SCOTT ELECTRONICS®, Scottkit® and Scotsman™ are registered trademarks of H.H. SCOTT, Inc.

22

ARCHIVE COPY
DO NOT REMOVE

Service Manual AM/FM Stereo Receivers

355R

375R

385R

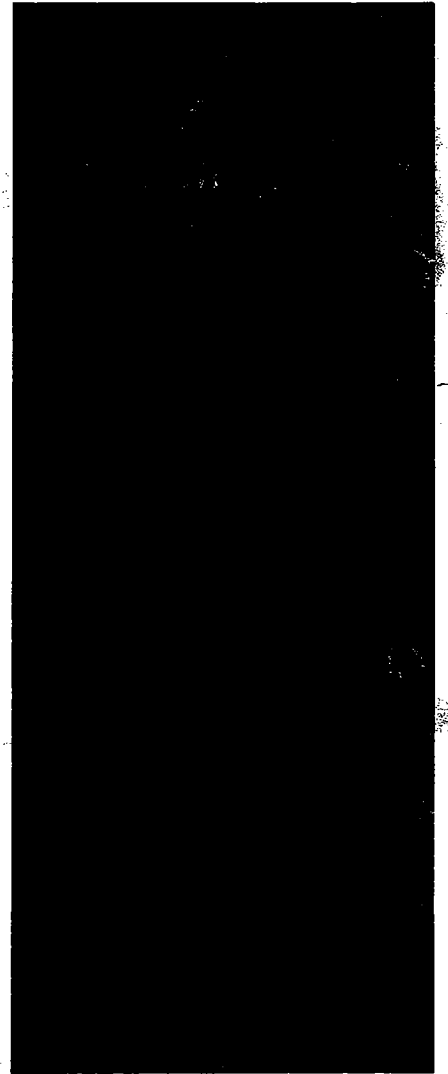

 **SCOTT**[®]
The Name to listen to.

H. H. SCOTT, INC., 20 Commerce Way, Woburn, Mass. 01888 Tel. (617) 933-8800

CONTENTS

PAGE

1. Specifications and revision information.
3. Circuit description, tuner section.
4. Circuit description, tuning indicators.
6. Circuit description, audio amplifier.
7. Circuit description, protection and power meters.
8. Circuit description, temperature sensors.
8. Test procedures.
11. Fluorescent indicator panel lead codes.
14. Parts location diagrams.
17. Circuit diagrams.
20. Exploded view and Notes.
21. Parts list.
32. Troubleshooting guide.

CAUTION NOTICE

The following safety precautions must be followed to assure continued reliability and safety against fire and shock hazard:

1. Replacement parts used during servicing of this appliance must have identical characteristics as those offered and recommended by H. H. Scott, Inc. In the interest of continued product safety we refer in particular to those safety critical components shown on the Replacement Parts List identified by the IEC Symbol "△".
2. A dielectric test is to be performed on each appliance following the re-assembly and before returning the unit to the customer.
3. The dielectric test to be performed on H. H. Scott, Inc. electric components serviced in the United States and Canada for use in these countries shall consist of not less than the following:*
 - 1) A dielectric tester designed to have an output voltage that (1) has a sinusoidal wave form, (2) has a frequency that is within the range of 40-70 Hz, and (3) has a peak value of the waveform that is not less than 1.3 and not more than 1.5 times the root-mean-square value.
 - 1a) The sensitivity of the test equipment shall be such that when a 120,000-ohm resistor is connected across the output, the test equipment does not indicate unacceptable performance for any output voltage less than the specified test voltage, and does indicate unacceptable performance for any output voltage equal to or greater than the specified test voltage. The calibrating resistor is to be adjusted as close to 120,000 ohms as instrumentation accuracy can provide, but not more than 120,000 ohms.
 - 2) The tester is to be connected per the instructions enclosed with the instrument, or as follows:
 - a. The tester is connected to the power line receptacle and the power switch is turned on.
 - b. Sufficient time is allowed for the tester supply to stabilize and then the output voltage is adjusted for 1080 V.
 - c. Leads of the tester, usually marked GND and HV, are connected between chassis ground and both blades of the male plug of the power cord.
 - d. Switch tester to "test" and observe leakage indicator.

*Dielectric tests made by service personnel in countries other than USA and Canada must use test equipment and procedures specified by the safety agency serving that country.

COPYRIGHT H.H. SCOTT ELECTRONICS®

Printed in U.S.A. 11/82 029-1175-049

H.H. SCOTT ELECTRONICS®, Scottkit® and Scotsman® are registered trademarks of H.H. SCOTT, Inc.

SPECIFICATIONS

AMPLIFIER SECTION	355R	375R	385R
Minimum Continuous RMS Output power perchannel both channels driven into 8 ohms from 20 Hz to 20 kHz With no more than rated T.H.D.	45 W	65 W	85 W
Total Harmonic Distortion at rated output	0.05%	0.04%	0.03%
Total Harmonic Distortion at 10 Watt from 20 Hz to 20 kHz	0.04%	0.03%	0.03%
Intermodulation Distortion at rated output power; 60;7000 Hz;4:1	0.04%	0.03%	0.03%
Signal to Noise Ratio, shortened input, IHF-A network: Phono (10mV, RIAA 1 kHz): Others	81 dB 100 dB	84 dB 100 dB	84 dB 100 dB
Input Sensitivity Phono MM Phono MC Others	2.5 mV 150 mV	2.5 mV 0.25 mV 150 mV	2.5 mV 0.25 mV 150 mV
Phono Overload	200 mV	M.M: 220 mV M.C: 20 mV	M.M: 220 mV M.C: 20 mV
Damping Factor, 1 kHz, 8 Ohm more than	50	60	60
Channel separation at 1 kHz PHONO at 1 kHz OTHERS	55 dB 65 dB	55 dB 65 dB	55 dB 65 dB
Frequency Response at 1 Watt output Phono RIAA 20 Hz—20 kHz: Others 20 Hz—20 kHz:	± 0.5 dB ± 1 dB	± 0.5 dB ± 0.8 dB	± 0.5 dB ± 0.8 dB
Filters subsonic 6 dB/octave, -3 dB Hi Filter 6 dB/octave, -3 dB	Phono 18 Hz 30 dB/oct 7 kHz 12 dB/oct Others 18 Hz 18 dB/oct	Phono 18 Hz 30 dB/oct 7 kHz 12 dB/oct Others 18 Hz 18 dB/oct	Phono 18 Hz 30 dB/oct 7 kHz 12 dB/oct Others 18 Hz 18 dB/oct
Tone Control Range Base at 100 Hz Treble at 10 kHz Mid: at 1 kHz	± 10 dB ± 10 dB ± 6 dB	± 10 dB ± 10 dB ± 6 dB	± 10 dB ± 10 dB ± 6dB
Loudness Contour Volume control set to -30 dB at 10 kHz at 100 Hz	+ 3.5 dB at 10 kHz + 7 dB at 100 Hz	+ 3.5 dB at 10 kHz + 7 dB at 100 Hz	+ 3.5 dB at 10 kHz + 7 dB at 100 Hz
GENERAL			
Power requirement: (Refer to rear panel for specified voltage and frequency before making any connections.)	120V AC; 60 Hz	120 V AC: 60 Hz	120 V AC: 60 Hz
Power Consumption	280 W	370 W	480 W
Dimensions (W/H/D)	5"/20"/13", 125mm/500mm/330mm	5"/20"/13", 125mm/500mm/330mm	5"/20"/13", 125mm/500mm/330mm
Net Weight	25¼ lbs. 11.5 Kgs.	28 lbs. 12.7 kgs.	30 lbs. 13.0 kgs.

SPECIFICATIONS

FM SECTION	355R	375R	385R
Tuning Range	87.5 to 108.5 MHz	87.5 to 108.5 MHz	87.5 to 108.5 MHz
IHF sensitivity	10.8 dBf/1.9uV	10.3 dBf/1.8 uV	10.3 dBf/1.8 uV
50 dB quieting sensitivity	Mono: 16.7 dBf/3.8 uV Stereo: 37 dBf/39 uV	Mono: 16.5 dBf/3.6 uV Stereo: 37 dBf/39 uV	Mono: 16.5 dBf/3.6 uV Stereo: 37 dBf/39 uV
S/N ratio at 65 dBf	Mono: 72 dB Stereo: 67 dB	Mono: 76 dB Stereo: 70 dB	Mono: 76 dB Stereo: 70 dB
Distortion at 65 dBf	Mono: 0.15% Stereo: 0.25%	Mono: 0.1% Stereo: 0.2%	Mono: 0.1% Stereo: 0.2%
Frequency response + 1dB/ - 2dB	20 Hz—15 kHz	20 Hz—15 kHz	20 Hz—15 kHz
Capture ratio	1.2 dB	1.2 dB	1.2 dB
Alternate channel selectivity	60 dB	60 dB	60 dB
Image rejection	75 dB	80 dB	80 dB
Stereo separation at 1 kHz	45 dB	50 dB	50 dB
Spurious response rejection	78 dB	78 dB	78 dB
Subcarrier rejection	55 dB	60 dB	60 dB
IF rejection (98 MHz)	90 dB	90 dB	90 dB
AM SECTION	355R	375R	385R
Tuning Range	515 to 1640 kHz	515 to 1640 kHz	515 to 1640 kHz
Usable sensitivity (bar ant.)	250 uV/m	250 uV/m	250 uV/m
S/N ratio	50 dB	54 dB	54 dB
Selectivity (1MHz)	45 dB	45 dB	45 dB
Image rejection	50 dB	50 dB	50 dB

REVISIONS MADE DURING PRODUCTION

355R, 375R

- 1) R203 (FM IF CKT) deleted in certain production units to improve stereo separation.
- 2) R 502 (Pwr. Supply) changed from 1.0K to 220 ohms.
- 3) Pwr. transformer secondary voltage increased to provide better regulation and to accommodate additional voltage drop by added 4.7ohm resistor (R510).
- 4) CR511 changed from 1Z14 to 1Z15 to provide higher supply to tuner section.
- 5) C218 increased from 1/50 to 10/15 to reduce transient when unit switches in and out of MUTE.
- 6) Q601 changed from KSA733Y to KSA708Y to improve reliability.
- 7) C602 changed from 4.7/50 to 4.7/160 to improve reliability.
- 8) CR602 deleted.
- 9) Q501 changed from KSD 288-0 to KSD 288-Y to reduce voltage drop.
- 10) R602 changed from 10K to 2.2K.
- 11) C513 changed from 220mF to 1000mF to reduce protection circuit triggering with tone controls set at boost.

CIRCUIT DESCRIPTION

—Tuner

FM Front End

The input section is designed using a balun coil that provides input matching for both 75 and 300 ohm transmission lines. The tuner section uses a MOSFET RF amplifier (Q1), transformer coupled to a bipolar mixer (Q2) for conversion. The local oscillator (Q3) is capacitively coupled to the base of Q2 where through the heterodyne process a 10.7 MHz signal is produced for IF amplification.

FM IF Amplifier & Quadrature Detector (IC201)

Output of the FM front end is transformer coupled to the IF amplifier circuit, composed of the 10.7 MHz transformer (T201), a transistor stage (Q201), 3 dual element ceramic filters (CF201, 202, and 203) and one integrated circuit (IC201). This integrated circuit contains the limiter amplifiers, quadrature detector, AGC amplifier, mute circuits, A.F.C. circuit and audio amplifier. Within the IC, limiter output is fed directly to one quadrature input. This signal is also connected to pin 8 where it is phase shifted by external coil L201 and reapplied to the other quadrature input at pin 9.

Two audio signals, opposite in phase, are obtained from the quadrature detector. Output of the first amplifier (pin 7) is at a DC level which varies with detuning and is used to provide the DC level shift necessary to operate the center tuning circuits. Output from the second amplifier (pin 6) is the composite audio signal which is coupled directly to the multiplex IC. The composite signal is internally muted in IC201 whenever a positive voltage is applied to pin 5. Drive for muting supplied from pin 12 provides a positive voltage when input to the IC is reduced to a low level.

Block Diagram of HA1137 (IC201)

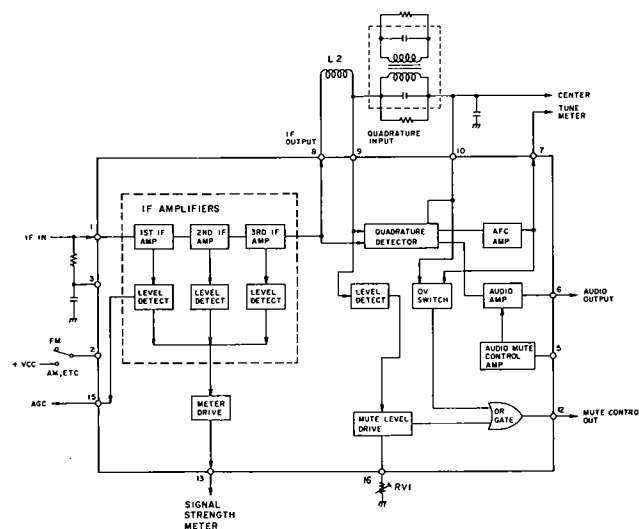

Multiplex Decoder HA1196 (IC301)

The multiplex decoder IC is functionally divided into 2 sections: the phase locked loop (PLL) signal generator and the stereo demodulator. The PLL consists of a 76 kHz voltage controlled oscillator (VCO) followed by two frequency dividers, producing 38 kHz and 19 kHz. The phase of this signal is compared with the phase of the incoming pilot signal and a difference signal is created which corrects the VCO and synchronizes the VCO signal to the pilot signal. Since higher order harmonics are contained in the phase difference signal, a low pass filter is used to eliminate these harmonics. A second phase comparator is used to sense when the PLL is locked to a pilot signal. The output of this comparator triggers the stereo indicator and connects the 38 kHz switching signal to the demodulator.

The demodulator circuit consists of two differential amplifiers operating in a switching mode controlled by the phase locked 38 kHz signal which demodulates the composite incoming signal into left and right outputs. These signals at pins 4 and 5 are coupled to external amplifiers Q302 and 352 which drive the left and right channel low pass filters.

A means of switching deemphasis of the FM audio signal has been incorporated in these models utilizing the external Post AMP FEEDBACK connections of the Multiplex decoder IC.

Block Diagram of HA1196 Multiplex Decoder

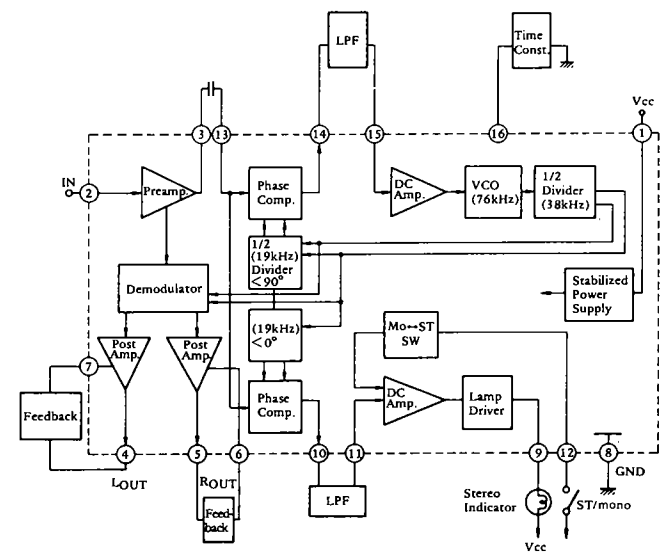

AM Tuner Section

The AM incoming signal received at the AM antenna enters the RF section of IC101 and is amplified and coupled to the converter stage. Here the signal is changed to the universal 455 kHz intermediate frequency.

The local oscillator, operating 455 kHz above the incoming tuned signal, is achieved in the converter block in the IC with externally connected L102.

The 455 kHz signal is coupled through two stages of IF amplification, and to the detector. The detector output then appears as audio information at pin 12. This signal is then conducted through the low pass filter to further remove the 455 kHz component.

Block Diagram of HA1197 AM Tuner (IC101)

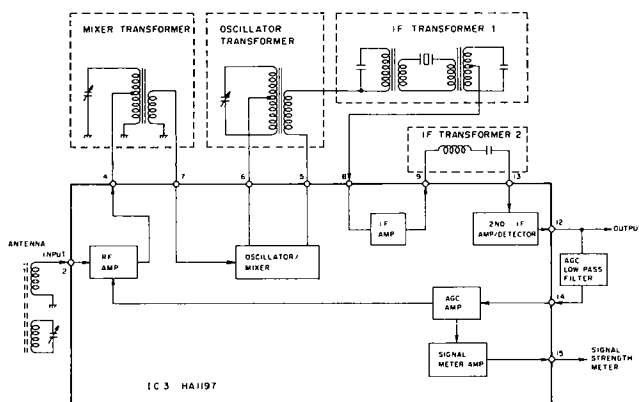

Drive for the signal strength indicator is provided at pin 15, this positive AGC voltage is coupled directly to the input (pin 8) of IC805.

Signal Strength Indicator (IC805)

The signal strength indicator is driven by the single inline package BA6104. This digital IC is designed using five comparators to drive the external display. It operates with an increasing DC voltage level applied to the input at pin 8.

In the 355R this IC is used to directly energize the LED display segments, in the 375R and 385R this same circuit is used to operate the signal strength segments of the fluorescent display tube.

The meter drive IC derives its inputs from pin 13 of IC 201 for FM and from pin 15 of IC 101 for AM. Sensitivity is set by control R835 while R214 provides adjustment for FM signal strength.

FM Tuning Frequency Display Circuit 375R, 385R

Frequencies generated by the FM local oscillator are coupled through a small value capacitor (C24) to the gate of FET Q4. Q4 is used for isolation and gain to trigger IC802. IC802 is a divide by 100 prescaler that divides the 110 MHz local oscillator frequency down to 1.1 MHz, the square wave out-

put is then applied through C811 to the input of IC 803, IC803 is a C-MOS LSI circuit designed to operate frequency indicators with up to five digits.

A four MHz crystal is mounted externally and wired to pins 19 and 20 of the IC.

This crystal is used as a reference for the clock which controls the gates within the IC.

Switching of the display frequency to FM is accomplished by applying FM B+ through regulator transistor Q801 to IC802 and by applying the FM B+ through a voltage divider R811 and R812 to pins 8 and 12 of IC803. FM B+ is also used to bias the series diode connected in series with the AM oscillator signal lead to pin 6 of IC 803. With this plus voltage applied to the diode cathode any signal that might appear on this conductor in the FM mode will not be conducted to IC803.

AM Tuning Frequency Display Circuit

Frequencies generated by the AM local oscillator within IC101 are coupled from pin 6 to the base of Q101, output of this emitter follower, is applied through a series diode directly to the input of IC803.

Switching of the display reading from FM to AM is accomplished by switching the FM local oscillator OFF and by removing FM B+ from IC802, pins 8 and 12 of IC803 as well as the bias voltage applied to the series diode used to conduct AM local oscillator signal to pin 6 of IC803.

Center Tune/Lock Circuit (Refer to Circuit Diagram)

The models 355R, 375R and 385R incorporate circuitry to both indicate proper FM tuning as well as to electronically correct a tuning error of up to ± 50 kHz caused by operator mistuning.

Center Tune

Center Tuning circuitry is composed of a dual op amp (IC804) with transistors Q802, 803, 804, 805 and 808 to operate the center tune indicator. When operating normally A.G.C. and mute voltages are applied to control transistors Q806, Q809 and Q810 which in turn determine when the center tune indicators will be turned on.

IC804 derives its control signals from pins 7 and 10 of the FM detector, IC201.

When the receiver is perfectly tuned the voltage across these two terminals will be zero, however as the receiver is tuned above the station carrier frequency the voltage as measured on pin 7 of IC201 will become lower with respect to pin 10. These pins of the detector IC are connected through isolation resistors to IC804.

IC804 serves two functions, first to invert the DC level applied to pin 2, secondly to stabilize the DC level at pin 7 which

is used as a reference voltage for Q802 and Q803 as well as for Q814 and Q816 in the lock circuit.

With the reference voltage applied to Q802 and Q803 **the output at pin 1 will now deviate plus as the receiver is tuned above the carrier frequency and minus when tuned below.**

When tuned high the positive voltage will cause Q802 to conduct and Q803 to be cut-off, with Q803 cut-off, Q804 will conduct and apply a positive voltage to the HIGH indicator. Conversely, tuning low will cut-off Q802 causing Q805 to conduct causing the LOW indicator to be illuminated. When either Q804 or Q805 is conducting the positive voltage at their emitter terminal will be applied to the base of Q808 thus causing this transistor to conduct thereby shunting the supply voltage through R827 to the center tune indicator.

Control Circuits

Operation of the CENTER TUNE circuits is dependant on proper alignment of the FM section and on the signal levels applied to the control transistors.

The CENTER TUNE circuit is also inhibited from operating at low input signal levels and from OFF station operation until a positive voltage is applied to the base of Q810, this will be accomplished:

- a) when center tune voltage on 845 approaches zero, causing Q809 to cut off.
- b) when voltage on pin 1 of IC 805 goes positive.

When Q810 conducts the base of Q806 will go low causing this PNP to conduct applying a positive voltage to diodes CR815 and CR816, without this positive voltage applied to the cathode of these diodes, the diodes act as a shunt to the DC level changes which operate the tuning indicators.

Lock Circuit

The lock circuitry, comprised of Q811, 812, 813, 814, 815 and 816 is described as follows:

When tuning of the receiver approaches an FM carrier the Plus Voltage at board terminal 845 will be reduced and finally reach zero on station.

When the voltage at the base of Q811 is reduced to below 0.6 volts the transistor will cut-off and the collector voltage will go to supply level. In this design, an intentional delay created by the R-C time constant of C824 and R838 has been incorporated.

When C824 is sufficiently charged Q812 will conduct pulling the collector down so that collector of Q813 will go high thus turning on the lock indicator (CR801).

When the lock indicator is OFF Q816 is fully conducting.

This condition sets a **fixed bias** on CRI which is a back biased varactor diode on the FM local oscillator section. The characteristic of this circuit is that the capacitance of the diode is directly proportional to the reverse DC voltage across it. Thus the diode with a fixed DC voltage contributes nothing to the tuning, acting only as a fixed capacitor. However, when the lock circuit is enabled and the indicator is turned on the collector/base voltage through R850 to Q816 will be shunted by Q815 thus turning Q816 OFF and permitting the DC level change at the collector of Q814 to be applied to the varactor diode (CR1). The D.C. level applied to the base of Q814 is derived from pin 1 of IC804 where, as indicated above, will become increasingly positive with respect to pin 7, when the receiver is tuned above the carrier, with this more positive voltage applied to the base of Q814, the result will be a lower voltage across the varactor diode.

With a lower voltage the diode capacitance is increased until the carrier is center tuned, conversly, if the receiver is tuned below the carrier, a higher voltage will be applied to the diode with a resulting reduction in capacitance which will tune the receiver to the carrier.

Voltage change to the varactor is slow as determined by the R/C time constant of R849 on the display board and C220 on the tuner board.

The entire lock circuit is disabled by SW 7-2 when the LOCK/MUTE button is out.

CIRCUIT DESCRIPTION

—Audio

Phono Preamplifier

These models use two separate operational amplifiers (IC901, 951) in a negative feedback configuration which provides the designer with means of gain adjustment and equalization.

Gain adjustment is fixed by resistors R914 and R915 while capacitors C910 and C911 provide the proper equalization to conform to the RIAA standard curve for recorded disc reproduction.

The circuit is powered by split supplies at a DC level suitable to provide the 200 mV overload capability at 1.0 kHz.

Tone Control

The tone control circuits (IC 401, 451) use of the high gain and low noise characteristics of the TA7322.

The tone control is a negative feedback type utilizing inverting Pin No. 3 for control.

Bass Control (R412)

As the frequency applied to the input of the IC decreases, the impedance of C411 increases thus reducing the signal applied to the treble control. Therefore at low frequencies the gain is mainly determined by the position of the bass control (R412L). Rotating the bass control toward C407 will boost the low frequencies by attenuating the feedback information below 1000Hz. Rotating the control toward C406 will attenuate low frequencies by reducing the circuit impedance thereby increasing feedback below 1000Hz.

Treble Control (R414)

As the frequency applied to the input increases the bass control will be shorted by C406 and C407 and the control will have no effect. However the impedance of C408 will decrease so that control R414L becomes the main feedback control. Rotating R414L toward R413 will increase feedback thus attenuating high frequencies. Rotating R414L toward R415 will reduce feedback and boost high frequencies.

Midrange Control (R419)

At 1 kHz the bass and treble controls have little effect on the gain because of the impedance of capacitors C406, C407, C409 and C410. Thus at midrange frequencies R419L will control the gain of the tone control circuit.

Power Amplifier

The power amplifier design used in these models is a fully complementary design using a differential input amplifier composed of a matched transistor pair in a single package thus providing optimum common mode rejection and low DC offset.

With reference to one of the circuit diagrams, the first transistor (Q1401) provides the excellent common mode rejection and low DC offset.

Q1404 and Q1405 are used as voltage amplifiers to provide adequate signal level to driver transistors Q1406 and Q1407. Current gain is provided by the darlington connected driver/output circuit where Q1407 and Q1409 conduct for the negative swing and Q1406 and Q1408 conduct for the positive swing.

The output stage bias is set by the triple diode CR1401 and potentiometer R1412.

The amplifier is controlled by multiple feedback networks. DC feedback is provided through R1410 while R1411 and C1404 set the DC gain.

AC gain is determined by the ratio of R427 and R428.

Power Supply

The power supply in these models consists of a thermally protected power transformer with three separate secondary windings.

The first winding provides approximately 15.5-0-15.5 VAC which is rectified and regulated to provide the 12V DC supply for the tuner and part of the indicator circuits. Note: In later production the 15.5 VAC was increased to 18.0 VAC and zener changed to provide approx. 14V DC.

The second winding supplies approximately 82 VAC (385R) 72 VAC (375R) and 62 VAC (355R). This secondary voltage is rectified and filtered to provide a DC supply for the driver/output circuits, it is also regulated and further filtered for use in low level audio circuits.

The third winding, supplying approximately 5 VAC is used to provide filament current for the fluorescent displays.

TURN-ON DELAY/ PROTECTION CIRCUIT

This circuit is mounted on PCB #3014-523-010 and consists of six transistors, one relay and an assortment of coils, resistors, diodes and capacitors. **Q607 and Q657 are located on the Main Amplifier PC Board** and are actually connected to this board via terminals **1408** and **603**.

Delay

Audio Power to the speakers and headphones is delayed until relay contacts **K601** and **K651** are closed.

When power is switched ON, AC will be applied from the high voltage secondary to terminal **601** where it is rectified by **CR601**, filtered and applied to the base of **Q603**, at this time supply voltages to all circuits has been established and the voltage on the base of **PNPQ602** has been reduced thus causing this device to conduct and to energize the relay coil thus closing the relay contacts.

Since the **SAFETY INDICATOR** is connected between supply and the relay coil this LED will be switched off when voltage to the coil is raised to near supply voltage.

Protection

Circuitry used to sense offset and overload on the output circuit is composed of **Q606**, **607** and **Q657**.

Under normal operating conditions, these devices are not conducting therefore the collector of each remains at approximately the + supply voltage.

In operation, whenever any one of the above transistors sense an overload or offset condition in the output circuit either from internal or external causes one or more of the transistors will conduct which in turn applies a more negative voltage to base of **Q601**, when **Q601** conducts the voltage on the base of **Q604** increases and causes **Q604** to conduct which in turn causes **Q605** to conduct thus short circuiting the positive voltage applied to base of **Q603**. This voltage is short circuited through **Q605** and **R604** to ground. Thus **Q603** is cutoff and **Q602** will not conduct to energize the relay.

Output Power Meter—355R-375R

(Although typical of both channels, reference is made only to left channel components)

The output power indicator circuit is comprised of **Q817**, **Q818**, **IC806** and the fluorescent display tube, **FL801**.

Since **IC806** requires a linear input, conversion of the audio information from logarithmic to linear is performed

by the diode/resistor network **CR805**, **806**, **807**, **808** and resistors **R854**, **855**.

Amplified output of **Q817** is AC coupled to a germanium diode and to the base of **Q818**. Since **IC806** also requires a DC input the output of **Q818** is DC coupled through an adjustment potentiometer and applied to the input of **IC806**.

IC806 is a C MOS LSI circuit which performs the analog to digital conversion and peak holding function for both channels. **IC806** is directly connected to the fluorescent display tube and as DC level on the input of **IC806** increases the gates at the output progressively turn on, thereby applying the supply voltage to the appropriate input of the display tube.

Output Power Meter—385R

The FL tube is driven by a MOS LSI (**IC702**) which performs the analogue to digital conversion and the peak holding for both channels. Since the input response of this IC is linear, a LOG signal conversion is required. This AC to DC conversion and LOG compression is performed by Diodes **CR701**, **751** and **IC701**.

Since this IC is a current activated device, its input voltage sensitivity is determined by a series resistor to the inputs.

The auto-ranging circuit changes the sensitivity of the circuit by turning ON or OFF transistors **Q-701** and **Q-751**.

The FLIP-FLOP (**Q-702**, **Q-703**) drives the input attenuator transistors and lights the corresponding decimal points on the display.

Need for change over, from low to high range is detected by diodes **CR-711** and **CR-710** which are connected to the last segments (most significant) of both channel displays, as long as the 2 least significant segments are lit, the range will remain in the high one. However if these segments turn off (underrange condition) for more than 3 seconds (determined by **R-717** and **C-709**) the FLIP-FLOP will switch to the low range by **Q-705** triggering the transition.

These segments are monitored by diodes (**CR-709** and **C-708**) which keep **Q-705** in CUT OFF if these segments are lit.

Transistor **Q-706** serves as system voltage regulator, utilizing the 8.2V internal reference of the LOG converter (**IC701**).

NOTE: Printed circuit board no. 3014-530-9606 is added in some production units to increase brightness of dots.

TEMPERATURE SENSORS

Power Transformer Sensor

During production of these models certain production lots were fitted with a sensor attached to the power transformer designed to activate the protection circuitry if the power transformer temperature exceeded a predetermined level such as may occur under abnormal operating conditions.

If the receiver is made inoperable by the thermal sensor action the transformer must be allowed to cool before normal operation is resumed.

Circuit Theory

The subassembly voltage is supplied from a regulated source on the fluorescent display PCB as well as the positive voltage at term 603 of the protection board.

The regulated voltage applied to the first transistor, is used also to forward bias the triple diode and to provide a stable voltage on which to set the threshold for the second transistor.

With a known voltage drop across STV-3H at a given temperature the current through Q608 will be established thus setting the emitter voltage of the second transistor (Q609).

As the temperature applied to STV-3H increases the voltage drop across the diodes is reduced thus current through the first transistor is reduced and the emitter voltage drops. When the emitter voltage drops below the threshold set by the potentiometer, the second transistor will conduct thus activating the protection circuit to open the speaker relay contacts.

See page 10 for adjustment procedure.

Heat Sink Sensor

The 385R is designed with a sensor on the output transistor heat sink. This circuit operates in the same manner as the transformer sensor, however the design differences require a higher reference voltage setting for Q609. See page 10 for adjustment procedure.

ADJUSTMENTS

Equipment Required

- Audio signal generator.
- Level meter.
- Oscilloscope.
- Digital frequency counter, 0 - 100 kHz.
- FM multiplex signal generator.
- DMM, high impedance.
- 455 kHz sweep generator.
- 10.7 MHz sweep generator.

AM Section

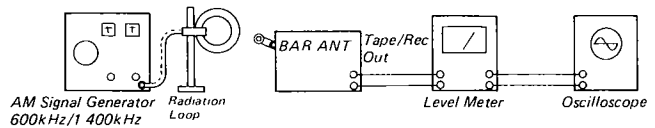

AM IF Amplifier

- 1) Apply 455 kHz sweep generator output to the unit AM antenna terminal.
- 2) Connect scope to pin number 12 of IC101.
- 3) Adjust T102 to obtain maximum and symmetrical display as shown.

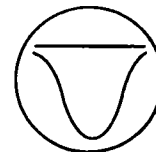

AM Tracking

- 1) Apply 600 kHz, 30% modulated with 1 kHz to the AM bar antenna. See test setup figure. (Distance between the AM bar antenna and emitting loop antenna should be 2 feet.)
- 2) Adjust signal generator output so that a sine wave appears on the scope.
- 3) Adjust T101 and L102 for maximum audio output on the level meter connected parallel with the scope. When turning core, always adjust signal generator output to maintain low input level. Do not change voltmeter range. Moreover, always keep the generator output as low as possible to avoid AGC action and to keep the measurements accurate.
- 4) Adjust the AM loopstick antenna core for maximum output reading on the voltmeter.
- 5) Shift generator frequency to 1,400 kHz with same modulation condition.
- 6) Repeat step 2.
- 7) Adjust OSC. trimmer for maximum voltmeter reading.
- 8) Adjust Ant. trimmer for maximum reading on the voltmeter.
- 9) Repeat items 3 through 8 for best tracking and maximum sensitivity.

FM IF Amplifier

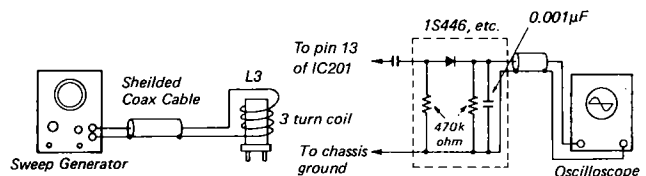

- 1) Mute the FM local oscillator by shorting L5.
- 2) Connect the oscilloscope to pin 13 of IC201.

- Apply 10.7 MHz signal from the sweep generator to L3 in the manner as shown above.
- Adjust T201 for correct figure as shown. It may be necessary to increase or decrease the sweep generator output for adjustment convenience.

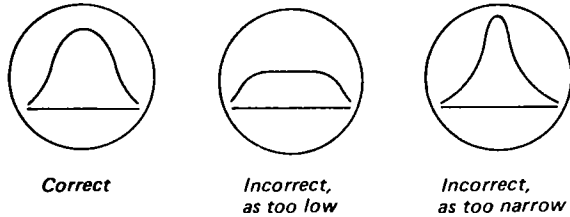

FM RF Tracking

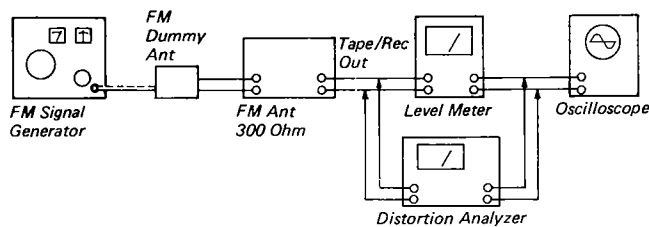

- Apply 90 MHz, 1 kHz and 100% modulated, 25 dBf signal level to the FM antenna terminals.
- Tune unit to 90 MHz.
- Observe the oscilloscope connected to the Tape/Rec output terminal for symmetrical sine wave. If failed, adjust L5.
- Adjust L1 and L2 for maximum level meter reading. Reduce input from the 25 dBf level as necessary to maintain noise on sine wave.
- Readjust the signal generator for 106 MHz, and retune unit.
- Repeat step 3. If failed, adjust the OSC. trimming capacitor mounted on the tuning capacitor.
- Adjust the trimming capacitors, for mixer and RF.
- Repeat as necessary until product specifications are met.

Center Tuning Adjustment

Connect DC DMM between chassis and pin 15 of IC201. Tune receiver to signal generator with output set at 65 dBf, carefully tune for lowest AGC voltage. (Assuming proper IF alignment this step assures tuning to center of IF band pass.) Reconnect DMM to PCB Terminals marked TUNING METER and adjust T202 for zero volts.

FM Distortion

With unit connected as above for tuning indicator adjustment, adjust T203 for minimum harmonic distortion.

Since there is some interaction between coil settings, repeat center tune and distortion adjustments for optimum results.

FM Signal Strength Display

- At 98 MHz, with receiver connected and tuned to FM generator, apply 65 dBf signal to unit antenna.
- Adjust R835 on Display Board until all segments are lighted.
- Reduce RF input to zero and note that both left and right center tune guide indicators are lighted.

Mute Threshold Adjust

- At 98 MHz, 20 dBf signal level, and set-up connected as above, tune unit with mute switch in the OFF position.
- Switch MUTE ON and adjust R226 until FM output is muted.
- Increase generator output to check for proper muting action.
- With LOCK/MUTE button IN, tune generator 50-100 kHz high and note that with approximately 8 seconds delay the circuit corrects to CENTER TUNE. Tune generator 50-100 kHz low and note same corrective action.

Multiplex Pilot Adjust

- Apply 98 MHz, 65 dBf signal to the unit with no modulation.
- Adjust R303 for 76 kHz reading on the frequency counter connected between TP and chassis ground. A deviation of ± 200 Hz is acceptable.

Stereo Separation

- Apply 98 MHz, 65 dBf left channel signal to the unit modulated with 1 kHz, 9% pilot signal.
- Connect a digital voltmeter to the right channel Tape/Rec output terminal.
- Adjust R312 for minimum leakage (minimum level) on the voltmeter.
- Apply 98 MHz, 65 dBf right channel signal to the unit modulated same as step 1.
- Move digital voltmeter to the left channel Tape/Rec output terminal.
- Check for approximately the same leakage as in step 3.

Audio Adjustments

Equipment Required

Audio signal generator.
Digital multimeter.
Speaker load resistors, 8 ohm 100 watt.

The following adjustments are the same for both the left and right channels.

Bias Adjustment

- Connect 8 ohm load resistors to the Speaker A terminals, and set the Speaker A switch to ON position.
- Turn the Volume control fully counterclockwise.
- Turn R1412 fully counterclockwise.

- Using digital multimeter set meter to read 200 mV. Connect probes to emitters of Q1408, Q1409 (Voltmeter bias test points, L channel). Turn unit ON. Let it idle for at least one minute. Adjust R1412 for 30 mV across the resistors.
- Perform the same procedure for the right channel, except measure voltage at emitters of Q1458, Q1459 (voltmeter bias test). Adjustment is made with R1462.
- Leave the amplifier on for about 30 minutes, then recheck measurement. A tolerance of $\pm 25\%$ is acceptable. Readjust if necessary.

Power Indicator Adjust (355R and 375R)

- With all controls flat and volume at maximum, adjust input signal for an output level of 40 watts (no load) at 1 kHz.
- Adjust controls located on PWB behind front panel (R861 for left channel, R877 for right channel) for an output power reading of 40 watts.

Power Indicator Adjust (385R)

- With all controls flat and volume at maximum, adjust input signal for an output level of 65 watts (no load) at 1 kHz.
- Adjust controls R705 and R755 located on PWB behind front panel (R705 for left channel, R755 for right channel), for an output power reading of 65 watts.

Frequency Display Adjustment, (375R, 385R)

- Adjust R803 located on PCB behind front panel for 7.0-8.0V on pin 13 of IC801. Note this voltage should be as low as possible within the above range while still maintaining reliable display under normal user conditions.

FM Display Adjustment.

- Tune receiver to FM broadcast station of known frequency (the lock circuit may be used for accuracy). Adjust R808 until display reads the known station carrier frequency.
Note: It is important that pot R808 be rotated left and right through the range where the correct frequency is displayed ending in the center of the range.

AM Display Adjustment

- Carefully tune receiver to center of AM station of known broadcast frequency. Adjust R809 until display reads the exact carrier frequency.

Power Transformer Temperature Sensor Adjustment.

- Connect DMM to measure DC voltage at test terminals.
- With unit at room temperature 20°C (68°F) adjust R627 for 400 mV.
- If transformer temperature is within the range of 10-30°C, the measured voltage should be corrected by -7.5 mV for each degree above 20 and +7.5 mV for each degree below 20.

Heat Sink Temperature Sensor Adjustment (385R)

- Follow the above procedure setting the voltage at the test terminals at 900 mV when heatsink temperature is 20°C.

Dial Cord Stringing

- Loosen the screw securing the drum to the variable capacitor shaft.
- Tie the end of the cord "A" as shown to the fixing protrusion on the drum.
- Wind the cord two turns around the drum then thread it through the rollers, etc., following the illustration.
- Tie the end of the cord to the coiled spring so that the proper tension of the dial cord is obtained.
- Align the pointer position for the correct frequency indication on the tuning dial.
- Secure the screw on the drum.

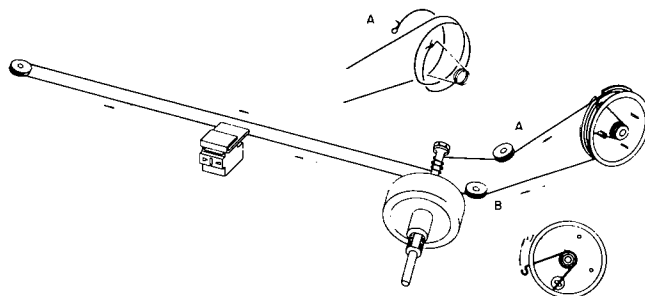

Fluorescent Indicator Panels (FIP)

Power

The models 355R and 375R utilize the same basic power display tube and both are driven by IC806, a type LC7555. The fundamental difference between the two tubes is the scale marking. Therefore, replacement parts should be ordered by part number for the appropriate model no.

The 385R utilizes a more sophisticated power meter, one which is the result of joint efforts by SCOTT and NIPPON ELECTRIC CO., LTD. Engineers to develop this multi-purpose tube to SCOTT specifications.

Tuning

The tuning display tube used in the 375R and 385R provides indication of AM and FM signal strength. FM center tuning, and a frequency read-out of both the AM and FM bands.

Drawings on the following pages show the pin connections to the various elements of the above mentioned FIPs.

Caution

THESE FIPs, BEING MADE OF GLASS ARE EASILY DAMAGED. A LOSS OF VACUUM OR BREAKAGE CAN RESULT FROM PHYSICAL SHOCK OR STRESS DURING HANDLING AND INSTALLATION.

"FIP" LEAD CODE

The following pages contain outline drawings and lead codes for FIPs used in these models.

Pin no.	1	2	3	4	5	6	7	8	9	10	11	12	13	14	15	16	17	18	19	20	21	22	23	24	25	26	27	28	29	30	31	32	33	
Electrode	F	NP	SC	1a	G	2a	3a	4a	5a	6a	1b	2b	3b	4b	5b	6b	7b	G	8b	9b	10	11	12	7a	8a	9a	10	11	12	NP	NC	NP	F	
																							b	b	b	a	a	a	a					

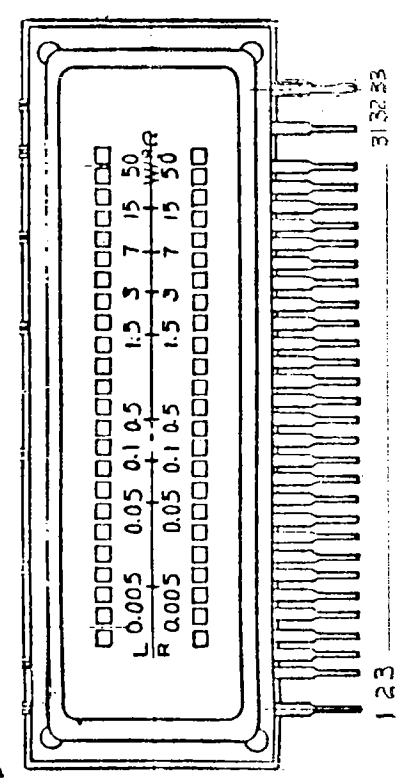
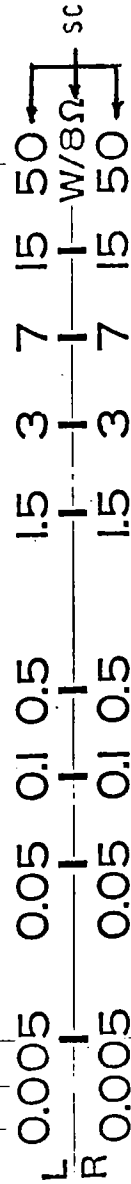
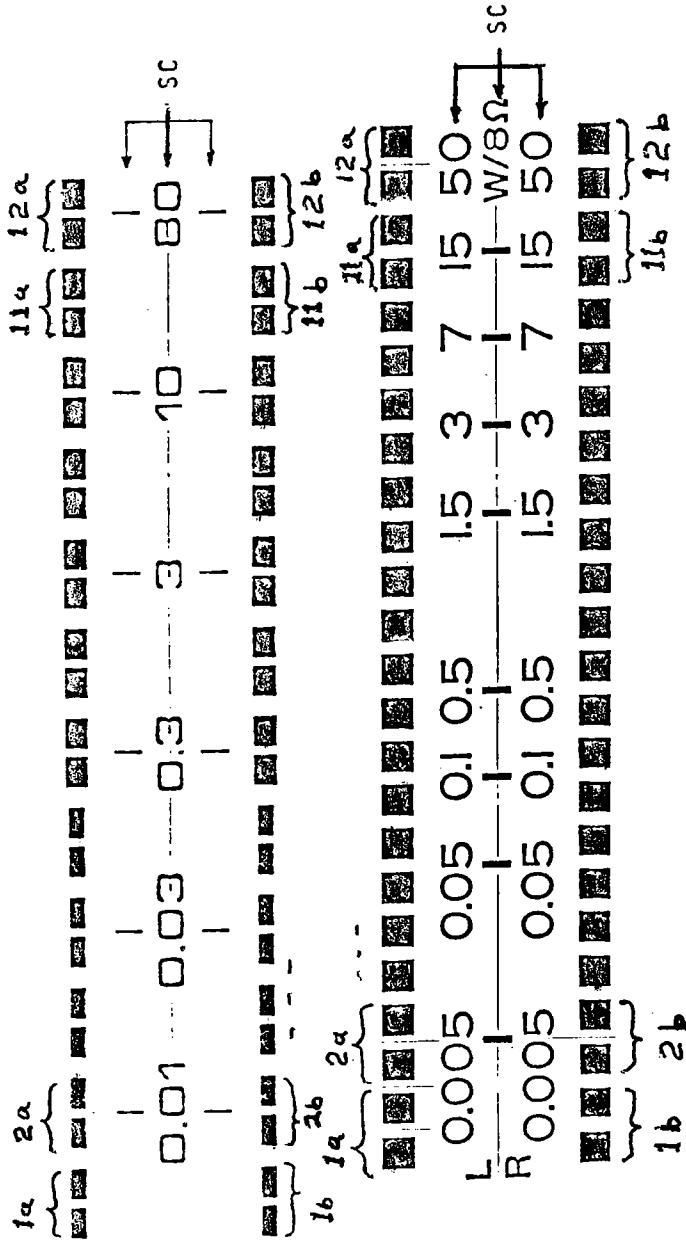

FL 801
TYP. BG-32, BG-60
355R-375R

FL-701
385R

TERM. NO.	1	2	3	4	5	6	7	8	9	10	11	12	13	14	15	16	17	18	19	20
ELECTRODE	F	G	P1	P2	P3	P4	P5	P6	PA	PB	PC	PD	G	PE	PF	P%	PW	Ps	Ps	3

TERM. NO.	21	22	23	24	25	26	27	28	29	30	31	32	33	34	35	36	37	38	39	40
ELECTRODE	Ps	1	Lch	P	P	G	PI	PJ	PK	PL	P+8	P	P	P	P	P	P	P	G	F

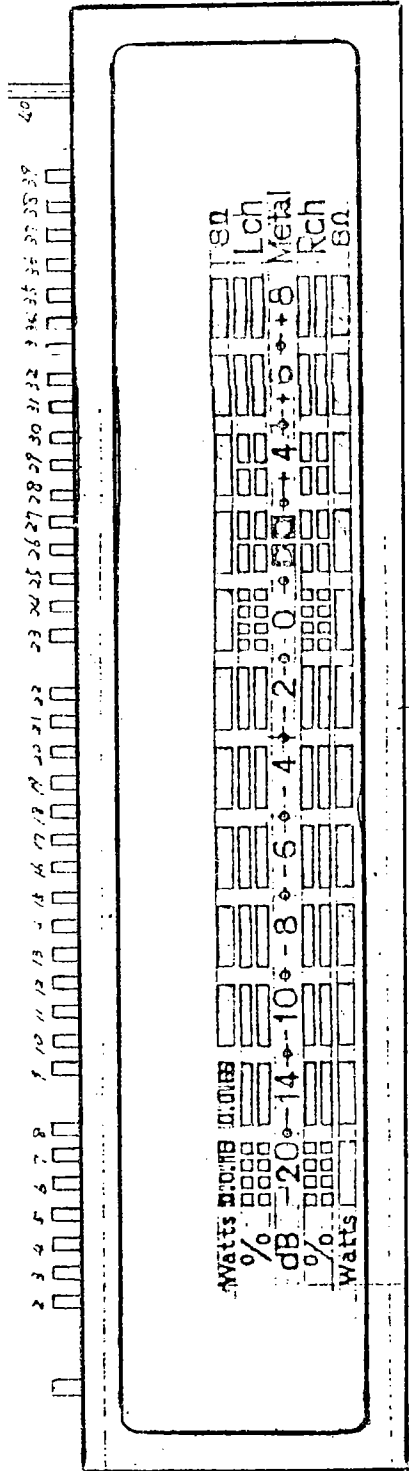
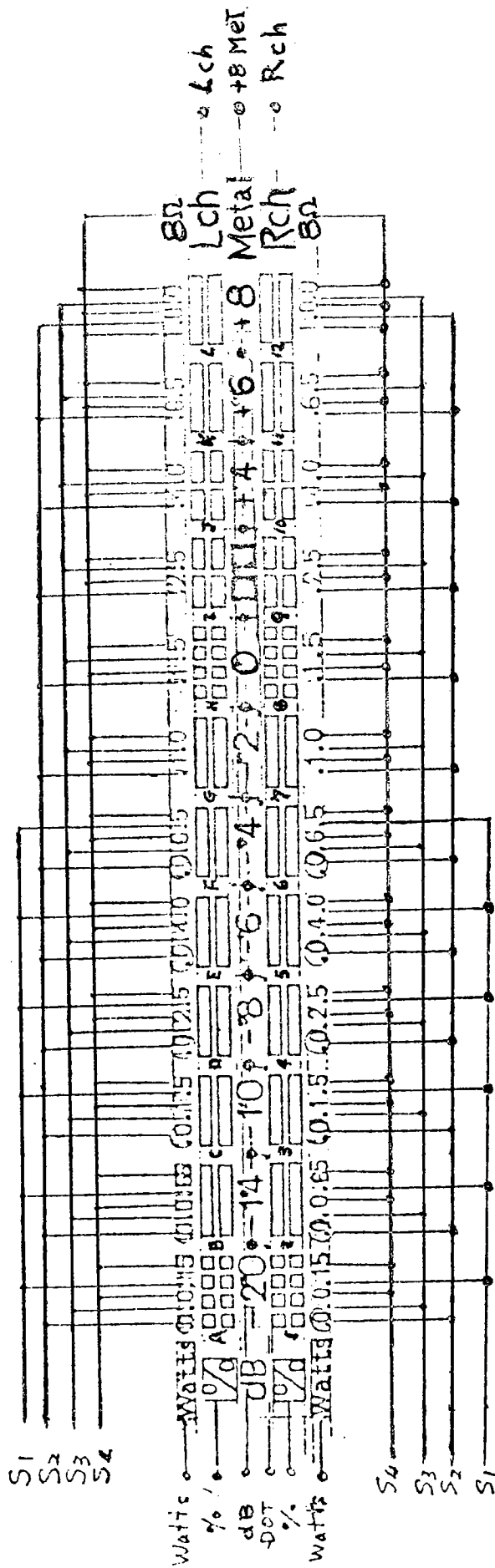

Parts Location Diagrams
375R 385R
Tuner, Amplifier and Protection

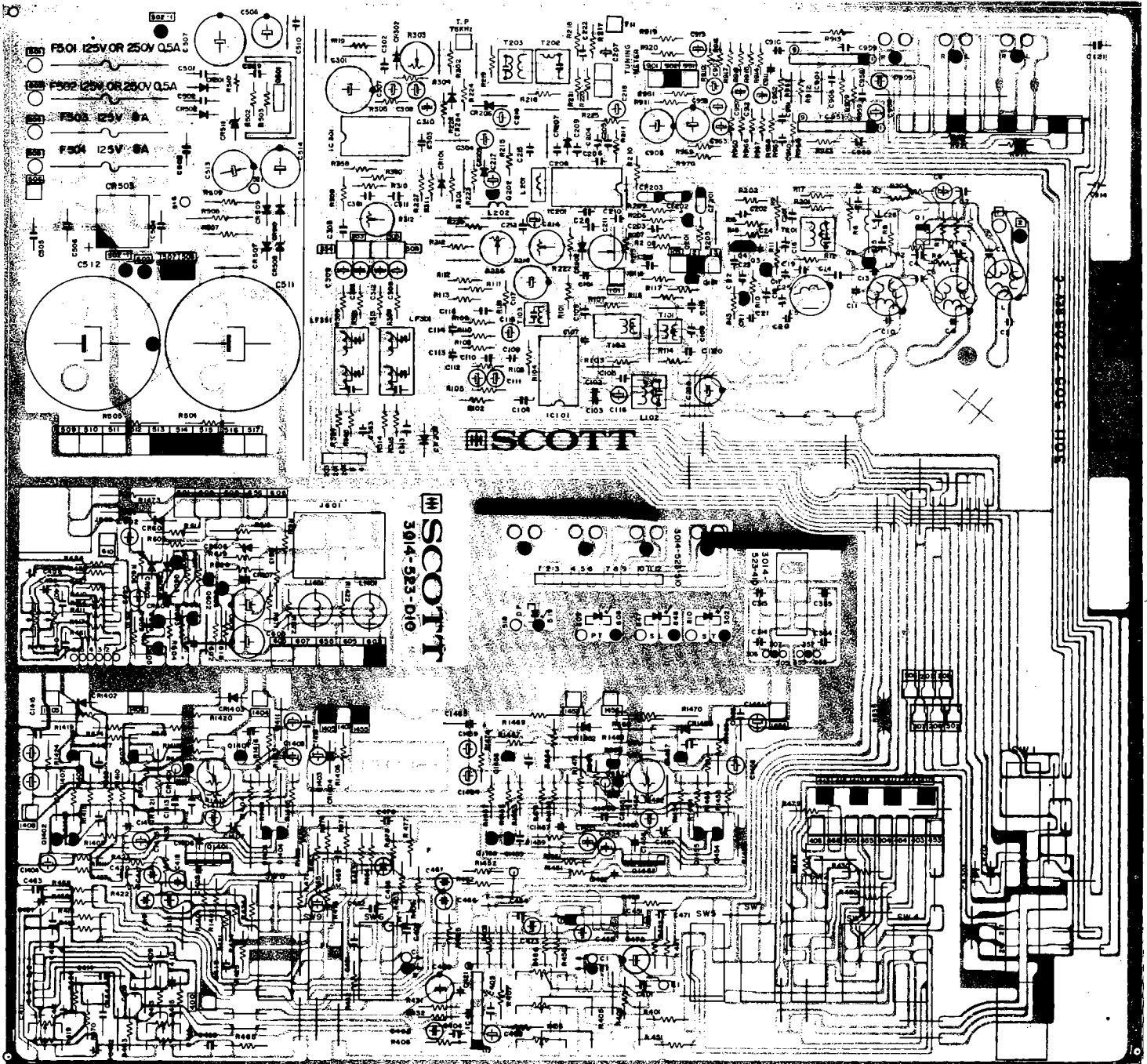

Parts Location Diagram 355R Tuner, Amp, Protection

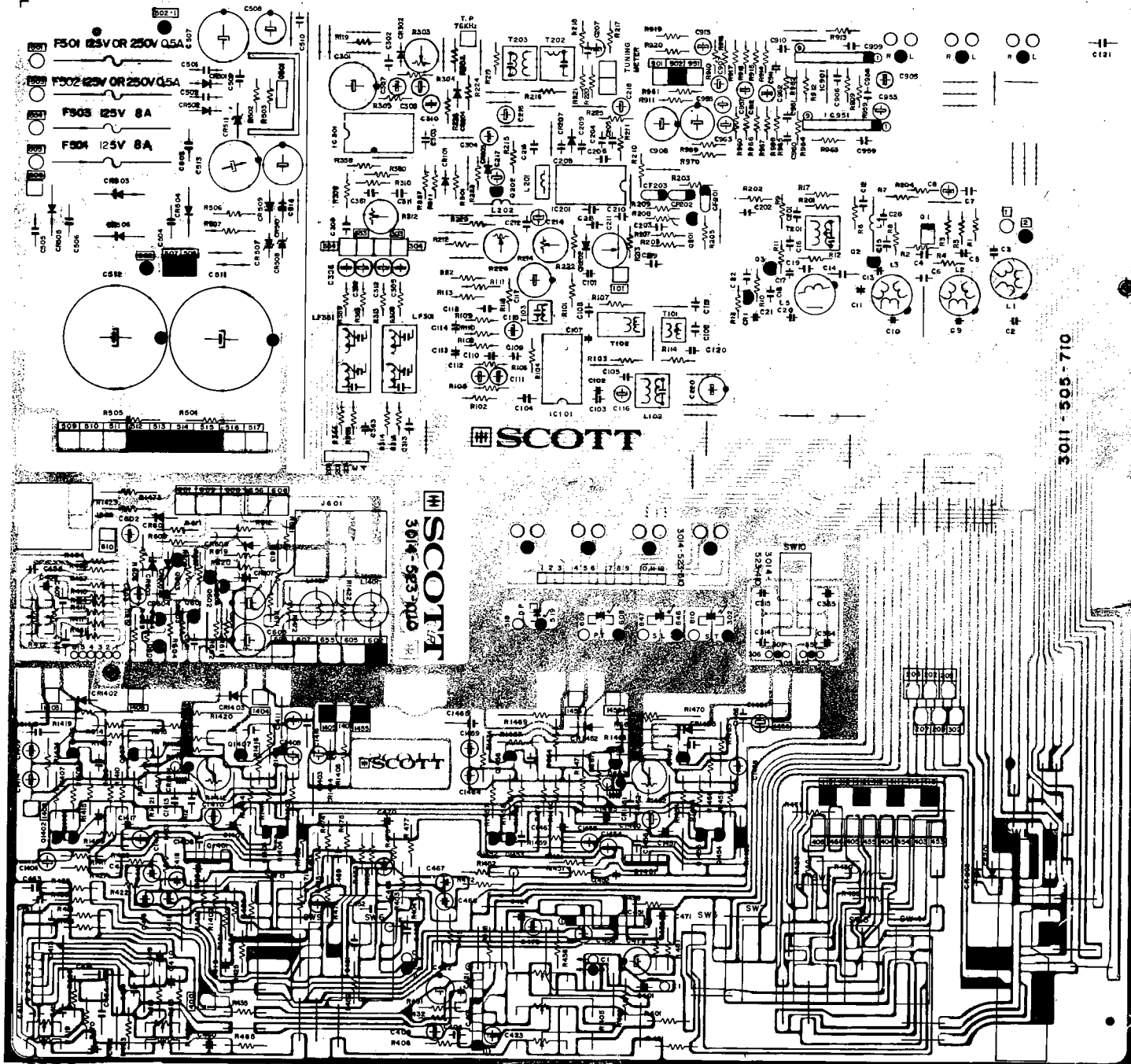

**Parts Location Diagram
375R, 385R Display**

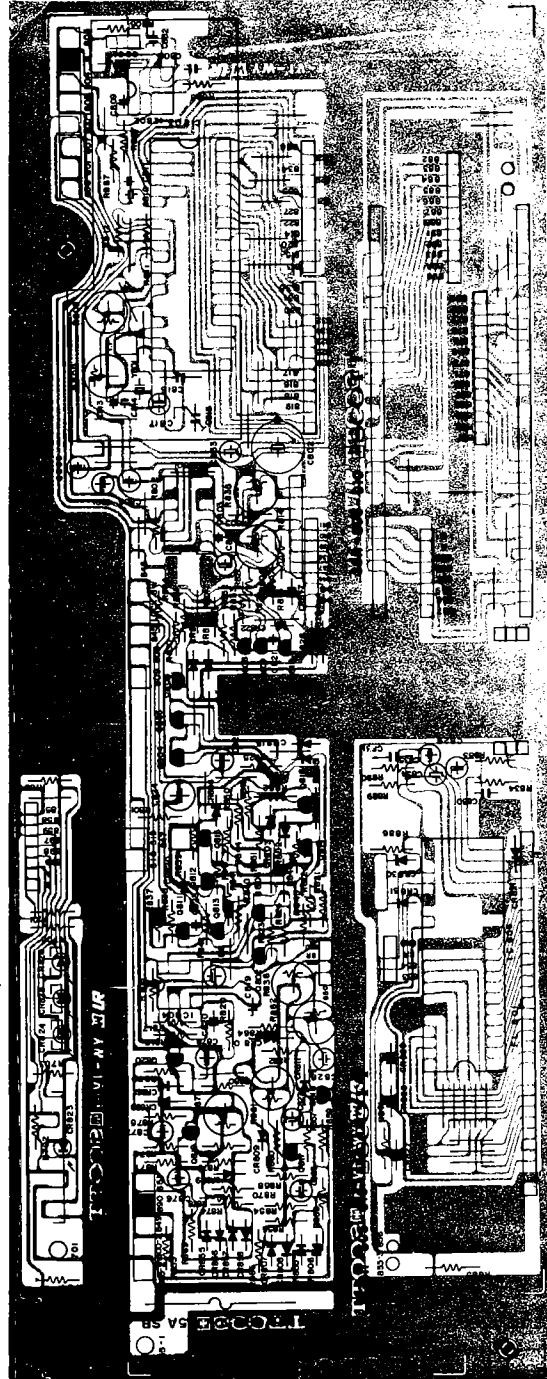

**Parts Location Diagram
Moving Coil Preamp.**

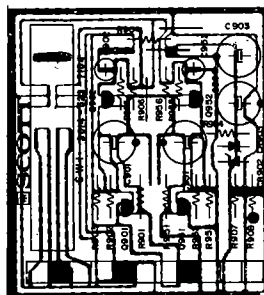

NOTES

- 1) Many transistors used in these models are identified by "KS" in place of the more familiar "2S" prefix. Generally these parts are electrically interchangeable. However, when replacing the SMALL SIGNAL devices, please observe proper transistor basing.
- 2) Pushbutton switch banks are available as a complete assembly or as individual sections. It is suggested that individual sections be replaced rather than the entire assembly. Therefore when ordering, specify both part number for assembly and describe individual section by its front panel function.
- 3) When ordering replacement parts please give complete information as listed in the parts list section. In addition, please note the unit model number.
- 4) Power transformer part numbers may vary from those listed here, therefore please give part number of old transformer as well as all information from parts list herein.
- 5) Input power of typical unit, properly adjusted at 120V line, volume minimum, switched to FM is 35 watts, 0.5A.

SCOTT 385R EXPLODED VIEW

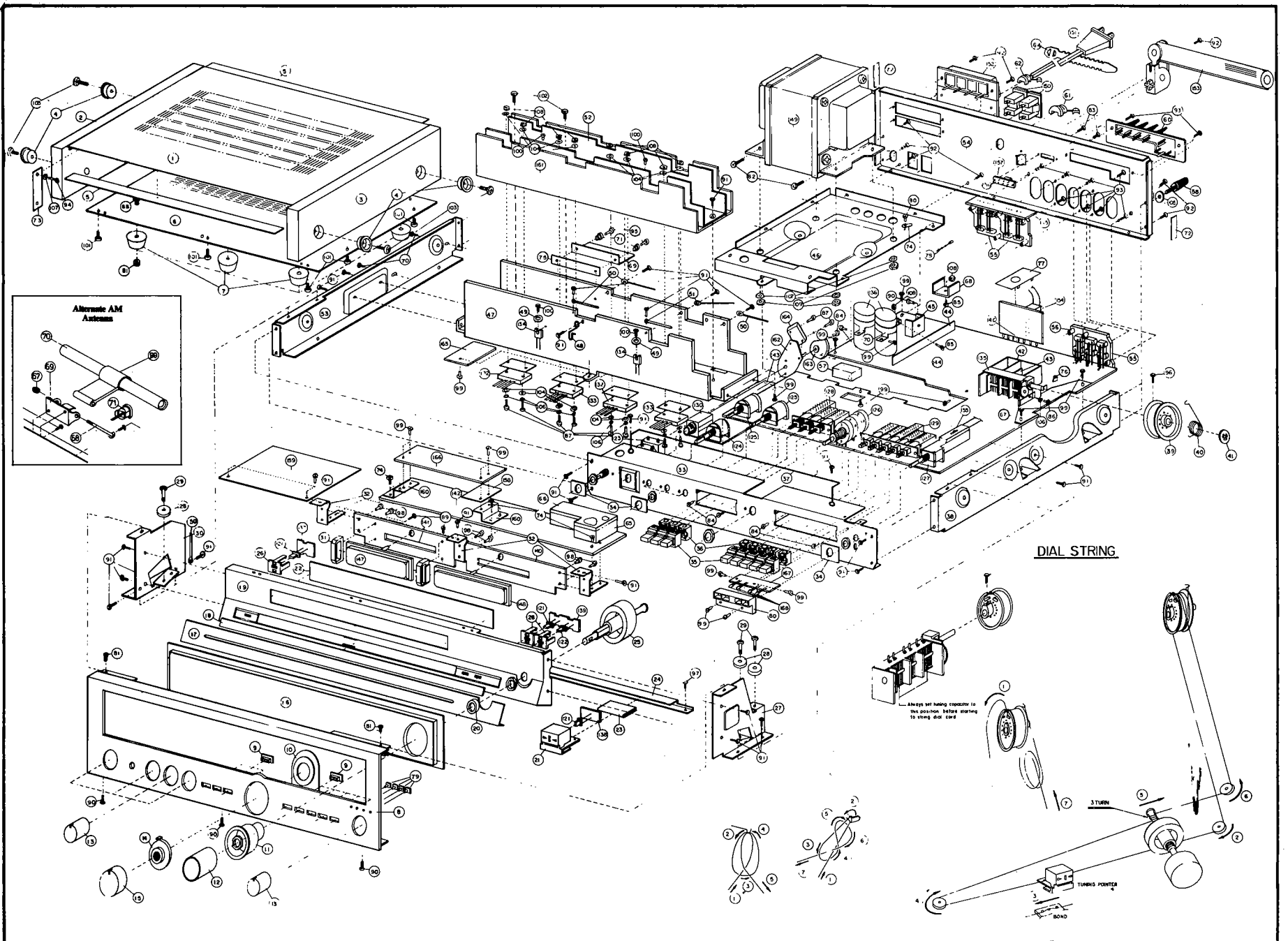

**REPLACEMENT LIST OF MECHANICAL AND ELECTRO MECHANICAL PARTS—
REFER TO 385R EXPLODED VIEW**

SYMBOL	PART NO.	DESCRIPTION	SPECIFICATION	USED IN
1	6102-502-8101	CABINET	1.0T VINYL STEEL	ALL
2	6103-500-3107	SIDE-CABINET-L	15T PLYWOOD VINYL	ALL
3	6103-500-4102	SIDE-CABINET-R	15T PLYWOOD VINYL	ALL
4	7334-500-1106	WASHER-CABINET	P.P BLACK	ALL
5	6804-502-2206	SPACER-CABINET	1.0 HIMERONE SHEET	ALL
6	6022-505-6107	CHASSIS-BOTTOM	1.0T SPC-1 FZY	ALL
7	6074-500-2101	FOOT	RUBBER	ALL
8	7702-507-7100	PANEL-FRONT	AL EXTRU	355R
8	7702-507-7207	PANEL-FRONT	AL EXTRU	375R
8	7702-507-7304	PANEL-FRONT	AL EXTRU	385R
9	6463-500-7106	GUIDE-KNOB "F"	ABS GREY	ALL
10	7714-504-7207	PLATE-BACK VOL.	0.8T ALS	ALL
11	7603-502-1109	MASK-TUNING	ABS GREY	ALL
12	7724-507-7104	KNOB-TUNING	ALB ALUMITE	ALL
13	7724-505-6103	KNOB-ROTARY	ALB ALUMITE	ALL
14	7724-506-0106	KNOB-BALANCE	94HB ACRYL CLR	ALL
15	7724-503-7108	KNOB-VOLUME	ALB ALUMITE	ALL
16	7653-501-4106	DIAL WINDOW	5.0T ACRYL CLR	ALL
17	8012-504-1106	SCALE-DIAL	0.5T ALS OFFSET	355R
17	8012-504-1203	SCALE-DIAL	0.5T ALS OFFSET	375R
17	8012-504-1300	SCALE-DIAL	0.5T ALS OFFSET	385R
18	8014-502-7104	BLIND-SCALE	ACRYL 0.5T×373×13	ALL
19	8012-504-0208	SCALE-BACK	1.0T SPC-1 MET GRY	355R
19	8012-504-0101	SCALE-BACK	1.0T SPC-1 MET GRY	375R
19	8012-504-0305	SCALE-BACK	1.0T SPC-1 MET GRY	385R
20	6834-506-6103	SPACER	RUBBER 3.5T	ALL
21	8003-500-4101	CAP-POINTER	ABS BLK	ALL
22	7654-503-3104	FILTER-WINDOW	ACRYL 0.5T	355R
22	7653-503-0102	FILTER-WINDOW	ACRYL 0.5T	375R
22	7653-503-0209	FILTER-WINDOW	ACRYL 0.5T	385R
23	0859-141-6008	TEFLON TAPE	W 25.4×33Y×0.8T	ALL
24	6613-506-1105	BRKT-GUIDE PNTR	0.8T SPCY-1 FZW	ALL
25	5104-509-1100	SHAFT-TUNING	MB R2 GC10	ALL
26	6603-500-6107	HOLDER-LED,S	ABS NATURAL	ALL
27	6614-583-2106	BRACKET, SCALE, R	1.0T SPC-1 FZW	ALL

SYMBOL	PART NO.	DESCRIPTION	SPECIFICATION	USED IN
28	5214-501-3104	PULLY GUIDE	PA WHITE	ALL
29	7394-500-5106	SHAFT GUIDE	FE FZY	ALL
30	6613-504-3109	BRACKET, SCALE L	1.0T SPC-1 FZW	ALL
31	6603-101-2104	HOLDER-DIGITRON	PS H/T 100%	355R, 375R
31	6603-101-3105	HOLDER-FL	ABS BLACK	385R
32	6614-587-4108	BRKT-PWB (F)	1.2T S PC-1 FZW	ALL
33	6022-505-5104	CHASSIS-FRONT	1.0T SPC-1 FZY	355R
33	6022-505-5102	CHASSIS-FRONT	1.0T SPC-1 FZY	375R
33	6022-505-5209	CHASSIS-FRONT	1.0T SPC-1 FZY	385R
34	7604-502-1109	MASK-KNOB	0.5T HIMERONE	ALL
35	7723-500-5106	KNOB-PUSH "F"	ABS	ALL
36	6463-500-1106	GUIDE-KNOB	PE SOFT NAT	ALL
37	6654-507-9105	SUPPORT-G POINTER	STS P1 1.0	ALL
38	6023-502-1100	FRAME-R	1.2T SPC-1 FZY	ALL
39	5223-500-6104	WHEEL-DRUM	ABS NATURAL	ALL
40	6674-510-2100	SPRING, DIAL	STS P1 1.0	ALL
41	6674-508-6103	STOP-SPRING	SPS-27 0.3T	ALL
42	4543-500-8102	SHIELD FENCE	0.3T TE SBC	ALL
43	4544-503-1103	SHIELD PLATE-T	0.3T TE SBC	ALL
44	4544-503-0108	SHIELD PLATE-P	0.3T TE-SBC	ALL
45	5684-501-1101	HEAT SINK, TR	1.5T ALS	ALL
46	6613-506-0100	BRACKET, TRANS	1.2T SPC-1 FZY	ALL
47	5682-502-2105	HEAT SINK	2.5T ALS	ALL
48	6654-507-8100	SUPPORT-B PNTR	STS P1 1.0	ALL
49	6844-503-1201	WASHER-CABINET	0.8T FIBER	ALL
50	6634-105-6409	CLAMPER-WIRE	0.5T SPC-1 FZY	ALL
51	6634-100-1904	CLAMPER-WIRE	SPC-1 0.6 TFT	ALL
52	5683-501-3104	HEAT SINK A	2.0T ALS	355R
52	5682-501-1207	HEAT SINK SUB	1.5T ALS	375R, 385R
53	6023-502-0100	FRAME-L	1.2T SPC-1 FZY	355R
53	6023-502-0105	FRAME-L	1.2T SPC-1 FZY	375R, 385R
54	6022-505-4107	CHASSIS, REAR	1.0T SPC-1 BLK	355R
54	6022-505-4204	CHASSIS, REAR	1.0T SPC 1 BLK	375R
54	6022-505-4505	CHASSIS, REAR	1.0T SPC 1 BLK	385R
55	3339-543-0105	JACK, AUX	ABS & 4P BLK	ALL
56	3339-543-0202	JACK, AUX	ABS & 2P BLK	ALL

SYMBOL	PART NO.	DESCRIPTION	SPECIFICATION	USED IN
57	6834-502-0101	SPACER	1.0T×30×25 RUBBER	ALL
58	3104-501-6109	TERMINAL, SCREW	ABS	ALL
59	7304-100-2100	WASHER-PLAIN	0.5T×3.5×7P1 FE FZY	ALL
60	3303-500-1100	TERMINAL BD	5T SCREW ABS BLK	ALL
61	6634-100-8103	CLAMPER, CORD	HEYCO SR4N4	ALL
62	6634-100-7108	CLAMPER, CORD	HEYCO SR 3P4	ALL
63	3304-501-6105	TERM BD PUSH	DRP 0.03 4P	ALL
64	6634-101-8106	BAND, CORD WIRE	P.P BLACK	ALL
65	4543-500-9107	SHIELD-FENCE FL	0.3T TE-S BC	375R, 385R
65	6603-103-7105	HOLDER-LED	ABS NAT	355R
66	4543-501-0105	CAP-SHIELD, FL	0.3T TE-SBC	375R, 385R
66	6834-503-5109	MASK, LIGHT T	RUBBER, SPONGE 6T	355R
67	6634-100-6103	BAND WIRE	P.P BLK	355R
67	6613-506-4207	BRKT-PROT PWB	0.8T SPC-1 FZY	375R, 385R
68	4544-502-2105	SHIELD CAP-2	TE-SBC 0.3T	355R
68	5684-502-8109	HEATSINK, DIODE	ALS 1.5T	375R, 385R
69	3124-100-7105	TAP-STUD	0.5T SPC-1 BT 2	355R
69	6614-591-6101	BRKT-BAND CAP	1.2T SPC-1 FZY	375R, 385R
70	3114-102-4208	LUG	0.3T TE-S BC	355R
70	6634-102-7201	BAND-CAP	0.8T SPC-1 FZY	375R, 385R
71	4544-500-5104	SHIELD FENCE	TE-SBC 0.3T	355R
71	3934-103-1103	INSUL-TR	NYLON 66	375R, 385R
72	6804-502-8106	SPACER-CAB	0.5T HIMERONE	375R, 385R
73	4544-500-5104	SHIELD-FENCE	TE-SBC 0.3T	375R, 385R
74	3114-102-4208	LUG	0.3T T TE-SBC	375R, 385R
75	3934-500-7100	INSULATOR PLATE	1.0T FIBRE	375R, 385R
76	3124-100-7105	TAP-STUD	0.5T SPC-1 BT2	375R, 385R
77	4544-502-2105	SHIELD CAP-2	TE-SBC 0.3T	375R, 385R
78	6634-100-6103	BAND WIRE	P.P BLK	375R, 385R
79	7654-565-3106	INDICATOR-SEL	ACRYL CLEAR	385R
80	6604-513-2104	HOLDER-LED	RUBBER, 94V-OW	385R
81	7018-130-0815	SCREW-FH	+ M3×8FE FZY	ALL
82	7028-140-1010	SCREW-TH	+ M4×10 FE FZY	ALL
83	7048-126-0437	SCREW-RH	+ M2.6×4 FE FZY	ALL
84	7048-130-0616	SCREW-RH	+ M3×6 FE FZY	ALL

SYMBOL	PART NO.	DESCRIPTION	SPECIFICATION	USED IN
85	7048-130-1213	SCREW-RH	+ M3×12 FE FZY	375R, 385R
85	7048-130-1019	SCREW-RH	+ M3×10	355R
86	7048-130-0412	SCREW-RH	+ M3×4 FE FZY	ALL
87	7048-130-1514	SCREW-RH	+ M3×15 FE FZY	ALL
88	7048-130-1019	SCREW-RH	+ M3×10 FE FZY	375R, 385R
89	7148-130-0619	SCREW-TAP, RH	1-3×6 FE FZY	ALL
90	7148-530-0615	SCREW-TAP RH	2S-3×6 FE FZY	ALL
91	7148-530-0819	SCREW-TAP RH	2S-3×8 FE FZY	ALL
92	7148-530-0837	SCREW-TAP RH	2S-3×8 FZB	ALL
93	7148-130-0831	SCREW-TAP RH	1-3×8 FZB	ALL
94	7148-130-1012	SCREW-TAP RH	1-3×10 FZB	ALL
95	7148-530-1212	SCREW-TAP RH	2S-3×12 FZY	355R
95	7148-530-1018	SCREW-TAP RH	2S-3×10 FZY	375R, 385R
96	7148-530-1212	SCREW-TAP RH	2S-3×12 FZY	375R, 385R
97	7158-530-0832	SCREW-TAP BH	2S-3×8FE FZB	ALL
98	7098-130-0611	SCREW-FLANGE, RH	+ M3×6 FE FZY	ALL
99	7154-100-6303	SCREW-TAP RH	2S-3×8 FE FZY	ALL
100	7154-100-6701	SCREW-TAP RH	2S-3×2 FE FZY	ALL
101	7128-540-0810	SCREW-TAP TH	2S-4×8 FE FZY	ALL
102	7128-540-1213	SCREW-TAP TH	2S-4×12 FE FZY	ALL
103	7128-540-2032	SCREW-TAP TH	2S-4×20 FZB	ALL
104	7304-100-2100	WASHER-PLAIN	0.5T×3.5×7.5P1	ALL
105	7304-500-2106	WASHER-PLAIN	4.5 P1×100 P1×1.5T	ALL
106	7318-103-0014	WASHER-SPRING	PI3.0 (3.1×5.9×0.7T)	ALL
107	7328-204-0011	WASHER-TOOTHED	BPI (4.3×8.5×T0.45	ALL
108	7208-113-0017	NUT-HEX	1M3 FE FZY	ALL
109	7208-114-0010	NUT-HEX	1M4 FE FXY	ALL
121	2309-120-0102	LED-SQUARE	LN 217 RPL	ALL
122	2309-119-0108	LED-SQUARE	LN 317 GP	ALL
123	3509-501-0203	SWITCH-SPK/PWR	SFR 2045/SDRIR	355R, 375R*
123	3509-501-0504	SWITCH-SPK/PWR	SFR 20451/SDR3R	355R, 375R*
123	3509-201-1502	SWITCH-SPK	SRF 485	355R, 385R**
123	3509-501-0708	SWITCH-SPK	SRF 4078	385R
124	1219-108-0105	VR-BASS	GMPE 20FM7C100K	355R
124	1269-111-1503	VR-BASS	GMPE 20FM7C100K	375R, 385R
125	1269-111-1309	VR-MID/TREB	GM70E 20FM7C100K	355R

*Early production, grey power switch.

**Later production using micro switch, see items 162, 163, 164.

SYMBOL	PART NO.	DESCRIPTION	SPECIFICATION	USED IN
125	1269-111-1406	VR-MID/TREB	GM70E 20F C100K	375R, 385R
126	1299-102-0107	VR-VOL	FJ60E 2SFM11	355R
126	1299-102-0204	VR-VOL	FJ60E W250K/B100K	375R, 385R
127	3509-201-0507	SW-ROT-SLIDE	SRZ VO45N	355N
127	3509-501-0106	SW-ROT-SLIDE	SRZW045N	375R, 385R
128	3529-203-1702	SW-PUSH, FIL/LOUD	SUF32 4C-4C, 2C	ALL
129	3529-203-1809	SW-PUSH, MODE-TAPE	SUF52 2C×29	ALL
130	3339-511-0203	JACK-EARPHONE	HLJ0290-01-020	ALL
132	SEE TRANSISTOR LIST			ALL
133	SEE TRANSISTOR LIST			ALL
134	2189-105-1007	VARISISTOR-STV3H	7MA 1.6-1.8V	ALL
135	1809-400-0101	VARICON-AIR	C774J	ALL
136	SEE CAPACITOR LIST			ALL
137-146	PCB ASSYS ARE GENERALLY NOT AVAILABLE FOR REPLACEMENT*			
147	2319-101-0302	DIGITRON-PWR	BG 32	355R
147	2319-101-0409	DIGITRON-PWR	BG 60	375R
147	2319-101-0506	DIGITRON-PWR	FIP 12AW 12YS	385R
148	2309-117-0102	LED METER	LNO5202P	355R
148	2319-101-0205	DIGITRON-FREQ	7-LT-08	375R, 385R
149	2869-197-9003	TRANS-PWR	W/O SENSOR	355R
149	2869-197-7031	TRANS-PWR	W/SENSOR	355R
149	2869-197-9100	TRANS-PWR		375R
149	2869-198-0108	TRANS-PWR		385R
150	3334-500-1005	JACK-AC OUTLET	125V 15A S-16444	ALL
151	3053-806-3101	POWERCORD, AC	STP1 18 BLK	ALL
152	3304-501-6105	TERM BD, PUSH	DRP 003 4P	ALL
153	SEE PARTS LIST UNDER COILS			ALL
154	3519-501-0509	SWITCH-INPUT SEL	SSR 22602D	375R, 385R
155	3349-519-9100	SW, DENTENT, FLEX	SWR 6300	375R, 385R
156	DEEMPHASIS PWB—NOT AVAILABLE			ALL
157	3519-201-0609	SW, SLIDE, DEEMP	SSB 023N	ALL
158	3934-501-110	INSULATOR, FIB-A	0.8T×45×52	385R
159	3934-501-2108	INSULATOR, FIB	1.0T×160×72	385R
160	6614-595-4103	BRKT-BWB, S	1.2T SPC-1 FZY	385R
161	5682-501-5107	HEATSINK, B	2.0T ALB BLK	385R

*Check with service manager for possible limited availability of used assemblies.

SYMBOL	PART NO.	DESCRIPTION	SPECIFICATION	USED IN
162	6614-592-9109	BRKT PWR, SW	1.0T SPC-1 FZY	385R
163	5244-500-3106	CAM-S/W	2.0T SPC-1 FZY	385R
164	3599-902-020	SW/PWR	SDR3R	355R, 375R*
164	3579-101-0105	MICRO SW	AH 715457	355R, 375R, 385R
165	3014-528-9109	PWB, THERM PROT	CHECK AVAILABILITY	385R
166	3013-507-8102	PWB, DRIVE, FL	CHECK AVAILABILITY	385R
167	3014-529-0107	PWB, LED FUNCTION	CHECK AVAILABILITY	385R
168	2309-101-4103	LED	LD 30A RED 3 P1	385R

*Used in early production. (Grey pwr sw only).

DIODES

SYMBOL	PART NO.	DESCRIPTION	SPECIFICATION	USED IN
CR801	2309-119-0108	LED-SQUARE	LN 317 GP	ALL
CR301, CR603	2309-120-0102	LED-SQUARE	LN 217 RP	ALL
CR512, CR825				
CR716, CR717	2309-101-4103	LED	LD30 A RED 3PI	ALL
CR718				
	2309-104-2102	LED-DELTA	SLP 239B	355R Pointer
SEE SCHEMATIC				
ALL MODELS	2169-301-2901	DIODE, SWITCHING	1SS53	See Schematic
CR-1	2169-501-1603	DIODE, AFC	KS3302, 4-7.5PF	ALL
CR507, CR508	2169-404-2200	DIODE-ZN WZ220	50MW 20.8-22.3V	ALL Δ
CR501, CR502	2169-201-0504	DIODE, RECTIFIER	IN4001, 1A, 50V	ALL Δ
CR503, CR504	2169-201-1509	DIODE, RECTIFIER	IN4142, 3A 400V	355R Δ
CR505, CR506				
CR509, CR510, CR601	2169-201-0601	DIODE, RECTIFIER	IN4002, 1A 100V	ALL Δ
CR511	2169-403-9202	DIODE-ZN, BZ150	IW 13.8-15.6V	ALL Δ
CR902	2169-404-1409	DIODE-ZN, WZ-061	50MW 5.6-6.5V	375R, 385R Δ
CR901	2169-404-6103	DIODE-ZN Wz120	500MW, 11,4-12.6V	375R, 385R Δ
CR608, CR1401	2189-105-1007	VARISTOR-STV 3H	7MA 1.6-1.8V	ALL Δ
CR1451				
CR1402, CR1403	2169-201-0708	DIODE, RECTIFIER	IN4003, 1A,200V	ALL Δ
CR1452, CR1453				
CR1404, CR605	2169-403-2207	DIODE, ZN, WZ-182	50MW, 16.8-19.1V	ALL Δ
CR810, CR811	2169-101-1403	DIODE, GER, IN60	IR 15UA	355R, 375R
CR860, CR861				

FUSES

SYMBOL	PART NO.	DESCRIPTION	SPECIFICATION	USED IN
F505	4709-031-4004	FUSE	NOR 125V 6A, 31, 8 UL	375R, 385R Δ
F505	4709-031-3106	FUSE	NOR 125V 5A, UL	355R Δ
F801	4709-133-1402	FUSE W/LEAD	SLO 125/250 0.5A UL	ALL Δ
F501, F502				
F503, F504	4709-131-3309	FUSE W/LEAD	NOR 125V, 8A UL	ALL Δ

INTEGRATED CIRCUITS

SYMBOL	PART NO.	DESCRIPTION	SPECIFICATION	USED IN
IC701	2119-101-4500	IC	TA 7318P	385R
IC806	2119-201-1300	IC-DISPLAY	LC 7555	355R, 375R
IC702	2119-201-3203	IC-DISPLAY	LC 7556	385R
IC101	2119-201-0907	IC-AM IF	HA 1197	ALL
IC201	2119-201-0402	IC-FM IF	HA 1137W	ALL
IC301	2119-201-1106	IC-MPX	HA 1196	ALL
IC901, IC951	2119-401-0206	IC-OP	TA 7322P	ALL
IC401, IC451				
IC801	2119-601-0301	IC-REG	LA 5700	375R, 385R Δ
IC802	2119-601-0204	IC-PRESCALER	SP 8629	375R, 385R
IC803	2119-201-1203	IC-FREQ. DISP.	LC 7258	375R, 385R
IC804	2119-401-0303	IC-OP	NJM 4558 DD	ALL
IC805	2119-201-2004	IC-SIG	BA 6104	ALL

RESISTORS SAFETY, CRITICAL COMPONENTS Δ AND SPECIALTY ITEMS.

SYMBOL	PART NO.	DESCRIPTION	SPECIFICATION	USED IN
R214, R312	1249-102-0908	VR-SEMI	SR19R B220K	ALL
R226	1249-102-0403	VR-SEMI	SR19R B22K	ALL
R303, R808, R809	1249-102-0306	VR-SEMI	SR19R B10K	ALL
R861, R877				
R1412, R1462	1249-102-0102	VR-SEMI	SR19R B470	ALL
R627, R803	1249-102-1000	VR-SEMI	SR19R B2.2K	ALL
R835, R705	1249-102-0209	VR-SEMI	SR19R B4,7K	ALL
R755				
R886	1249-102-0704	VR-SEMI	SR19R B100K	375R
R504, R505	1049-301-3106	R-METAL OXIDE	RSIP 3.3K-K	ALL Δ
R709				
R506, R507	1049-301-2402	R-METAL OXIDE	RSIP 820-K	ALL Δ
R509	1049-105-2202	R-METAL OXIDE	RS3P 560K	ALL Δ
R1407, R1457	1049-301-0101	R-METAL OXIDE	RSIP 10K	
R1408, R1458				
R1422, R1472				
R1413, R1463	1049-301-1300	R-METAL OXIDE	RSIP 100-K	ALL Δ
R1424, R1474				
R1417, R1467				
R1418, R1468	1049-301-1504	R-METAL OXIDE	RSIP 150-K	ALL Δ

CRITICAL COMPONENTS Δ

SYMBOL	PART NO.	DESCRIPTION	SPECIFICATION	USED IN
R1421, R1471	1049-315-0104	R-METAL OXIDE	RS2P 10J	ALL
R1422, R1472	1049-315-0104	R-METAL OXIDE	RS2P 10J	385R Only
R1423, R1473	1049-103-2002	R-METAL OXIDE	RS2P 390-K	375R, 385R
R612	1049-105-1906	R-METAL OXIDE	RS3P 330-K	385R
R613	1049-103-2400	R-METAL OXIDE	RS2P 820-K	385R
R612	1049-103-1803	R-METAL OXIDE	RS2P 270-K	375R, 355R
R1423, R1473	1049-103-1900	R-METAL OXIDE	RS2P 330-K	355R
R613	1049-301-2402	R-METAL OXIDE	RS1P 820-K	355R, 375R
R1422, R1472	1049-301-0101	R-METAL OXIDE	RS1P 10K	355R, 375R
R1419, R1469	1035-905-0908	R-CEMENT WIRE	RW5P 0.47K	ALL
R1420, R1470				

TRANSISTORS

NOTE! TRANSISTORS ARE CONSIDERED CRITICAL COMPONENTS FOR SAFETY AND RELIABILITY REPLACEMENT PARTS MUST BE SAME TYPE OR EQUIVALENT

SYMBOL	PART NO.	DESCRIPTION	SPECIFICATION	USED IN
Q2, Q3	2139-301-0508	TRANSISTOR	KSC 1674-0	ALL
Q101, Q201	2139-301-8508	TRANSISTOR	KSA 838-0	ALL
Q202, 603, 604 606, 607, 657 802, 803, 808 809, 810, 811 812, 813, 814 815, 816, 817 818, 819, 820	2139-302-7409	TRANSISTOR	KSA 945-Y	ALL
Q701, 751	2139-302-7409	TRANSISTOR	KSA 945-Y	385R
Q501	2149-401-2609	TRANSISTOR	KSD 288-Y*	ALL
Q801	2149-401-2609	TRANSISTOR	KSD 288-0	375R, 385R
Q1401, 1451	2139-901-0104	TRANSISTOR	KSA 798G	ALL
Q1402, 1452 1403, 1453 1407, 1457	2149-102-6304	TRANSISTOR	KSA 965 Y	ALL
Q1404, 1454 1405, 1455	2149-304-6405	TRANSISTOR	KSC 2235 Y	ALL
Q1406, 1456	2149-304-6405	TRANSISTOR	KSC 2235 Y	355R
Q1406, 1456	2149-403-3309	TRANSISTOR	KSD 669 A-B	375R, 385R
Q1407, 1457	2149-201-7606	TRANSISTOR	2SB 649 A-B	375R, 385R
Q1408, 1458	2149-101-6107	TRANSISTOR	KSA 1187 Y	375R
Q1408, 1458	2149-301-3207	TRANSISTOR	KSC 2579 Y	355R
Q1408, 1458	2149-301-7605	TRANSISTOR	KSC 2921 Y	385R
Q1409, 1459	2149-201-0300	TRANSISTOR	2SA 1187	375R
Q1409, 1459	2149-101-3209	TRANSISTOR	KSA 1104 Y	355R
Q1409, 1459	2149-101-3607	TRANSISTOR	KSA 1215 Y	385R
Q901, 951	2139-103-8603	TRANSISTOR	KTA 970 BL	375R, 385R
Q902, 952	2139-305-6704	TRANSISTOR	KTC 2240 BL	375R, 385R
Q601, 602	2139-103-7103	TRANSISTOR	KSA 708 Y	ALL
Q605, 804 805, 806	2139-103-3802	TRANSISTOR	KSA 733 Y	ALL
Q702, 703 704	2139-103-3802	TRANSISTOR	KSA 733 Y	385R
Q608, 609	2149-301-3409	TRANSISTOR	KSC 1008 Y	385R
Q1	2139-601-4806	FET	3SK 73 GR	ALL
Q4	2139-601-0301	FET	2SK 212	375R, 385R

*Changed from D2880 to D288Y during production, D288Y is specified.

AM ANTENNA, SEE EXPLODED VIEW INSERT

SYMBOL/ EXP. VIEW NO.	PART NO.	DESCRIPTION	SPECIFICATION	USED IN
67	7224-100-9102	NUT-HEX, CAP	FE ENI	ALL
68	7044-100-1106	SCREW-RH	FE-FNI	ALL
69	6614-117-3100	BRACKET-ANT BAR	1.0T SPC-1 FZB	ALL
L101/70	2509-305-1016	COIL-ANT MW W/CORE	CORE 10 PIX 120	ALL
99	6634-106-4101	BAND-BAR ANT	94HB ABS BLACK	ALL

COILS, TRANSFORMERS, FILTERS & MISC.

SYMBOL	PART NO.	DESCRIPTION	SPECIFICATION	USED IN
L2, L3	2509-106-2104	COIL, FM ANT	TR-A7JZ004S	ALL
L1	2519-106-3104	COIL, FM ANT	TR-A7JZ002S	ALL
L4, L202, L103	2429-040-0302	COIL, CHOKE	2.2UH-K Q30	ALL
L5	2539-107-3107	COIL-FM OSC	TR-A7JZ003S	355R, 375R
L5	2539-108-4105	COIL-FM OSC	CFOR 12 P1010	385R
L201	2429-020-0708	COIL-CHOKE	18 UH-K Q30 F2R5	ALL
L102	2619-511-7093	COIL-RF, AM	340UH A-BASE	ALL
L1401, 1451	2429-060-0401	COIL, CHOKE SPKR	2R5UH-KQ50	ALL
T101***	2619-010-4027	COIL, OSC MW	150UH A BASE	ALL
T103	2749-118-0204	TRANS-IF, AM	7MM CAN	ALL
T102	4529-313-0106	FILTER-CER, AM	7MM CAN	ALL
T201	2739-501-0203	COIL-FM, MIX	TRIO MMA002S	ALL
T202	2739-503-0102	TRANS-FM, IF	TRIO MM 013M	ALL
T203	2739-501-0300	TRANS-FM, IF	TRIO MM 014M	ALL
LF301, 351	4529-415-0509	FILTER, LP	208 BLR 315 7R	ALL
L101*	2509-205-1309	COIL-ANT, AM W/CORE	CORE 10 PIX 120	355R, 375R
L101**	2509-305-1016	COIL-ANT, MW W/CORE	CORE 10 PIX 120	ALL
Y801	4539-501-0403	CRYSTAL	HC-18/U, 4.0 MHz	375R, 385R
L6	2509-105-5106	BALUN	TV750301A2	ALL
K601	4724-100-1201	RELAY, PROTECT	MS4U DC24V 30MA	ALL
	3519-201-0609	SWITCH, SLIDE	SSBO23N (Deemphasis)	ALL
CF 201, 202, 203	4529-309-0103	FILTER, CERAMIC	SFE 10.7 MA8	ALL

*Used in early production, and shown on exploded view.

**Used in later production, see insert.

***Replacement part may be marked 2539-403-0204.

CAPACITORS (SPECIAL OR CRITICAL COMPONENTS)

SYMBOL	PART NO.	DESCRIPTION	SPECIFICATION	USED IN
C515	1469-502-0706	CAP-CERAMIC AC	125 VAC 0.0047	ALL Δ
C120	1509-452-1001	CAP-POLYSTYRENE	CQ09S 50V 330-J	ALL
C302	1509-452-1108	CAP-POLYSTYRENE	CQ09S 50V 510-J	
C311, C361				
C511, C512	1619-018-2701	CAP-ELECTROLYTIC	50V 8200M PCB	355R Δ
C511, C512	1619-018-3201	CAP-ELECTROLYTIC	63V 10000M PCB	375R, 385R Δ
C416, C417, C418	1609-802-9908	CAP-ELECTROLYTIC NP	CEO4W 100V 0.047M	ALL Δ
C466, C467, C468				
C315, C365	1509-452-1700	CAP POLYSTYRENE	CQ09S 50V 1100-J	ALL
C314, C364	1509-452-1302	CAP POLYSTYRENE	CQ09S 50V 560-J	
C1	1809-400-0101	VARICON	C774J	ALL
C27	1829-511-0104	C TRIMMER	ECV-12 W06 \times 32E	ALL

POWER/FREQUENCY DISPLAY CIRCUIT COMPONENTS

SYMBOL/ EXP. VIEW NO.	PART NO.	DESCRIPTION	SPECIFICATION	USED IN
FL801	2319-101-0302	FLUORESCENT TUBE	B6-32	355R
FL801/147	2319-101-0409	FLUORESCENT TUBE	B6-60	375R
FL701/147	2319-101-0506	FLUORESCENT TUBE	FIP12AW12YS	385R,
IC806	2119-201-1300	INTEGRATED CIRCUIT	LC7555	355R, 375R
IC702	2119-201-2303	INTEGRATED CIRCUIT	LC7556	385R
IC701	2119-101-4500	INTEGRATED CIRCUIT	TA7318P	385R
Q701, Q751	2139-302-7409	TRANSISTOR	KSC945Y	385R
Q702, Q703, Q704	2139-103-3802	TRANSISTOR	KSA733Y	385R
CR701-714, CR751	2169-301-2901	DIODE	1SS53	385R,
CR821	2169-301-2901	DIODE	1SS53	355R, 375R
R886	1249-102-0704	VR-SEMI	SR19R B100K	375R
C831	1509-121-2702	CAP-POLYESTER	M50V 0.12M-J	375R
CR820	2309-117-0102	LED METER	LN 05202P	355R
CR827, CR828, CR829	2169-301-2901	DIODE	1SS53	355R, 375R

TROUBLESHOOTING GUIDE

PROBLEM	POSSIBLE CAUSE	CORRECTION
<p>FM distortion.</p> <p>Severe frequency jumping, or drift.</p> <p>Oscillation at all levels, all inputs.</p> <p>Display does not light up.</p>	<p>Low B+ supply to FM IF.</p> <p>Defective FM OSC trimmer.</p> <p>12V Reg. transistor Q501 oscillates at VHF band.</p> <p>Check for broken wire or PCB track to FIP or IC.</p>	<p>Verify that Q501 is KSD 288 Y (See parts list).</p> <p>Replace trimmer cap C-27.</p> <p>Increase value of C-509 from 0.001 to 0.047 ceramic disc.</p> <p>Repair as indicated.</p>
<p>—NOTE—</p>		
<p>To verify that FIP is or is not defective a new FIP may be connected directly across the part in question with sufficient terminals connected to energize the filament B+ and one or more display elements.</p>		
<p>Protection circuit remains activated. (Protection LED ON).</p>	<p>1) Check output bias and offset both channels. Units with temp sensor on transformer and all 385R, check for proper setting.</p>	<p>1) Adjust per test procedure</p>
<p>Protection circuit remains activated. (Protection LED ON).</p>	<p>2) A number of production units have been found with a 10 ohm resistor replacing R1417, R1418, R1467 or R1468 causing severe offset.</p>	<p>2) Replace this critical part with factory specified replacement-Adj. bias.</p>
<p>Occasional fuzzy sound at low level output.</p>	<p>Oxidized relay contacts.</p>	<p>Verify by shorting across contacts on PCB, clean contacts with strip of clean white paper pulled through contacts under pressure or replace relay.</p>
<p>Display frequency stays at 87.5 or very slow AM to FM.</p>	<p>Incorrect setting of regulated supply—IC 801.</p>	<p>Adjust R803 for 7.5-8.0V at Pin 13 of IC801.</p>
<p>Poor FM sensitivity, does not switch to stereo.</p>	<p>Defective ceramic filter.</p>	<p>Replace filter with same color code.</p>
<p>Thump in speakers when switching through input functions. Noisy tone/volume controls.</p>	<p>Excessive DC offset in IC or leaky coupling/feedback capacitors.</p>	<p>Troubleshoot and replace parts as indicated.</p>
<p>355R FM tuning indicator (green pointer LEDS) not operating.</p>	<p>FM detector alignment or defect. Defective component in circuit Q802-Q810 or IC804.</p>	<p>Troubleshoot and replace parts as indicated.</p>
<p>Excessive high frequencies in phono mode.</p>	<p>Incorrect equalization or improper cartridge loading.</p>	<p>Check response to R1AA spec. Provide additional cartridge loading 100-300 pF.</p>
<p>Output section oscillates under certain speaker load conditions.</p>	<p>Reactive loads causing circuit instability.</p>	<p>Increase value of C 1417 and C1467 from 2 pF to 5pF.</p>

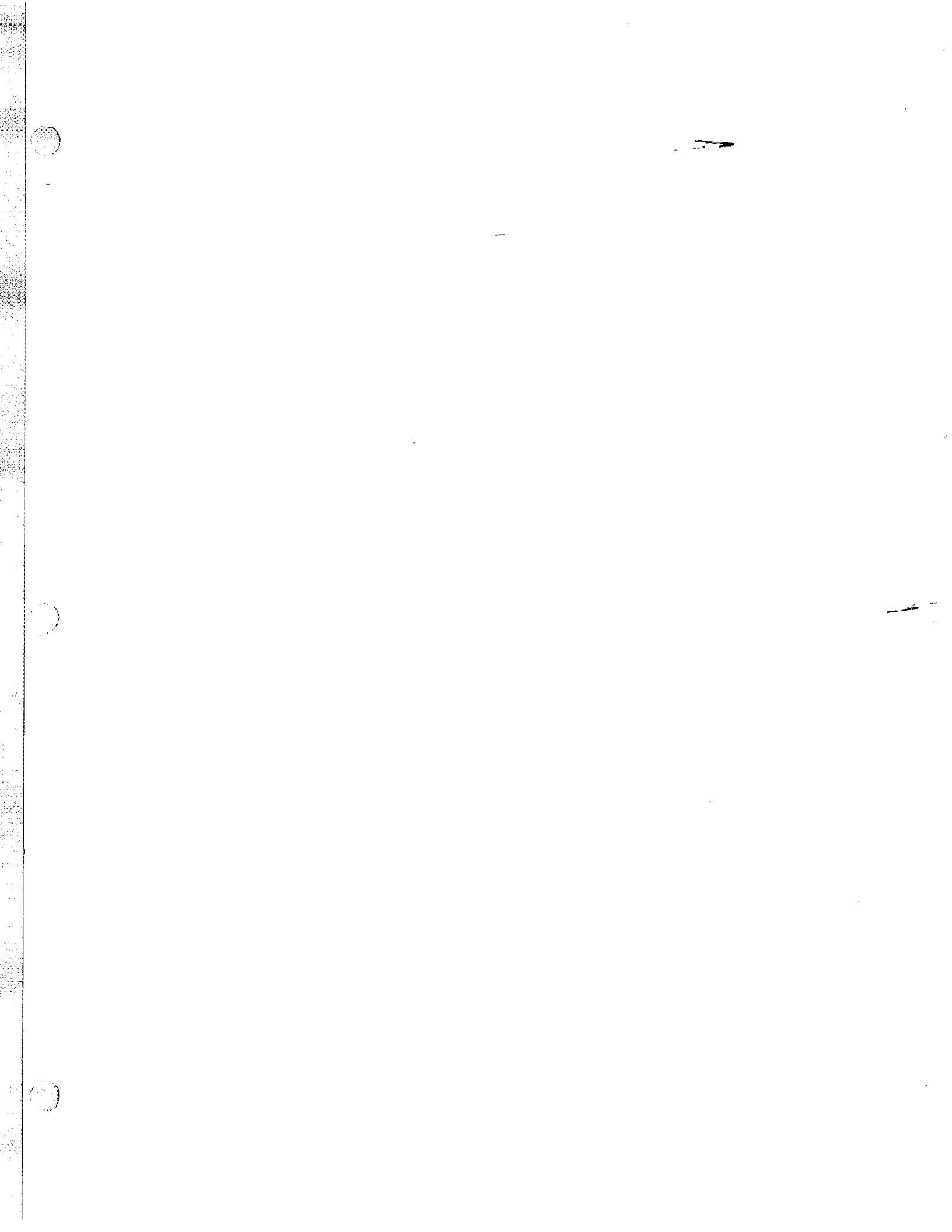

 **SCOTT.**
The Name to listen to.

U.S.A. CORPORATE HEADQUARTERS

H. H. SCOTT INC.

20 Commerce Way

Woburn, MASS. 01801

tel.: 617-933-8800
