

22

ARCHIVE COPY
DO NOT REMOVE

Service Manual AM/FM Stereo Receivers

355R

375R

385R

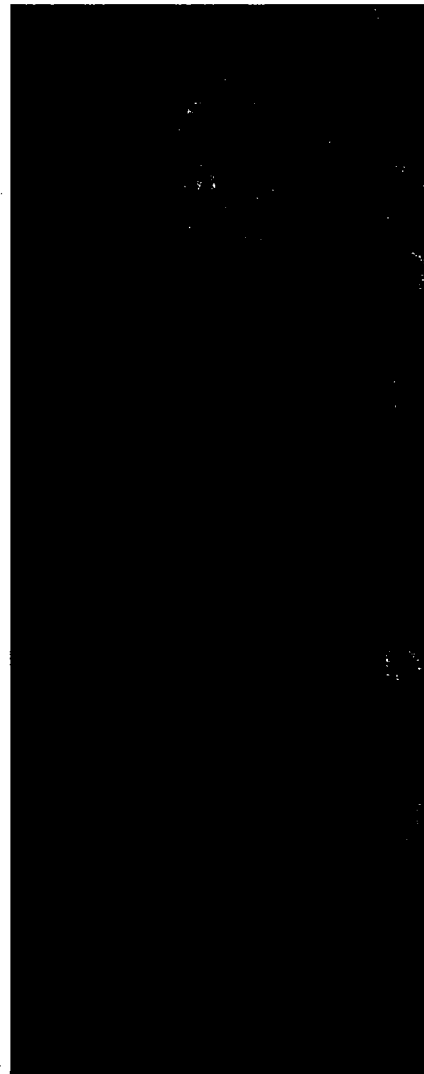

 **SCOTT**[®]
The Name to listen to.

H. H. SCOTT, INC., 20 Commerce Way, Woburn, Mass. 01888 Tel. (617) 933-8800

CONTENTS

PAGE

1. Specifications and revision information.
3. Circuit description, tuner section.
4. Circuit description, tuning indicators.
6. Circuit description, audio amplifier.
7. Circuit description, protection and power meters.
8. Circuit description, temperature sensors.
8. Test procedures.
11. Fluorescent indicator panel lead codes.
14. Parts location diagrams.
17. Circuit diagrams.
20. Exploded view and Notes.
21. Parts list.
32. Troubleshooting guide.

CAUTION NOTICE

The following safety precautions must be followed to assure continued reliability and safety against fire and shock hazard:

1. Replacement parts used during servicing of this appliance must have identical characteristics as those offered and recommended by H. H. Scott, Inc. In the interest of continued product safety we refer in particular to those safety critical components shown on the Replacement Parts List identified by the IEC Symbol "△".
2. A dielectric test is to be performed on each appliance following the re-assembly and before returning the unit to the customer.
3. The dielectric test to be performed on H. H. Scott, Inc. electric components serviced in the United States and Canada for use in these countries shall consist of not less than the following:*
 - 1) A dielectric tester designed to have an output voltage that (1) has a sinusoidal wave form, (2) has a frequency that is within the range of 40-70 Hz, and (3) has a peak value of the waveform that is not less than 1.3 and not more than 1.5 times the root-mean-square value.
 - 1a) The sensitivity of the test equipment shall be such that when a 120,000-ohm resistor is connected across the output, the test equipment does not indicate unacceptable performance for any output voltage less than the specified test voltage, and does indicate unacceptable performance for any output voltage equal to or greater than the specified test voltage. The calibrating resistor is to be adjusted as close to 120,000 ohms as instrumentation accuracy can provide, but not more than 120,000 ohms.
 - 2) The tester is to be connected per the instructions enclosed with the instrument, or as follows:
 - a. The tester is connected to the power line receptacle and the power switch is turned on.
 - b. Sufficient time is allowed for the tester supply to stabilize and then the output voltage is adjusted for 1080 V.
 - c. Leads of the tester, usually marked GND and HV, are connected between chassis ground and both blades of the male plug of the power cord.
 - d. Switch tester to "test" and observe leakage indicator.

*Dielectric tests made by service personnel in countries other than USA and Canada must use test equipment and procedures specified by the safety agency serving that country.

COPYRIGHT H.H. SCOTT ELECTRONICS®

Printed in U.S.A. 11/82 029-1175-049

H.H. SCOTT ELECTRONICS®, Scottkit® and Scotsman™ are registered trademarks of H.H. SCOTT, Inc.

22

ARCHIVE COPY
DO NOT REMOVE

Service Manual AM/FM Stereo Receivers

355R

375R

385R

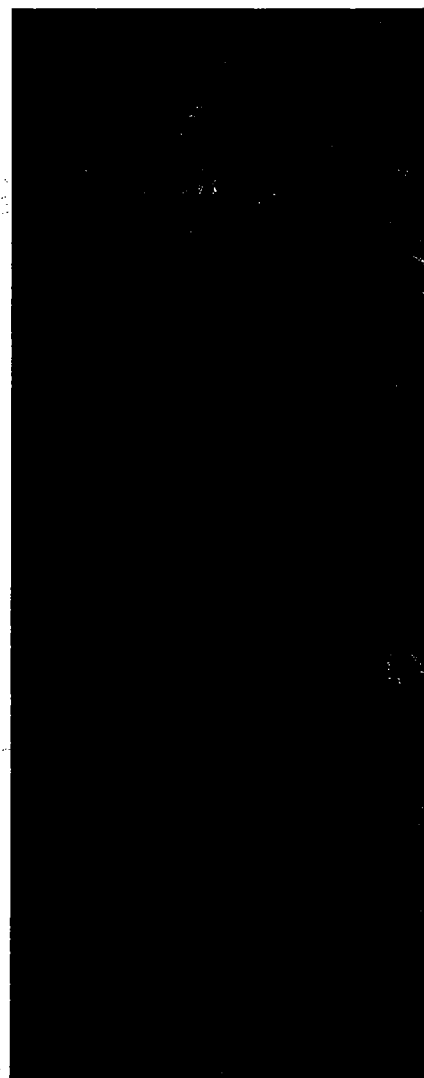

 **SCOTT**[®]
The Name to listen to.

H. H. SCOTT, INC., 20 Commerce Way, Woburn, Mass. 01888 Tel. (617) 933-8800

CONTENTS

PAGE

1. Specifications and revision information.
3. Circuit description, tuner section.
4. Circuit description, tuning indicators.
6. Circuit description, audio amplifier.
7. Circuit description, protection and power meters.
8. Circuit description, temperature sensors.
8. Test procedures.
11. Fluorescent indicator panel lead codes.
14. Parts location diagrams.
17. Circuit diagrams.
20. Exploded view and Notes.
21. Parts list.
32. Troubleshooting guide.

CAUTION NOTICE

The following safety precautions must be followed to assure continued reliability and safety against fire and shock hazard:

1. Replacement parts used during servicing of this appliance must have identical characteristics as those offered and recommended by H. H. Scott, Inc. In the interest of continued product safety we refer in particular to those safety critical components shown on the Replacement Parts List identified by the IEC Symbol "△".
2. A dielectric test is to be performed on each appliance following the re-assembly and before returning the unit to the customer.
3. The dielectric test to be performed on H. H. Scott, Inc. electric components serviced in the United States and Canada for use in these countries shall consist of not less than the following:*
 - 1) A dielectric tester designed to have an output voltage that (1) has a sinusoidal wave form, (2) has a frequency that is within the range of 40-70 Hz, and (3) has a peak value of the waveform that is not less than 1.3 and not more than 1.5 times the root-mean-square value.
 - 1a) The sensitivity of the test equipment shall be such that when a 120,000-ohm resistor is connected across the output, the test equipment does not indicate unacceptable performance for any output voltage less than the specified test voltage, and does indicate unacceptable performance for any output voltage equal to or greater than the specified test voltage. The calibrating resistor is to be adjusted as close to 120,000 ohms as instrumentation accuracy can provide, but not more than 120,000 ohms.
 - 2) The tester is to be connected per the instructions enclosed with the instrument, or as follows:
 - a. The tester is connected to the power line receptacle and the power switch is turned on.
 - b. Sufficient time is allowed for the tester supply to stabilize and then the output voltage is adjusted for 1080 V.
 - c. Leads of the tester, usually marked GND and HV, are connected between chassis ground and both blades of the male plug of the power cord.
 - d. Switch tester to "test" and observe leakage indicator.

*Dielectric tests made by service personnel in countries other than USA and Canada must use test equipment and procedures specified by the safety agency serving that country.

COPYRIGHT H.H. SCOTT ELECTRONICS®

Printed in U.S.A. 11/82 029-1175-049

H.H. SCOTT ELECTRONICS®, Scottkit® and Scotsman® are registered trademarks of H.H. SCOTT, Inc.

SPECIFICATIONS

| AMPLIFIER SECTION | 355R | 375R | 385R |
|---|--|--|--|
| Minimum Continuous RMS Output power perchannel both channels driven into 8 ohms from 20 Hz to 20 kHz With no more than rated T.H.D. | 45 W | 65 W | 85 W |
| Total Harmonic Distortion at rated output | 0.05% | 0.04% | 0.03% |
| Total Harmonic Distortion at 10 Watt from 20 Hz to 20 kHz | 0.04% | 0.03% | 0.03% |
| Intermodulation Distortion at rated output power; 60;7000 Hz;4:1 | 0.04% | 0.03% | 0.03% |
| Signal to Noise Ratio, shortened input, IHF-A network: Phono (10mV, RIAA 1 kHz): Others | 81 dB 100 dB | 84 dB 100 dB | 84 dB 100 dB |
| Input Sensitivity Phono MM Phono MC Others | 2.5 mV 150 mV | 2.5 mV 0.25 mV 150 mV | 2.5 mV 0.25 mV 150 mV |
| Phono Overload | 200 mV | M.M: 220 mV M.C: 20 mV | M.M: 220 mV M.C: 20 mV |
| Damping Factor, 1 kHz, 8 Ohm more than | 50 | 60 | 60 |
| Channel separation at 1 kHz PHONO at 1 kHz OTHERS | 55 dB 65 dB | 55 dB 65 dB | 55 dB 65 dB |
| Frequency Response at 1 Watt output Phono RIAA 20 Hz—20 kHz: Others 20 Hz—20 kHz: | ± 0.5 dB ± 1 dB | ± 0.5 dB ± 0.8 dB | ± 0.5 dB ± 0.8 dB |
| Filters subsonic 6 dB/octave, -3 dB Hi Filter 6 dB/octave, -3 dB | Phono 18 Hz 30 dB/oct 7 kHz 12 dB/oct Others 18 Hz 18 dB/oct | Phono 18 Hz 30 dB/oct 7 kHz 12 dB/oct Others 18 Hz 18 dB/oct | Phono 18 Hz 30 dB/oct 7 kHz 12 dB/oct Others 18 Hz 18 dB/oct |
| Tone Control Range Base at 100 Hz Treble at 10 kHz Mid: at 1 kHz | ± 10 dB ± 10 dB ± 6 dB | ± 10 dB ± 10 dB ± 6 dB | ± 10 dB ± 10 dB ± 6dB |
| Loudness Contour Volume control set to -30 dB at 10 kHz at 100 Hz | + 3.5 dB at 10 kHz + 7 dB at 100 Hz | + 3.5 dB at 10 kHz + 7 dB at 100 Hz | + 3.5 dB at 10 kHz + 7 dB at 100 Hz |
| GENERAL | | | |
| Power requirement: (Refer to rear panel for specified voltage and frequency before making any connections.) | 120V AC; 60 Hz | 120 V AC: 60 Hz | 120 V AC: 60 Hz |
| Power Consumption | 280 W | 370 W | 480 W |
| Dimensions (W/H/D) | 5"/20"/13", 125mm/500mm/330mm | 5"/20"/13", 125mm/500mm/330mm | 5"/20"/13", 125mm/500mm/330mm |
| Net Weight | 25¼ lbs. 11.5 Kgs. | 28 lbs. 12.7 kgs. | 30 lbs. 13.0 kgs. |

SPECIFICATIONS

| FM SECTION | 355R | 375R | 385R |
|--|---|---|---|
| Tuning Range | 87.5 to 108.5 MHz | 87.5 to 108.5 MHz | 87.5 to 108.5 MHz |
| IHF sensitivity | 10.8 dBf/1.9uV | 10.3 dBf/1.8 uV | 10.3 dBf/1.8 uV |
| 50 dB quieting sensitivity | Mono: 16.7 dBf/3.8 uV Stereo: 37 dBf/39 uV | Mono: 16.5 dBf/3.6 uV Stereo: 37 dBf/39 uV | Mono: 16.5 dBf/3.6 uV Stereo: 37 dBf/39 uV |
| S/N ratio at 65 dBf | Mono: 72 dB Stereo: 67 dB | Mono: 76 dB Stereo: 70 dB | Mono: 76 dB Stereo: 70 dB |
| Distortion at 65 dBf | Mono: 0.15% Stereo: 0.25% | Mono: 0.1% Stereo: 0.2% | Mono: 0.1% Stereo: 0.2% |
| Frequency response + 1dB/ - 2dB | 20 Hz—15 kHz | 20 Hz—15 kHz | 20 Hz—15 kHz |
| Capture ratio | 1.2 dB | 1.2 dB | 1.2 dB |
| Alternate channel selectivity | 60 dB | 60 dB | 60 dB |
| Image rejection | 75 dB | 80 dB | 80 dB |
| Stereo separation at 1 kHz | 45 dB | 50 dB | 50 dB |
| Spurious response rejection | 78 dB | 78 dB | 78 dB |
| Subcarrier rejection | 55 dB | 60 dB | 60 dB |
| IF rejection (98 MHz) | 90 dB | 90 dB | 90 dB |
| AM SECTION | 355R | 375R | 385R |
| Tuning Range | 515 to 1640 kHz | 515 to 1640 kHz | 515 to 1640 kHz |
| Usable sensitivity (bar ant.) | 250 uV/m | 250 uV/m | 250 uV/m |
| S/N ratio | 50 dB | 54 dB | 54 dB |
| Selectivity (1MHz) | 45 dB | 45 dB | 45 dB |
| Image rejection | 50 dB | 50 dB | 50 dB |

REVISIONS MADE DURING PRODUCTION

355R, 375R

- 1) R203 (FM IF CKT) deleted in certain production units to improve stereo separation.
- 2) R 502 (Pwr. Supply) changed from 1.0K to 220 ohms.
- 3) Pwr. transformer secondary voltage increased to provide better regulation and to accommodate additional voltage drop by added 4.7ohm resistor (R510).
- 4) CR511 changed from 1Z14 to 1Z15 to provide higher supply to tuner section.
- 5) C218 increased from 1/50 to 10/15 to reduce transient when unit switches in and out of MUTE.
- 6) Q601 changed from KSA733Y to KSA708Y to improve reliability.
- 7) C602 changed from 4.7/50 to 4.7/160 to improve reliability.
- 8) CR602 deleted.
- 9) Q501 changed from KSD 288-0 to KSD 288-Y to reduce voltage drop.
- 10) R602 changed from 10K to 2.2K.
- 11) C513 changed from 220mF to 1000mF to reduce protection circuit triggering with tone controls set at boost.

CIRCUIT DESCRIPTION

—Tuner

FM Front End

The input section is designed using a balun coil that provides input matching for both 75 and 300 ohm transmission lines. The tuner section uses a MOSFET RF amplifier (Q1), transformer coupled to a bipolar mixer (Q2) for conversion. The local oscillator (Q3) is capacitively coupled to the base of Q2 where through the heterodyne process a 10.7 MHz signal is produced for IF amplification.

FM IF Amplifier & Quadrature Detector (IC201)

Output of the FM front end is transformer coupled to the IF amplifier circuit, composed of the 10.7 MHz transformer (T201), a transistor stage (Q201), 3 dual element ceramic filters (CF201, 202, and 203) and one integrated circuit (IC201). This integrated circuit contains the limiter amplifiers, quadrature detector, AGC amplifier, mute circuits, A.F.C. circuit and audio amplifier. Within the IC, limiter output is fed directly to one quadrature input. This signal is also connected to pin 8 where it is phase shifted by external coil L201 and reapplied to the other quadrature input at pin 9.

Two audio signals, opposite in phase, are obtained from the quadrature detector. Output of the first amplifier (pin 7) is at a DC level which varies with detuning and is used to provide the DC level shift necessary to operate the center tuning circuits. Output from the second amplifier (pin 6) is the composite audio signal which is coupled directly to the multiplex IC. The composite signal is internally muted in IC201 whenever a positive voltage is applied to pin 5. Drive for muting supplied from pin 12 provides a positive voltage when input to the IC is reduced to a low level.

Block Diagram of HA1137 (IC201)

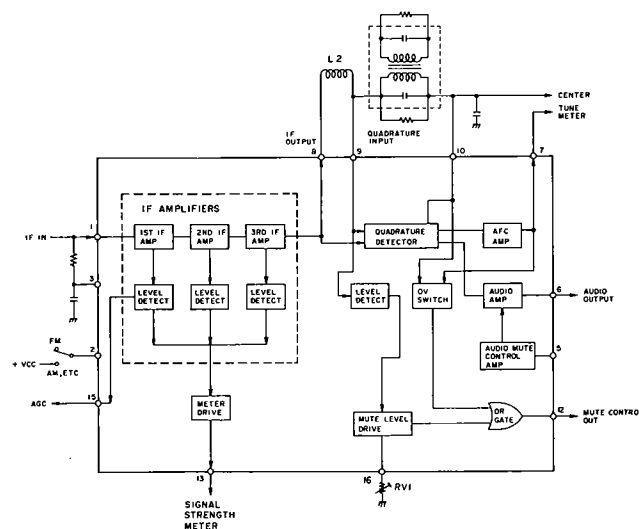

Multiplex Decoder HA1196 (IC301)

The multiplex decoder IC is functionally divided into 2 sections: the phase locked loop (PLL) signal generator and the stereo demodulator. The PLL consists of a 76 kHz voltage controlled oscillator (VCO) followed by two frequency dividers, producing 38 kHz and 19 kHz. The phase of this signal is compared with the phase of the incoming pilot signal and a difference signal is created which corrects the VCO and synchronizes the VCO signal to the pilot signal. Since higher order harmonics are contained in the phase difference signal, a low pass filter is used to eliminate these harmonics. A second phase comparator is used to sense when the PLL is locked to a pilot signal. The output of this comparator triggers the stereo indicator and connects the 38 kHz switching signal to the demodulator.

The demodulator circuit consists of two differential amplifiers operating in a switching mode controlled by the phase locked 38 kHz signal which demodulates the composite incoming signal into left and right outputs. These signals at pins 4 and 5 are coupled to external amplifiers Q302 and 352 which drive the left and right channel low pass filters.

A means of switching deemphasis of the FM audio signal has been incorporated in these models utilizing the external Post AMP FEEDBACK connections of the Multiplex decoder IC.

Block Diagram of HA1196 Multiplex Decoder

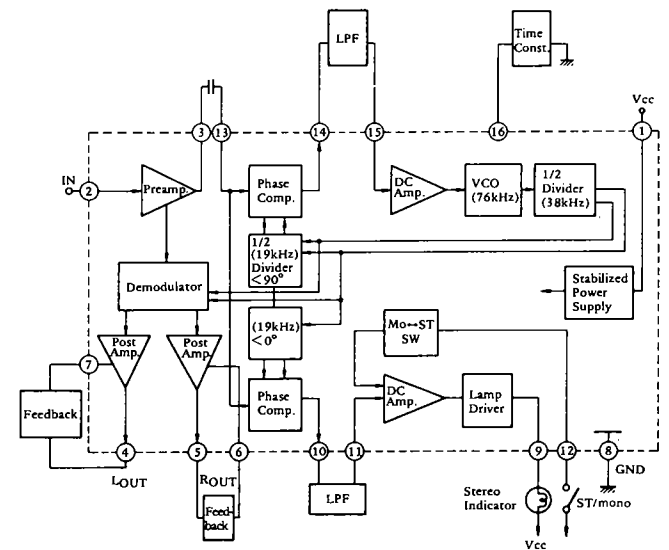

AM Tuner Section

The AM incoming signal received at the AM antenna enters the RF section of IC101 and is amplified and coupled to the converter stage. Here the signal is changed to the universal 455 kHz intermediate frequency.

The local oscillator, operating 455 kHz above the incoming tuned signal, is achieved in the converter block in the IC with externally connected L102.

The 455 kHz signal is coupled through two stages of IF amplification, and to the detector. The detector output then appears as audio information at pin 12. This signal is then conducted through the low pass filter to further remove the 455 kHz component.

Block Diagram of HA1197 AM Tuner (IC101)

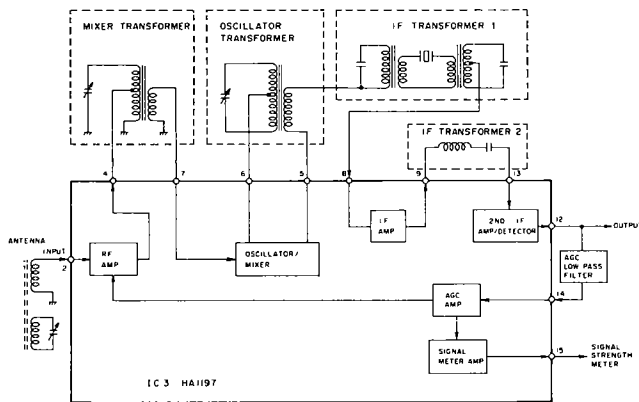

Drive for the signal strength indicator is provided at pin 15, this positive AGC voltage is coupled directly to the input (pin 8) of IC805.

Signal Strength Indicator (IC805)

The signal strength indicator is driven by the single inline package BA6104. This digital IC is designed using five comparators to drive the external display. It operates with an increasing DC voltage level applied to the input at pin 8.

In the 355R this IC is used to directly energize the LED display segments, in the 375R and 385R this same circuit is used to operate the signal strength segments of the fluorescent display tube.

The meter drive IC derives its inputs from pin 13 of IC 201 for FM and from pin 15 of IC 101 for AM. Sensitivity is set by control R835 while R214 provides adjustment for FM signal strength.

FM Tuning Frequency Display Circuit 375R, 385R

Frequencies generated by the FM local oscillator are coupled through a small value capacitor (C24) to the gate of FET Q4. Q4 is used for isolation and gain to trigger IC802. IC802 is a divide by 100 prescaler that divides the 110 MHz local oscillator frequency down to 1.1 MHz, the square wave out-

put is then applied through C811 to the input of IC 803, IC803 is a C-MOS LSI circuit designed to operate frequency indicators with up to five digits.

A four MHz crystal is mounted externally and wired to pins 19 and 20 of the IC.

This crystal is used as a reference for the clock which controls the gates within the IC.

Switching of the display frequency to FM is accomplished by applying FM B+ through regulator transistor Q801 to IC802 and by applying the FM B+ through a voltage divider R811 and R812 to pins 8 and 12 of IC803. FM B+ is also used to bias the series diode connected in series with the AM oscillator signal lead to pin 6 of IC 803. With this plus voltage applied to the diode cathode any signal that might appear on this conductor in the FM mode will not be conducted to IC803.

AM Tuning Frequency Display Circuit

Frequencies generated by the AM local oscillator within IC101 are coupled from pin 6 to the base of Q101, output of this emitter follower, is applied through a series diode directly to the input of IC803.

Switching of the display reading from FM to AM is accomplished by switching the FM local oscillator OFF and by removing FM B+ from IC802, pins 8 and 12 of IC803 as well as the bias voltage applied to the series diode used to conduct AM local oscillator signal to pin 6 of IC803.

Center Tune/Lock Circuit (Refer to Circuit Diagram)

The models 355R, 375R and 385R incorporate circuitry to both indicate proper FM tuning as well as to electronically correct a tuning error of up to ± 50 kHz caused by operator mistuning.

Center Tune

Center Tuning circuitry is composed of a dual op amp (IC804) with transistors Q802, 803, 804, 805 and 808 to operate the center tune indicator. When operating normally A.G.C. and mute voltages are applied to control transistors Q806, Q809 and Q810 which in turn determine when the center tune indicators will be turned on.

IC804 derives its control signals from pins 7 and 10 of the FM detector, IC201.

When the receiver is perfectly tuned the voltage across these two terminals will be zero, however as the receiver is tuned above the station carrier frequency the voltage as measured on pin 7 of IC201 will become lower with respect to pin 10. These pins of the detector IC are connected through isolation resistors to IC804.

IC804 serves two functions, first to invert the DC level applied to pin 2, secondly to stabilize the DC level at pin 7 which

is used as a reference voltage for Q802 and Q803 as well as for Q814 and Q816 in the lock circuit.

With the reference voltage applied to Q802 and Q803 **the output at pin 1 will now deviate plus as the receiver is tuned above the carrier frequency and minus when tuned below.**

When tuned high the positive voltage will cause Q802 to conduct and Q803 to be cut-off, with Q803 cut-off, Q804 will conduct and apply a positive voltage to the HIGH indicator. Conversely, tuning low will cut-off Q802 causing Q805 to conduct causing the LOW indicator to be illuminated. When either Q804 or Q805 is conducting the positive voltage at their emitter terminal will be applied to the base of Q808 thus causing this transistor to conduct thereby shunting the supply voltage through R827 to the center tune indicator.

Control Circuits

Operation of the CENTER TUNE circuits is dependant on proper alignment of the FM section and on the signal levels applied to the control transistors.

The CENTER TUNE circuit is also inhibited from operating at low input signal levels and from OFF station operation until a positive voltage is applied to the base of Q810, this will be accomplished:

- a) when center tune voltage on 845 approaches zero, causing Q809 to cut off.
- b) when voltage on pin 1 of IC 805 goes positive.

When Q810 conducts the base of Q806 will go low causing this PNP to conduct applying a positive voltage to diodes CR815 and CR816, without this positive voltage applied to the cathode of these diodes, the diodes act as a shunt to the DC level changes which operate the tuning indicators.

Lock Circuit

The lock circuitry, comprised of Q811, 812, 813, 814, 815 and 816 is described as follows:

When tuning of the receiver approaches an FM carrier the Plus Voltage at board terminal 845 will be reduced and finally reach zero on station.

When the voltage at the base of Q811 is reduced to below 0.6 volts the transistor will cut-off and the collector voltage will go to supply level. In this design, an intentional delay created by the R-C time constant of C824 and R838 has been incorporated.

When C824 is sufficiently charged Q812 will conduct pulling the collector down so that collector of Q813 will go high thus turning on the lock indicator (CR801).

When the lock indicator is OFF Q816 is fully conducting.

This condition sets a **fixed bias** on CR1 which is a back biased varactor diode on the FM local oscillator section. The characteristic of this circuit is that the capacitance of the diode is directly proportional to the reverse DC voltage across it. Thus the diode with a fixed DC voltage contributes nothing to the tuning, acting only as a fixed capacitor. However, when the lock circuit is enabled and the indicator is turned on the collector/base voltage through R850 to Q816 will be shunted by Q815 thus turning Q816 OFF and permitting the DC level change at the collector of Q814 to be applied to the varactor diode (CR1). The D.C. level applied to the base of Q814 is derived from pin 1 of IC804 where, as indicated above, will become increasingly positive with respect to pin 7, when the receiver is tuned above the carrier, with this more positive voltage applied to the base of Q814, the result will be a lower voltage across the varactor diode.

With a lower voltage the diode capacitance is increased until the carrier is center tuned, conversly, if the receiver is tuned below the carrier, a higher voltage will be applied to the diode with a resulting reduction in capacitance which will tune the receiver to the carrier.

Voltage change to the varactor is slow as determined by the R/C time constant of R849 on the display board and C220 on the tuner board.

The entire lock circuit is disabled by SW 7-2 when the LOCK/MUTE button is out.

CIRCUIT DESCRIPTION

—Audio

Phono Preamplifier

These models use two separate operational amplifiers (IC901, 951) in a negative feedback configuration which provides the designer with means of gain adjustment and equalization.

Gain adjustment is fixed by resistors R914 and R915 while capacitors C910 and C911 provide the proper equalization to conform to the RIAA standard curve for recorded disc reproduction.

The circuit is powered by split supplies at a DC level suitable to provide the 200 mV overload capability at 1.0 kHz.

Tone Control

The tone control circuits (IC 401, 451) use of the high gain and low noise characteristics of the TA7322.

The tone control is a negative feedback type utilizing inverting Pin No. 3 for control.

Bass Control (R412)

As the frequency applied to the input of the IC decreases, the impedance of C411 increases thus reducing the signal applied to the treble control. Therefore at low frequencies the gain is mainly determined by the position of the bass control (R412L). Rotating the bass control toward C407 will boost the low frequencies by attenuating the feedback information below 1000Hz. Rotating the control toward C406 will attenuate low frequencies by reducing the circuit impedance thereby increasing feedback below 1000Hz.

Treble Control (R414)

As the frequency applied to the input increases the bass control will be shorted by C406 and C407 and the control will have no effect. However the impedance of C408 will decrease so that control R414L becomes the main feedback control. Rotating R414L toward R413 will increase feedback thus attenuating high frequencies. Rotating R414L toward R415 will reduce feedback and boost high frequencies.

Midrange Control (R419)

At 1 kHz the bass and treble controls have little effect on the gain because of the impedance of capacitors C406, C407, C409 and C410. Thus at midrange frequencies R419L will control the gain of the tone control circuit.

Power Amplifier

The power amplifier design used in these models is a fully complementary design using a differential input amplifier composed of a matched transistor pair in a single package thus providing optimum common mode rejection and low DC offset.

With reference to one of the circuit diagrams, the first transistor (Q1401) provides the excellent common mode rejection and low DC offset.

Q1404 and Q1405 are used as voltage amplifiers to provide adequate signal level to driver transistors Q1406 and Q1407. Current gain is provided by the darlington connected driver/output circuit where Q1407 and Q1409 conduct for the negative swing and Q1406 and Q1408 conduct for the positive swing.

The output stage bias is set by the triple diode CR1401 and potentiometer R1412.

The amplifier is controlled by multiple feedback networks. DC feedback is provided through R1410 while R1411 and C1404 set the DC gain.

AC gain is determined by the ratio of R427 and R428.

Power Supply

The power supply in these models consists of a thermally protected power transformer with three separate secondary windings.

The first winding provides approximately 15.5-0-15.5 VAC which is rectified and regulated to provide the 12V DC supply for the tuner and part of the indicator circuits. Note: In later production the 15.5 VAC was increased to 18.0 VAC and zener changed to provide approx. 14V DC.

The second winding supplies approximately 82 VAC (385R) 72 VAC (375R) and 62 VAC (355R). This secondary voltage is rectified and filtered to provide a DC supply for the driver/output circuits, it is also regulated and further filtered for use in low level audio circuits.

The third winding, supplying approximately 5 VAC is used to provide filament current for the fluorescent displays.

TURN-ON DELAY/ PROTECTION CIRCUIT

This circuit is mounted on PCB #3014-523-010 and consists of six transistors, one relay and an assortment of coils, resistors, diodes and capacitors. **Q607 and Q657 are located on the Main Amplifier PC Board** and are actually connected to this board via terminals **1408** and **603**.

Delay

Audio Power to the speakers and headphones is delayed until relay contacts **K601** and **K651** are closed.

When power is switched ON, AC will be applied from the high voltage secondary to terminal **601** where it is rectified by **CR601**, filtered and applied to the base of **Q603**, at this time supply voltages to all circuits has been established and the voltage on the base of PNP **Q602** has been reduced thus causing this device to conduct and to energize the relay coil thus closing the relay contacts.

Since the SAFETY INDICATOR is connected between supply and the relay coil this LED will be switched off when voltage to the coil is raised to near supply voltage.

Protection

Circuitry used to sense offset and overload on the output circuit is composed of **Q606**, **607** and **Q657**.

Under normal operating conditions, these devices are not conducting therefore the collector of each remains at approximately the + supply voltage.

In operation, whenever any one of the above transistors sense an overload or offset condition in the output circuit either from internal or external causes one or more of the transistors will conduct which in turn applies a more negative voltage to base of **Q601**, when **Q601** conducts the voltage on the base of **Q604** increases and causes **Q604** to conduct which in turn causes **Q605** to conduct thus short circuiting the positive voltage applied to base of **Q603**. This voltage is short circuited through **Q605** and **R604** to ground. Thus **Q603** is cutoff and **Q602** will not conduct to energize the relay.

Output Power Meter—355R-375R

(Although typical of both channels, reference is made only to left channel components)

The output power indicator circuit is comprised of **Q817**, **Q818**, **IC806** and the fluorescent display tube, **FL801**.

Since **IC806** requires a linear input, conversion of the audio information from logarithmic to linear is performed

by the diode/resistor network **CR805**, **806**, **807**, **808** and resistors **R854**, **855**.

Amplified output of **Q817** is AC coupled to a germanium diode and to the base of **Q818**. Since **IC806** also requires a DC input the output of **Q818** is DC coupled through an adjustment potentiometer and applied to the input of **IC806**.

IC806 is a C MOS LSI circuit which performs the analog to digital conversion and peak holding function for both channels. **IC806** is directly connected to the fluorescent display tube and as DC level on the input of **IC806** increases the gates at the output progressively turn on, thereby applying the supply voltage to the appropriate input of the display tube.

Output Power Meter—385R

The FL tube is driven by a MOS LSI (**IC702**) which performs the analogue to digital conversion and the peak holding for both channels. Since the input response of this IC is linear, a LOG signal conversion is required. This AC to DC conversion and LOG compression is performed by Diodes **CR701**, **751** and **IC701**.

Since this IC is a current activated device, its input voltage sensitivity is determined by a series resistor to the inputs.

The auto-ranging circuit changes the sensitivity of the circuit by turning ON or OFF transistors **Q-701** and **Q-751**.

The FLIP-FLOP (**Q-702**, **Q-703**) drives the input attenuator transistors and lights the corresponding decimal points on the display.

Need for change over, from low to high range is detected by diodes **CR-711** and **CR-710** which are connected to the last segments (most significant) of both channel displays, as long as the 2 least significant segments are lit, the range will remain in the high one. However if these segments turn off (underrange condition) for more than 3 seconds (determined by **R-717** and **C-709**) the FLIP-FLOP will switch to the low range by **Q-705** triggering the transition.

These segments are monitored by diodes (**CR-709** and **C-708**) which keep **Q-705** in CUT OFF if these segments are lit.

Transistor **Q-706** serves as system voltage regulator, utilizing the 8.2V internal reference of the LOG converter (**IC701**).

NOTE: Printed circuit board no. 3014-530-9606 is added in some production units to increase brightness of dots.

TEMPERATURE SENSORS

Power Transformer Sensor

During production of these models certain production lots were fitted with a sensor attached to the power transformer designed to activate the protection circuitry if the power transformer temperature exceeded a predetermined level such as may occur under abnormal operating conditions.

If the receiver is made inoperable by the thermal sensor action the transformer must be allowed to cool before normal operation is resumed.

Circuit Theory

The subassembly voltage is supplied from a regulated source on the fluorescent display PCB as well as the positive voltage at term 603 of the protection board.

The regulated voltage applied to the first transistor, is used also to forward bias the triple diode and to provide a stable voltage on which to set the threshold for the second transistor.

With a known voltage drop across STV-3H at a given temperature the current through Q608 will be established thus setting the emitter voltage of the second transistor (Q609).

As the temperature applied to STV-3H increases the voltage drop across the diodes is reduced thus current through the first transistor is reduced and the emitter voltage drops. When the emitter voltage drops below the threshold set by the potentiometer, the second transistor will conduct thus activating the protection circuit to open the speaker relay contacts.

See page 10 for adjustment procedure.

Heat Sink Sensor

The 385R is designed with a sensor on the output transistor heat sink. This circuit operates in the same manner as the transformer sensor, however the design differences require a higher reference voltage setting for Q609. See page 10 for adjustment procedure.

ADJUSTMENTS

Equipment Required

- Audio signal generator.
- Level meter.
- Oscilloscope.
- Digital frequency counter, 0 - 100 kHz.
- FM multiplex signal generator.
- DMM, high impedance.
- 455 kHz sweep generator.
- 10.7 MHz sweep generator.

AM Section

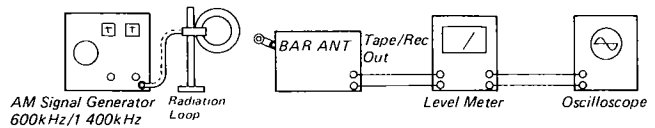

AM IF Amplifier

- 1) Apply 455 kHz sweep generator output to the unit AM antenna terminal.
- 2) Connect scope to pin number 12 of IC101.
- 3) Adjust T102 to obtain maximum and symmetrical display as shown.

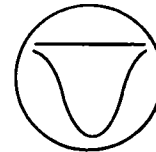

AM Tracking

- 1) Apply 600 kHz, 30% modulated with 1 kHz to the AM bar antenna. See test setup figure. (Distance between the AM bar antenna and emitting loop antenna should be 2 feet.)
- 2) Adjust signal generator output so that a sine wave appears on the scope.
- 3) Adjust T101 and L102 for maximum audio output on the level meter connected parallel with the scope. When turning core, always adjust signal generator output to maintain low input level. Do not change voltmeter range. Moreover, always keep the generator output as low as possible to avoid AGC action and to keep the measurements accurate.
- 4) Adjust the AM loopstick antenna core for maximum output reading on the voltmeter.
- 5) Shift generator frequency to 1,400 kHz with same modulation condition.
- 6) Repeat step 2.
- 7) Adjust OSC. trimmer for maximum voltmeter reading.
- 8) Adjust Ant. trimmer for maximum reading on the voltmeter.
- 9) Repeat items 3 through 8 for best tracking and maximum sensitivity.

FM IF Amplifier

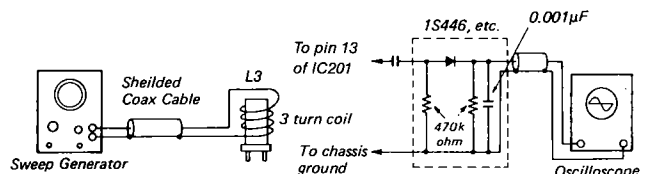

- 1) Mute the FM local oscillator by shorting L5.
- 2) Connect the oscilloscope to pin 13 of IC201.

- Apply 10.7 MHz signal from the sweep generator to L3 in the manner as shown above.
- Adjust T201 for correct figure as shown. It may be necessary to increase or decrease the sweep generator output for adjustment convenience.

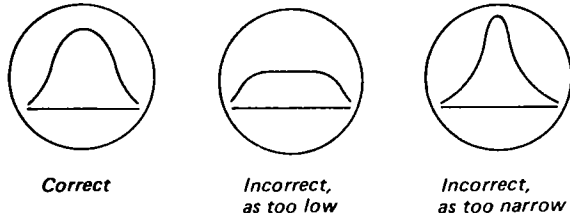

FM RF Tracking

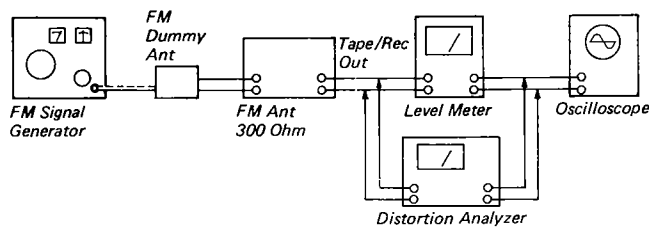

- Apply 90 MHz, 1 kHz and 100% modulated, 25 dBf signal level to the FM antenna terminals.
- Tune unit to 90 MHz.
- Observe the oscilloscope connected to the Tape/Rec output terminal for symmetrical sine wave. If failed, adjust L5.
- Adjust L1 and L2 for maximum level meter reading. Reduce input from the 25 dBf level as necessary to maintain noise on sine wave.
- Readjust the signal generator for 106 MHz, and retune unit.
- Repeat step 3. If failed, adjust the OSC. trimming capacitor mounted on the tuning capacitor.
- Adjust the trimming capacitors, for mixer and RF.
- Repeat as necessary until product specifications are met.

Center Tuning Adjustment

Connect DC DMM between chassis and pin 15 of IC201. Tune receiver to signal generator with output set at 65 dBf, carefully tune for lowest AGC voltage. (Assuming proper IF alignment this step assures tuning to center of IF band pass.) Reconnect DMM to PCB Terminals marked TUNING METER and adjust T202 for zero volts.

FM Distortion

With unit connected as above for tuning indicator adjustment, adjust T203 for minimum harmonic distortion.

Since there is some interaction between coil settings, repeat center tune and distortion adjustments for optimum results.

FM Signal Strength Display

- At 98 MHz, with receiver connected and tuned to FM generator, apply 65 dBf signal to unit antenna.
- Adjust R835 on Display Board until all segments are lighted.
- Reduce RF input to zero and note that both left and right center tune guide indicators are lighted.

Mute Threshold Adjust

- At 98 MHz, 20 dBf signal level, and set-up connected as above, tune unit with mute switch in the OFF position.
- Switch MUTE ON and adjust R226 until FM output is muted.
- Increase generator output to check for proper muting action.
- With LOCK/MUTE button IN, tune generator 50-100 kHz high and note that with approximately 8 seconds delay the circuit corrects to CENTER TUNE. Tune generator 50-100 kHz low and note same corrective action.

Multiplex Pilot Adjust

- Apply 98 MHz, 65 dBf signal to the unit with no modulation.
- Adjust R303 for 76 kHz reading on the frequency counter connected between TP and chassis ground. A deviation of ± 200 Hz is acceptable.

Stereo Separation

- Apply 98 MHz, 65 dBf left channel signal to the unit modulated with 1 kHz, 9% pilot signal.
- Connect a digital voltmeter to the right channel Tape/Rec output terminal.
- Adjust R312 for minimum leakage (minimum level) on the voltmeter.
- Apply 98 MHz, 65 dBf right channel signal to the unit modulated same as step 1.
- Move digital voltmeter to the left channel Tape/Rec output terminal.
- Check for approximately the same leakage as in step 3.

Audio Adjustments

Equipment Required

Audio signal generator.
Digital multimeter.
Speaker load resistors, 8 ohm 100 watt.

The following adjustments are the same for both the left and right channels.

Bias Adjustment

- Connect 8 ohm load resistors to the Speaker A terminals, and set the Speaker A switch to ON position.
- Turn the Volume control fully counterclockwise.
- Turn R1412 fully counterclockwise.

- 4) Using digital multimeter set meter to read 200 mV. Connect probes to emitters of Q1408, Q1409 (Voltmeter bias test points, L channel). Turn unit ON. Let it idle for at least one minute. Adjust R1412 for 30 mV across the resistors.
- 5) Perform the same procedure for the right channel, except measure voltage at emitters of Q1458, Q1459 (voltmeter bias test). Adjustment is made with R1462.
- 6) Leave the amplifier on for about 30 minutes, then recheck measurement. A tolerance of $\pm 25\%$ is acceptable. Readjust if necessary.

Power Indicator Adjust (355R and 375R)

- 1) With all controls flat and volume at maximum, adjust input signal for an output level of 40 watts (no load) at 1 kHz.
- 2) Adjust controls located on PWB behind front panel (R861 for left channel, R877 for right channel) for an output power reading of 40 watts.

Power Indicator Adjust (385R)

- 1) With all controls flat and volume at maximum, adjust input signal for an output level of 65 watts (no load) at 1 kHz.
- 2) Adjust controls R705 and R755 located on PWB behind front panel (R705 for left channel, R755 for right channel), for an output power reading of 65 watts.

Frequency Display Adjustment, (375R, 385R)

- 1) Adjust R803 located on PCB behind front panel for 7.0-8.0V on pin 13 of IC801. Note this voltage should be as low as possible within the above range while still maintaining reliable display under normal user conditions.

FM Display Adjustment.

- 1) Tune receiver to FM broadcast station of known frequency (the lock circuit may be used for accuracy). Adjust R808 until display reads the known station carrier frequency.
Note: It is important that pot R808 be rotated left and right through the range where the correct frequency is displayed ending in the center of the range.

AM Display Adjustment

- 1) Carefully tune receiver to center of AM station of known broadcast frequency. Adjust R809 until display reads the exact carrier frequency.

Power Transformer Temperature Sensor Adjustment.

- 1) Connect DMM to measure DC voltage at test terminals.
- 2) With unit at room temperature 20°C (68°F) adjust R627 for 400 mV.
- 3) If transformer temperature is within the range of 10-30°C, the measured voltage should be corrected by -7.5 mV for each degree above 20 and +7.5 mV for each degree below 20.

Heat Sink Temperature Sensor Adjustment (385R)

- 1) Follow the above procedure setting the voltage at the test terminals at 900 mV when heatsink temperature is 20°C.

Dial Cord Stringing

- 1) Loosen the screw securing the drum to the variable capacitor shaft.
- 2) Tie the end of the cord "A" as shown to the fixing protrusion on the drum.
- 3) Wind the cord two turns around the drum then thread it through the rollers, etc., following the illustration.
- 4) Tie the end of the cord to the coiled spring so that the proper tension of the dial cord is obtained.
- 5) Align the pointer position for the correct frequency indication on the tuning dial.
- 6) Secure the screw on the drum.

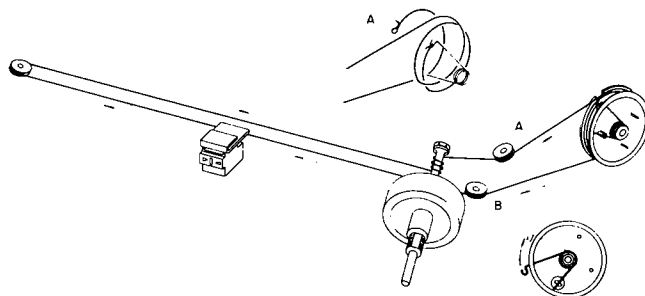

Fluorescent Indicator Panels (FIP)

Power

The models 355R and 375R utilize the same basic power display tube and both are driven by IC806, a type LC7555. The fundamental difference between the two tubes is the scale marking. Therefore, replacement parts should be ordered by part number for the appropriate model no.

The 385R utilizes a more sophisticated power meter, one which is the result of joint efforts by SCOTT and NIPPON ELECTRIC CO., LTD. Engineers to develop this multi-purpose tube to SCOTT specifications.

Tuning

The tuning display tube used in the 375R and 385R provides indication of AM and FM signal strength. FM center tuning, and a frequency read-out of both the AM and FM bands.

Drawings on the following pages show the pin connections to the various elements of the above mentioned FIPs.

Caution

THESE FIPs, BEING MADE OF GLASS ARE EASILY DAMAGED. A LOSS OF VACUUM OR BREAKAGE CAN RESULT FROM PHYSICAL SHOCK OR STRESS DURING HANDLING AND INSTALLATION.

"FIP" LEAD CODE

The following pages contain outline drawings and lead codes for FIPs used in these models.

| | | | | | | | | | | | | | | | | | | | | | | | | | | | | | | | | | | |
|-----------|---|----|----|----|---|----|----|----|----|----|----|----|----|----|----|----|----|----|----|----|----|----|----|----|----|----|----|----|----|----|----|----|----|--|
| Pin no. | 1 | 2 | 3 | 4 | 5 | 6 | 7 | 8 | 9 | 10 | 11 | 12 | 13 | 14 | 15 | 16 | 17 | 18 | 19 | 20 | 21 | 22 | 23 | 24 | 25 | 26 | 27 | 28 | 29 | 30 | 31 | 32 | 33 | |
| Electrode | F | NP | SC | 1a | G | 2a | 3a | 4a | 5a | 6a | 1b | 2b | 3b | 4b | 5b | 6b | 7b | G | 8b | 9b | 10 | 11 | 12 | 7a | 8a | 9a | 10 | 11 | 12 | NP | NC | NP | F | |
| | | | | | | | | | | | | | | | | | | | | | b | b | b | b | a | a | a | a | a | | | | | |

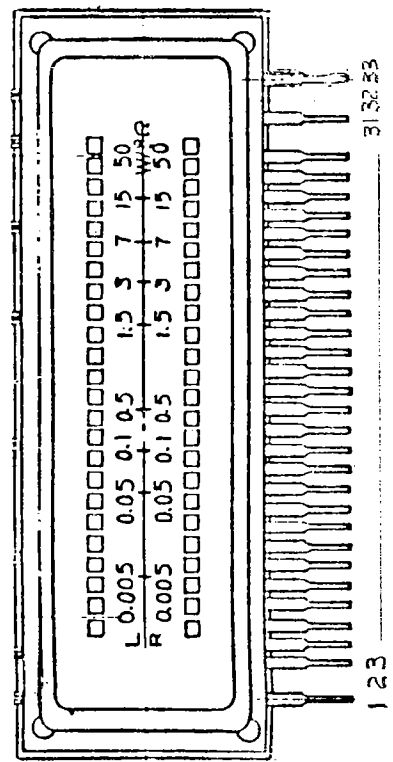
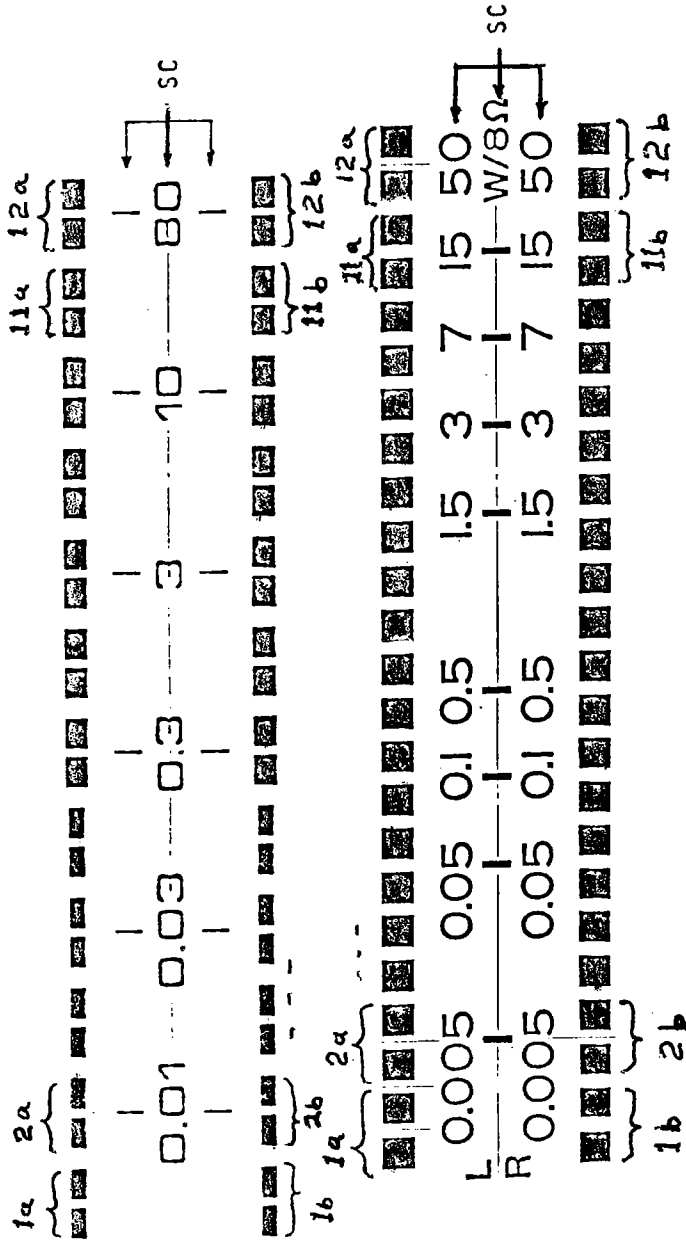

FL 801
TYP. BG-32, BG-60
355R-375R

123 313223

FL-701
385R

| | | | | | | | | | | | | | | | | | | | | |
|-----------|---|---|----|----|----|----|----|----|----|----|----|----|----|----|----|----|----|----|----|----|
| TERM. NO. | 1 | 2 | 3 | 4 | 5 | 6 | 7 | 8 | 9 | 10 | 11 | 12 | 13 | 14 | 15 | 16 | 17 | 18 | 19 | 20 |
| ELECTRODE | F | G | P1 | P2 | P3 | P4 | P5 | P6 | Pa | PB | PC | PD | G | PE | PF | P% | PW | Ps | Ps | Ps |
| | | | | | | | | B | | | | | | | | | | 4 | 4 | 3 |

| | | | | | | | | | | | | | | | | | | | | |
|-----------|----|----|-----|----|----|----|----|----|----|----|-----|-----|----|----|----|----|----|----|----|----|
| TERM. NO. | 21 | 22 | 23 | 24 | 25 | 26 | 27 | 28 | 29 | 30 | 31 | 32 | 33 | 34 | 35 | 36 | 37 | 38 | 39 | 40 |
| ELECTRODE | Ps | Ps | Lch | P | P | G | PI | PJ | PK | PL | P+8 | P | P | P | P | P | P | P | P | F |
| | 2 | 1 | Rch | G | H | | | | | | Met | Dot | 7 | 8 | 9 | 10 | 11 | 12 | G | F |

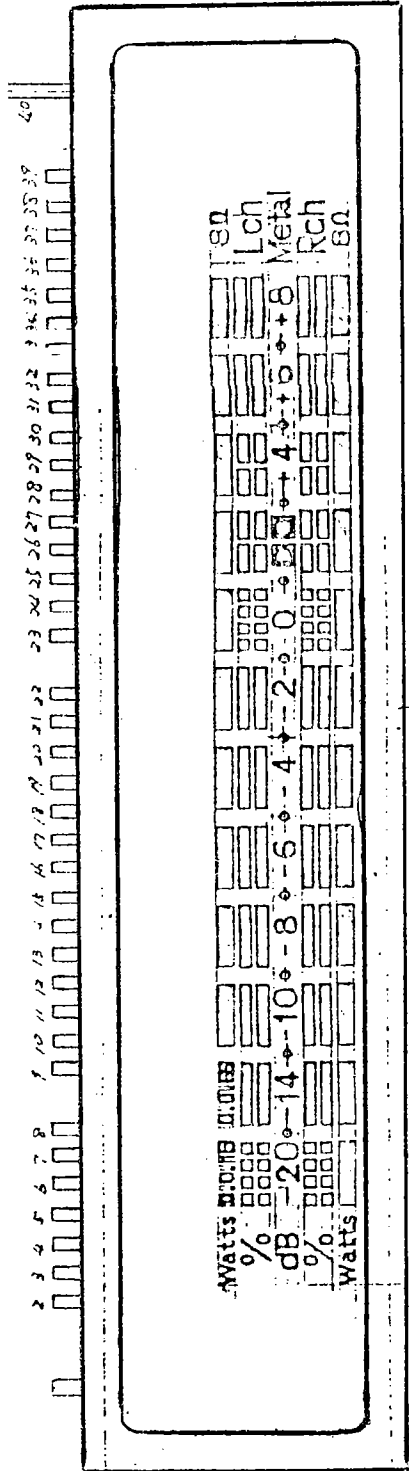
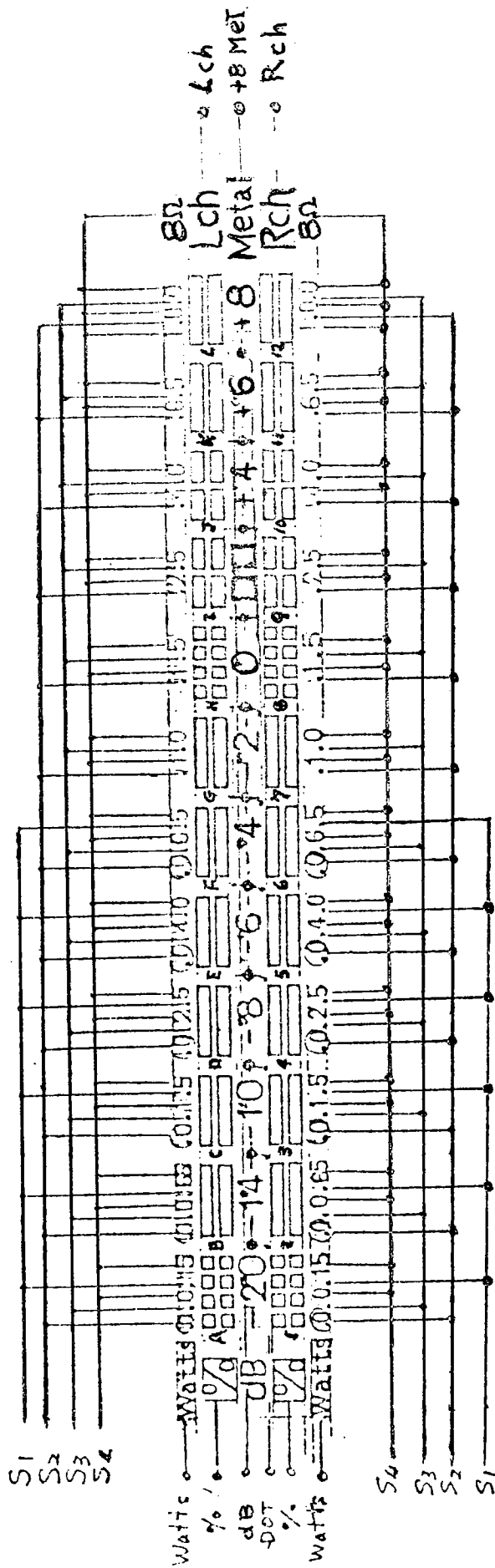

FL 802 375R-385R

| | | | | | | | | | | | | | | | | | | | | | | | | | | | | | | | | | | | | | |
|----------|----|----|----|----|----|----|----|----|----|----|----|----|----|----|----|----|----|----|----|----|----|----|----|----|----|----|----|----|----|----|----|----|----|----|----|----|----|
| NP 319 | 29 | 29 | S1 | S2 | S3 | S4 | S5 | f5 | 29 | b5 | a5 | f4 | b4 | a4 | f3 | NC | NP | 19 | g1 | f1 | b1 | a1 | 19 | VC | NP | NP | | | | | | | | | | | |
| PINNO 76 | 75 | 77 | 73 | 72 | 71 | 70 | 69 | 68 | 67 | 66 | 65 | 64 | 63 | 62 | 61 | 60 | 59 | 58 | 57 | 56 | 55 | 54 | 53 | 52 | 51 | 50 | 49 | 48 | 47 | 46 | 45 | 44 | 43 | 42 | 41 | 40 | 39 |

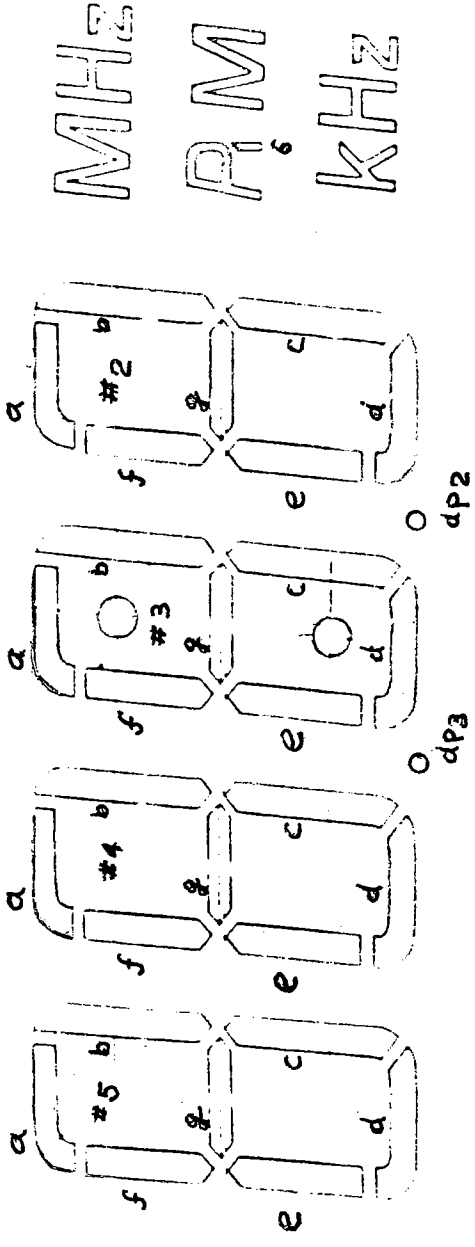
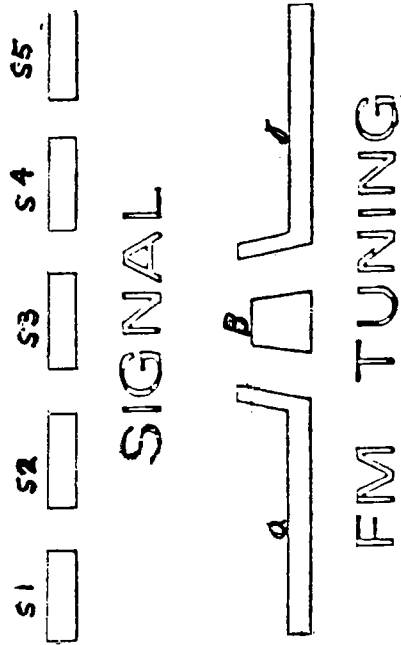

| | | | | | | | | | | | | | | | | | | | | | | | | | | | | | | | | | | | | | | |
|--------|---|---|---|---|---|---------|----|----|----|----|----|----|----|----|----|----|----|----|-----|----|----|----|----|-----|----|----|----|----|-----|----|----|----|----|-----|----|----|----|----|
| PIN NO | 1 | 2 | 3 | 4 | 5 | 6 | 7 | 8 | 9 | 10 | 11 | 12 | 13 | 14 | 15 | 16 | 17 | 18 | 19 | 20 | 21 | 22 | 23 | 24 | 25 | 26 | 27 | 28 | 29 | 30 | 31 | 32 | 33 | 34 | 35 | 36 | 37 | 38 |
| | F | a | A | Z | 8 | FM TUNE | C5 | es | d5 | 29 | gA | C4 | C4 | C4 | d4 | p3 | d1 | g3 | 1d2 | C3 | 19 | e3 | d3 | dp2 | C2 | e2 | 19 | d2 | dp1 | C1 | C1 | d1 | 19 | KHZ | 5 | PM | F | |

PIN CONNECTION (TOP VIEW)

Parts Location Diagrams
375R 385R
Tuner, Amplifier and Protection

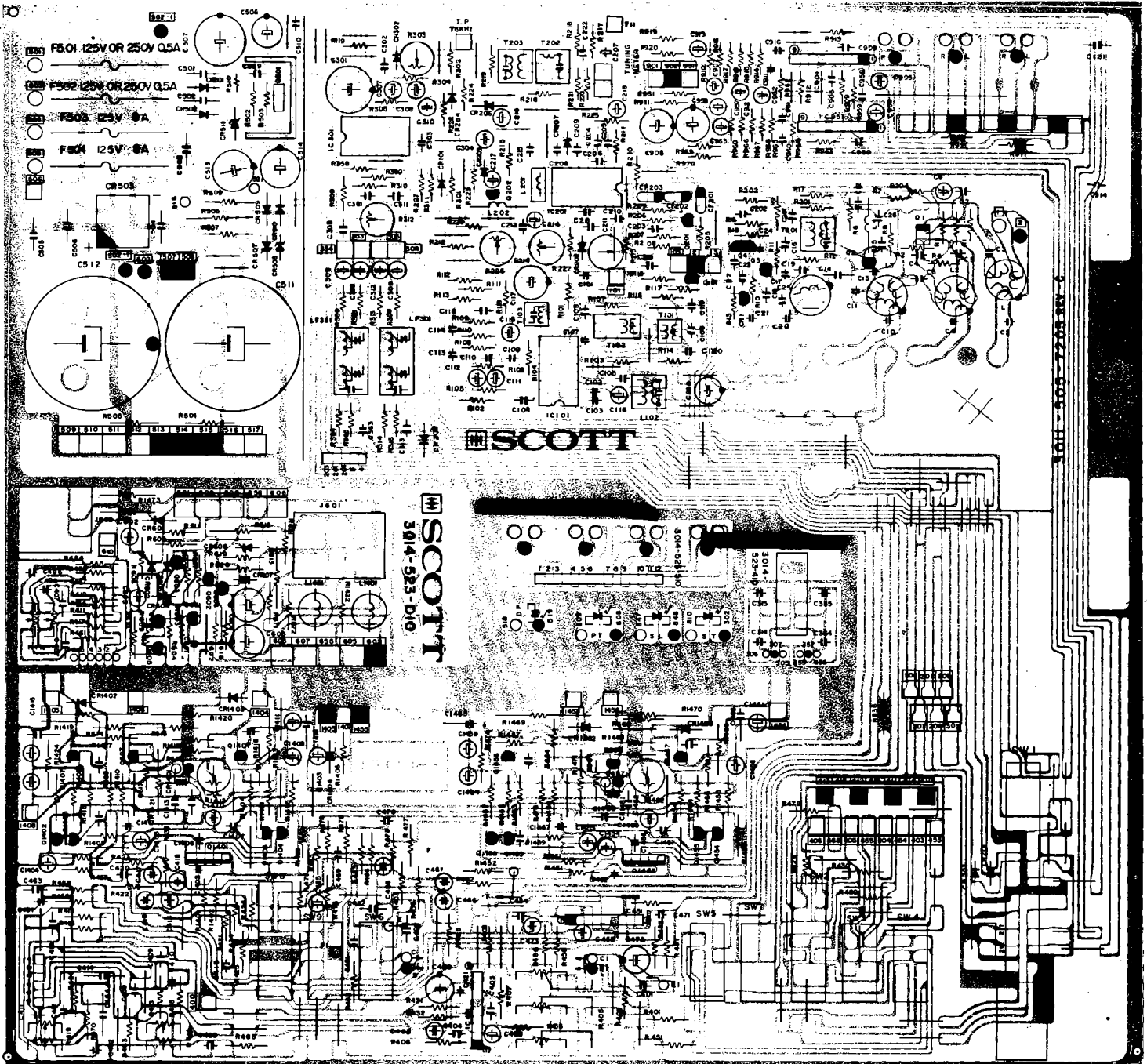

Parts Location Diagram 355R Tuner, Amp, Protection

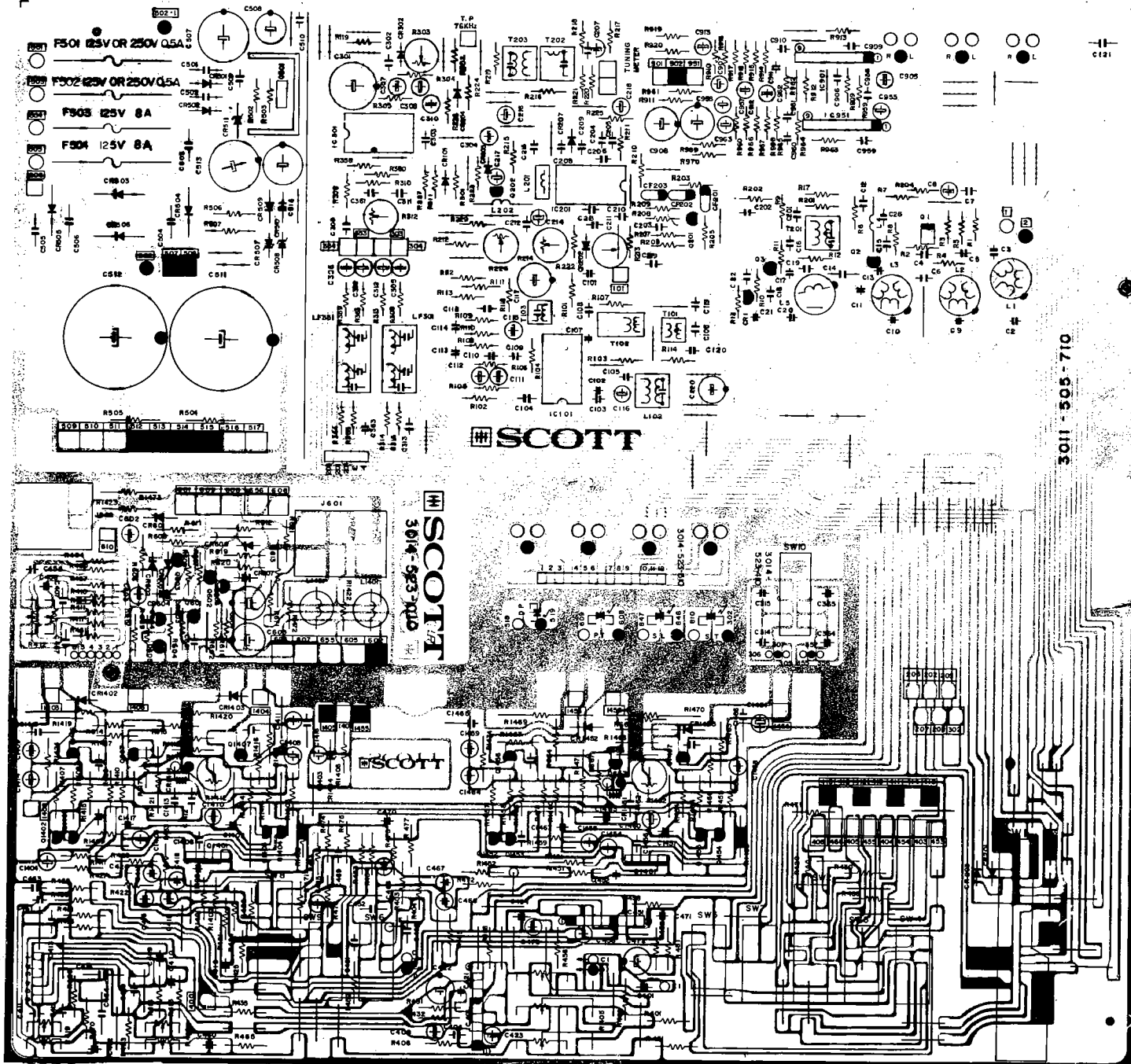

3011-505-710

**Parts Location Diagram
375R, 385R Display**

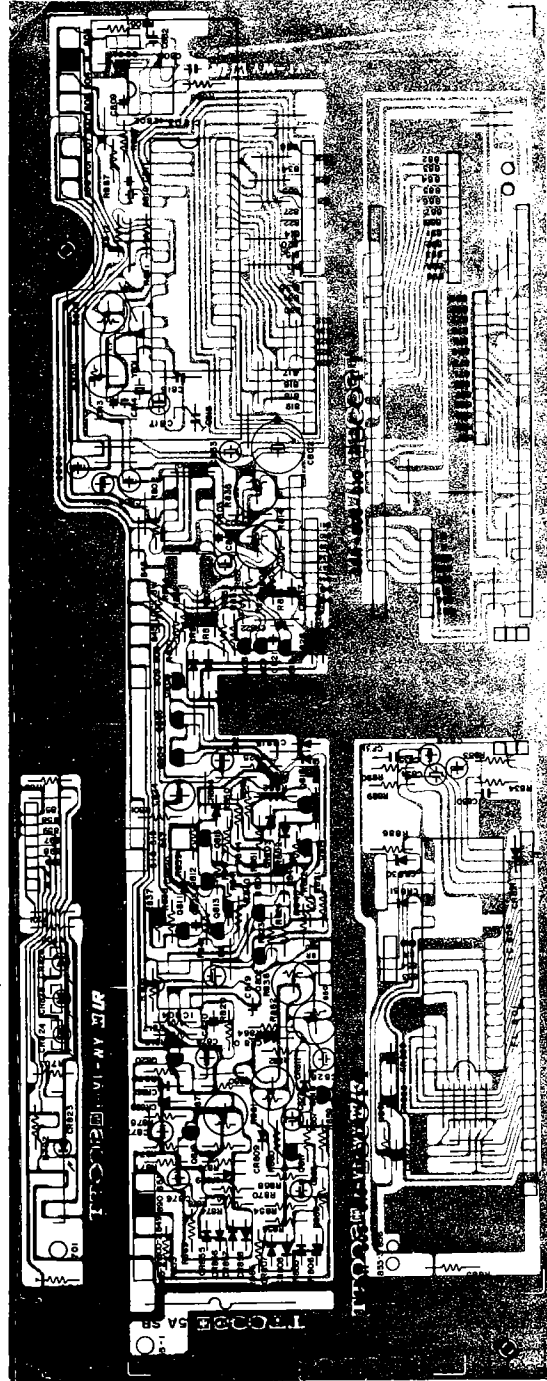

**Parts Location Diagram
Moving Coil Preamp.**

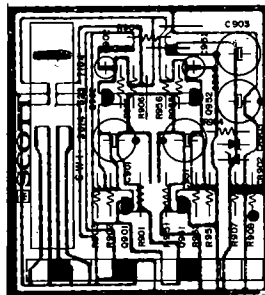

SCHEMATIC DIAGRAM

355R

1981, 8.7

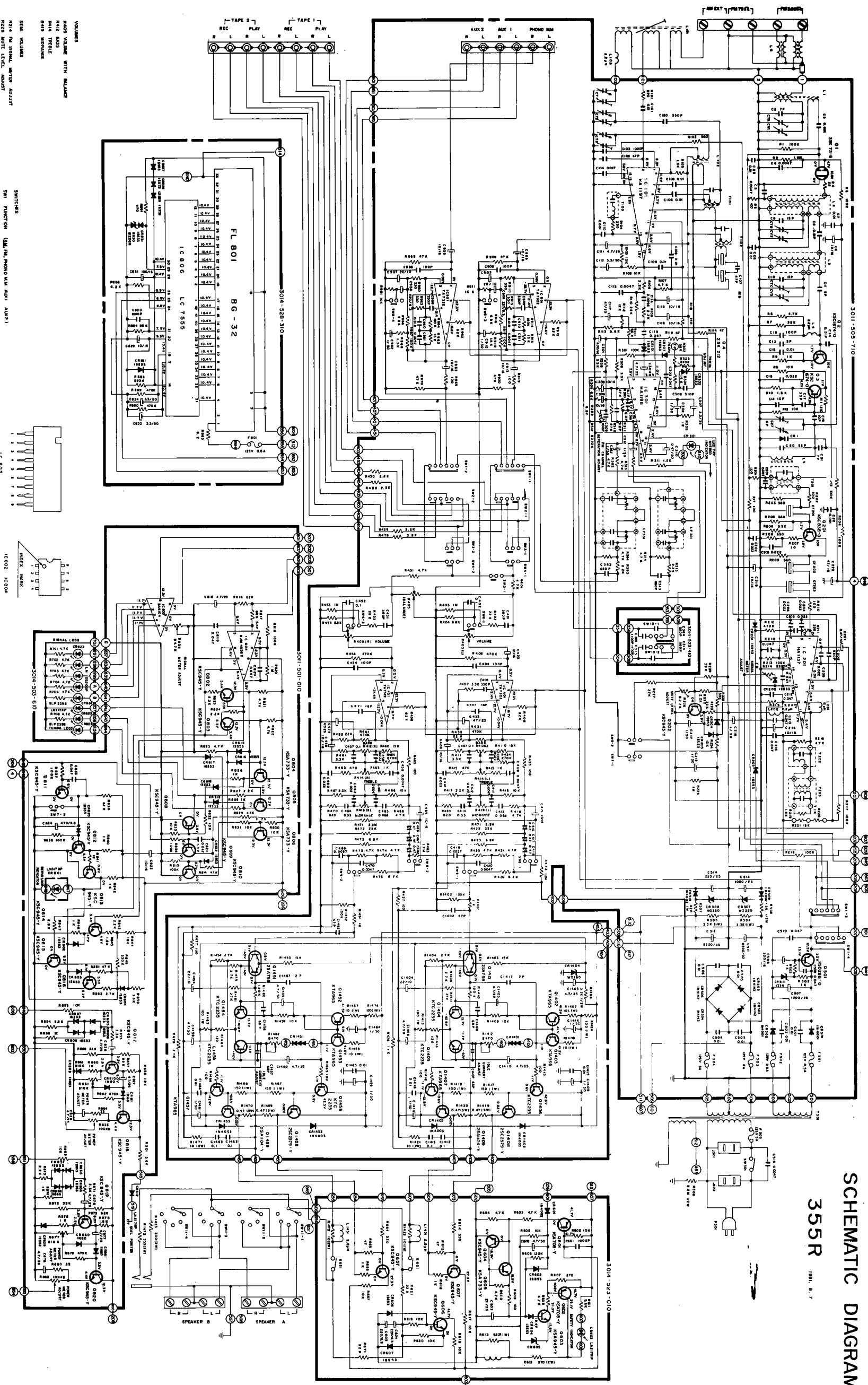

VOLUME
 R403 VOLUME WITH BALANCE
 R412 BALANCE
 R419 BALANCE

SEMI VOLUMES
 R414 PA SIGNAL, LETTER ADJUST
 R415 PA SIGNAL, LETTER ADJUST
 R416 PA SIGNAL, LETTER ADJUST
 R417 PA SIGNAL, LETTER ADJUST
 R418 PA SIGNAL, LETTER ADJUST
 R419 PA SIGNAL, LETTER ADJUST
 R420 PA SIGNAL, LETTER ADJUST
 R421 PA SIGNAL, LETTER ADJUST
 R422 PA SIGNAL, LETTER ADJUST
 R423 PA SIGNAL, LETTER ADJUST
 R424 PA SIGNAL, LETTER ADJUST
 R425 PA SIGNAL, LETTER ADJUST
 R426 PA SIGNAL, LETTER ADJUST
 R427 PA SIGNAL, LETTER ADJUST
 R428 PA SIGNAL, LETTER ADJUST
 R429 PA SIGNAL, LETTER ADJUST
 R430 PA SIGNAL, LETTER ADJUST
 R431 PA SIGNAL, LETTER ADJUST
 R432 PA SIGNAL, LETTER ADJUST
 R433 PA SIGNAL, LETTER ADJUST
 R434 PA SIGNAL, LETTER ADJUST
 R435 PA SIGNAL, LETTER ADJUST
 R436 PA SIGNAL, LETTER ADJUST
 R437 PA SIGNAL, LETTER ADJUST
 R438 PA SIGNAL, LETTER ADJUST
 R439 PA SIGNAL, LETTER ADJUST
 R440 PA SIGNAL, LETTER ADJUST
 R441 PA SIGNAL, LETTER ADJUST
 R442 PA SIGNAL, LETTER ADJUST
 R443 PA SIGNAL, LETTER ADJUST
 R444 PA SIGNAL, LETTER ADJUST
 R445 PA SIGNAL, LETTER ADJUST
 R446 PA SIGNAL, LETTER ADJUST
 R447 PA SIGNAL, LETTER ADJUST
 R448 PA SIGNAL, LETTER ADJUST
 R449 PA SIGNAL, LETTER ADJUST
 R450 PA SIGNAL, LETTER ADJUST
 R451 PA SIGNAL, LETTER ADJUST
 R452 PA SIGNAL, LETTER ADJUST
 R453 PA SIGNAL, LETTER ADJUST
 R454 PA SIGNAL, LETTER ADJUST
 R455 PA SIGNAL, LETTER ADJUST
 R456 PA SIGNAL, LETTER ADJUST
 R457 PA SIGNAL, LETTER ADJUST
 R458 PA SIGNAL, LETTER ADJUST
 R459 PA SIGNAL, LETTER ADJUST
 R460 PA SIGNAL, LETTER ADJUST
 R461 PA SIGNAL, LETTER ADJUST
 R462 PA SIGNAL, LETTER ADJUST
 R463 PA SIGNAL, LETTER ADJUST
 R464 PA SIGNAL, LETTER ADJUST
 R465 PA SIGNAL, LETTER ADJUST
 R466 PA SIGNAL, LETTER ADJUST
 R467 PA SIGNAL, LETTER ADJUST
 R468 PA SIGNAL, LETTER ADJUST
 R469 PA SIGNAL, LETTER ADJUST
 R470 PA SIGNAL, LETTER ADJUST
 R471 PA SIGNAL, LETTER ADJUST
 R472 PA SIGNAL, LETTER ADJUST
 R473 PA SIGNAL, LETTER ADJUST
 R474 PA SIGNAL, LETTER ADJUST
 R475 PA SIGNAL, LETTER ADJUST
 R476 PA SIGNAL, LETTER ADJUST
 R477 PA SIGNAL, LETTER ADJUST
 R478 PA SIGNAL, LETTER ADJUST
 R479 PA SIGNAL, LETTER ADJUST
 R480 PA SIGNAL, LETTER ADJUST
 R481 PA SIGNAL, LETTER ADJUST
 R482 PA SIGNAL, LETTER ADJUST
 R483 PA SIGNAL, LETTER ADJUST
 R484 PA SIGNAL, LETTER ADJUST
 R485 PA SIGNAL, LETTER ADJUST
 R486 PA SIGNAL, LETTER ADJUST
 R487 PA SIGNAL, LETTER ADJUST
 R488 PA SIGNAL, LETTER ADJUST
 R489 PA SIGNAL, LETTER ADJUST
 R490 PA SIGNAL, LETTER ADJUST
 R491 PA SIGNAL, LETTER ADJUST
 R492 PA SIGNAL, LETTER ADJUST
 R493 PA SIGNAL, LETTER ADJUST
 R494 PA SIGNAL, LETTER ADJUST
 R495 PA SIGNAL, LETTER ADJUST
 R496 PA SIGNAL, LETTER ADJUST
 R497 PA SIGNAL, LETTER ADJUST
 R498 PA SIGNAL, LETTER ADJUST
 R499 PA SIGNAL, LETTER ADJUST
 R500 PA SIGNAL, LETTER ADJUST

SWITCHES
 SW1 TUNING (LAMP IN PHONO MM ADJ. AUX2)
 SW2 TUNE (COPY, NORMAL)
 SW3 TUNE (TAP, TUNE 2)
 SW4 TUNE (TAP, TUNE 1)
 SW5 MODE (STEREO, MONO)
 SW6 MODE (STEREO, MONO)
 SW7 PA MUTE, SILENCE (ON-OFF)
 SW8 SILENCE (ON-OFF)
 SW9 SILENCE (ON-OFF)
 SW10 DC-CUMBERS SW (25V, -25V, 50V)
 SW11 SILENCE POWER SW B SPEAKER (OFF, A, B, A+B, PHONES)

NOTE
 1. ALL RESISTANCE VALUES IN OHM K_Ω OR M_Ω UNLESS OTHERWISE SPECIFIED.
 2. UNLESS OTHERWISE NOTED IN SCHEMATIC ALL CAPACITORS IN MFD PF OR PICOGRAM.
 3. THERE MIGHT BE SLIGHT CHANGES IN THE ACTUAL SET.
 4. ALL VOLTAGES ARE DC UNLESS OTHERWISE SPECIFIED, DC VOLTAGES SHOWN ARE MEASURED FROM CHASSIS WITH NO SIGNAL INPUT, LOADNESS SWITCH IN "OFF" POSITION, LINE VOLTAGE 200V USMG.
 A HIGH IMPEDANCE DIGITAL MULTIMETER.

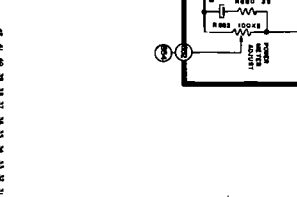
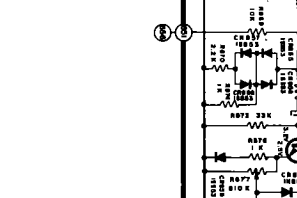
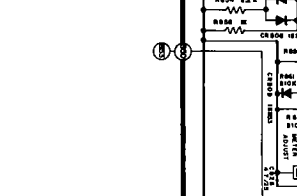
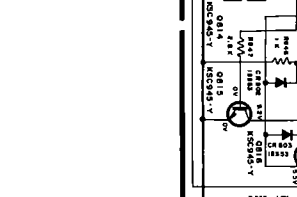
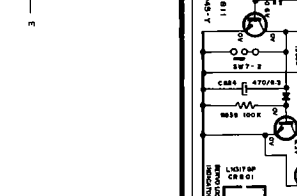
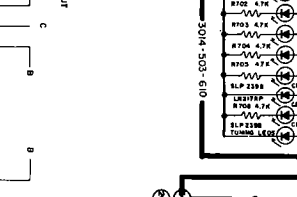
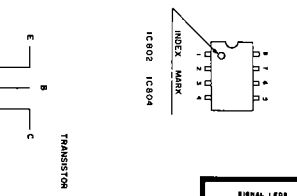

17

SCHEMATIC DIAGRAM

375R 1981 8 7

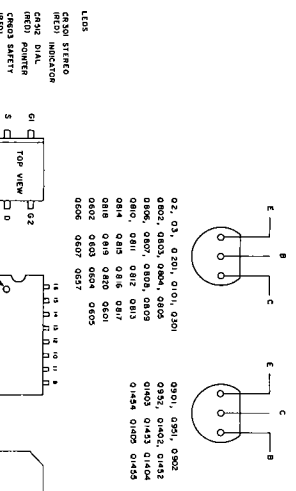
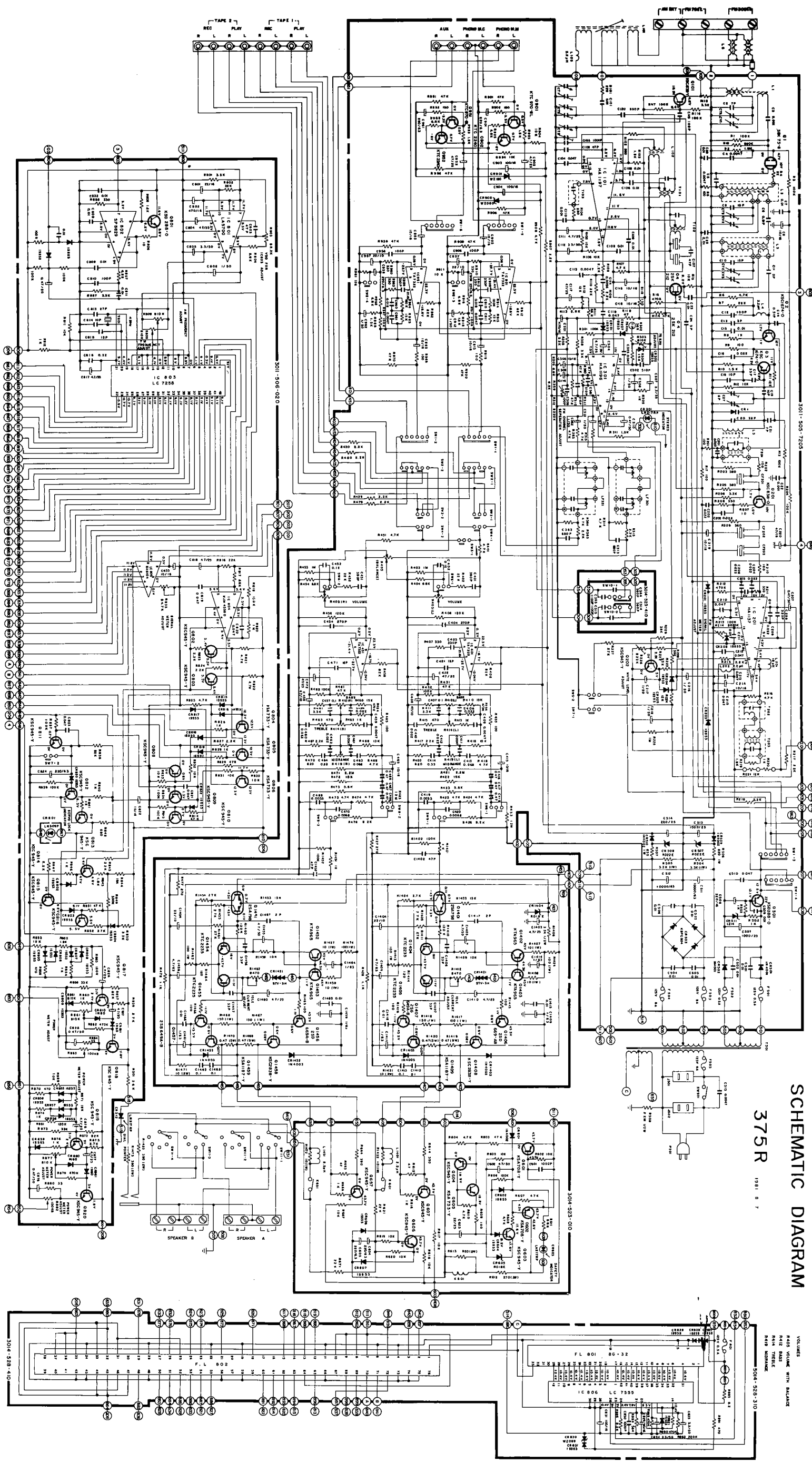

- SWITCHES
- SW1 FUNCTION (L.A.M./A.M./M.W./PHONO/M.C./A.M.)
 - SW2 TAP (COPY/TUNING)
 - SW3 TAP (TUNE/TUNE 2)
 - SW4 TAP (TUNE/TUNE 2)
 - SW5 TAP (TUNE/TUNE 2)
 - SW6 TAP (TUNE/TUNE 2)
 - SW7 TAP (TUNE/TUNE 2)
 - SW8 TAP (TUNE/TUNE 2)
 - SW9 TAP (TUNE/TUNE 2)
 - SW10 TAP (TUNE/TUNE 2)
 - SW11 TAP (TUNE/TUNE 2)
 - SW12 TAP (TUNE/TUNE 2)
 - SW13 TAP (TUNE/TUNE 2)
 - SW14 TAP (TUNE/TUNE 2)
 - SW15 TAP (TUNE/TUNE 2)
 - SW16 TAP (TUNE/TUNE 2)
 - SW17 TAP (TUNE/TUNE 2)
 - SW18 TAP (TUNE/TUNE 2)
 - SW19 TAP (TUNE/TUNE 2)
 - SW20 TAP (TUNE/TUNE 2)
 - SW21 TAP (TUNE/TUNE 2)
 - SW22 TAP (TUNE/TUNE 2)
 - SW23 TAP (TUNE/TUNE 2)
 - SW24 TAP (TUNE/TUNE 2)
 - SW25 TAP (TUNE/TUNE 2)
 - SW26 TAP (TUNE/TUNE 2)
 - SW27 TAP (TUNE/TUNE 2)
 - SW28 TAP (TUNE/TUNE 2)
 - SW29 TAP (TUNE/TUNE 2)
 - SW30 TAP (TUNE/TUNE 2)
 - SW31 TAP (TUNE/TUNE 2)
 - SW32 TAP (TUNE/TUNE 2)
 - SW33 TAP (TUNE/TUNE 2)
 - SW34 TAP (TUNE/TUNE 2)
 - SW35 TAP (TUNE/TUNE 2)
 - SW36 TAP (TUNE/TUNE 2)
 - SW37 TAP (TUNE/TUNE 2)
 - SW38 TAP (TUNE/TUNE 2)
 - SW39 TAP (TUNE/TUNE 2)
 - SW40 TAP (TUNE/TUNE 2)
 - SW41 TAP (TUNE/TUNE 2)
 - SW42 TAP (TUNE/TUNE 2)
 - SW43 TAP (TUNE/TUNE 2)
 - SW44 TAP (TUNE/TUNE 2)
 - SW45 TAP (TUNE/TUNE 2)
 - SW46 TAP (TUNE/TUNE 2)
 - SW47 TAP (TUNE/TUNE 2)
 - SW48 TAP (TUNE/TUNE 2)
 - SW49 TAP (TUNE/TUNE 2)
 - SW50 TAP (TUNE/TUNE 2)
 - SW51 TAP (TUNE/TUNE 2)
 - SW52 TAP (TUNE/TUNE 2)
 - SW53 TAP (TUNE/TUNE 2)
 - SW54 TAP (TUNE/TUNE 2)
 - SW55 TAP (TUNE/TUNE 2)
 - SW56 TAP (TUNE/TUNE 2)
 - SW57 TAP (TUNE/TUNE 2)
 - SW58 TAP (TUNE/TUNE 2)
 - SW59 TAP (TUNE/TUNE 2)
 - SW60 TAP (TUNE/TUNE 2)
 - SW61 TAP (TUNE/TUNE 2)
 - SW62 TAP (TUNE/TUNE 2)
 - SW63 TAP (TUNE/TUNE 2)
 - SW64 TAP (TUNE/TUNE 2)
 - SW65 TAP (TUNE/TUNE 2)
 - SW66 TAP (TUNE/TUNE 2)
 - SW67 TAP (TUNE/TUNE 2)
 - SW68 TAP (TUNE/TUNE 2)
 - SW69 TAP (TUNE/TUNE 2)
 - SW70 TAP (TUNE/TUNE 2)
 - SW71 TAP (TUNE/TUNE 2)
 - SW72 TAP (TUNE/TUNE 2)
 - SW73 TAP (TUNE/TUNE 2)
 - SW74 TAP (TUNE/TUNE 2)
 - SW75 TAP (TUNE/TUNE 2)
 - SW76 TAP (TUNE/TUNE 2)
 - SW77 TAP (TUNE/TUNE 2)
 - SW78 TAP (TUNE/TUNE 2)
 - SW79 TAP (TUNE/TUNE 2)
 - SW80 TAP (TUNE/TUNE 2)
 - SW81 TAP (TUNE/TUNE 2)
 - SW82 TAP (TUNE/TUNE 2)
 - SW83 TAP (TUNE/TUNE 2)
 - SW84 TAP (TUNE/TUNE 2)
 - SW85 TAP (TUNE/TUNE 2)
 - SW86 TAP (TUNE/TUNE 2)
 - SW87 TAP (TUNE/TUNE 2)
 - SW88 TAP (TUNE/TUNE 2)
 - SW89 TAP (TUNE/TUNE 2)
 - SW90 TAP (TUNE/TUNE 2)
 - SW91 TAP (TUNE/TUNE 2)
 - SW92 TAP (TUNE/TUNE 2)
 - SW93 TAP (TUNE/TUNE 2)
 - SW94 TAP (TUNE/TUNE 2)
 - SW95 TAP (TUNE/TUNE 2)
 - SW96 TAP (TUNE/TUNE 2)
 - SW97 TAP (TUNE/TUNE 2)
 - SW98 TAP (TUNE/TUNE 2)
 - SW99 TAP (TUNE/TUNE 2)
 - SW100 TAP (TUNE/TUNE 2)

- NOTE
1. ALL RESISTANCE VALUES IN OHM K^Ω M^Ω AND MEGA OHM. ALL RESISTORS 1/4W UNLESS OTHERWISE SPECIFIED.
 2. UNLESS OTHERWISE NOTED IN SCHEMATIC ALL CAPACITORS IN PFD OR MICROFARAD.
 3. THESE SHOULD BE SLIGHT CHANGES IN THE ACTUAL SET.
 4. ALL VOLTAGES ARE DC UNLESS OTHERWISE SPECIFIED. DC VOLTAGES SHOWN ARE MEASURED FROM COMMON WITH NO SIGNAL INPUT. LOADNESS SWITCH IN 'OFF' POSITION. LINE VOLTAGE 120V 50/60 HZ.

SCHEMATIC DIAGRAM 385R

1982, 2-20

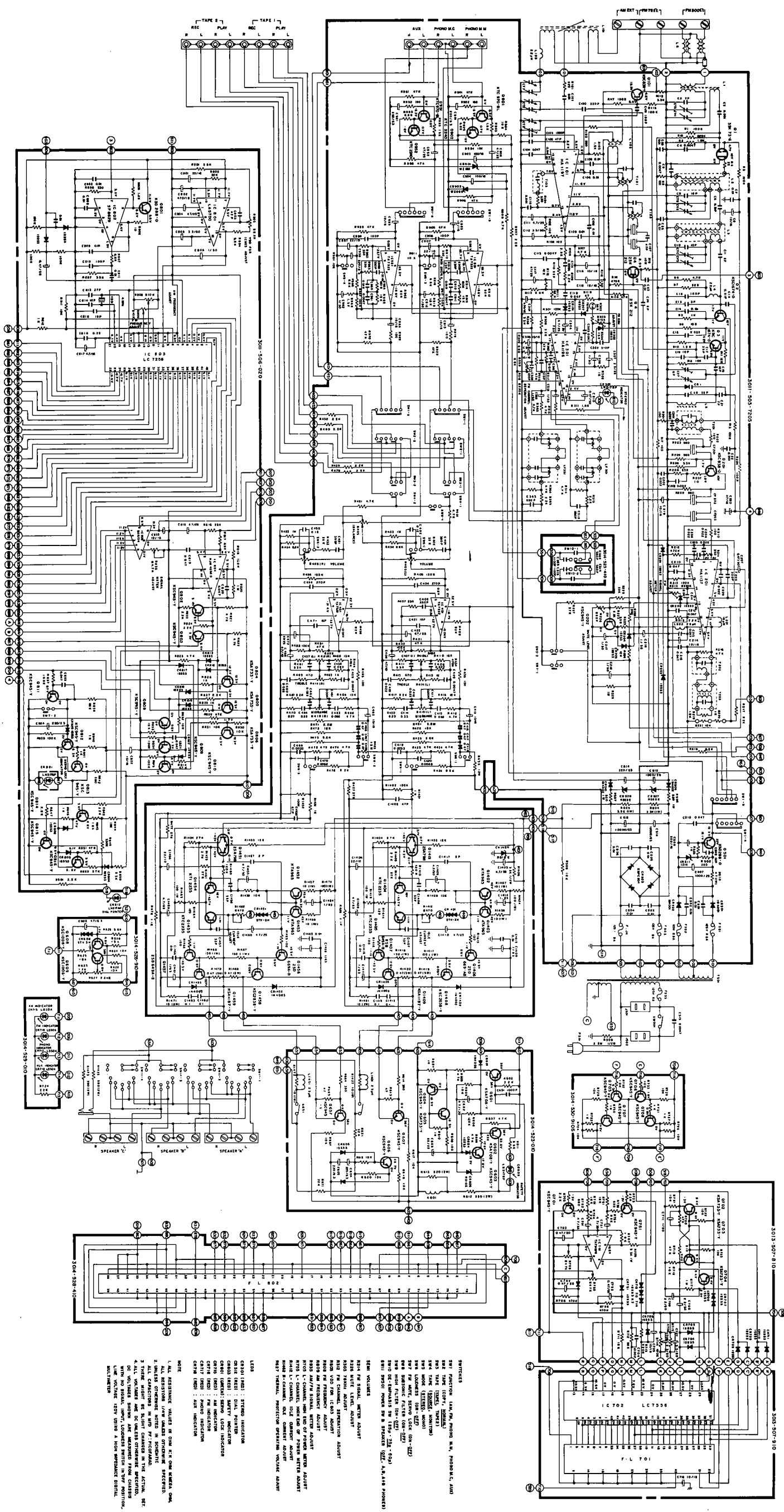

DEFINITIONS
 1. ALL RESISTANCE VALUES IN OHMS UNLESS OTHERWISE SPECIFIED.
 2. ALL CAPACITANCE VALUES IN MICROFARADS UNLESS OTHERWISE SPECIFIED.
 3. TUBE SOCKET PIN NUMBERS ARE SHOWN IN THE ACTUAL, BUT NOT IN THE SCHEMATIC, POSITION.
 4. ALL VOLTAGE AND CURRENT RATINGS ARE IN RMS UNLESS OTHERWISE SPECIFIED.
 5. ALL VOLTAGE AND CURRENT RATINGS ARE IN RMS UNLESS OTHERWISE SPECIFIED.
 6. ALL VOLTAGE AND CURRENT RATINGS ARE IN RMS UNLESS OTHERWISE SPECIFIED.
 7. ALL VOLTAGE AND CURRENT RATINGS ARE IN RMS UNLESS OTHERWISE SPECIFIED.
 8. ALL VOLTAGE AND CURRENT RATINGS ARE IN RMS UNLESS OTHERWISE SPECIFIED.
 9. ALL VOLTAGE AND CURRENT RATINGS ARE IN RMS UNLESS OTHERWISE SPECIFIED.
 10. ALL VOLTAGE AND CURRENT RATINGS ARE IN RMS UNLESS OTHERWISE SPECIFIED.

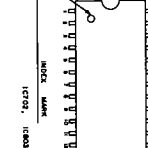
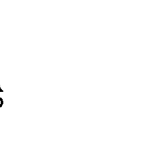
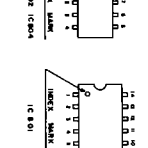
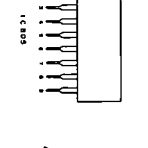
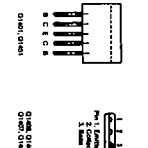
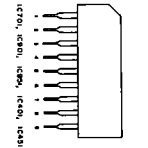
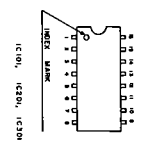
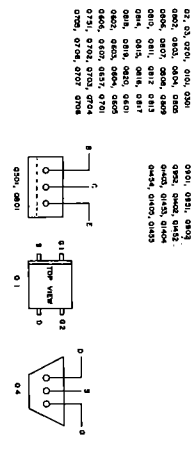
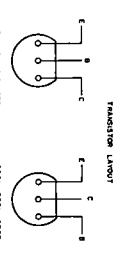

NOTES

- 1) Many transistors used in these models are identified by "KS" in place of the more familiar "2S" prefix. Generally these parts are electrically interchangeable. However, when replacing the SMALL SIGNAL devices, please observe proper transistor basing.
- 2) Pushbutton switch banks are available as a complete assembly or as individual sections. It is suggested that individual sections be replaced rather than the entire assembly. Therefore when ordering, specify both part number for assembly and describe individual section by its front panel function.
- 3) When ordering replacement parts please give complete information as listed in the parts list section. In addition, please note the unit model number.
- 4) Power transformer part numbers may vary from those listed here, therefore please give part number of old transformer as well as all information from parts list herein.
- 5) Input power of typical unit, properly adjusted at 120V line, volume minimum, switched to FM is 35 watts, 0.5A.

SCOTT 385R EXPLODED VIEW

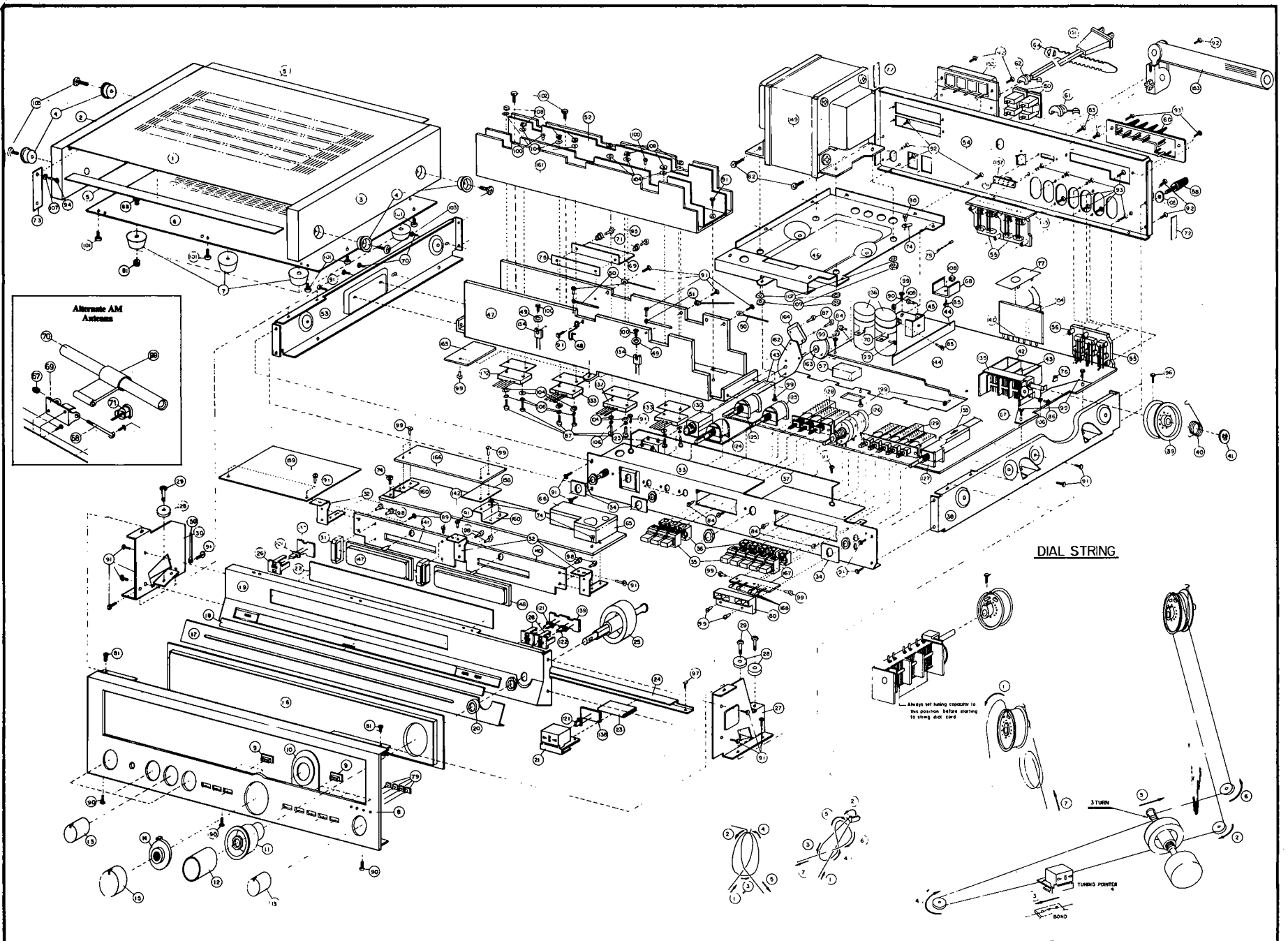

**REPLACEMENT LIST OF MECHANICAL AND ELECTRO MECHANICAL PARTS—
REFER TO 385R EXPLODED VIEW**

| SYMBOL | PART NO. | DESCRIPTION | SPECIFICATION | USED IN |
|---------------|-----------------|--------------------|----------------------|----------------|
| 1 | 6102-502-8101 | CABINET | 1.0T VINYL STEEL | ALL |
| 2 | 6103-500-3107 | SIDE-CABINET-L | 15T PLYWOOD VINYL | ALL |
| 3 | 6103-500-4102 | SIDE-CABINET-R | 15T PLYWOOD VINYL | ALL |
| 4 | 7334-500-1106 | WASHER-CABINET | P.P BLACK | ALL |
| 5 | 6804-502-2206 | SPACER-CABINET | 1.0 HIMERONE SHEET | ALL |
| 6 | 6022-505-6107 | CHASSIS-BOTTOM | 1.0T SPC-1 FZY | ALL |
| 7 | 6074-500-2101 | FOOT | RUBBER | ALL |
| 8 | 7702-507-7100 | PANEL-FRONT | AL EXTRU | 355R |
| 8 | 7702-507-7207 | PANEL-FRONT | AL EXTRU | 375R |
| 8 | 7702-507-7304 | PANEL-FRONT | AL EXTRU | 385R |
| 9 | 6463-500-7106 | GUIDE-KNOB "F" | ABS GREY | ALL |
| 10 | 7714-504-7207 | PLATE-BACK VOL. | 0.8T ALS | ALL |
| 11 | 7603-502-1109 | MASK-TUNING | ABS GREY | ALL |
| 12 | 7724-507-7104 | KNOB-TUNING | ALB ALUMITE | ALL |
| 13 | 7724-505-6103 | KNOB-ROTARY | ALB ALUMITE | ALL |
| 14 | 7724-506-0106 | KNOB-BALANCE | 94HB ACRYL CLR | ALL |
| 15 | 7724-503-7108 | KNOB-VOLUME | ALB ALUMITE | ALL |
| 16 | 7653-501-4106 | DIAL WINDOW | 5.0T ACRYL CLR | ALL |
| 17 | 8012-504-1106 | SCALE-DIAL | 0.5T ALS OFFSET | 355R |
| 17 | 8012-504-1203 | SCALE-DIAL | 0.5T ALS OFFSET | 375R |
| 17 | 8012-504-1300 | SCALE-DIAL | 0.5T ALS OFFSET | 385R |
| 18 | 8014-502-7104 | BLIND-SCALE | ACRYL 0.5T×373×13 | ALL |
| 19 | 8012-504-0208 | SCALE-BACK | 1.0T SPC-1 MET GRY | 355R |
| 19 | 8012-504-0101 | SCALE-BACK | 1.0T SPC-1 MET GRY | 375R |
| 19 | 8012-504-0305 | SCALE-BACK | 1.0T SPC-1 MET GRY | 385R |
| 20 | 6834-506-6103 | SPACER | RUBBER 3.5T | ALL |
| 21 | 8003-500-4101 | CAP-POINTER | ABS BLK | ALL |
| 22 | 7654-503-3104 | FILTER-WINDOW | ACRYL 0.5T | 355R |
| 22 | 7653-503-0102 | FILTER-WINDOW | ACRYL 0.5T | 375R |
| 22 | 7653-503-0209 | FILTER-WINDOW | ACRYL 0.5T | 385R |
| 23 | 0859-141-6008 | TEFLON TAPE | W 25.4×33Y×0.8T | ALL |
| 24 | 6613-506-1105 | BRKT-GUIDE PNTR | 0.8T SPCY-1 FZW | ALL |
| 25 | 5104-509-1100 | SHAFT-TUNING | MB R2 GC10 | ALL |
| 26 | 6603-500-6107 | HOLDER-LED,S | ABS NATURAL | ALL |
| 27 | 6614-583-2106 | BRACKET, SCALE, R | 1.0T SPC-1 FZW | ALL |

| SYMBOL | PART NO. | DESCRIPTION | SPECIFICATION | USED IN |
|--------|---------------|-------------------|-----------------|------------|
| 28 | 5214-501-3104 | PULLY GUIDE | PA WHITE | ALL |
| 29 | 7394-500-5106 | SHAFT GUIDE | FE FZY | ALL |
| 30 | 6613-504-3109 | BRACKET, SCALE L | 1.0T SPC-1 FZW | ALL |
| 31 | 6603-101-2104 | HOLDER-DIGITRON | PS H/T 100% | 355R, 375R |
| 31 | 6603-101-3105 | HOLDER-FL | ABS BLACK | 385R |
| 32 | 6614-587-4108 | BRKT-PWB (F) | 1.2T S PC-1 FZW | ALL |
| 33 | 6022-505-5104 | CHASSIS-FRONT | 1.0T SPC-1 FZY | 355R |
| 33 | 6022-505-5102 | CHASSIS-FRONT | 1.0T SPC-1 FZY | 375R |
| 33 | 6022-505-5209 | CHASSIS-FRONT | 1.0T SPC-1 FZY | 385R |
| 34 | 7604-502-1109 | MASK-KNOB | 0.5T HIMERONE | ALL |
| 35 | 7723-500-5106 | KNOB-PUSH "F" | ABS | ALL |
| 36 | 6463-500-1106 | GUIDE-KNOB | PE SOFT NAT | ALL |
| 37 | 6654-507-9105 | SUPPORT-G POINTER | STS P1 1.0 | ALL |
| 38 | 6023-502-1100 | FRAME-R | 1.2T SPC-1 FZY | ALL |
| 39 | 5223-500-6104 | WHEEL-DRUM | ABS NATURAL | ALL |
| 40 | 6674-510-2100 | SPRING, DIAL | STS P1 1.0 | ALL |
| 41 | 6674-508-6103 | STOP-SPRING | SPS-27 0.3T | ALL |
| 42 | 4543-500-8102 | SHIELD FENCE | 0.3T TE SBC | ALL |
| 43 | 4544-503-1103 | SHIELD PLATE-T | 0.3T TE SBC | ALL |
| 44 | 4544-503-0108 | SHIELD PLATE-P | 0.3T TE-SBC | ALL |
| 45 | 5684-501-1101 | HEAT SINK, TR | 1.5T ALS | ALL |
| 46 | 6613-506-0100 | BRACKET, TRANS | 1.2T SPC-1 FZY | ALL |
| 47 | 5682-502-2105 | HEAT SINK | 2.5T ALS | ALL |
| 48 | 6654-507-8100 | SUPPORT-B PNTR | STS P1 1.0 | ALL |
| 49 | 6844-503-1201 | WASHER-CABINET | 0.8T FIBER | ALL |
| 50 | 6634-105-6409 | CLAMPER-WIRE | 0.5T SPC-1 FZY | ALL |
| 51 | 6634-100-1904 | CLAMPER-WIRE | SPC-1 0.6 TFT | ALL |
| 52 | 5683-501-3104 | HEAT SINK A | 2.0T ALS | 355R |
| 52 | 5682-501-1207 | HEAT SINK SUB | 1.5T ALS | 375R, 385R |
| 53 | 6023-502-0100 | FRAME-L | 1.2T SPC-1 FZY | 355R |
| 53 | 6023-502-0105 | FRAME-L | 1.2T SPC-1 FZY | 375R, 385R |
| 54 | 6022-505-4107 | CHASSIS, REAR | 1.0T SPC-1 BLK | 355R |
| 54 | 6022-505-4204 | CHASSIS, REAR | 1.0T SPC 1 BLK | 375R |
| 54 | 6022-505-4505 | CHASSIS, REAR | 1.0T SPC 1 BLK | 385R |
| 55 | 3339-543-0105 | JACK, AUX | ABS & 4P BLK | ALL |
| 56 | 3339-543-0202 | JACK, AUX | ABS & 2P BLK | ALL |

| SYMBOL | PART NO. | DESCRIPTION | SPECIFICATION | USED IN |
|--------|---------------|-----------------|---------------------|------------|
| 57 | 6834-502-0101 | SPACER | 1.0T×30×25 RUBBER | ALL |
| 58 | 3104-501-6109 | TERMINAL, SCREW | ABS | ALL |
| 59 | 7304-100-2100 | WASHER-PLAIN | 0.5T×3.5×7P1 FE FZY | ALL |
| 60 | 3303-500-1100 | TERMINAL BD | 5T SCREW ABS BLK | ALL |
| 61 | 6634-100-8103 | CLAMPER, CORD | HEYCO SR4N4 | ALL |
| 62 | 6634-100-7108 | CLAMPER, CORD | HEYCO SR 3P4 | ALL |
| 63 | 3304-501-6105 | TERM BD PUSH | DRP 0.03 4P | ALL |
| 64 | 6634-101-8106 | BAND, CORD WIRE | P.P BLACK | ALL |
| 65 | 4543-500-9107 | SHIELD-FENCE FL | 0.3T TE-S BC | 375R, 385R |
| 65 | 6603-103-7105 | HOLDER-LED | ABS NAT | 355R |
| 66 | 4543-501-0105 | CAP-SHIELD, FL | 0.3T TE-SBC | 375R, 385R |
| 66 | 6834-503-5109 | MASK, LIGHT T | RUBBER, SPONGE 6T | 355R |
| 67 | 6634-100-6103 | BAND WIRE | P.P BLK | 355R |
| 67 | 6613-506-4207 | BRKT-PROT PWB | 0.8T SPC-1 FZY | 375R, 385R |
| 68 | 4544-502-2105 | SHIELD CAP-2 | TE-SBC 0.3T | 355R |
| 68 | 5684-502-8109 | HEATSINK, DIODE | ALS 1.5T | 375R, 385R |
| 69 | 3124-100-7105 | TAP-STUD | 0.5T SPC-1 BT 2 | 355R |
| 69 | 6614-591-6101 | BRKT-BAND CAP | 1.2T SPC-1 FZY | 375R, 385R |
| 70 | 3114-102-4208 | LUG | 0.3T TE-S BC | 355R |
| 70 | 6634-102-7201 | BAND-CAP | 0.8T SPC-1 FZY | 375R, 385R |
| 71 | 4544-500-5104 | SHIELD FENCE | TE-SBC 0.3T | 355R |
| 71 | 3934-103-1103 | INSUL-TR | NYLON 66 | 375R, 385R |
| 72 | 6804-502-8106 | SPACER-CAB | 0.5T HIMERONE | 375R, 385R |
| 73 | 4544-500-5104 | SHIELD-FENCE | TE-SBC 0.3T | 375R, 385R |
| 74 | 3114-102-4208 | LUG | 0.3T T TE-SBC | 375R, 385R |
| 75 | 3934-500-7100 | INSULATOR PLATE | 1.0T FIBRE | 375R, 385R |
| 76 | 3124-100-7105 | TAP-STUD | 0.5T SPC-1 BT2 | 375R, 385R |
| 77 | 4544-502-2105 | SHIELD CAP-2 | TE-SBC 0.3T | 375R, 385R |
| 78 | 6634-100-6103 | BAND WIRE | P.P BLK | 375R, 385R |
| 79 | 7654-565-3106 | INDICATOR-SEL | ACRYL CLEAR | 385R |
| 80 | 6604-513-2104 | HOLDER-LED | RUBBER, 94V-OW | 385R |
| 81 | 7018-130-0815 | SCREW-FH | + M3×8FE FZY | ALL |
| 82 | 7028-140-1010 | SCREW-TH | + M4×10 FE FZY | ALL |
| 83 | 7048-126-0437 | SCREW-RH | + M2.6×4 FE FZY | ALL |
| 84 | 7048-130-0616 | SCREW-RH | + M3×6 FE FZY | ALL |

| SYMBOL | PART NO. | DESCRIPTION | SPECIFICATION | USED IN |
|--------|---------------|------------------|----------------------|--------------|
| 85 | 7048-130-1213 | SCREW-RH | + M3×12 FE FZY | 375R, 385R |
| 85 | 7048-130-1019 | SCREW-RH | + M3×10 | 355R |
| 86 | 7048-130-0412 | SCREW-RH | + M3×4 FE FZY | ALL |
| 87 | 7048-130-1514 | SCREW-RH | + M3×15 FE FZY | ALL |
| 88 | 7048-130-1019 | SCREW-RH | + M3×10 FE FZY | 375R, 385R |
| 89 | 7148-130-0619 | SCREW-TAP, RH | 1-3×6 FE FZY | ALL |
| 90 | 7148-530-0615 | SCREW-TAP RH | 2S-3×6 FE FZY | ALL |
| 91 | 7148-530-0819 | SCREW-TAP RH | 2S-3×8 FE FZY | ALL |
| 92 | 7148-530-0837 | SCREW-TAP RH | 2S-3×8 FZB | ALL |
| 93 | 7148-130-0831 | SCREW-TAP RH | 1-3×8 FZB | ALL |
| 94 | 7148-130-1012 | SCREW-TAP RH | 1-3×10 FZB | ALL |
| 95 | 7148-530-1212 | SCREW-TAP RH | 2S-3×12 FZY | 355R |
| 95 | 7148-530-1018 | SCREW-TAP RH | 2S-3×10 FZY | 375R, 385R |
| 96 | 7148-530-1212 | SCREW-TAP RH | 2S-3×12 FZY | 375R, 385R |
| 97 | 7158-530-0832 | SCREW-TAP BH | 2S-3×8FE FZB | ALL |
| 98 | 7098-130-0611 | SCREW-FLANGE, RH | + M3×6 FE FZY | ALL |
| 99 | 7154-100-6303 | SCREW-TAP RH | 2S-3×8 FE FZY | ALL |
| 100 | 7154-100-6701 | SCREW-TAP RH | 2S-3×2 FE FZY | ALL |
| 101 | 7128-540-0810 | SCREW-TAP TH | 2S-4×8 FE FZY | ALL |
| 102 | 7128-540-1213 | SCREW-TAP TH | 2S-4×12 FE FZY | ALL |
| 103 | 7128-540-2032 | SCREW-TAP TH | 2S-4×20 FZB | ALL |
| 104 | 7304-100-2100 | WASHER-PLAIN | 0.5T×3.5×7.5P1 | ALL |
| 105 | 7304-500-2106 | WASHER-PLAIN | 4.5 P1×100 P1×1.5T | ALL |
| 106 | 7318-103-0014 | WASHER-SPRING | PI3.0 (3.1×5.9×0.7T) | ALL |
| 107 | 7328-204-0011 | WASHER-TOOTHED | BPI (4.3×8.5×T0.45 | ALL |
| 108 | 7208-113-0017 | NUT-HEX | 1M3 FE FZY | ALL |
| 109 | 7208-114-0010 | NUT-HEX | 1M4 FE FXY | ALL |
| 121 | 2309-120-0102 | LED-SQUARE | LN 217 RPL | ALL |
| 122 | 2309-119-0108 | LED-SQUARE | LN 317 GP | ALL |
| 123 | 3509-501-0203 | SWITCH-SPK/PWR | SFR 2045/SDRIR | 355R, 375R* |
| 123 | 3509-501-0504 | SWITCH-SPK/PWR | SFR 20451/SDR3R | 355R, 375R* |
| 123 | 3509-201-1502 | SWITCH-SPK | SRF 485 | 355R, 385R** |
| 123 | 3509-501-0708 | SWITCH-SPK | SRF 4078 | 385R |
| 124 | 1219-108-0105 | VR-BASS | GMPE 20FM7C100K | 355R |
| 124 | 1269-111-1503 | VR-BASS | GMPE 20FM7C100K | 375R, 385R |
| 125 | 1269-111-1309 | VR-MID/TREB | GM70E 20FM7C100K | 355R |

*Early production, grey power switch.

**Later production using micro switch, see items 162, 163, 164.

| SYMBOL | PART NO. | DESCRIPTION | SPECIFICATION | USED IN |
|---------|--|--------------------|-------------------|------------|
| 125 | 1269-111-1406 | VR-MID/TREB | GM70E 20F C100K | 375R, 385R |
| 126 | 1299-102-0107 | VR-VOL | FJ60E 2SFM11 | 355R |
| 126 | 1299-102-0204 | VR-VOL | FJ60E W250K/B100K | 375R, 385R |
| 127 | 3509-201-0507 | SW-ROT-SLIDE | SRZ VO45N | 355N |
| 127 | 3509-501-0106 | SW-ROT-SLIDE | SRZW045N | 375R, 385R |
| 128 | 3529-203-1702 | SW-PUSH, FIL/LOUD | SUF32 4C-4C, 2C | ALL |
| 129 | 3529-203-1809 | SW-PUSH, MODE-TAPE | SUF52 2C×29 | ALL |
| 130 | 3339-511-0203 | JACK-EARPHONE | HLJ0290-01-020 | ALL |
| 132 | SEE TRANSISTOR LIST | | | ALL |
| 133 | SEE TRANSISTOR LIST | | | ALL |
| 134 | 2189-105-1007 | VARISISTOR-STV3H | 7MA 1.6-1.8V | ALL |
| 135 | 1809-400-0101 | VARICON-AIR | C774J | ALL |
| 136 | SEE CAPACITOR LIST | | | ALL |
| 137-146 | PCB ASSYS ARE GENERALLY NOT AVAILABLE FOR REPLACEMENT* | | | |
| 147 | 2319-101-0302 | DIGITRON-PWR | BG 32 | 355R |
| 147 | 2319-101-0409 | DIGITRON-PWR | BG 60 | 375R |
| 147 | 2319-101-0506 | DIGITRON-PWR | FIP 12AW 12YS | 385R |
| 148 | 2309-117-0102 | LED METER | LNO5202P | 355R |
| 148 | 2319-101-0205 | DIGITRON-FREQ | 7-LT-08 | 375R, 385R |
| 149 | 2869-197-9003 | TRANS-PWR | W/O SENSOR | 355R |
| 149 | 2869-197-7031 | TRANS-PWR | W/SENSOR | 355R |
| 149 | 2869-197-9100 | TRANS-PWR | | 375R |
| 149 | 2869-198-0108 | TRANS-PWR | | 385R |
| 150 | 3334-500-1005 | JACK-AC OUTLET | 125V 15A S-16444 | ALL |
| 151 | 3053-806-3101 | POWERCORD, AC | STP1 18 BLK | ALL |
| 152 | 3304-501-6105 | TERM BD, PUSH | DRP 003 4P | ALL |
| 153 | SEE PARTS LIST UNDER COILS | | | ALL |
| 154 | 3519-501-0509 | SWITCH-INPUT SEL | SSR 22602D | 375R, 385R |
| 155 | 3349-519-9100 | SW, DENTENT, FLEX | SWR 6300 | 375R, 385R |
| 156 | DEEMPHASIS PWB—NOT AVAILABLE | | | ALL |
| 157 | 3519-201-0609 | SW, SLIDE, DEEMP | SSB 023N | ALL |
| 158 | 3934-501-110 | INSULATOR, FIB-A | 0.8T×45×52 | 385R |
| 159 | 3934-501-2108 | INSULATOR, FIB | 1.0T×160×72 | 385R |
| 160 | 6614-595-4103 | BRKT-BWB, S | 1.2T SPC-1 FZY | 385R |
| 161 | 5682-501-5107 | HEATSINK, B | 2.0T ALB BLK | 385R |

*Check with service manager for possible limited availability of used assemblies.

| SYMBOL | PART NO. | DESCRIPTION | SPECIFICATION | USED IN |
|--------|---------------|-------------------|--------------------|------------------|
| 162 | 6614-592-9109 | BRKT PWR, SW | 1.0T SPC-1 FZY | 385R |
| 163 | 5244-500-3106 | CAM-S/W | 2.0T SPC-1 FZY | 385R |
| 164 | 3599-902-020 | SW/PWR | SDR3R | 355R, 375R* |
| 164 | 3579-101-0105 | MICRO SW | AH 715457 | 355R, 375R, 385R |
| 165 | 3014-528-9109 | PWB, THERM PROT | CHECK AVAILABILITY | 385R |
| 166 | 3013-507-8102 | PWB, DRIVE, FL | CHECK AVAILABILITY | 385R |
| 167 | 3014-529-0107 | PWB, LED FUNCTION | CHECK AVAILABILITY | 385R |
| 168 | 2309-101-4103 | LED | LD 30A RED 3 P1 | 385R |

*Used in early production. (Grey pwr sw only).

DIODES

| SYMBOL | PART NO. | DESCRIPTION | SPECIFICATION | USED IN |
|---------------------|---------------|-------------------|-------------------|---------------------|
| CR801 | 2309-119-0108 | LED-SQUARE | LN 317 GP | ALL |
| CR301, CR603 | 2309-120-0102 | LED-SQUARE | LN 217 RP | ALL |
| CR512, CR825 | | | | |
| CR716, CR717 | 2309-101-4103 | LED | LD30 A RED 3PI | ALL |
| CR718 | | | | |
| | 2309-104-2102 | LED-DELTA | SLP 239B | 355R Pointer |
| SEE SCHEMATIC | | | | |
| ALL MODELS | 2169-301-2901 | DIODE, SWITCHING | 1SS53 | See Schematic |
| CR-1 | 2169-501-1603 | DIODE, AFC | KS3302, 4-7.5PF | ALL |
| CR507, CR508 | 2169-404-2200 | DIODE-ZN WZ220 | 50MW 20.8-22.3V | ALL Δ |
| CR501, CR502 | 2169-201-0504 | DIODE, RECTIFIER | IN4001, 1A, 50V | ALL Δ |
| CR503, CR504 | 2169-201-1509 | DIODE, RECTIFIER | IN4142, 3A 400V | 355R Δ |
| CR505, CR506 | | | | |
| CR509, CR510, CR601 | 2169-201-0601 | DIODE, RECTIFIER | IN4002, 1A 100V | ALL Δ |
| CR511 | 2169-403-9202 | DIODE-ZN, BZ150 | IW 13.8-15.6V | ALL Δ |
| CR902 | 2169-404-1409 | DIODE-ZN, WZ-061 | 50MW 5.6-6.5V | 375R, 385R Δ |
| CR901 | 2169-404-6103 | DIODE-ZN Wz120 | 500MW, 11,4-12.6V | 375R, 385R Δ |
| CR608, CR1401 | 2189-105-1007 | VARISTOR-STV 3H | 7MA 1.6-1.8V | ALL Δ |
| CR1451 | | | | |
| CR1402, CR1403 | 2169-201-0708 | DIODE, RECTIFIER | IN4003, 1A, 200V | ALL Δ |
| CR1452, CR1453 | | | | |
| CR1404, CR605 | 2169-403-2207 | DIODE, ZN, WZ-182 | 50MW, 16.8-19.1V | ALL Δ |
| CR810, CR811 | 2169-101-1403 | DIODE, GER, IN60 | IR 15UA | 355R, 375R |
| CR860, CR861 | | | | |

FUSES

| SYMBOL | PART NO. | DESCRIPTION | SPECIFICATION | USED IN |
|------------|---------------|-------------|-----------------------|---------------------|
| F505 | 4709-031-4004 | FUSE | NOR 125V 6A, 31, 8 UL | 375R, 385R Δ |
| F505 | 4709-031-3106 | FUSE | NOR 125V 5A, UL | 355R Δ |
| F801 | 4709-133-1402 | FUSE W/LEAD | SLO 125/250 0.5A UL | ALL Δ |
| F501, F502 | | | | |
| F503, F504 | 4709-131-3309 | FUSE W/LEAD | NOR 125V, 8A UL | ALL Δ |

INTEGRATED CIRCUITS

| SYMBOL | PART NO. | DESCRIPTION | SPECIFICATION | USED IN |
|--------------|---------------|----------------|---------------|---------------------|
| IC701 | 2119-101-4500 | IC | TA 7318P | 385R |
| IC806 | 2119-201-1300 | IC-DISPLAY | LC 7555 | 355R, 375R |
| IC702 | 2119-201-3203 | IC-DISPLAY | LC 7556 | 385R |
| IC101 | 2119-201-0907 | IC-AM IF | HA 1197 | ALL |
| IC201 | 2119-201-0402 | IC-FM IF | HA 1137W | ALL |
| IC301 | 2119-201-1106 | IC-MPX | HA 1196 | ALL |
| IC901, IC951 | 2119-401-0206 | IC-OP | TA 7322P | ALL |
| IC401, IC451 | | | | |
| IC801 | 2119-601-0301 | IC-REG | LA 5700 | 375R, 385R Δ |
| IC802 | 2119-601-0204 | IC-PRESCALER | SP 8629 | 375R, 385R |
| IC803 | 2119-201-1203 | IC-FREQ. DISP. | LC 7258 | 375R, 385R |
| IC804 | 2119-401-0303 | IC-OP | NJM 4558 DD | ALL |
| IC805 | 2119-201-2004 | IC-SIG | BA 6104 | ALL |

RESISTORS SAFETY, CRITICAL COMPONENTS Δ AND SPECIALTY ITEMS.

| SYMBOL | PART NO. | DESCRIPTION | SPECIFICATION | USED IN |
|------------------|---------------|---------------|---------------|--------------|
| R214, R312 | 1249-102-0908 | VR-SEMI | SR19R B220K | ALL |
| R226 | 1249-102-0403 | VR-SEMI | SR19R B22K | ALL |
| R303, R808, R809 | 1249-102-0306 | VR-SEMI | SR19R B10K | ALL |
| R861, R877 | | | | |
| R1412, R1462 | 1249-102-0102 | VR-SEMI | SR19R B470 | ALL |
| R627, R803 | 1249-102-1000 | VR-SEMI | SR19R B2.2K | ALL |
| R835, R705 | 1249-102-0209 | VR-SEMI | SR19R B4,7K | ALL |
| R755 | | | | |
| R886 | 1249-102-0704 | VR-SEMI | SR19R B100K | 375R |
| R504, R505 | 1049-301-3106 | R-METAL OXIDE | RSIP 3.3K-K | ALL Δ |
| R709 | | | | |
| R506, R507 | 1049-301-2402 | R-METAL OXIDE | RSIP 820-K | ALL Δ |
| R509 | 1049-105-2202 | R-METAL OXIDE | RS3P 560K | ALL Δ |
| R1407, R1457 | 1049-301-0101 | R-METAL OXIDE | RSIP 10K | |
| R1408, R1458 | | | | |
| R1422, R1472 | | | | |
| R1413, R1463 | 1049-301-1300 | R-METAL OXIDE | RSIP 100-K | ALL Δ |
| R1424, R1474 | | | | |
| R1417, R1467 | | | | |
| R1418, R1468 | 1049-301-1504 | R-METAL OXIDE | RSIP 150-K | ALL Δ |

CRITICAL COMPONENTS Δ

| SYMBOL | PART NO. | DESCRIPTION | SPECIFICATION | USED IN |
|--------------|---------------|---------------|---------------|------------|
| R1421, R1471 | 1049-315-0104 | R-METAL OXIDE | RS2P 10J | ALL |
| R1422, R1472 | 1049-315-0104 | R-METAL OXIDE | RS2P 10J | 385R Only |
| R1423, R1473 | 1049-103-2002 | R-METAL OXIDE | RS2P 390-K | 375R, 385R |
| R612 | 1049-105-1906 | R-METAL OXIDE | RS3P 330-K | 385R |
| R613 | 1049-103-2400 | R-METAL OXIDE | RS2P 820-K | 385R |
| R612 | 1049-103-1803 | R-METAL OXIDE | RS2P 270-K | 375R, 355R |
| R1423, R1473 | 1049-103-1900 | R-METAL OXIDE | RS2P 330-K | 355R |
| R613 | 1049-301-2402 | R-METAL OXIDE | RS1P 820-K | 355R, 375R |
| R1422, R1472 | 1049-301-0101 | R-METAL OXIDE | RS1P 10K | 355R, 375R |
| R1419, R1469 | 1035-905-0908 | R-CEMENT WIRE | RW5P 0.47K | ALL |
| R1420, R1470 | | | | |

TRANSISTORS

NOTE! TRANSISTORS ARE CONSIDERED CRITICAL COMPONENTS FOR SAFETY AND RELIABILITY REPLACEMENT PARTS MUST BE SAME TYPE OR EQUIVALENT

| SYMBOL | PART NO. | DESCRIPTION | SPECIFICATION | USED IN |
|--|---------------|-------------|---------------|------------|
| Q2, Q3 | 2139-301-0508 | TRANSISTOR | KSC 1674-0 | ALL |
| Q101, Q201 | 2139-301-8508 | TRANSISTOR | KSA 838-0 | ALL |
| Q202, 603, 604 606, 607, 657 802, 803, 808 809, 810, 811 812, 813, 814 815, 816, 817 818, 819, 820 | 2139-302-7409 | TRANSISTOR | KSA 945-Y | ALL |
| Q701, 751 | 2139-302-7409 | TRANSISTOR | KSA 945-Y | 385R |
| Q501 | 2149-401-2609 | TRANSISTOR | KSD 288-Y* | ALL |
| Q801 | 2149-401-2609 | TRANSISTOR | KSD 288-0 | 375R, 385R |
| Q1401, 1451 | 2139-901-0104 | TRANSISTOR | KSA 798G | ALL |
| Q1402, 1452 1403, 1453 1407, 1457 | 2149-102-6304 | TRANSISTOR | KSA 965 Y | ALL |
| Q1404, 1454 1405, 1455 | 2149-304-6405 | TRANSISTOR | KSC 2235 Y | ALL |
| Q1406, 1456 | 2149-304-6405 | TRANSISTOR | KSC 2235 Y | 355R |
| Q1406, 1456 | 2149-403-3309 | TRANSISTOR | KSD 669 A-B | 375R, 385R |
| Q1407, 1457 | 2149-201-7606 | TRANSISTOR | 2SB 649 A-B | 375R, 385R |
| Q1408, 1458 | 2149-101-6107 | TRANSISTOR | KSA 1187 Y | 375R |
| Q1408, 1458 | 2149-301-3207 | TRANSISTOR | KSC 2579 Y | 355R |
| Q1408, 1458 | 2149-301-7605 | TRANSISTOR | KSC 2921 Y | 385R |
| Q1409, 1459 | 2149-201-0300 | TRANSISTOR | 2SA 1187 | 375R |
| Q1409, 1459 | 2149-101-3209 | TRANSISTOR | KSA 1104 Y | 355R |
| Q1409, 1459 | 2149-101-3607 | TRANSISTOR | KSA 1215 Y | 385R |
| Q901, 951 | 2139-103-8603 | TRANSISTOR | KTA 970 BL | 375R, 385R |
| Q902, 952 | 2139-305-6704 | TRANSISTOR | KTC 2240 BL | 375R, 385R |
| Q601, 602 | 2139-103-7103 | TRANSISTOR | KSA 708 Y | ALL |
| Q605, 804 805, 806 | 2139-103-3802 | TRANSISTOR | KSA 733 Y | ALL |
| Q702, 703 704 | 2139-103-3802 | TRANSISTOR | KSA 733 Y | 385R |
| Q608, 609 | 2149-301-3409 | TRANSISTOR | KSC 1008 Y | 385R |
| Q1 | 2139-601-4806 | FET | 3SK 73 GR | ALL |
| Q4 | 2139-601-0301 | FET | 2SK 212 | 375R, 385R |

*Changed from D2880 to D288Y during production, D288Y is specified.

AM ANTENNA, SEE EXPLODED VIEW INSERT

| SYMBOL/ EXP. VIEW NO. | PART NO. | DESCRIPTION | SPECIFICATION | USED IN |
|--------------------------|---------------|--------------------|-----------------|---------|
| 67 | 7224-100-9102 | NUT-HEX, CAP | FE ENI | ALL |
| 68 | 7044-100-1106 | SCREW-RH | FE-FNI | ALL |
| 69 | 6614-117-3100 | BRACKET-ANT BAR | 1.0T SPC-1 FZB | ALL |
| L101/70 | 2509-305-1016 | COIL-ANT MW W/CORE | CORE 10 PIX 120 | ALL |
| 99 | 6634-106-4101 | BAND-BAR ANT | 94HB ABS BLACK | ALL |

COILS, TRANSFORMERS, FILTERS & MISC.

| SYMBOL | PART NO. | DESCRIPTION | SPECIFICATION | USED IN |
|------------------|---------------|---------------------|----------------------|------------|
| L2, L3 | 2509-106-2104 | COIL, FM ANT | TR-A7JZ004S | ALL |
| L1 | 2519-106-3104 | COIL, FM ANT | TR-A7JZ002S | ALL |
| L4, L202, L103 | 2429-040-0302 | COIL, CHOKE | 2.2UH-K Q30 | ALL |
| L5 | 2539-107-3107 | COIL-FM OSC | TR-A7JZ003S | 355R, 375R |
| L5 | 2539-108-4105 | COIL-FM OSC | CFOR 12 P1010 | 385R |
| L201 | 2429-020-0708 | COIL-CHOKE | 18 UH-K Q30 F2R5 | ALL |
| L102 | 2619-511-7093 | COIL-RF, AM | 340UH A-BASE | ALL |
| L1401, 1451 | 2429-060-0401 | COIL, CHOKE SPKR | 2R5UH-KQ50 | ALL |
| T101*** | 2619-010-4027 | COIL, OSC MW | 150UH A BASE | ALL |
| T103 | 2749-118-0204 | TRANS-IF, AM | 7MM CAN | ALL |
| T102 | 4529-313-0106 | FILTER-CER, AM | 7MM CAN | ALL |
| T201 | 2739-501-0203 | COIL-FM, MIX | TRIO MMA002S | ALL |
| T202 | 2739-503-0102 | TRANS-FM, IF | TRIO MM 013M | ALL |
| T203 | 2739-501-0300 | TRANS-FM, IF | TRIO MM 014M | ALL |
| LF301, 351 | 4529-415-0509 | FILTER, LP | 208 BLR 315 7R | ALL |
| L101* | 2509-205-1309 | COIL-ANT, AM W/CORE | CORE 10 PIX 120 | 355R, 375R |
| L101** | 2509-305-1016 | COIL-ANT, MW W/CORE | CORE 10 PIX 120 | ALL |
| Y801 | 4539-501-0403 | CRYSTAL | HC-18/U, 4.0 MHz | 375R, 385R |
| L6 | 2509-105-5106 | BALUN | TV750301A2 | ALL |
| K601 | 4724-100-1201 | RELAY, PROTECT | MS4U DC24V 30MA | ALL |
| | 3519-201-0609 | SWITCH, SLIDE | SSBO23N (Deemphasis) | ALL |
| CF 201, 202, 203 | 4529-309-0103 | FILTER, CERAMIC | SFE 10.7 MA8 | ALL |

*Used in early production, and shown on exploded view.

**Used in later production, see insert.

***Replacement part may be marked 2539-403-0204.

CAPACITORS (SPECIAL OR CRITICAL COMPONENTS)

| SYMBOL | PART NO. | DESCRIPTION | SPECIFICATION | USED IN |
|------------------|---------------|---------------------|-------------------------|---------------------|
| C515 | 1469-502-0706 | CAP-CERAMIC AC | 125 VAC 0.0047 | ALL Δ |
| C120 | 1509-452-1001 | CAP-POLYSTYRENE | CQ09S 50V 330-J | ALL |
| C302 | 1509-452-1108 | CAP-POLYSTYRENE | CQ09S 50V 510-J | |
| C311, C361 | | | | |
| C511, C512 | 1619-018-2701 | CAP-ELECTROLYTIC | 50V 8200M PCB | 355R Δ |
| C511, C512 | 1619-018-3201 | CAP-ELECTROLYTIC | 63V 10000M PCB | 375R, 385R Δ |
| C416, C417, C418 | 1609-802-9908 | CAP-ELECTROLYTIC NP | CEO4W 100V 0.047M | ALL Δ |
| C466, C467, C468 | | | | |
| C315, C365 | 1509-452-1700 | CAP POLYSTYRENE | CQ09S 50V 1100-J | ALL |
| C314, C364 | 1509-452-1302 | CAP POLYSTYRENE | CQ09S 50V 560-J | |
| C1 | 1809-400-0101 | VARICON | C774J | ALL |
| C27 | 1829-511-0104 | C TRIMMER | ECV-12 W06 \times 32E | ALL |

POWER/FREQUENCY DISPLAY CIRCUIT COMPONENTS

| SYMBOL/ EXP. VIEW NO. | PART NO. | DESCRIPTION | SPECIFICATION | USED IN |
|--------------------------|---------------|--------------------|---------------|------------|
| FL801 | 2319-101-0302 | FLUORESCENT TUBE | B6-32 | 355R |
| FL801/147 | 2319-101-0409 | FLUORESCENT TUBE | B6-60 | 375R |
| FL701/147 | 2319-101-0506 | FLUORESCENT TUBE | FIP12AW12YS | 385R, |
| IC806 | 2119-201-1300 | INTEGRATED CIRCUIT | LC7555 | 355R, 375R |
| IC702 | 2119-201-2303 | INTEGRATED CIRCUIT | LC7556 | 385R |
| IC701 | 2119-101-4500 | INTEGRATED CIRCUIT | TA7318P | 385R |
| Q701, Q751 | 2139-302-7409 | TRANSISTOR | KSC945Y | 385R |
| Q702, Q703, Q704 | 2139-103-3802 | TRANSISTOR | KSA733Y | 385R |
| CR701-714, CR751 | 2169-301-2901 | DIODE | 1SS53 | 385R, |
| CR821 | 2169-301-2901 | DIODE | 1SS53 | 355R, 375R |
| R886 | 1249-102-0704 | VR-SEMI | SR19R B100K | 375R |
| C831 | 1509-121-2702 | CAP-POLYESTER | M50V 0.12M-J | 375R |
| CR820 | 2309-117-0102 | LED METER | LN 05202P | 355R |
| CR827, CR828, CR829 | 2169-301-2901 | DIODE | 1SS53 | 355R, 375R |

TROUBLESHOOTING GUIDE

| PROBLEM | POSSIBLE CAUSE | CORRECTION |
|--|---|--|
| <p>FM distortion.</p> <p>Severe frequency jumping, or drift.</p> <p>Oscillation at all levels, all inputs.</p> <p>Display does not light up.</p> | <p>Low B+ supply to FM IF.</p> <p>Defective FM OSC trimmer.</p> <p>12V Reg. transistor Q501 oscillates at VHF band.</p> <p>Check for broken wire or PCB track to FIP or IC.</p> | <p>Verify that Q501 is KSD 288 Y (See parts list).</p> <p>Replace trimmer cap C-27.</p> <p>Increase value of C-509 from 0.001 to 0.047 ceramic disc.</p> <p>Repair as indicated.</p> |
| <p>—NOTE—</p> | | |
| <p>Protection circuit remains activated. (Protection LED ON).</p> | <p>1) Check output bias and offset both channels. Units with temp sensor on transformer and all 385R, check for proper setting.</p> | <p>1) Adjust per test procedure</p> |
| <p>Protection circuit remains activated. (Protection LED ON).</p> | <p>2) A number of production units have been found with a 10 ohm resistor replacing R1417, R1418, R1467 or R1468 causing severe offset.</p> | <p>2) Replace this critical part with factory specified replacement-Adj. bias.</p> |
| <p>Occasional fuzzy sound at low level output.</p> | <p>Oxidized relay contacts.</p> | <p>Verify by shorting across contacts on PCB, clean contacts with strip of clean white paper pulled through contacts under pressure or replace relay.</p> |
| <p>Display frequency stays at 87.5 or very slow AM to FM.</p> | <p>Incorrect setting of regulated supply—IC 801.</p> | <p>Adjust R803 for 7.5-8.0V at Pin 13 of IC801.</p> |
| <p>Poor FM sensitivity, does not switch to stereo.</p> | <p>Defective ceramic filter.</p> | <p>Replace filter with same color code.</p> |
| <p>Thump in speakers when switching through input functions. Noisy tone/volume controls.</p> | <p>Excessive DC offset in IC or leaky coupling/feedback capacitors.</p> | <p>Troubleshoot and replace parts as indicated.</p> |
| <p>355R FM tuning indicator (green pointer LEDS) not operating.</p> | <p>FM detector alignment or defect. Defective component in circuit Q802-Q810 or IC804.</p> | <p>Troubleshoot and replace parts as indicated.</p> |
| <p>Excessive high frequencies in phono mode.</p> | <p>Incorrect equalization or improper cartridge loading.</p> | <p>Check response to R1AA spec. Provide additional cartridge loading 100-300 pF.</p> |
| <p>Output section oscillates under certain speaker load conditions.</p> | <p>Reactive loads causing circuit instability.</p> | <p>Increase value of C 1417 and C1467 from 2 pF to 5pF.</p> |

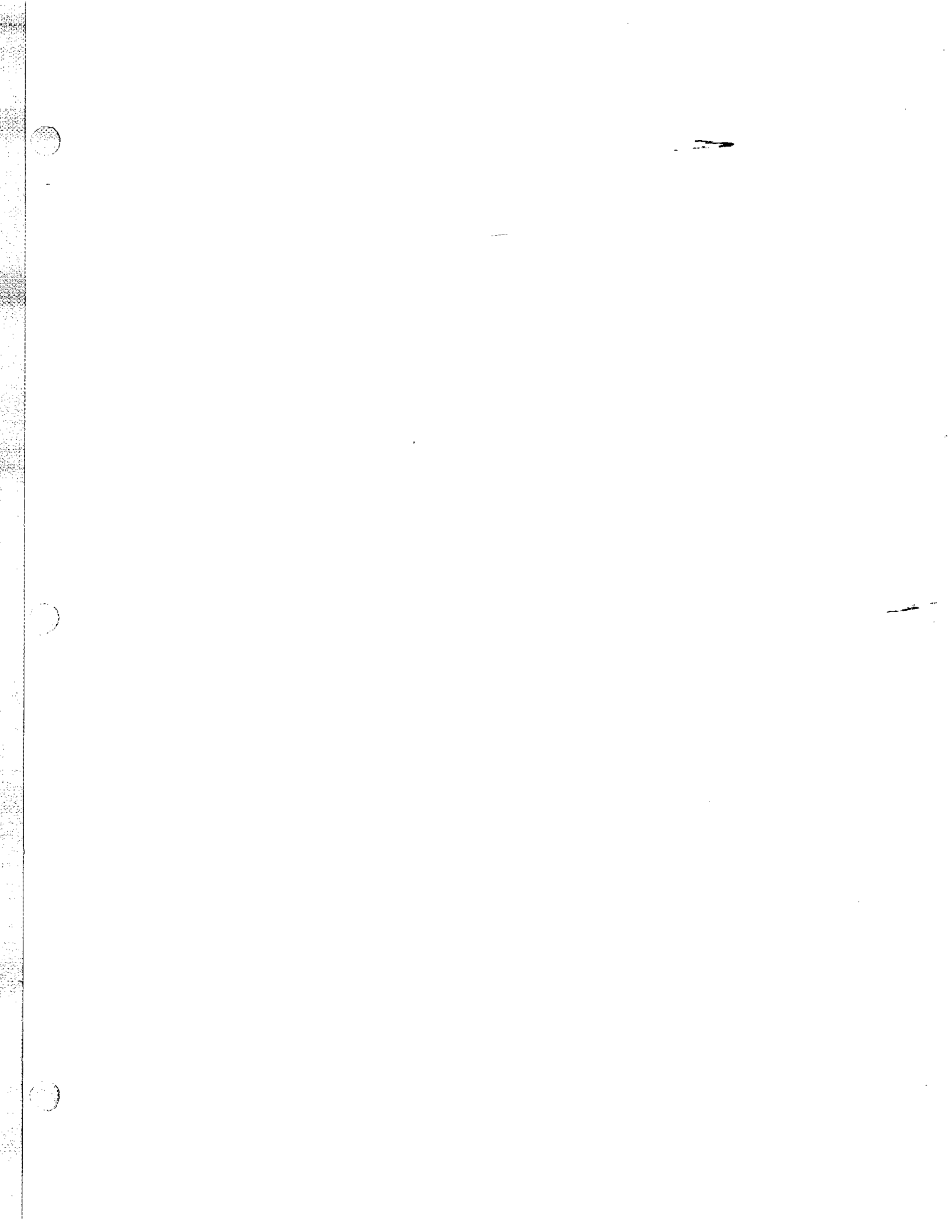

 **SCOTT.**
The Name to listen to.

U.S.A. CORPORATE HEADQUARTERS

H. H. SCOTT INC.

20 Commerce Way

Woburn, MASS. 01801

tel.: 617-933-8800
