

Price \$6.00

Service Manual Integrated Stereo Amplifier

420A



 **SCOTT**[®]
The Name to listen to.

SCHEMATIC DIAGRAM

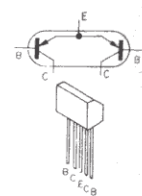
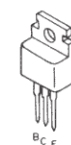
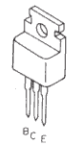
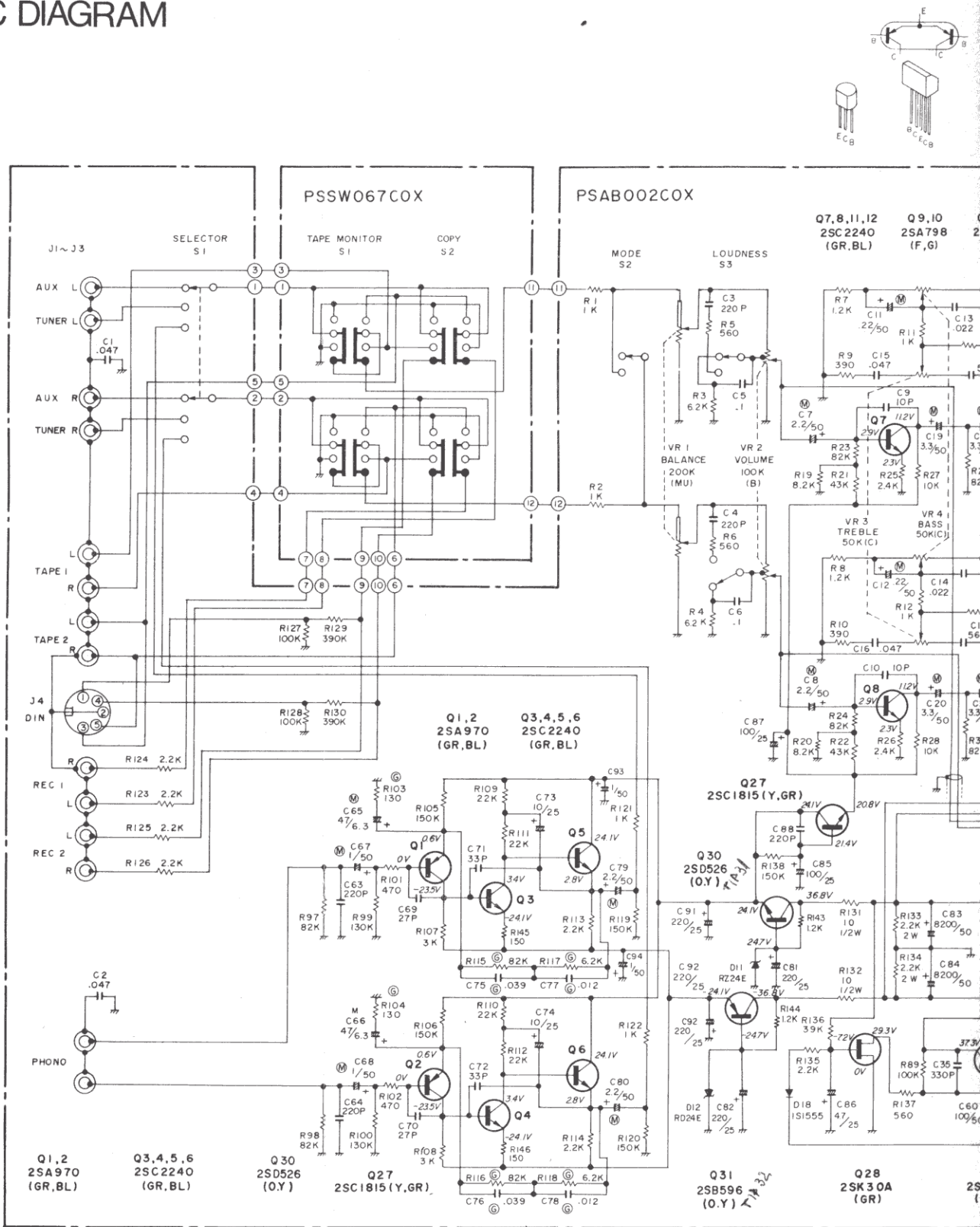

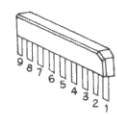
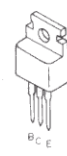
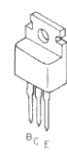
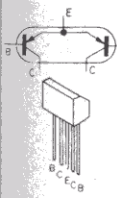

- Q9,10 2SA798 (F,G)
- Q13,14 2SC2229 (Y)
- Q15,16 2SC1318 (Q,R)
- Q17,18 2SA720 (Q,R)
- Q19,20 2SC2235 (O,Y)
- Q21,22 2SA965 (O,Y)
- Q23,24 2SD718 (O,R)
- Q25,26 2SB688 (O,R)
- IC 1 TA7318P-2

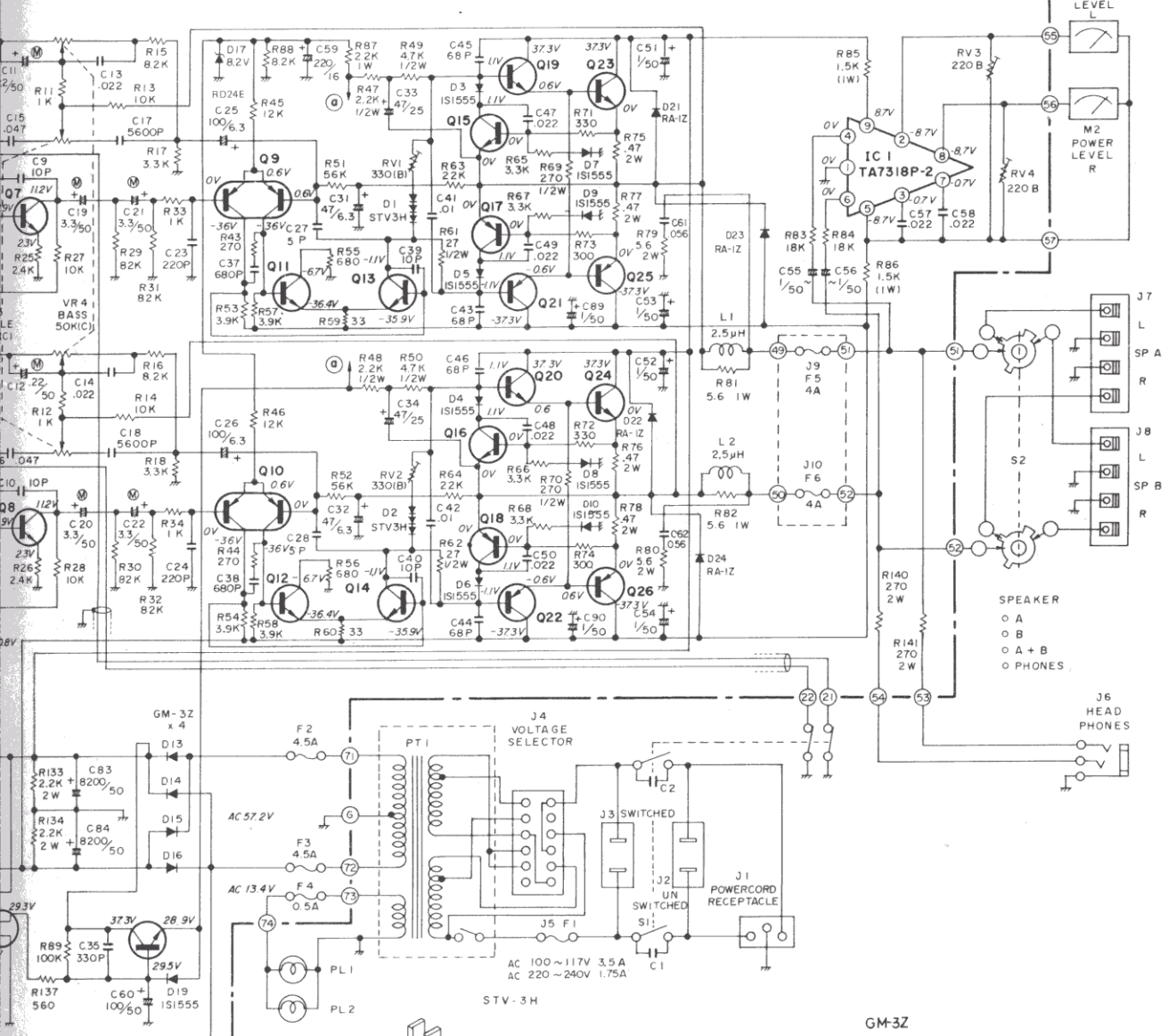

- Q29 2SC1815 (Y,G,R)

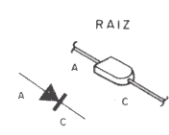
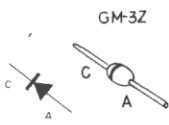
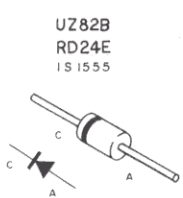

M1 POWER LEVEL L

M2 POWER LEVEL R

SPEAKER
 ○ A
 ○ B
 ○ A + B
 ○ PHONES

J6 HEAD PHONES

J4 VOLTAGE SELECTOR

PT1

J3 SWITCHED

J2 UN SWITCHED

J1 POWERCORD RECEPTACLE

STV-3H

GM-3Z

UZ82B
RD24E
IS1555

RA1Z

28
30A
GR