

Scott 530T/TL, 570T/TL

Block Diagram of IC3 (IC2)

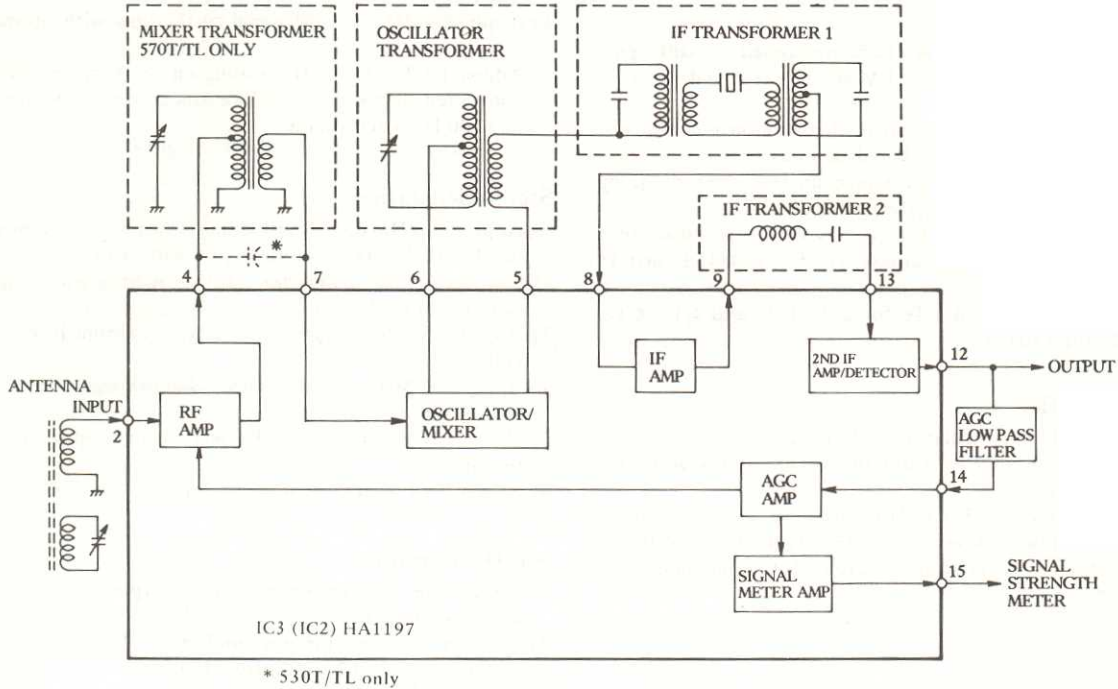

ADJUSTMENT

Test Set-Ups

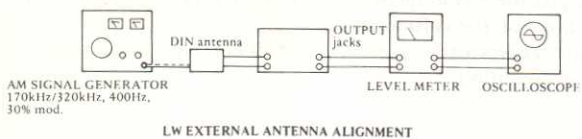
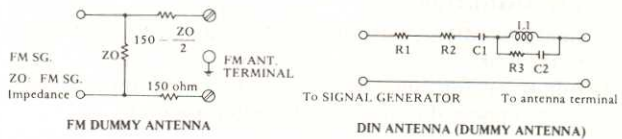
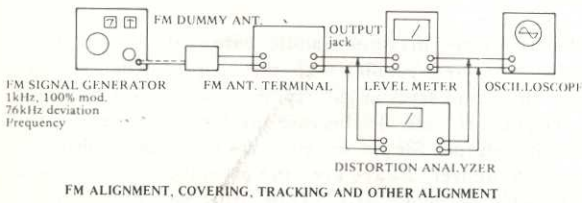
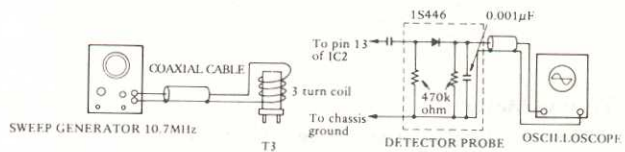
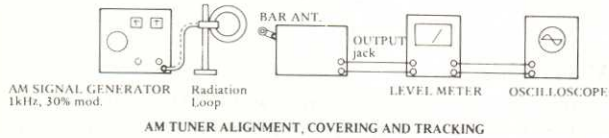

Equipment Required

Audio signal generator.
Distortion analyzer.
DC voltmeter.
Oscilloscope.
Digital frequency counter, 0–100 kHz.
FM multiplex signal generator.

FM RF Tracking

- 1) Apply 90 MHz, 1 kHz and 100% modulated, 65 dBf signal with 76 kHz deviation to the FM antenna terminal.
- 2) Tune the unit to 90 MHz.
- 3) Observe the oscilloscope connected to the output terminal for symmetrical sine wave. If failed, adjust T4.
- 4) Adjust T1, T2, and T3 for maximum level meter reading (connected in parallel with the oscilloscope).
- 5) Readjust the signal generator for 106 MHz, and retune unit.
- 6) Repeat step 3), if failed, adjust CTg for 570T[L], or CTF for 530T[L].
- 7) Adjust CTa, CTc, and CTe for 570T[L], and CTa, CTc, and CTd for 530T[L].

FM IF Amplifier

- 1) Mute the FM local oscillator by shorting CV4.
- 2) Apply 10.7 MHz signal from the sweep generator to T3. See Set-up figure.
- 3) Adjust T5 and T6 (570TL[L] only) for correct figure as provided below. It may be necessary to increase or decrease the sweep generator output for adjustment convenience.



Correct

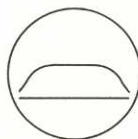

Incorrect
as too low



Incorrect
as too narrow

Tuning Meter

- 1) Remove signal generator output from the unit.
- 2) Adjust T7 for exact center reading on the FM Center Tuning meter.

FM IF Distortion

- 1) Apply 98 MHz, 1 kHz and 100% modulated, 65 dBf signal to the unit.
- 2) Adjust T8 for minimum distortion on the distortion analyzer connected to the Speaker output terminal.

Signal Strength Meter [FM]

- 1) Apply 98 MHz, 90 dB signal to the unit.
- 2) Tune the unit for 98 MHz.
- 3) Adjust RV1 (or RV7 in the 530T/TL) for 90% reading on the signal strength meter.

Mute Circuit

- 1) Apply 98 MHz, 20 dBf signal to the unit.
- 2) Tune the unit (with the Mute switch in the Off position).
- 3) Set the Mute switch to the On position.
- 4) Adjust RV5 for 570T[L], and RV6 for 530T[L] so that the signal is muted.

Pilot Signal (76 kHz)

- 1) Apply 98 MHz, 65 dBf signal to the unit with no modulation.
- 2) Adjust RV3 for 76 kHz reading on the frequency counter connected between TP and chassis ground. The deviation of ± 200 Hz is acceptable.

Stereo Separation

- 1) Apply 98 MHz, 65 dBf left channel signal to the unit modulated with 1 kHz, 9% pilot signal with 6.75 kHz deviation.
- 2) Connect a DC voltmeter to the right channel speaker output terminal.
- 3) Adjust RV4 for minimum leakage (minimum level) on the voltmeter.
- 4) Apply 98 MHz, 65 dBf right channel signal to the unit modulated same as step 1).
- 5) Move DC voltmeter to the left channel speaker output terminal.
- 6) Adjust RV4 again for minimum level.

AM IF Amplifier

- 1) Apply 455 kHz sweep generator output to the unit AM antenna terminal.
- 2) Connect scope to the pin number 12 of IC3 for 570T[L] and pin number 12 of IC2 for 530T[L].
- 3) Adjust T13 to obtain maximum and symmetrical display as shown below.

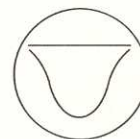

AM Tracking

- 1) Apply 600 kHz, 30% modulated with 1 kHz to the AM bar antenna. See test setup figure (Distance between the AM bar antenna and emitting loop antenna should be 2 foot).
- 2) Adjust signal generator output so that a sine wave appears on the scope.
- 3) Adjust T14 for maximum audio output on the DC voltmeter connected parallel with the scope. When turning core, the audio level might rapidly increase and the voltmeter goes off scale. In this case, always decrease the signal generator output for proper level. Do not change voltmeter range. Moreover, always keep the generator output as low as possible to avoid AGC action (this will prevent inaccurate adjustments).
- 4) Adjust the AM loopstick antenna core for maximum output reading on the voltmeter.
- 5) Shift generator frequency to 1,400 kHz with same modulation condition.

Scott 530T/TL, 570T/TL

- 6) Repeat 2).
- 7) Adjust CTd(570T), CT3(570TL), CTe(530T) or CT2 (530TL), for maximum voltmeter reading.
- 8) Adjust CTb and CTf(570T), CT1 and CT2(570TL), CTb (530T), or CT1 (530TL), for maximum reading on the voltmeter.
- 9) Repeat above procedure again.

Long Wave Tracking (570TL and 530TL only)

- 1) Apply 170 kHz generator output modulated 30% with 400 Hz. See test set-up figure. Set two antennas in a distance of 2 foot. Set the EXT antenna switch to INT position.
- 2) Adjust T15 so that the generator signal is tuned in. Adjust long wave loop stick antenna core (and T11 for 570TL, in addition) for maximum output from the speaker output terminal.
- 3) Shift generator frequency to 320 kHz with same modula-

tion condition.

- 4) Adjust CT7 for 570TL and CT5 for 530TL for maximum output from the speaker output terminal.
- 5) Adjust CT4 and CT6 for 570TL and CT3 for 530TL for maximum output from the speaker output terminal.
- 6) Repeat above procedure.

External Long Wave Antenna Tuning (570TL and 530TL only)

- 1) Apply 170 kHz generator output modulated 30% with 400 Hz audio. Set the EXT antenna switch to EXT position. Use DIN antenna as seen in set-up figure.
- 2) Adjust generator output to observe sine wave on the scope.
- 3) Adjust T9 for maximum audio output.
- 4) Shift generator frequency to 320 kHz with same modulation condition.
- 5) Adjust CT5 for 570TL and CT4 for 530TL for maximum audio output.

Dial Cord Stringing

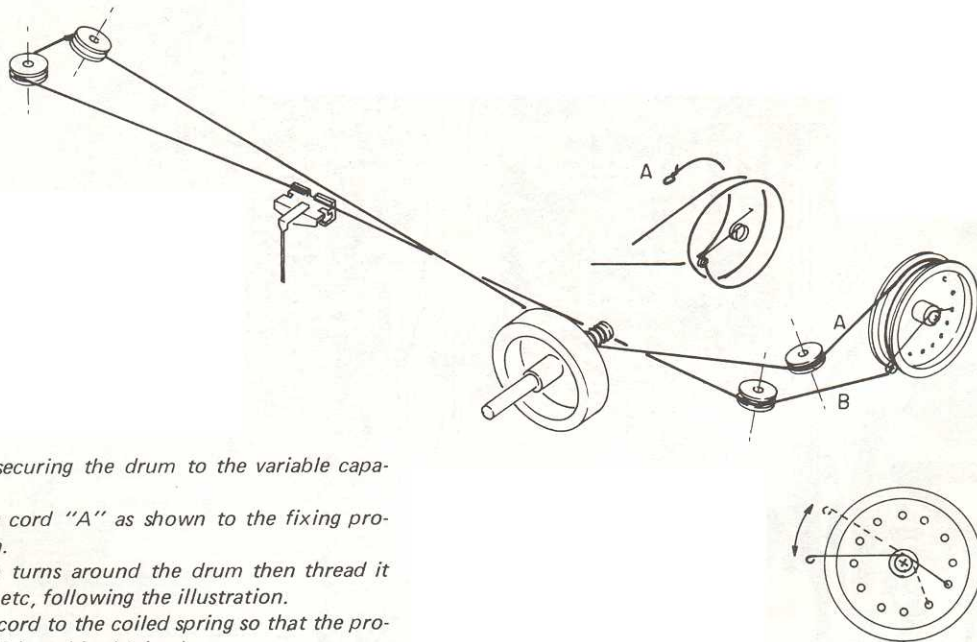

- 1) Loosen the screw securing the drum to the variable capacitor shaft.
- 2) Tie the end of the cord "A" as shown to the fixing protrusion on the drum.
- 3) Wind the cord two turns around the drum then thread it through the rollers, etc, following the illustration.
- 4) Tie the end of the cord to the coiled spring so that the proper tension of the dial cord is obtained.
- 5) Align the pointer position for the correct frequency indication on the tuning dial.
- 6) Secure the screw on the drum.

PARTS LOCATION DIAGRAM: 530T/TL

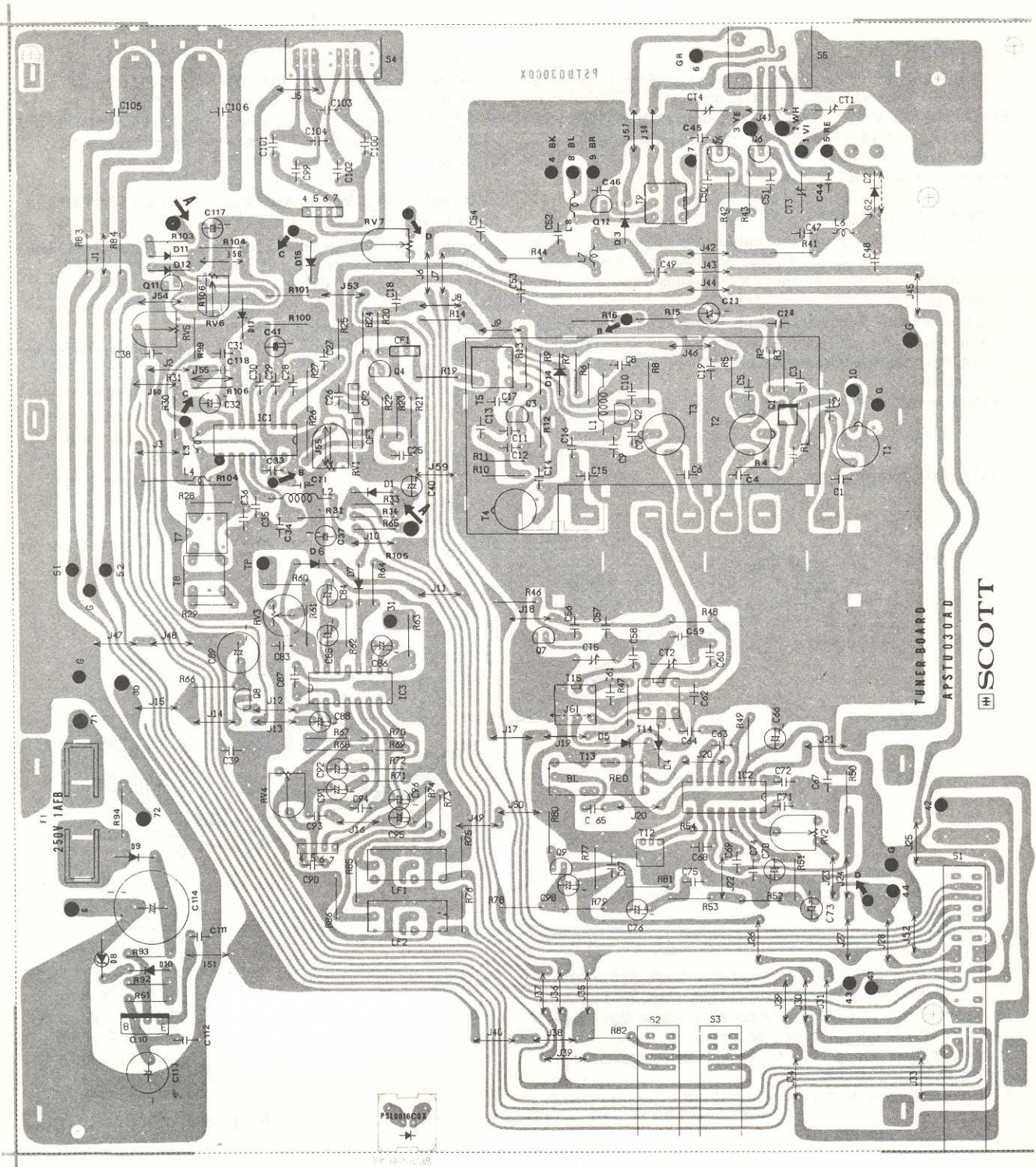

Scott 530T/TL, 570T/TL

PARTS LOCATION DIAGRAM: 570T/TL

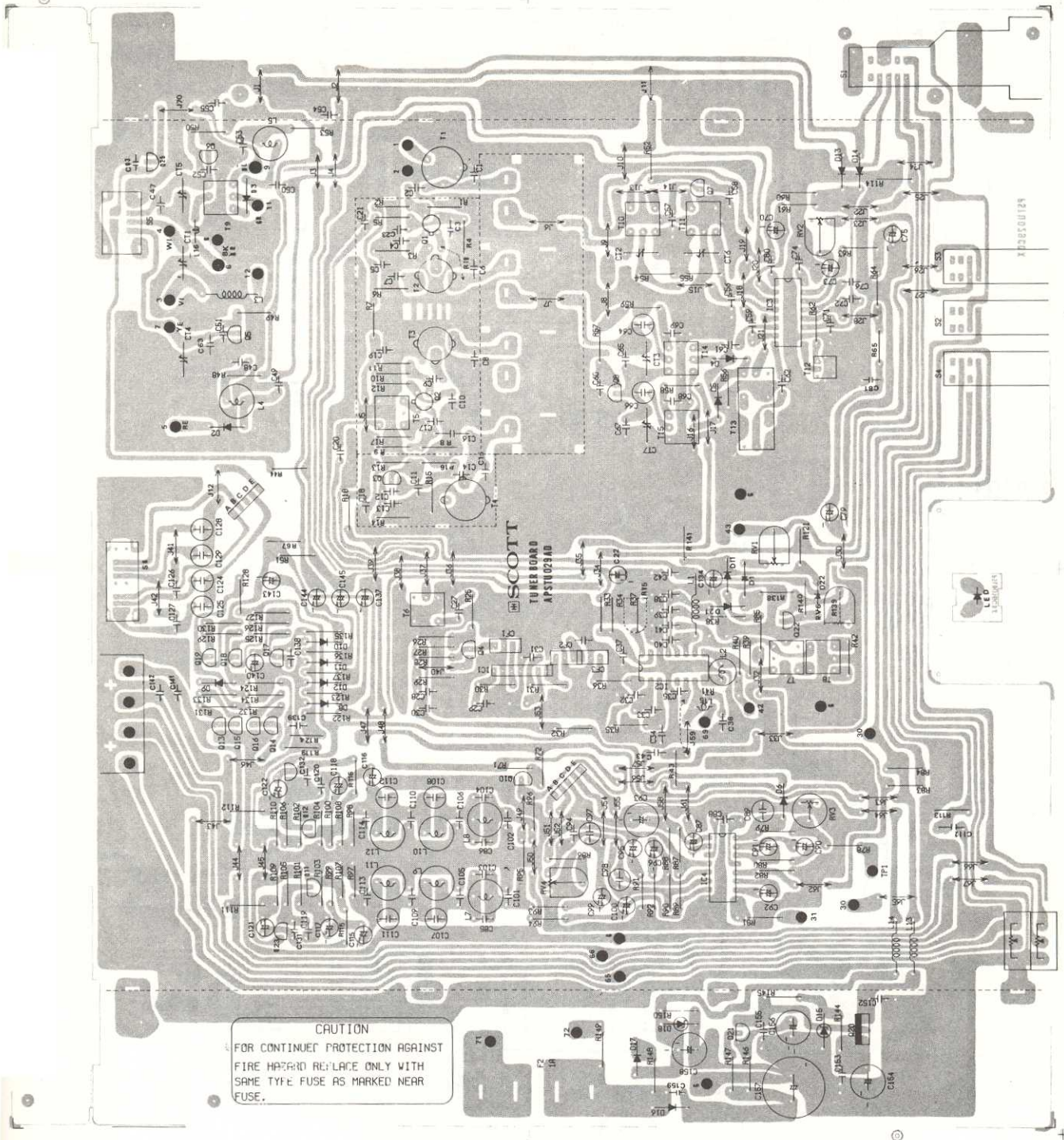

BLOCK DIAGRAMS

570T/TL

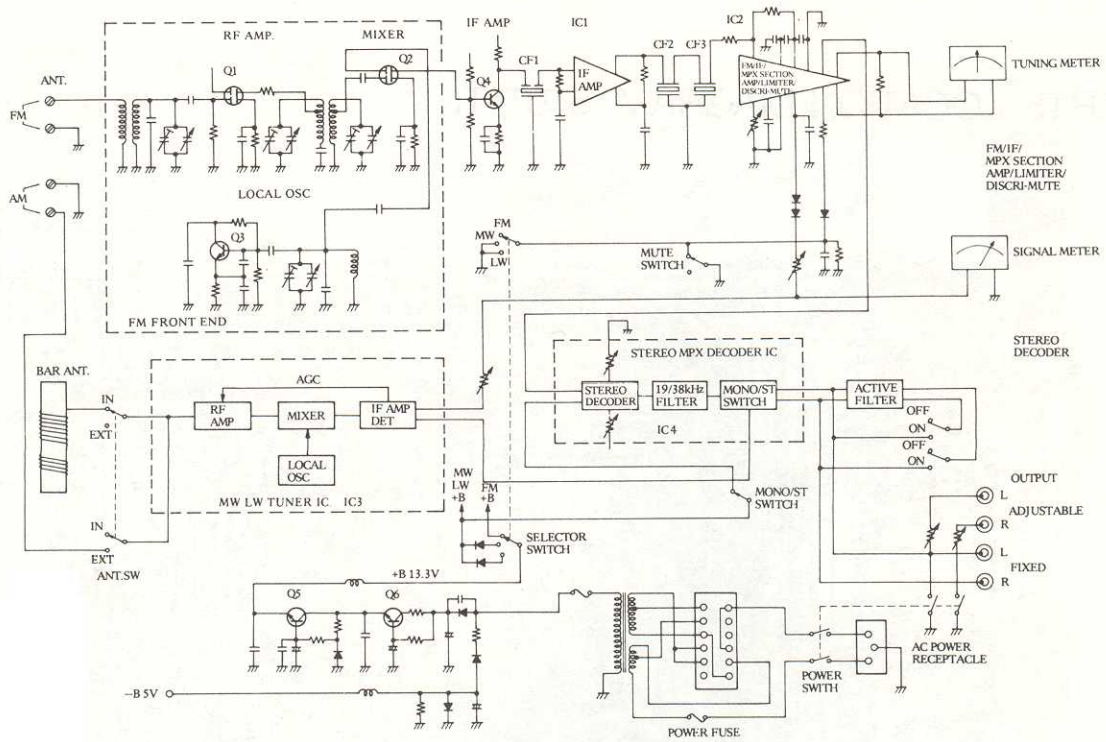

530T/TL

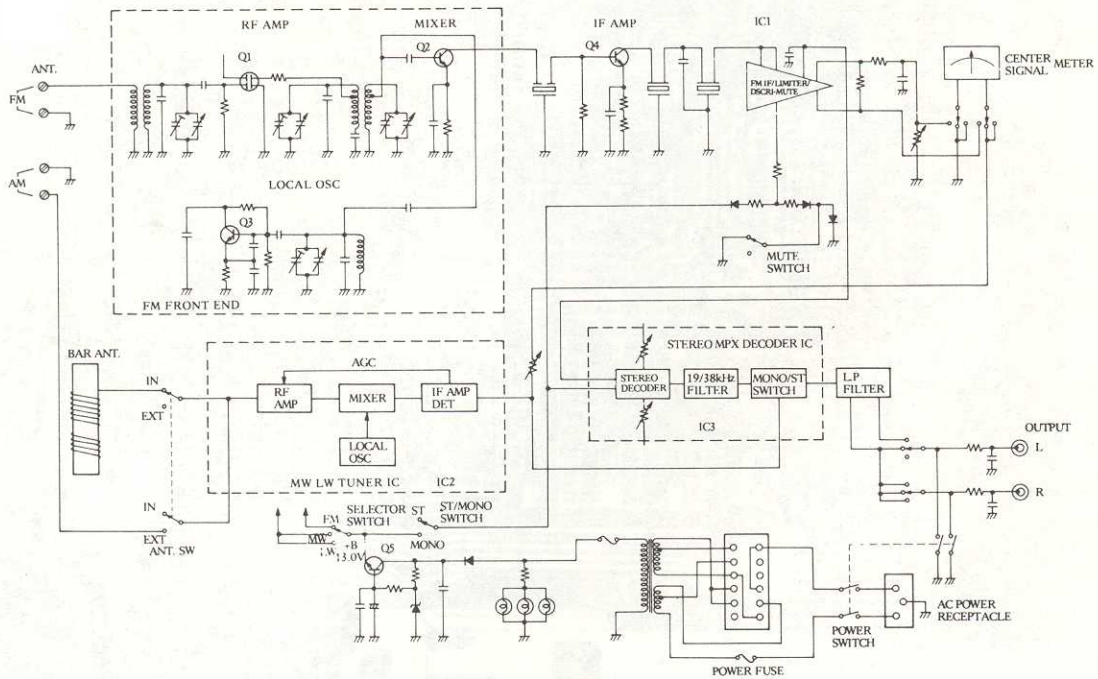

IC3 HA1196

Q4

2SC1923(O,R)

IC1 HA1137W

IS1555
RD13E
RA-1Z

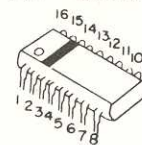
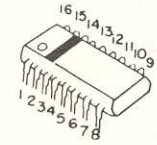

Q4
2SC1923(O,R)

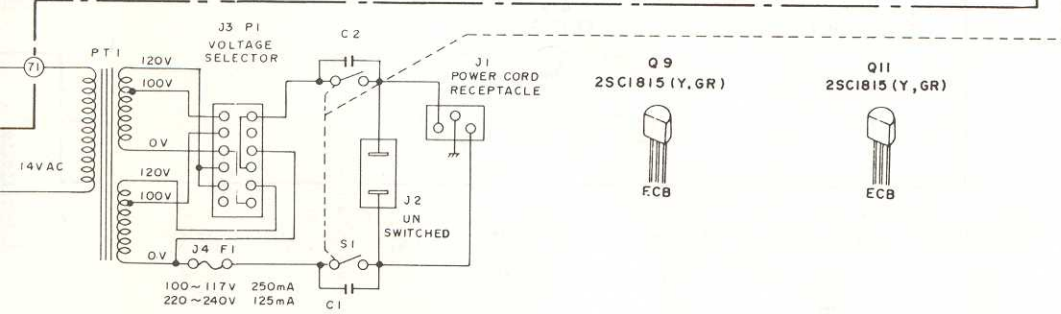
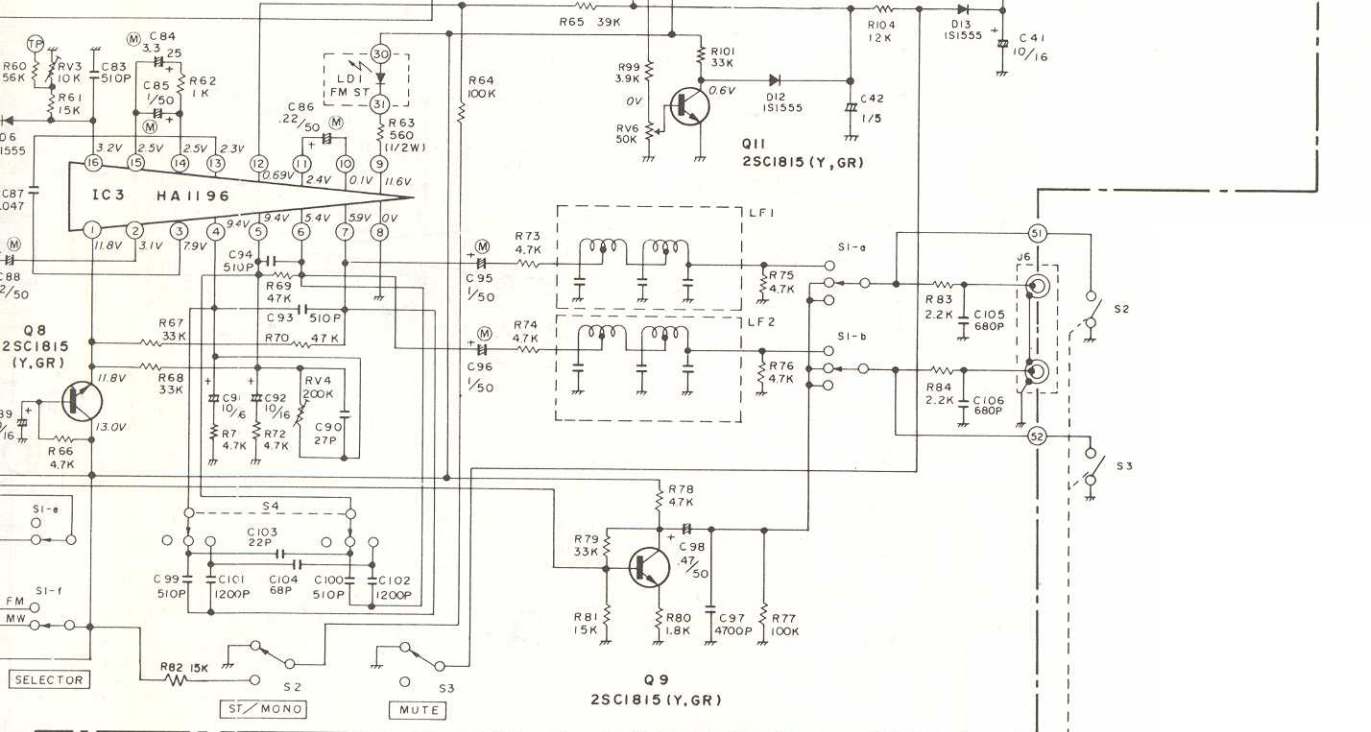
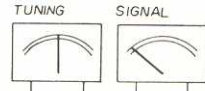
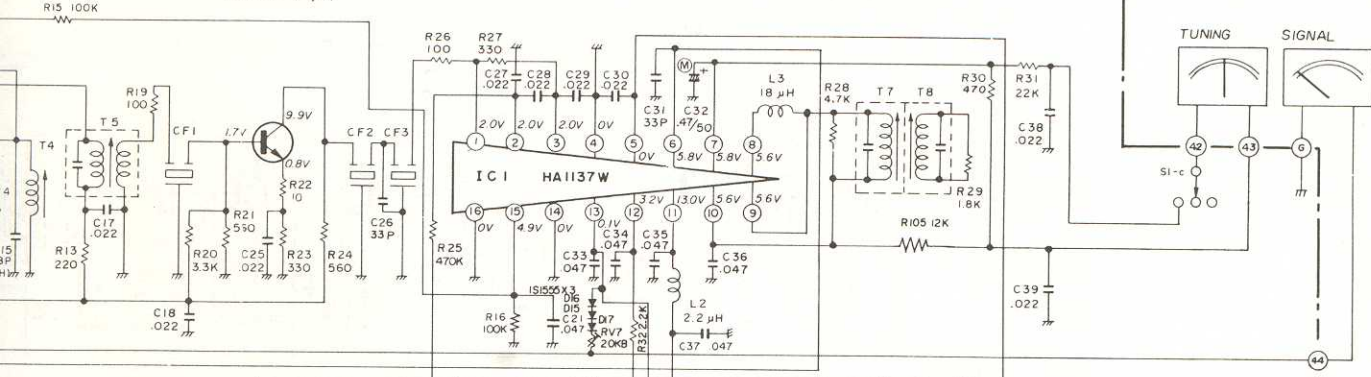

NOTES

- 1 ALL VOLTAGES MEASURED FROM COMMON NEGATIVE CHASSIS GROUND WITH VTVM AT NO SIGNAL.
- 2 CAPACITOR'S VALUES ARE IN μ F UNLESS OTHERWISE NOTED. P=PICO FARAD.
3. RESISTOR'S VALUES ARE IN OHM. K=K OHM
4. *VARIABLE

SCHEMATIC DIAGRAM: 530T

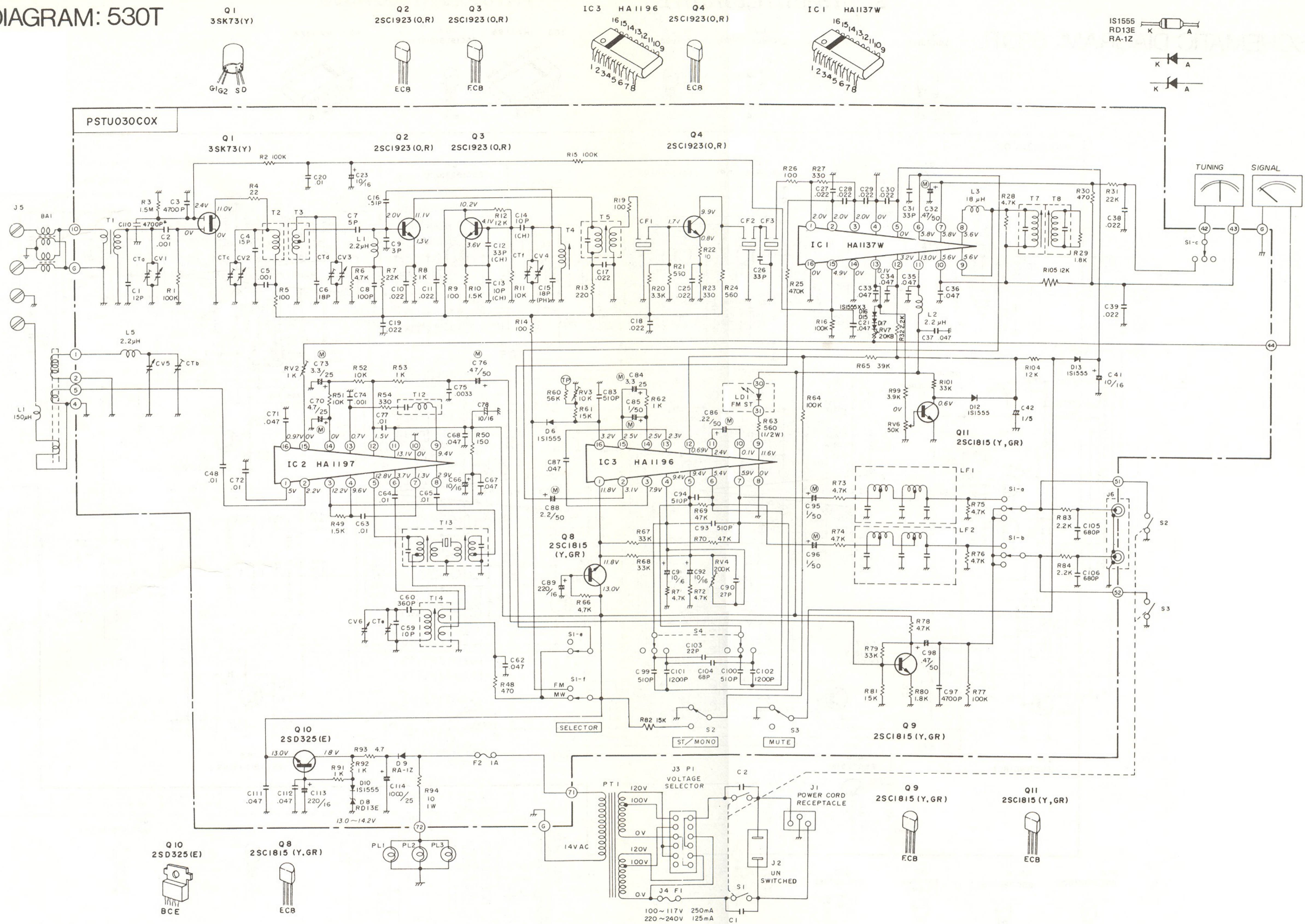

NOTES
 1 ALL VOLTAGES MEASURED FROM COMMON NEGATIVE CHASSIS GROUND WITH VTVM AT NO SIGNAL.
 2 CAPACITOR'S VALUES ARE IN μ F UNLESS OTHERWISE NOTED. P=PICO FARAD.
 3 RESISTOR'S VALUES ARE IN OHM. K=KOHM
 4 *VARIABLE

Scott 530T/TL, 570T/TL

SCHEMATIC DIAGRAM: 530TL

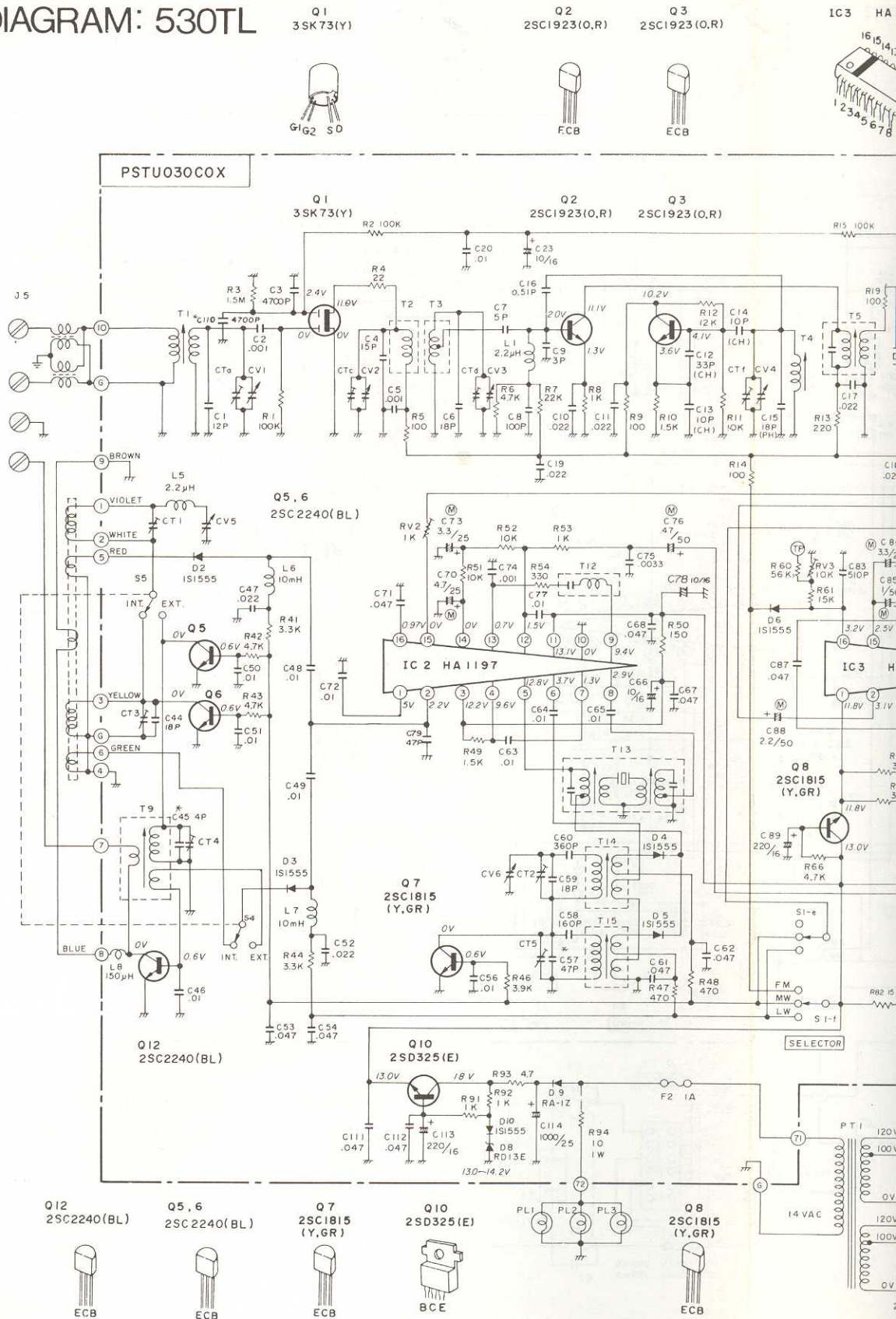

Q3
2SC1923(O,R)

IC3 HA1196

Q4
2SC1923(O,R)

IC1 HA1137W

IS1555
RD13E
RA-12

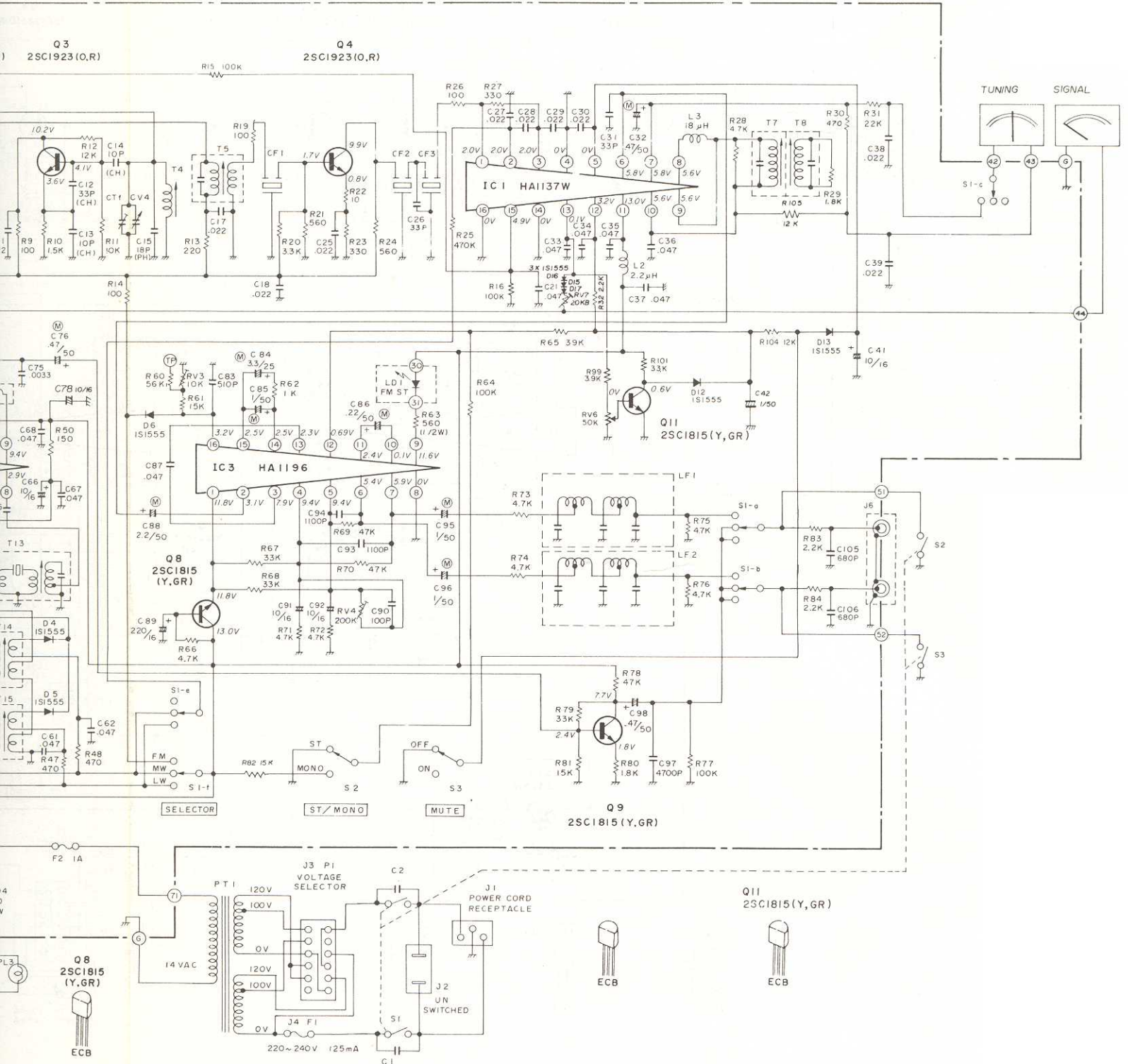
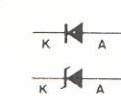
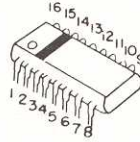
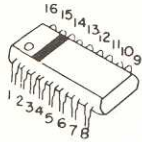

- NOTES
1. ALL VOLTAGES MEASURED FROM COMMON NEGATIVE CHASSIS GROUND WITH VTVM AT NO SIGNAL.
 2. CAPACITOR'S VALUES ARE IN μ F UNLESS OTHERWISE NOTED. P=PICGO FARAD
 3. RESISTOR'S VALUES ARE IN OHM. K=KOHM
 4. *VARIABLE

SCHEMATIC DIAGRAM: 530TL

Scott 530T/TL, 570T/TL

1000 M-REAO DIV

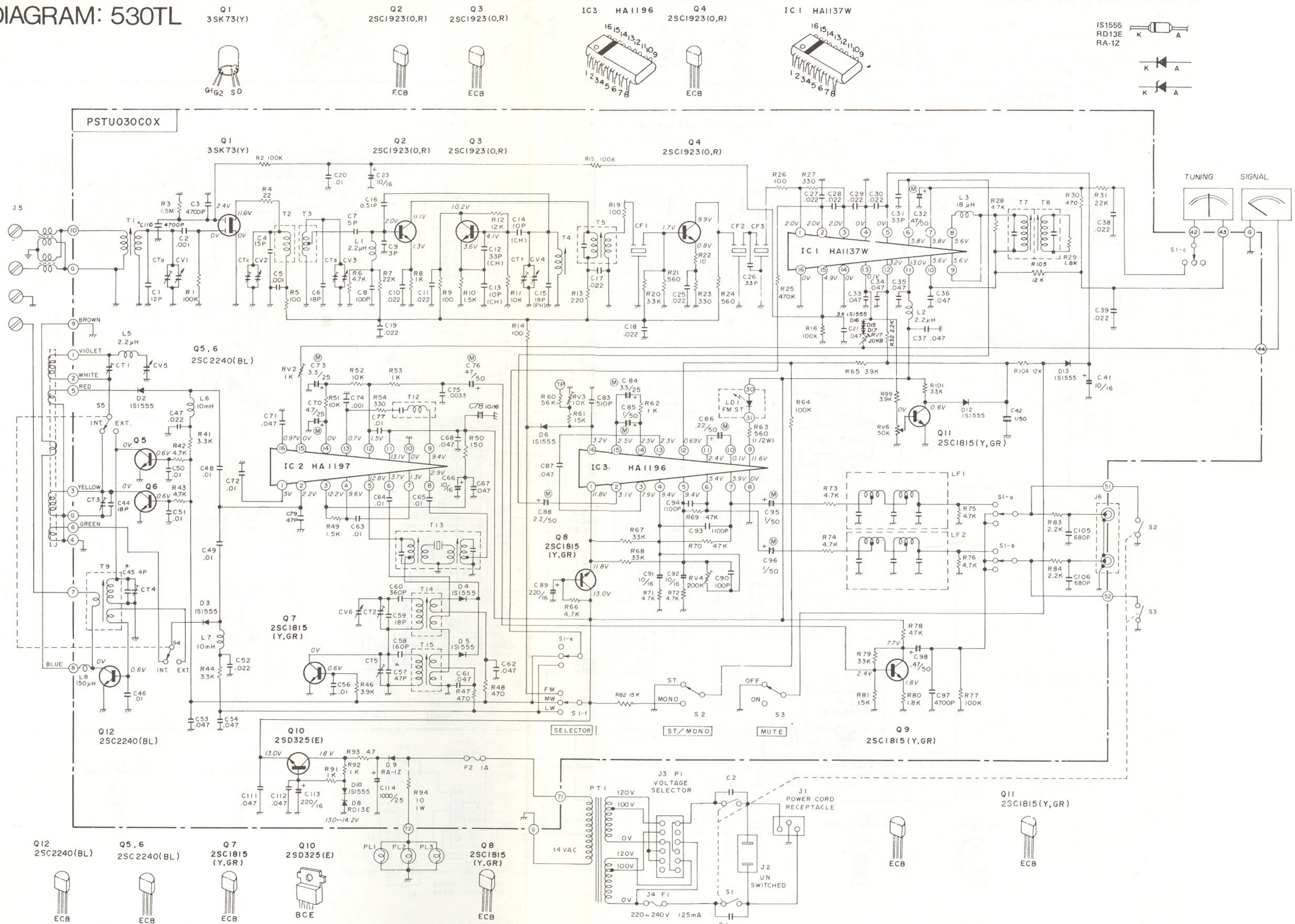

NOTES
 1. ALL VOLTAGES MEASURED FROM COMMON NEGATIVE CHASSIS GROUND WITH VTVM AT NO SIGNAL.
 2. CAPACITOR'S VALUES ARE IN μ F UNLESS OTHERWISE NOTED. P=PICO FARAD
 3. RESISTOR'S VALUES ARE IN OHM. K=KOHM
 4. *VARIABLE

530T/TL

PSTU030COX

Symbol No.	Description	Part Code
S1 (530TL)	Slide switch, 6P-3T, MW/LW/FM	SH060303ZB
S1 (530T)	" 6P-2T, AM/FM	SH060201ZB
S2, 3	" 2P-2T, Stereo-Mono, Mute	SL020215ZB
S4 (530TL)	" 2P-2T, LW Antenna SW	SS020233ZA
S5 (530T)	" 4P-3T, Deemphassis	SS040305ZL
Q1	FET, 3SK73	QTL0073XAT
Q2-4	Transistor, 2SC1923	QTC1923XAT
Q5 (530TL), 6 (530TL), 12 (530TL)	" 2SC2240	QTC2240XAT
Q7 (530TL), 8, 9, 11	" 2SC1815	QTC1815XAT
Q10	" 2SD325	QTD0325XAC
IC1	IC, HA1137W	QQMA1137AB
IC2	" HA1197	QQMA1197AB
IC3	" HA1196	QQMA1196AB
D2-6 (530TL except D6), 10, 12, 13	Silicon diode, 1S155	QDSS1555XT
D8	Zenner diode, RD13E (13V)	QDZRD13EXA
D9	Silicon diode, RA-1Z	QDSRA1ZXXD
D15	" MA26T0-A	QVEMA26TAN
L1, 2	RFC, 2.2 μ H	LCADA3038A
L3	" 18 μ H	LF180JC01K
L6 (530TL), 7 (530TL)	" 10mH	LF103KC01S
L8 (530TL)	" 150 μ H	LF151KA01T
RV2	Trimming resistor, 1k (B)	RPGNB10201
RV3	" 10k (B), Dust-proof	RPJNB10302
RV4	" 200k (B)	RPGNB20401
RV6	" 50k (B)	RPGNB50301
RV7	" 20k (B)	RPGNB20301
T1	RFT, FM antenna	TRA7JZ004S
T2, 3	" FM RF, FM mixer	TR10MQ003M
T4	" FM osc	TRA7JZ003S
T5	IFT, FM IF	TR10MA003S
T7	" "	TR10MM013M
T8	" "	TR10MM014M
T9 (530TL)	RFT, Long wave RF	TR10MZ001M

Symbol No.	Description	Part Code
T12	IFT, AM IF	TR07BM001M
T13	„ (+ Filter), AM IF/filter	FBR455A18Q
T14	RFT, AM osc	TR10MZ002M
T15 (530TL)	„ Long wave osc	TR10MZ003M
CF1-3	Ceramic filter, 10.7 MHz, dual-element	FB10R7F14M
LF1, 2	Lowpass filter, MPX output	FJRR38L04C
CT1-4 (530TL)	Trimming capacitor, 8p	CTX1080P06
CT5 (530TL)	„ 15p	CTX1150P01
CV (530T)	Variable capacitor, 6-gang	CVA2433G02
CV (530TL)	„ 6-gang	CVA2433G01
R63	Metal-oxide film R, 560, 1/2W	RGHANJ561N
R94	„ 10, 1W	RX1ANJ100N
C1	Ceramic capacitor, 12p	CCGB120KOT
C2, 5	„ 0.001	CKGB102KBT
C3, 97	„ 0.0047	CKFB472KBT
C4	„ 15p	CCGB150KOT
C6, 44 (530TL), 59 (530TL)	„ 18p	CCGB180KOT
C7	„ 5p	CCGB050DOT
C8, 90 (530TL)	„ 100p	CCGB101KOT
C9	„ 3p	CCGB030DOT
C10, 11, 17, 18, 25, 27-30, 38, 39, 47 (530L), 52 (530TL)	„ 0.022	CKFB223ZFT
C12	„ 33p	CCFB330KCT
C13, 14	„ 10p	CCGB100DCT
C15	„ 18p (PH)	CCGB180KPT
C16	Minic capacitor, 0.51p	CG2HR51KNN
C20, 46 (530TL), 48-51 (530TL except C48), 56, 63-65, 72, 115	Ceramic capacitor, 0.01	CKFB103ZFT
C21, 33-37, 53 (530TL), 54 (530TL), 61 (530TL), 62, 67, 68, 71, 87, 111, 112	„ 0.047	CKFB473ZFT
C23	Electrolytic capacitor, 10, 16V	CEVD100ALX
C26, 31	Ceramic capacitor, 33p	CCGB330KOT
C32, 76, 38	Electrolytic-capacitor, 0.47	CEEGR47ZMN
C41, 66, 78, 91, 92	Electrolytic capacitor, 10, 16V	CEWD100ALX
C42	„ 1	CEAG010ALX
C45	Ceramic capacitor, 4p	CCGB040COT
C57	„ 47p	CCGB470KOT
C58	Styroflex capacitor, 160p	CQSC161JCF
C60	„ 360p	CQSC361JCF
C59 (530T)	Ceramic capacitor, 10p	CCGB100DOT
C70	Electrolytic capacitor, 4.7, 25V	CEEE4R7ZMN
C73, 84	„ 3.3, 25V	CEEE3R3ZMN
C74	Mylar capacitor, 0.001	CQMB102KTH

Scott 530T/TL,570T/TL

Symbol No.	Description	Part Code
C75	Mylar capacitor, 0.0033	CQMB332KTH
C77	" 0.01	CQMB103KTH
C79	Ceramic capacitor, 47p	CCDB470KOT
C83, 93 (530T), 94 (530T), 99 (530T), 100 (530T)	Styroflex capacitor, 510p	CQSC511JCF
C85, 95, 96	Electrolytic capacitor, 1 (MS)	CEEG010ZMN
C86	" 0.22	CEEGR22ZMN
CC88	" 2.2	CEEG2R2ZMN
C89, 113	" 220, 16V	CEAD221ALX
C90 (530T)	Ceramic capacitor, 27p	CCGB270KOT
C101 (530T), 102 (530T)	Mylar capacitor, 1200p	CQMB122K1H
C103 (530T)	Ceramic capacitor, 22p	CCGB220KOT
C104 (530T)	" 68p	CCGB680KOT
C105, 106	" 680p	CKGB681KBT
C93 (530TL), 94 (530TL)	Styroflex capacitor, 1100p	CQSC112JCF
C110	Ceramic capacitor, 4700p	CKFB472KBT
C114	Electrolytic capacitor, 1000, 25V	CEEE102ALX

PSLD016COX

LD1	LED, Red	QLAR5531KR
-----	----------	------------

Main Chassis

PT1	Power transformer, Youth	TPE48001Y
J1	AC power receptacle, UL/CSA listed	YJA03S002U
J2	AC accessory outlet, UL/CSA listed	YJA020005U
J3	Voltage selector receptacle	YJZ10S001U
P1	Voltage selector plug	YPZ06S004U
J4	Fuse holder, UL listed	YHF1S3001U
J5	Antenna terminals	YTD04S004U
J6	RCA jacks, Output	YPJ02S009U
S1	Lever switch, Power, (US/Canada) " (Europe)	SL020219VA SL020220SA
C1, 2	US/Canada: Ceramic capacitor, 0.0047, 125VAC Europe: Oil-paper capacitor, 0.01, 450VAC	CKDX472PMM CNST103MAN
F1	US/Canada: Fuse, primary, 250mA, 250V Europe: Fuse, primary, 125mA, 250V	ZFBQ25104V ZFBQ13103V
F2	Fuse, secondary, 1A, 250V	ZFBQ10203Z
S2, 3	Leaf switch, Audio mute, etc.	SF010115ZE
M1	Meter, Signal, 500 μ A	ZMG2052N01

Symbol No.	Description	Part Code
M2	Meter, Center-tuning, 250 μ A	ZMF4052K01
BA2 (530T)	Ferrite loop-stick antenna, AM	TEAR155E01
BA2 (530TL)	" Long wave	TEAR200M01
PL1-4	Lamp, 14V/80mA	ZPA1481103U
L1 (530T)	RFC, 150 μ H	LF151KA01T
L5	" 2.2 μ H	LCADA3038A
BA1	FM antenna balance	TV750301A2
C3	Ceramic capacitor, 0.022	CKDB223ZFM

Mechanical Component

Exploded View No.	Description	Part Code
49	Escutcheon (530T)	AM530T**02
"	" (530TL)	AM530TL*02
57	Cabinet cover	MU897SX011
54	Bottom plate	MS986SL002
56	Bottom plate leg	VM280EB001
1	Front chassis	MB972SL002
31	Rear panel	MB972SE037
22	Side chassis bridge, left	MU852SL002
24	" right	MU852SL001
16	Dial scale bridge	ML942SM001
48	Dial pointer	MJ312SM001
12	Dial scale (530T)	VS843AC001
"	" (530TL)	VS843AC002
47	Pointer bracket	VK121NB001
21	Stringing pulley, left	MS546SZ002
17	" right	MZ333SZ001
2	Tuning flywheel assembly	AVFLYWL009
8	Lamp housing	VB632SW001
15	Mounting bracket holder	MC371SZ002
52	Knob, Tuning	MN386AA026
50	" Mode	MN376AA019
51	" ST-Mono, Mute	VN360SX001
53	" Power	VN370SX001

Scott 530T/TL, 570T/TL

REPLACEMENT PARTS LIST: 570T/TL

PSTU029COX

Symbol No.	Description	Part Code
S1 (570T)	Slide switch, AM/FM, 2P-2T	SH020201ZB
S1 (570TL)	" MW/LW/FM, 2P-3T	SH020301ZB
S2-4	" Stereo/Mono, Mute, MPX Fil., 2P-2T	SL020215ZB
S5 (570TL)	" Antenna Int-Ext, 2P-2T	SS020233ZB
S6 (570T)	" 75-50-25 μ S, 4P-3T	SS040305ZL
J1	RCA jacks, 4-pin, Outputs	YJP04S016U
VR1	VR, 20k(A), Output Level	RVQA203A01
CV (570TL)	Variable capacitor, 7-gang, Tuning	CVA3433G03
CV (570T)	" 7-gang, Tuning (Alps)	CVA3433G02
IC1	IC, μ PC555H, IF amplifier	QQM00555BA
IC2	" HA11225, quadrature detector	QQM11225AB
IC3	" HA1197, AM RF/IF	QQMA1197AB
IC4	" HA1196, PLL decoder	QQMA1196AB
Q1, 2	FET, 3SK45	QT10045XXB
Q3, 4	Transistor, 2SC1923	QTC1923XAT
Q5 (570TL), 6 (570TL), 10, 25 (570TL)	" 2SC2240	QTC2240XAT
Q7 (570TL), 8 (570TL), 12-14, 17, 19	" 2SC1815	QTC1815XAT
Q15, 16, 18, 23, 24	" 2SA1015	QTA1015XAT
Q20	" 2SD325	QTD0325XAC
Q21	" 2SC1509	QTC1509XBN
D1-14 (570T except D2-5, 12-14), 17, 19, 21	Silicon diode, 1S1555	QDSS1555XT
D15	Zenner diode, RD13E (13V)	QDZRD13EXA
D16	Silicon diode, RA-1Z	QDSRA1ZXXD
L1, 3, 13, 14	RFC, 2.2 μ H	LCADA3038A
L2	" 18 μ H	LF180JC01K
L4 (570TL), 5 (570TL)	" 10mH	LF103KC01S
L7, 8	" 68mH	LF683JC01K
L9, 10	" 56mH	LF563JC01K
L11, 12	" 39mH	LF393JC01K
L16 (570TL)	" 150 μ H	
T1	RFT, FM antenna	TRA7JZ007S
T2	" FM RF	TR10MQ002M
T3	" FM mix	TR10MQ003M
T4	" FM local	TR10MQ004M
T5, 6	" FM IF	TR10MA013S
T7	" "	TR10MM013M
T8	" "	TR10MM014M
T9 (570TL)	" Long wave antenna	TR10MZ001M
T10	" AM RF	TR10MN006M
T11 (570TL)	" Long wave RF	TR10MP005M
T12	" AM IF	TR07BM001M
T13	" (Filter), AM IF, filter	FBR455A18Q
T14	RFT, AM osc	TR10MZ002M
T15 (570TL)	" Long wave osc	TR10MZ003M

Certain parts are used solely for the single model specified in bracket which follows the symbol No.

Symbol No.	Description	Part Code
D22, 23	Silicon diode, 1N60	QDGI1N60XXT
RV1	Trimming resistor, 20k (B)	RPGNB20301
RV2	" 1k (B)	RPGNB10201
RV3	" 10k (B), Dust-proof	RPGNB10302
RV4	" 200k (B)	RPGNB20401
RV5	" 10k (B)	RPGNB10301
CF1-3	Ceramic filter, 10.7 MHz, FM IF	FB10R7F14M
CT1-6 (570TL)	Trimming capacitor, 8p*	CTX1080P06
CT7 (570TL)	" 15p	CTX1150P01
R81	Metal-oxide-film R, 560**, 1/2W	RGHAPJ561N
R149	" 10, 1W	RX1ANJ100N
C1	Ceramic capacitor, 15p	CCDB150KOT
C2, 4, 9, 101	" 0.001	CKDB102ZFT
C3	" 0.0047	CKDB472ZFT
C5, 7, 10, 19, 21, 27, 48-53 (570TL except C49), 58-62 (570TL except C59, 61, 62), 80, 83 (570TL), 159	" 0.01	CKFB103ZFT
C6	" 18p	CCDB180KOT
C7	"	
C8	" 18p	CCGB180KOT
C10	"	
C11, 17, 18, 28-34, 44, 45	" 0.022	CKFB223ZFT
C12	" 33p	CCFB330KCT
C13, 63 (570TL)	" 10p	CCGB100DCT
C14	" 10p (UJ)	CCDB100DUM
C15	" 22p	CCGB220KRT
C16	Minic capacitor, 3p	CG2H3R9KNN
C20, 82, 131, 132	Ceramic capacitor, 47p	CCGB470KOT
C24	" 0.0047	CKDB472PEM
C35	" 33p	CCGB330KOT
C36	Electrolytic, 0.47, 50V	CEAGR47ZMN
C38-40, 41, 42, 54-57 (570TL except C56), 68 (570TL), 69, 71, 74, 88, 152, 153, 155,	Ceramic capacitor, 0.047	CKFB473ZFT
C43	" 4700p	CKDB472PEM
C46	Electrolytic, 1	CEAG010ALX
C47 (570TL)	Ceramic capacitor, 4p	CCGB040COT
C64	Styroflex capacitor, 360p	CQSC361JCF
C65	Ceramic capacitor, 15p	CCGB150KOT
CC66 (570TL)	Styroflex capacitor, 150p	CQSC151JCF
C67 (570TL)	Ceramic capacitor, 39p	CCGB391KOT
C70, 78, 95, 96, 140	Electrolytic capacitor, 10, 16V	CEWD100ALX
C73	" 4.7, 25V	CEEE4R7ZMN
C75, 90	Electrolytic capacitor, 3.3, 25V	CEEE3R3ZMN
C76	Mylar capacitor, 0.001	CQMB102KTH

* All capacitors are rated in micr-farad and have the voltage rating of 50V, unless otherwise specified.

** Resistors are rated in ohm and have the wattage rating of 1/4W, unless otherwise specified.

SCHEMATIC DIAGRAM: 570T

Q1
3SK45(B)



Q2
3SK45(B)



Q3
2SC1923(O.R)



IC4 HA 1196

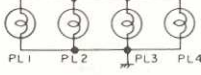
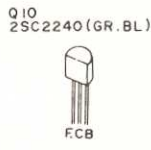
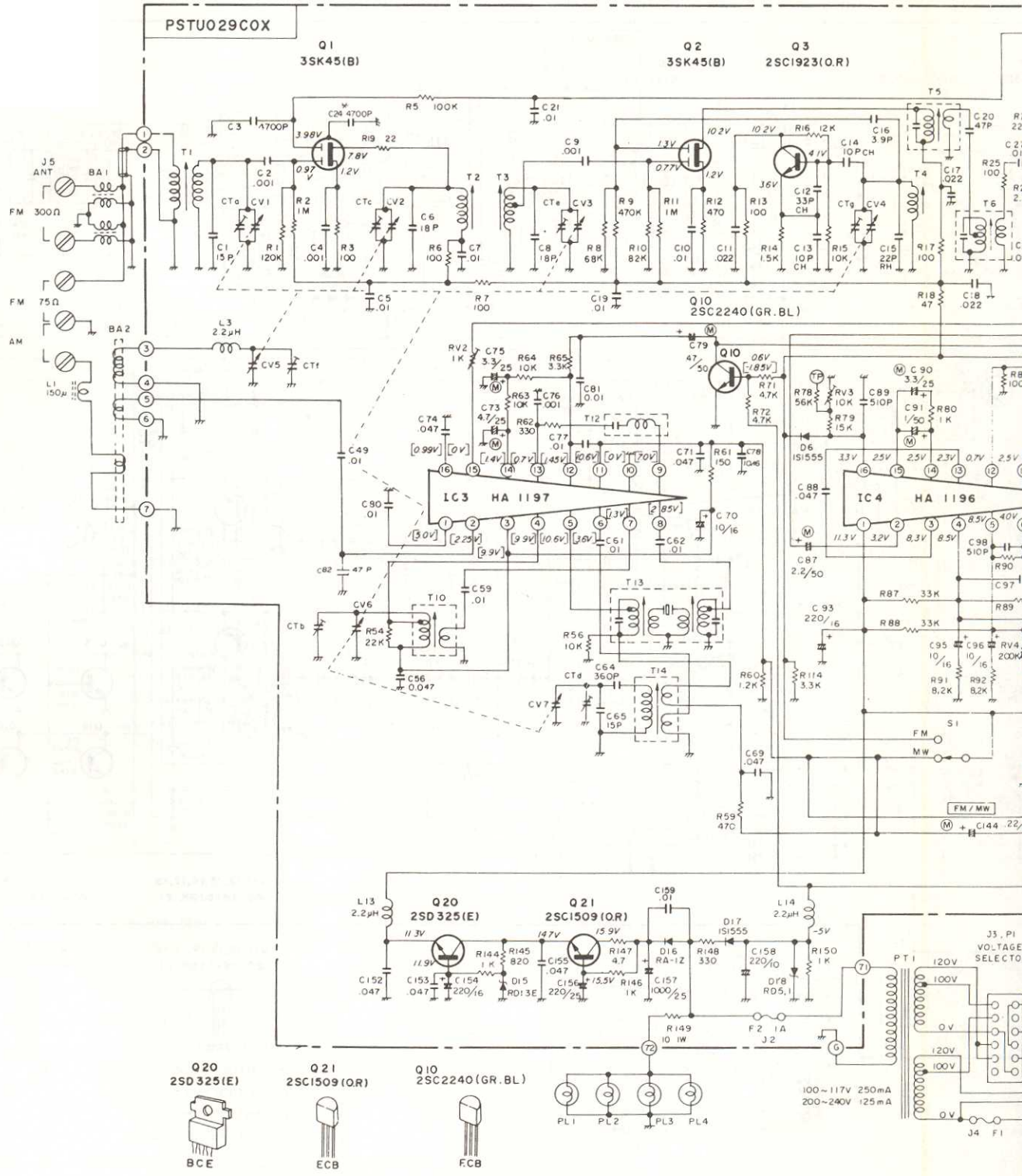
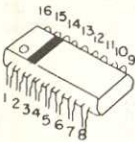

100-117V 250mA
200-240V 125mA

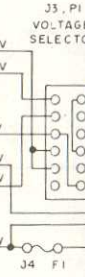

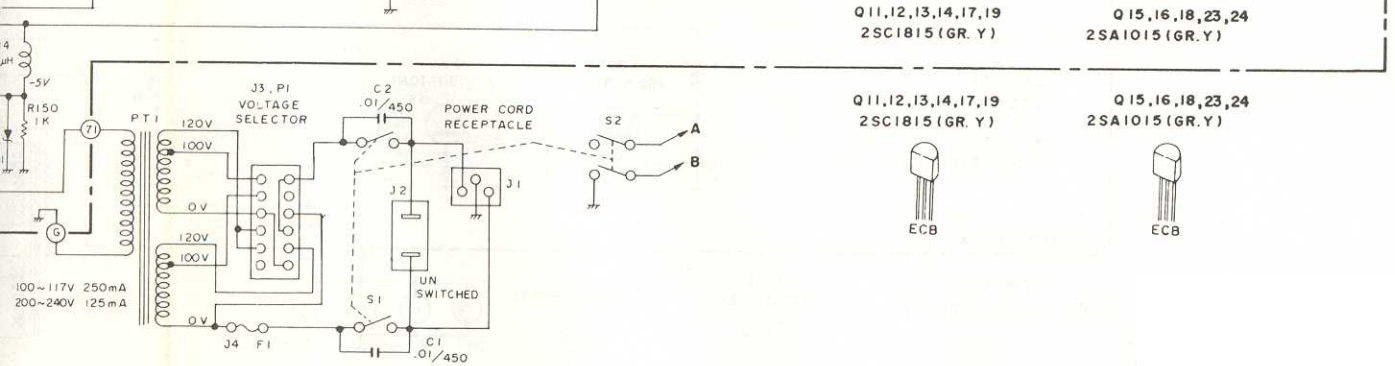
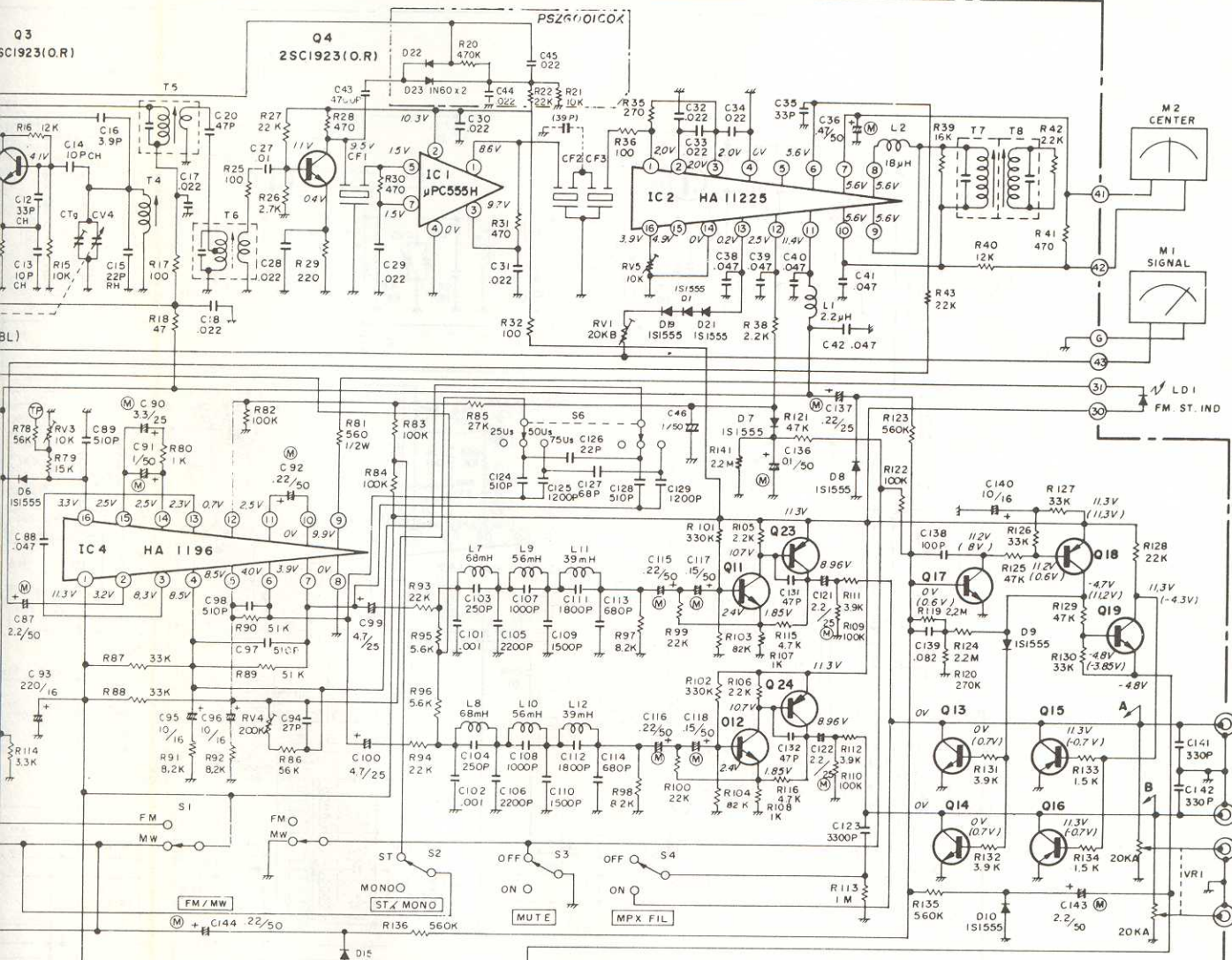
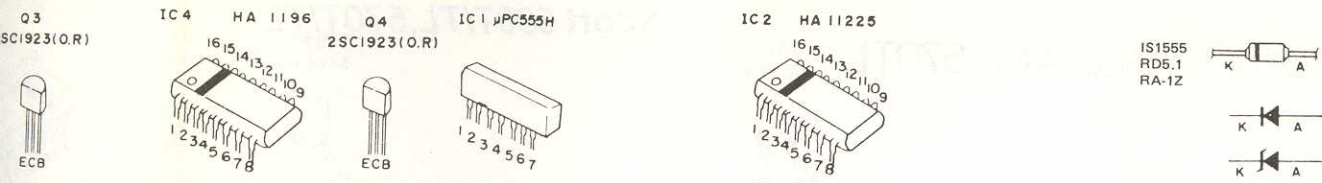

- NOTE
- 1 ALL VOLTAGES MEASURED FROM COMMON NEGATIVE CHASSIS GROUND WITH VTVM AT NO SIGNAL.
 - 2 CAPACITOR'S VALUES ARE IN μ F UNLESS OTHERWISE NOTED
 - 3 RESISTOR'S VALUES ARE IN OHM K=K OHM
 - 4 VOLTAGES IN () WHEN MUTE ON
 - 5 VOLTAGES IN [] WHEN AM
 - 6 *VARIABLE

SCHEMATIC DIAGRAM: 570T

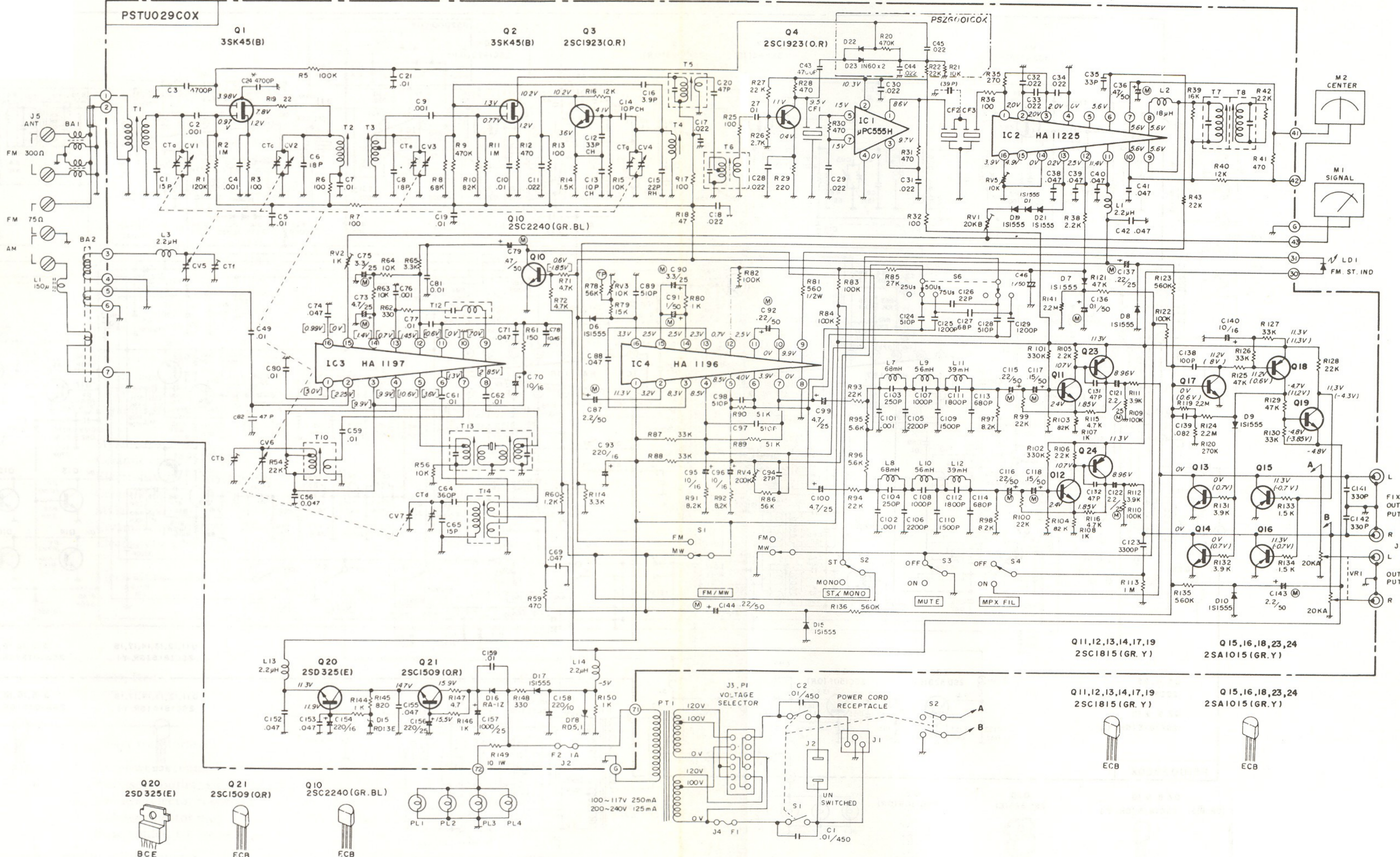
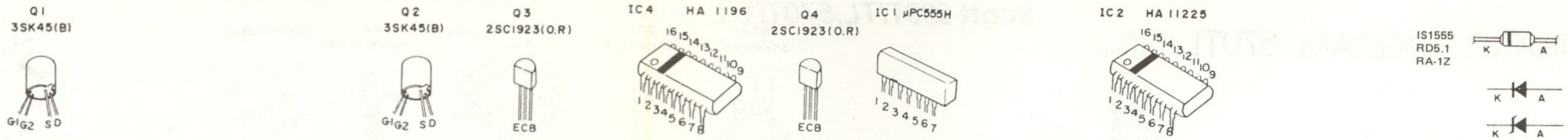

NOTE

- ALL VOLTAGES MEASURED FROM COMMON NEGATIVE CHASSIS GROUND WITH VTVM AT NO SIGNAL
- CAPACITOR'S VALUES ARE IN μF UNLESS OTHERWISE NOTED
- P=PICO FARAD
- RESISTOR'S VALUES ARE IN OHM, K=K OHM
- VOLTAGES IN () WHEN MUTE ON
- VOLTAGES IN [] WHEN AM
- *VARIABLE

SCHEMATIC DIAGRAM: 570TL

Scott 530T/TL, 570T/TL

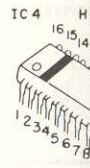
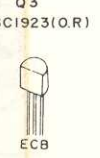
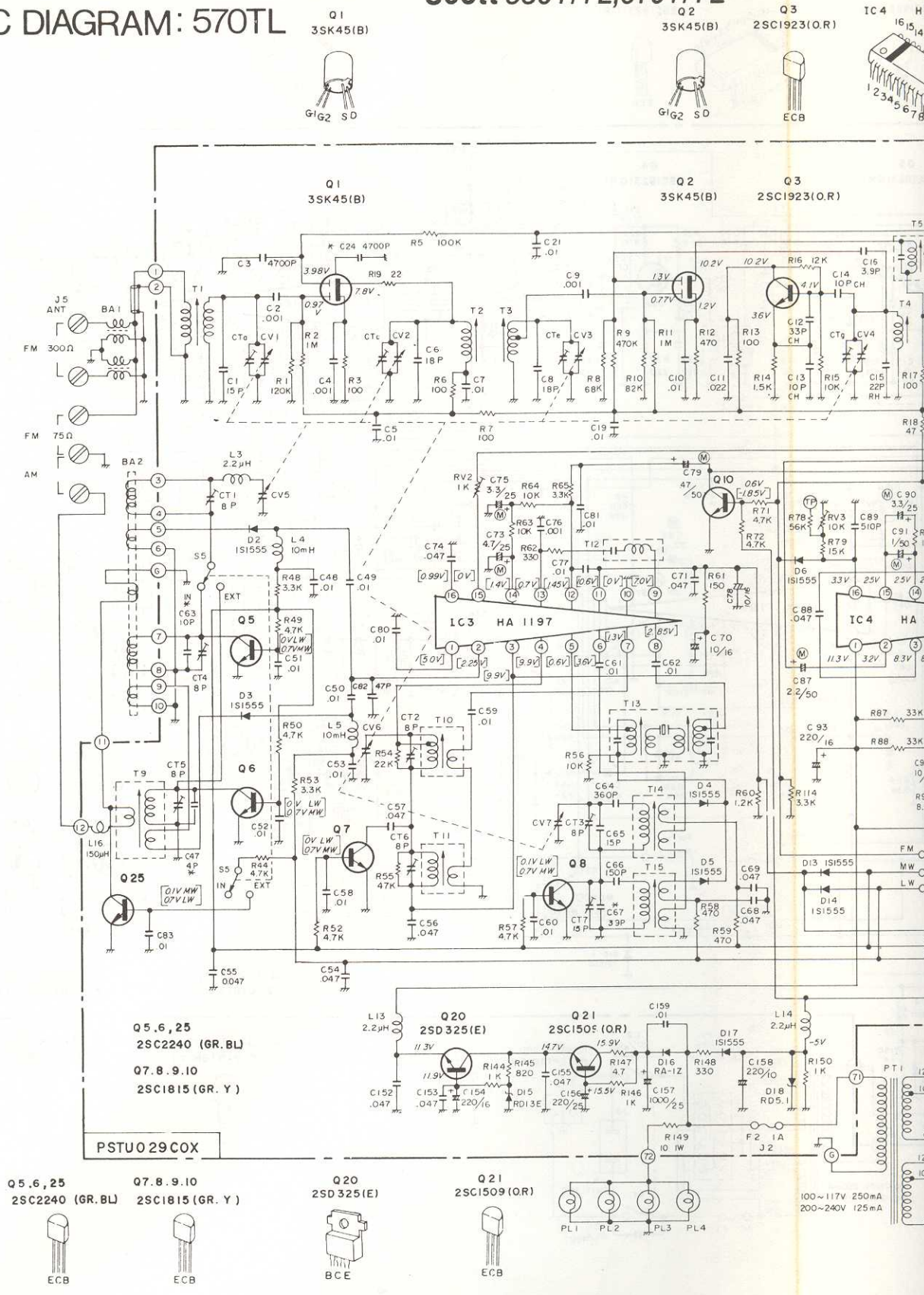

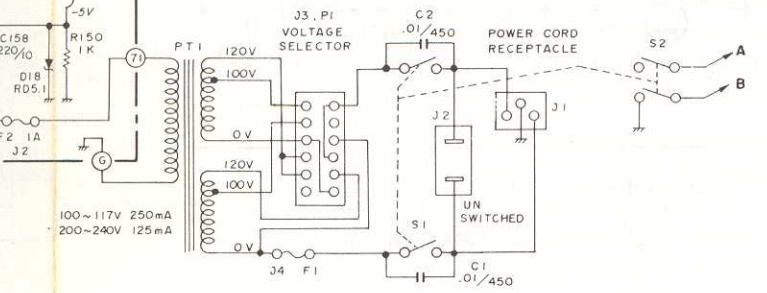
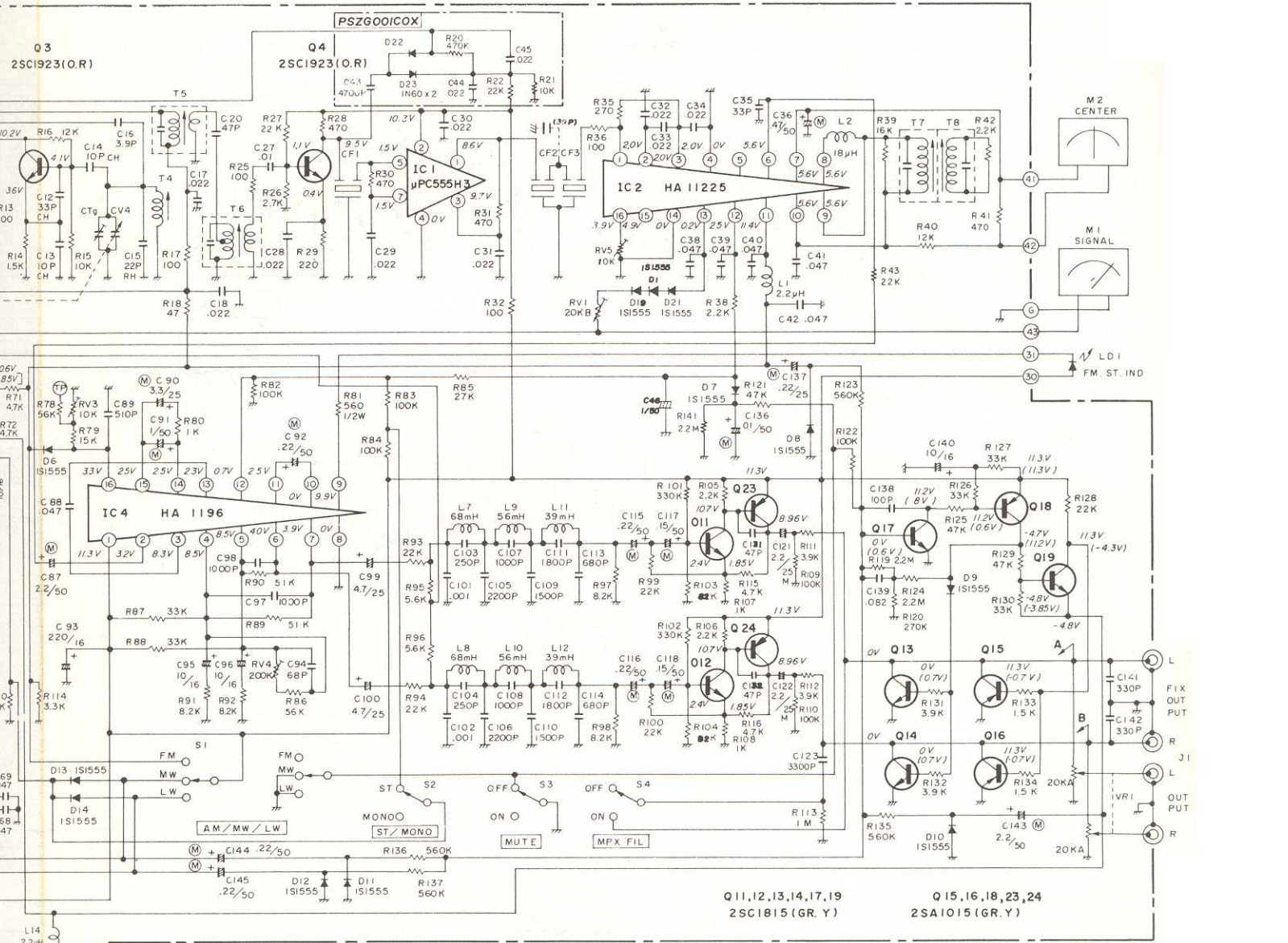
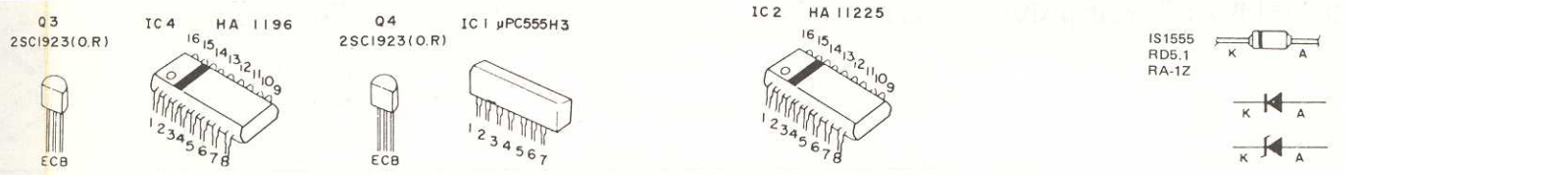

Q11,12,13,14,17,19
2SC1815 (GR. Y)

Q15,16,18,23,24
2SA1015 (GR. Y)

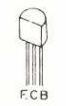

NOTE
 1 ALL VOLTAGES MEASURED FROM COMMON NEGATIVE CHASSIS GROUND WITH VTVM AT NO SIGNAL.
 2 CAPACITOR'S VALUES ARE IN μF UNLESS OTHERWISE NOTED. P=PICO FARAD.
 3 RESISTOR'S VALUES ARE IN ΩMM K=K OHM
 4 VOLTAGES IN [] WHEN MUTE ON
 5 VOLTAGES IN [] WHEN MW LW
 6 *VARIABLE

SCHEMATIC DIAGRAM: 570TL

Scott 530T/TL, 570T/TL

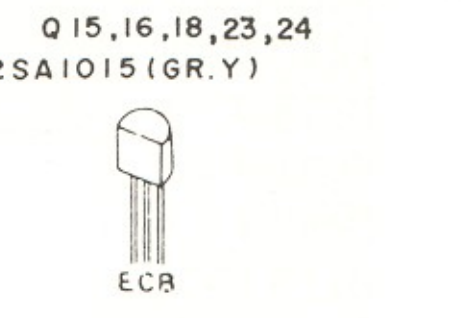
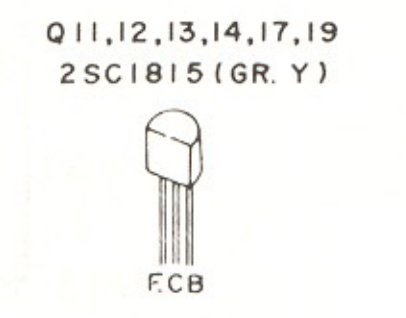
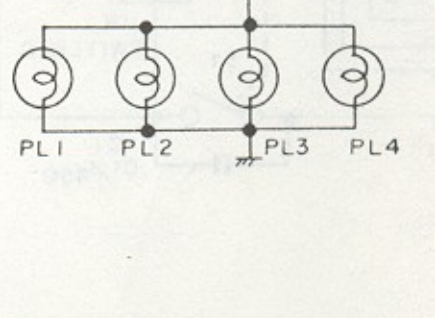
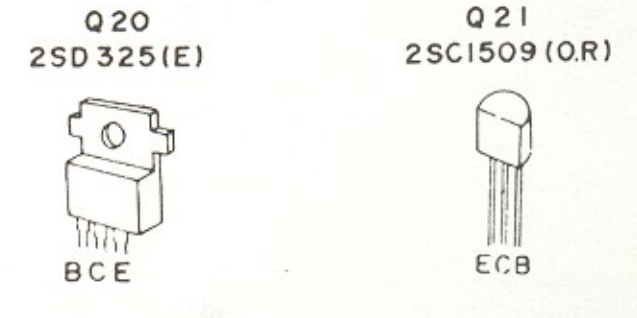
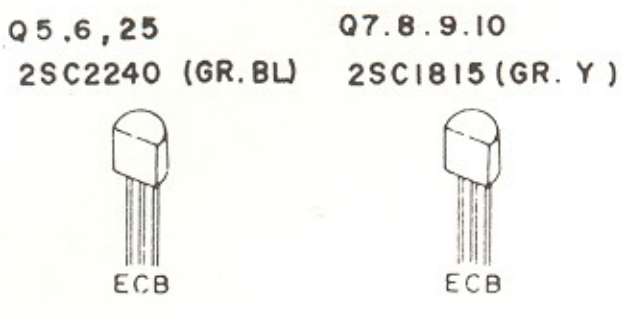
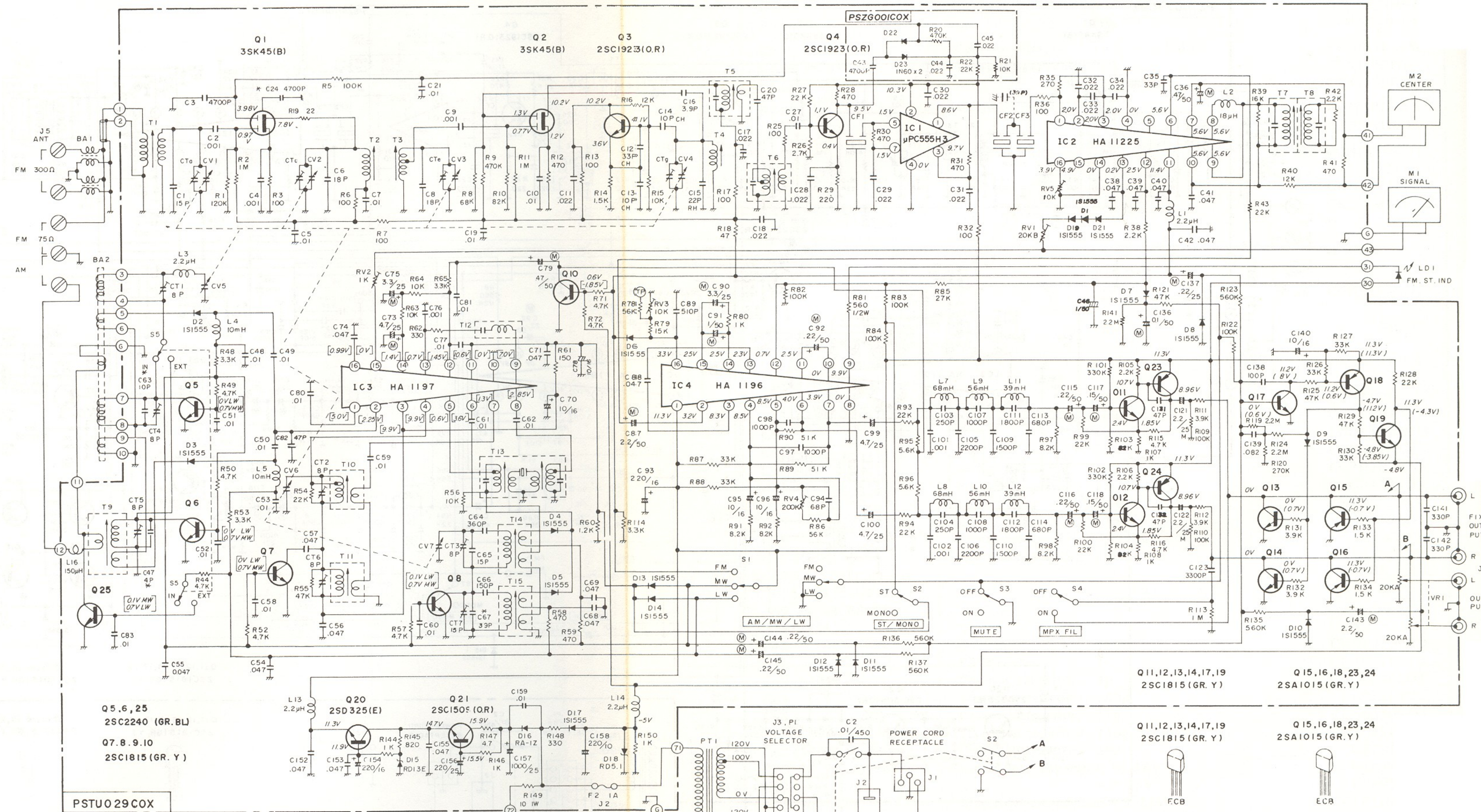
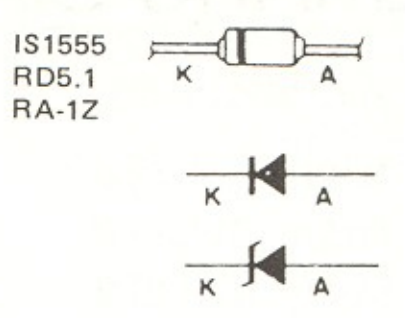
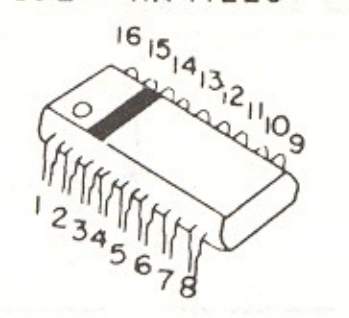
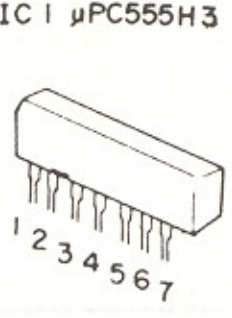
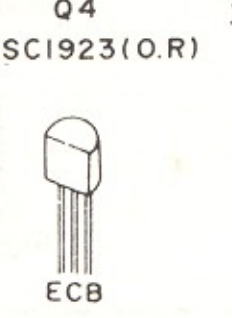
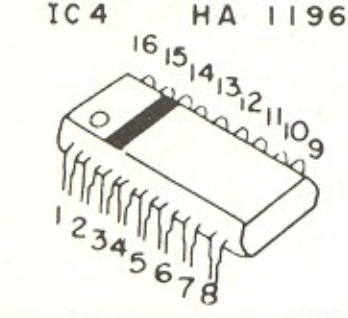
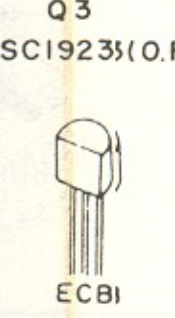
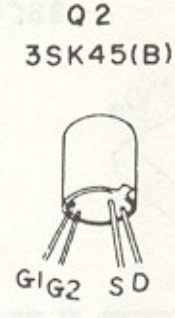
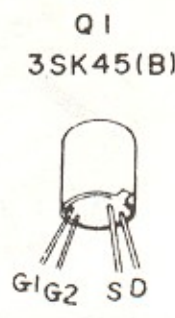

NOTE

- ALL VOLTAGES MEASURED FROM COMMON NEGATIVE CHASSIS GROUND WITH VTVM AT NO SIGNAL.
- CAPACITOR'S VALUES ARE IN µF UNLESS OTHERWISE NOTED. P=PICO FARAD.
- RESISTOR'S VALUES ARE IN OHM, K=K OHM.
- VOLTAGES IN () WHEN MUTE ON.
- VOLTAGES IN [] WHEN MW, LW.
- * VARIABLE.

Scott 530T/TL,570T/TL

Symbol No.	Description	Part Code
C77, 81	Mylar capacitor, 0.01	CQMB103KTH
C79	" 0.47	CEAGR47ZMN
C87	Electrolytic capacitor, 2.2	CEAG2R2ZMN
C89, 97 (570TL), 98 (570TL), 124 (570TL), 128 (570TL)	Styroflex capacitor, 510p	CQSC511JCF
C91	Electrolytic capacitor, 1 (MS)	CEAG010ZMN
C92	" 0.22	CEAGR22ZMN
C93, 154	" 220, 16V	CEFD221ALX
C94 (570TL)	Ceramic capacitor, 68p	CCGB680KOT
C97 (570TL), 98 (570TL)	Styroflex capacitor, 0.001	CQSC102JCF
C99, 100	Electrolytic capacitor, 4.7, 25V	CEWF4R7ALX
C101, 102	Ceramic capacitor, 0.001	CKGB102KBJ
C103, 104	Styroflex capacitor, 250p	CQSC251JCF
C105, 106	Mylar capacitor, 0.0022	CQMB222JTH
C107, 108	Styroflex capacitor, 1000p	CQSC102JCF
C109, 110	Mylar capacitor, 0.0015	CQMB152JFH
C111, 112	Styroflex capacitor, 1800p	CQSC182JCF
C113, 114	" 680p	CQSC681JCF
C115, 116, 137	Electrolytic capacitor, 0.22	CEAGR22ZMN
C117, 118	" 0.15	CEAGR15ZMN
C121, 122	Electrolytic capacitor, 2.2, 25V	CEAF2R2ZMN
C123	Mylar capacitor, 3300p	CQMB332KTH
C125 (570TL)	Mylar capacitor, 1200p	CQMB122KTH
C126 (570TL)	Ceramic capacitor, 22p	CCGB220KOT
C127 (570TL)	" 68p	CCGB680KOT
C129 (570TL)	Mylar capacitor, 1200p	CQMB122KTH
C94 (570TL)	Ceramic capacitor, 27p	CCGB270KOT
C136	Electrolytic capacitor, 0.01	CEAG0R1ZMN
C138	Ceramic capacitor, 100p	CCGB101KOT
C139	Mylar capacitor, 0.082	CQMB823KTH
C141, 142	Ceramic capacitor, 330p	CCFB331KOT
C143	Electrolytic capacitor, 2.2, 25V	CEAE2R2ZMN
C144, 145 (570TL)	" 2.2, 50V	CEAGR22ZMN
C156	Electrolytic capacitor, 220, 25V	CEFF211ALX
C157	" 1000, 25V	CEAE102ALX
C158	" 220, 10V	CEFC221ALX

PSLD016COX

LD1	LED, Red	QLAR5531KR
-----	----------	------------

Main Chassis

PT1	Power transformer, Youth	TPE48A001Y
J1	AC power receptacle, UL/CSA listed, 3-pin	YJA03S002U
J2	Accessory outlet, UL/CSA listed	YJA020005U
J3	Voltage selector receptacle	YJZ10S001U
P1	Voltage selector plug	YPZ06S004U
J4	Fuse holder, UL listed	YHF1S3001U

Symbol No.	Description	Part Code
J5	Antenna terminals	YTD05D001U
S2, 3	Leaf switch, audio mute etc.	SF010115ZF
S1	Lever switch, Power	SL020220SA
C1, 2	Oil-paper capacitor, 0.01, 450VAC	CNST103MAN
F1 (US/CSA)	Fuse, 250mA, 250V, UL listed	ZFBQ25104V
F1 (Europe)	„ 125mA, 250V, UL listed	ZFBQ13103V
F2	Fuse, secondary, 1A, 250V	ZFBQ10203Z
M1	Meter, Signal, 500 μ A	ZMG2052N01
M2	„ Center-tuning, 250 μ A	ZMF4052K01
BA1	RFT, FM antenna balance	TV750301A2
BA2	Loop stick antenna	TEAR200M01
PL1-4	Lamp, 14V/80mA	ZPA148103U
L1 (570T)	AM antenna input, 15 μ H	LF151KA01S

Mechanical Component

Exploded View No.	Description	Part Code
43	Escutcheon (570T)	AM570T**01
„	„ (570TL)	AM570TL*01
52	Cabinet cover	MU897SX010
49	Bottom plate	MS986SZ015
50	Bottom plate leg	VM280EB001
1	Front chassis	MB972SZ006
32	Rear panel	MB972SE03S
23	Left chassis bridge	MU852SZ002
25	Right chassis bridge	MU852SZ003
15	Dial scale bridge	ML942SM001
42	Dial pointer	MJ312SM001
41	Dial pointer bracket	VK121NB001
12	Dial scale (570T)	VS843AC001
„	„ (570TL)	VS843AC002
20	Stringing pulley, left	MS546SZ002
16	„ right	MZ333SZ001
2	Tuning flywheel assembly	AVFLYWL009
9	Meter lamp housing	VB632SW001
22	Mounting bracket holder	MC371SZ002
46	Knob, Tuning	MN386AA026
44	„ Mode	MN376AA019
47	„ Output Level	MN276XA020
45	„ ST-Mono, FM Mute, MPX Fil	VN360SX001
48	„ Power	VN370SX001