

**HITACHI SOLID STATE  
STEREOPHONIC RADIO PHONOGRAPH**

**MODEL DPK-321(U)  
SUPPLEMENT  
SERVICE MANUAL**

NO. 19-1 1971



Model DPK-321(U) is improved by modifying part of the circuit and replacing a few parts as follows;

- 1) The old model picked up short wave signals sometimes during AM broadcast reception.  
To avoid this trouble, in sets from Serial No.35201501 part of RFPCB and the ferrite antenna are modified.
- 2) Varister HV-26 and power transistor 2SC830 are replaced with diode VO-6C and power transistor 2SC1060 respectively (Both interchangeable).

**I. SPECIFICATIONS**

BEFORE ALTERATION	AFTER ALTERATION
<b>Amplifier</b> Diodes.....25	Diodes.....24
<b>AM tuner</b> Sensitivity.....170 $\mu$ V/m(IHF S/N20dB)	Sensitivity .....300 $\mu$ V/m(IHF S/N20dB)

**2. DIAL CORD SETTING**

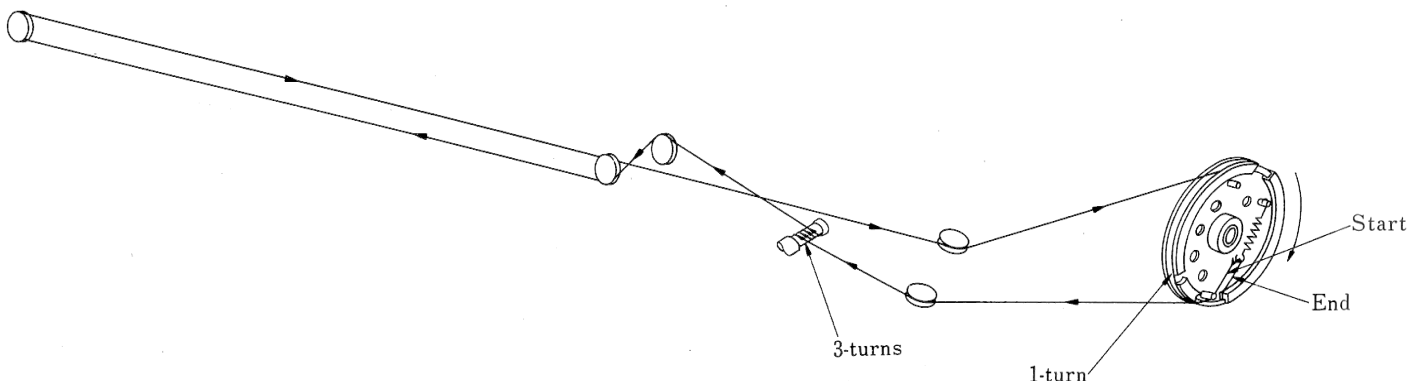

### 3. CIRCUIT BOARD

#### IF · MPX CIRCUIT BOARD

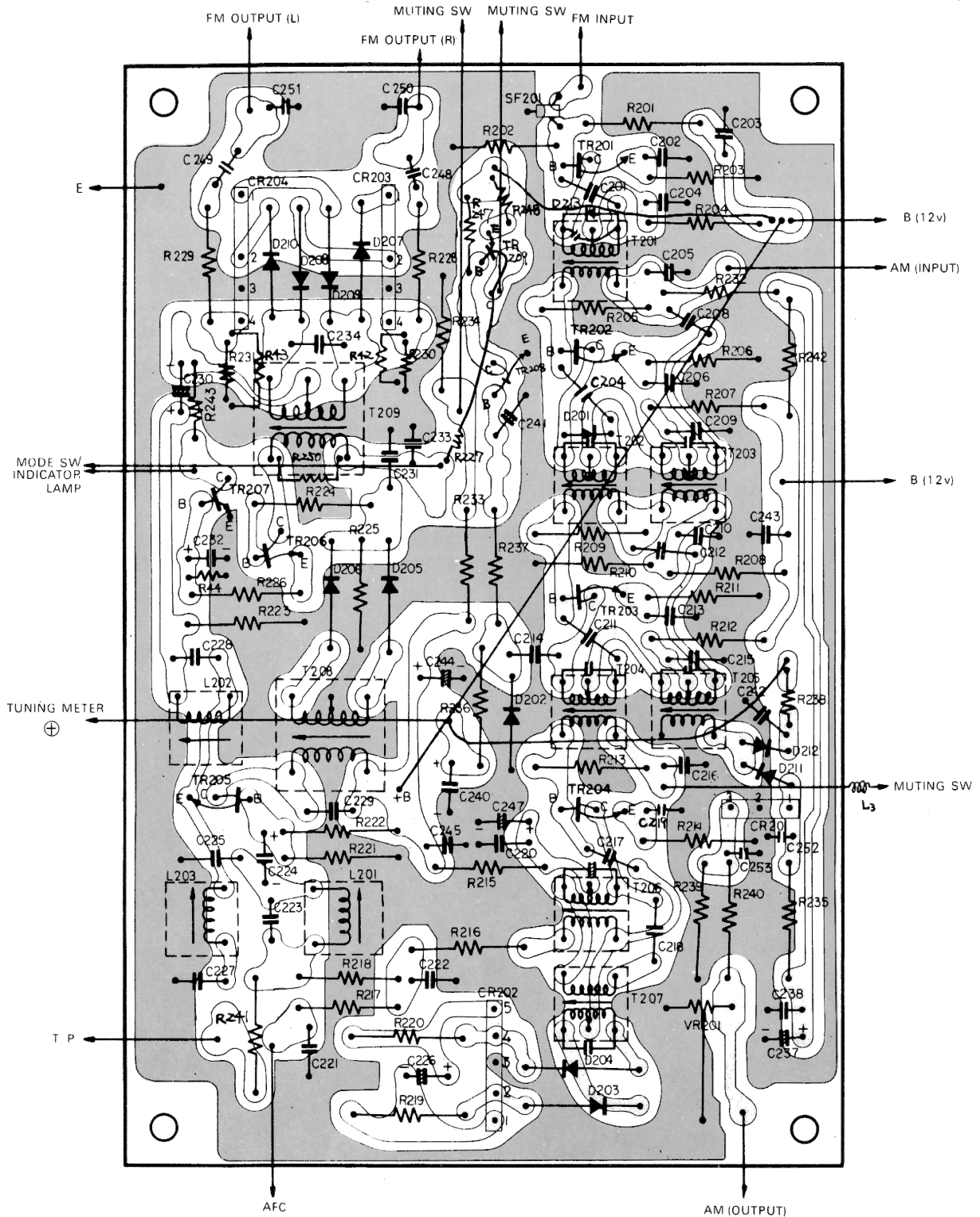

RF CIRCUIT BOARD

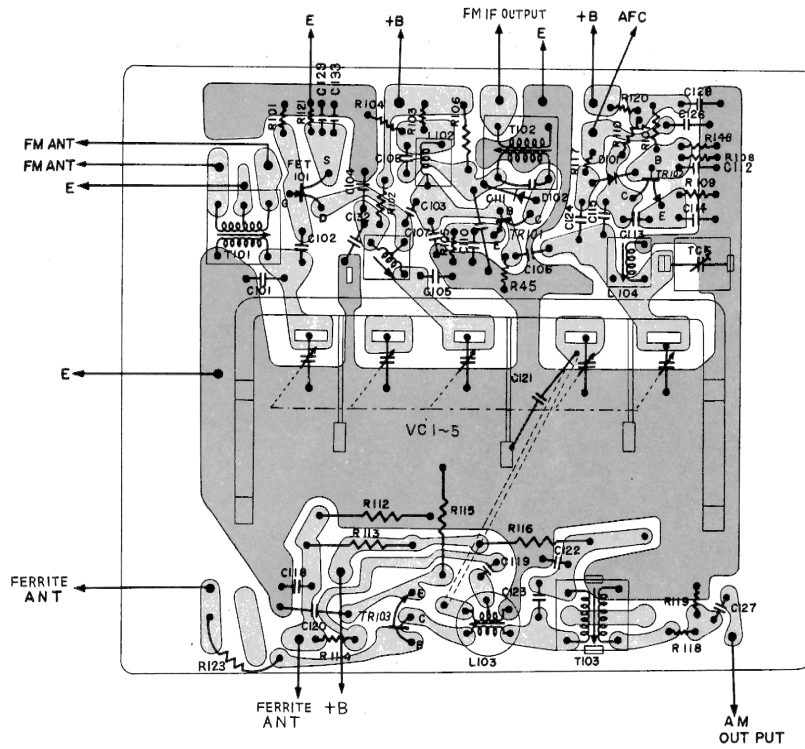

EQUALIZER CIRCUIT BOARD

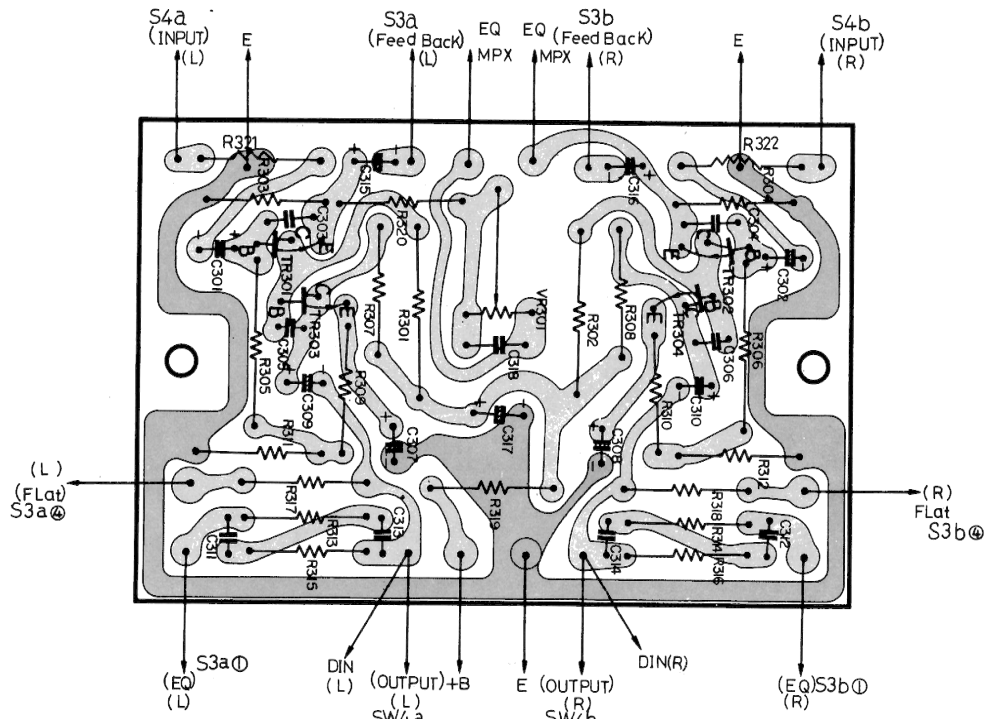

# MODEL DPK-321 SERVICE MANUAL

## MAIN AMP CIRCUIT BOARD

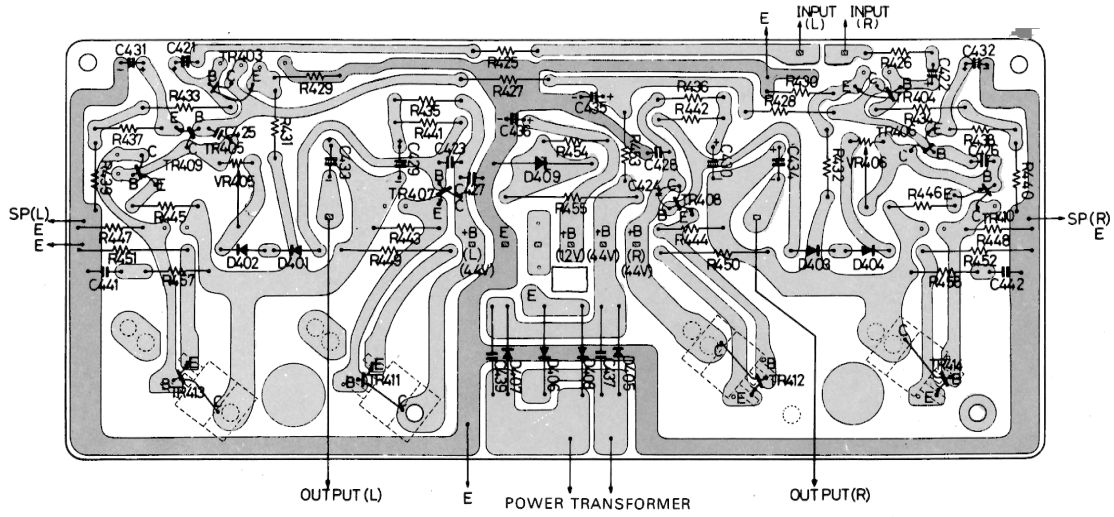

## PRE-AMP CIRCUIT BOARD

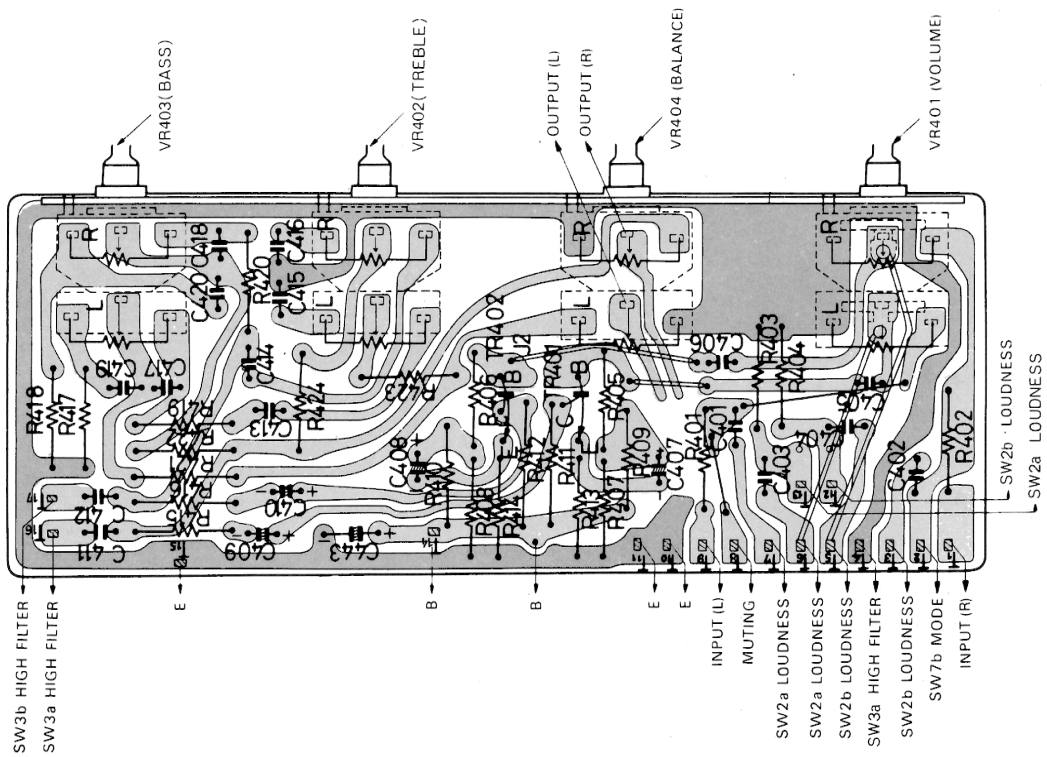

4. STANDARD CIRCUIT DIAGRAM

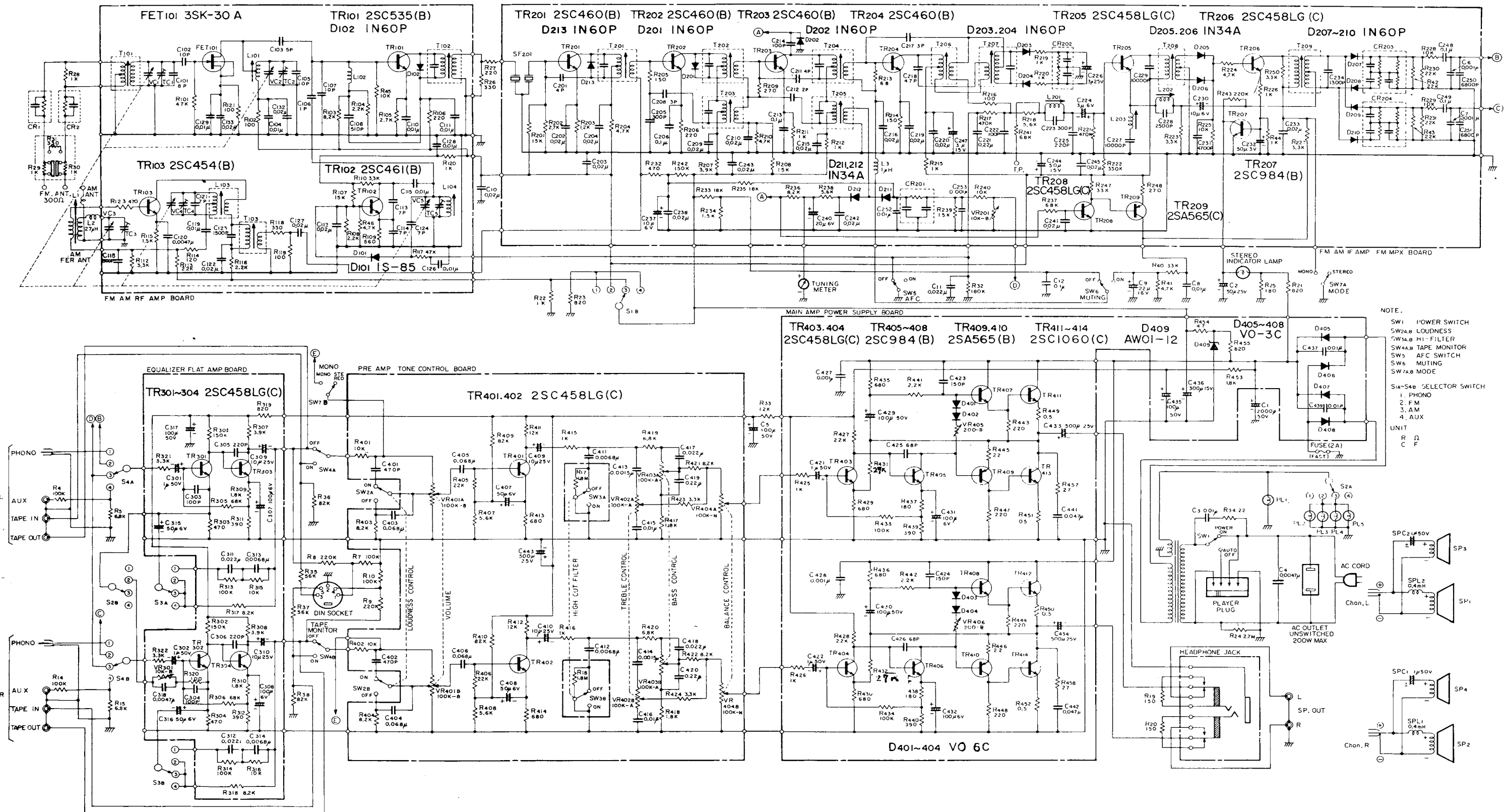

NOTE.

- SW1 POWER SWITCH
- SW2a,b LOUDNESS
- SW3a,b HI-FILTER
- SW4a,b TAPE MONITOR
- SW5 AFC SWITCH
- SW6 MUTING
- SW7a,b MODE

S1a-S4b SELECTOR SWITCH

1. PHONO
2. FM
3. AM
4. AUX

UNIT

R Ω

C F

5. REPLACEMENT PARTS LIST

Note: \* changed parts  
 ○ newly added parts  
 □ removed parts

SYMBOL NO.	STOCK NO.	DESCRIPTION	SYMBOL NO.	STOCK NO.	DESCRIPTION
<b>RF CIRCUIT BOARD</b>			<b>OTHERS</b>		
<b>CAPACITORS</b>			2518302		RF Circuit board assembly
C101	0248648	Ceramic, discal 8pF D 50V	<b>IF - MPX CIRCUIT BOARD</b>		
C102	0248650	Ceramic, discal 10pF K 50V	<b>CAPACITORS</b>		
C103	0248635	Ceramic, discal 5pF ± 0.25pF 50V	C201	0248634	Ceramic, discal 4pF 50V
C104	0245017	Ceramic, discal 0.01μF Z 15V	C202	0245018	Ceramic, discal 0.02μF 15V
C105	0248650	Ceramic, discal 10pF ± 0.5pF 50V	C203	0245018	Ceramic, discal 0.02μF 15V
C106	0248631	Ceramic, discal 1pF ± 0.25pF 50V	C204	0245018	Ceramic, discal 0.02μF 15V
* C107	0248650	Ceramic, discal 10pF J 50V	C205	0248695	Ceramic, discal 300pF 50V
C108	0221328	Styrol 510pF J 35V	C206	0246007	Ceramic, discal 0.1μF 15V
C110	0245017	Ceramic, discal 0.01μF Z 15V	C208	0248633	Ceramic, discal 3pF 50V
C111	0245017	Ceramic, discal 0.01μF Z 15V	C209	0245018	Ceramic, discal 0.02μF 15V
C112	0245018	Ceramic, discal 0.02μF Z 15V	C210	0245018	Ceramic, discal 0.02μF 15V
* C113	0248647	Ceramic, discal 7pF D 50V	C211	0248634	Ceramic, discal 4pF 50V
C114	0248647	Ceramic, discal 7pF D 50V	C212	0248632	Ceramic, discal 2pF 50V
C115	0245017	Ceramic, discal 0.01μF Z 15V	C213	0246007	Ceramic, discal 0.1μF 15V
□ C116			C214	0248684	Ceramic, discal 100pF 50V
C118	0223037	Ceramic, discal 300pF 50V	C215	0245018	Ceramic, discal 0.02μF 15V
C119	0275011	Polyester, film 0.01μF K 50V	C216	0245018	Ceramic, discal 0.02μF 15V
C120	0274015	Polyester, film 0.0047μF 50V	C217	0248633	Ceramic, discal 3pF 50V
C121	0248647	Ceramic, discal 7pF ± 0.5pF 50V	C218	0248676	Ceramic, discal 47pF 50V
C122	0245018	Ceramic, discal 0.02μF Z 15V	C219	0245018	Ceramic, discal 0.02μF 15V
C123	0221128	Styrol 1500pF ± 5% 35V	C220	0245018	Ceramic, discal 0.02μF 15V
* C124	0248647	Ceramic, discal 7pF D 50V	C221	0276111	Polyester, film 0.22μF 50V
C126	0245017	Ceramic, discal 0.01μF Z 15V	C222	0248684	Ceramic, discal 100pF 50V
C127	0245018	Ceramic, discal 0.02μF Z 15V	C223	0223037	Styrol 300pF 50V
C128	0245017	Ceramic, discal 0.01μF Z 15V	C224	0252213	Electrolytic 3μF 6V
C129	0245017	Ceramic, discal 0.01μF Z 15V	C225	0248732	Ceramic, discal 220pF 50V
□ C130			C226	0252213	Electrolytic 3μF 6V
C132	0245018	Ceramic, discal 0.02μF Z 15V	* C227	0221520	Styrol 10000pF 50V
C133	0245018	Ceramic, discal 0.02μF Z 15V	C228	0224011	Styrol 2500pF 50V
VC1-5	0282097	FM/AM variable	* C229	0221520	Styrol 10000pF 50V
TC5	0283113	Trimmer	C230	0252221	Electrolytic 10μF 6V
<b>RESISTORS</b>			C231	0274015	Polyester, film 4700pF 50V
R101	0137909	Carbon film 47kΩ K SRD½SD	C232	0252125	Electrolytic 50μF 3V
R102	0137801	Carbon film 100Ω K SRD½SD	C233	0245018	Polyester, film 0.02μF 50V
R103	0137862	Carbon film 8.2kΩ K SRD½SD	C234	0221127	Styrol 1300pF 50V
R104	0114465	Carbon film 2.2kΩ K SRD½P	C237	0252221	Electrolytic 10μF 6V
R105	0137856	Carbon film 2.7kΩ K SRD½SD	C238	0245018	Ceramic, discal 0.02μF 15V
R106	0137805	Carbon film 220Ω K SRD½SD	□ C239		
R107	0137903	Carbon film 15kΩ K SRD½SD	C240	0252222	Electrolytic 20μF 6V
R108	0137855	Carbon film 2.2kΩ K SRD½SD	C241	0245018	Ceramic, discal 0.02μF 15V
R109	0137810	Carbon film 560Ω K SRD½SD	C242	0245018	Ceramic, discal 0.02μF 15V
R110	0137857	Carbon film 3.3kΩ K SRD½SD	C243	0245018	Ceramic, discal 0.02μF 15V
□ R111			C244	0252525	Electrolytic 50μF 15V
R112	0114467	Carbon film 3.3kΩ K SRD½P	C245	0245018	Ceramic, discal 0.02μF 15V
R113	0114525	Carbon film 22kΩ K SRD½P	C247	0252513	Electrolytic 3μF 15V
* R114	0137802	Carbon film 120Ω K SRD½SD	C248	0276011	Polyester, film 0.1μF 50V
R115	0114462	Carbon film 1.5kΩ K SRD½P	C249	0276011	Polyester, film 0.1μF 50V
R116	0114465	Carbon film 2.2kΩ K SRD½P	C250	0274016	Polyester, film 6800pF 50V
R117	0137909	Carbon film 47kΩ K SRD½SD	C251	0274016	Polyester, film 6800pF 50V
R118	0137807	Carbon film 330Ω K SRD½SD	C252	0245017	Ceramic, discal 0.01μF 15V
R119	0137801	Carbon film 100Ω K SRD½SD	C253	0274011	Polyester, film 0.001μF 50V
R120	0137851	Carbon film 1kΩ K SRD½SD	<b>RESISTORS</b>		
R121	0137801	Carbon film 100Ω K SRD½SD	R201	0114523	Carbon film 15kΩ K SRD½P
□ R122			R202	0114466	Carbon film 2.7kΩ K SRD½P
○ R123	0138369	Carbon film 470Ω K SRD½SD	R203	0114462	Carbon film 1.2kΩ K SRD½P
<b>TRANSISTORS</b>			R204	0114469	Carbon film 4.7kΩ K SRD½P
TR101	0573510	Transistor 2SC535 ⊕	R205	0114443	Carbon film 150Ω K SRD½P
TR102	0573507	Transistor 2SC461 ⊕	R206	0114445	Carbon film 220Ω K SRD½P
TR103	0573491	Transistor 2SC454 ⊕	R207	0114468	Carbon film 3.9kΩ K SRD½P
FET101	2327142	Transistor 3SK30 ⊕	R208	0114523	Carbon film 15kΩ K SRD½P
<b>DIODES</b>			R209	0114446	Carbon film 270Ω K SRD½P
D101	0575010	Diode 1S85	R210	0114469	Carbon film 4.7kΩ K SRD½P
□ D102	0575019	Diode 1N60 (P)	R211	0114461	Carbon film 1kΩ K SRD½P
<b>COILS &amp; TRANSFORMERS</b>			R212	0114461	Carbon film 1kΩ K SRD½P
L101	2134051	FM, RF coil	R213	0114381	Carbon film 68Ω K SRD½P
L102	2134041	FM Trap coil	R214	0114443	Carbon film 150Ω K SRD½P
L103	2120034	AM OSC coil	R215	0114461	Carbon film 1kΩ K SRD½P
L104	2134054	FM OSC coil	R216	0114131	Carbon film 100Ω K SRD½P
T101	2134062	FM Antenna coil	R217	0114549	Carbon film 470kΩ K SRD½P
T102	0322327	FM, IF Transformer	R218	0114470	Carbon film 5.6kΩ K SRD½P
T103	2140441	AM, IF Transformer	R219	0114461	Carbon film 1kΩ K SRD½P
			R220	0114461	Carbon film 1kΩ K SRD½P
			R221	0114549	Carbon film 470kΩ K SRD½P
			R222	0114547	Carbon film 330kΩ K SRD½P
			R223	0114467	Carbon film 3.3kΩ K SRD½P

SYMBOL NO.	STOCK NO.	DESCRIPTION	SYMBOL NO.	STOCK NO.	DESCRIPTION
R224	0114469	Carbon film 4.7kΩ K SRD½P	C313	0274016	Polyester film 0.0068μF K
R225	0114521	Carbon film 10kΩ K SRD½P	C314	0274016	Polyester film 0.0068μF K
R226	0114461	Carbon film 1kΩ K SRD½P	C315	0252225	Electrolytic 50μF 6V
R227	0114467	Carbon film 3.3kΩ K SRD½P	C316	0252225	Electrolytic 50μF 6V
R228	0114521	Carbon film 10kΩ K SRD½P	C317	0252831	Electrolytic 100μF 50V
R229	0114521	Carbon film 10kΩ K SRD½P	C318	0274015	Polyester film 0.0047μF K
R230	0137905	Carbon film 22kΩ K SRD½SD	<b>RESISTORS</b>		
R231	0137905	Carbon film 22kΩ K SRD½SD	R301	0112535	Carbon film 150kΩ K NLRD½P
R232	0114449	Carbon film 470Ω K SRD½P	R302	0112535	Carbon film 150kΩ K NLRD½P
R233	0114524	Carbon film 18kΩ K SRD½P	R303	0114449	Carbon film 470Ω K SRD½P
R234	0114463	Carbon film 1.5kΩ K SRD½P	R304	0114449	Carbon film 470Ω K SRD½P
R235	0114524	Carbon film 18kΩ K SRD½P	R305	0112473	Carbon film 68kΩ K NLRD½P
R236	0114472	Carbon film 8.2kΩ K SRD½P	R306	0112473	Carbon film 68kΩ K NLRD½P
R237	0114531	Carbon film 68kΩ K SRD½P	R307	0114468	Carbon film 3.9kΩ K SRD½P
R238	0137860	Carbon film 5.6kΩ K SRD½SD	R308	0114468	Carbon film 3.9kΩ K SRD½P
R239	0114523	Carbon film 15kΩ K SRD½P	R309	0114464	Carbon film 1.8kΩ K SRD½P
R240	0114521	Carbon film 10kΩ K SRD½P	R310	0114464	Carbon film 1.8kΩ K SRD½P
R241	0114531	Carbon film 68kΩ K SRD½P	R311	0114468	Carbon film 390Ω K SRD½P
R242	0114543	Carbon film 150kΩ K SRD½P	R312	0114468	Carbon film 390Ω K SRD½P
R243	0137955	Carbon film 220kΩ K SRD½SD	R313	0114541	Carbon film 100kΩ K SRD½P
R247	0114527	Carbon film 33kΩ SRD½P	R314	0114541	Carbon film 100kΩ K SRD½P
R248	0137806	Carbon film 270Ω SRD½SD	R315	0114521	Carbon film 10kΩ K SRD½P
* R250	0114467	Carbon film 3.3kΩ SRD½P	R316	0114521	Carbon film 10kΩ K SRD½P
VR201	0151224	Semi-variable 10kΩ -B V10K7	R317	0114472	Carbon film 8.2kΩ K SRD½P
<b>TRANSISTORS</b>			R318	0114472	Carbon film 8.2kΩ K SRD½P
TR201	0573486	Transistor 2SC460 ⊕	R319	0114452	Carbon film 820Ω K SRD½P
TR202	0573486	Transistor 2SC460 ⊕	R320	0114441	Carbon film 100Ω K SRD½P
TR203	0573486	Transistor 2SC460 ⊕	R321	0137851	Carbon film 3.3kΩ K SRD½P
TR204	0573486	Transistor 2SC460 ⊕	R322	0137851	Carbon film 3.3kΩ K SRD½P
TR205	2320073	Transistor 2SC458LG ⊕	VR301	0151224	Variable 10kΩ B
TR206	2320073	Transistor 2SC458LG ⊕	<b>TRANSISTORS</b>		
TR207	2327022	Transistor 2SC984 ⊕	TR301	2320073	Transistor 2SC458LG ⊕
TR208	2320073	Transistor 2SC458LG ⊕	TR302	2320073	Transistor 2SC458LG ⊕
TR209	2320161	Transistor 2SA565 ⊕	TR303	2320073	Transistor 2SC458LG ⊕
<b>DIODES</b>			TR304	2320073	Transistor 2SC458LG ⊕
D201	0575019	Diode 1N60P	<b>OTHERS</b>		
D202	0575019	Diode 1N60P	2517192		EQUALIZER circuit board assembly
D203	0575019	Diode 1N60P	<b>PRE-AMP CIRCUIT BOARD</b>		
D204	0575019	Diode 1N60P	<b>CAPACITORS</b>		
D205	0575002	Diode 1N34A	C401	0243509	Ceramic, discal 470pF J
D206	0575002	Diode 1N34A	C402	0243509	Ceramic, discal 470pF J
D207	0575019	Diode 1N60P	C403	0275016	Polyester film 0.068μF K
D208	0575019	Diode 1N60P	C404	0275016	Polyester film 0.068μF K
D209	0575019	Diode 1N60P	C405	0275016	Polyester film 0.068μF K
D210	0575019	Diode 1N60P	C406	0275016	Polyester film 0.068μF K
D211	0575002	Diode 1N34A	C407	0252225	Electrolytic 50μF 6V
D212	0575002	Diode 1N34A	C408	0252225	Electrolytic 50μF 6V
D213	0575019	Diode 1N60P	C409	0252621	Electrolytic 10μF 25V
<b>COILS &amp; TRANSFORMERS</b>			C410	0252621	Electrolytic 10μF 25V
T201	2140151	FM/IF transformer	C411	0274016	Polyester film 0.0068μF K
T202	0322203	FM/IF transformer	C412	0274016	Polyester film 0.0068μF K
T203	0322208	AM/IF transformer	C413	0274012	Polyester film 0.0015μF K
T204	0322203	FM/IF transformer	C414	0274012	Polyester film 0.0015μF K
T205	0322206	AM/IF transformer	C415	0275011	Polyester film 0.01μF K
T206	2134123	FM discrimination	C416	0275011	Polyester film 0.01μF K
T207	2134124	FM discrimination	C417	0275013	Polyester film 0.022μF K
T208	0313062	19kHz transformer	C418	0275013	Polyester film 0.022μF K
T209	0313062	19kHz transformer	C419	0276013	Polyester film 0.22μF K
SF201	2140401	10.7MHz ceramic filter	C420	0276013	Polyester film 0.22μF K
L201	5120145	71kHz trap coil	C443	0252635	Electrolytic 500μF K 25V
L202	0323002	67kHz trap coil	<b>RESISTORS</b>		
L203	0324005	19kHz trap coil	R401	0114521	Carbon film 10kΩ K SRD½P
<b>OTHERS</b>			R402	0114521	Carbon film 10kΩ K SRD½P
CR201	0599723	Couplate	R403	0114183	Carbon film 8.2kΩ J SRD½P
CR202	0186003	Couplate	R404	0114183	Carbon film 8.2kΩ J SRD½P
CR203	0186007	Couplate	R405	0114525	Carbon film 22kΩ J SRD½P
CR204	0186007	Couplate	R406	0114525	Carbon film 22kΩ J SRD½P
	2517631	IF - MPX circuit board assembly	R407	0114470	Carbon film 5.6kΩ K SRD½P
<b>EQUALIZER CIRCUIT BOARD</b>			R408		

# MODEL DPK-321 SERVICE MANUAL

SYMBOL NO.	STOCK NO.	DESCRIPTION	SYMBOL NO.	STOCK NO.	DESCRIPTION
R422	0114472	Carbon film	*TR412	2327203	Transistor
R423	0114467	Carbon film	*TR413	2327203	Transistor
R424	0114467	Carbon film	*TR414	2327203	Transistor
VR401	0153686	Variable	<b>DIODES</b>		
VR402	0153685	Variable	*D401	2327041	Diode
VR403	0153685	Variable	*D402	2327041	Diode
VR404	0153687	Variable	*D403	2327041	Diode
<b>TRANSISTORS</b>			*D404	2327041	Diode
TR401	2320073	2SC458LG Ⓞ	D405	2327031	Diode
TR402	2320073	2SC458LG Ⓞ	D406	2327031	Diode
<b>OTHERS</b>			D407	2327031	Diode
	2517441	PRE-AMP circuit board assembly	D408	2327031	Diode
<b>MAIN-AMP CIRCUIT BOARD</b>			D409	2327071	Zener diode
<b>CAPACITORS</b>			<b>OTHERS</b>		
C421	0252811	Electrolytic	4354401		Radiator (A)
C422	0252811	Electrolytic	4354521		Radiator (B)
C423	0248728	Ceramic, discal	2517451		MAIN-AMP circuit board assembly
C424	0248728	Ceramic, discal	<b>FOR CHASSIS ASSEMBLY</b>		
C425	0248720	Ceramic, discal	<b>CAPACITORS</b>		
C426	0248720	Ceramic, discal	C 1	0259757	Electrolytic
C427	0274011	Polyester, film	C 2	0252825	Electrolytic
C428	0274011	Polyester, film	C 3	0214469	Oil
C429	0252831	Electrolytic	C 4	0243873	Ceramic, discal
C430	0252831	Electrolytic	C 5	0253408	Electrolytic
C431	0252231	Electrolytic	C 6	0274111	Polyester film
C432	0252231	Electrolytic	C 7	0274111	Polyester film
C433	0252635	Electrolytic	C 8	0245017	Ceramic, discal
C434	0252635	Electrolytic	C 9	0253381	Electrolytic
C435	0252831	Electrolytic	C 10	0245018	Ceramic, discal
C436	0252533	Electrolytic	C 11	0275113	Polyester film
C437	0245408	Ceramic, discal	○ C 12	0246007	Ceramic, discal
C439	0245408	Ceramic, discal	<b>RESISTORS</b>		
C441	0275015	Polyester, film	R 4	0112533	Carbon film
C442	0275015	Polyester, film	R 5	0112384	Carbon film
<b>RESISTORS</b>			R 7	0112533	Carbon film
R425	0114461	Carbon film	R 8	0134401	Composition
R426	0114461	Carbon film	R 9	0134401	Composition
R427	0112467	Carbon film	R 10	0112533	Carbon film
R428	0112467	Carbon film	R 14	0112533	Carbon film
R429	0114451	Carbon film	R 15	0112384	Carbon film
R430	0114451	Carbon film	R 17	0134412	Composition
*R431	0114526	Carbon film	R 18	0134412	Composition
*R432	0114526	Carbon film	R 19	0134363	Composition
R433	0112533	Carbon film	R 20	0134363	Composition
R434	0112533	Carbon film	R 21	0111417	Metal oxide
R435	0114451	Carbon film	R 22	0134373	Composition
R436	0114451	Carbon film	R 23	0134372	Composition
R437	0114444	Carbon film	R 24	0134414	Composition
R438	0114444	Carbon film	R 25	0134364	Composition
R439	0114448	Carbon film	R 26	0114447	Carbon film
R440	0114448	Carbon film	R 27	0114445	Carbon film
R441	0114465	Carbon film	R 28	0114461	Carbon film
R442	0114465	Carbon film	R 29	0114461	Carbon film
R443	0114445	Carbon film	R 30	0114461	Carbon film
R444	0114445	Carbon film	R 31	0114447	Carbon film
R445	0114375	Carbon film	R 32	0114549	Carbon film
R446	0114375	Carbon film	R 33	0134370	Composition
R447	0114445	Carbon film	R 34	0134293	Composition
R448	0114445	Carbon film	R 35	0114219	Carbon film
R449	0149105	Wire wounded	R 36	0114526	Carbon film
R450	0149105	Wire wounded	R 37	0114219	Carbon film
R451	0149105	Wire wounded	R 38	0114526	Carbon film
R452	0149105	Wire wounded	R 40	0114527	Carbon film
R453	0114464	Carbon film	R 41	0114469	Carbon film
R454	0114379	Carbon film	R 42	0114525	Carbon film
R455	0111417	Metal oxide	R 43	0114525	Carbon film
R457	0134294	Composition	R 44	0114461	Carbon film
R458	0134294	Composition	R 45	0114521	Carbon film
VR405	0151223	Variable	R 46	0114469	Carbon film
VR406	0151223	Variable	<b>OTHERS</b>		
<b>TRANSISTORS</b>			CR 1	4560353	Shaft—Tuning shaft assembly
TR403	2320073	Transistor	CR 2	0599675	CR couplate
TR404	2320073	Transistor		0599675	CR couplate
TR405	2327022	Transistor		3910251	Arm—Antenna arm assembly
TR406	2327022	Transistor		4116332	Nut—8 mm $\phi$ nut
TR407	2327022	Transistor		4513311	Screw—Earth screw
TR408	2327022	Transistor	*SW 1	2637034	Switch—Lever switch
*TR409	2320161	Transistor	SW 2~7	2610071	Switch—Lever switch
*TR410	2320161	Transistor		2617081	Switch—Rotary switch
*TR411	2327203	Transistor		2627011	Switch—Slide switch
				2577081	Meter—Tuning meter

# MODEL DPK-321 SERVICE MANUAL

SYMBOL NO.	STOCK NO.	DESCRIPTION	SYMBOL NO.	STOCK NO.	DESCRIPTION
PL1 PL2-5	2760051 2760061 <b>2767081</b> 2720021 <b>2650132</b> 2740241 3715182 2650141 <b>2727062</b> 2720031 0541358 2670061 2681351	Lamp—Pilot lamp (fuse type 6.3V 0.15A) Lamp—Pilot lamp (6.3V 0.15A) Lamp—Pilot lamp (5.5V 22mA) Socket—Pilot lamp socket (fuse type) Socket—Pilot lamp socket Cord—AC cord Bushing Socket—AC socket Holder—Fuse holder Fuse—Fuse (2A) fast Socket—5P socket (rec & p.b.) Pin jack—2P US pin jack Terminal board—Antenna terminal board (3P bolt terminal)			
* L 1 L 2 L 3	2677062 2667015 2780641 <b>2757071</b> 2227035 2227041 2217131 0544404 2687062 0544404 4720512 <b>0544384</b> <b>2687072</b>	Jack—Headphone jack Socket—Amp rock Crip—Cord crip Ferrite antenna Choke coil (27 $\mu$ H) Choke coil (1 $\mu$ H) Power transformer Terminal board—2P terminal board Terminal board—2P terminal board Terminal board—6P terminal board Clamp Terminal board—4P terminal board Terminal board—4P terminal board			
* O O					
			SP1, 2 SP3, 4 SPC1.2	3197791 3910173 4680281 3386121 <b>0662084</b> 0666704 3712283  3240275 3280302 3280371 4511353 0040045 3710471 3911243  4920991 4922291 4770254 4921021 0044227 4720971 2410151 2410041 0257051 2687081  0544402 2270051 3711861	<b>MISCELLANEOUS</b>  <b>for Dial mechanism assembly</b> Dial scale Indicator—Dial indicator Cover—Indicator cover Dial pointer assembly Spring Cord—Dial cord holding fixture Pulley—Dial pulley  <b>for Final assembly</b> Escutcheons assembly Knob—Knob for Knob—Knob for Bolt—4 mm $\phi$ $\times$ 25 mm bolt Washer—F10 washer Cap—Headphone cap Cover—Dust cover assembly  <b>for Cabinet assembly</b> Cabinet—Speaker cabinet assembly Cabinet—Center cabinet assembly Nut—Nut with 3 $\phi$ washer { for speaker { for network coil Cover—M321 back-cover for speaker cabinet Screw—3.1mm $\phi$ $\times$ 20 mm screw Cover—Choke cover Speaker—20 cm speaker Speaker—Phone tweeter Electrolytic capacitor (1 $\mu$ F 50V) Terminal board—2P terminal board (for speaker terminal) Terminal board—2P terminal board Coil—Network coil (0.4mH) Leg—S45 leg
					<b>ACCESSORIES</b>
				0043491 4355124 2747171	FM antenna assembly Player driver Cord—Speaker junction cord

## HITACHI SALES CORPORATION OF AMERICA

New York 48-50, 34th Street, Long Island City, N.Y. 11101  
Tel. (212) 361-3090

Chicago 1400 Morse Ave., Elk Grove Village, Chicago,  
Illinois 60007 Tel.(312)593-7500

Los Angeles 2550 Santa Fe Ave. Redondo Beach Calif. 90278  
Tel. (213) 644-3655 (213) 772-6571

Dallas 1121 Round Table Drive, Dallas, Texas 75247  
Tel. (214) 638-5820

## HITACHI SALES CORPORATION OF HAWAII, INC.

743-G Waiakamilo Road, Honolulu, Hawaii 96817  
Tel. 841-431

## HITACHI SALES CORPORATION OF CANADA LTD.

9601 Cote De Liesse Rd. Dorval 760, P.Q.



Head Office : 5-1, 1-chome, Marunouchi, Chiyoda-ku, Tokyo  
Tel. Tokyo (212) 1111 (80 lines)

Cable Address : "HITACHY" TOKYO

Codes : All Codes Used