

# HITACHI

## SERVICE MANUAL

TY

No. 411 EGF

# HTA-12

(FT-12, HA-12)

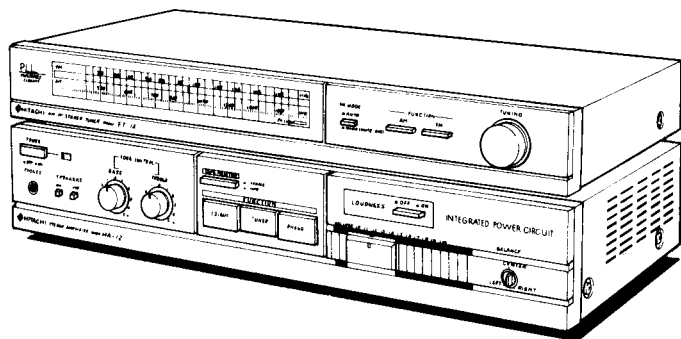

The HTA-12 comes in two color versions, black and silver. They are the same except for parts list.

Der HTA-12 wird in zwei Versionen geliefert, schwarz und silber. Sie sind gleich mit Ausnahme der Teilleiste.

Le HTA-12 est disponible en deux versions, noir et argent. Elles sont identiques à l'exception de la liste des pièces.

### CONTENTS · INHALT · SOMMAIRE

SPECIFICATIONS · TECHNISCHE DATEN · CARACTÉRISTIQUES TECHNIQUES	1 ~ 4
DIAL CORD SETTING · SKALENSEILEINSTELLUNG · EQUIPEMENT DE CADRAN	4
DISASSEMBLY AND REPLACEMENT · ZERLEGUNG UND AUSTAUSCH · DEMONTAGE ET REMONTAGE	5
BLOCK DIAGRAM · BLOCK SCHEMA · SCHEMA	6
GENERAL ALIGNMENT INSTRUCTION · ALLGEMEINE AUSRICHTANLEITUNG · INSTRUCTIONS GENERALES	7
FM TUNER ALIGNMENT · ABGLEICH DES UKW-TUNERS · REGLAGE DE TUNER FM	7, 8
AM TUNER ALIGNMENT · ABGLEICH DES AM-TUNERS · REGLAGE DE TUNER AM	9, 10
PRINTED WIRING BOARD · PRINTPLATTEN · PLAN DE BASE	11, 13, 15, 17
CIRCUIT DIAGRAM · SCHALTPLAN · PLAN DE BASE	12, 14, 16, 17
FRONT AND REAR PANEL · VORDERE UND HINTERE BEDIENUNGSTAFEL · PANNEAUX AVANT ET ARRIERE	18, 19
REPLACEMENT PARTS LIST · ERSATZTEILISTE · TABLEAU DES PIÈCE	20 ~ 25

### SAFETY PRECAUTION

The following precautions should be observed when servicing.

- Since many parts in the unit have special safety related characteristics, always use genuine Hitachi's replacement parts. Especially critical parts in the power circuit block should not be replaced with other makers. Critical parts are marked with  $\Delta$  in the circuit diagram and printed wiring board.
- Before returning a repaired unit to the customer, the service technician must thoroughly test the unit to ascertain that it is completely safe to operate without danger of electrical shock.

## SPECIFICATIONS

### FT-12

<b>Circuitry</b>	AM/FM 2-band Stereo tuner MW/LW/FM 3-band Stereo tuner	<b>Selectivity</b>	50 dB
<b>• FM SECTION</b>		<b>Stereo separation</b>	40 dB (1 kHz) [except for W. Germany & Italy]
<b>Frequency range</b>	88 - 108 MHz	<b>Capture ratio</b>	1.0 dB
<b>Usable Sensitivity</b>	11.2 dBf (IHF), 1.0 $\mu$ V (75 ohms DIN)	<b>Output voltage</b>	550 mV (1 kHz)
<b>50 dB Quieting Sensitivity</b>	22.4 dBf (MONO) 39.5 dBf (STEREO)	<b>• AM (MW) SECTION</b>	
<b>Image interference ratio</b>	45 dB (98 MHz)	<b>Frequency range</b>	530 - 1,605 kHz
<b>Total harmonic distortion</b>	MONO : 0.3 % (1 kHz) STEREO : 0.4 % (1 kHz)	<b>Sensitivity</b>	40 $\mu$ V (DIN) ... S/N 26 dB 20 $\mu$ V (IHF) 500 $\mu$ V/m (IHF Loop antenna)
<b>Signal-to-noise ratio</b>	MONO : 75 dB (IHF) 65 dB (IEC, unweighted, Q-peak) 60 dB (IEC, weighted, Q-peak) STEREO : 70 dB (IHF) 60 dB (IEC, unweighted, Q-peak) 55 dB (IEC, weighted, Q-peak)	<b>Image interference ratio</b>	38 dB
<b>Frequency response</b>	50 Hz - 12 kHz (50 $\mu$ s $\pm$ 2 dB) 50 Hz - 15 kHz (50 $\mu$ s $\begin{smallmatrix} +1.0 \\ -6.0 \end{smallmatrix}$ dB) [for W. Germany & Italy] 50 Hz - 12 kHz (75 $\mu$ s $\pm$ 2 dB) [for U.S.A. & Canada]	<b>Selectivity</b>	35 dB
		<b>Signal-to-noise ratio</b>	45 dB
		<b>Output voltage</b>	165 mV (400 Hz, 30% modulation)
		<b>• AM (LW) SECTION</b>	
		<b>Frequency range</b>	150 - 350 kHz
		<b>Sensitivity</b>	200 $\mu$ V (DIN) ... S/N 26 dB
		<b>• GENERAL</b>	
		<b>Dimensions</b>	435(W) $\times$ 60(H) $\times$ 236(D) mm
		<b>Weight</b>	2.4 kg (5.3 lbs.)

SPECIFICATIONS AND PARTS ARE SUBJECT TO CHANGE FOR IMPROVEMENT.

# STEREO TUNER AMPLIFIER

March 1984

TOYOKAWA WORKS

## HA-12

<b>Power output</b> <b>(Both channels driven)</b>	28 watts + 28 watts* min RMS, at 8 ohms from 40 Hz to 20 kHz, with no more than 0.9% total harmonic distortion. 30 W + 30 W (8 ohms, 1 kHz, T.H.D. 0.7% IEC) 30 W/ch + 30 W/ch (8 ohms 40 - 20 kHz, T.H.D., 0.7%)	<b>Output level</b> <b>TAPE REC OUT</b>	170 mV
<b>Power bandwidth</b>	10 Hz - 30 kHz (8 ohms, T.H.D. 0.5% 1/2 Rated)	<b>Phono overload level</b> <b>(at 1 kHz)</b>	140 mV
<b>Frequency characteristics</b> <b>TUNER, CD/AUX, TAPE</b>	20 Hz - 30 kHz ( $\pm 2$ dB)	<b>Signal-to-noise ratio</b> <b>(IHF, A network)</b>	72 dB
<b>PHONO</b>	30 Hz - 15 kHz (RIAA $\pm 0.5$ dB)	<b>PHONO</b>	95 dB
<b>Harmonic distortion</b> <b>(at rated output)</b>	Less than 0.5%	<b>TUNER, CD/AUX, TAPE</b>	20 (1 kHz)
<b>(at 1/2 rated output)</b>	Less than 0.1%	<b>Damping factor</b>	$\pm 8$ dB (100 Hz)
<b>Intermodulation distortion</b> <b>(at 1/2 rated output)</b>	Less than 0.2%	<b>Bass control</b>	$\pm 8$ dB (10 kHz)
<b>Input sensitivity/</b> <b>Impedance</b>		<b>Treble control</b>	+7 dB (100 Hz)
<b>PHONO</b>	3.0 mV/47 k-ohms	<b>Loudness control</b>	+4 dB (10 kHz)
<b>TUNER</b>	190 mV/40 k-ohms	<b>Power supply</b>	AC 120 V 60Hz, ~220 V 50/60 Hz, ~240 V 50/60 Hz or ~120 V/220 V/240 V 50/60Hz
<b>TAPE PLAY</b>	190 mV/40 k-ohms	<b>Power consumption</b>	60 W (at 1/10 rated output) 100 W (at 1/3 rated output) 150 W (at rated output)
<b>CD/AUX</b>	190 mV/40 k-ohms	<b>Dimensions</b>	435(W) $\times$ 83(H) $\times$ 230(D) mm
		<b>Weight</b>	4.0 kg

\* Measured pursuant to the Federal Trade Commission's Trade Regulation Rule on Power Output Claims for Amplifiers.

**NOTE** : Multi voltage unit can be operated on ~110 V to 120 V, ~200 V to 220 V or ~230 V to 240 V (When the boltage selector setting is changed).

## SICHERHEITSMASSNAHMEN

Bei Wartungsarbeiten sind die folgenden Sicherheitsmaßnahmen zu beachten :

- Da verschiedene Teile dieses Gerätes Sicherheitsfunktionen aufweisen, nur Original-Hitachi-Ersatzteile verwenden. Kritische Teile im Netzteil sollten nicht durch ähnliche Teile anderer Hersteller ersetzt werden. Alle kritischen Teile sind im Schaltplan und im Diagramm der Schaltplatinen mit dem Symbol  $\Delta$  gekennzeichnet.
- Vor der Auslieferung eines reparierten Gerätes an den Kunden muß der Wartungstechniker das Gerät einer gründlichen Prüfung unterziehen, um sicherzustellen, daß sicherer Betrieb ohne die Gefahr von elektrischen Schlägen gewährleistet ist.

## TECHNISCHE DATEN

### FT-12

<b>Type</b>	Zwei-Wellenbereichs-Stereotuner MW/UKW Drei-Wellenbereichs-Stereotuner MW/LW/UKW	<b>Trennschärfe</b>	50 dB
<b>• UKW-Teil</b>		<b>Übersprechdämpfung</b>	40 dB (1 kHz) [außer die Bundesrepublik Deutschland und Italien]
<b>Empfangsbereich</b>	88 MHz bis 108 MHz	<b>Gleichwellenselektion</b>	1,0 dB
<b>Nutzbare Empfindlichkeit</b>	11,2 dBf (IHF), 1,0 $\mu$ V (75 Ohm DIN)	<b>Ausgangsspannung</b>	500 mV (1 kHz, 40 kHz Hub)
<b>50-dB-Geräusch-dämpfung</b>	22,4 dBf (Mono) 39,5 dBf (Stereo)	<b>• MW-Teil</b>	
<b>Spiegelfrequenzdämpfung</b>	45 dB (98 MHz)	<b>Empfangsbereich</b>	530 kHz - 1605 kHz
<b>Klirrfaktor</b>	MONO : 0,3 % (1 kHz) STEREO : 0,4 % (1 kHz)	<b>Empfindlichkeit</b>	40 $\mu$ V (DIN) ... S/N 26 dB 20 $\mu$ V (IHF) 500 $\mu$ V/m (IHF Zimmer antenne)
<b>Rauschabstand</b>	MONO : 75 dB (IHF) 65 dB (Fremdspannung sabstand) 60 dB (Geräuschspannung sabstand) STEREO : 70 dB (IHF) 60 dB (Fremdspannung sabstand) 55 dB (Geräuschspannung sabstand)	<b>Spiegelfrequenz-Dämpfung</b>	38 dB
<b>Übertragungsbereich</b>	50 Hz bis 12 kHz (50 $\mu$ s $\pm 2,0$ dB) 50 Hz bis 15 kHz (50 $\mu$ s $\pm 1,0$ dB) [für die Bundesrepublik Deutschland und Italien] 50 kHz bis 12 kHz (75 $\mu$ s $\pm 2$ dB) [für USA und Kanada]	<b>Trennschärfe</b>	35 dB ( $\pm 9$ kHz)
		<b>Signal-Geräuschabstand</b>	45 dB
		<b>Ausgangsspannung</b>	165 mV (400 Hz, 30% Modulation)
		<b>• LW-Teil</b>	
		<b>Empfangsbereich</b>	150 - 350 kHz
		<b>Empfindlichkeit</b>	200 $\mu$ V (DIN) ... S/N 26 dB
		<b>• Allgemeine Daten</b>	
		<b>Abmessungen</b>	435(B) $\times$ 60(H) $\times$ 236(T) mm
		<b>Gewicht</b>	2,4 kg (5,3 lbs.)

HA-12

<b>Ausgangsleistung</b>	28 Watt/Kanal + 28 Watt/Kanal (beide Kanäle ausgesteuert an 8 Ohm, 40 Hz – 20 kHz, T.H.D., 0,9%)	<b>Ausgangspegel</b>	170 mV
<b>DIN 4/8 Ohm</b>	30 Watt/Kanal + 30 Watt/Kanal (8 Ohm, 1 kHz, T.H.D. 0,7 % IEC)	<b>Phonoüberlastungspegel (bei 1 kHz)</b>	140 mV
<b>Leistungsbandbreite</b>	30 Watt/Kanal + 30 Watt/Kanal (8 Ohm, 40 Hz – 20 kHz, T.H.D., 0,7 %)	<b>Geräuschspannungsabstand (IHF, A-Nets)</b>	72 dB
<b>Frequenzcharakteristik TUNER, CD/AUX, TAPE PHONO</b>	10 Hz – 30 kHz (an 8 Ohm, Klirrgrad 0,5 %, halbe Nennleistung)	<b>PHONO TUNER, CD/AUX, TAPE</b>	95 dB
<b>Klirrfaktor (bei Nennleistung)</b>	20 Hz – 30 kHz ( $\pm 2$ dB)	<b>Dämpfungsfaktor</b>	20 (1 kHz)
<b>(bei halber Nennleistung)</b>	30 Hz – 15 kHz	<b>Tiefeneinstellung</b>	$\pm 8$ dB (100 Hz)
<b>Intermodulations-Verzerrung (bei halber Nennleistung)</b>	(RIAA-Kennlinie $\pm 0,5$ dB)	<b>Höheneinstellung</b>	$\pm 8$ dB (10 kHz)
<b>Eingangsempfindlichkeit/ Impedanz</b>		<b>Gehörrichtige Lautstärkekorrektur</b>	+7 dB (100 Hz) +4 dB (10 kHz)
<b>PHONO</b>	3,0 mV/47 k-Ohm	<b>Netzspannung</b>	Wechselstrom 120 V 60 Hz, ~220 V 50/60 Hz, ~240 V 50/60 Hz oder ~120 V/220 V/240 V 50/60 Hz
<b>TUNER</b>	190 mV/40 k-Ohm	<b>Leistungsafnahme</b>	60 W (bei 1/10 Nennleistung) 100 W (bei 1/3 Nennleistung) 150 W (bei Nennleistung)
<b>TAPE PLAY</b>	190 mV/40 k-Ohm	<b>Abmessungen</b>	435(B) $\times$ 83(H) $\times$ 230(T) mm
<b>CD/AUX</b>	190 mV/40 k-Ohm	<b>Gewicht</b>	4,0 kg

Anderungen der Konstruktion und technischen Daten bleiben im Sinne der ständigen Verbesserung vorbehalten.

**HINWEIS :** Das Gerät ist zum Betrieb mit verschiedenen Spannungen ausgelegt und kann mit ~100 V bis 120 V, ~200 V bis 220 V oder ~230 V bis 240 V betrieben werden (wenn die Einstellung des Spannungswählers entsprechend verändert wird).

**PRÉCAUTIONS DE SÉCURITÉ**

Les précautions suivantes doivent être observées chaque fois qu'une réparation doit être faite.

1. Etant donné que de nombreux composants de l'appareil possèdent des caractéristiques relatives à la sécurité, utiliser uniquement des pièces de rechange d'origine Hitachi pour effectuer un remplacement. Ceci se rapporte notamment aux pièces critiques du bloc d'alimentation qui ne doivent en aucun cas être remplacées par celles d'autres fabricants. Les pièces critiques sont accompagnés du symbole  $\Delta$  dans le schéma de montage et sur le schéma de plaque de câblage.
2. Avant de retourner l'appareil réparé au client le technicien doit procéder à un essai complet pour s'assurer qu'il ne présente aucun danger de chocs électriques.

**CARACTÉRISTIQUES TECHNIQUES**

FT-12

<b>Circuit</b>	Tuner stéréo 2 gammes AM/FM Tuner stéréo 3 gammes PO/GO/FM	<b>Sélectivité</b>	50 dB
<b>SECTION FM</b>		<b>Séparation stéréo</b>	40 dB (1 kHz) [sauf pour l'Allemagne de l'Ouest et Italie]
<b>Plage de fréquence</b>	88 – 108 MHz	<b>Taux de capture</b>	1,0 dB
<b>Sensibilité utilisable</b>	11,2 dBf (IHF), 1,0 $\mu$ V (75 ohms DIN)	<b>Tension de sortie</b>	500 mV (1 kHz, 40 kHz déviation)
<b>Sensibilité pour recul du druit de fond de 50 dB</b>	22,4 dBf (MONO) 39,5 dBf (STÉRÉO)	<b>SECTION PO (MW)</b>	
<b>Taux d'interférence image</b>	45 dB (98 MHz)	<b>Plage de fréquence</b>	530 – 1605 kHz
<b>Distorsion harmonique totale</b>	MONO : 0,3 % (1 kHz) STEREO : 0,4 % (1 kHz)	<b>Sensibilité</b>	40 $\mu$ V (DIN) ... S/N 26 dB 20 $\mu$ V (IHF) 500 $\mu$ V/m (IHF antenna-cadre)
<b>Rapport signal/bruit</b>	MONO : 75 dB (IHF) 65 dB (IEC, non pondéré, crête Q) 60 dB (IEC, pondéré, crête Q) STEREO : 70 dB (IHF) 60 dB (IEC, non pondéré, crête Q) 55 dB (IEC, Pondéré, crête Q)	<b>Taux d'interférence image</b>	38 dB
<b>Réponse de fréquence</b>	50 Hz – 12 kHz (50 $\mu$ s $\pm 2,0$ dB) 50 Hz – 15 kHz (50 $\mu$ s $\pm 1,0$ dB) [pour l'Allemagne de l'Ouest et Italie] 50 kHz – 12 kHz (75 $\mu$ s $\pm 2$ dB) [pour les Etats-Unis et le Canada]	<b>Sélectivité</b>	35 dB ( $\pm 9$ kHz)
		<b>Rapport signal/bruit</b>	45 dB
		<b>Tension de sortie</b>	165 mV (400 Hz, 30 % modulation)
		<b>SECTION GO (LW)</b>	
		<b>Plage de fréquence</b>	150 – 350 kHz
		<b>Sensibilité</b>	200 $\mu$ V (DIN) ... S/N 26 dB
		<b>DONNESS GENERALES</b>	
		<b>Dimentions</b>	435(L) $\times$ 60(H) $\times$ 236(P) mm
		<b>Poids</b>	2,4 kg (5,3 lbs.)

**HA-12**

<b>Puissance de sortie</b>	28 W/can.+28 W/can. (deux canaux en fonction sous 8 ohms, 40 Hz – 20 kHz, D.H.T. 0,9%) 30 W/can. + 30 W/can. (8 ohms, 1 kHz, D.H.T. 0,7% IEC). 30 W/can. + 30 W/can. (8 ohms, 40 Hz – 20 kHz, D.H.T. 0,7%)	<b>Niveau de sortie</b>	160 mV
<b>Bande passante</b>	10 Hz – 30 kHz (8 ohms, D.H.T. 0,5% 1/2 de la puissance nominale)	<b>TAPE REC OUT</b>	140 mV
<b>Caractéristiques de fréquence</b>		<b>Niveau de surcharge phono (à 1 kHz)</b>	140 mV
<b>TUNER, CD/AUX, TAPE</b>	20 Hz – 30 kHz (±2 dB)	<b>Rapport signal/bruit (IHF, réseau A)</b>	72 dB
<b>PHONO</b>	30 Hz – 15 kHz (RIAA ±0,5 dB)	<b>PHONO</b>	95 dB
<b>Distorsion harmonique (à la puissance nominale)</b>	Inférieure à 0,5%	<b>TUNER, CD/AUX, TAPE</b>	20 (1 kHz)
<b>(à la moitié de la puissance nominale)</b>	Inférieure à 0,1%	<b>Facteur d'amortissement</b>	±8 dB (100 Hz)
<b>Distorsion d'intermodulation (à la moitié de la puissance nominale)</b>	Inférieure à 0,2%	<b>Réglage de graves</b>	±8 dB (10 kHz)
<b>Sensibilité d'entrée/ Impédance</b>		<b>Réglage des aigues</b>	+7 dB (100 Hz)
<b>PHONO</b>	3,0 mV/47 k-ohms	<b>Correction physiologique</b>	+4 dB (10 kHz)
<b>TUNER</b>	190 mV/40 k-ohms	<b>Alimentation</b>	CA 120 V 60 Hz, ~220 V 50/60 Hz, ~240 V 50/60 Hz ou ~120 V/220 V/240 V 50/60 Hz
<b>TAPE PLAY</b>	190 mV/40 k-ohms	<b>Consommation</b>	60 W (à 1/10 de la puissance nominale) 100 W (à 1/3 de la puissance nominale) 150 W (à la puissance nominale)
<b>CD/AUX</b>	190 mV/40 k-ohms	<b>Dimensions Poids</b>	435(L) × 83(H) × 230(P) mm 4,0 kg

Les caractéristiques techniques et la présentation peuvent être modifiées sans préavis pour des raisons d'amélioration.

**REMARQUE :** Une unité acceptant diverses tensions peut être alimentée sur ~110 V – 120 V, ~200 V – 220 V ou ~230 V – 240 V, moyennant un réglage du sélecteur de tension.

**DIAL CORD SETTING • SKALENSEILEINSTELLUNG • EQUIPEMENT DE CADRAN** FT-12

**Specification :**

After setting the dial cord, make the pointer go and return three times within the pointer stroke (the variable capacitor opens and closes three times). When the cord tension is thus equalized, make adjustment so that the tip (a) of the trigger spring matches with the point (b) shown on the pulley. Set the zero point of the pointer in this status.

**Spezifikation :**

Bewegen Sie den Zeiger nach dem Einstellen der Skalenantriebsschnur 3 mal über den gesamten Bewegungsbereich hin und her (der Drehkondensator wird 3 mal geöffnet und geschlossen). Wenn die Schnurspannung auf diese Weise ausgeglichen worden ist, so führen Sie Einstellung so durch, daß die Spitze (a) der Auslösefeder mit dem auf der Schnurscheibe gezeigten Punkt (b) übereinstimmt. Setzen Sie den Nullpunkt des Zeigers in diesem Zustand ein.

**Spécifications :**

Après l'installation de la corde à cadran, faire va-et-vient de l'aiguille trois fois dans la course de l'aiguille (le condensateur variable s'ouvre et se ferme trois fois). Lorsque la tension de la corde est ainsi égalisée, régler de sorte que le bout (a) du ressort de détente corresponde au point (b) indiqué sur la poulie. Régler le point zéro de l'aiguille à cet état.

**Position of 0 point :**

The 0 point is located on the 0.15 mm thick line, which is the second line to the right of the letters FM and AM.

**Position des Nullpunkts**

Der Nullpunkt befindet sich auf der 0,15 mm dicken Linie, die die zweite Linie rechts von den Buchstaben FM und AM ist.

**Position du point 0**

La position du point 0 se trouve sur la ligne de 0,15 mm de large, qui est la deuxième à compter des lettres FM et AM.

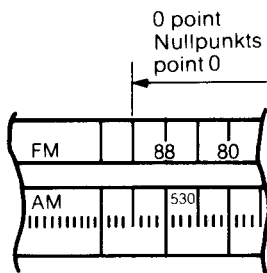

Apply Diabond DY-471A  
Diabond DY-471A auftragen.  
Appliquer le Diabond DY-471A

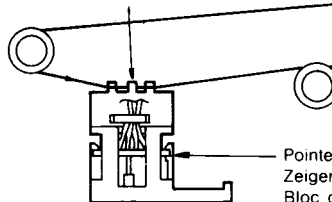

Apply Diabond DY-471A.  
Diabond DY-471A auftragen.  
Appliquer le Diabond DY-471A.

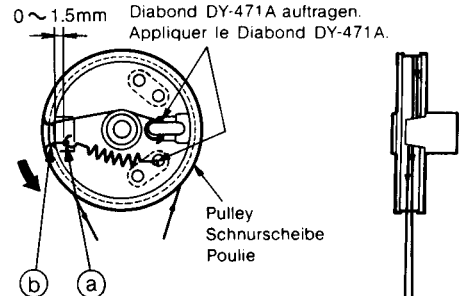

Pointer Assembly  
Zeigermontage  
Bloc d'aiguille

3 tours  
3 Wicklungen  
3 turns  
Tuning shaft  
Drehwelle  
Arbre rotatif

# DISASSEMBLY AND REPLACEMENT • ZERLEGUNG UND AUSTAUSCH • DEMONTAGE ET REMONTAGE

## FT-12

1. The cover can be detached by removing the screw ①.
2. The P.W.B. can be detached by removing the screws ② and ③.

1. Die Abdeckung kann nach Entfernen der Schraube ① entfernt werden.
2. Die gedruckte Schaltplatte kann nach Entfernen der Schrauben ② und ③ entfernt werden.

1. Le couvercle peut être détaché en enlevant la vis ①.
2. Le socle peut être détaché en enlevant les vis ② et ③.

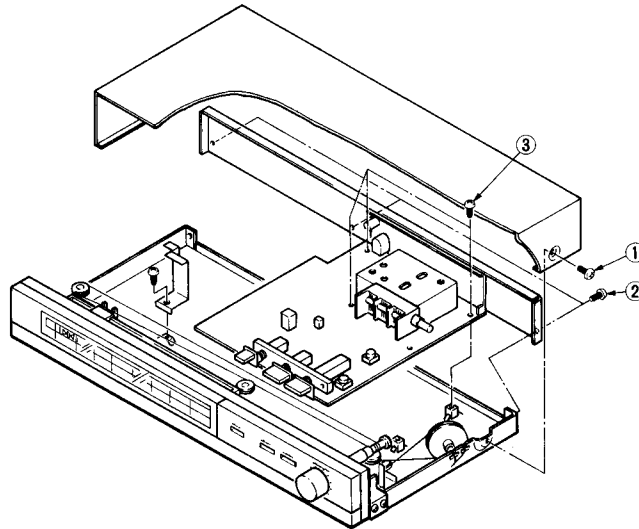

## HA-12

1. By loosening the screw ①, the cover can be removed.
2. Loosen the screws ② through ⑥, raise the rear plate slightly and slightly pull the front panel forward.
3. The board can be set upright with the rear plate and front panel kept mounted.
4. By loosening the screw ⑤ through ⑦, in the front panel can be removed.

1. Wenn die Schraube ① entfernt wird, kann die abdeckung entfernt werden.
2. Entfernen Sie die Schrauben ② bis ⑥, heben Sie das hintere Blech etwas an, und ziehen Sie die Frontplatte etwas nach vorne heraus.
3. Die Grundplatte kann aufgestellt werden, während hinteres Blech und Frontplatte angebracht sind.
4. Wenn die Schraube ⑤ bis ⑦, entfernt wird, kann die Frontplatte entfernt werden.

1. En desserrant la vis ①, on peut enlever le couvercle.
2. Desserrer les vis ② à ⑥, lever un peu la plaque arrière et extraire légèrement en avant le tableau avant.
3. On peut redresser la plaquette la plaque arrière et le tableau avant maintenus associés.
4. En desserrant la vis ⑤ à ⑦, on peut enlever le tableau avant.

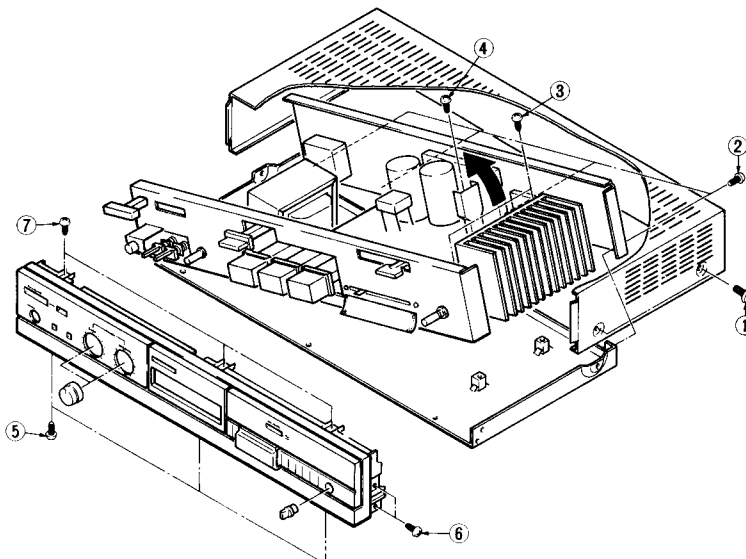

BLOCK DIAGRAM • BLOCK SCHEMA • SCHEMA

FT-12

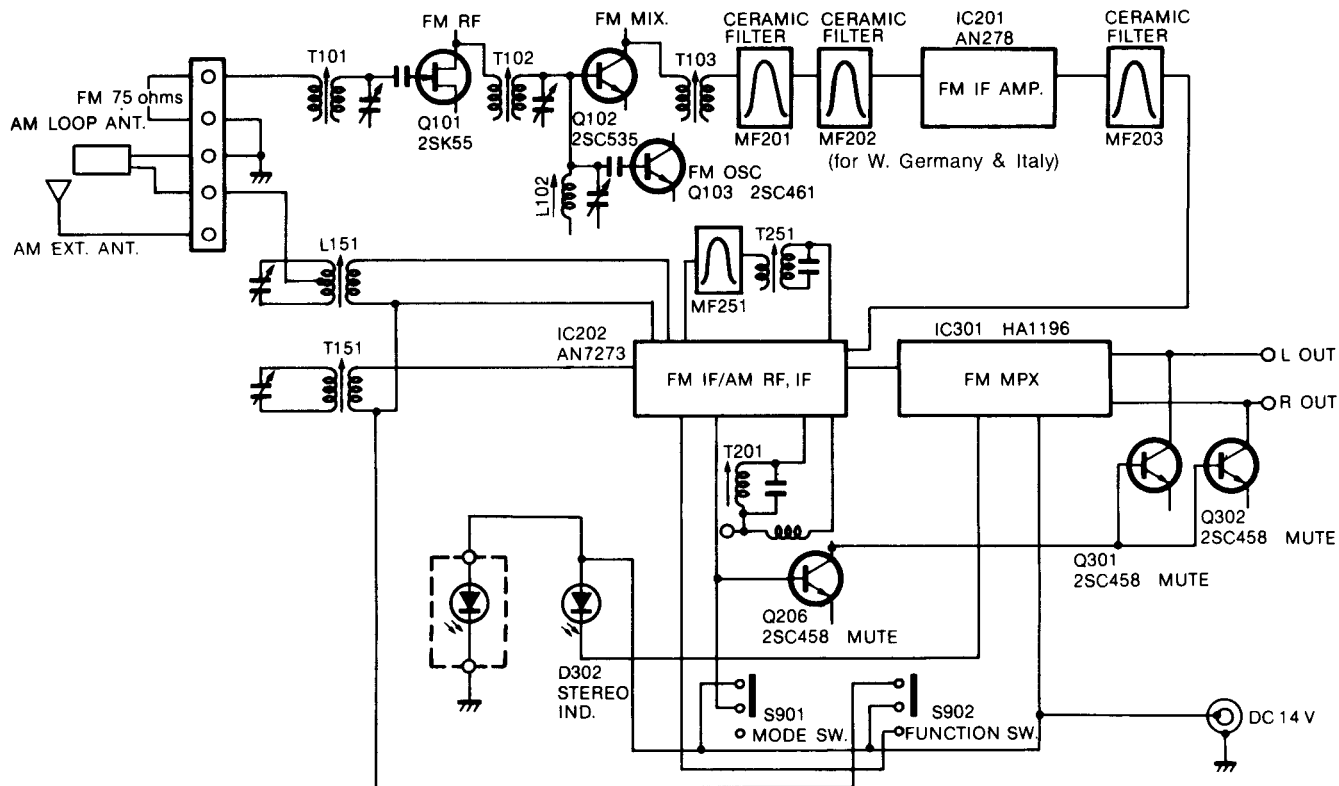

HA-12

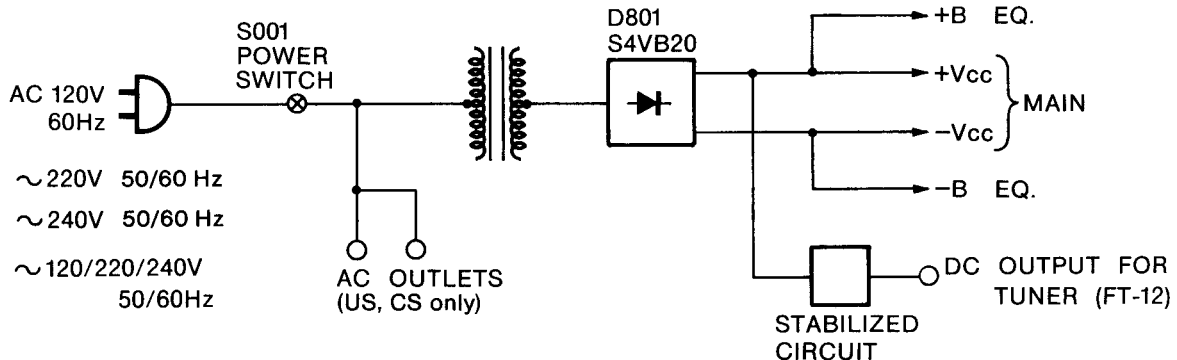
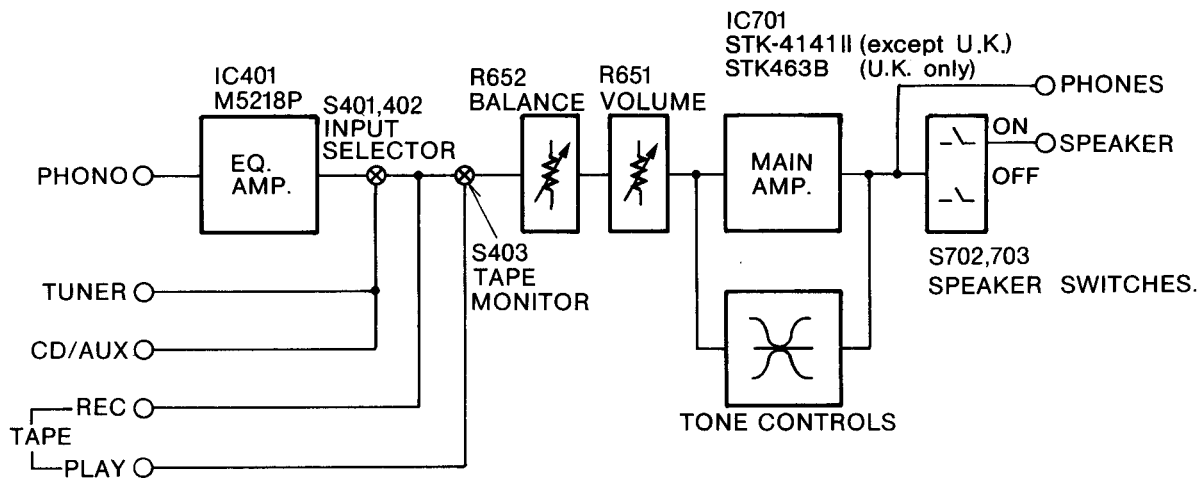





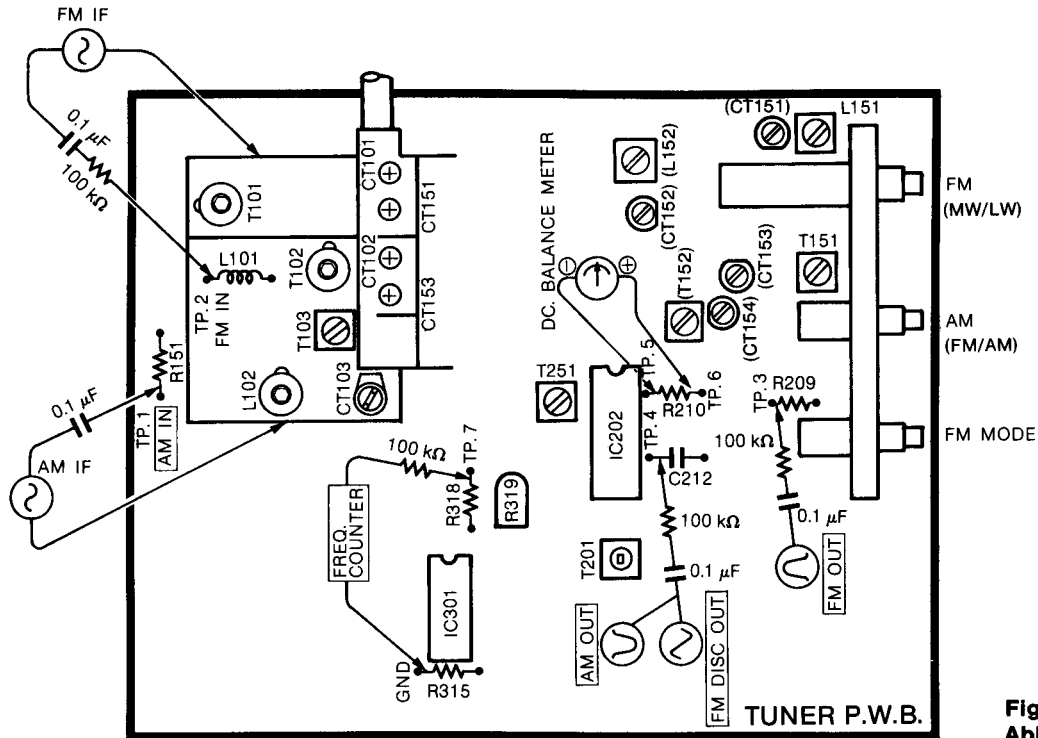

**GENERAL ALIGNMENT INSTRUCTION • ALLGEMEINE AUSRICHTANLEITUNG • INSTRUCTIONS GENERALES**

**FT-12**



**Fig. 1**  
**Abb. 1**



**FM TUNER ALIGNMENT • ABGLEICH DES UKW-TUNERS • REGLAGE DE TUNER FM**

-   
 Sweep Generator  
 Wobbelgenerator  
 Générateur de balayage
-   
 Signal Generator  
 Oszillator  
 Générateur de signaux
-   
 Oscilloscope  
 Oszilloskop  
 Oscilloscope
-   
 VTVM  
 Vakuumröhrevoltmeter  
 Voltmètre électronique
-   
 Frequency Counter  
 Frequenzzähler  
 Fréquencecètre
-   
 Dist.  
 Distortion Meter  
 Verzerrungsmesser  
 Indicateur de distorsion

Condition Function : FM  
 FM Muting : OFF  
 Modulation : 1000 Hz, 53.3%  
 (Unless otherwise notified)

Bedingung Funktion : FM (UKW)  
 FM (UKW) Muting : OFF  
 Modulation : 1000 Hz, 53,3 %  
 (Falls nicht anders angegeben)

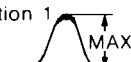
Condition Function : FM  
 Sourdine FM : OFF  
 Modulation : 1000 Hz, 53,3 %  
 (Sauf indication contraire)

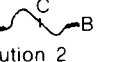
Sequence Reihenfolge Séquence	Connection Anschluß Connexion		Setting Einstellung Montage		Adjust for Einstellen für Réglage pour	
	Input Eingang Entrée	Output Ausgang Sortie	Tuning Abstimmung Indicateur d'accord	Signal	Adjust Einstellen Réglage	Indication Anzeige Indication
1	IF Amp. ZF-Verstärker- Amplificateur de fréquence intermédiaire	TP. 3 0.1 μ 100 k		10.7 MHz	T103	Caution 1 Vorsicht 1 Attention 1 
2	"S" curve S-Kurve Courbe S	TP. 4 0.1 μ 100 k		10.7 MHz	T201	Straight line Gerade Linie Ligne droite  Caution 2 Vorsicht 2 Attention 2

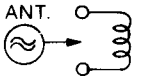
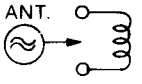
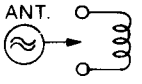
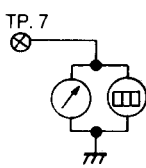
<b>3</b>	Covering Abgleich Poursuite	ANT. Terminal (75 ohms) Antennen-Anschluß Borne d'antenne		f min.	87.4 MHz	L102	V max.		
				f max.	108.35MHz	CT103			
<b>4</b>	Tracking Vorstufe Alignement'	ANT. Terminal (75 ohms) Antennen-Anschluß Borne d'antenne		90 MHz	90 MHz	T101, T102	V max.		
				106 MHz	106 MHz	CT101, CT102			
<b>5</b>	76 kHz	ANT. Terminal (75 ohms) Antennen-Anschluß Borne d'antenne		60 dB input 60 dB Eingang Entrée 60 dB Non-modulated Nicht moduliert Non modulé		98 MHz	98 MHz	R319	Fre. 76 kHz±120 Hz Frequenz 76 kHz±120 Hz Fréquence 76 kHz±120 Hz

## CAUTION

- Short-circuit the OSC stage by earthing the live side of the variable capacitor in that stage. Adjust the core of T103 so that the gain will be max. In this case, reduce the level of the input signal of signal generator so that the wave form will be the same as the one shown in the figure.
- Short-circuit the OSC stage as described in Caution 1. Adjust the core of T201 so that the output is like the S curve shown in illustration of this table with A and B symmetrical with respect to C.

## VORSICHT

- Die Oszillator-Stufe kurzschließen, indem die spannungsführende Seite des Regelkondensators dieser Stufe an Masse gelegt wird. Den Kern von T103 so einstellen, daß maximaler Gewinn erzielt wird. In diesem Fall ist der Eingangssignalpegel des Signalgenerators zu reduzieren, damit die in der Abbildung gezeigte Wellenform erhalten wird.
- Die in Punkt 1 beschriebene Oszillator-Stufe kurzschließen. Den Kern von T201 einstellen, daß ein der in der Tabelle gezeigten S-Kurve ähnlicher Ausgang erhalten wird, wobei A und B gegenüber C symmetrisch sein müssen.

## ATTENTION

- Court-circuiter l'étage OSC en raccordant le pôle sous tension à l'aide d'un condensateur variable au sein de l'étage. Ajuster le noyau de T103 de telle sorte que le gain soit optimum. Dans ce cas, réduire le niveau du signal d'entrée du générateur de signaux de telle sorte que la forme d'onde soit identique à celle indiquée sur l'illustration.
- Court-circuiter l'étage OSC comme décrit dans le paragraphe Précaution 1. Ajuster le noyau de T201 de telle sorte que la section droite de la courbe en S indiquée sur l'illustration de la table A et B soit symétrique par rapport à C.



# AM TUNER ALIGNMENT • ABGLEICH DES AM-TUNERS • REGLAGE DE TUNER AM

Condition Function : AM  
Modulation : 400 Hz, 30 %

Bedingung Funktion : AM  
Modulation : 400 Hz, 30 %

Condition Fonction : AM  
Modulation : 400 Hz, 30 %

Sequence Reihenfolge Séquence	Connection Anschluß Connexion		Setting Einstellung Montage		Adjust for Einstellen für Réglage pour		FT-12	
	Input Eingang Entrée	Output Ausgang Sortie	Tuning Abstimmung Indicateur d'accord	Signal	Adjust Einstellen Réglage	Indication Anzeige Indication	AM Function AM Funktion Fonction AM	
1	IF Amp. ZF Verstärker Amplificateur de fréquence intermédiaire			450 kHz	T251	 Caution 1 Vorsicht 1 Attention 1	MW MW PO	
2	Covering Abgleich Poursuite	 Loop antenna Rahmenantenne Antenne en cadre		515 kHz	515 kHz	T151	V max Caution 2 Vorsicht 2 Attention 2	MW MW PO
				1650 kHz	1650 kHz	CT153 (CT153)		
				145 kHz	145 kHz	T152	V max Caution 2 Vorsicht 2 Attention 2	LW LW GO
				355 kHz	355 kHz	(CT154)		
				Repeat 2 (MW) Wiederholung 2 (MW) Répétition 2 (PO)				
3	Tracking Vorstufe Alignement	 Loop antenna Rahmenantenne Antenne en cadre		600 kHz	600 kHz	L151	V max Caution 2 Vorsicht 2 Attention 2	MW MW PO
				1400 kHz	1400 kHz	CT151 (CT151)		
				175 kHz	175 kHz	L152	V max Caution 2 Vorsicht 2 Attention 2	LW LW GO
				300 kHz	300 kHz	(CT152)		
				Repeat 3 (MW) Wiederholung 3 (MW) Répétition 3 (PO)				
Repeat 3 (LW) Wiederholung 3 (LW) Répétition 3 (GO)								

( ): LW

## CAUTION

- In step 1, set the capacitance of the variable capacitor to minimum and adjust red and blue cores of T251 so that the wave form is as shown in Fig.2. As T251 contains a 450 kHz ceramic filter, sometimes the center of the marker will not correspond to that of the wave form.
- Set the input level to 74 dB in coarse adjustment. Reduce the input level to minimum (55 dB) as adjustment proceeds.

## VORSICHT

- In Schritt 1 ist die Kapazität des Regelkondensators auf ein Minimum einzustellen; die roten und blauen Kerne von T251 so einjustieren, daß die in Abb.2 gezeigte Wellenform erhalten wird. Da T251 auch ein 450-kHz-Keramikfilter enthält, kann es vorkommen, das manchmal die Mitte der Anzeige nicht mit der Wellenamplitude übereinstimmt.
- Eine Grobeinstellung auf einen Eingangspegel von 74 dB vornehmen. Im Verlauf der Einstellungen den Eingangspegel auf ein Minimum (55 dB) absenken.

## ATTENTION

- Dans le point 1. régler la capacitance du condensateur variable sur la position minimum et ajuster les noyaux rouge et bleu de T251 pour que la forme d'onde soit identique a celle indiquée sur l'illustration (Fig.2). Etant donné que T251 contient un filtre céramique de 450 kHz, il peut arriver que le centre de l'indicateur ne corresponde pas à la forme d'onde.
- Ajuster le niveau d'entrée sur 74 dB en procédant à un réglage approximatif. Réduire le niveau d'entrée à son minimum (55 dB) au fur et à mesure que le réglage est fait.

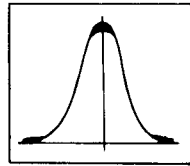
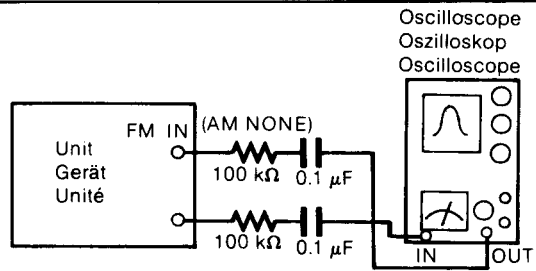

Fig. 2  
Abb. 2

Fig. 3 FM IF Discriminator and AM IF alignments (AM and FM Step. 1)

Abb. 3 UKW-ZF-Diskriminator und AM-ZF-Abgleich (AM: Schritt 1, UKW: Schritt 1)

Fig. 3 Réglages de discriminateur FM IF et AM IF (Operations IFM et IAM)



AM Signal generator  
AM Signalgenerator  
Générateur de signal AM

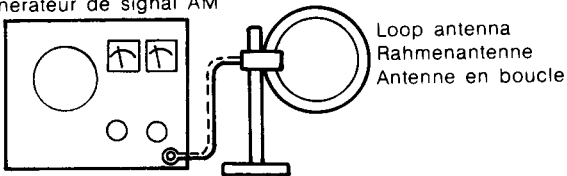

AC Voltmeter  
Wechselspannungsmesser  
Voltmètre à courant alternatif  
Oscilloscope  
Oszilloskop  
Oscilloscope

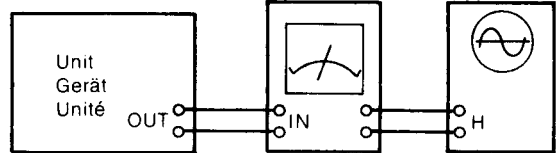
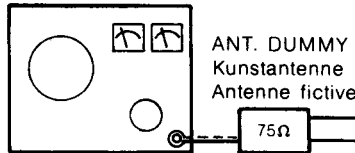

Fig. 4 AM frequency covering and tracking alignments (Step. 2 and 3)

Abb. 4 AM-Bereich- und Nachführungsabgleich (Schritte 2 und 3)

Fig. 4 Réglages de poursuite et d'étendue de fréquence AM (Operations 2 et 3)

FM Signal generator  
UKW Signalgenerator  
Générateur de signal FM



ANT. TERMINAL  
Antennenanschluß  
Borne d'antenne

AC Voltmeter  
Wechselspannungsmesser  
Voltmètre à courant alternatif  
Oscilloscope  
Oszilloskop  
Oscilloscope

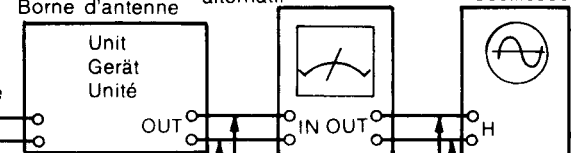

Fig. 5 FM frequency covering, tracking and other alignments (Step. 3 to 5)

Abb. 5 UKW-Bereich-, -Nachführungs- und andere Abgleiche (Schritte 2 bis 5)

Fig. 5 Réglages de poursuite, d'étendue de fréquence FM et autres (Opérations 2 à 5)

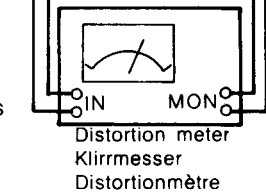
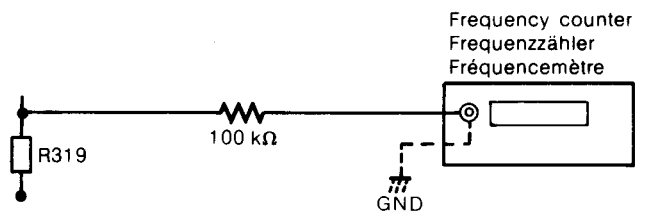

Fig. 6 FM MPX 76 kHz adjustment (Step. 6)

Abb. 6 UKW-Dekoder 76-kHz-Abgleich (Schritt 6)

Fig. 6 Réglage de 76 kHz MPX FM (Opération 6)



PRINTED WIRING BOARD • PRINTPLATTEN • PLAN DE BASE

FT-12 [  : Earth,  : Other ]

\* : Axial  
 \* : Zylind.  
 \* : Cond.

TUNER

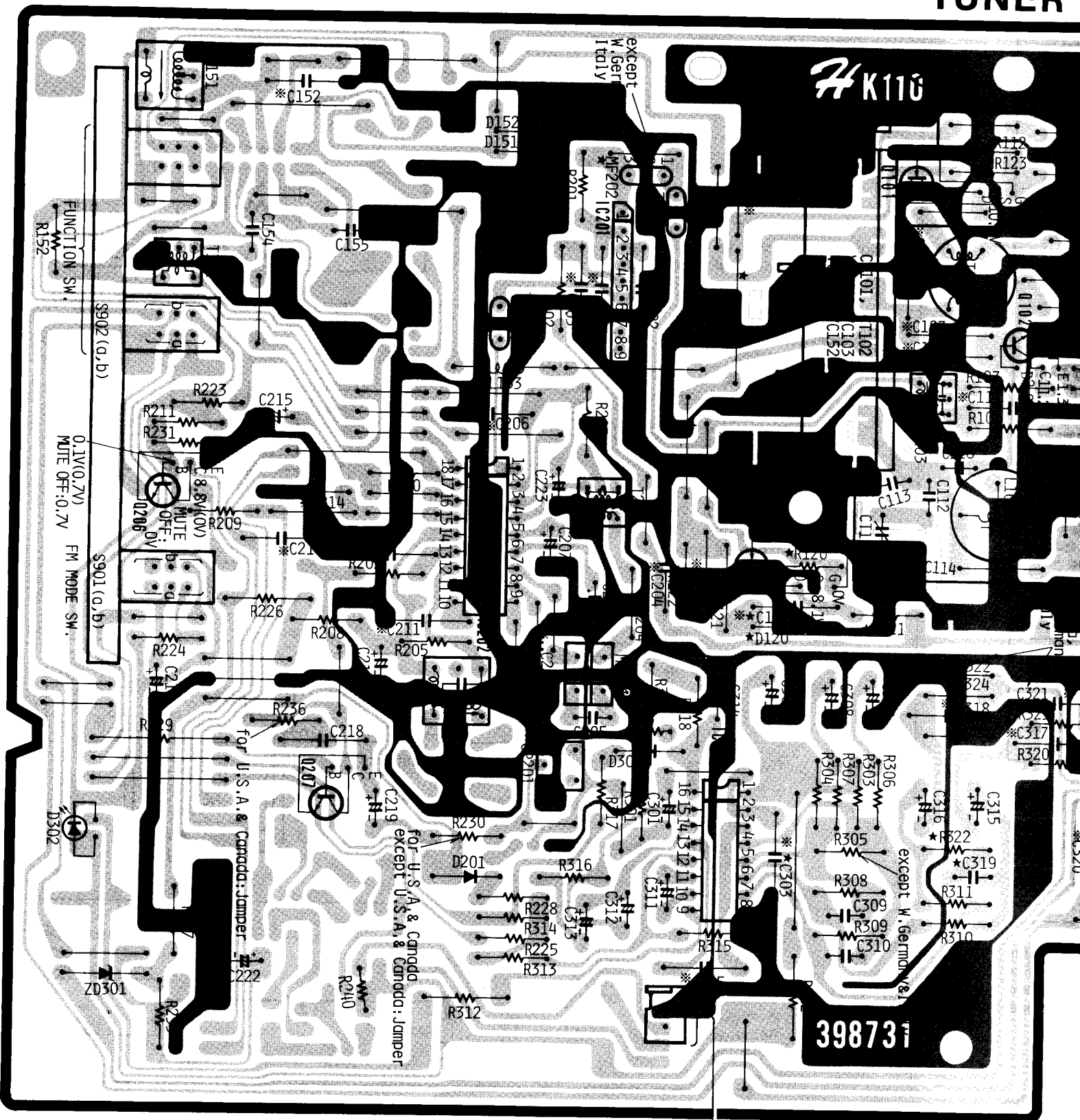

except U.K., Switzerland & France

Q207
E 1.9V(1.4V)
C 1.9V(1.7V)
B 2.6V(0V)

★ : for W. Germany & Italy  
 ( ) : AM position

- \* : Axial lead cylindrical ceramic capacitor
- \* : Zylindrischer Keramik Kondensator mit axialer Zuleitung
- \* : Condensateur céramique cylindrique à conducteur axial

# TUNER P.W.B. except U.S.A. & Canada

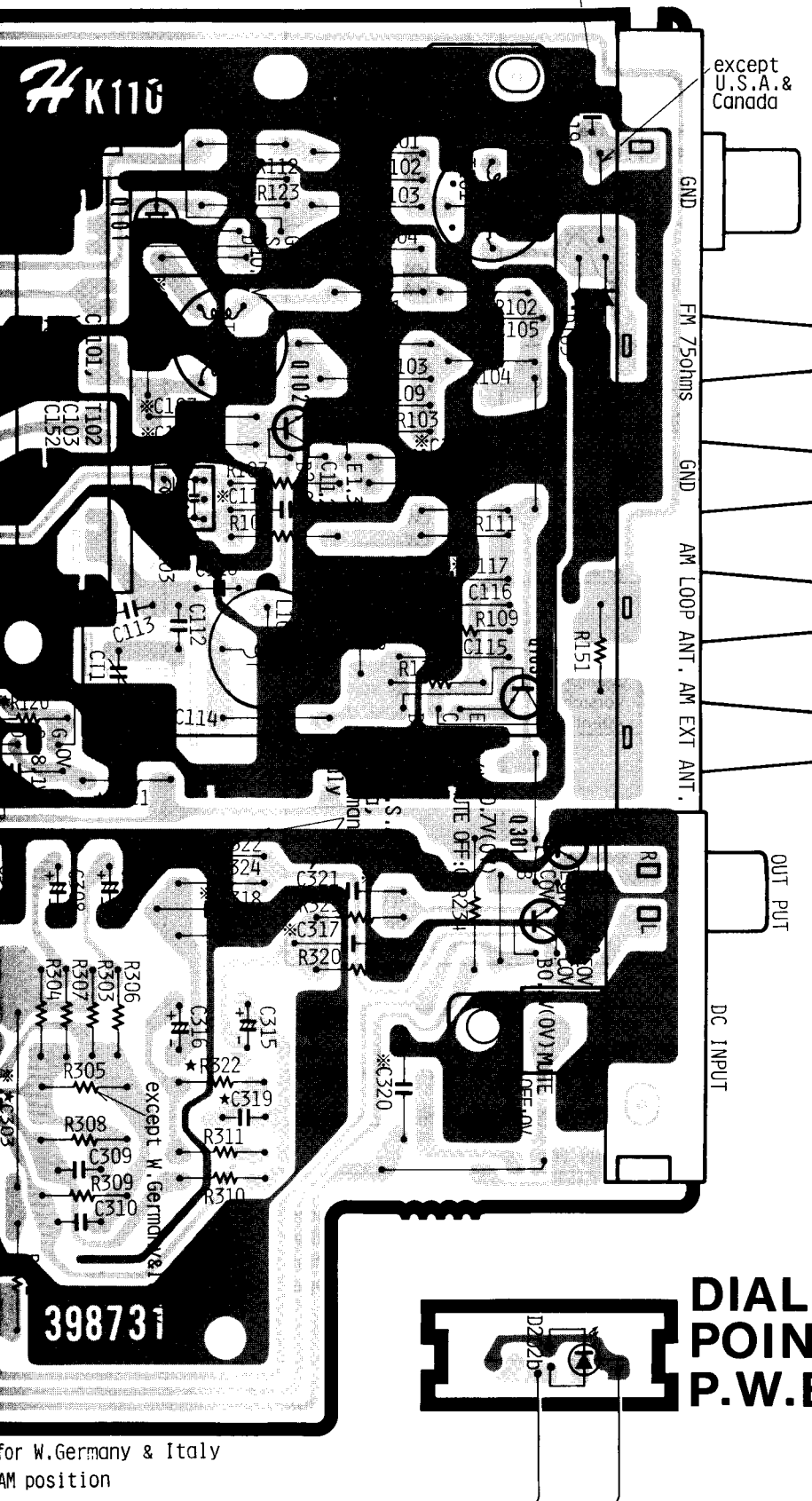

IC201

1	2.2V	6	2.4V
2	2.2V	7	0V
3	2.3V	8	1.6V
4	2.4V	9	2.3V
5	4.1V		

IC202

1	7.5V(9.9V)	7	7.5V(9.9V)	13	1.9V(1.7V)
2	0.6V(8.6V)	8	7.5V(9.9V)	14	7.9V(10.5V)
3	0.6V(8.6V)	9	7.4V(9.9V)	15	0V(0.18V)MUTE OFF:0.18V
4	0.6V(8.5V)	10	7.1V(9.6V)	16	1.5V(1.5V)
5	0V(1.0V)	11	0V	17	1.5V(1.5V)
6	0.3V(0.8V)	12	7.8V(10.5V)	18	0.6V(8.6V)

IC301

1	13.3V	7	7.4V	13	2.3V
2	3.1V	8	0V	14	2.4V
3	7.8V	9	12.4V	15	2.4V
4	10.7V	10	0V	16	3.2V(6.8V)
5	10.7V	11	2.4V		
6	7.3V	12	0.7V		

for W.Germany & Italy  
AM position

CIRCUIT DIAGRAM · SCHALTPLAN · PLAN DE CIRCUIT

FT-12

CAUTION

Use the electrolytic capacitors with extreme care when the diameter of them is more than 5mm.

except U.K., Switzerland & France

\* : for W.Germany & Italy  
( ) : AM position

W.Germnay&Italy:82K  
Others :100K

TUNER P.W.B.

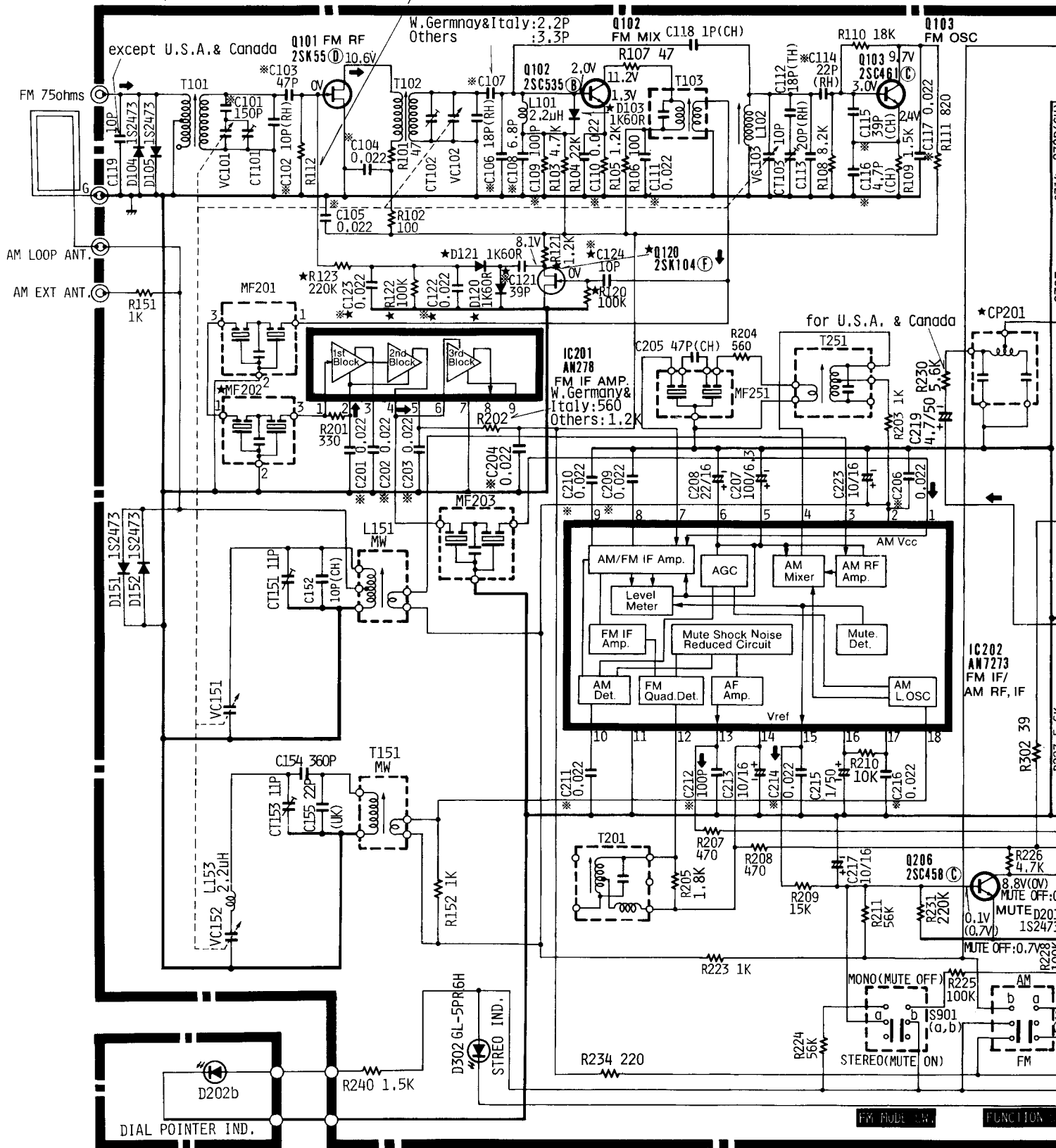

DIAL POINTER P.W.B.

CAUTION

Use the electrolytic capacitors with explosion-proof valve when the diameter of them is more than 10mmø.

- \* : Axial lead cylindrical ceramic capacitor
- \* : Zylindrischer Keramikkondensator mit axialer Zuleitung
- \* : Condensateur céramique cylindrique à conducteur axial

TUNER P.W.B.

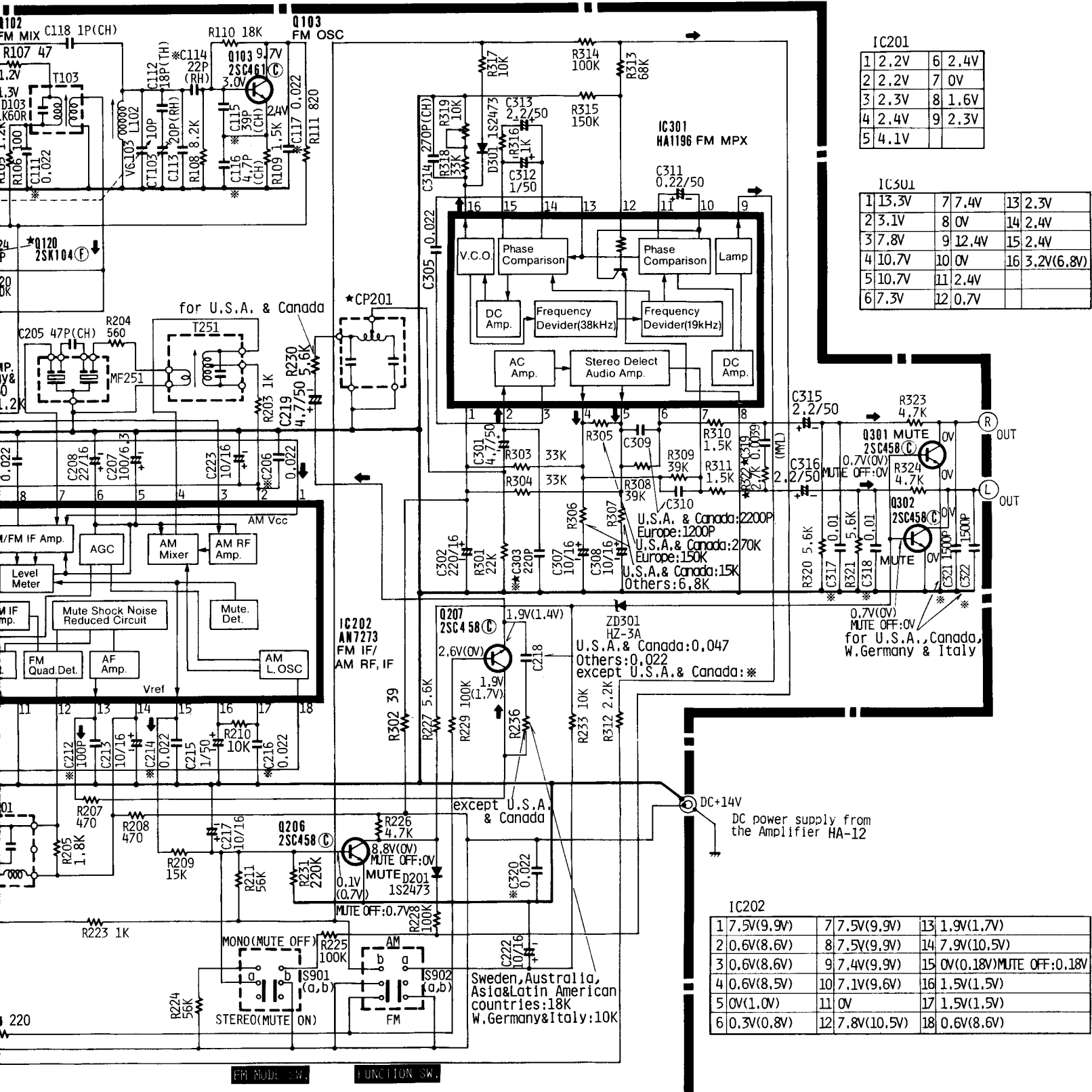

IC201

1	2.2V	6	2.4V
2	2.2V	7	0V
3	2.3V	8	1.6V
4	2.4V	9	2.3V
5	4.1V		

IC501

1	13.3V	7	7.4V	13	2.3V
2	3.1V	8	0V	14	2.4V
3	7.8V	9	12.4V	15	2.4V
4	10.7V	10	0V	16	3.2V(6.8V)
5	10.7V	11	2.4V		
6	7.3V	12	0.7V		

IC202

1	7.5V(9.9V)	7	7.5V(9.9V)	13	1.9V(1.7V)
2	0.6V(8.6V)	8	7.5V(9.9V)	14	7.9V(10.5V)
3	0.6V(8.6V)	9	7.4V(9.9V)	15	0V(0.18V)MUTE OFF:0.18V
4	0.6V(8.5V)	10	7.1V(9.6V)	16	1.5V(1.5V)
5	0V(1.0V)	11	0V	17	1.5V(1.5V)
6	0.3V(0.8V)	12	7.8V(10.5V)	18	0.6V(8.6V)





ASE

- \* : Axial lead cylindrical ceramic capacitor
- \* : Zylindrischer Keramikcondensator mit axialer Zuleitung
- \* : Condensateur céramique cylindrique à conducteur axial

# TUNER P.W.B.

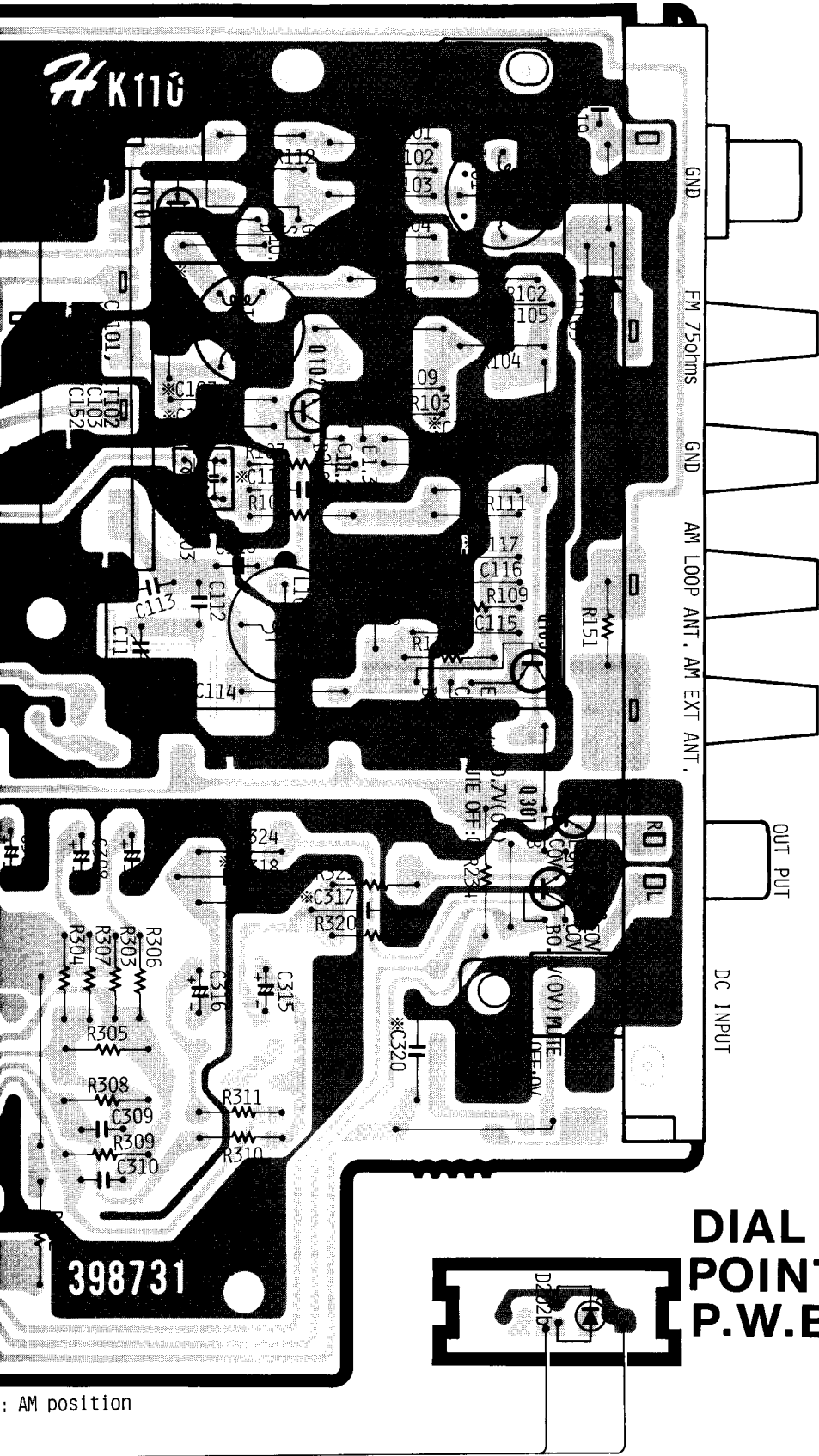

IC201

1	2.2V	6	2.4V
2	2.2V	7	0V
3	2.3V	8	1.6V
4	2.4V	9	2.3V
5	4.1V		

IC202

1	7.5V(9.9V)	7	7.5V(9.9V)	13	1.9V(1.7V)
2	0.6V(8.6V)	8	7.5V(9.9V)	14	7.9V(10.5V)
3	0.6V(8.6V)	9	7.4V(9.9V)	15	0V(0.18V)MUTE OFF:0.18V
4	0.6V(8.5V)	10	7.1V(9.6V)	16	1.5V(1.5V)
5	0V(1.0V)	11	0V	17	1.5V(1.5V)
6	0.3V(0.8V)	12	7.8V(10.5V)	18	0.6V(8.6V)

IC301

1	13.3V	7	7.4V	13	2.3V
2	3.1V	8	0V	14	2.4V
3	7.8V	9	12.4V	15	2.4V
4	10.7V	10	0V	16	3.2V(6.8V)
5	10.7V	11	2.4V		
6	7.3V	12	0.7V		

# DIAL POINTER P.W.B.

: AM position



DIAGRAM · SCHALTPLAN · PLAN DE CIRCUIT

CAUTION  
Use the electrolytic capacitors with explosion-proof valve when the diameter of them is more than 10mmø.

for U.K., Switzerland & France

TUNER P.W.B.

( ) : AM position

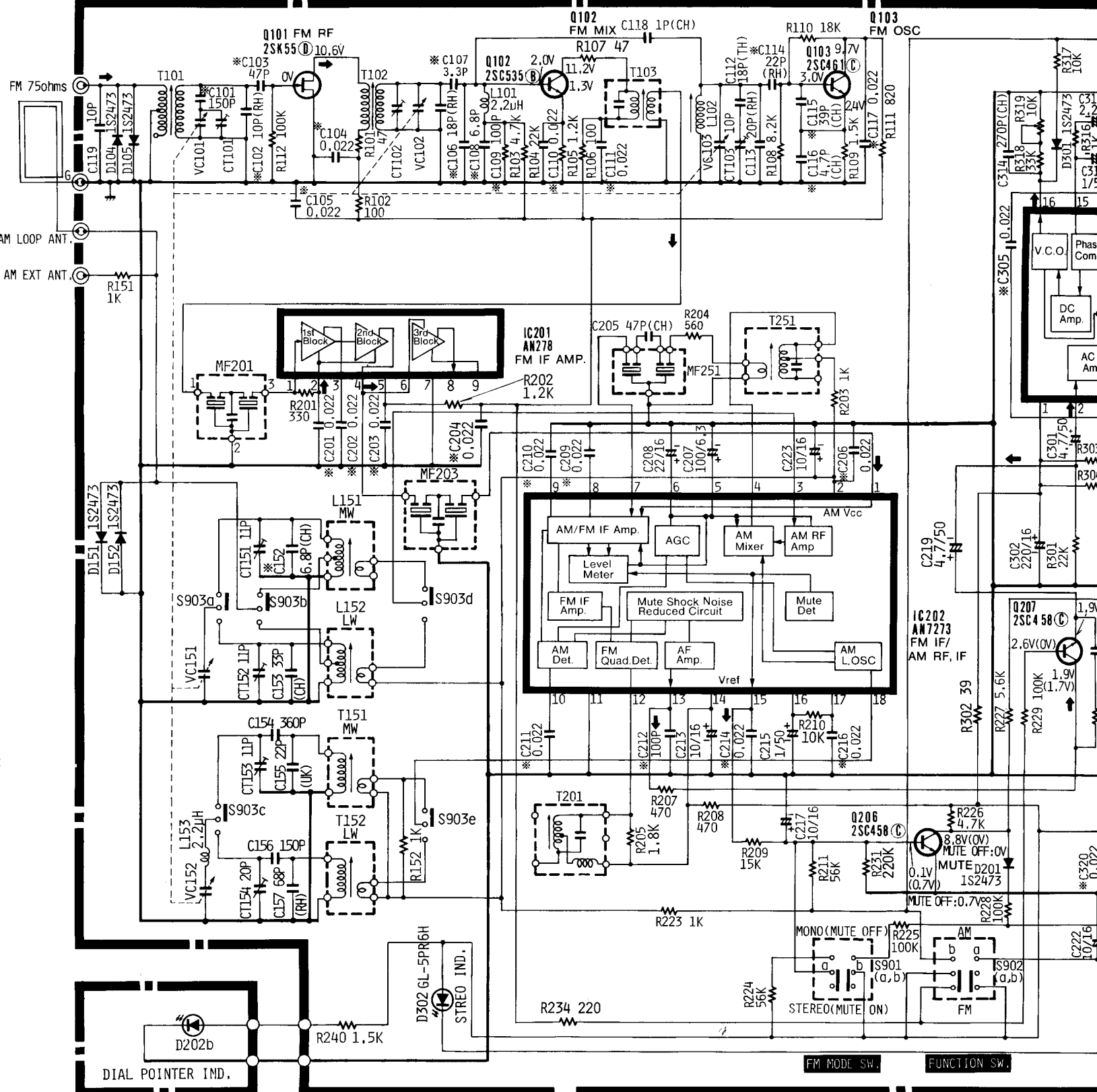

DIAL POINTER P.W.B.

CAUTION

Use the electrolytic capacitors with explosion-proof valve when the diameter of them is more than 10mmø.

- \* : Axial lead cylindrical ceramic capacitor
- \* : Zylindrischer Keramik Kondensator mit axialer Zuleitung
- \* : Condensateur céramique cylindrique à conducteur axial

TUNER P.W.B.

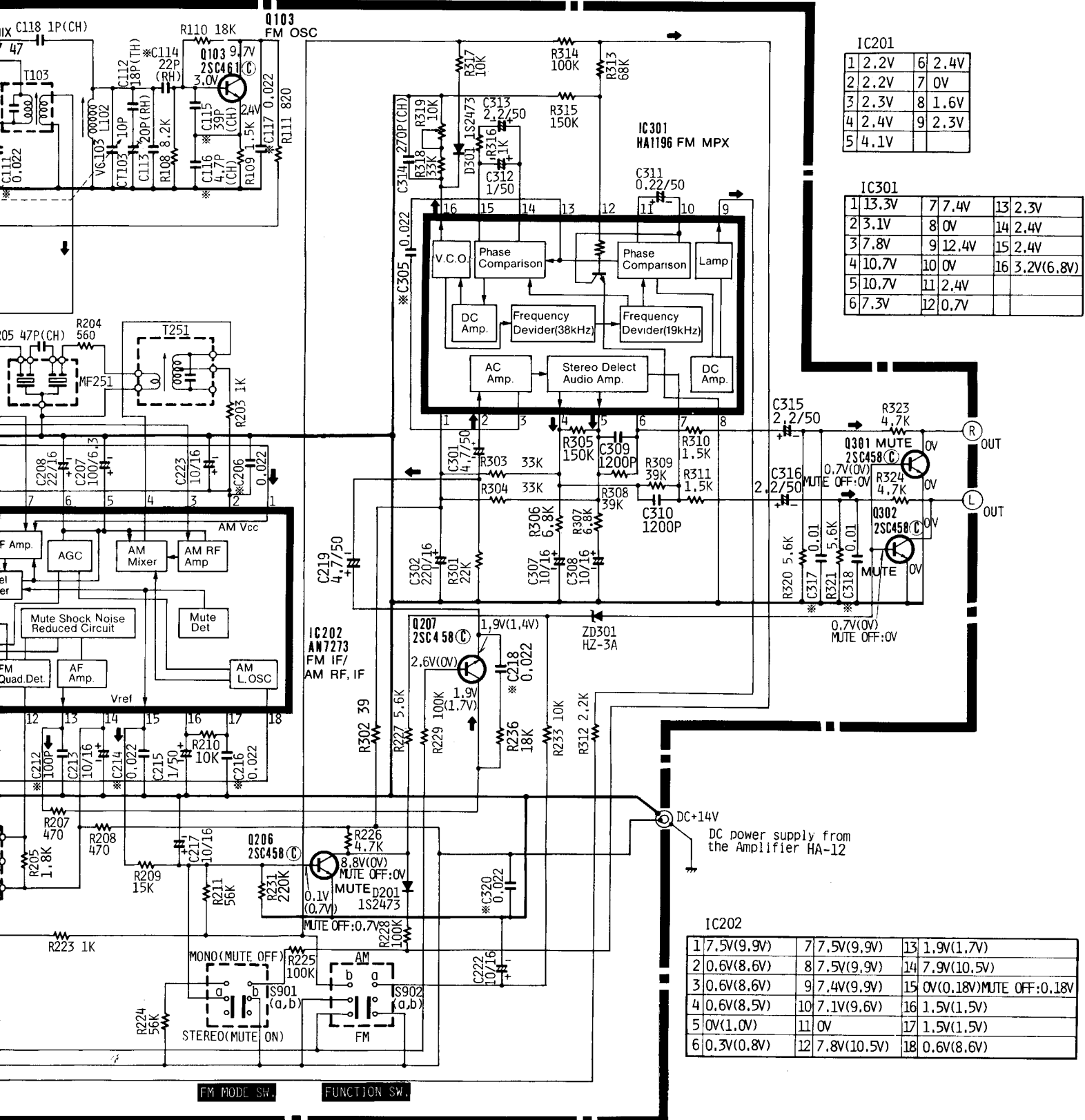

IC201

1	2.2V	6	2.4V
2	2.2V	7	0V
3	2.3V	8	1.6V
4	2.4V	9	2.3V
5	4.1V		

IC301

1	13.3V	7	7.4V	13	2.3V
2	3.1V	8	0V	14	2.4V
3	7.8V	9	12.4V	15	2.4V
4	10.7V	10	0V	16	3.2V(6.8V)
5	10.7V	11	2.4V		
6	7.3V	12	0.7V		

IC202

1	7.5V(9.9V)	7	7.5V(9.9V)	13	1.9V(1.7V)
2	0.6V(8.6V)	8	7.5V(9.9V)	14	7.9V(10.5V)
3	0.6V(8.6V)	9	7.4V(9.9V)	15	0V(0.18V)MUTE OFF:0.18V
4	0.6V(8.5V)	10	7.1V(9.6V)	16	1.5V(1.5V)
5	0V(1.0V)	11	0V	17	1.5V(1.5V)
6	0.3V(0.8V)	12	7.8V(10.5V)	18	0.6V(8.6V)



- \* : Axial lead cylindrical ceramic capacitor
- \* : Zylindrischer Keramik Kondensator mit axialer Zuleitung
- \* : Condensateur céramique cylindrique à conducteur axial

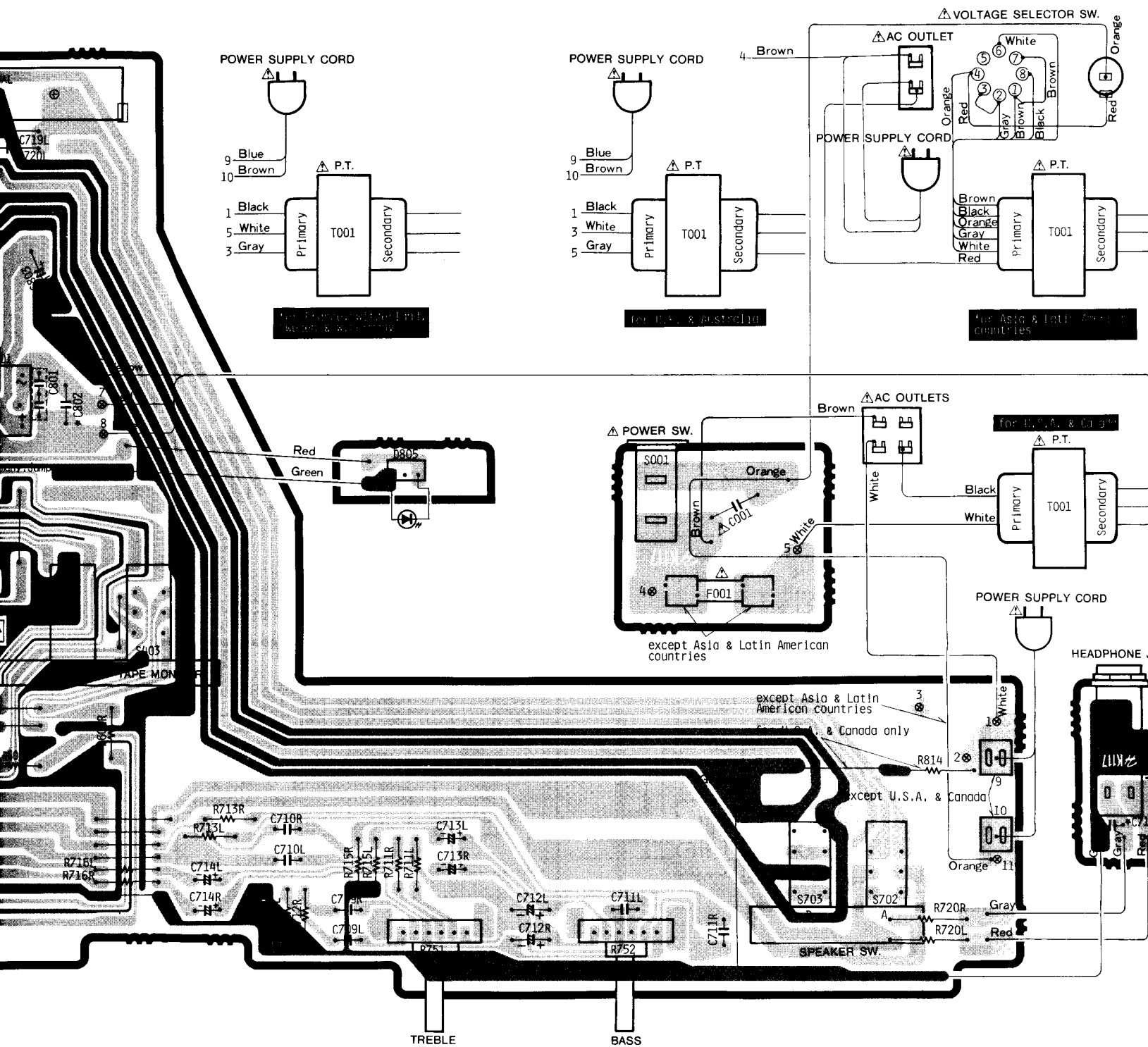

# CIRCUIT DIAGRAM • SCHALTPLAN • PLAN DE CIRCUIT

HA-12

CAUTION

Use the electrolytic capacitors with explosion-proof when the diameter of them is more than 10mm

\*:for W.Germany only

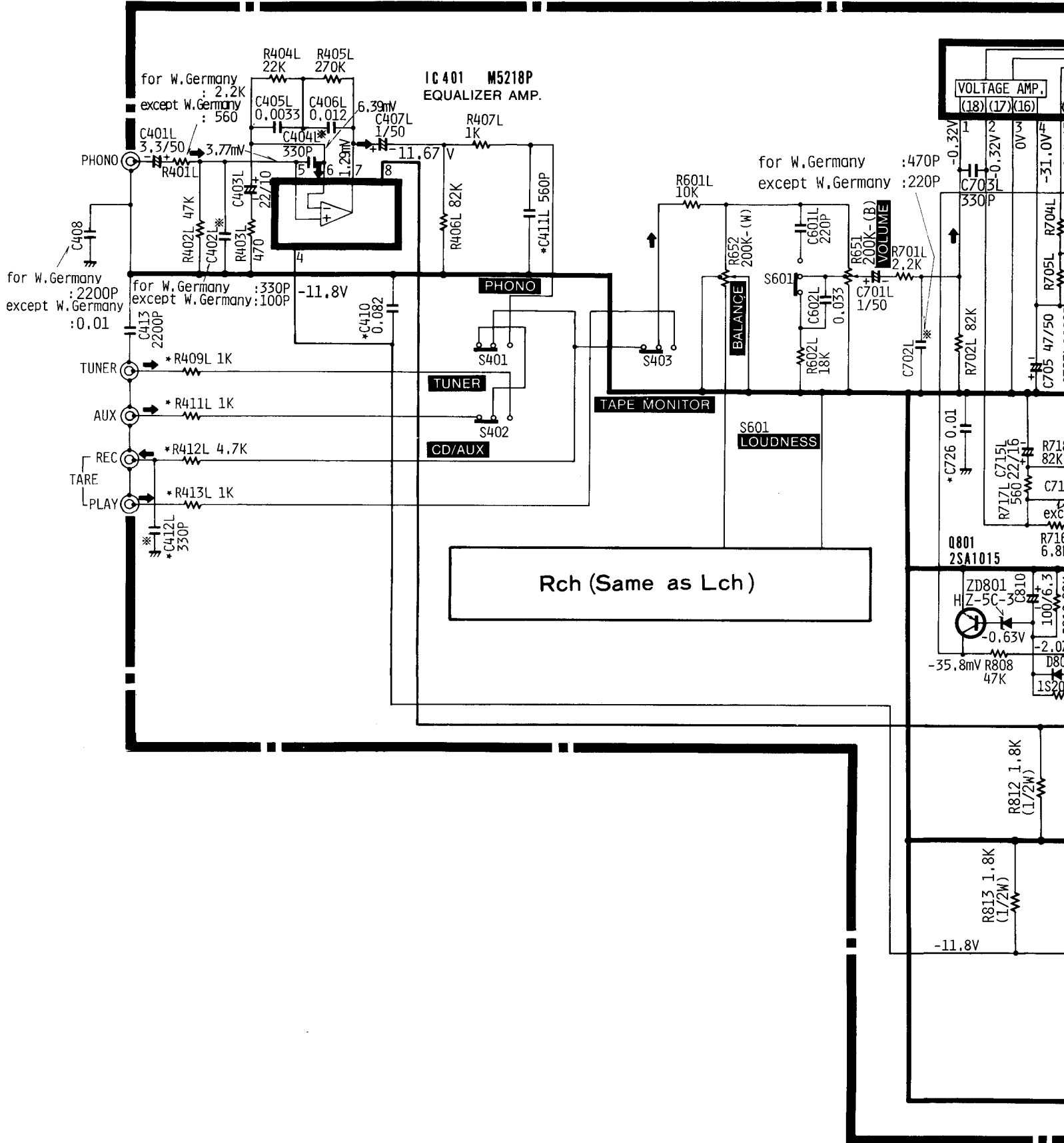

CAUTION

Use the electrolytic capacitors with explosion-proof valve when the diameter of them is more than 10mmφ.

- \* : Axial lead cylindrical ceramic capacitor
- \* : Zylindrischer Keramik Kondensator mit axialer Zuleitung
- \* : Condensateur céramique cylindrique à conducteur axial

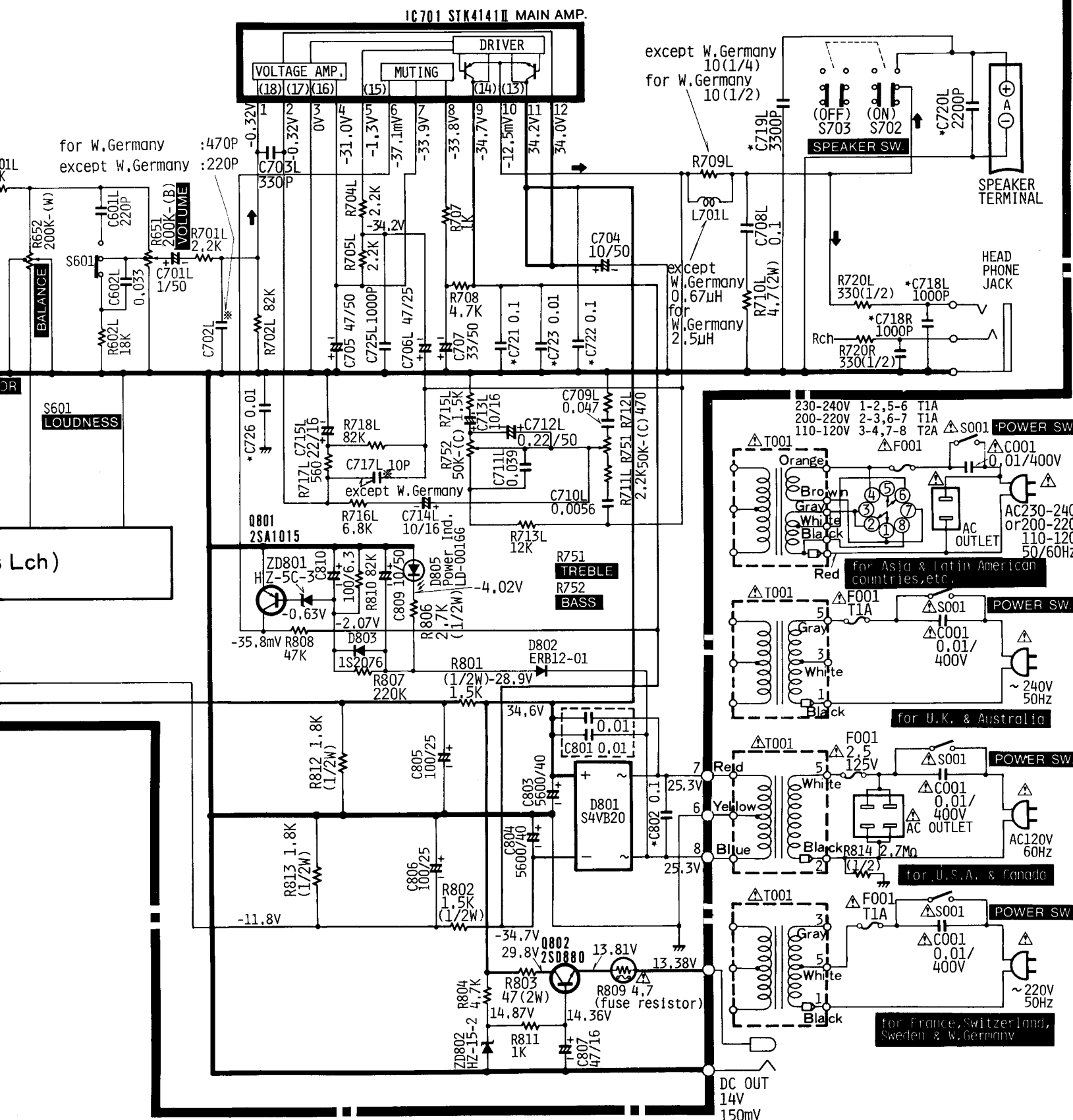

PRINTED WIRING BOARD · PRINTPLATTEN · PLAN DE BASE

•For U.K. only [  :Earth,  :Other]

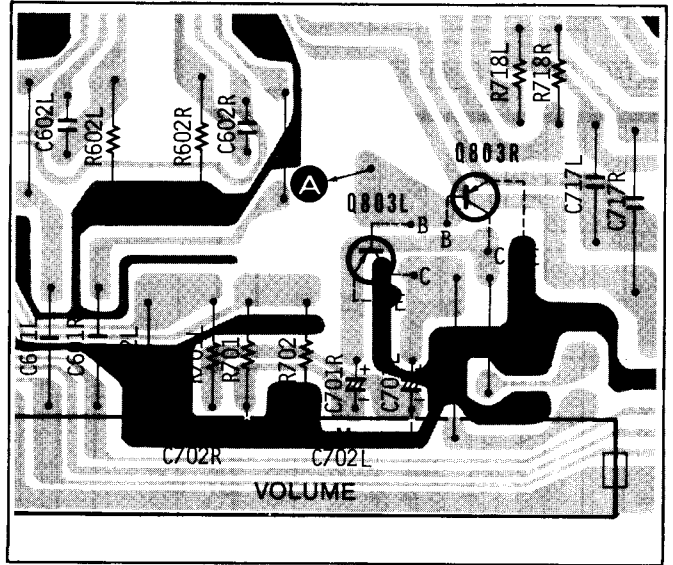
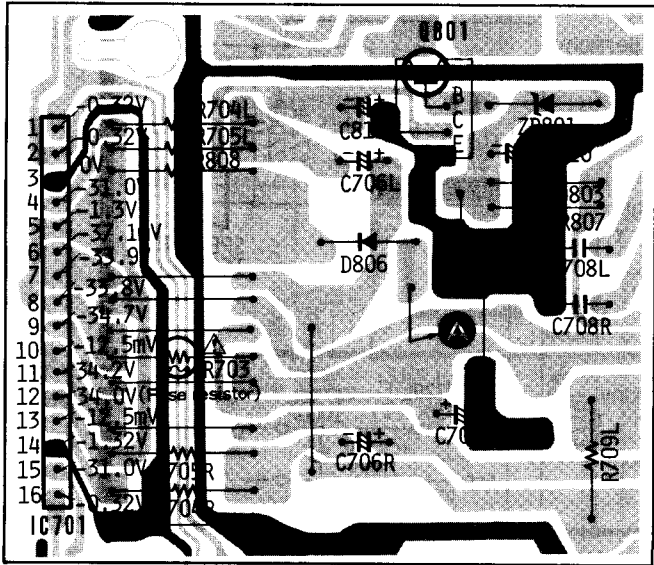

CIRCUIT DIAGRAM · SCHALTPLAN · PLAN DE CIRCUIT

•For U.K. only

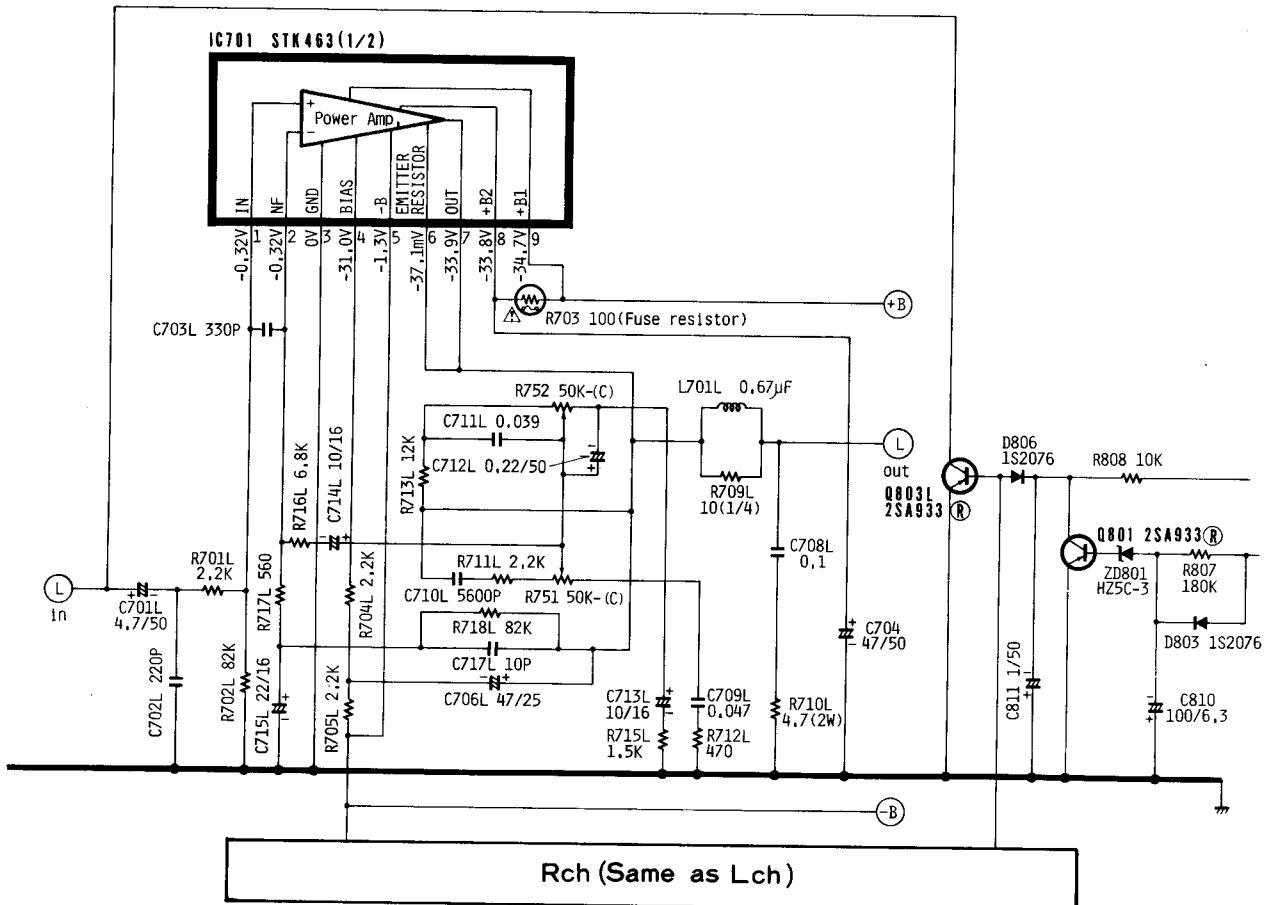

# FRONT AND REAR PANEL. VORDERE UND HINTERE BEDIENUNGSTAFEL. PANNEAUX AVANT ET ARRIERE

FT-12

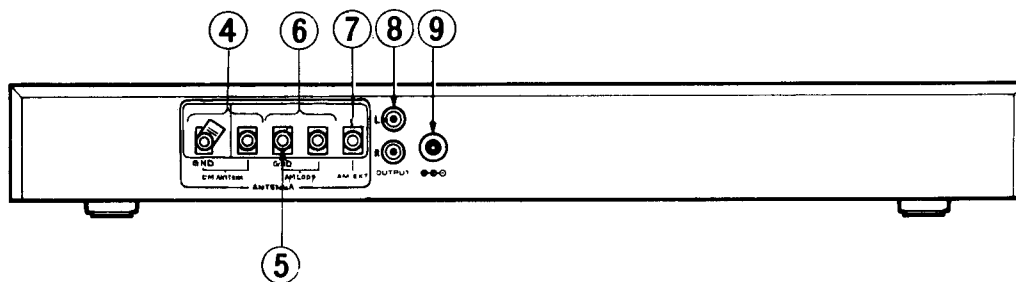
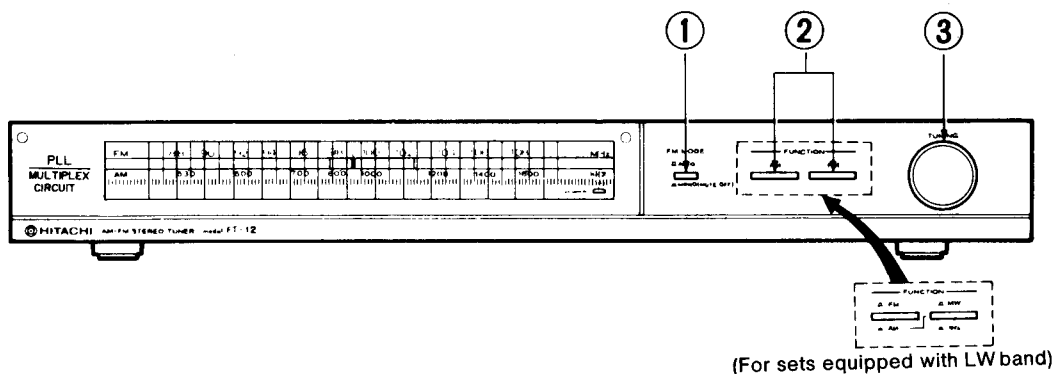

•For U.S.A. and Canada

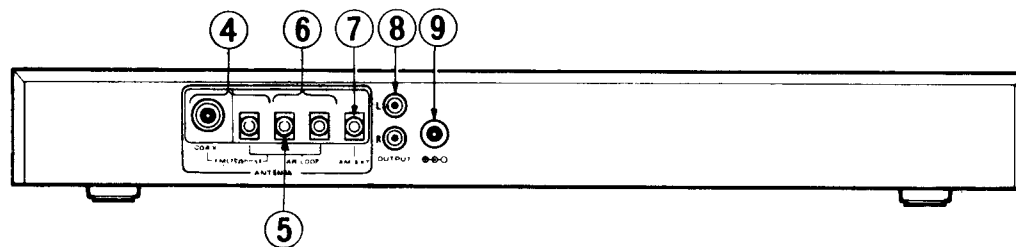

- ① FM MODE (AUTO/MONO MUTE OFF) switch
- ② FUNCTION switch
- ③ TUNING knob
- ④ FM ANTENNA terminals (75 ohms)
- ⑤ Ground terminal (GND)
- ⑥ AM loop antenna terminal
- ⑦ AM ANTENNA terminal
- ⑧ Output terminals
- ⑨ DC input terminal

- ① UKW-Betriebsartenschalter (FM MODE) (AUTO/MONO MUTE OFF)
- ② Funktionswahlschalter (FUNCTION)
- ③ Abstimmknopf (TUNING)
- ④ UKW-Antennenanschluß (FM ANTENNA) (75 Ohm)
- ⑤ Erdungsklemme (GND)
- ⑥ AM-Zimmerantenne
- ⑦ AM-Antennenklemme (AM ANTENNA)
- ⑧ Ausgangsbuchsen
- ⑨ Gleichspannungs-Eingangsklemme

- ① Commutateur de mode FM (MODE) (AUTO MONO MUTE OFF)
- ② Commutateur de fonction (FUNCTION)
- ③ Bouton d'accord (TUNING)
- ④ Bornes d'antenne FM (FM ANTENNA) (75 ohms)
- ⑤ Borne de mise à la terre (GND)
- ⑥ Antenne cadre AM
- ⑦ Borne d'antenne AM (AM ANTENNA)
- ⑧ Prise de sortie
- ⑨ Borne d'entrée CC



HA-12

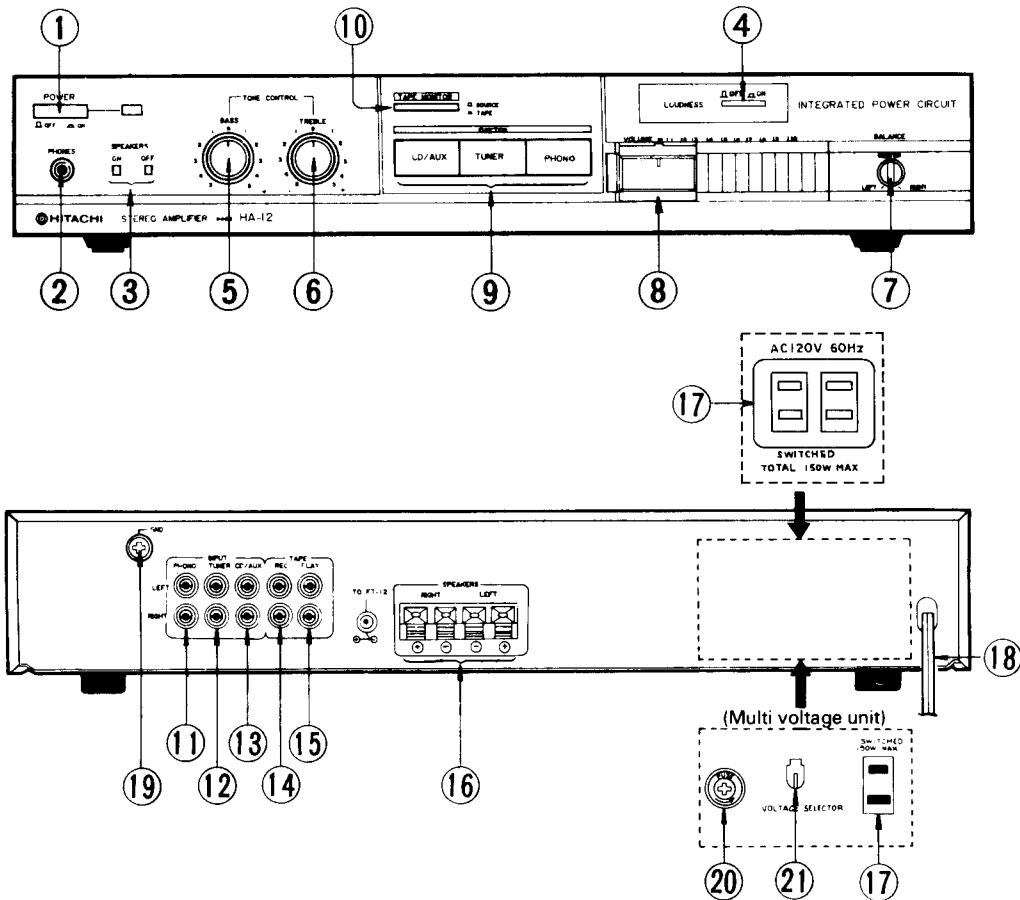

- |   |   |   |
|---|---|---|
| ① POWER switch  | ① Netzschalter (POWER)  | ① Interrupteur d'alimentation (POWER)   |
| ② PHONES jack   | ② Kopfhörer-Buchse (PHONES)   | ② Prise de casque (PHONES)  |
| ③ SPEAKERS switches   | ③ Lautsprecherschalter bass (SPEAKERS)  | ③ Commutateur d'enceintes (SPEAKERS)  |
| ④ LOUDNESS switch   | ④ Schalter für gehorrlichtige Klangkorrektur (LOUDNESS)   | ④ Commutateur de correction physiologique (LOUDNESS)  |
| ⑤ BASS control  | ⑤ BASS-Regler   | ⑤ Commande des graves (BASS)  |
| ⑥ TREBLE control  | ⑥ Höhenregler (TREBLE)  | ⑥ Commande des aigus (TREBLE)   |
| ⑦ BALANCE control   | ⑦ BALANCE-Regler  | ⑦ Commande d'équilibrage (BALANCE)  |
| ⑧ VOLUME control  | ⑧ Lautstärkereglter (VOLUME)  | ⑧ Commande de VOLUME  |
| ⑨ FUNCTION switches   | ⑨ Funktionsschalter (FUNCTION)  | ⑨ Commutateur de fonction (FUNCTION)  |
| ⑩ TAPE MONITOR switch   | ⑩ Tonbandschalter (TAPE MONITOR)  | ⑩ Commutateur du contrôleur de bande (TAPE MONITOR)   |
| ⑪ PHONO INPUT jacks   | ⑪ PHONO-Eingangsbuchse (PHONO INPUT)  | ⑪ Prises d'entrée PHONO (PHONO INPUT)   |
| ⑫ TUNER INPUT jacks   | ⑫ Tuner-Eingangsbuchse (TUNER INPUT)  | ⑫ Bornes d'entrée tuner (TUNER INPUT)   |
| ⑬ CD/AUX jacks  | ⑬ CD/AUX-Eingangsbuchse (CD/AUX)  | ⑬ Bornes d'entrée CD/AUX (CD/AUX)   |
| ⑭ TAPE REC jacks  | ⑭ Bandaufnahmebuchsen (TAPE REC)  | ⑭ Prises d'entregistrement de magné phono (TAPE REC)  |
| ⑮ TAPE PLAY jacks   | ⑮ Bandwiedergabebuchsen (TAPE PLAY)   | ⑮ Prises de reproduction du magnéphonon (TAPE PLAY)   |
| ⑯ SPEAKERS terminals  | ⑯ Lautsprecher-Klemmen (SPEAKERS)   | ⑯ Bornes d'enceintes (SPEAKERS)   |
| ⑰ AC outlet   | ⑰ Kaltgeräte-Steckdose  | ⑰ Prises C.A. ( 2 prises d'alimentation sur les modèles destinés aux Etats-Unis et au Canada, 1 prise d'alimentation pour les pays d'Asie et d'Amérique Latine) |
| (2 outlets for U.S.A. & Canada sets, 1 outlet for Asia & Latin American countries sets) | (2 Steckdosen bei für USA und Kanada bestimmten Modellen ; 1 Steckdose bei für Asien und Lateinamerika bestimmten Modellen) |   |
| ⑱ Power supply cord   | ⑱ Netzkabel   | ⑱ Cordon d'alimentation C.A.  |
| ⑲ Ground terminal (GND)   | ⑲ Erdung (GND)  | ⑲ Borne de terre (GND)  |
| ⑳ FUSE holder   | ⑳ Sicherungshalterung (FUSE)  | ⑳ Porte-fusible (FUSE)  |
| (for Asia & Latin American countries)   | (für Asien und Lateinamerika)   | (pour l'Asie et l'Amérique Latine)  |
| ㉑ VOLTAGE SELECTOR  | ㉑ Spannungswähler (VOLTAGE SELECTOR)  | ㉑ Sélecteur de tension (VOLTAGE SELECTOR)   |
| (for Asia & Latin American countries)   | (für Asien und Lateinamerika)   | (Pour l'Asie et l'Amérique Latine)  |

REPLACEMENT PARTS LIST • ERSATZTEILISTE • TABLEAU DES PIÈCE

FT-12

SYMBOL No.	PART No.	DESCRIPTION			SYMBOL No.	PART No.	DESCRIPTION			
<b>CAPACITORS</b>										
C101	0240002	Cylindrical ceramic	150pF	±10%	50V	C218	0240220	Ceramic, discal (for U.S.A. & Canada)	0.047μF ±10%	25V
C102	0230112	Cylindrical ceramic	10pF	±5%	50V	C218	0240108	Cylindrical ceramic (except U.S.A. & Canada)	0.022μF ±30%	16V
C103	0230028	Cylindrical ceramic	47pF	±5%	50V	C219	0252815	Electrolytic	4.7μF	50V
C104	0240108	Cylindrical ceramic	0.022μF	±30%	16V	C222	0252521	Electrolytic	10μF	16V
C105	0240108	Cylindrical ceramic	0.022μF	±30%	16V	C223	0252521	Electrolytic	10μF	16V
C106	0230118	Cylindrical ceramic	18pF	±5%	50V	C301	0252815	Electrolytic	4.7μF	50V
C107	0230006	Cylindrical ceramic (except W. Germany & Italy)	3.3pF	±10%	50V	C302	0252532	Electrolytic	220μF	16V
C107	0230004	Cylindrical ceramic (for W. Germany & Italy)	2.2pF	±10%	50V	C303	0240004	Cylindrical ceramic (for W. Germany & Italy)	220pF ±10%	50V
C108	0230010	Cylindrical ceramic	6.8pF	±10%	50V	C305	0240108	Cylindrical ceramic	0.022μF ±30%	16V
C109	0230036	Cylindrical ceramic	100pF	±5%	50V	C307	0252521	Electrolytic	10μF	16V
C110	0240108	Cylindrical ceramic	0.022μF	±30%	16V	C308	0252521	Electrolytic	10μF	16V
C111	0240108	Cylindrical ceramic	0.022μF	±30%	16V	C309	0274013	Mylar, film (for U.S.A. & Canada)	2200pF ±10%	50V
C112	0248336	Ceramic, discal	18pF	±5%	50V	C309	0274231	Mylar, film (except U.S.A. & Canada)	1200pF ±5%	50V
C113	0248037	Ceramic, discal	20pF	±5%	50V	C310	0274013	Mylar, film (for U.S.A. & Canada)	2200pF ±10%	50V
C114	0230120	Cylindrical ceramic	22pF	±5%	50V	C310	0274231	Mylar, film (except U.S.A. & Canada)	1200pF ±5%	50V
C115	0230076	Cylindrical ceramic	39pF	±5%	50V	C311	0252802	Electrolytic	0.22μF	50V
C116	0230058	Cylindrical ceramic	4.7pF	±10%	50V	C312	0252811	Electrolytic	1μF	50V
C117	0240108	Cylindrical ceramic	0.022μF	±30%	16V	C313	0252812	Electrolytic	2.2μF	50V
C118	0246411	Ceramic, discal	1μF	±0.25%	50V	C314	0246470	Ceramic, discal	270pF ±5%	50V
C119	0248640	Ceramic, discal (except W. Germany & Italy)	10pF	±0.25%	50V	C315	0252812	Electrolytic	2.2μF	50V
C121	0230026	Cylindrical ceramic (for W. Germany & Italy)	39pF	±5%	50V	C316	0252812	Electrolytic	2.2μF	50V
C122	0240108	Cylindrical ceramic (for W. Germany & Italy)	0.022μF	±30%	16V	C317	0240106	Cylindrical ceramic	0.01μF ±30%	25V
C123	0240108	Cylindrical ceramic (for W. Germany & Italy)	0.022μF	±30%	16V	C318	0240106	Cylindrical ceramic	0.01μF ±30%	25V
C124	0230012	Cylindrical ceramic (for W. Germany & Italy)	10pF	±5%	50V	C319	0274034	Mylar, film	3900pF ±10%	50V
C152	0230062	Cylindrical ceramic (except France, Switzerland & U.K.)	10pF	±5%	50V	C320	0240108	Cylindrical ceramic	0.022μF ±30%	16V
C152	0230060	Cylindrical ceramic (for France, Switzerland & U.K.)	6.8pF	±5%	50V	C321	0240101	Cylindrical ceramic (for W. Germany & Italy)	1500pF ±30%	50V
C153	0230074	Cylindrical ceramic (for France, Switzerland & U.K.)	33pF	±5%	50V	C321	0274012	Mylar, film (for U.S.A. & Canada)	1500pF ±10%	50V
C154	0279327	Polypro-pylene	360pF	±5%	100V	C322	0240101	Cylindrical ceramic (for W. Germany & Italy)	1500pF ±30%	50V
C155	0241884	Ceramic, discal	22pF	±5%	50V	C322	0274012	Mylar, film (for U.S.A. & Canada)	1500pF ±10%	50V
C156	0228315	Styrol (for France, Switzerland & U.K.)	150pF	±5%	50V	<b>RESISTORS</b>				
C157	0248050	Ceramic, discal (for France, Switzerland & U.K.)	68pF	±5%	50V	R101	0129547	Carbon film	47Ω ±5%	SRD1/4P
C201	0240108	Cylindrical ceramic	0.022μF	±30%	16V	R102	0129561	Carbon film	100Ω ±5%	SRD1/4P
C202	0240108	Cylindrical ceramic	0.022μF	±30%	16V	R103	0129617	Carbon film	4.7kΩ ±5%	SRD1/4P
C203	0240108	Cylindrical ceramic	0.022μF	±30%	16V	R104	0129639	Carbon film	22kΩ ±5%	SRD1/4P
C204	0240108	Cylindrical ceramic	0.022μF	±30%	16V	R105	0129603	Carbon film	1.2kΩ ±5%	SRD1/4P
C205	0246456	Ceramic, discal	47Ω	±5%	50V	R106	0129561	Carbon film	100Ω ±5%	SRD1/4P
C206	0240108	Cylindrical ceramic	0.022μF	±30%	16V	R107	0129547	Carbon film	47Ω ±5%	SRD1/4P
C207	0252231	Electrolytic	100μF		6.3V	R108	0129623	Carbon film	8.2kΩ ±5%	SRD1/4P
C208	0252522	Electrolytic	22μF		16V	R109	0129605	Carbon film	1.5kΩ ±5%	SRD1/4P
C209	0240108	Cylindrical ceramic	0.022μF	±30%	16V	R110	0129637	Carbon film	18kΩ ±5%	SRD1/4P
C210	0240108	Cylindrical ceramic	0.022μF	±30%	16V	R111	0129583	Carbon film	820Ω ±5%	SRD1/4P
C211	0240108	Cylindrical ceramic	0.022μF	±30%	16V	R112	0129661	Carbon film (except W. Germany & Italy)	100kΩ ±5%	SRD1/4P
C212	0230036	Cylindrical ceramic	100pF	±5%	50V	R112	0129653	Carbon film (for W. Germany & Italy)	82kΩ ±5%	SRD1/4P
C213	0252521	Electrolytic	10μF		16V	R120	0129661	Carbon film (for W. Germany & Italy)	100kΩ ±5%	SRD1/4P
C214	0240108	Cylindrical ceramic	0.022μF	±30%	16V	R121	0129603	Carbon film (for W. Germany & Italy)	1.2kΩ ±5%	SRD1/4P
C215	0252811	Electrolytic	1μF		50V					
C216	0240108	Cylindrical ceramic	0.022μF	±30%	16V					
C217	0252521	Electrolytic	10μF		16V					

SYMBOL No.	PART No.	DESCRIPTION		
R122	0129661	Carbon film (for W. Germany & Italy)	100kΩ ±5%	SRD1/4P
R123	0129669	Carbon film (for W. Germany & Italy)	220kΩ ±5%	SRD1/4P
R151	0129601	Carbon film (except U.S.A. & Canada)	1kΩ ±5%	SRD1/4P
R151	0134373	Composition (for U.S.A. & Canada)	1kΩ ±10%	RC1/2GF
R152	0129601	Carbon film	1kΩ ±5%	SRD1/4P
R201	0129573	Carbon film	330Ω ±5%	SRD1/4P
R202	0129603	Carbon film (except W. Germany & Italy)	1.2kΩ ±5%	SRD1/4P
R202	0129579	Carbon film (for W. Germany & Italy)	560Ω ±5%	SRD1/4P
R203	0129601	Carbon film	1kΩ ±5%	SRD1/4P
R204	0129579	Carbon film	560Ω ±5%	SRD1/4P
R205	0129607	Carbon film	1.8kΩ ±5%	SRD1/4P
R207	0129577	Carbon film	470Ω ±5%	SRD1/4P
R208	0129577	Carbon film	470Ω ±5%	SRD1/4P
R209	0129635	Carbon film	15kΩ ±5%	SRD1/4P
R210	0129631	Carbon film	10kΩ ±5%	SRD1/4P
R211	0129649	Carbon film	56kΩ ±5%	SRD1/4P
R223	0129601	Carbon film	1kΩ ±5%	SRD1/4P
R224	0129649	Carbon film	56kΩ ±5%	SRD1/4P
R225	0129661	Carbon film	100kΩ ±5%	SRD1/4P
R226	0129617	Carbon film	4.7kΩ ±5%	SRD1/4P
R227	0129619	Carbon film	5.6kΩ ±5%	SRD1/4P
R228	0129661	Carbon film	100kΩ ±5%	SRD1/4P
R229	0129661	Carbon film	100kΩ ±5%	SRD1/4P
R230	0129619	Carbon film (for U.S.A. & Canada)	5.6kΩ ±5%	SRD1/4P
R231	0129669	Carbon film	220kΩ ±5%	SRD1/4P
R233	0129631	Carbon film	10kΩ ±5%	SRD1/4P
R234	0129569	Carbon film	220Ω ±5%	SRD1/4P
R236	0129637	Carbon film (except U.S.A., Canada, W. Germany & Italy)	18kΩ ±5%	SRD1/4P
R236	0129631	Carbon film (for W. Germany & Italy)	10kΩ ±5%	SRD1/4P
R240	0129874	Carbon film	1.5kΩ ±5%	SRD1/4P
R301	0129639	Carbon film	22kΩ ±5%	SRD1/4P
R302	0100645	Carbon film	39Ω ±5%	SRD1/4P
R303	0129643	Carbon film	33kΩ ±5%	SRD1/4P
R304	0129643	Carbon film	33kΩ ±5%	SRD1/4P
R305	0129665	Carbon film (except U.S.A., Canada, W. Germany & Italy)	150kΩ ±5%	SRD1/4P
R305	0129671	Carbon film (for U.S.A. & Canada)	270kΩ ±5%	SRD1/4P
R306	0129621	Carbon film (except U.S.A. & Canada)	6.8kΩ ±5%	SRD1/4P
R306	0129635	Carbon film (for U.S.A. & Canada)	15kΩ ±5%	SRD1/4P
R307	0129621	Carbon film (except U.S.A. & Canada)	6.8kΩ ±5%	SRD1/4P
R307	0129635	Carbon film (for U.S.A. & Canada)	15kΩ ±5%	SRD1/4P
R308	0129645	Carbon film	39kΩ ±5%	SRD1/4P
R309	0129645	Carbon film	39kΩ ±5%	SRD1/4P
R310	0129605	Carbon film	1.5kΩ ±5%	SRD1/4P

SYMBOL No.	PART No.	DESCRIPTION		
R311	0129605	Carbon film	1.5kΩ ±5%	SRD1/4P
R312	0129609	Carbon film	2.2kΩ ±5%	SRD1/4P
R313	0129651	Carbon film	68kΩ ±5%	SRD1/4P
R314	0129661	Carbon film	100kΩ ±5%	SRD1/4P
R315	0129665	Carbon film	150kΩ ±5%	SRD1/4P
R316	0129601	Carbon film	1kΩ ±5%	SRD1/4P
R317	0129631	Carbon film	10kΩ ±5%	SRD1/4P
R318	0129643	Carbon film	33kΩ ±5%	SRD1/4P
R320	0129619	Carbon film	5.6kΩ ±5%	SRD1/4P
R321	0129619	Carbon film	5.6kΩ ±5%	SRD1/4P
R322	0129611	Carbon film (for W. Germany & Italy)	2.7kΩ ±5%	SRD1/4P
R323	0129617	Carbon film	4.7kΩ ±5%	SRD1/4P
R324	0129617	Carbon film	4.7kΩ ±5%	SRD1/4P

**ICS & TRANSISTORS**

IC201	2368431	AN278
IC202	2387321	AN7273
IC301	2367271	HA1196
Q101	2327683	2SK55 (D)
Q102	0573510	2SC535 (B)
Q103	0573508	2SC461 (C)
Q120	2328805	2SK104 (for W. Germany & Italy)
Q206	2328282	2SC458 (C)
Q207	2328282	2SC458 (C)
Q301	2328282	2SC458 (C)
Q302	2328282	2SC458 (C)

**DIODES**

D103	2337931	1K60R (for W. Germany & Italy)
D104	2337601	1S2473
D105	2337601	1S2473
D120	2337931	1K60R (for W. Germany & Italy)
D121	2337931	1K60R (for W. Germany & Italy)
D151	2337601	1S2473
D152	2337601	1S2473
D201	2337601	1S2473
D301	2337601	1S2473
D302	2337752	LED GL-5PR6H
ZD301	2337613	HZ3A-3

**VARIABLE RESISTOR**

R319	0158955	10kΩ - (B)
------	---------	------------

**COILS & TRANSISTORS**

L101	2227354	Choke coil 2.2μH
L102	2134471	FM OSC coil

SYMBOL No.	PART No.	DESCRIPTION
L151	2136501	AM antenna coil (MW)
L152	2136502	AM antenna coil (LW) (for France, Switzerland & U.K.)
L153	2227354	Choke coil 2.2 $\mu$ H
T101	2136511	FM antenna coil
T102	2136513	FM RF coil
T103	2155181	FM IFT coil (7 MM)
T151	2136491	AM OSC coil (MW)
T152	2136492	AM OSC coil (LW) (for France, Switzerland & U.K.)
T201	2155173	FM disci trans.
T251	2154493	AM IFT trans.
<b>MISCELLANEOUS</b>		
CP201	2136312	Anti-birdy filter
MF201	2134981	FM ceramic filter 10.7 MA5 (for U.S.A. & Canada)
MF201	2135001	FM ceramic filter 10.7 MS2 (except U.S.A. & Canada)
MF202	2135001	FM ceramic filter 10.7 MS2 (for W. Germany & Italy)
MF203	2134981	FM ceramic filter 10.7 MA5 (for U.S.A. & Canada)
MF203	2135001	FM ceramic filter 10.7 MS2 (except U.S.A. & Canada)
MF251	2155152	AM ceramic filter SFZ450F
CT103	0283121	Trimmer capacitor 10P (white)
CT151	0283126	Trimmer capacitor 11P (white) (for France, Switzerland & U.K.)
CT152	0283126	Trimmer capacitor 11P (white) (for France, Switzerland & U.K.)
CT153	0283126	Trimmer capacitor 11P (white) (for France, Switzerland & U.K.)
CT154	0283127	Trimmer capacitor 20P (red) (for France, Switzerland & U.K.)
	3945205	Spacer
	0282121	Variable capacitor (except France, Switzerland & U.K.)
	0282122	Variable capacitor (for France, Switzerland & U.K.)
S901	2639893	Push switch (except France, Switzerland & U.K.)
S901	2639894	Push switch (for France, Switzerland & U.K.)
S902	2639893	Push switch (except France, Switzerland & U.K.)
S902	2639894	Push switch (for France, Switzerland & U.K.)
S903	2639894	Push switch (for France, Switzerland & U.K.)
	2689371	Antenna terminal (for U.S.A. & Canada)
	2689372	Antenna terminal (except U.S.A. & Canada)
<b>for FINAL ASSEMBLY</b>		
	4450361	Top cover [Silver]
	4415588	Top cover [Black]
	3297112	Knob (26) ass'y
	4567463	4 $\phi$ $\times$ 10 DT bind screw (for Cover) [Silver]
	4567443	4 $\phi$ $\times$ 10 DT bind screw (for Cover) [Black]

SYMBOL No.	PART No.	DESCRIPTION
<b>for DIAL MECHANISM ASSEMBLY</b>		
	3387631	Pointer ass'y
	3346212	Pulley
	3340321	Sprint (M)
	4420731	Gap spring
<b>for CHASSIS ASSEMBLY</b>		
	4025881	Front panel ass'y [Silver] (except France, Switzerland & U.K.)
	4025882	Front panel ass'y [Silver] (for France, Switzerland & U.K.)
	4025883	Front panel ass'y [Black] (except France, Switzerland & U.K.)
	4025884	Front panel ass'y [Black] (for France, Switzerland & U.K.)
	3965781	Blind
	3947541	Nilon rivet (B)
	3927412	Leg (10 $\times$ 21.8)
	3958741	Push button [Silver]
	3958743	Push button [Black]
	3958753	Push button
	3356266	Tuning ass'y
	4113441	M9 nut
	4567413	3 $\phi$ $\times$ 10 DT bind screw
	4567412	3 $\phi$ $\times$ 8 DT bind screw
	4784106	3 $\phi$ $\times$ 10 bind tapping screw
	4567432	3 $\phi$ $\times$ 8 DT bind screw
	4567454	3 $\phi$ $\times$ 12 DT bind screw
	4567462	AM loop antenna
	4458081	Rear plate (for U.S.A.)
	4458082	Rear plate (for Canada)
	4458083	Rear plate (for W. Germany & Italy)
	4458084	Rear plate (for Sweden & Australia)
	4458085	Rear plate (for Asia & Latin American countries)
	4458086	Rear plate (for France, Switzerland & U.K.)

HA-12

SYMBOL No.	PART No.	DESCRIPTION			
<b>CAPACITORS</b>					
C001	0243901	Ceramic, discal	0.01 $\mu$ F	+100% -0%	400V
C401LR	0252813	Electrolytic	3.3 $\mu$ F		50V
C402LR	0230036	Cylindrical ceramic (except W. Germany & Italy)	100pF	$\pm$ 5%	50V
C402LR	0240006	Cylindrical ceramic (for W. Germany & Italy)	330pF	$\pm$ 5%	50V
C403LR	0252322	Electrolytic	22 $\mu$ F		10V
C404LR	0240006	Cylindrical ceramic	330pF	$\pm$ 10%	50V
C405LR	0274014	Mylar, film	3300pF	$\pm$ 10%	50V
C406LR	0275231	Mylar, film	0.012 $\mu$ F	$\pm$ 5%	50V
C407LR	0252811	Electrolytic	1 $\mu$ F		50V
C408	0209737	Ceramic, discal (except W. Germany & Italy)	0.01 $\mu$ F	$\pm$ 10%	50V
C408	0274013	Mylar, film (for W. Germany & Italy)	2200pF	$\pm$ 10%	50V
C410	0274011	Mylar, film (for W. Germany & Italy)	0.082 $\mu$ F	$\pm$ 10%	50V
C411LR	0249724	Ceramic, discal (for W. Germany & Italy)	560pF	$\pm$ 10%	50V
C412L	0239408	Ceramic, discal (for W. Germany & Italy)	330pF	$\pm$ 10%	50V
C412R	0209721	Ceramic, discal (for W. Germany & Italy)	330pF	$\pm$ 10%	50V
C413	0274013	Mylar, film (for W. Germany & Italy)	2200pF	$\pm$ 10%	50V
C601LR	0240004	Cylindrical ceramic	220pF	$\pm$ 10%	50V
C602LR	0275014	Mylar, film	0.033 $\mu$ F	$\pm$ 10%	50V
C701LR	0252811	Electrolytic (except U.K.)	1 $\mu$ F		50V
C701LR	0252815	Electrolytic (for U.K.)	4.7 $\mu$ F		50V
C702LR	0240004	Cylindrical ceramic (except W. Germany & Italy)	220pF	$\pm$ 10%	50V
C702LR	0240008	Cylindrical ceramic (for W. Germany & Italy)	470pF	$\pm$ 10%	50V
C703LR	0240006	Cylindrical ceramic	330pF	$\pm$ 10%	50V
C704	0252821	Electrolytic (except U.K.)	10 $\mu$ F		50V
C704	0252825	Electrolytic (for U.K.)	47 $\mu$ F		50V
C705	0252825	Electrolytic (except U.K.)	47 $\mu$ F		50V
C706LR	0252625	Electrolytic	47 $\mu$ F		25V
C707	0252823	Electrolytic (except U.K.)	33 $\mu$ F		50V
C708LR	0276011	Mylar, film	0.1 $\mu$ F	$\pm$ 10%	50V
C709LR	0275015	Mylar, film	0.047 $\mu$ F	$\pm$ 10%	50V
C710LR	0274235	Mylar, film	5600pF	$\pm$ 10%	50V
C711LR	0275034	Mylar, film	0.039 $\mu$ F	$\pm$ 10%	50V
C712LR	0252802	Electrolytic	0.22 $\mu$ F		50V
C713LR	0252521	Electrolytic	10 $\mu$ F		16V
C714LR	0252521	Electrolytic	10 $\mu$ F		16V
C715LR	0252522	Electrolytic	22 $\mu$ F		16V
C717LR	0230012	Cylindrical ceramic (except W. Germany & Italy)	10pF	$\pm$ 5%	50V
C718LR	0274011	Mylar, film (for W. Germany & Italy)	1000pF	$\pm$ 10%	50V
C719	0274014	Mylar, film (for W. Germany & Italy)	3300pF	$\pm$ 30%	50V
C720LR	0274013	Mylar, film (for W. Germany & Italy)	2200pF	$\pm$ 30%	50V
C721	0276011	Mylar, film (for W. Germany & Italy)	0.1 $\mu$ F	$\pm$ 10%	50V

SYMBOL No.	PART No.	DESCRIPTION			
C722	0276011	Mylar, film (for W. Germany & Italy)	0.1 $\mu$ F	$\pm$ 10%	50V
C723	0209737	Ceramic, discal (for W. Germany & Italy)	0.01 $\mu$ F	$\pm$ 10%	50V
C725LR	0274011	Mylar, film (for W. Germany & Italy)	1000pF	$\pm$ 10%	50V
C726	0239427	Ceramic, discal (for W. Germany & Italy)	0.01 $\mu$ F	$\pm$ 10%	50V
C801	0241901	Ceramic, discal	0.1 $\mu$ F	+80% -20%	250V
C802	0276511	Mylar, film (for W. Germany & Italy)	0.1 $\mu$ F	$\pm$ 10%	100V
C803	0259933	Electrolytic	5600pF		40V
C804	0259933	Electrolytic	5600pF		40V
C805	0252631	Electrolytic	100 $\mu$ F		25V
C806	0252631	Electrolytic	100 $\mu$ F		25V
C807	0252525	Electrolytic	47 $\mu$ F		16V
C809	0252821	Electrolytic	10 $\mu$ F		50V
C810	0252231	Electrolytic	100 $\mu$ F		6.3V
C811	0252811	Electrolytic (for U.K.)	1 $\mu$ F		50V
<b>RESISTORS</b>					
R401LR	0129579	Carbon film (except W. Germany & Italy)	560 $\Omega$	$\pm$ 5%	SRD1/4P
R401LR	0129609	Carbon film (for W. Germany & Italy)	2.2k $\Omega$	$\pm$ 5%	SRD1/4P
R402LR	0129647	Carbon film	47k $\Omega$	$\pm$ 5%	SRD1/4P
R403LR	0129577	Carbon film	470 $\Omega$	$\pm$ 5%	SRD1/4P
R404LR	0129639	Carbon film	22k $\Omega$	$\pm$ 5%	SRD1/4P
R405LR	0129671	Carbon film	270k $\Omega$	$\pm$ 5%	SRD1/4P
R406LR	0129653	Carbon film	82k $\Omega$	$\pm$ 5%	SRD1/4P
R407LR	0129870	Carbon film (for W. Germany & Italy)	1k $\Omega$	$\pm$ 5%	SRD1/4P
R409LR	0129870	Carbon film (for W. Germany & Italy)	1k $\Omega$	$\pm$ 5%	SRD1/4P
R411LR	0129870	Carbon film (for W. Germany & Italy)	1k $\Omega$	$\pm$ 5%	SRD1/4P
R412LR	0129617	Carbon film (for W. Germany & Italy)	4.7k $\Omega$	$\pm$ 5%	SRD1/4P
R413LR	0129601	Carbon film (for W. Germany & Italy)	1k $\Omega$	$\pm$ 5%	SRD1/4P
R601LR	0129631	Carbon film	10k $\Omega$	$\pm$ 5%	SRD1/4P
R602LR	0129637	Carbon film	18k $\Omega$	$\pm$ 5%	SRD1/4P
R701LR	0129609	Carbon film	2.2k $\Omega$	$\pm$ 5%	SRD1/4P
R702LR	0129653	Carbon film	82k $\Omega$	$\pm$ 5%	SRD1/4P
$\Delta$ R703	0110621	Metal(fuse Resistor) (for U.K.)	100 $\Omega$	$\pm$ 5%	RN1/4B
R704LR	0129609	Carbon film	2.2k $\Omega$	$\pm$ 5%	SRD1/4P
R705LR	0129609	Carbon film	2.2k $\Omega$	$\pm$ 5%	SRD1/4P
R706	0134373	Composition (except U.K.)	1k $\Omega$	$\pm$ 10%	RC1/2GF
R707	0129601	Carbon film (except U.K.)	1k $\Omega$	$\pm$ 5%	SRD1/4P
R708	0129617	Carbon film (except U.K.)	4.7k $\Omega$	$\pm$ 5%	SRD1/4P
R709LR	0129531	Carbon film (except W. Germany & Italy)	10 $\Omega$	$\pm$ 5%	SRD1/4P
R709LR	0134289	Composition (for W. Germany & Italy)	10 $\Omega$	$\pm$ 10%	RC1/2GF
R710LR	0119139	Metal	4.7 $\Omega$	$\pm$ 10%	RN2B
R711LR	0129609	Carbon film	2.2k $\Omega$	$\pm$ 5%	SRD1/4P
R712LR	0129577	Carbon film	470 $\Omega$	$\pm$ 5%	SRD1/4P
R713LR	0129633	Carbon film	12k $\Omega$	$\pm$ 5%	SRD1/4P

SYMBOL No.	PART No.	DESCRIPTION		
R715LR	0129605	Carbon film	1.5kΩ ±5%	SRD1/4P
R716LR	0129621	Carbon film	6.8kΩ ±5%	SRD1/4P
R717LR	0129579	Carbon film	560Ω ±5%	SRD1/4P
R718LR	0129653	Carbon film	82kΩ ±5%	SRD1/4P
R720LR	0134367	Composition	330Ω ±10%	RC1/2GF
R801	0134375	Composition	1.5kΩ ±10%	RC1/2GF
R802	0134375	Composition	1.5kΩ ±10%	RC1/2GF
R803	0119159	Metal	47Ω ±10%	RN2B
R804	0129617	Carbon film	4.7kΩ ±5%	SRD1/4P
R806	0134378	Composition	2.7kΩ ±10%	RC1/2GF
R807	0129669	Carbon film (except U.K.)	220kΩ ±5%	SRD1/4P
R807	0129667	Carbon film (for U.K.)	180kΩ ±5%	SRD1/4P
R808	0129647	Carbon film (except U.K.)	47kΩ ±5%	SRD1/4P
R808	0129631	Carbon film (for U.K.)	10kΩ ±5%	SRD1/4P
△R809	0118445	Metal(fuse resistor)	4.7Ω ±5%	RN1/4B
R810	0129653	Carbon film	82kΩ ±5%	SRD1/4P
R811	0129601	Carbon film	1kΩ ±5%	SRD1/4P
R812	0134376	Composition	1.8kΩ ±10%	RC1/2GF
R813	0134376	Composition	1.8kΩ ±10%	RC1/2GF
R814	0139005	Composition (for U.S.A. & Canada)	2.7MΩ ±10%	RC1/2GF
R815	0129623	Carbon film	8.2kΩ ±10%	SRD1/4P
<b>ICS &amp; TRANSISTORS</b>				
IC401	2387301	M5218P		
IC701	2387531	STK4141 II (except U.K.)		
IC701	2368842	STK463B (for U.K.)		
Q801	2329183	2SA1015 (GR) (except U.K.)		
Q801	2329582	2SA933 (R) (for U.K.)		
Q802	2317822	2SD880		
Q803LR	2329582	2SA933 (R) (for U.K.)		
<b>DIODES</b>				
D801	2337461	S4VB20		
D802	2337762	FRB12-01R		
D803	2337011	1S2076		
D805	2339981	LED LD-001GG		
D806	2337011	1S2076 (for U.K.)		
ZD801	2337587	HZ5C-3		
ZD802	2337532	HZ-15-2		
<b>VARIABLE RESISTORS</b>				
R651	0166751	200kΩ - (B) (MAIN)		
R652	0151848	200kΩ - (W) (BALANCE)		
R751	0158733	50kΩ - (C) (TONE)		
R752	0158733	50kΩ - (C) (TONE)		
<b>COILS</b>				
L701LR	2227361	Audio trap coil (except W. Germany & Italy)		
L701LR	2227311	Audio trap coil (for W. Germany & Italy)		

SYMBOL No.	PART No.	DESCRIPTION
<b>MISCELLANEOUS</b>		
△F001	2727964	Fuse 2.5A (for U.S.A. & Canada)
△F001	2727191	Fuse T1A 250V (except U.S.A., Canada, Asia & Latin American countries)
	2639660	4 key push switch (FUNCTION)
	2600141	Push switch (LOUDNESS)
	2600122	2 key push switch (SPEAKER)
	2639869	Power switch
	2688282	4P push terminal
	2677753	Headphone jack
	2678347	6P US pin jack
	2678348	4P US pin jack
	2678451	DC jack
<b>for FINAL ASSEMBLY</b>		
	3965761	Front panel ass'y [Silver]
	3965762	Front panel ass'y [Black]
	3297101	Knob (20)
	3296681	REC knob
	3292555	Knob (10)
	4453241	Cover (for U.K.) [Silver]
	4453242	Cover (except U.K.) [Silver]
	4455940	Cover [Black]
	3297792	Power button ass'y
	3297801	Push knob
	3297821	Push knob ass'y
	3297822	Push knob
	3297823	Push knob
	3297811	Push knob
	3297841	Push knob [Silver]
	3297843	Push knob [Black]
	3927411	Leg
	4567411	3φ × 6 DT bind screw
	4567432	3φ × 8 DT bind screw
	4784106	3φ × 10 bind tapping screw
	4567454	3φ × 12 DT bind screw
	4567422	4φ × 8 DT bind screw
	4567413	3φ × 10 DT bind screw
	4567412	3φ × 8 DT bind screw
	8811114	3φ Washer
<b>for REAR PLATE ASSEMBLY</b>		
	4458231	Rear plate (for U.S.A.)
	4458232	Rear plate (for Canada)
	4458233	Rear plate (for France, Switzerland, Sweden & W. Germany & Italy)
	4458234	Rear plate (for U.K. & Australia)
	4458235	Rear plate (for Asia & Latin American countries)
	0043793	Bushing (for U.S.A. & Canada)
	3913006	Bushing (except U.S.A. & Canada)
	2700121	Power supply cord (for U.S.A. & Canada)
	2748752	Power supply cord (for France, Switzerland, Sweden, W. Germany, Italy, Asia & Latin American countries)
	2749582	Power supply cord (for U.K.)

SYMBOL No.	PART No.	DESCRIPTION
△	2749622	Power supply cord (for Australia)
△	2658481	AC outlet (for U.S.A. & Canada)
△	2658372	AC outlet (for Asia & Latin American countries)
△	2618053	AC selector switch (for Asia & Latin American countries)
△	2727191	Fuse T1A
△	4567432	3φ × 8 DT bind screw (for Asia & Latin American countries)

SYMBOL No.	PART No.	DESCRIPTION
<b>for ACCESSORIES</b>		
△	2757525	FM antenna (except W. Germany & Italy)
△	2717514	DC plug cord (for U.S.A. & Canada)
△	2702451	DC cord
△	2749500	Patch cord
△	2658361	E socket adaptor (for Asia & Latin American countries)
△	2727193	Fuse T2A 250V (for Asia & Latin American countries)

Check that exposed parts are acceptably insulated from the supply circuit before returning the instrument repaired to the customer.

● **Checking method**

Power switch is set to ON.  
 Next, measure the resistance value between the both poles of attachment cup (Power supply plug) and the exposed parts (Parts such as Ground terminal, Knob, Cover, etc. where the customer is easy to touch.) and check that the resistance value is 500 kohms or more.

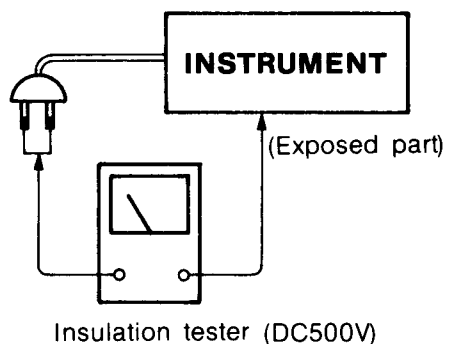

**HITACHI SALES EUROPA GmbH**

Postfach 801060 Rungedamm 2, 2050 Hamburg 80,  
West Germany  
Tel. 040-734 11-0

**HITACHI SALES (U.K.) Ltd.**

Hitachi House, Station Road, Hayes, Middlesex UB3  
4DR, England  
Tel. 01-848-8787

**HITACHI SALES SCANDINAVIA AB**

Rissneleden 8, Box 7138, 172-07 Sundbyberg, Sweden  
Tel. 08-98 52 80

**HITACHI SALES NORWAY A/S**

Oerebekk 1620, Gressvik, P.O. Box 46, N-1601,  
Fredrikstad, Norway  
Tel. 032-28255

**SUOMEN HITACHI OY**

Takojankatsu 5, 15800 Lahti 80, Finland  
Tel. Lahti 44 241

**HITACHI SALES A/S**

Kuldysen 13, DK-2630, Taastrup, Denmark  
Tel. 02-999200

**HITACHI SALES A.G.**

Bahnhofstrasse, 19, 5600 Lenzburg, Switzerland  
Tel. 064-513621

**HITACHI SALES WARENHANDELS GMBH**

A-1180/Wien, Kreuzgasse 27, Austria  
Tel. 0222-439367

**HITACHI SALES ITALIANA, S.P.A.**

Via Cristoforo Colombo 49, Trezzano sul naviglio  
(Milano), Italy  
Tel. 02-44 59 031

**HITACHI SALES BELGIUM S.A.**

56 Chaussee de Namur B-1400 Nivelles, Belgium  
Tel. (003267) 227181

**HITACHI SALES IBERICA, S.A.**

Gran Via Carlos Tercero, 101, 1-1, Barcelona-28,  
Spain  
Tel. 330-8652

**HITACHI MAROC (RADIO TV ELECTRO-MANAGER), S.A.**

Rue du Havre, Casablanca, Morocco  
Tel. 30-73-68, 30-73-57

**HITACHI CANARIAS S.A.**

Calle San-Francisco No. 19, Santa Cruz de Tenerife  
Canary Islands  
Tel. 24-64-98

**HITACHI SALES (HELLAS) LTD.**

110 Syngrou St., Athens, Greece  
Tel. 9219082, 9233469

**HITACHI SALES (MALAYSIA) SDN. BHD.**

17, Jalan 20/16, Petaling Jaya, Selangor, Malaysia  
Tel. 762523, 769918, 769836, 762594

**HITACHI (SINGAPORE) PTE., LTD.**

Room B, C & D, 15th Floor, Yen San Building  
268 Orchard Road, Singapore 9, Singapore  
Tel. 7378244, 7379826

**HITACHI SALES (THAILAND) LTD.**

2242-48, New Petchburi Road, Bangkapi, Hueykuang  
Bangkok, Thailand  
Tel. 314-2741

**HITACHI ELECTRIC SERVICE CO., (HONG KONG) LTD.**

4th Floor Leun Tai Industrial Bldg., 72-76 Kwai Cheong  
Road Kwai Chung N.T., Hong Kong  
Tel. 240126

**HITACHI SALES AUSTRALIA PTY LTD.**

153 Keys Road, Moorabbin, Victoria 3189 Australia  
Tel. 555-8722

**HITACHI SALES CORPORATION OF AMERICA**

Eastern Regional Office  
1200 Wall Street West, Lyndhurst, New Jersey 07071, U.S.A.  
Tel. 201-935-8980

**Mid-Western Regional Office**

1400 Morse Ave., Elk Grove Village, Ill. 60007, U.S.A.  
Tel. 312-593-1550

**Southern Regional Office**

510 Plaza Drive, College Park, Georgia 30349, U.S.A.  
Tel. 404-763-0360

**Western Regional Office**

401 West Artesia Boulevard, Compton, California 90220 U.S.A.  
Tel. 213-537-8383

**HITACHI SALES CORPORATION OF HAWAII, INC.**

3219 Koapaka Street, Honolulu, Hawaii 96819, U.S.A.  
Tel. 808-836-3621

**HITACHI (HSC) CANADA INC.**

3300 Trans-Canada Highway, Pointe Claire, Quebec,  
H9R 1B1, Canada  
Tel. 514-697-9150

**Hitachi Sales Centroamericans, S.A.**

San Rafael de Excazu, (Apartado 10272), San Jose,  
Costa Rica  
Tel. 28-20-11, 28-00-37

**Hitachi Sales Corporation de Panama, S.A.**

Nuevo Repato E1 Camen, Calle Ramon Arias y Calle B  
Edificio Brasil 100. (Apartado 7657) Panama 5  
Panama City, Rep. of Panama  
Tel. 61-3100, 61-4305

**Hitachi Sales de Chile Cia., Ltda.**

Av. Mexico, 0183, Casilla 9793, Correo Central  
Santiago, Chile  
Tel. 774165

**HITACHI-FRANCE S.A.**

95-101 Rue Charles Michels,  
93200 SAINT-DENIS,  
France  
Tel. 821 6015

**HITACHI LTD. TOKYO JAPAN**

Head Office : THE HITACHI ATAGO BLDG.  
No. 15-12, 2-Chome Nishi-Shinbashi  
Minato-Ku, Tokyo 105, Japan  
Tel. Tokyo (03) 502-2111

**HTA-12 TY No. 411 EGF**