

HITACHI

SERVICE MANUAL

TY**No. 451 EGF**

HTA-09

(ES VS KS BS SA ZS EW)

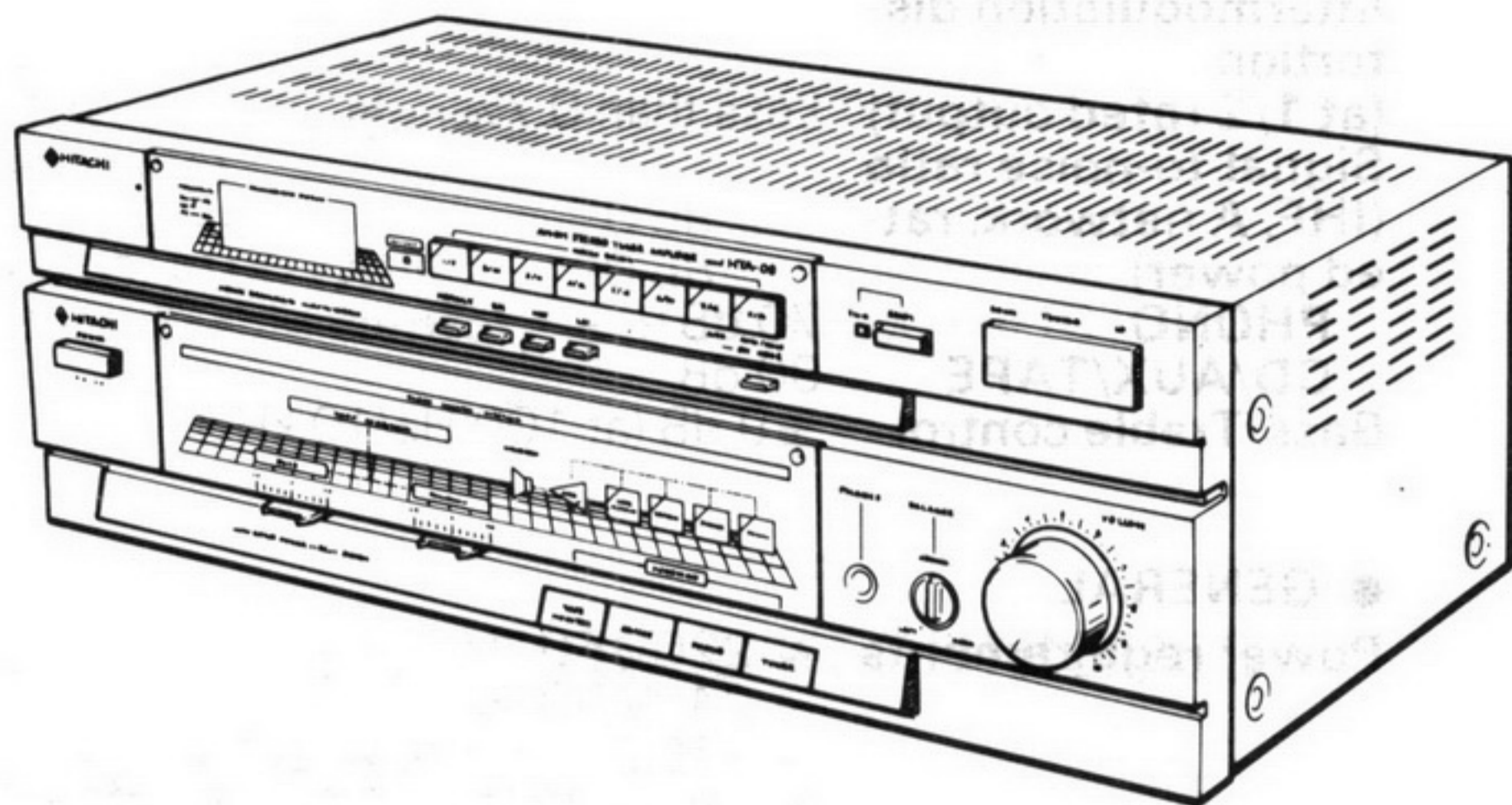
**CONTENTS · INHALT · SOMMAIRE**

SPECIFICATIONS · TECHNISCHE DATEN ·	
CARACTERISTIQUES TECHNIQUES.....	2, 3
CIRCUIT BOARD CHECKING AND ESCUTCHEON ASS'Y	
DISASSEMBLY PROCEDURES ·	
PRÜFUNG DER LEITERPLATTE UND FRONTPLATTEN-	
DEMONTAGE-VORGÄNGE ·	
CONTROLE DE CARTE A CIRCUITS IMPRIMES ET	
PROCEDE DE DEMONTAGE DE PLAQUE DECORATIVE....	4
GENERAL ALIGNMENT INSTRUCTION ·	
ALLGEMEINE AUSRICHTANLEITUNG ·	
INSTRUCTIONS GENERALES	5
FM TUNER ALIGNMENT · ABGLEICH DES UKW-TUNERS ·	
REGLAGE DE TUNER FM.....	5,6
AM TUNER ALIGNMENT · ABGLEICH DES AM-TUNERS ·	
REGLAGE DE TUNER AM.....	7
BLOCK DIAGRAM · BLOCK SCHEMA · SCHEMA.....	8
PRINTED WIRING BOARD · PRINTPLATTEN · PLAN DE	
CIRCUIT.....	9
CIRCUIT DIAMGRAM · SCHALTPLAN · PLAN DE	
CIRCUIT.....	10-11
FRONT AND REAR PANEL · VORDERE UND HINTERE	
BEDIENUNGSRAFFL · PANNEAUX AVANT ET ARRIERE	12
REPLACEMENT PARTS LIST · ERSATZTEILISTE ·	
TABLEAU DES PIECE.....	13

SAFETY PRECAUTION

The following precautions should be observed when servicing.

1. Since many parts in the unit have special safety related characteristics, always use genuine Hitachi's replacement parts. Especially critical parts in the power circuit block should not be replaced with other markers. Critical parts are marked with Δ in the circuit diagram and printed wiring board.
2. Before returning a repaired unit to the customer, the service technician must thoroughly test the unit to ascertain that it is completely safe to operate without danger of electrical shock.

SICHERHEITSMASSNAHMEN

Bei Wartungsarbeiten sind die folgenden Sicherheitsmaßnahmen zu beachten:

1. Da verschiedene Teile dieses Gerätes Sicherheitsfunktionen aufweisen, nur Original-Hitachi-Ersatzteile verwenden. Kritische Teile im Netzteil sollten nicht durch ähnliche Teil anderer Hersteller ersetzt werden. Alle kritischen Teil sind im Schaltplan und im Diagramm der Schaltplatinen mit dem Symbol Δ gekennzeichnete.
2. Vor der Auslieferung eines reparierten Gerätes an den Kunden muß der Wartungstechniker das Gerät einer gründlichen Prüfung unterziehen, um sicherzustellen, daß sicherer Betrieb ohne die Gefahr von elektrischen Schlägen gewährleistet ist.

PRÉCAUTIONS DE SÉCURITÉ

Les précautions suivantes doivent être observées chaque fois qu'une réparation doit être faite.

1. Etant donné que de nombreux composants de l'appareil possèdent des caractéristiques relatives à la sécurité, utiliser uniquement des pièces de rechange d'origine Hitachi pour effectuer un remplacement du bloc d'alimentation qui ne doivent en aucun cas être remplacées par celles d'autres fabricants. Les pièces critiques sont accompagnés du symbole Δ dans le schéma de montage et sur le schéma de plaque de câblage.
2. Avant de retourner l'appareil réparé au client le technicien doit procéder à un essai complet pour s'assurer qu'il ne présente aucun danger de chocs électriques.

SPECIFICATIONS AND PARTS ARE SUBJECT TO CHANGE FOR IMPROVEMENT.

STEREO TUNER AMPLIFIER

SPECIFICATIONS

● **FM SECTION**

Frequency range	87.50 – 108.00 MHz (50 kHz spacing)
Usable sensitivity	1.5 μ V (IEC)
Signal-to-noise ratio (at 65 dBf)	Mono: 69 dB (IHF) Stereo: 67 dB (IHF) Mono: 60 dB (DIN AUDIO Q-Peak) 60 dB (DIN NOISE Q-Peak) Stereo: 58 dB (DIN AUDIO Q-Peak) 57 dB (DIN NOISE Q-Peak)
Total harmonic distortion (1 kHz, at 65 dBf)	Mono: 0.3% Stereo: 0.6%
Frequency response	30 Hz – 12 kHz \pm 2.5 dB
Selectivity	45 dB (\pm 300 kHz) (except W.Germany) 60 dB (\pm 300 kHz, DIN)(for W.Germany)
Stereo separation	40 dB
Antenna input	75 ohms unbalanced

● **MW SECTION**

Frequency range	522 – 1,611 kHz (9 kHz spacing) 530 – 1620 kHz (10 kHz spacing) (for multi-voltage unit only)
Sensitivity	40 μ V(IEC)
Selectivity	36 dB (\pm 9 kHz)
Signal-to-noise ratio	45 dB
Antenna input:	AM loop antenna and external terminal

● **LW SECTION**

Frequency range:	146 – 353 kHz (1 kHz spacing)
Sensitivity:	350 μ V (IEC)
Antenna input:	AM loop antenna and external terminal

● **AUDIO SECTION**

RMS Power (Both channels driven)	30W + 30W (8 ohms, 1 kHz, T.H.D. 0.7%)
Power bandwidth	20 Hz – 30 kHz (1/2 RMS power, T.H.D. 0.7% at 8 ohms)
Total harmonic distortion (at rated output)	less than 0.7%
Intermodulation distortion (at 1/2 rated output)	Less than 0.7%
Signal-to-noise ratio (IHF, A network, rated power)	
PHONO	70 dB
CD/AUX/TAPE	90 dB
Bass/Treble control	\pm 9 dB (at 100 Hz/10 kHz)

● **GENERAL**

Power requirements	~ 220V 50 Hz ~ 240V 50 Hz ~ 110V ~ 120V, ~ 200V ~ 220V, ~ 230V ~ 240V, 50/60 Hz (for multi voltage unit only)
Power consumption	180W
Dimensions	435(W) x 143(H) x 210(D) mm
Weight	4.7 kg

Measured Pursuant to the Federal Trade Commission's Trade Regulation Rule on Power Output Claims for Amplifiers.

TECHNISCHE DATEN

● **FM-TEIL**

Frequenzbereich	87,50–108,00 MHz (Kanalabstand 50 kHz)
Netzempfindlichkeit	1.5 μ V (IEC)
Signal/Rausch-Abstand (bei 65 dBf)	Mono: 69 dB (IHF) Stereo: 67 dB (IHF) Mono: 60 dB (DIN AUDIO Q-Peak), 60 dB (DIN NOISE Q-Peak) Stereo: 58 dB (DIN AUDIO Q-Peak), 57 dB (DIN NOISE Q-Peak)
Klirrgrad (1 kHz, bei 65 dBf)	Mono: 0,3% Stereo: 0.6%
Frequenzgang	30 Hz – 12 kHz \pm 2,5 dB
Selektivität	45 dB (\pm 300 kHz) (außer der Bundesrepublik Deutschland) 60 dB (\pm 300 kHz, DIN) (für die Bundesrepublik Deutschland)
Stereo-Trennung	40 dB
Antenna input	75 ohms unbalanced

● **MW-TEIL**

Frequenzbereich	522 – 1611 kHz (Kanalabstand 9 kHz) 530 – 1620 kHz (Kanalabstand 10 kHz)
Empfindlichkeit	40 μ V (IEC)
Selektivität	36 dB (\pm 9 kHz)
Störspannungsabstand:	45 dB
Antenneneingang:	MW/LW-Rahmenantenne und Anschluß für externe Antenne

● **LW TEIL**

Frequenzbereich:	146 – 353 kHz (Kanalabstand 1 kHz)
Empfindlichkeit:	350 μ V (IEC)
Antenneneingang:	MW/LW-Rahmenantenne und Anschluß für externe Antenne

CIRCUIT DIAGRAM
SCHALTPLAN
PLAN DE CIRCUIT

- * : Axial lead cylindrical ceramic capacitor
- * : Zylindrischer Keramik Kondensator mit axialer Zuleitung
- * : Condensateur céramique cylindrique à conducteur axial

CAUTION
 Use the electrolytic diameter of the

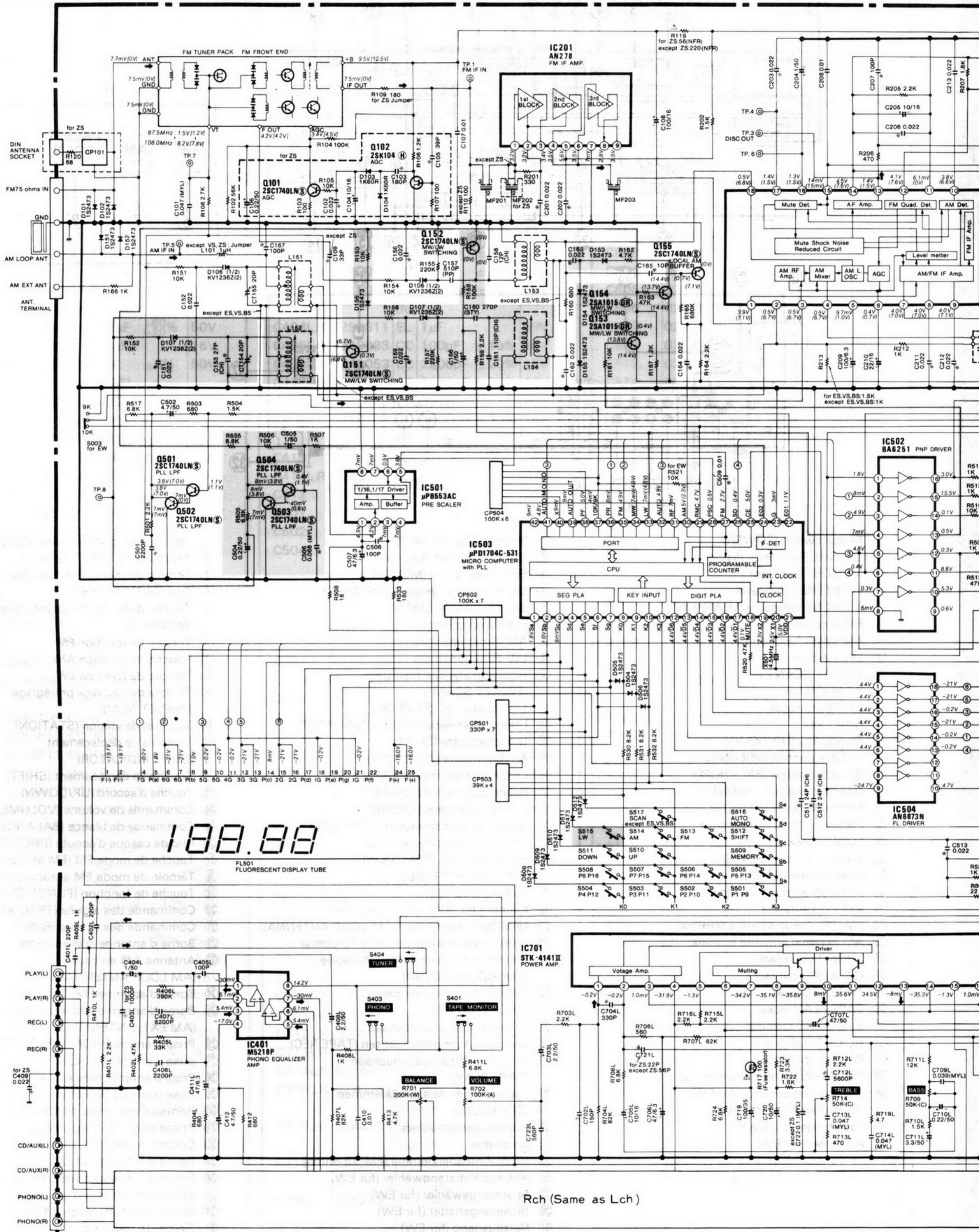

Rch (Same as Lch)

CAUTION

Use the electrolytic capacitors with explosion-proof valve when the diameter of them is more than 10 mm ϕ .

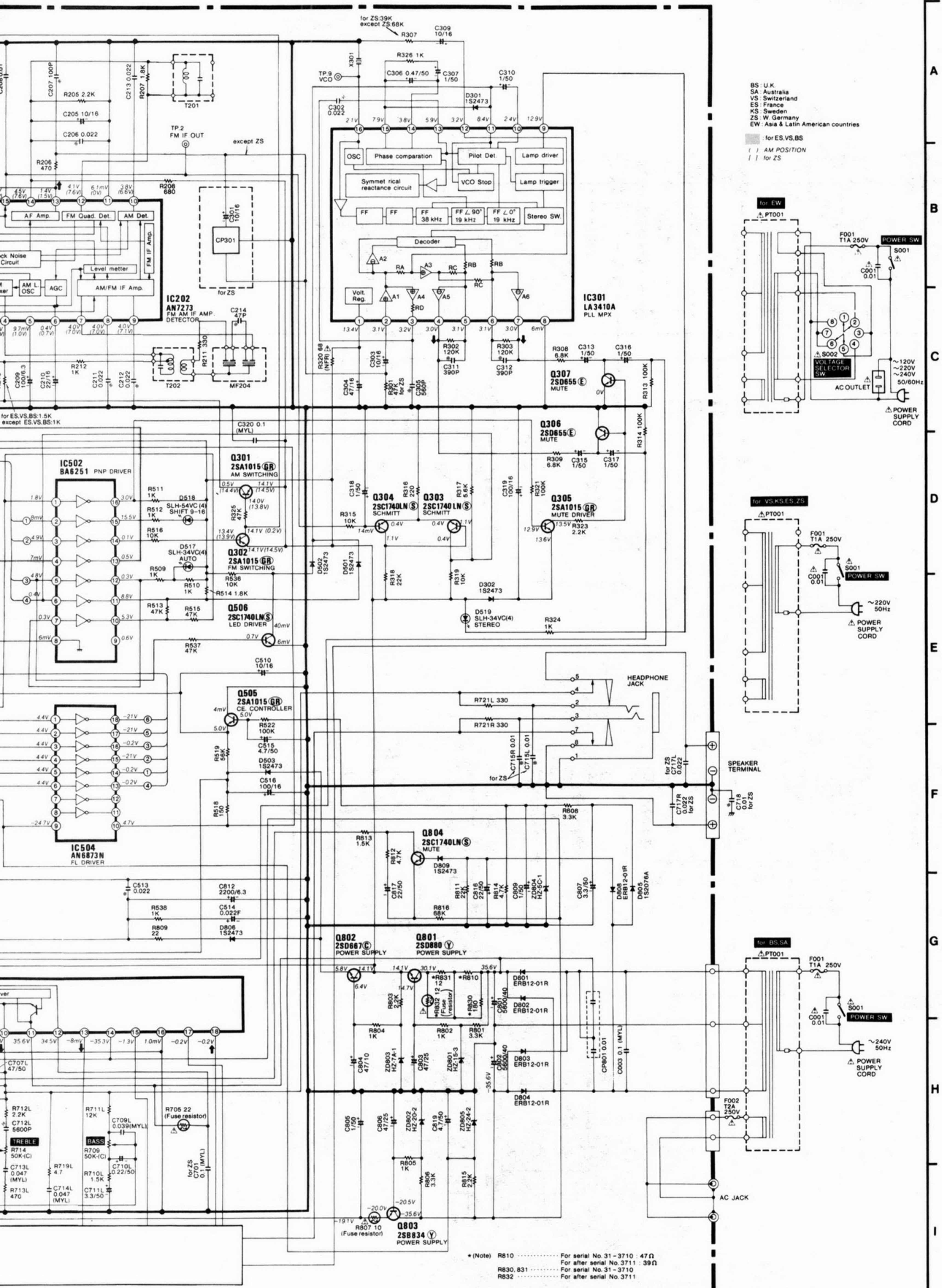

BS: U.K.
 SA: Australia
 VS: Switzerland
 ES: France
 KS: Sweden
 ZS: W. Germany
 EW: Asia & Latin American countries

for ES, VS, BS
 for AM POSITION
 for ZS

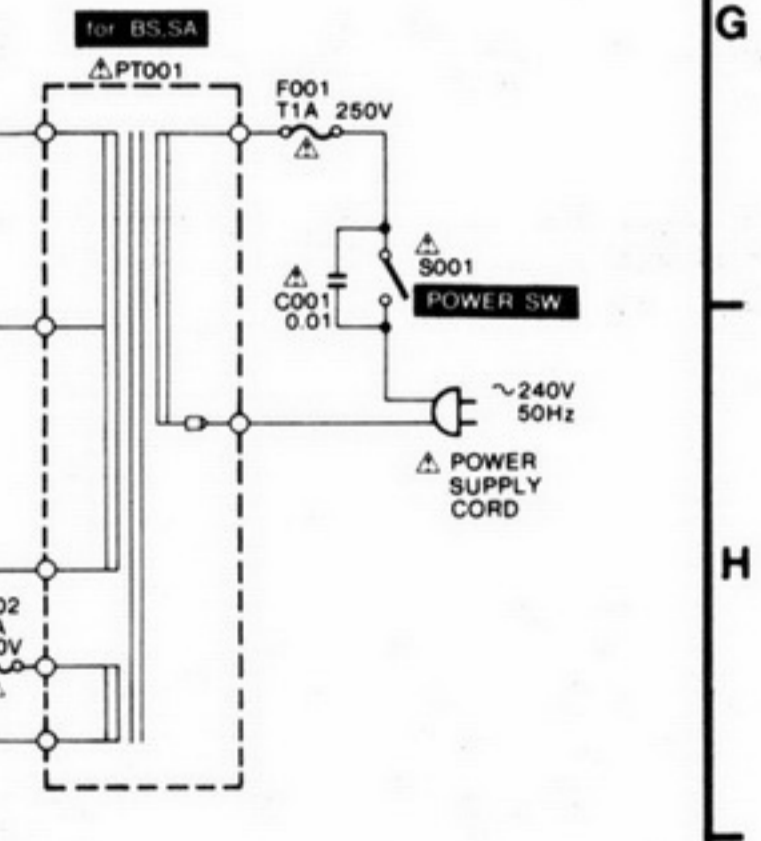
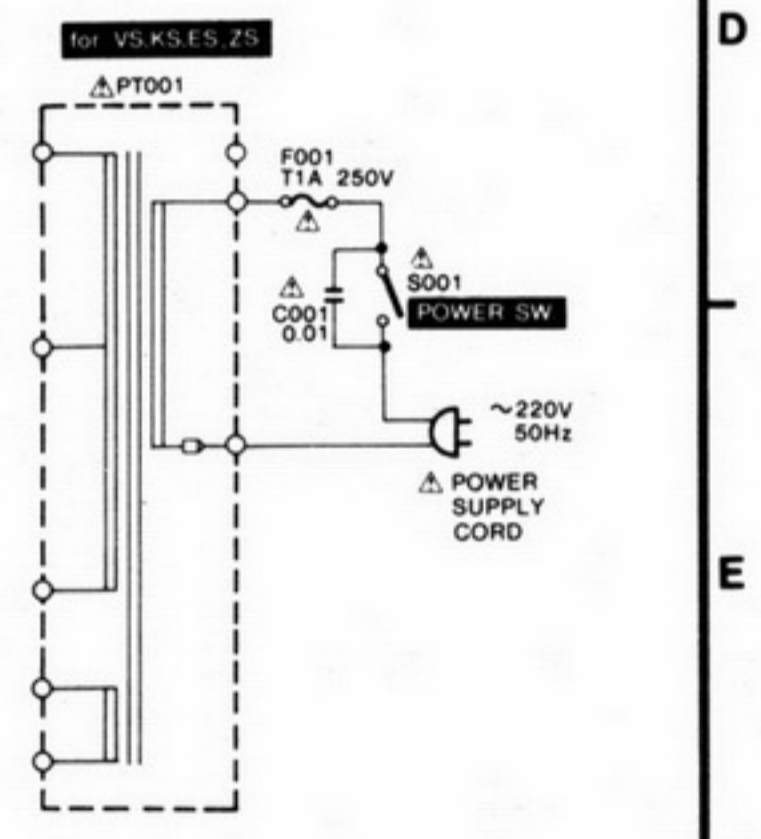
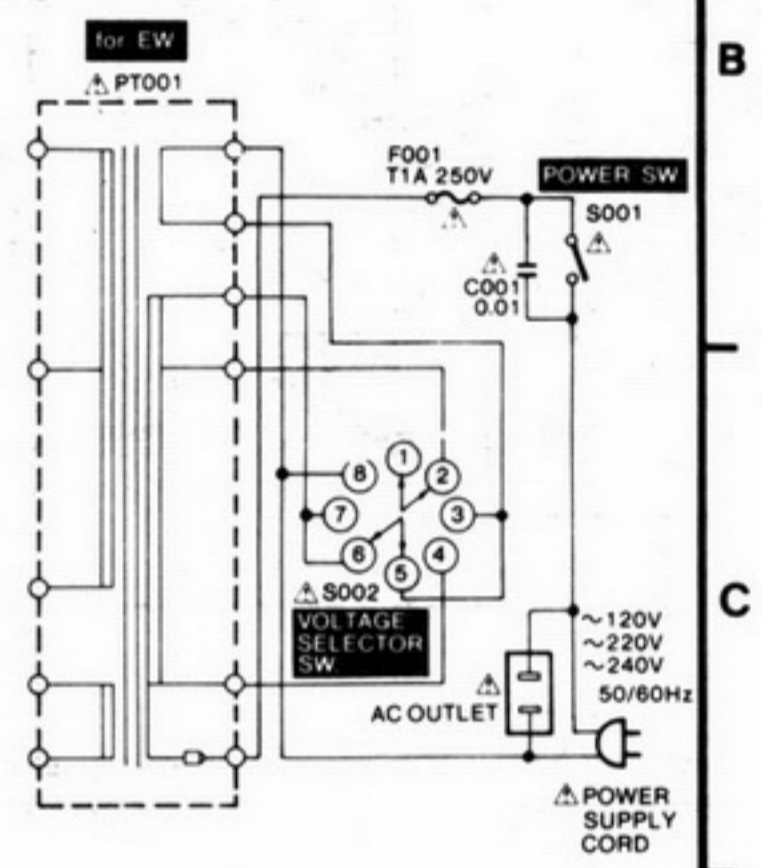

(Note) R810 For serial No. 31 - 3710 : 47 Ω
 For after serial No. 3711 : 39 Ω
 R830, 831 For serial No. 31 - 3710
 R832 For after serial No. 3711

CIRCUIT DIAGRAM · SCHALTPLAN · PLAND DE CIRCUIT

FM Front End (Tuner Pack)

(Except W. Germany)

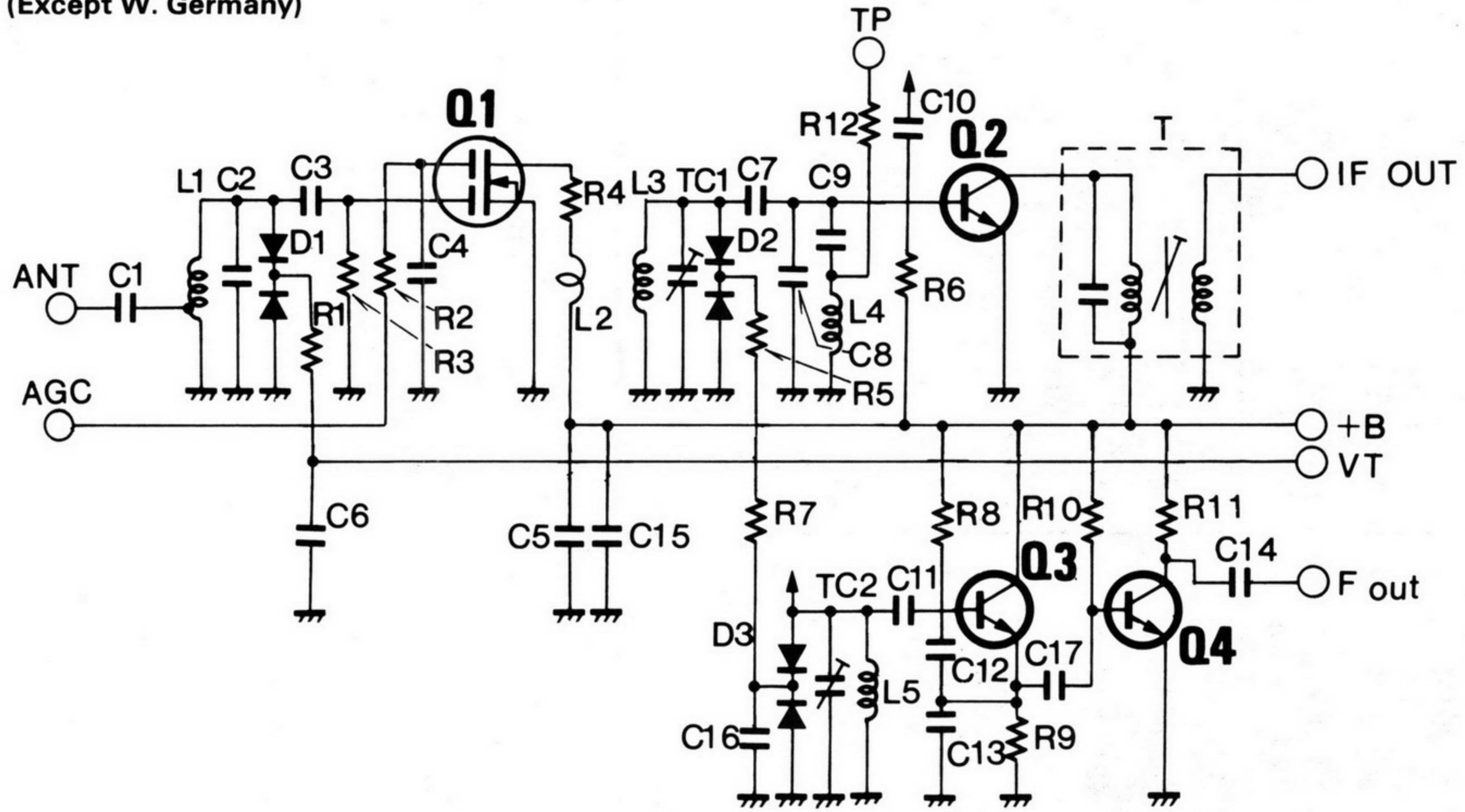

(For W. Germany)

