

HITACHI

SERVICE MANUAL

TY

No. 411 EGF

HTA-12

(FT-12, HA-12)

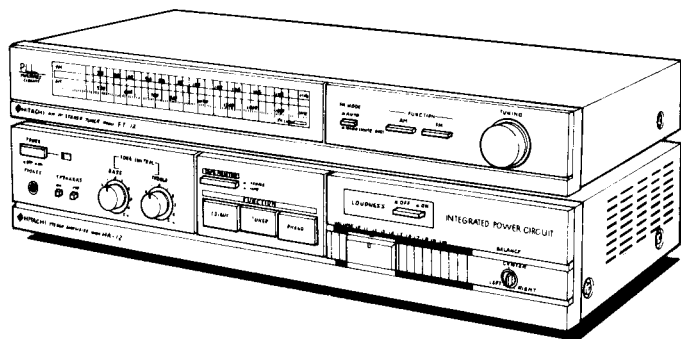

The HTA-12 comes in two color versions, black and silver. They are the same except for parts list.

Der HTA-12 wird in zwei Versionen geliefert, schwarz und silber. Sie sind gleich mit Ausnahme der Teilleiste.

Le HTA-12 est disponible en deux versions, noir et argent. Elles sont identiques à l'exception de la liste des pièces.

CONTENTS · INHALT · SOMMAIRE

SPECIFICATIONS · TECHNISCHE DATEN · CARACTÉRISTIQUES TECHNIQUES	1 ~ 4
DIAL CORD SETTING · SKALENSEILEINSTELLUNG · EQUIPEMENT DE CADRAN	4
DISASSEMBLY AND REPLACEMENT · ZERLEGUNG UND AUSTAUSCH · DEMONTAGE ET REMONTAGE	5
BLOCK DIAGRAM · BLOCK SCHEMA · SCHEMA	6
GENERAL ALIGNMENT INSTRUCTION · ALLGEMEINE AUSRICHTANLEITUNG · INSTRUCTIONS GENERALES	7
FM TUNER ALIGNMENT · ABGLEICH DES UKW-TUNERS · REGLAGE DE TUNER FM	7, 8
AM TUNER ALIGNMENT · ABGLEICH DES AM-TUNERS · REGLAGE DE TUNER AM	9, 10
PRINTED WIRING BOARD · PRINTPLATTEN · PLAN DE BASE	11, 13, 15, 17
CIRCUIT DIAGRAM · SCHALTPLAN · PLAN DE BASE	12, 14, 16, 17
FRONT AND REAR PANEL · VORDERE UND HINTERE BEDIENUNGSTAFEL · PANNEAUX AVANT ET ARRIERE	18, 19
REPLACEMENT PARTS LIST · ERSATZTEILISTE · TABLEAU DES PIÈCE	20 ~ 25

SAFETY PRECAUTION

The following precautions should be observed when servicing.

- Since many parts in the unit have special safety related characteristics, always use genuine Hitachi's replacement parts. Especially critical parts in the power circuit block should not be replaced with other makers. Critical parts are marked with Δ in the circuit diagram and printed wiring board.
- Before returning a repaired unit to the customer, the service technician must thoroughly test the unit to ascertain that it is completely safe to operate without danger of electrical shock.

SPECIFICATIONS

FT-12

Circuitry	AM/FM 2-band Stereo tuner MW/LW/FM 3-band Stereo tuner	Selectivity	50 dB
• FM SECTION		Stereo separation	40 dB (1 kHz) [except for W. Germany & Italy]
Frequency range	88 - 108 MHz	Capture ratio	1.0 dB
Usable Sensitivity	11.2 dBf (IHF), 1.0 μ V (75 ohms DIN)	Output voltage	550 mV (1 kHz)
50 dB Quieting Sensitivity	22.4 dBf (MONO) 39.5 dBf (STEREO)	• AM (MW) SECTION	
Image interference ratio	45 dB (98 MHz)	Frequency range	530 - 1,605 kHz
Total harmonic distortion	MONO : 0.3 % (1 kHz) STEREO : 0.4 % (1 kHz)	Sensitivity	40 μ V (DIN) ... S/N 26 dB 20 μ V (IHF) 500 μ V/m (IHF Loop antenna)
Signal-to-noise ratio	MONO : 75 dB (IHF) 65 dB (IEC, unweighted, Q-peak) 60 dB (IEC, weighted, Q-peak) STEREO : 70 dB (IHF) 60 dB (IEC, unweighted, Q-peak) 55 dB (IEC, weighted, Q-peak)	Image interference ratio	38 dB
Frequency response	50 Hz - 12 kHz (50 μ s \pm 2 dB) 50 Hz - 15 kHz (50 μ s $\begin{smallmatrix} +1.0 \\ -6.0 \end{smallmatrix}$ dB) [for W. Germany & Italy] 50 Hz - 12 kHz (75 μ s \pm 2 dB) [for U.S.A. & Canada]	Selectivity	35 dB
		Signal-to-noise ratio	45 dB
		Output voltage	165 mV (400 Hz, 30% modulation)
		• AM (LW) SECTION	
		Frequency range	150 - 350 kHz
		Sensitivity	200 μ V (DIN) ... S/N 26 dB
		• GENERAL	
		Dimensions	435(W) \times 60(H) \times 236(D) mm
		Weight	2.4 kg (5.3 lbs.)

SPECIFICATIONS AND PARTS ARE SUBJECT TO CHANGE FOR IMPROVEMENT.

STEREO TUNER AMPLIFIER

March 1984

TOYOKAWA WORKS

HA-12

Power output (Both channels driven)	28 watts + 28 watts* min RMS, at 8 ohms from 40 Hz to 20 kHz, with no more than 0.9% total harmonic distortion. 30 W + 30 W (8 ohms, 1 kHz, T.H.D. 0.7% IEC) 30 W/ch + 30 W/ch (8 ohms 40 - 20 kHz, T.H.D., 0.7%)	Output level TAPE REC OUT	170 mV
Power bandwidth	10 Hz - 30 kHz (8 ohms, T.H.D. 0.5% 1/2 Rated)	Phono overload level (at 1 kHz)	140 mV
Frequency characteristics TUNER, CD/AUX, TAPE	20 Hz - 30 kHz (± 2 dB)	Signal-to-noise ratio (IHF, A network)	72 dB
PHONO	30 Hz - 15 kHz (RIAA ± 0.5 dB)	PHONO	95 dB
Harmonic distortion (at rated output)	Less than 0.5%	TUNER, CD/AUX, TAPE	20 (1 kHz)
(at 1/2 rated output)	Less than 0.1%	Damping factor	± 8 dB (100 Hz)
Intermodulation distortion (at 1/2 rated output)	Less than 0.2%	Bass control	± 8 dB (10 kHz)
Input sensitivity/ Impedance		Treble control	+7 dB (100 Hz)
PHONO	3.0 mV/47 k-ohms	Loudness control	+4 dB (10 kHz)
TUNER	190 mV/40 k-ohms	Power supply	AC 120 V 60Hz, ~220 V 50/60 Hz, ~240 V 50/60 Hz or ~120 V/220 V/240 V 50/60Hz
TAPE PLAY	190 mV/40 k-ohms	Power consumption	60 W (at 1/10 rated output) 100 W (at 1/3 rated output) 150 W (at rated output)
CD/AUX	190 mV/40 k-ohms	Dimensions	435(W) \times 83(H) \times 230(D) mm
		Weight	4.0 kg

* Measured pursuant to the Federal Trade Commission's Trade Regulation Rule on Power Output Claims for Amplifiers.

NOTE : Multi voltage unit can be operated on ~110 V to 120 V, ~200 V to 220 V or ~230 V to 240 V (When the boltage selector setting is changed).

SICHERHEITSMASSNAHMEN

Bei Wartungsarbeiten sind die folgenden Sicherheitsmaßnahmen zu beachten :

1. Da verschiedene Teile dieses Gerätes Sicherheitsfunktionen aufweisen, nur Original-Hitachi-Ersatzteile verwenden. Kritische Teile im Netzteil sollten nicht durch ähnliche Teile anderer Hersteller ersetzt werden. Alle kritischen Teile sind im Schaltplan und im Diagramm der Schaltplatinen mit dem Symbol Δ gekennzeichnet.
2. Vor der Auslieferung eines reparierten Gerätes an den Kunden muß der Wartungstechniker das Gerät einer gründlichen Prüfung unterziehen, um sicherzustellen, daß sicherer Betrieb ohne die Gefahr von elektrischen Schlägen gewährleistet ist.

TECHNISCHE DATEN

FT-12

Type	Zwei-Wellenbereichs-Stereotuner MW/UKW Drei-Wellenbereichs-Stereotuner MW/LW/UKW	Trennschärfe	50 dB
• UKW-Teil		Übersprechdämpfung	40 dB (1 kHz) [außer die Bundesrepublik Deutschland und Italien]
Empfangsbereich	88 MHz bis 108 MHz	Gleichwellenselektion	1,0 dB
Nutzbare Empfindlichkeit	11,2 dBf (IHF), 1,0 μ V (75 Ohm DIN)	Ausgangsspannung	500 mV (1 kHz, 40 kHz Hub)
50-dB-Geräusch-dämpfung	22,4 dBf (Mono) 39,5 dBf (Stereo)	• MW-Teil	
Spiegelfrequenzdämpfung	45 dB (98 MHz)	Empfangsbereich	530 kHz - 1605 kHz
Klirrfaktor	MONO : 0,3 % (1 kHz) STEREO : 0,4 % (1 kHz)	Empfindlichkeit	40 μ V (DIN) ... S/N 26 dB 20 μ V (IHF) 500 μ V/m (IHF Zimmer antenne)
Rauschabstand	MONO : 75 dB (IHF) 65 dB (Fremdspannung sabstand) 60 dB (Geräuschspannung sabstand) STEREO : 70 dB (IHF) 60 dB (Fremdspannung sabstand) 55 dB (Geräuschspannung sabstand)	Spiegelfrequenz-Dämpfung	38 dB
Übertragungsbereich	50 Hz bis 12 kHz (50 μ s $\pm 2,0$ dB) 50 Hz bis 15 kHz (50 μ s $\pm 1,0$ dB) [für die Bundesrepublik Deutschland und Italien] 50 kHz bis 12 kHz (75 μ s ± 2 dB) [für USA und Kanada]	Trennschärfe	35 dB (± 9 kHz)
		Signal-Geräuschabstand	45 dB
		Ausgangsspannung	165 mV (400 Hz, 30% Modulation)
		• LW-Teil	
		Empfangsbereich	150 - 350 kHz
		Empfindlichkeit	200 μ V (DIN) ... S/N 26 dB
		• Allgemeine Daten	
		Abmessungen	435(B) \times 60(H) \times 236(T) mm
		Gewicht	2,4 kg (5,3 lbs.)

HA-12

Ausgangsleistung	28 Watt/Kanal + 28 Watt/Kanal (beide Kanäle ausgesteuert an 8 Ohm, 40 Hz – 20 kHz, T.H.D., 0,9%)	Ausgangspegel	170 mV
DIN 4/8 Ohm	30 Watt/Kanal + 30 Watt/Kanal (8 Ohm, 1 kHz, T.H.D. 0,7 % IEC)	TAPE REC OUT	170 mV
	30 Watt/Kanal + 30 Watt/Kanal (8 Ohm, 40 Hz – 20 kHz, T.H.D., 0,7 %)	Phonoüberlastungspegel (bei 1 kHz)	140 mV
Leistungsbandbreite	10 Hz – 30 kHz (an 8 Ohm, Klirrgrad 0,5 %, halbe Nennleistung)	Geräuschspannungsabstand (IHF, A-Nets)	72 dB
Frequenzcharakteristik TUNER, CD/AUX, TAPE	20 Hz – 30 kHz (± 2 dB)	PHONO	95 dB
PHONO	30 Hz – 15 kHz (RIAA-Kennlinie $\pm 0,5$ dB)	TUNER, CD/AUX, TAPE	95 dB
Klirrfaktor (bei Nennleistung)	Kleiner als 0,5 %	Dämpfungsfaktor	20 (1 kHz)
(bei halber Nennleistung)	Kleiner als 0,1 %	Tiefeneinstellung	± 8 dB (100 Hz)
Intermodulations-Verzerrung (bei halber Nennleistung)	Kleiner als 0,2 %	Höheneinstellung	± 8 dB (10 kHz)
Eingangsempfindlichkeit/ Impedanz		Gehörrichtige Lautstärkekorrektur	+7 dB (100 Hz) +4 dB (10 kHz)
PHONO	3,0 mV/47 k-Ohm	Netzspannung	Wechselstrom 120 V 60 Hz, ~220 V 50/60 Hz, ~240 V 50/60 Hz oder ~120 V/220 V/240 V 50/60 Hz
TUNER	190 mV/40 k-Ohm	Leistungsafnahme	60 W (bei 1/10 Nennleistung) 100 W (bei 1/3 Nennleistung) 150 W (bei Nennleistung)
TAPE PLAY	190 mV/40 k-Ohm	Abmessungen	435(B) \times 83(H) \times 230(T) mm
CD/AUX	190 mV/40 k-Ohm	Gewicht	4,0 kg

Anderungen der Konstruktion und technischen Daten bleiben im Sinne der ständigen Verbesserung vorbehalten.

HINWEIS : Das Gerät ist zum Betrieb mit verschiedenen Spannungen ausgelegt und kann mit ~100 V bis 120 V, ~200 V bis 220 V oder ~230 V bis 240 V betrieben werden (wenn die Einstellung des Spannungswählers entsprechend verändert wird).

PRÉCAUTIONS DE SÉCURITÉ

Les précautions suivantes doivent être observées chaque fois qu'une réparation doit être faite.

1. Etant donné que de nombreux composants de l'appareil possèdent des caractéristiques relatives à la sécurité, utiliser uniquement des pièces de rechange d'origine Hitachi pour effectuer un remplacement. Ceci se rapporte notamment aux pièces critiques du bloc d'alimentation qui ne doivent en aucun cas être remplacées par celles d'autres fabricants. Les pièces critiques sont accompagnés du symbole Δ dans le schéma de montage et sur le schéma de plaque de câblage.
2. Avant de retourner l'appareil réparé au client le technicien doit procéder à un essai complet pour s'assurer qu'il ne présente aucun danger de chocs électriques.

CARACTÉRISTIQUES TECHNIQUES

FT-12

Circuit	Tuner stéréo 2 gammes AM/FM Tuner stéréo 3 gammes PO/GO/FM	Sélectivité	50 dB
SECTION FM		Séparation stéréo	40 dB (1 kHz) [sauf pour l'Allemagne de l'Ouest et Italie]
Plage de fréquence	88 – 108 MHz	Taux de capture	1,0 dB
Sensibilité utilisable	11,2 dBf (IHF), 1,0 μ V (75 ohms DIN)	Tension de sortie	500 mV (1 kHz, 40 kHz déviation)
Sensibilité pour recul du bruit de fond de 50 dB	22,4 dBf (MONO) 39,5 dBf (STÉRÉO)	SECTION PO (MW)	
Taux d'interférence image	45 dB (98 MHz)	Plage de fréquence	530 – 1605 kHz
Distorsion harmonique totale	MONO : 0,3 % (1 kHz) STEREO : 0,4 % (1 kHz)	Sensibilité	40 μ V (DIN) ... S/N 26 dB 20 μ V (IHF) 500 μ V/m (IHF antenna-cadre)
Rapport signal/bruit	MONO : 75 dB (IHF) 65 dB (IEC, non pondéré, crête Q) 60 dB (IEC, pondéré, crête Q) STEREO : 70 dB (IHF) 60 dB (IEC, non pondéré, crête Q) 55 dB (IEC, Pondéré, crête Q)	Taux d'interférence image	38 dB
Réponse de fréquence	50 Hz – 12 kHz (50 μ s $\pm 2,0$ dB) 50 Hz – 15 kHz (50 μ s $\pm 1,0$ dB) [pour l'Allemagne de l'Ouest et Italie] 50 kHz – 12 kHz (75 μ s ± 2 dB) [pour les Etats-Unis et le Canada]	Sélectivité	35 dB (± 9 kHz)
		Rapport signal/bruit	45 dB
		Tension de sortie	165 mV (400 Hz, 30 % modulation)
		SECTION GO (LW)	
		Plage de fréquence	150 – 350 kHz
		Sensibilité	200 μ V (DIN) ... S/N 26 dB
		DONNESS GENERALES	
		Dimentions	435(L) \times 60(H) \times 236(P) mm
		Poids	2,4 kg (5,3 lbs.)

HA-12

Puissance de sortie	28 W/can.+28 W/can. (deux canaux en fonction sous 8 ohms, 40 Hz – 20 kHz, D.H.T. 0,9%) 30 W/can. + 30 W/can. (8 ohms, 1 kHz, D.H.T. 0,7% IEC). 30 W/can. + 30 W/can. (8 ohms, 40 Hz – 20 kHz, D.H.T. 0,7%)	Niveau de sortie	160 mV
Bande passante	10 Hz – 30 kHz (8 ohms, D.H.T. 0,5% 1/2 de la puissance nominale)	TAPE REC OUT	140 mV
Caractéristiques de fréquence		Niveau de surcharge phono (à 1 kHz)	140 mV
TUNER, CD/AUX, TAPE	20 Hz – 30 kHz (±2 dB)	Rapport signal/bruit (IHF, réseau A)	72 dB
PHONO	30 Hz – 15 kHz (RIAA ±0,5 dB)	PHONO	95 dB
Distorsion harmonique (à la puissance nominale)	Inférieure à 0,5%	TUNER, CD/AUX, TAPE	20 (1 kHz)
(à la moitié de la puissance nominale)	Inférieure à 0,1%	Facteur d'amortissement	±8 dB (100 Hz)
Distorsion d'intermodulation (à la moitié de la puissance nominale)	Inférieure à 0,2%	Réglage de graves	±8 dB (10 kHz)
Sensibilité d'entrée/ Impédance		Réglage des aigues	+7 dB (100 Hz)
PHONO	3,0 mV/47 k-ohms	Correction physiologique	+4 dB (10 kHz)
TUNER	190 mV/40 k-ohms	Alimentation	CA 120 V 60 Hz, ~220 V 50/60 Hz, ~240 V 50/60 Hz ou ~120 V/220 V/240 V 50/60 Hz
TAPE PLAY	190 mV/40 k-ohms	Consommation	60 W (à 1/10 de la puissance nominale) 100 W (à 1/3 de la puissance nominale) 150 W (à la puissance nominale)
CD/AUX	190 mV/40 k-ohms	Dimensions Poids	435(L) × 83(H) × 230(P) mm 4,0 kg

Les caractéristiques techniques et la présentation peuvent être modifiées sans préavis pour des raisons d'amélioration.

REMARQUE : Une unité acceptant diverses tensions peut être alimentée sur ~110 V – 120 V, ~200 V – 220 V ou ~230 V – 240 V, moyennant un réglage du sélecteur de tension.

DIAL CORD SETTING • SKALENSEILEINSTELLUNG • EQUIPEMENT DE CADRAN FT-12

Specification :

After setting the dial cord, make the pointer go and return three times within the pointer stroke (the variable capacitor opens and closes three times). When the cord tension is thus equalized, make adjustment so that the tip (a) of the trigger spring matches with the point (b) shown on the pulley. Set the zero point of the pointer in this status.

Spezifikation :

Bewegen Sie den Zeiger nach dem Einstellen der Skalenantriebsschnur 3 mal über den gesamten Bewegungsbereich hin und her (der Drehkondensator wird 3 mal geöffnet und geschlossen). Wenn die Schnurspannung auf diese Weise ausgeglichen worden ist, so führen Sie Einstellung so durch, daß die Spitze (a) der Auslösefeder mit dem auf der Schnurscheibe gezeigten Punkt (b) übereinstimmt. Setzen Sie den Nullpunkt des Zeigers in diesem Zustand ein.

Spécifications :

Après l'installation de la corde à cadran, faire va-et-vient de l'aiguille trois fois dans la course de l'aiguille (le condensateur variable s'ouvre et se ferme trois fois). Lorsque la tension de la corde est ainsi égalisée, régler de sorte que le bout (a) du ressort de détente corresponde au point (b) indiqué sur la poulie. Régler le point zéro de l'aiguille à cet état.

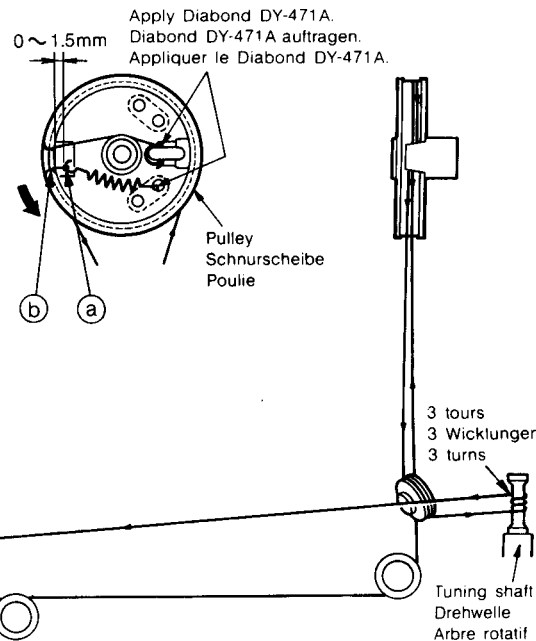

Position of 0 point :

The 0 point is located on the 0.15 mm thick line, which is the second line to the right of the letters FM and AM.

Position des Nullpunkts

Der Nullpunkt befindet sich auf der 0,15 mm dicken Linie, die die zweite Linie rechts von den Buchstaben FM und AM ist.

Position du point 0

La position du point 0 se trouve sur la ligne de 0,15 mm de large, qui est la deuxième à compter des lettres FM et AM.

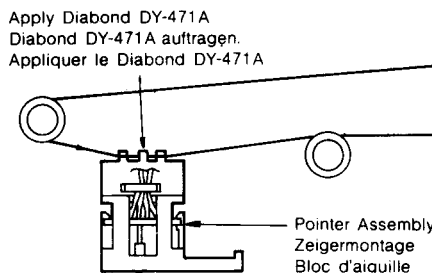
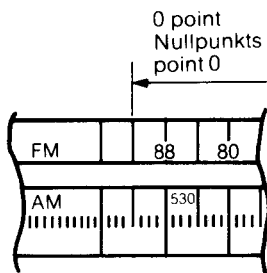

DISASSEMBLY AND REPLACEMENT • ZERLEGUNG UND AUSTAUSCH • DEMONTAGE ET REMONTAGE

FT-12

1. The cover can be detached by removing the screw ①.
2. The P.W.B. can be detached by removing the screws ② and ③.

1. Die Abdeckung kann nach Entfernen der Schraube ① entfernt werden.
2. Die gedruckte Schaltplatte kann nach Entfernen der Schrauben ② und ③ entfernt werden.

1. Le couvercle peut être détaché en enlevant la vis ①.
2. Le socle peut être détaché en enlevant les vis ② et ③.

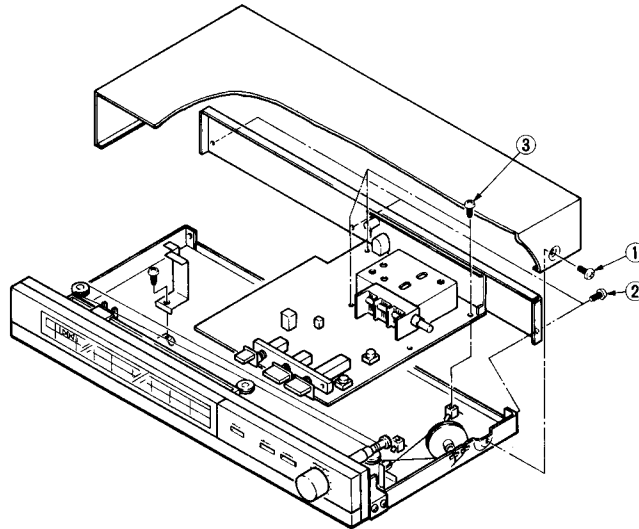

HA-12

1. By loosening the screw ①, the cover can be removed.
2. Loosen the screws ② through ⑥, raise the rear plate slightly and slightly pull the front panel forward.
3. The board can be set upright with the rear plate and front panel kept mounted.
4. By loosening the screw ⑤ through ⑦, in the front panel can be removed.

1. Wenn die Schraube ① entfernt wird, kann die abdeckung entfernt werden.
2. Entfernen Sie die Schrauben ② bis ⑥, heben Sie das hintere Blech etwas an, und ziehen Sie die Frontplatte etwas nach vorne heraus.
3. Die Grundplatte kann aufgestellt werden, während hinteres Blech und Frontplatte angebracht sind.
4. Wenn die Schraube ⑤ bis ⑦, entfernt wird, kann die Frontplatte entfernt werden.

1. En desserrant la vis ①, on peut enlever le couvercle.
2. Desserrer les vis ② à ⑥, lever un peu la plaque arrière et extraire légèrement en avant le tableau avant.
3. On peut redresser la plaquette la plaque arrière et le tableau avant maintenus associés.
4. En desserrant la vis ⑤ à ⑦, on peut enlever le tableau avant.

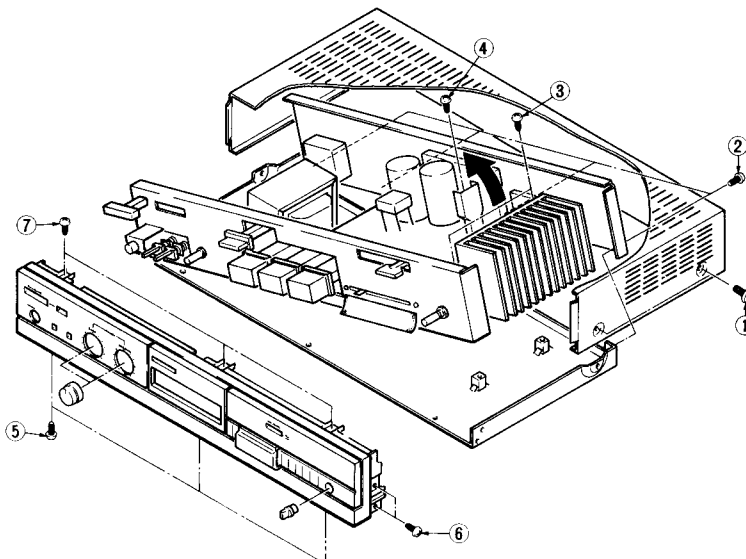

BLOCK DIAGRAM • BLOCK SCHEMA • SCHEMA

FT-12

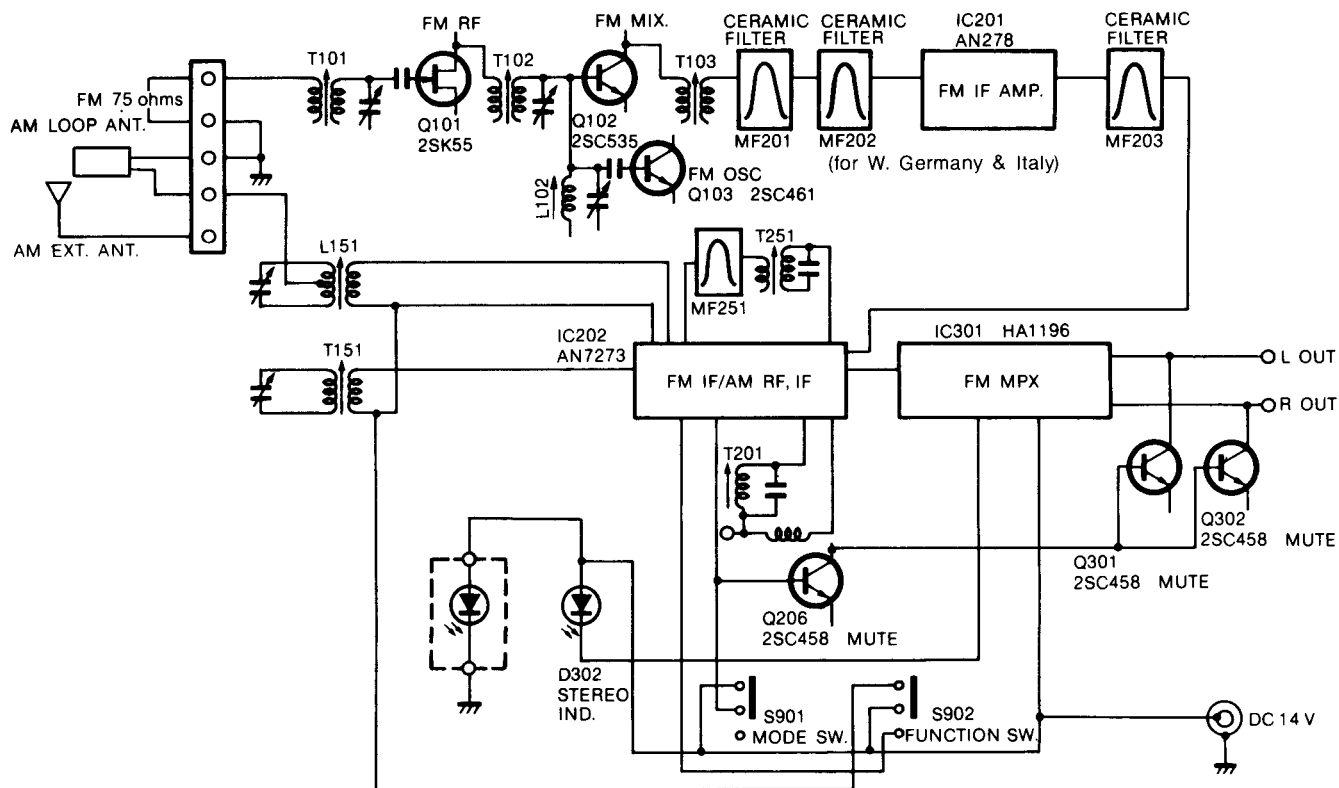

HA-12

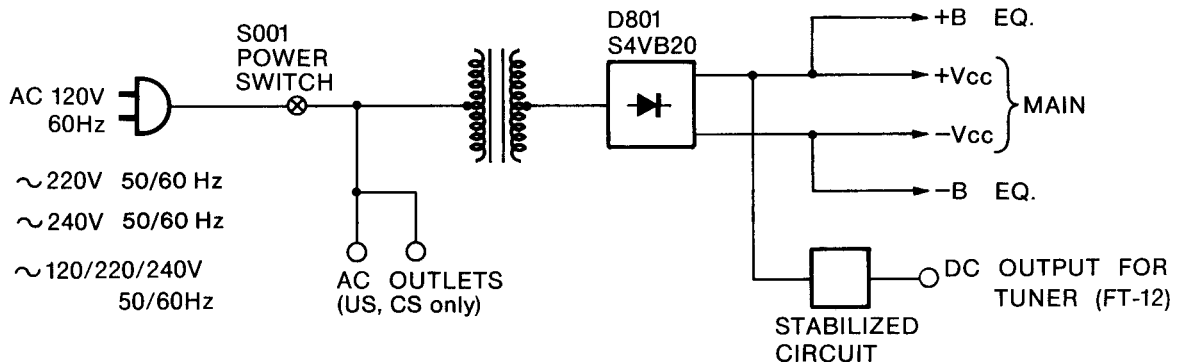
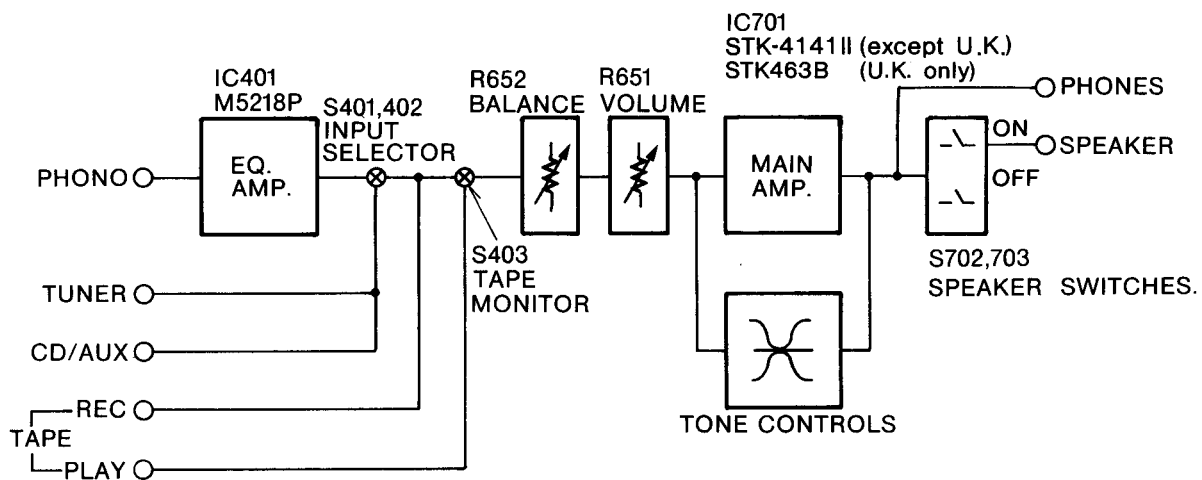

GENERAL ALIGNMENT INSTRUCTION • ALLGEMEINE AUSRICHTANLEITUNG • INSTRUCTIONS GENERALES

FT-12

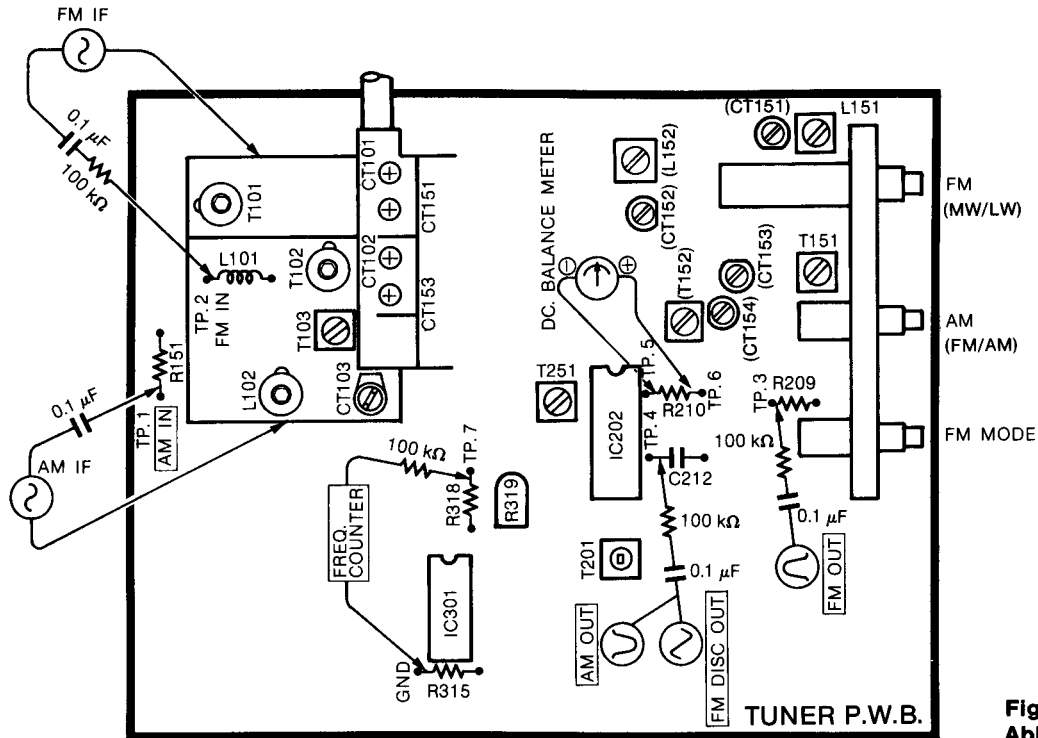







Fig. 1
Abb. 1



FM TUNER ALIGNMENT • ABGLEICH DES UKW-TUNERS • REGLAGE DE TUNER FM

- 
 Sweep Generator
 Wobbelgenerator
 Générateur de balayage
- 
 Signal Generator
 Oszillator
 Générateur de signaux
- 
 Oscilloscope
 Oszilloskop
 Oscilloscope
- 
 VTVM
 Vakuumröhrevoltmeter
 Voltmètre électronique
- 
 Frequency Counter
 Frequenzzähler
 Fréquencecètre
- 
 Dist.
 Distortion Meter
 Verzerrungsmesser
 Indicateur de distorsion

Condition Function : FM
 FM Muting : OFF
 Modulation : 1000 Hz, 53.3%
 (Unless otherwise notified)

Bedingung Funktion : FM (UKW)
 FM (UKW) Muting : OFF
 Modulation : 1000 Hz, 53,3 %
 (Falls nicht anders angegeben)

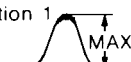
Condition Function : FM
 Sourdine FM : OFF
 Modulation : 1000 Hz, 53,3 %
 (Sauf indication contraire)

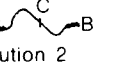
Sequence Reihenfolge Séquence	Connection Anschluß Connexion		Setting Einstellung Montage		Adjust for Einstellen für Réglage pour	
	Input Eingang Entrée	Output Ausgang Sortie	Tuning Abstimmung Indicateur d'accord	Signal	Adjust Einstellen Réglage	Indication Anzeige Indication
1	IF Amp. ZF-Verstärker- Amplificateur de fréquence intermédiaire	TP. 3 0.1 μ 100 k		10.7 MHz	T103	Caution 1 Vorsicht 1 Attention 1 
2	"S" curve S-Kurve Courbe S	TP. 4 0.1 μ 100 k		10.7 MHz	T201	Straight line Gerade Linie Ligne droite  Caution 2 Vorsicht 2 Attention 2

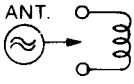
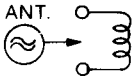
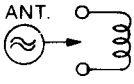
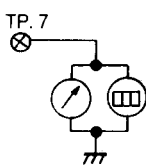
3	Covering Abgleich Poursuite	ANT. Terminal (75 ohms) Antennen-Anschluß Borne d'antenne		f min.	87.4 MHz	L102	V max.		
				f max.	108.35MHz	CT103			
4	Tracking Vorstufe Alignement'	ANT. Terminal (75 ohms) Antennen-Anschluß Borne d'antenne		90 MHz	90 MHz	T101, T102	V max.		
				106 MHz	106 MHz	CT101, CT102			
5	76 kHz	ANT. Terminal (75 ohms) Antennen-Anschluß Borne d'antenne		60 dB input 60 dB Eingang Entrée 60 dB Non-modulated Nicht moduliert Non modulé		98 MHz	98 MHz	R319	Fre. 76 kHz±120 Hz Frequenz 76 kHz±120 Hz Fréquence 76 kHz±120 Hz

CAUTION

- Short-circuit the OSC stage by earthing the live side of the variable capacitor in that stage. Adjust the core of T103 so that the gain will be max. In this case, reduce the level of the input signal of signal generator so that the wave from will be the same as the one shown in the figure.
- Short-circuit the OSC stage as described in Caution 1. Adjust the core of T201 so that the output is like the S curve shown in illustration of this table with A and B symmetrical with respect to C.

VORSICHT

- Die Oszillator-Stufe kurzschließen, indem die spannungsführende Seite des Regelkondensators dieser Stufe an Masse gelegt wird. Den Kern von T103 so einstellen, daß maximaler Gewinn erzielt wird. In diesem Fall ist der Eingangssignalpegel des Signalgenerators zu reduzieren, damit die in der Abbildung gezeigte Wellenform erhalten wird.
- Die in Punkt 1 beschriebene Oszillator-Stufe kurzschließen. Den Kern von T201 einstellen, daß ein der in der Tabelle gezeigten S-Kurve ähnlicher Ausgang erhalten wird, wobei A und B gegenüber C symmetrisch sein müssen.

ATTENTION

- Court-circuiter l'étage OSC en raccordant le pôle sous tension à l'aide d'un condensateur variable au sein de l'étage. Ajuster le noyau de T103 de telle sorte que le gain soit optimum. Dans ce cas, réduire le niveau du signal d'entrée du générateur de signaux de telle sorte que la forme d'onde soit identique à celle indiquée sur l'illustration.
- Court-circuiter l'étage OSC comme décrit dans le paragraphe Précaution 1. Ajuster le noyau de T201 de telle sorte que la section droite de la courbe en S indiquée sur l'illustration de la table A et B soit symétrique par rapport à C.

AM TUNER ALIGNMENT • ABGLEICH DES AM-TUNERS • REGLAGE DE TUNER AM

Condition Function : AM
Modulation : 400 Hz, 30 %

Bedingung Funktion : AM
Modulation : 400 Hz, 30 %

Condition Fonction : AM
Modulation : 400 Hz, 30 %

Sequence Reihenfolge Séquence	Connection Anschluß Connexion		Setting Einstellung Montage		Adjust for Einstellen für Réglage pour		FT-12	
	Input Eingang Entrée	Output Ausgang Sortie	Tuning Abstimmung Indicateur d'accord	Signal	Adjust Einstellen Réglage	Indication Anzeige Indication	AM Function AM Funktion Fonction AM	
1	IF Amp. ZF Verstärker Amplificateur de fréquence intermédiaire			450 kHz	T251	 Caution 1 Vorsicht 1 Attention 1	MW MW PO	
2	Covering Abgleich Poursuite	 Loop antenna Rahmenantenne Antenne en cadre		515 kHz	515 kHz	T151	V max Caution 2 Vorsicht 2 Attention 2	MW MW PO
				1650 kHz	1650 kHz	CT153 (CT153)		Repeat 2 (MW) Wiederholung 2 (MW) Répétition 2 (PO)
				145 kHz	145 kHz	T152	V max Caution 2 Vorsicht 2 Attention 2	LW LW GO
				355 kHz	355 kHz	(CT154)		Repeat 2 (LW) Wiederholung 2 (LW) Répétition 2 (GO)
3	Tracking Vorstufe Alignement	 Loop antenna Rahmenantenne Antenne en cadre		600 kHz	600 kHz	L151	V max Caution 2 Vorsicht 2 Attention 2	MW MW PO
				1400 kHz	1400 kHz	CT151 (CT151)		Repeat 3 (MW) Wiederholung 3 (MW) Répétition 3 (PO)
				175 kHz	175 kHz	L152	V max Caution 2 Vorsicht 2 Attention 2	LW LW GO
				300 kHz	300 kHz	(CT152)		Repeat 3 (LW) Wiederholung 3 (LW) Répétition 3 (GO)

() : LW

CAUTION

- In step 1, set the capacitance of the variable capacitor to minimum and adjust red and blue cores of T251 so that the wave form is as shown in Fig.2. As T251 contains a 450 kHz ceramic filter, sometimes the center of the marker will not correspond to that of the wave form.
- Set the input level to 74 dB in coarse adjustment. Reduce the input level to minimum (55 dB) as adjustment proceeds.

VORSICHT

- In Schritt 1 ist die Kapazität des Regelkondensators auf ein Minimum einzustellen; die roten und blauen Kerne von T251 so einjustieren, daß die in Abb.2 gezeigte Wellenform erhalten wird. Da T251 auch ein 450-kHz-Keramikfilter enthält, kann es vorkommen, das manchmal die Mitte der Anzeige nicht mit der Wellenamplitude übereinstimmt.
- Eine Grobeinstellung auf einen Eingangspegel von 74 dB vornehmen. Im Verlauf der Einstellungen den Eingangspegel auf ein Minimum (55 dB) absenken.

ATTENTION

- Dans le point 1. régler la capacitance du condensateur variable sur la position minimum et ajuster les noyaux rouge et bleu de T251 pour que la forme d'onde soit identique a celle indiquée sur l'illustration (Fig.2). Etant donné que T251 contient un filtre céramique de 450 kHz, il peut arriver que le centre de l'indicateur ne corresponde pas à la forme d'onde.
- Ajuster le niveau d'entrée sur 74 dB en procédant à un réglage approximatif. Réduire le niveau d'entrée à son minimum (55 dB) au fur et à mesure que le réglage est fait.

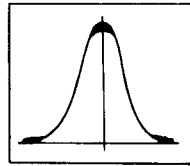
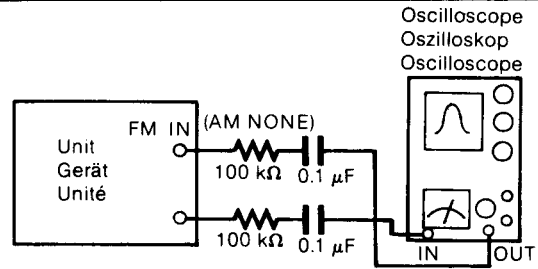

Fig. 2
Abb. 2

Fig. 3 FM IF Discriminator and AM IF alignments (AM and FM Step. 1)

Abb. 3 UKW-ZF-Diskriminator und AM-ZF-Abgleich (AM: Schritt 1, UKW: Schritt 1)

Fig. 3 Réglages de discriminateur FM IF et AM IF (Operations IFM et IAM)



AM Signal generator
AM Signalgenerator
Générateur de signal AM

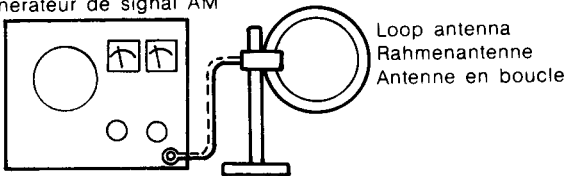

AC Voltmeter
Wechselspannungsmesser
Voltmètre à courant alternatif
Oscilloscope
Oszilloskop
Oscilloscope

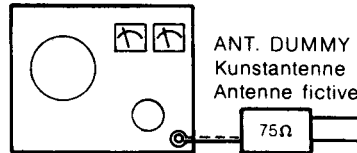

Fig. 4 AM frequency covering and tracking alignments (Step. 2 and 3)

Abb. 4 AM-Bereich- und Nachführungsabgleich (Schritte 2 und 3)

Fig. 4 Réglages de poursuite et d'étendue de fréquence AM (Operations 2 et 3)

FM Signal generator
UKW Signalgenerator
Générateur de signal FM



ANT. TERMINAL
Antennenanschluß
Borne d'antenne
AC Voltmeter
Wechselspannungsmesser
Voltmètre à courant alternatif
Oscilloscope
Oszilloskop
Oscilloscope

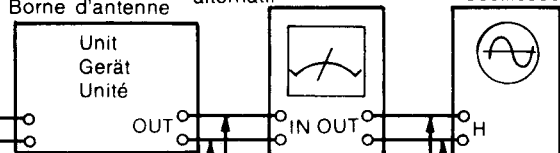

Fig. 5 FM frequency covering, tracking and other alignments (Step. 3 to 5)

Abb. 5 UKW-Bereich-, -Nachführungs- und andere Abgleiche (Schritte 2 bis 5)

Fig. 5 Réglages de poursuite, d'étendue de fréquence FM et autres (Opérations 2 à 5)

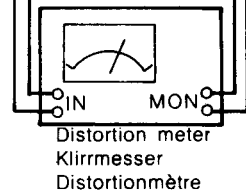
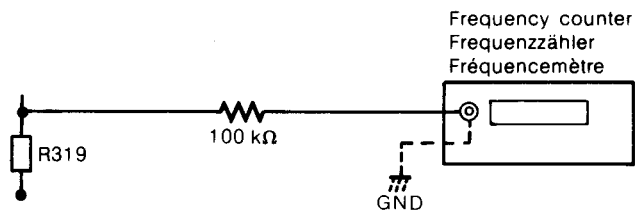

Fig. 6 FM MPX 76 kHz adjustment (Step. 6)

Abb. 6 UKW-Dekoder 76-kHz-Abgleich (Schritt 6)

Fig. 6 Réglage de 76 kHz MPX FM (Opération 6)



PRINTED WIRING BOARD • PRINTPLATTEN • PLAN DE BASE

FT-12 [ : Earth,  : Other]

* : Axial
 * : Zylind.
 * : Cond.

TUNER

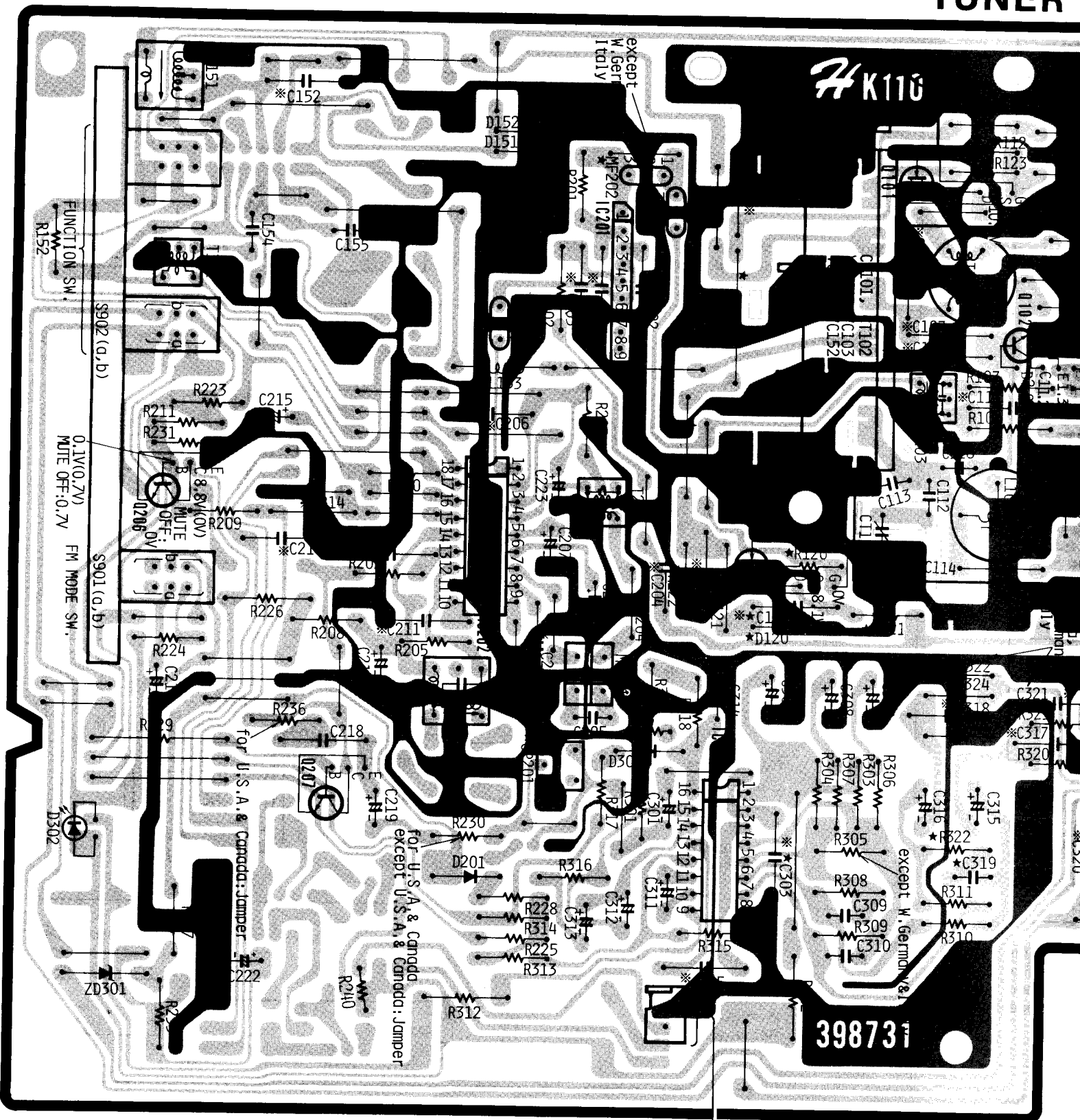

except U.K., Switzerland & France

Q207
E 1.9V(1.4V)
C 1.9V(1.7V)
B 2.6V(0V)

★ : for W. Germany & Italy
 () : AM position

- * : Axial lead cylindrical ceramic capacitor
- * : Zylindrischer Keramik Kondensator mit axialer Zuleitung
- * : Condensateur céramique cylindrique à conducteur axial

TUNER P.W.B. except U.S.A. & Canada

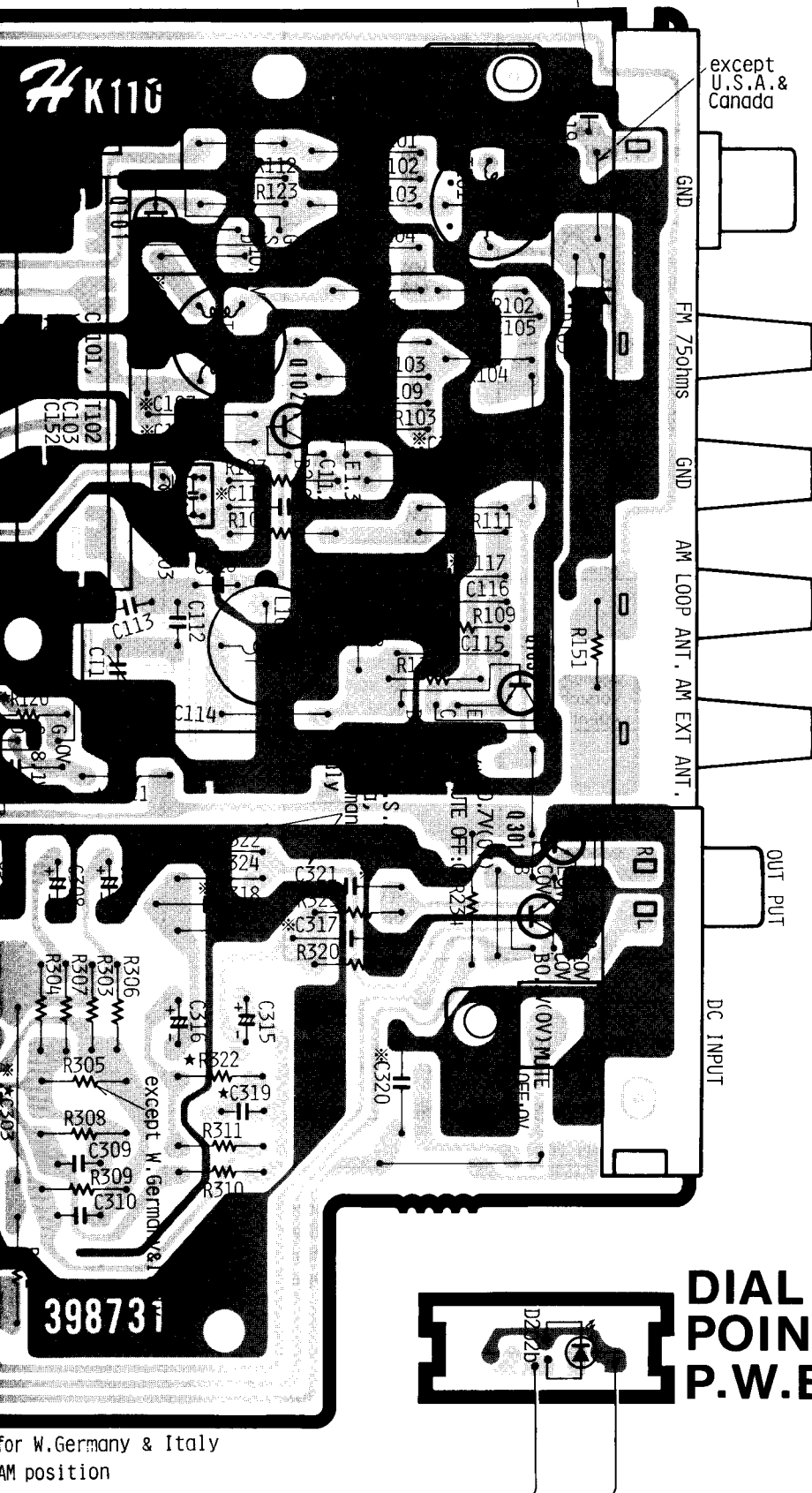

IC201

1	2.2V	6	2.4V
2	2.2V	7	0V
3	2.3V	8	1.6V
4	2.4V	9	2.3V
5	4.1V		

IC202

1	7.5V(9.9V)	7	7.5V(9.9V)	13	1.9V(1.7V)
2	0.6V(8.6V)	8	7.5V(9.9V)	14	7.9V(10.5V)
3	0.6V(8.6V)	9	7.4V(9.9V)	15	0V(0.18V)MUTE OFF:0.18V
4	0.6V(8.5V)	10	7.1V(9.6V)	16	1.5V(1.5V)
5	0V(1.0V)	11	0V	17	1.5V(1.5V)
6	0.3V(0.8V)	12	7.8V(10.5V)	18	0.6V(8.6V)

IC301

1	13.3V	7	7.4V	13	2.3V
2	3.1V	8	0V	14	2.4V
3	7.8V	9	12.4V	15	2.4V
4	10.7V	10	0V	16	3.2V(6.8V)
5	10.7V	11	2.4V		
6	7.3V	12	0.7V		

for W.Germany & Italy
AM position

CIRCUIT DIAGRAM · SCHALTPLAN · PLAN DE CIRCUIT

FT-12

CAUTION

Use the electrolytic capacitors with extreme care when the diameter of them is more than 5mm.

except U.K., Switzerland & France

* : for W. Germany & Italy
() : AM position

W. Germany & Italy: 82K
Others : 100K

TUNER P.W.B.

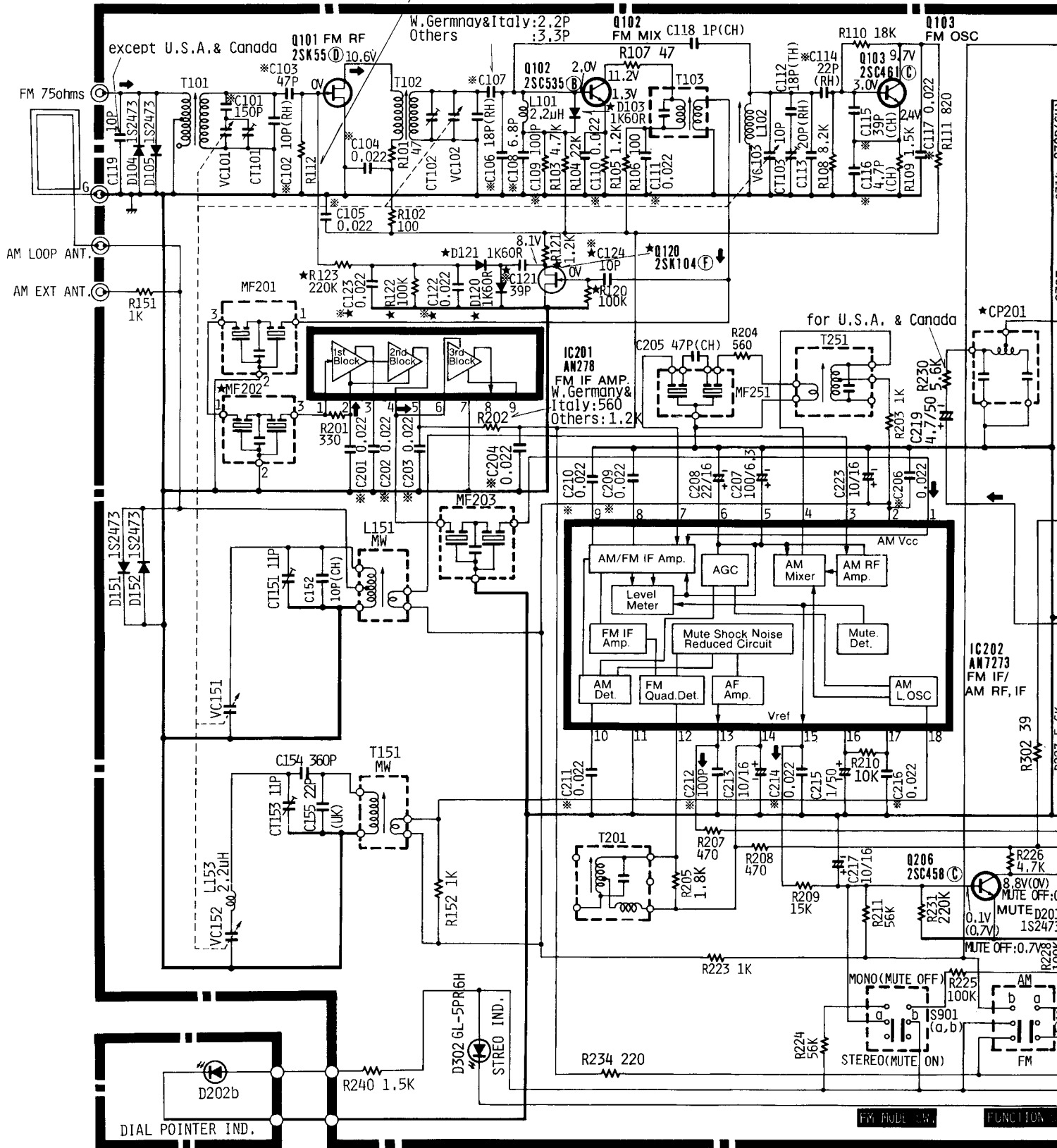

DIAL POINTER P.W.B.

CAUTION

Use the electrolytic capacitors with explosion-proof valve when the diameter of them is more than 10mmø.

- * : Axial lead cylindrical ceramic capacitor
- * : Zylindrischer Keramikkondensator mit axialer Zuleitung
- * : Condensateur céramique cylindrique à conducteur axial

TUNER P.W.B.

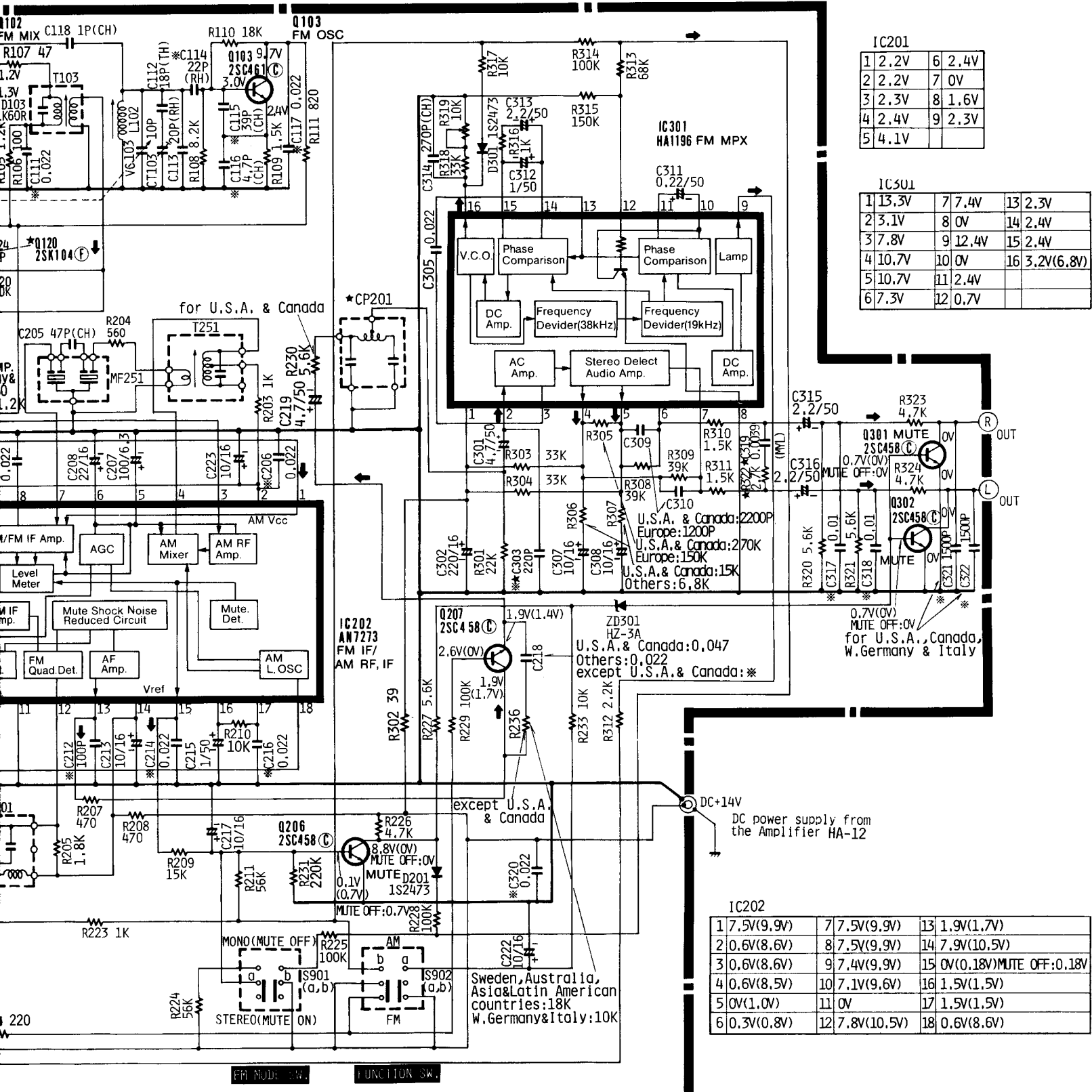

IC201

1	2.2V	6	2.4V
2	2.2V	7	0V
3	2.3V	8	1.6V
4	2.4V	9	2.3V
5	4.1V		

IC501

1	13.3V	7	7.4V	13	2.3V
2	3.1V	8	0V	14	2.4V
3	7.8V	9	12.4V	15	2.4V
4	10.7V	10	0V	16	3.2V(6.8V)
5	10.7V	11	2.4V		
6	7.3V	12	0.7V		

Q301 MUTE 2SC458(C) 0.7V(OV) MUTE OFF:0V
 R323 4.7K
 R324 4.7K
 Q302 2SC458(C) MUTE 0V
 C321 1500P
 C322 1500P
 0.7V(OV) MUTE OFF:0V for U.S.A., Canada, W.Germany & Italy

IC202

1	7.5V(9.9V)	7	7.5V(9.9V)	13	1.9V(1.7V)
2	0.6V(8.6V)	8	7.5V(9.9V)	14	7.9V(10.5V)
3	0.6V(8.6V)	9	7.4V(9.9V)	15	0V(0.18V)MUTE OFF:0.18V
4	0.6V(8.5V)	10	7.1V(9.6V)	16	1.5V(1.5V)
5	0V(1.0V)	11	0V	17	1.5V(1.5V)
6	0.3V(0.8V)	12	7.8V(10.5V)	18	0.6V(8.6V)

PRINTED WIRING BOARD · PRINTPLATTEN · PLAN DE BASE

FT-12 [ : Earth,  : Other]

* : Axial lead
 * : Zylinder
 * : Condensator

TUN

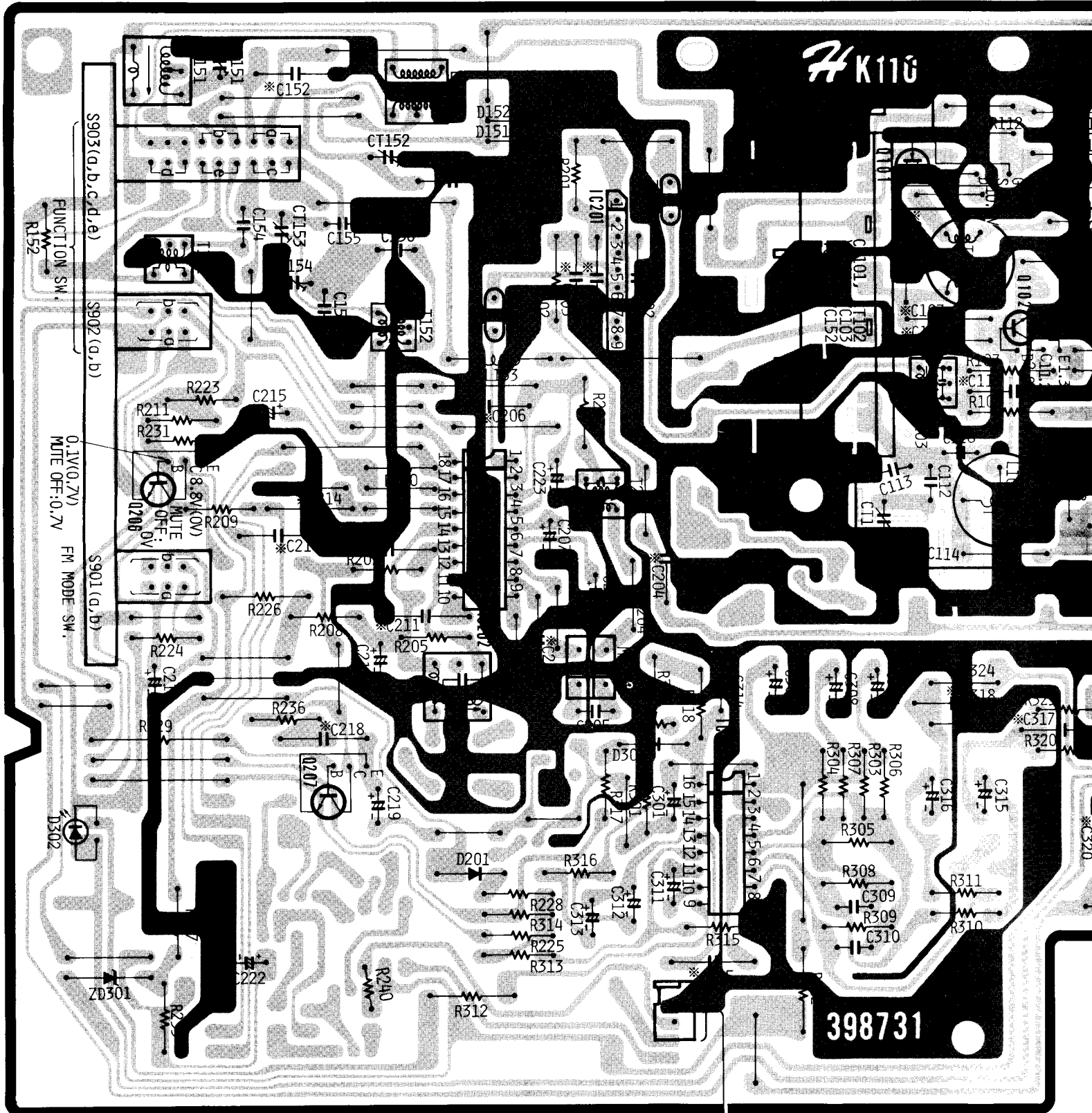

for U.K., Switzerland & France

Q207
E 1.9V(1.4V)
C 1.9V(1.7V)
B 2.6V(0V)

() : AM position

ASE

- * : Axial lead cylindrical ceramic capacitor
- * : Zylindrischer Keramikcondensator mit axialer Zuleitung
- * : Condensateur céramique cylindrique à conducteur axial

TUNER P.W.B.

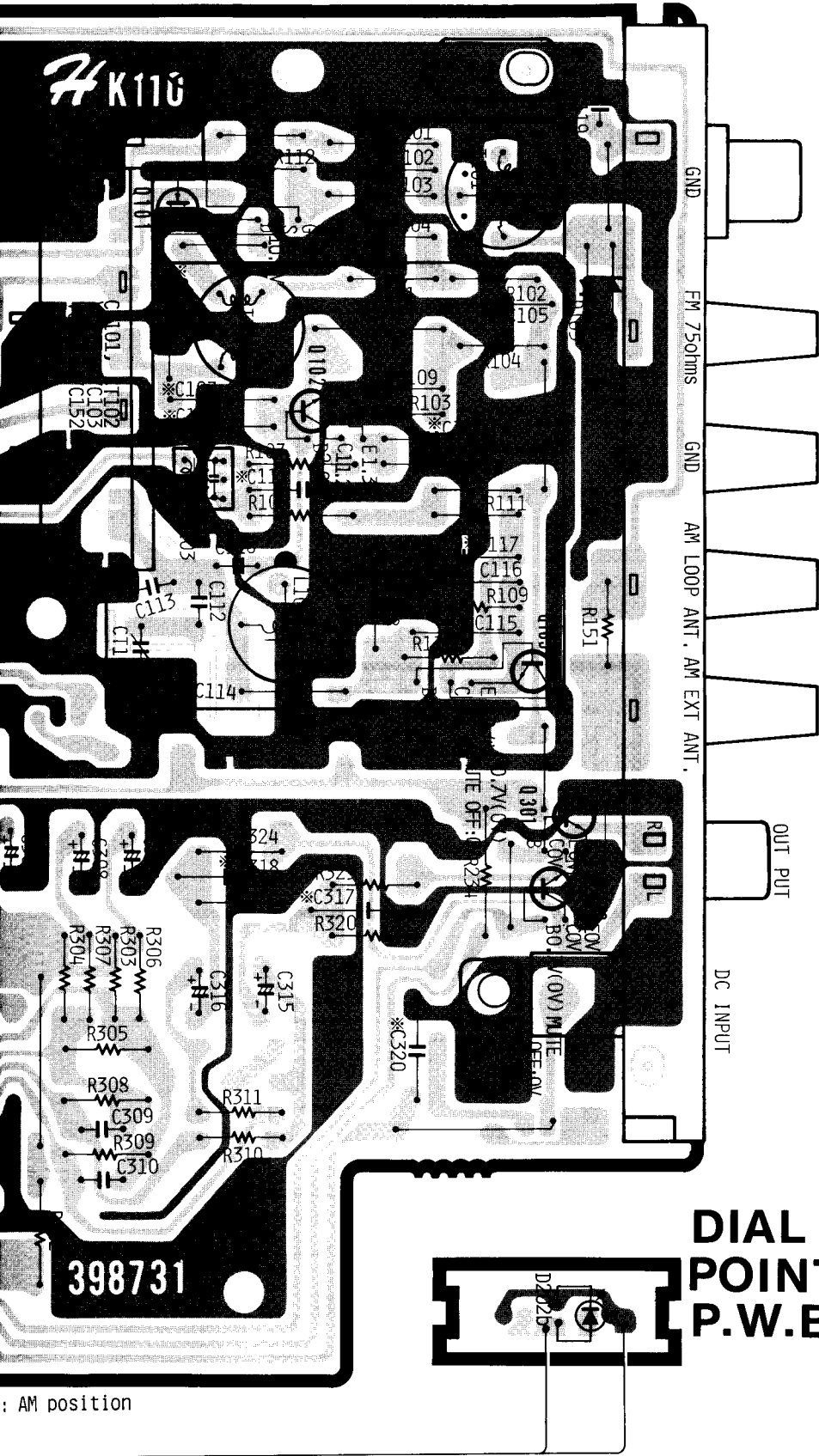

IC201

1	2.2V	6	2.4V
2	2.2V	7	0V
3	2.3V	8	1.6V
4	2.4V	9	2.3V
5	4.1V		

IC202

1	7.5V(9.9V)	7	7.5V(9.9V)	13	1.9V(1.7V)
2	0.6V(8.6V)	8	7.5V(9.9V)	14	7.9V(10.5V)
3	0.6V(8.6V)	9	7.4V(9.9V)	15	0V(0.18V)MUTE OFF:0.18V
4	0.6V(8.5V)	10	7.1V(9.6V)	16	1.5V(1.5V)
5	0V(1.0V)	11	0V	17	1.5V(1.5V)
6	0.3V(0.8V)	12	7.8V(10.5V)	18	0.6V(8.6V)

IC301

1	13.3V	7	7.4V	13	2.3V
2	3.1V	8	0V	14	2.4V
3	7.8V	9	12.4V	15	2.4V
4	10.7V	10	0V	16	3.2V(6.8V)
5	10.7V	11	2.4V		
6	7.3V	12	0.7V		

: AM position

DIAGRAM · SCHALTPLAN · PLAN DE CIRCUIT

CAUTION
Use the electrolytic capacitors with explosion-proof valve when the diameter of them is more than 10mmø.

for U.K., Switzerland & France

TUNER P.W.B.

() : AM position

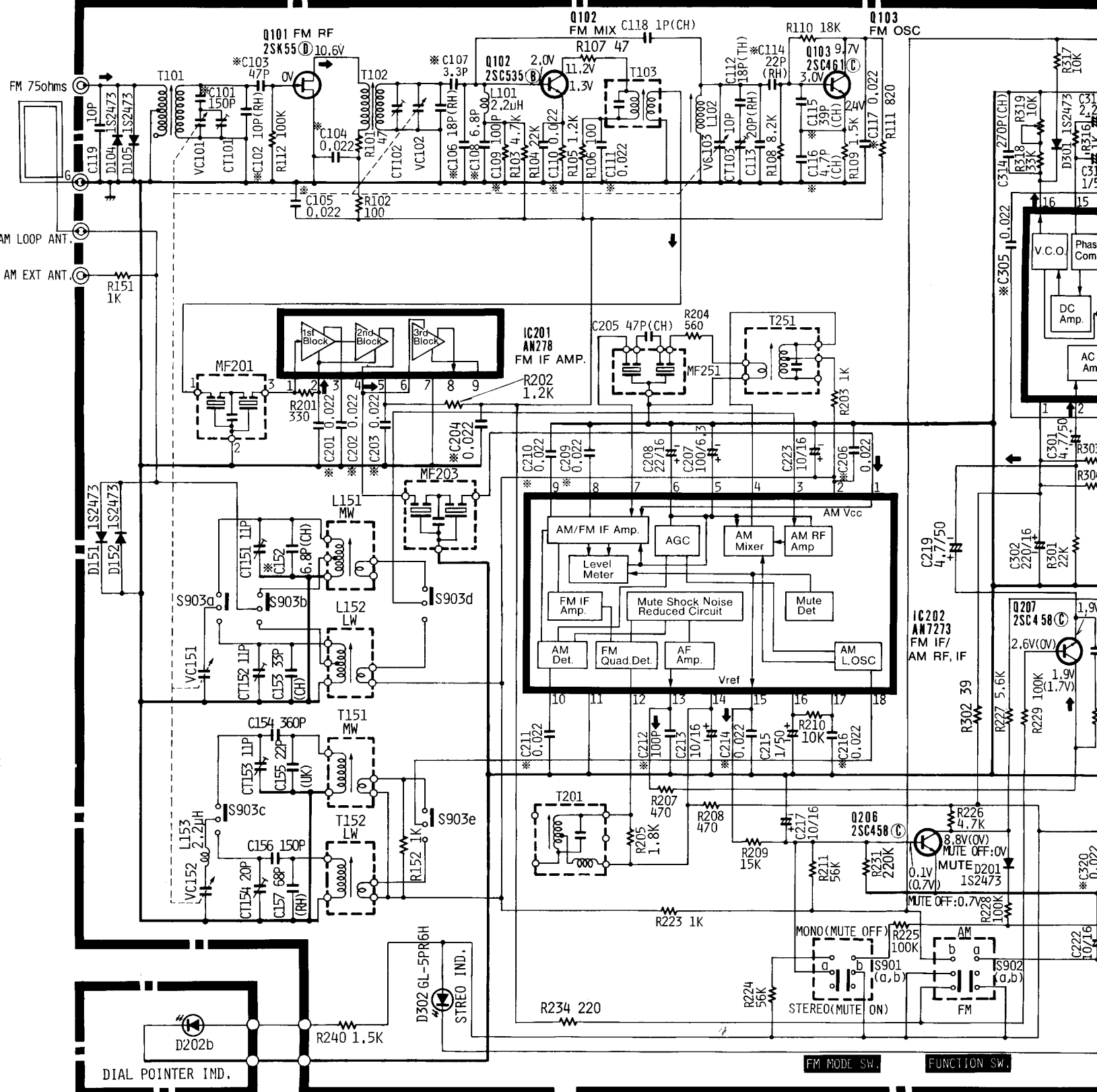

DIAL POINTER P.W.B.

CAUTION

Use the electrolytic capacitors with explosion-proof valve when the diameter of them is more than 10mmø.

- * : Axial lead cylindrical ceramic capacitor
- * : Zylindrischer Keramik Kondensator mit axialer Zuleitung
- * : Condensateur céramique cylindrique à conducteur axial

TUNER P.W.B.

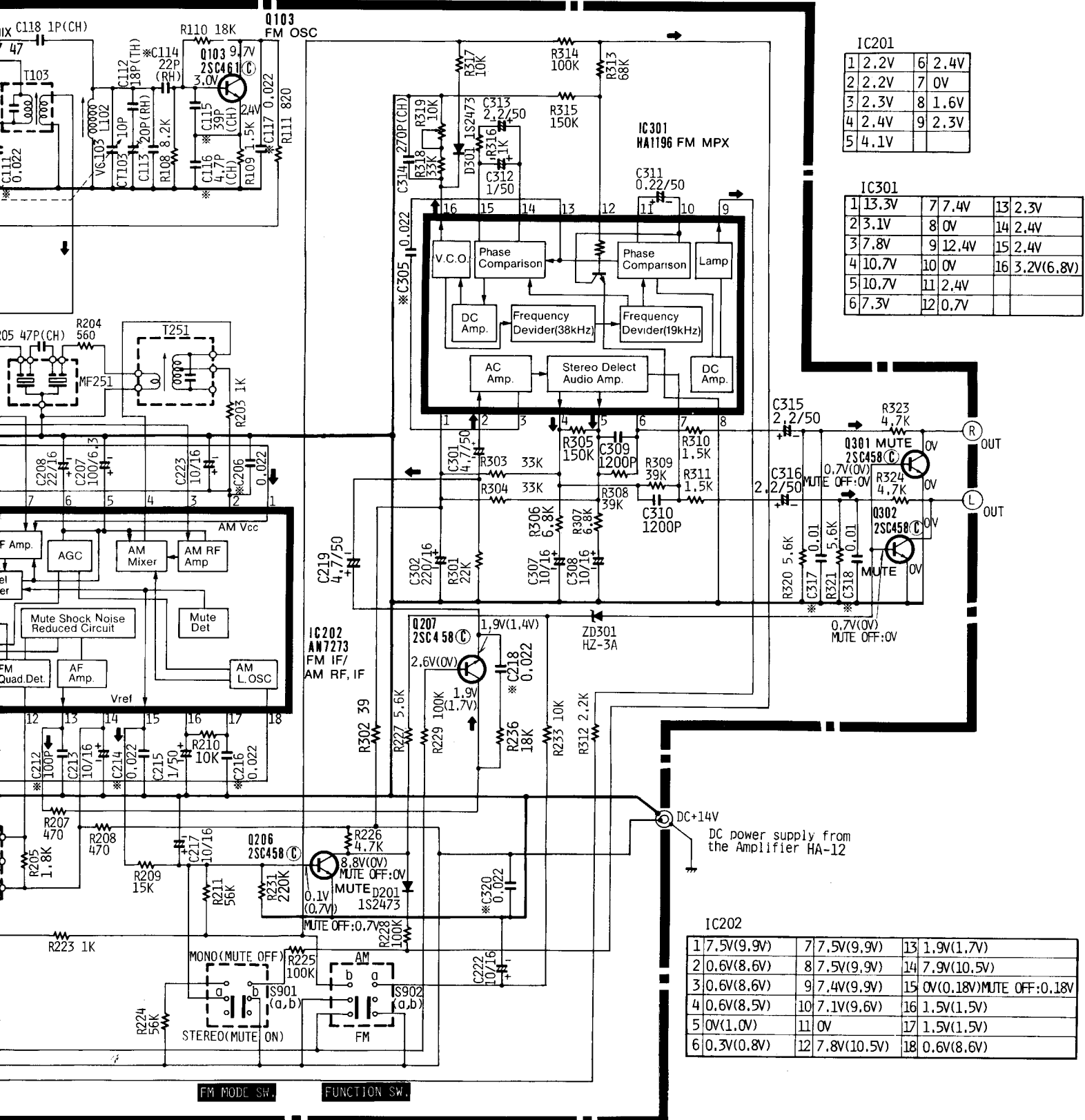

IC201

1	2.2V	6	2.4V
2	2.2V	7	0V
3	2.3V	8	1.6V
4	2.4V	9	2.3V
5	4.1V		

IC301

1	13.3V	7	7.4V	13	2.3V
2	3.1V	8	0V	14	2.4V
3	7.8V	9	12.4V	15	2.4V
4	10.7V	10	0V	16	3.2V(6.8V)
5	10.7V	11	2.4V		
6	7.3V	12	0.7V		

IC202

1	7.5V(9.9V)	7	7.5V(9.9V)	13	1.9V(1.7V)
2	0.6V(8.6V)	8	7.5V(9.9V)	14	7.9V(10.5V)
3	0.6V(8.6V)	9	7.4V(9.9V)	15	0V(0.18V)MUTE OFF:0.18V
4	0.6V(8.5V)	10	7.1V(9.6V)	16	1.5V(1.5V)
5	0V(1.0V)	11	0V	17	1.5V(1.5V)
6	0.3V(0.8V)	12	7.8V(10.5V)	18	0.6V(8.6V)

PRINTED WIRING BOARD · PRINTPLATTEN · PLAN DE BASE

HTA-12

[ :Earth,  :Other]

*: for W.Germany only

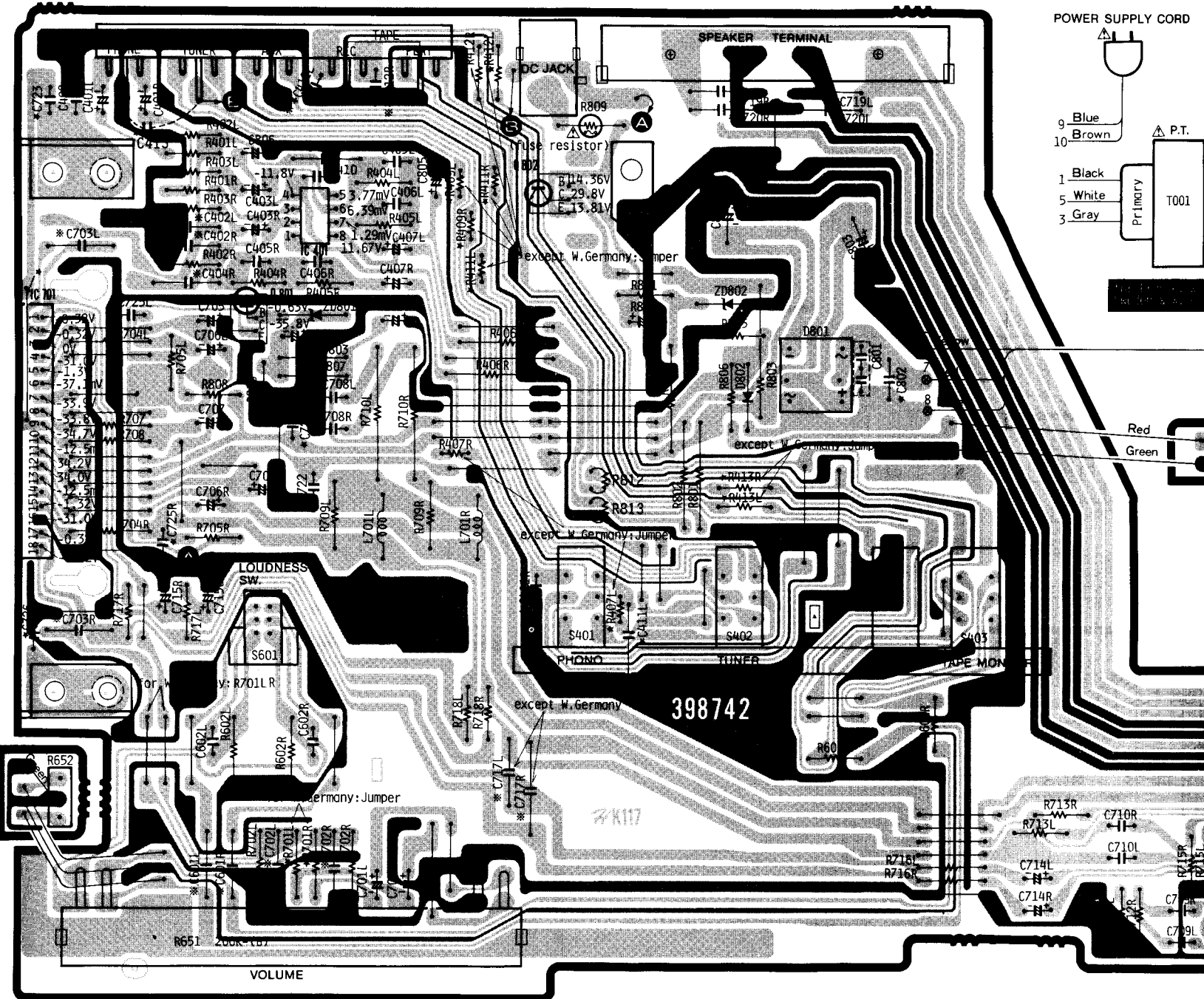

POWER SUPPLY CORD

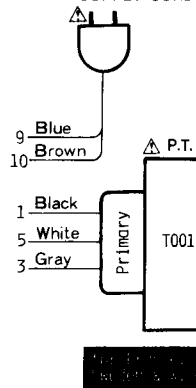

Red
Green

398742

K117

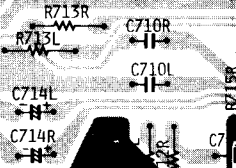

- * : Axial lead cylindrical ceramic capacitor
- * : Zylindrischer Keramik Kondensator mit axialer Zuleitung
- * : Condensateur céramique cylindrique à conducteur axial

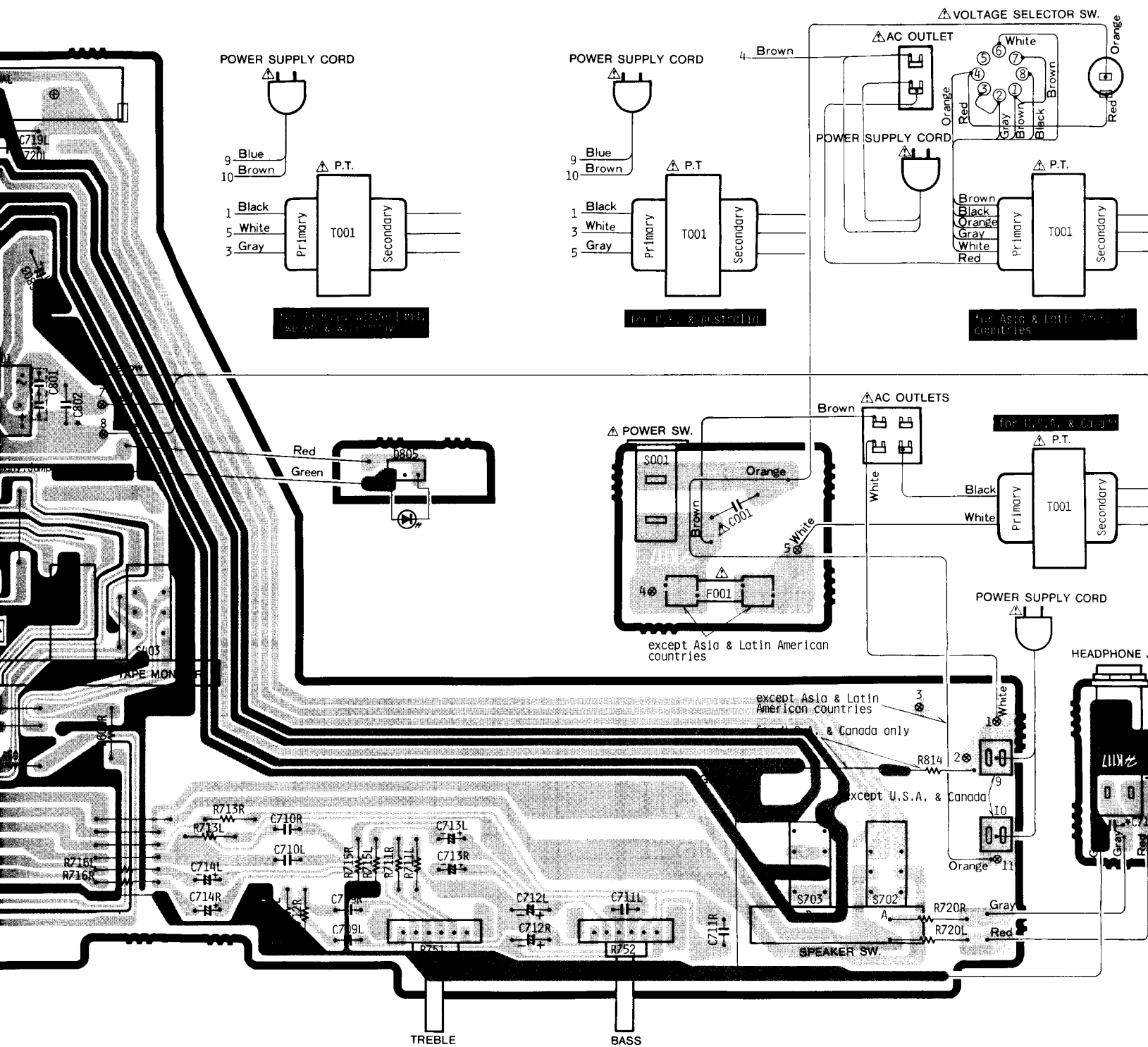

CIRCUIT DIAGRAM • SCHALTPLAN • PLAN DE CIRCUIT

HA-12

CAUTION

Use the electrolytic capacitors with explosion-proof when the diameter of them is more than 10mm

*:for W.Germany only

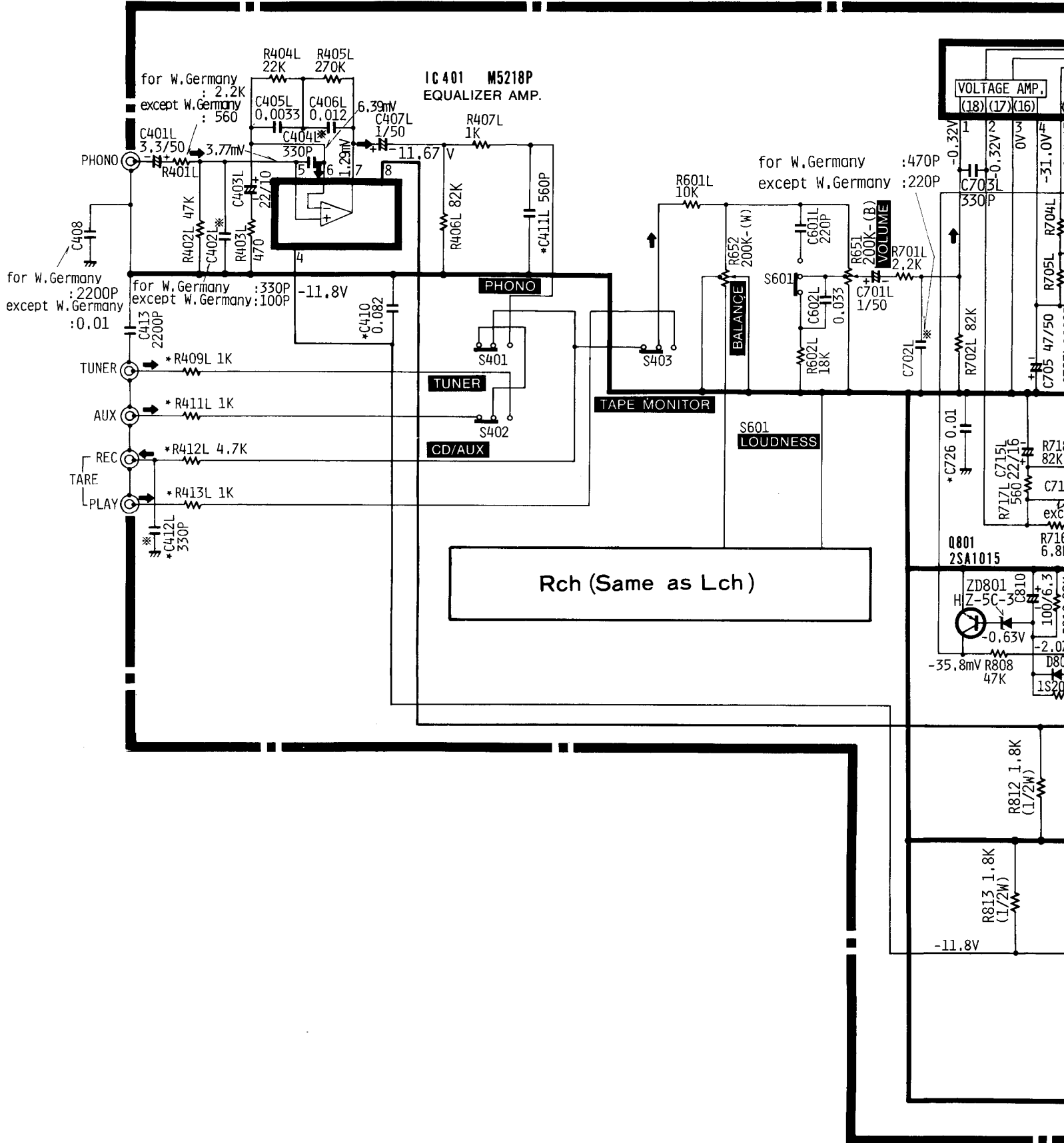

CAUTION

Use the electrolytic capacitors with explosion-proof valve when the diameter of them is more than 10mmφ.

- * : Axial lead cylindrical ceramic capacitor
- * : Zylindrischer Keramikcondensator mit axialer Zuleitung
- * : Condensateur céramique cylindrique à conducteur axial

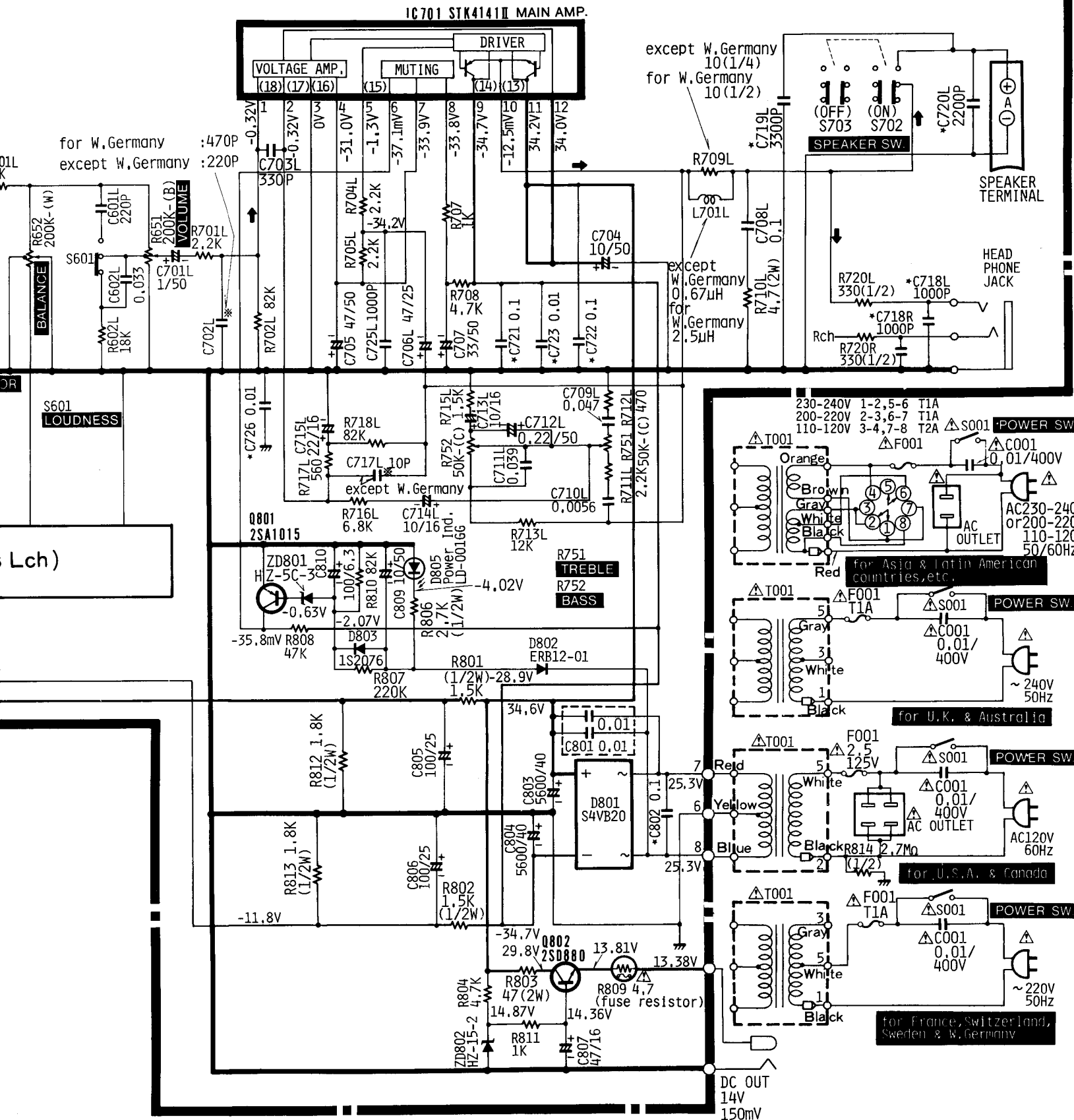

PRINTED WIRING BOARD · PRINTPLATTEN · PLAN DE BASE

•For U.K. only [ :Earth,  :Other]

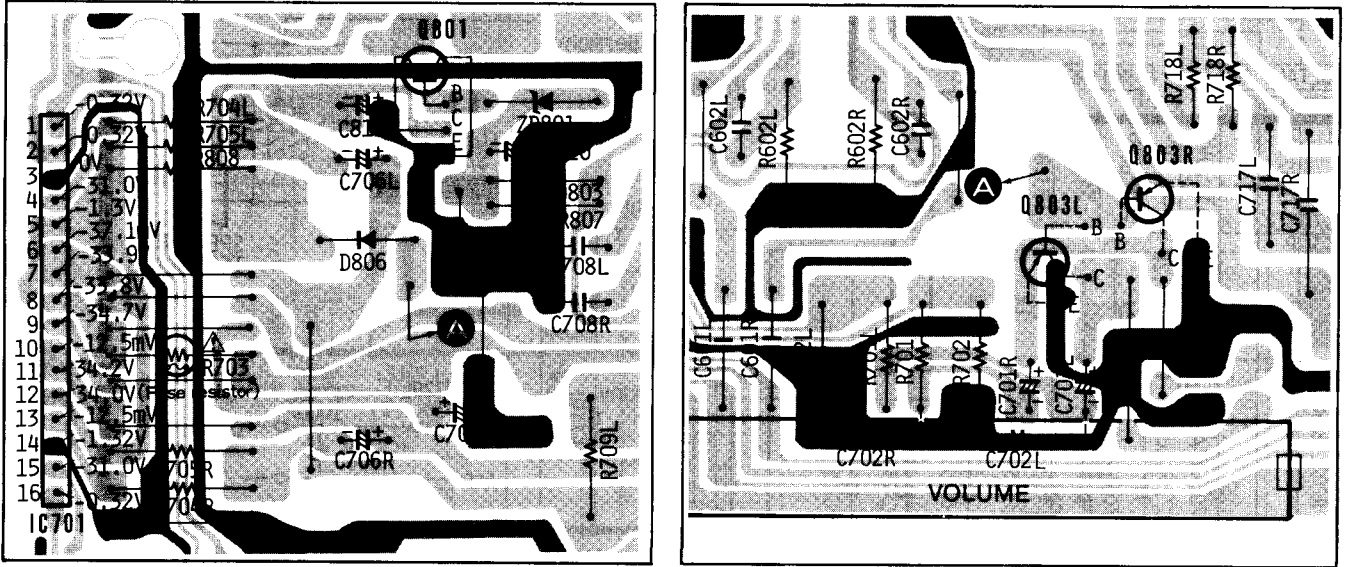

CIRCUIT DIAGRAM · SCHALTPLAN · PLAN DE CIRCUIT

•For U.K. only

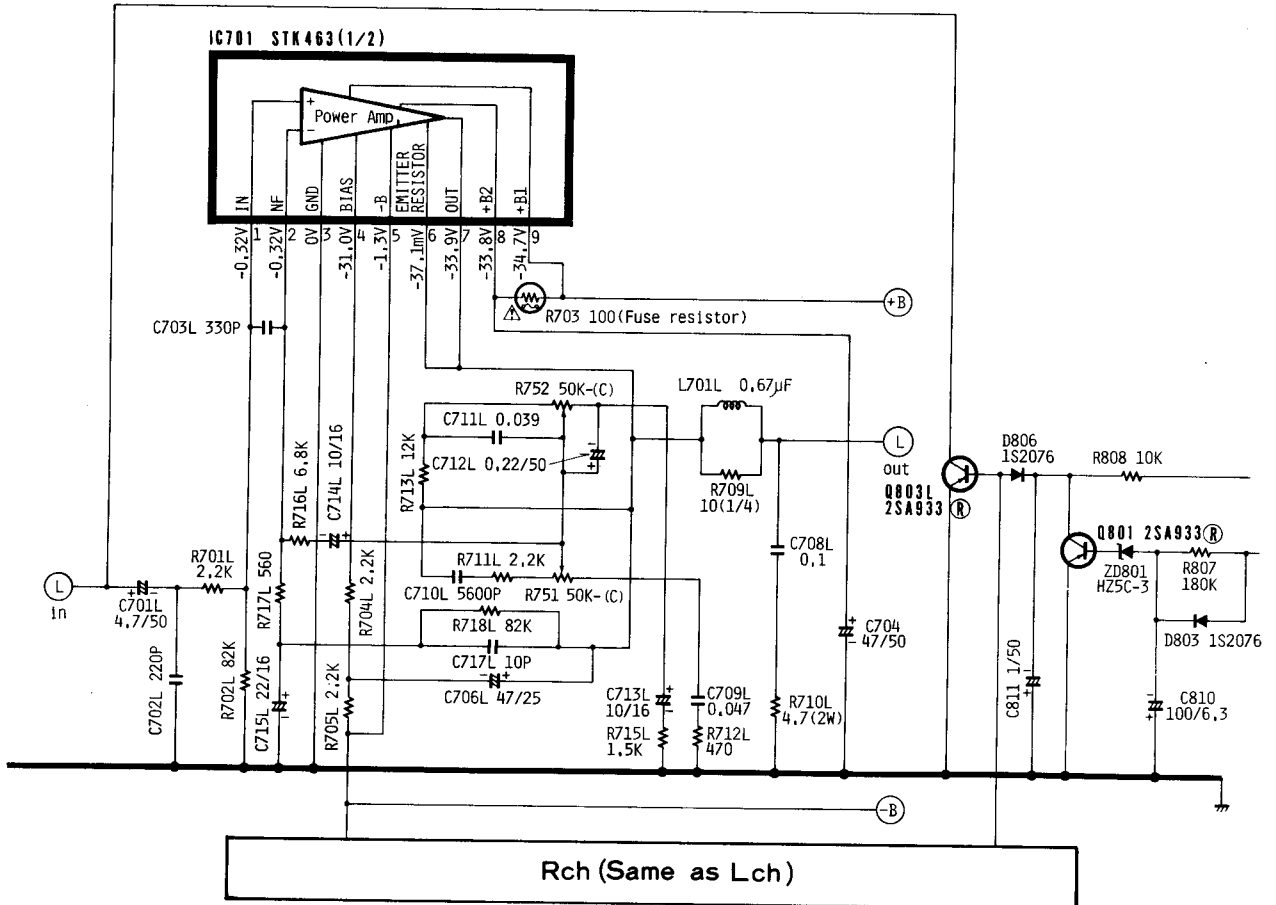

FRONT AND REAR PANEL. VORDERE UND HINTERE BEDIENUNGSTAFEL. PANNEAUX AVANT ET ARRIERE

FT-12

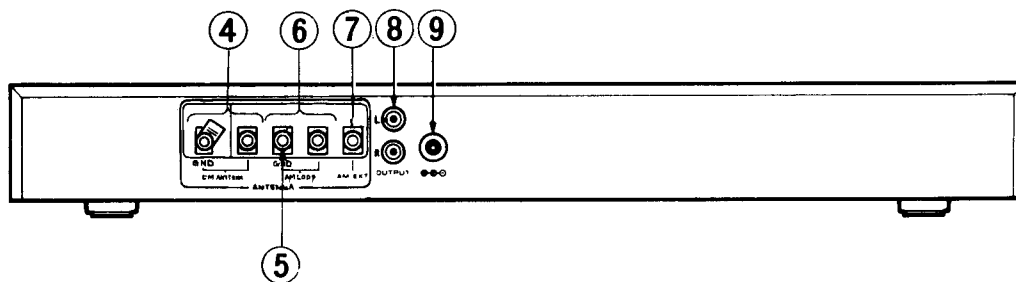
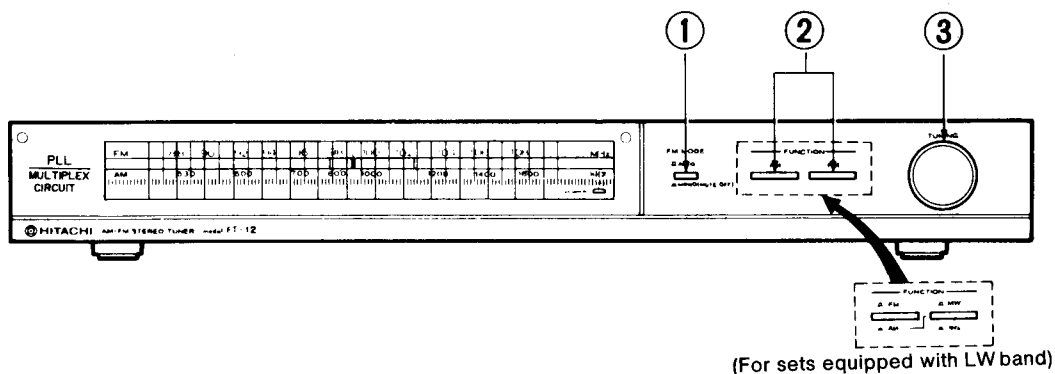

•For U.S.A. and Canada

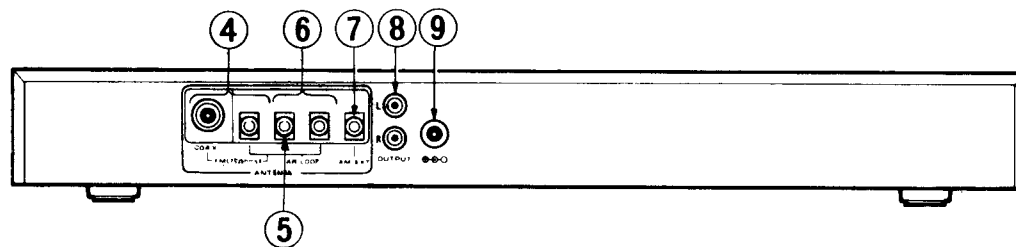

- ① FM MODE (AUTO/MONO MUTE OFF) switch
- ② FUNCTION switch
- ③ TUNING knob
- ④ FM ANTENNA terminals (75 ohms)
- ⑤ Ground terminal (GND)
- ⑥ AM loop antenna terminal
- ⑦ AM ANTENNA terminal
- ⑧ Output terminals
- ⑨ DC input terminal

- ① UKW-Betriebsartenschalter (FM MODE) (AUTO/MONO MUTE OFF)
- ② Funktionswahlschalter (FUNCTION)
- ③ Abstimmknopf (TUNING)
- ④ UKW-Antennenanschluß (FM ANTENNA) (75 Ohm)
- ⑤ Erdungsklemme (GND)
- ⑥ AM-Zimmerantenne
- ⑦ AM-Antennenklemme (AM ANTENNA)
- ⑧ Ausgangsbuchsen
- ⑨ Gleichspannungs-Eingangsklemme

- ① Commutateur de mode FM (MODE) (AUTO MONO MUTE OFF)
- ② Commutateur de fonction (FUNCTION)
- ③ Bouton d'accord (TUNING)
- ④ Bornes d'antenne FM (FM ANTENNA) (75 ohms)
- ⑤ Borne de mise à la terre (GND)
- ⑥ Antenne cadre AM
- ⑦ Borne d'antenne AM (AM ANTENNA)
- ⑧ Prise de sortie
- ⑨ Borne d'entrée CC

HA-12

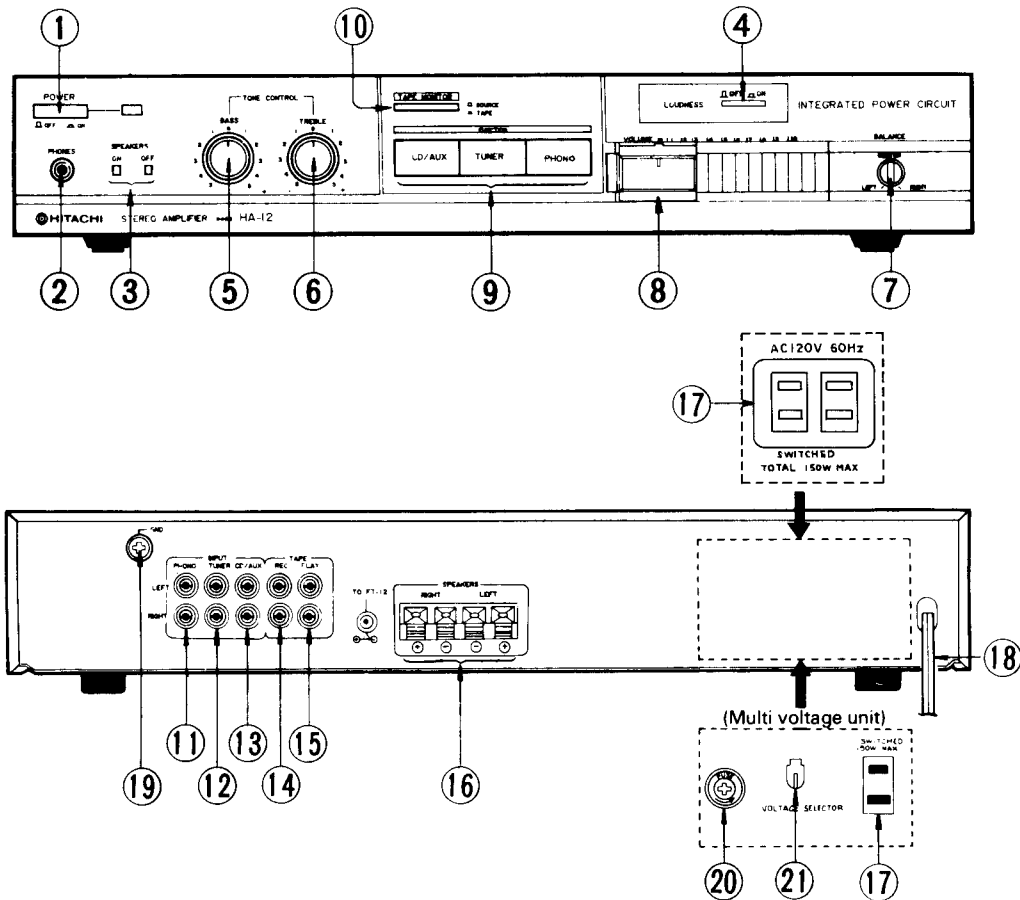

- | | | |
|--|--|--|
| ① POWER switch | ① Netzschalter (POWER) | ① Interrupteur d'alimentation (POWER) |
| ② PHONES jack | ② Kopfhörer-Buchse (PHONES) | ② Prise de casque (PHONES) |
| ③ SPEAKERS switches | ③ Lautsprecherschalter bass (SPEAKERS) | ③ Commutateur d'enceintes (SPEAKERS) |
| ④ LOUDNESS switch | ④ Schalter für gehorrlichtige Klangkorrektur (LOUDNESS) | ④ Commutateur de correction physiologique (LOUDNESS) |
| ⑤ BASS control | ⑤ BASS-Regler | ⑤ Commande des graves (BASS) |
| ⑥ TREBLE control | ⑥ Höhenregler (TREBLE) | ⑥ Commande des aigus (TREBLE) |
| ⑦ BALANCE control | ⑦ BALANCE-Regler | ⑦ Commande d'équilibrage (BALANCE) |
| ⑧ VOLUME control | ⑧ Lautstärkereglter (VOLUME) | ⑧ Commande de VOLUME |
| ⑨ FUNCTION switches | ⑨ Funktionsschalter (FUNCTION) | ⑨ Commutateur de fonction (FUNCTION) |
| ⑩ TAPE MONITOR switch | ⑩ Tonbandschalter (TAPE MONITOR) | ⑩ Commutateur du contrôleur de bande (TAPE MONITOR) |
| ⑪ PHONO INPUT jacks | ⑪ PHONO-Eingangsbuchse (PHONO INPUT) | ⑪ Prises d'entrée PHONO (PHONO INPUT) |
| ⑫ TUNER INPUT jacks | ⑫ Tuner-Eingangsbuchse (TUNER INPUT) | ⑫ Bornes d'entrée tuner (TUNER INPUT) |
| ⑬ CD/AUX jacks | ⑬ CD/AUX-Eingangsbuchse (CD/AUX) | ⑬ Bornes d'entrée CD/AUX (CD/AUX) |
| ⑭ TAPE REC jacks | ⑭ Bandaufnahmebuchsen (TAPE REC) | ⑭ Prises d'entregistrement de magné phono (TAPE REC) |
| ⑮ TAPE PLAY jacks | ⑮ Bandwiedergabebuchsen (TAPE PLAY) | ⑮ Prises de reproduction du magnéphonon (TAPE PLAY) |
| ⑯ SPEAKERS terminals | ⑯ Lautsprecher-Klemmen (SPEAKERS) | ⑯ Bornes d'enceintes (SPEAKERS) |
| ⑰ AC outlet
(2 outlets for U.S.A. & Canada sets,
1 outlet for Asia & Latin American
countries sets) | ⑰ Kaltgeräte-Steckdose
(2 Steckdosen bei für USA und
Kanada bestimmten Modellen ; 1
Steckdose bei für Asien und
Lateinamerika bestimmten Modellen) | ⑰ Prises C.A. (2 prises d'alimentation sur
les modèles destinés aux Etats-Unis et
au Canada, 1 prise d'alimentation pour
les pays d'Asie et d'Amérique Latine) |
| ⑱ Power supply cord | ⑱ Netzkabel | ⑱ Cordon d'alimentation C.A. |
| ⑲ Ground terminal (GND) | ⑲ Erdung (GND) | ⑲ Borne de terre (GND) |
| ⑳ FUSE holder
(for Asia & Latin American countries) | ⑳ Sicherungshalterung (FUSE)
(für Asien und Lateinamerika) | ⑳ Porte-fusible (FUSE)
(pour l'Asie et l'Amérique Latine) |
| ㉑ VOLTAGE SELECTOR
(for Asia & Latin American countries) | ㉑ Spannungswähler
(VOLTAGE SELECTOR)
(für Asien und Lateinamerika) | ㉑ Sélecteur de tension
(VOLTAGE SELECTOR)
(Pour l'Asie et l'Amérique Latine) |

REPLACEMENT PARTS LIST • ERSATZTEILISTE • TABLEAU DES PIÈCE

FT-12

SYMBOL No.	PART No.	DESCRIPTION			SYMBOL No.	PART No.	DESCRIPTION			
CAPACITORS										
C101	0240002	Cylindrical ceramic	150pF	±10%	50V	C218	0240220	Ceramic, discal (for U.S.A. & Canada)	0.047μF ±10%	25V
C102	0230112	Cylindrical ceramic	10pF	±5%	50V	C218	0240108	Cylindrical ceramic (except U.S.A. & Canada)	0.022μF ±30%	16V
C103	0230028	Cylindrical ceramic	47pF	±5%	50V	C219	0252815	Electrolytic	4.7μF	50V
C104	0240108	Cylindrical ceramic	0.022μF	±30%	16V	C222	0252521	Electrolytic	10μF	16V
C105	0240108	Cylindrical ceramic	0.022μF	±30%	16V	C223	0252521	Electrolytic	10μF	16V
C106	0230118	Cylindrical ceramic	18pF	±5%	50V	C301	0252815	Electrolytic	4.7μF	50V
C107	0230006	Cylindrical ceramic (except W. Germany & Italy)	3.3pF	±10%	50V	C302	0252532	Electrolytic	220μF	16V
C107	0230004	Cylindrical ceramic (for W. Germany & Italy)	2.2pF	±10%	50V	C303	0240004	Cylindrical ceramic (for W. Germany & Italy)	220pF ±10%	50V
C108	0230010	Cylindrical ceramic	6.8pF	±10%	50V	C305	0240108	Cylindrical ceramic	0.022μF ±30%	16V
C109	0230036	Cylindrical ceramic	100pF	±5%	50V	C307	0252521	Electrolytic	10μF	16V
C110	0240108	Cylindrical ceramic	0.022μF	±30%	16V	C308	0252521	Electrolytic	10μF	16V
C111	0240108	Cylindrical ceramic	0.022μF	±30%	16V	C309	0274013	Mylar, film (for U.S.A. & Canada)	2200pF ±10%	50V
C112	0248336	Ceramic, discal	18pF	±5%	50V	C309	0274231	Mylar, film (except U.S.A. & Canada)	1200pF ±5%	50V
C113	0248037	Ceramic, discal	20pF	±5%	50V	C310	0274013	Mylar, film (for U.S.A. & Canada)	2200pF ±10%	50V
C114	0230120	Cylindrical ceramic	22pF	±5%	50V	C310	0274231	Mylar, film (except U.S.A. & Canada)	1200pF ±5%	50V
C115	0230076	Cylindrical ceramic	39pF	±5%	50V	C311	0252802	Electrolytic	0.22μF	50V
C116	0230058	Cylindrical ceramic	4.7pF	±10%	50V	C312	0252811	Electrolytic	1μF	50V
C117	0240108	Cylindrical ceramic	0.022μF	±30%	16V	C313	0252812	Electrolytic	2.2μF	50V
C118	0246411	Ceramic, discal	1μF	±0.25%	50V	C314	0246470	Ceramic, discal	270pF ±5%	50V
C119	0248640	Ceramic, discal (except W. Germany & Italy)	10pF	±0.25%	50V	C315	0252812	Electrolytic	2.2μF	50V
C121	0230026	Cylindrical ceramic (for W. Germany & Italy)	39pF	±5%	50V	C316	0252812	Electrolytic	2.2μF	50V
C122	0240108	Cylindrical ceramic (for W. Germany & Italy)	0.022μF	±30%	16V	C317	0240106	Cylindrical ceramic	0.01μF ±30%	25V
C123	0240108	Cylindrical ceramic (for W. Germany & Italy)	0.022μF	±30%	16V	C318	0240106	Cylindrical ceramic	0.01μF ±30%	25V
C124	0230012	Cylindrical ceramic (for W. Germany & Italy)	10pF	±5%	50V	C319	0274034	Mylar, film	3900pF ±10%	50V
C152	0230062	Cylindrical ceramic (except France, Switzerland & U.K.)	10pF	±5%	50V	C320	0240108	Cylindrical ceramic	0.022μF ±30%	16V
C152	0230060	Cylindrical ceramic (for France, Switzerland & U.K.)	6.8pF	±5%	50V	C321	0240101	Cylindrical ceramic (for W. Germany & Italy)	1500pF ±30%	50V
C153	0230074	Cylindrical ceramic (for France, Switzerland & U.K.)	33pF	±5%	50V	C321	0274012	Mylar, film (for U.S.A. & Canada)	1500pF ±10%	50V
C154	0279327	Polypro-pylene	360pF	±5%	100V	C322	0240101	Cylindrical ceramic (for W. Germany & Italy)	1500pF ±30%	50V
C155	0241884	Ceramic, discal	22pF	±5%	50V	C322	0274012	Mylar, film (for U.S.A. & Canada)	1500pF ±10%	50V
C156	0228315	Styrol (for France, Switzerland & U.K.)	150pF	±5%	50V	RESISTORS				
C157	0248050	Ceramic, discal (for France, Switzerland & U.K.)	68pF	±5%	50V	R101	0129547	Carbon film	47Ω ±5%	SRD1/4P
C201	0240108	Cylindrical ceramic	0.022μF	±30%	16V	R102	0129561	Carbon film	100Ω ±5%	SRD1/4P
C202	0240108	Cylindrical ceramic	0.022μF	±30%	16V	R103	0129617	Carbon film	4.7kΩ ±5%	SRD1/4P
C203	0240108	Cylindrical ceramic	0.022μF	±30%	16V	R104	0129639	Carbon film	22kΩ ±5%	SRD1/4P
C204	0240108	Cylindrical ceramic	0.022μF	±30%	16V	R105	0129603	Carbon film	1.2kΩ ±5%	SRD1/4P
C205	0246456	Ceramic, discal	47Ω	±5%	50V	R106	0129561	Carbon film	100Ω ±5%	SRD1/4P
C206	0240108	Cylindrical ceramic	0.022μF	±30%	16V	R107	0129547	Carbon film	47Ω ±5%	SRD1/4P
C207	0252231	Electrolytic	100μF		6.3V	R108	0129623	Carbon film	8.2kΩ ±5%	SRD1/4P
C208	0252522	Electrolytic	22μF		16V	R109	0129605	Carbon film	1.5kΩ ±5%	SRD1/4P
C209	0240108	Cylindrical ceramic	0.022μF	±30%	16V	R110	0129637	Carbon film	18kΩ ±5%	SRD1/4P
C210	0240108	Cylindrical ceramic	0.022μF	±30%	16V	R111	0129583	Carbon film	820Ω ±5%	SRD1/4P
C211	0240108	Cylindrical ceramic	0.022μF	±30%	16V	R112	0129661	Carbon film (except W. Germany & Italy)	100kΩ ±5%	SRD1/4P
C212	0230036	Cylindrical ceramic	100pF	±5%	50V	R112	0129653	Carbon film (for W. Germany & Italy)	82kΩ ±5%	SRD1/4P
C213	0252521	Electrolytic	10μF		16V	R120	0129661	Carbon film (for W. Germany & Italy)	100kΩ ±5%	SRD1/4P
C214	0240108	Cylindrical ceramic	0.022μF	±30%	16V	R121	0129603	Carbon film (for W. Germany & Italy)	1.2kΩ ±5%	SRD1/4P
C215	0252811	Electrolytic	1μF		50V					
C216	0240108	Cylindrical ceramic	0.022μF	±30%	16V					
C217	0252521	Electrolytic	10μF		16V					

SYMBOL No.	PART No.	DESCRIPTION		
R122	0129661	Carbon film (for W. Germany & Italy)	100kΩ ±5%	SRD1/4P
R123	0129669	Carbon film (for W. Germany & Italy)	220kΩ ±5%	SRD1/4P
R151	0129601	Carbon film (except U.S.A. & Canada)	1kΩ ±5%	SRD1/4P
R151	0134373	Composition (for U.S.A. & Canada)	1kΩ ±10%	RC1/2GF
R152	0129601	Carbon film	1kΩ ±5%	SRD1/4P
R201	0129573	Carbon film	330Ω ±5%	SRD1/4P
R202	0129603	Carbon film (except W. Germany & Italy)	1.2kΩ ±5%	SRD1/4P
R202	0129579	Carbon film (for W. Germany & Italy)	560Ω ±5%	SRD1/4P
R203	0129601	Carbon film	1kΩ ±5%	SRD1/4P
R204	0129579	Carbon film	560Ω ±5%	SRD1/4P
R205	0129607	Carbon film	1.8kΩ ±5%	SRD1/4P
R207	0129577	Carbon film	470Ω ±5%	SRD1/4P
R208	0129577	Carbon film	470Ω ±5%	SRD1/4P
R209	0129635	Carbon film	15kΩ ±5%	SRD1/4P
R210	0129631	Carbon film	10kΩ ±5%	SRD1/4P
R211	0129649	Carbon film	56kΩ ±5%	SRD1/4P
R223	0129601	Carbon film	1kΩ ±5%	SRD1/4P
R224	0129649	Carbon film	56kΩ ±5%	SRD1/4P
R225	0129661	Carbon film	100kΩ ±5%	SRD1/4P
R226	0129617	Carbon film	4.7kΩ ±5%	SRD1/4P
R227	0129619	Carbon film	5.6kΩ ±5%	SRD1/4P
R228	0129661	Carbon film	100kΩ ±5%	SRD1/4P
R229	0129661	Carbon film	100kΩ ±5%	SRD1/4P
R230	0129619	Carbon film (for U.S.A. & Canada)	5.6kΩ ±5%	SRD1/4P
R231	0129669	Carbon film	220kΩ ±5%	SRD1/4P
R233	0129631	Carbon film	10kΩ ±5%	SRD1/4P
R234	0129569	Carbon film	220Ω ±5%	SRD1/4P
R236	0129637	Carbon film (except U.S.A., Canada, W. Germany & Italy)	18kΩ ±5%	SRD1/4P
R236	0129631	Carbon film (for W. Germany & Italy)	10kΩ ±5%	SRD1/4P
R240	0129874	Carbon film	1.5kΩ ±5%	SRD1/4P
R301	0129639	Carbon film	22kΩ ±5%	SRD1/4P
R302	0100645	Carbon film	39Ω ±5%	SRD1/4P
R303	0129643	Carbon film	33kΩ ±5%	SRD1/4P
R304	0129643	Carbon film	33kΩ ±5%	SRD1/4P
R305	0129665	Carbon film (except U.S.A., Canada, W. Germany & Italy)	150kΩ ±5%	SRD1/4P
R305	0129671	Carbon film (for U.S.A. & Canada)	270kΩ ±5%	SRD1/4P
R306	0129621	Carbon film (except U.S.A. & Canada)	6.8kΩ ±5%	SRD1/4P
R306	0129635	Carbon film (for U.S.A. & Canada)	15kΩ ±5%	SRD1/4P
R307	0129621	Carbon film (except U.S.A. & Canada)	6.8kΩ ±5%	SRD1/4P
R307	0129635	Carbon film (for U.S.A. & Canada)	15kΩ ±5%	SRD1/4P
R308	0129645	Carbon film	39kΩ ±5%	SRD1/4P
R309	0129645	Carbon film	39kΩ ±5%	SRD1/4P
R310	0129605	Carbon film	1.5kΩ ±5%	SRD1/4P

SYMBOL No.	PART No.	DESCRIPTION		
R311	0129605	Carbon film	1.5kΩ ±5%	SRD1/4P
R312	0129609	Carbon film	2.2kΩ ±5%	SRD1/4P
R313	0129651	Carbon film	68kΩ ±5%	SRD1/4P
R314	0129661	Carbon film	100kΩ ±5%	SRD1/4P
R315	0129665	Carbon film	150kΩ ±5%	SRD1/4P
R316	0129601	Carbon film	1kΩ ±5%	SRD1/4P
R317	0129631	Carbon film	10kΩ ±5%	SRD1/4P
R318	0129643	Carbon film	33kΩ ±5%	SRD1/4P
R320	0129619	Carbon film	5.6kΩ ±5%	SRD1/4P
R321	0129619	Carbon film	5.6kΩ ±5%	SRD1/4P
R322	0129611	Carbon film (for W. Germany & Italy)	2.7kΩ ±5%	SRD1/4P
R323	0129617	Carbon film	4.7kΩ ±5%	SRD1/4P
R324	0129617	Carbon film	4.7kΩ ±5%	SRD1/4P

ICS & TRANSISTORS

IC201	2368431	AN278
IC202	2387321	AN7273
IC301	2367271	HA1196
Q101	2327683	2SK55 (D)
Q102	0573510	2SC535 (B)
Q103	0573508	2SC461 (C)
Q120	2328805	2SK104 (for W. Germany & Italy)
Q206	2328282	2SC458 (C)
Q207	2328282	2SC458 (C)
Q301	2328282	2SC458 (C)
Q302	2328282	2SC458 (C)

DIODES

D103	2337931	1K60R (for W. Germany & Italy)
D104	2337601	1S2473
D105	2337601	1S2473
D120	2337931	1K60R (for W. Germany & Italy)
D121	2337931	1K60R (for W. Germany & Italy)
D151	2337601	1S2473
D152	2337601	1S2473
D201	2337601	1S2473
D301	2337601	1S2473
D302	2337752	LED GL-5PR6H
ZD301	2337613	HZ3A-3

VARIABLE RESISTOR

R319	0158955	10kΩ - (B)
------	---------	------------

COILS & TRANSISTORS

L101	2227354	Choke coil 2.2μH
L102	2134471	FM OSC coil

SYMBOL No.	PART No.	DESCRIPTION	SYMBOL No.	PART No.	DESCRIPTION			
L151	2136501	AM antenna coil (MW)	for DIAL MECHANISM ASSEMBLY					
L152	2136502	AM antenna coil (LW) (for France, Switzerland & U.K.)						
L153	2227354	Choke coil 2.2 μ H						
T101	2136511	FM antenna coil						
T102	2136513	FM RF coil						
T103	2155181	FM IFT coil (7 MM)						
T151	2136491	AM OSC coil (MW)						
T152	2136492	AM OSC coil (LW) (for France, Switzerland & U.K.)						
T201	2155173	FM disci trans.						
T251	2154493	AM IFT trans.				for CHASSIS ASSEMBLY		
MISCELLANEOUS								
CP201	2136312	Anti-birdy filter	4025881		Front panel ass'y [Silver] (except France, Switzerland & U.K.)			
MF201	2134981	FM ceramic filter 10.7 MA5 (for U.S.A. & Canada)	4025882		Front panel ass'y [Silver] (for France, Switzerland & U.K.)			
MF201	2135001	FM ceramic filter 10.7 MS2 (except U.S.A. & Canada)	4025883		Front panel ass'y [Black] (except France, Switzerland & U.K.)			
MF202	2135001	FM ceramic filter 10.7 MS2 (for W. Germany & Italy)	4025884		Front panel ass'y [Black] (for France, Switzerland & U.K.)			
MF203	2134981	FM ceramic filter 10.7 MA5 (for U.S.A. & Canada)	3965781		Blind			
MF203	2135001	FM ceramic filter 10.7 MS2 (except U.S.A. & Canada)	3947541		Nilon rivet (B)			
MF251	2155152	AM ceramic filter SFZ450F	3927412		Leg (10 \times 21.8)			
CT103	0283121	Trimmer capacitor 10P (white)	3958741		Push button [Silver]			
CT151	0283126	Trimmer capacitor 11P (white) (for France, Switzerland & U.K.)	3958743		Push button [Black]			
CT152	0283126	Trimmer capacitor 11P (white) (for France, Switzerland & U.K.)	3958753		Push button			
CT153	0283126	Trimmer capacitor 11P (white) (for France, Switzerland & U.K.)	3356266		Tuning ass'y			
CT154	0283127	Trimmer capacitor 20P (red) (for France, Switzerland & U.K.)	4113441		M9 nut			
	3945205	Spacer	4567413		3 ϕ \times 10 DT bind screw			
	0282121	Variable capacitor (except France, Switzerland & U.K.)	4567412		3 ϕ \times 8 DT bind screw			
	0282122	Variable capacitor (for France, Switzerland & U.K.)	4784106		3 ϕ \times 10 bind tapping screw			
S901	2639893	Push switch (except France, Switzerland & U.K.)	4567432		3 ϕ \times 8 DT bind screw			
S901	2639894	Push switch (for France, Switzerland & U.K.)	4567454		3 ϕ \times 12 DT bind screw			
S902	2639893	Push switch (except France, Switzerland & U.K.)	4567462		AM loop antenna			
S902	2639894	Push switch (for France, Switzerland & U.K.)	4458081		Rear plate (for U.S.A.)			
S903	2639894	Push switch (for France, Switzerland & U.K.)	4458082		Rear plate (for Canada)			
	2689371	Antenna terminal (for U.S.A. & Canada)	4458083		Rear plate (for W. Germany & Italy)			
	2689372	Antenna terminal (except U.S.A. & Canada)	4458084		Rear plate (for Sweden & Australia)			
			4458085		Rear plate (for Asia & Latin American countries)			
			4458086		Rear plate (for France, Switzerland & U.K.)			
for FINAL ASSEMBLY								
	4450361	Top cover [Silver]						
	4415588	Top cover [Black]						
	3297112	Knob (26) ass'y						
	4567463	4 ϕ \times 10 DT bind screw (for Cover) [Silver]						
	4567443	4 ϕ \times 10 DT bind screw (for Cover) [Black]						

HA-12

SYMBOL No.	PART No.	DESCRIPTION			
CAPACITORS					
C001	0243901	Ceramic, discal	0.01 μ F	+100% -0%	400V
C401LR	0252813	Electrolytic	3.3 μ F		50V
C402LR	0230036	Cylindrical ceramic (except W. Germany & Italy)	100pF	\pm 5%	50V
C402LR	0240006	Cylindrical ceramic (for W. Germany & Italy)	330pF	\pm 5%	50V
C403LR	0252322	Electrolytic	22 μ F		10V
C404LR	0240006	Cylindrical ceramic	330pF	\pm 10%	50V
C405LR	0274014	Mylar, film	3300pF	\pm 10%	50V
C406LR	0275231	Mylar, film	0.012 μ F	\pm 5%	50V
C407LR	0252811	Electrolytic	1 μ F		50V
C408	0209737	Ceramic, discal (except W. Germany & Italy)	0.01 μ F	\pm 10%	50V
C408	0274013	Mylar, film (for W. Germany & Italy)	2200pF	\pm 10%	50V
C410	0274011	Mylar, film (for W. Germany & Italy)	0.082 μ F	\pm 10%	50V
C411LR	0249724	Ceramic, discal (for W. Germany & Italy)	560pF	\pm 10%	50V
C412L	0239408	Ceramic, discal (for W. Germany & Italy)	330pF	\pm 10%	50V
C412R	0209721	Ceramic, discal (for W. Germany & Italy)	330pF	\pm 10%	50V
C413	0274013	Mylar, film (for W. Germany & Italy)	2200pF	\pm 10%	50V
C601LR	0240004	Cylindrical ceramic	220pF	\pm 10%	50V
C602LR	0275014	Mylar, film	0.033 μ F	\pm 10%	50V
C701LR	0252811	Electrolytic (except U.K.)	1 μ F		50V
C701LR	0252815	Electrolytic (for U.K.)	4.7 μ F		50V
C702LR	0240004	Cylindrical ceramic (except W. Germany & Italy)	220pF	\pm 10%	50V
C702LR	0240008	Cylindrical ceramic (for W. Germany & Italy)	470pF	\pm 10%	50V
C703LR	0240006	Cylindrical ceramic	330pF	\pm 10%	50V
C704	0252821	Electrolytic (except U.K.)	10 μ F		50V
C704	0252825	Electrolytic (for U.K.)	47 μ F		50V
C705	0252825	Electrolytic (except U.K.)	47 μ F		50V
C706LR	0252625	Electrolytic	47 μ F		25V
C707	0252823	Electrolytic (except U.K.)	33 μ F		50V
C708LR	0276011	Mylar, film	0.1 μ F	\pm 10%	50V
C709LR	0275015	Mylar, film	0.047 μ F	\pm 10%	50V
C710LR	0274235	Mylar, film	5600pF	\pm 10%	50V
C711LR	0275034	Mylar, film	0.039 μ F	\pm 10%	50V
C712LR	0252802	Electrolytic	0.22 μ F		50V
C713LR	0252521	Electrolytic	10 μ F		16V
C714LR	0252521	Electrolytic	10 μ F		16V
C715LR	0252522	Electrolytic	22 μ F		16V
C717LR	0230012	Cylindrical ceramic (except W. Germany & Italy)	10pF	\pm 5%	50V
C718LR	0274011	Mylar, film (for W. Germany & Italy)	1000pF	\pm 10%	50V
C719	0274014	Mylar, film (for W. Germany & Italy)	3300pF	\pm 30%	50V
C720LR	0274013	Mylar, film (for W. Germany & Italy)	2200pF	\pm 30%	50V
C721	0276011	Mylar, film (for W. Germany & Italy)	0.1 μ F	\pm 10%	50V

SYMBOL No.	PART No.	DESCRIPTION			
C722	0276011	Mylar, film (for W. Germany & Italy)	0.1 μ F	\pm 10%	50V
C723	0209737	Ceramic, discal (for W. Germany & Italy)	0.01 μ F	\pm 10%	50V
C725LR	0274011	Mylar, film (for W. Germany & Italy)	1000pF	\pm 10%	50V
C726	0239427	Ceramic, discal (for W. Germany & Italy)	0.01 μ F	\pm 10%	50V
C801	0241901	Ceramic, discal	0.1 μ F	+80% -20%	250V
C802	0276511	Mylar, film (for W. Germany & Italy)	0.1 μ F	\pm 10%	100V
C803	0259933	Electrolytic	5600pF		40V
C804	0259933	Electrolytic	5600pF		40V
C805	0252631	Electrolytic	100 μ F		25V
C806	0252631	Electrolytic	100 μ F		25V
C807	0252525	Electrolytic	47 μ F		16V
C809	0252821	Electrolytic	10 μ F		50V
C810	0252231	Electrolytic	100 μ F		6.3V
C811	0252811	Electrolytic (for U.K.)	1 μ F		50V
RESISTORS					
R401LR	0129579	Carbon film (except W. Germany & Italy)	560 Ω	\pm 5%	SRD1/4P
R401LR	0129609	Carbon film (for W. Germany & Italy)	2.2k Ω	\pm 5%	SRD1/4P
R402LR	0129647	Carbon film	47k Ω	\pm 5%	SRD1/4P
R403LR	0129577	Carbon film	470 Ω	\pm 5%	SRD1/4P
R404LR	0129639	Carbon film	22k Ω	\pm 5%	SRD1/4P
R405LR	0129671	Carbon film	270k Ω	\pm 5%	SRD1/4P
R406LR	0129653	Carbon film	82k Ω	\pm 5%	SRD1/4P
R407LR	0129870	Carbon film (for W. Germany & Italy)	1k Ω	\pm 5%	SRD1/4P
R409LR	0129870	Carbon film (for W. Germany & Italy)	1k Ω	\pm 5%	SRD1/4P
R411LR	0129870	Carbon film (for W. Germany & Italy)	1k Ω	\pm 5%	SRD1/4P
R412LR	0129617	Carbon film (for W. Germany & Italy)	4.7k Ω	\pm 5%	SRD1/4P
R413LR	0129601	Carbon film (for W. Germany & Italy)	1k Ω	\pm 5%	SRD1/4P
R601LR	0129631	Carbon film	10k Ω	\pm 5%	SRD1/4P
R602LR	0129637	Carbon film	18k Ω	\pm 5%	SRD1/4P
R701LR	0129609	Carbon film	2.2k Ω	\pm 5%	SRD1/4P
R702LR	0129653	Carbon film	82k Ω	\pm 5%	SRD1/4P
Δ R703	0110621	Metal(fuse Resistor) (for U.K.)	100 Ω	\pm 5%	RN1/4B
R704LR	0129609	Carbon film	2.2k Ω	\pm 5%	SRD1/4P
R705LR	0129609	Carbon film	2.2k Ω	\pm 5%	SRD1/4P
R706	0134373	Composition (except U.K.)	1k Ω	\pm 10%	RC1/2GF
R707	0129601	Carbon film (except U.K.)	1k Ω	\pm 5%	SRD1/4P
R708	0129617	Carbon film (except U.K.)	4.7k Ω	\pm 5%	SRD1/4P
R709LR	0129531	Carbon film (except W. Germany & Italy)	10 Ω	\pm 5%	SRD1/4P
R709LR	0134289	Composition (for W. Germany & Italy)	10 Ω	\pm 10%	RC1/2GF
R710LR	0119139	Metal	4.7 Ω	\pm 10%	RN2B
R711LR	0129609	Carbon film	2.2k Ω	\pm 5%	SRD1/4P
R712LR	0129577	Carbon film	470 Ω	\pm 5%	SRD1/4P
R713LR	0129633	Carbon film	12k Ω	\pm 5%	SRD1/4P

SYMBOL No.	PART No.	DESCRIPTION		
R715LR	0129605	Carbon film	1.5kΩ ±5%	SRD1/4P
R716LR	0129621	Carbon film	6.8kΩ ±5%	SRD1/4P
R717LR	0129579	Carbon film	560Ω ±5%	SRD1/4P
R718LR	0129653	Carbon film	82kΩ ±5%	SRD1/4P
R720LR	0134367	Composition	330Ω ±10%	RC1/2GF
R801	0134375	Composition	1.5kΩ ±10%	RC1/2GF
R802	0134375	Composition	1.5kΩ ±10%	RC1/2GF
R803	0119159	Metal	47Ω ±10%	RN2B
R804	0129617	Carbon film	4.7kΩ ±5%	SRD1/4P
R806	0134378	Composition	2.7kΩ ±10%	RC1/2GF
R807	0129669	Carbon film (except U.K.)	220kΩ ±5%	SRD1/4P
R807	0129667	Carbon film (for U.K.)	180kΩ ±5%	SRD1/4P
R808	0129647	Carbon film (except U.K.)	47kΩ ±5%	SRD1/4P
R808	0129631	Carbon film (for U.K.)	10kΩ ±5%	SRD1/4P
△R809	0118445	Metal(fuse resistor)	4.7Ω ±5%	RN1/4B
R810	0129653	Carbon film	82kΩ ±5%	SRD1/4P
R811	0129601	Carbon film	1kΩ ±5%	SRD1/4P
R812	0134376	Composition	1.8kΩ ±10%	RC1/2GF
R813	0134376	Composition	1.8kΩ ±10%	RC1/2GF
R814	0139005	Composition (for U.S.A. & Canada)	2.7MΩ ±10%	RC1/2GF
R815	0129623	Carbon film	8.2kΩ ±10%	SRD1/4P
ICS & TRANSISTORS				
IC401	2387301	M5218P		
IC701	2387531	STK4141 II (except U.K.)		
IC701	2368842	STK463B (for U.K.)		
Q801	2329183	2SA1015 (GR) (except U.K.)		
Q801	2329582	2SA933 (R) (for U.K.)		
Q802	2317822	2SD880		
Q803LR	2329582	2SA933 (R) (for U.K.)		
DIODES				
D801	2337461	S4VB20		
D802	2337762	FRB12-01R		
D803	2337011	1S2076		
D805	2339981	LED LD-001GG		
D806	2337011	1S2076 (for U.K.)		
ZD801	2337587	HZ5C-3		
ZD802	2337532	HZ-15-2		
VARIABLE RESISTORS				
R651	0166751	200kΩ - (B) (MAIN)		
R652	0151848	200kΩ - (W) (BALANCE)		
R751	0158733	50kΩ - (C) (TONE)		
R752	0158733	50kΩ - (C) (TONE)		
COILS				
L701LR	2227361	Audio trap coil (except W. Germany & Italy)		
L701LR	2227311	Audio trap coil (for W. Germany & Italy)		

SYMBOL No.	PART No.	DESCRIPTION
MISCELLANEOUS		
△F001	2727964	Fuse 2.5A (for U.S.A. & Canada)
△F001	2727191	Fuse T1A 250V (except U.S.A., Canada, Asia & Latin American countries)
	2639660	4 key push switch (FUNCTION)
	2600141	Push switch (LOUDNESS)
	2600122	2 key push switch (SPEAKER)
	2639869	Power switch
	2688282	4P push terminal
	2677753	Headphone jack
	2678347	6P US pin jack
	2678348	4P US pin jack
	2678451	DC jack
for FINAL ASSEMBLY		
	3965761	Front panel ass'y [Silver]
	3965762	Front panel ass'y [Black]
	3297101	Knob (20)
	3296681	REC knob
	3292555	Knob (10)
	4453241	Cover (for U.K.) [Silver]
	4453242	Cover (except U.K.) [Silver]
	4455940	Cover [Black]
	3297792	Power button ass'y
	3297801	Push knob
	3297821	Push knob ass'y
	3297822	Push knob
	3297823	Push knob
	3297811	Push knob
	3297841	Push knob [Silver]
	3297843	Push knob [Black]
	3927411	Leg
	4567411	3φ × 6 DT bind screw
	4567432	3φ × 8 DT bind screw
	4784106	3φ × 10 bind tapping screw
	4567454	3φ × 12 DT bind screw
	4567422	4φ × 8 DT bind screw
	4567413	3φ × 10 DT bind screw
	4567412	3φ × 8 DT bind screw
	8811114	3φ Washer
for REAR PLATE ASSEMBLY		
	4458231	Rear plate (for U.S.A.)
	4458232	Rear plate (for Canada)
	4458233	Rear plate (for France, Switzerland, Sweden & W. Germany & Italy)
	4458234	Rear plate (for U.K. & Australia)
	4458235	Rear plate (for Asia & Latin American countries)
	0043793	Bushing (for U.S.A. & Canada)
	3913006	Bushing (except U.S.A. & Canada)
	2700121	Power supply cord (for U.S.A. & Canada)
	2748752	Power supply cord (for France, Switzerland, Sweden, W. Germany, Italy, Asia & Latin American countries)
	2749582	Power supply cord (for U.K.)

SYMBOL No.	PART No.	DESCRIPTION
△	2749622	Power supply cord (for Australia)
△	2658481	AC outlet (for U.S.A. & Canada)
△	2658372	AC outlet (for Asia & Latin American countries)
△	2618053	AC selector switch (for Asia & Latin American countries)
△	2727191	Fuse T1A
△	4567432	3φ × 8 DT bind screw (for Asia & Latin American countries)

SYMBOL No.	PART No.	DESCRIPTION
for ACCESSORIES		
△	2757525	FM antenna (except W. Germany & Italy)
△	2717514	DC plug cord (for U.S.A. & Canada)
△	2702451	DC cord
△	2749500	Patch cord
△	2658361	E socket adaptor (for Asia & Latin American countries)
△	2727193	Fuse T2A 250V (for Asia & Latin American countries)

Check that exposed parts are acceptably insulated from the supply circuit before returning the instrument repaired to the customer.

● **Checking method**

Power switch is set to ON.
 Next, measure the resistance value between the both poles of attachment cup (Power supply plug) and the exposed parts (Parts such as Ground terminal, Knob, Cover, etc. where the customer is easy to touch.) and check that the resistance value is 500 kohms or more.

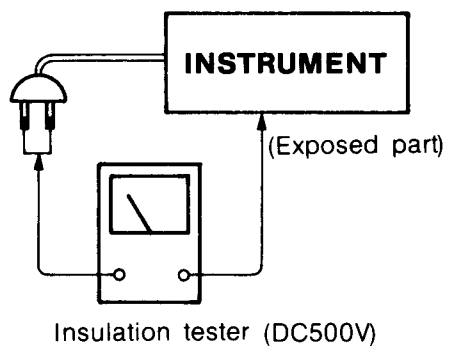

**HITACHI SALES EUROPA GmbH**

Postfach 801060 Rungedamm 2, 2050 Hamburg 80,
West Germany
Tel. 040-734 11-0

HITACHI SALES (U.K.) Ltd.

Hitachi House, Station Road, Hayes, Middlesex UB3
4DR, England
Tel. 01-848-8787

HITACHI SALES SCANDINAVIA AB

Rissneleden 8, Box 7138, 172-07 Sundbyberg, Sweden
Tel. 08-98 52 80

HITACHI SALES NORWAY A/S

Oerebekk 1620, Gressvik, P.O. Box 46, N-1601,
Fredrikstad, Norway
Tel. 032-28255

SUOMEN HITACHI OY

Takojankatsu 5, 15800 Lahti 80, Finland
Tel. Lahti 44 241

HITACHI SALES A/S

Kuldysen 13, DK-2630, Taastrup, Denmark
Tel. 02-999200

HITACHI SALES A.G.

Bahnhofstrasse, 19, 5600 Lenzburg, Switzerland
Tel. 064-513621

HITACHI SALES WARENHANDELS GMBH

A-1180/Wien, Kreuzgasse 27, Austria
Tel. 0222-439367

HITACHI SALES ITALIANA, S.P.A.

Via Cristoforo Colombo 49, Trezzano sul naviglio
(Milano), Italy
Tel. 02-44 59 031

HITACHI SALES BELGIUM S.A.

56 Chaussee de Namur B-1400 Nivelles, Belgium
Tel. (003267) 227181

HITACHI SALES IBERICA, S.A.

Gran Via Carlos Tercero, 101, 1-1, Barcelona-28,
Spain
Tel. 330-8652

HITACHI MAROC (RADIO TV ELECTRO-MANAGER), S.A.

Rue du Havre, Casablanca, Morocco
Tel. 30-73-68, 30-73-57

HITACHI CANARIAS S.A.

Calle San-Francisco No. 19, Santa Cruz de Tenerife
Canary Islands
Tel. 24-64-98

HITACHI SALES (HELLAS) LTD.

110 Syngrou St., Athens, Greece
Tel. 9219082, 9233469

HITACHI SALES (MALAYSIA) SDN. BHD.

17, Jalan 20/16, Petaling Jaya, Selangor, Malaysia
Tel. 762523, 769918, 769836, 762594

HITACHI (SINGAPORE) PTE., LTD.

Room B, C & D, 15th Floor, Yen San Building
268 Orchard Road, Singapore 9, Singapore
Tel. 7378244, 7379826

HITACHI SALES (THAILAND) LTD.

2242-48, New Petchburi Road, Bangkok, Hueykuang
Bangkok, Thailand
Tel. 314-2741

HITACHI ELECTRIC SERVICE CO., (HONG KONG) LTD.

4th Floor Leun Tai Industrial Bldg., 72-76 Kwai Cheong
Road Kwai Chung N.T., Hong Kong
Tel. 240126

HITACHI SALES AUSTRALIA PTY LTD.

153 Keys Road, Moorabbin, Victoria 3189 Australia
Tel. 555-8722

HITACHI SALES CORPORATION OF AMERICA

Eastern Regional Office
1200 Wall Street West, Lyndhurst, New Jersey 07071, U.S.A.
Tel. 201-935-8980

Mid-Western Regional Office

1400 Morse Ave., Elk Grove Village, Ill. 60007, U.S.A.
Tel. 312-593-1550

Southern Regional Office

510 Plaza Drive, College Park, Georgia 30349, U.S.A.
Tel. 404-763-0360

Western Regional Office

401 West Artesia Boulevard, Compton, California 90220 U.S.A.
Tel. 213-537-8383

HITACHI SALES CORPORATION OF HAWAII, INC.

3219 Koapaka Street, Honolulu, Hawaii 96819, U.S.A.
Tel. 808-836-3621

HITACHI (HSC) CANADA INC.

3300 Trans-Canada Highway, Pointe Claire, Quebec,
H9R 1B1, Canada
Tel. 514-697-9150

Hitachi Sales Centroamericans, S.A.

San Rafael de Excazu, (Apartado 10272), San Jose,
Costa Rica
Tel. 28-20-11, 28-00-37

Hitachi Sales Corporation de Panama, S.A.

Nuevo Repato E1 Camen, Calle Ramon Arias y Calle B
Edificio Brasil 100. (Apartado 7657) Panama 5
Panama City, Rep. of Panama
Tel. 61-3100, 61-4305

Hitachi Sales de Chile Cia., Ltda.

Av. Mexico, 0183, Casilla 9793, Correo Central
Santiago, Chile
Tel. 774165

HITACHI-FRANCE S.A.

95-101 Rue Charles Michels,
93200 SAINT-DENIS,
France
Tel. 821 6015

HITACHI LTD. TOKYO JAPAN

Head Office : THE HITACHI ATAGO BLDG.
No. 15-12, 2-Chome Nishi-Shinbashi
Minato-Ku, Tokyo 105, Japan
Tel. Tokyo (03) 502-2111