

HITACHI SERVICE MANUAL

TY

No. 500 EGF

HTA-A30

(US,CS,SA,KS,VS,BS,ES,ZS,EW)

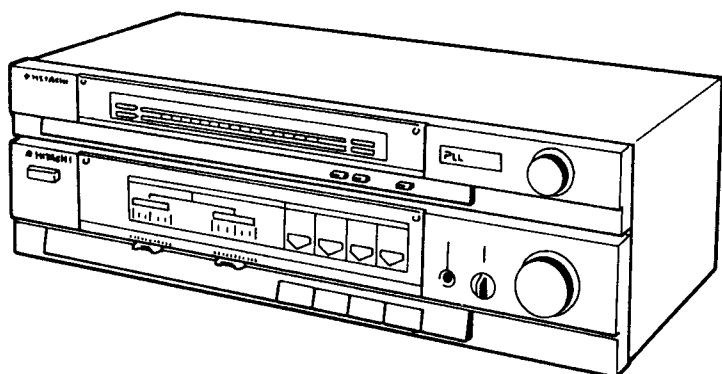

CONTENTS

CIRCUIT DIAGRAM	3, 4
PRINTED WIRING BOARD	5, 6
REPLACEMENT PARTS LIST	7

INHALTSVERZEICHNIS

SCHALTPLAN	3, 4
PRINTPLATTEN	5, 6
ERSATZTEILLISTE	7

TABLE DES MATIERES

PLAN DE CAUCUIT	3, 4
PLAN DE BASW	5, 6
TABEAU DES PIÉCES	7

This stereo tuner amplifier is the same as the model HTA-07 except that it has a appearance partly different from that model. This service manual shows the different points from HTA-07, so use together with the HTA-07/08 Service Manual (TY No. 450 EGF) issued previously.

Dieser Stereo-Tuner-Verstärker unterscheidet sich vom Modell HTA-07 nur durch ein etwas anderes Aussehen. Diese Wartungsanleitung behandelt nur solche Punkte, die sich vom Modell HTA-07 unterscheiden. Daher diese Anleitung zusammen mit der zuvor für HTA-07/08 herausgegebenen Anleitung (TY No. 450 EGF) verwenden.

Cet ampli-tuner stéréo est identique au modèle HTA-07 à l'exception des quelques différences d'aspect extérieur. Ce manuel de dépannage décrits les différences qui existent avec le modèle HTA-07 de sorte qu'il est indispensable de s'en servir avec le manuel de dépannage HTA-07/08 (TY No. 450 EGF) édité antérieurement.

SAFETY PRECAUTIONS

The following precautions should be observed when servicing.

1. Since many parts in the unit have special safety related characteristics, always use genuine Hitachi's replacement parts. Especially critical parts in the power circuit block should not be replaced with other makers. Critical parts are marked with Δ in the circuit diagram and printed wiring board.
2. Before returning a repaired unit to the customer, the service technician must thoroughly test the unit to ascertain that it is completely safe to operate without danger of electrical shock.

SPECIFICATIONS AND PARTS ARE SUBJECT TO CHANGE FOR IMPROVEMENT.

STEREO TUNER AMPLIFIER

June 1986

TOYOKAWA WORKS

SICHERHEITSMASSNAHMEN

Bei Wartungsarbeiten sind die folgenden Sicherheitsmaßnahmen zu beachten .

1. Da verschiedene Teile dieses Gerätes Sicherheitsfunktionen aufweisen, nur Original-Hitachi-Ersatzteile verwenden. Kritische Teile im Netzteil sollten nicht durch ähnliche Teile anderer Hersteller ersetzt werden. Alle kritischen Teile sind im Schaltplan und im Diagramm der Schaltplatinen mit dem Symbol Δ gekennzeichnet.
2. Vor der Auslieferung eines reparierten Gerätes an den Kunden muß der Wartungstechniker das Gerät einer gründlichen Prüfung unterziehen, um sicherzustellen, daß sicherer Betrieb ohne die Gefahr von elektrischen Schlägen gewährleistet ist.

PRÉCAUTIONS DE SÉCURITÉ

Les précautions suivantes doivent être observées chaque fois qu'une réparation doit être faite.

1. Etant donné que de nombreux composants de l'appareil possèdent des caractéristiques relatives à la sécurité, utiliser uniquement des pièces de rechange d'origine Hitachi pour effectuer un remplacement. Ceci se rapporte notamment aux pièces critiques du bloc d'alimentation qui ne doivent en aucun cas être remplacées par celles d'autres fabricants. Les pièces critiques sont accompagnés du symbole Δ dans le schéma de montage et sur le schéma de plaque de câblage.
2. Avant de retourner l'appareil répare au client le technicien doit procéder à un essai complet pour s'assurer qu'il ne présente aucun danger de chocs électriques.

The circuit symbol (☆) means difference for destination. (Refer to the table in the drawing)

Das Schaltsymbol (☆) deutet Unterscheidung gegen Bestimmungsort. (Die Tabelle inner die Zeichnung nachlesen)

Le symbole de circuit (☆) signifie qu'il s'agit des différence pour destination. (Consulter la table dans le plan)

※ : Axial lead cylindrical ceramic capacitor

※ : Zylindrischer Keramikkondensator mit axialer Zuleitung

※ : Condensateur céramique cylindrique à conducteur axial

REPLACEMENT PARTS LIST

ERSATZTEILLISTE

TABLEAU DES PIÈCES

This replacement parts list covers only different points between HTA-A30 and HTA-07.
 Diese Ersatzteilliste beinhaltet nur der Unterschieden zwischen HTA-A30 und HTA-07.
 Ce tableau des pièces traite uniquement les points des différences entre HTA-A30 et HTA-07.

SYMBOL No.	HTA-A30				HTA-07			
	PART No.	DESCRIPTION			PART No.	DESCRIPTION		
CAPACITORS								
C115	1252821	EL	10 μ F \pm 20%	50V (for ZS)	0252821	EL	10 μ F \pm 20%	50V (for ZS)
C125	0244173	CD	0.022 μ F \pm 80%	50V (for VS)		Not used.		
C154	0248050	CD	68PF \pm 5%	50V (for ES, VS, BS)	1248050	CD	68PF \pm 5%	50V (for ES, VS, BS)
C206	0252521	EL	10 μ F \pm 20%	16V (for ZS, VS)	0252521	EL	10 μ F \pm 20%	16V (for ZS)
C211	0249723	CD	470PF \pm 10%	50V (for ZS)		Not used.		
C702LR	0230620	CC	22PF \pm 5%	50V (for ZS)	0240037	CD	220PF \pm 10%	50V (for ZS)
C703LR	0240043	CC	680PF \pm 10%	50V (for ZS)	0240040	CD	390PF \pm 10%	50V (for ZS)
C726LR	0209737	CD	0.01 μ F \pm 10%	50V (for ZS)	0274013	CD	2200PF \pm 10%	50V (for ZS)
C731LR	0240044	CC	820PF \pm 10%	50V (for ZS)		Not used.		
C807	0276511	MF	0.1 μ F \pm 10%	100V	1276511	MF	0.1 μ F \pm 10%	100V
RESISTORS								
R151	0113370	CF	2.7k Ω \pm 5%	SRD1/2P	0134378	CO	2.7k Ω \pm 10%	SRD1/2P
R308	0113647	CF	22k Ω \pm 5%	SRD1/6P (for ZS, VS)	0113647	CF	22k Ω \pm 5%	SRD1/6P (for ZS)
	0113651	CF	33k Ω \pm 5%	SRD1/6P (except US, CS, ZS, VS)	0113651	CF	33k Ω \pm 5%	SRD1/6P (except US, CS, ZS)
R401LR	0113627	CF	3.3k Ω \pm 5%	SRD1/6P (for ZS)	0113615	CF	1k Ω \pm 5%	SRD1/6P
	0113615	CF	1k Ω \pm 5%	SRD1/6P (except ZS)				
R723LR	0113293	CF	330 Ω \pm 5%	SRD1/2P	0134367	CO	330 Ω \pm 10%	SRD1/2P
R725	0113371	CF	3.3k Ω \pm 5%	SRD1/2P	0134379	CO	3.3k Ω \pm 10%	SRD1/2P
IC and DIODES								
IC401	2300831	μ C PC4558C			2387301	M5218P		
D101	2337011	1S2076			2337601	1S2473		
D102	2337011	1S2076			2337601	1S2473		
D151	2337011	1S2076			2337601	1S2473		
D152	2337011	1S2076			2337601	1S2473		
D301	2337011	1S2076			2337601	1S2473		
D808	2337011	1S2076			2337601	1S2473		
D302	2398402	SLR-54DC (4)			2397064	SLH-54VC		
D806	2398402	SLR-54DC (4)			2397064	SLH-54VC		
D809	2337833	TLY-206 (for US, CS)			2337831	TLR-206 (for US, CS)		
MISCELLANEOUS								
CP201	2136313	Filter (for ZS, VS)			2136312	Anti birdie filter (for ZS)		
	2789733	FM ceramic disci ass'y [X201, MF201, MF202, MF203] (for ZS, VS)			2789733	FM ceramic disci ass'y [X201, MF201, MF202, MF203] (for ZS)		
	2789732	FM ceramic disci ass'y [X201, MF201, MF202] (except US, CS, ZS, VS)			2789732	FM ceramic disci ass'y [X201, MF201, MF202] (except US, CS, ZS)		

SYMBOL No.	HTA-A30			HTA-07	
	PART No.	DESCRIPTION		PART No.	DESCRIPTION
1	4463923	Cover		4460206	Cover ass'y
2	3201308	Front panel ass'y (for ES, VS, BS)		3969981	Front panel
	3201309	Front panel ass'y (except ES, VS, BS)		3904711	Blind (A)
				3975031	Blind (T) (for ES, VS, BS)
			3975032	Blind (T) (except ES, VS, BS)	
6	3307011	Button (CD/AUX)		3305061	Button (CD/AUX)
7	3307012	Button (TUNER)		3305062	Button (TUNER)
8	3307013	Button (PHONO)		3305063	Button (PHONO)
9	3307014	Button (TAPE MONITOR)		3305064	Button (TAPE)
10	3307031	Knob ass'y (tuning)		3305082	Knob (24) (for US, CS)
				3305081	Knob (24) (except US, CS)
11	3307023	Knob ass'y (volume)		3301932	Volume (35) (for US, CS)
				3301931	Volume (35) (except US, CS)
13	3305074	Slide knob (tone control)		3305072	Slide volume
14	3305042	Push button (mode select, band select)		3305043	Push button
	3305052	Remote shaft		3305051	Shaft
15	3297795	Power button		3297792	Power button ass'y
				3387641	Pointer case (except US, CS)
	3387642	Pointer case (except US, CS)			
17	4468381	Rear plate (for ES, VS, KS, BS, SA)		4462211	Rear plate (for ES, VS, KS)
	4468382	Rear plate (for EW)		4462212	Rear plate (for BS, SA)
	4468383	Rear plate (for US, CS)		4465044	Rear plate (for EW)
	4468384	Rear plate (for ZS)		4463187	Rear plate (for ZS)
				4462215	Rear plate (for US)
				4463189	Rear plate (for CS)
18	0043793	Bushing (for EW)		0043793	Bushing (3P-4) (for US, EW)
	3913006	Bushing (except EW)		3713006	Bushing (4N-4) (except US, EW)
19	2702711	AC cord (for US, CS)		2700121	AC cord (for US)
				2700122	AC cord (for CS)
21	2658391	DIN antenna socket (for ZS)		2677911	FM antenna socket (for ZS)
	2677911	FM antenna socket (except US, CS, ZS)			Not used.
	2727671	Fuse holder (for EW)			Not used.
25, 26	2678621	AC jack (for US, CS, EW)		2678621	AC jack
	2658711	Power jack (except US, CS, EW)			
	3920661	Cap			Not used.
for ACCESSORIES					
	2757528	FM antenna (except ZS)		2757525	FM antenna (except ZS)

CIRCUIT DIAGRAM · SCHALTPLAN · PLAN DE CIRCUIT

SIGNAL CURRENT
 [➡ : FM, ⇄ : AM]

☆ No.	US. CS	KS. SA	EW	ES. VS
C125				0.022 (VS on)
C206				10 (VS on)
C210	0.01			
C211				
C303L,R	820P	330P		
C306L,R				
C313				
C401L,R				
C409	0.01			
C410				
C411				
C420L,R				
C421L,R				
C702L,R	150P			
C703L,R	560P			

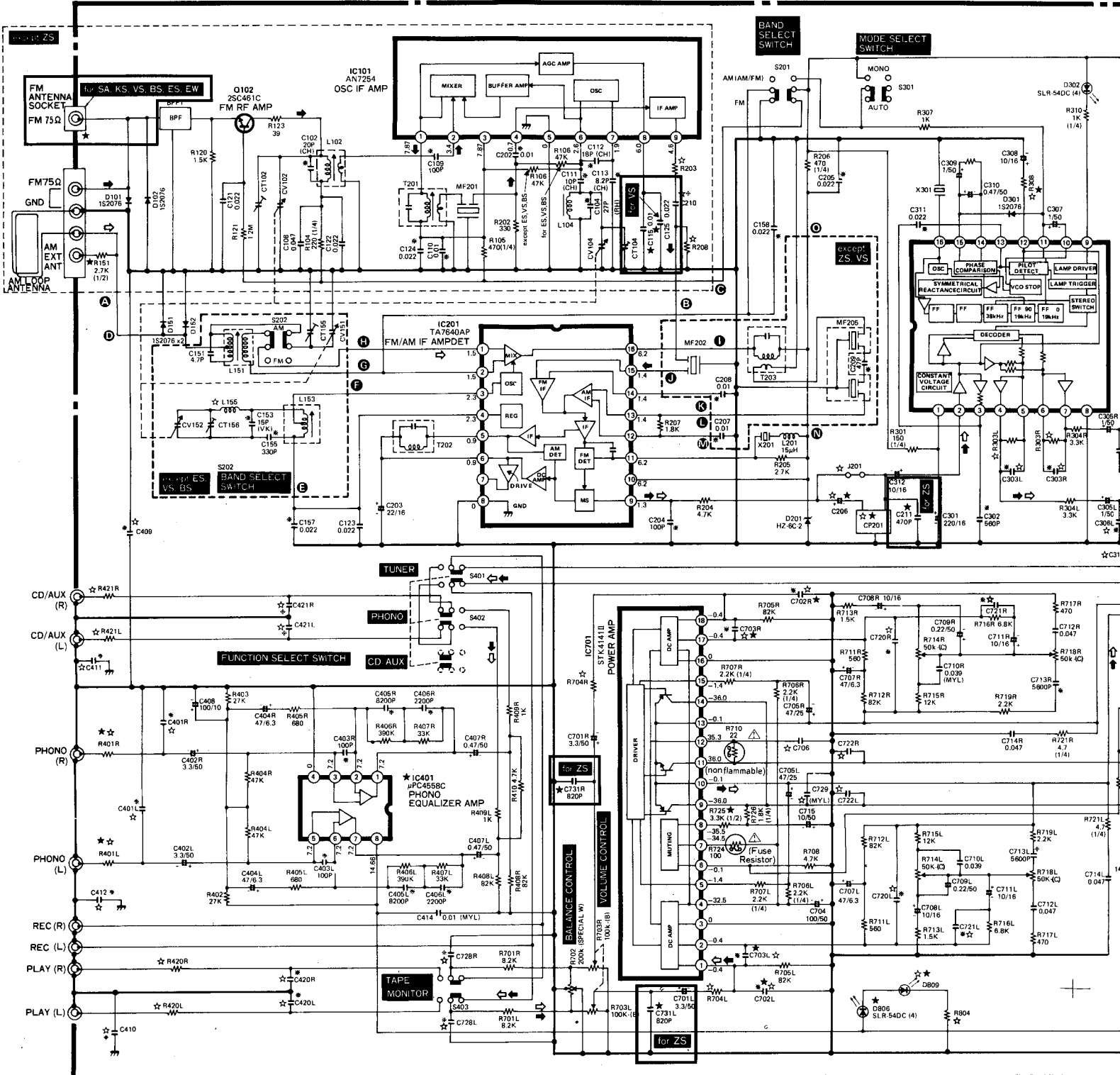
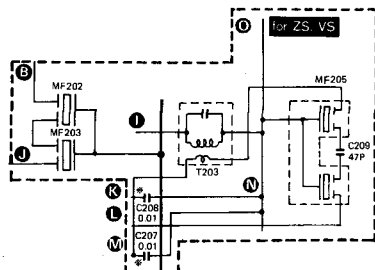
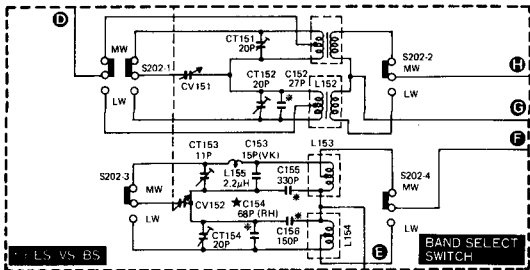

AL CURRENT
: FM, ⇨ : AM]

★ : THE DIFFERENT POINTS BETWEEN HTA-A30 AND HTA-07.
★ : DER UNTERSCHIEDEN ZWISCHEN HTA-A30 UND HTA-07.
★ : LES POINTS DES DIFFÉRENCE ENTRE HTA-A30 ET HTA-07.

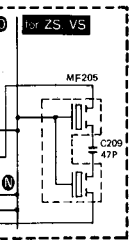

★ No.	US, CS	KS, SA	EW	ES, VS, BS	ZS
C125				0.022 [VS only]	
C206				10 [VS only]	10
C210	0.01				
C211					470P
C303L,R	820P	330P			
C306L,R					1000P
C313					0.01
C401L,R					1000P
C409	0.01				
C410					0.01
C411					0.01
C412					0.01
C420L,R					1000P
C431L,R					1000P
C702L,R	150P				22P
C703L,R	560P				680

★ No.	US, CS	KS, SA	EW	ES, VS, BS	ZS
C706	0.22				
C720L,R	22P				68P
C721L,R	68P				
C722L,R					0.01
C724L,R					0.01
C726L,R					0.01
C727					0.01
C728L,R	470P				1000P
C729	0.22				
C731L					820P
R203	680	100			
R208	680				
R303L,R	82K	150K			
R308	68K			33K [ES, BS] 22K [VS]	22K
R401L,R	1K				3.3K
R420L,R					680

★ No.	US, CS	KS, SA	EW	ES, VS, BS	ZS
R421L,R					680
R704L,R	4.7K				2.2K
R804	1.8K	2.2K			
D808	Use				
L155	2.2μH				0.22μH
CP201					Use
FO01	T2.5A-125V	T1A-250V			
FO02	T2A-125V	T2A			
J201	Use	Use			Use

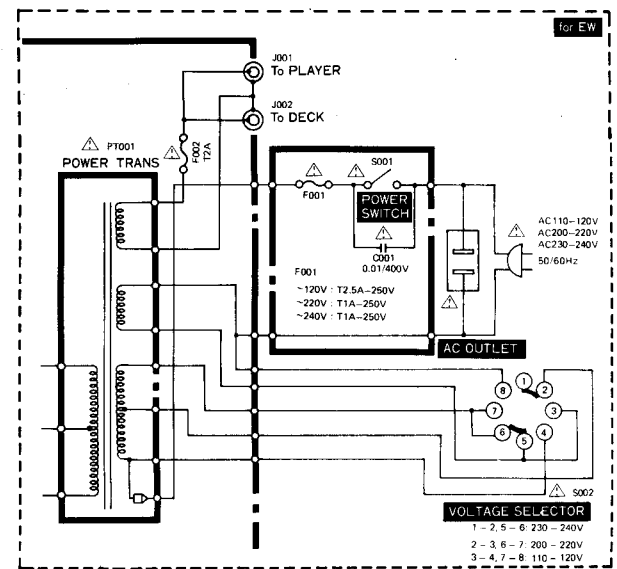
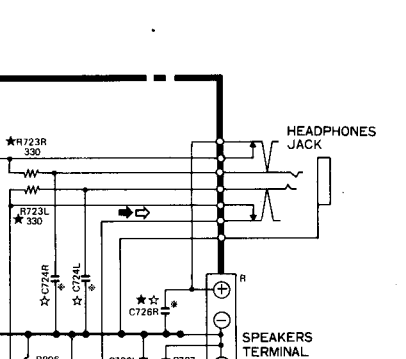
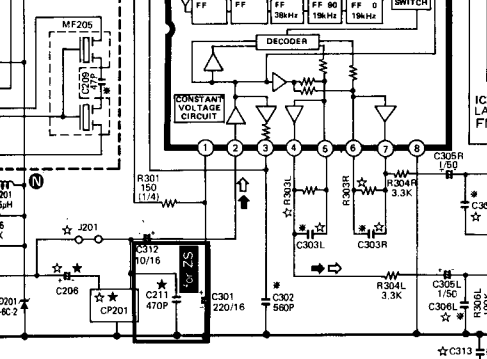
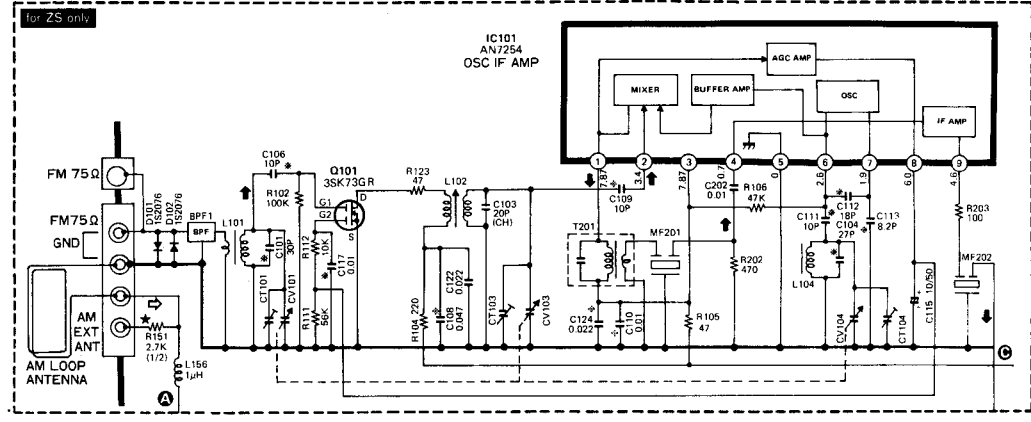
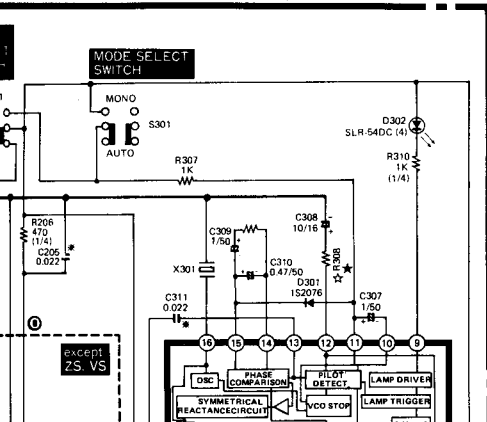

Pin No.	FM	AM
1	13.9	
2	3.1	
3	3.2	
4	2.8	
5	3.1	
6	3.1	
7	2.7	
8	0	
9	13.4	
10	2.3	3.1
11	10.5	3.0
12	3.1	
13	6.7	3.0
14	3.1	
15	9.9	3.0
16	2.2	3.4

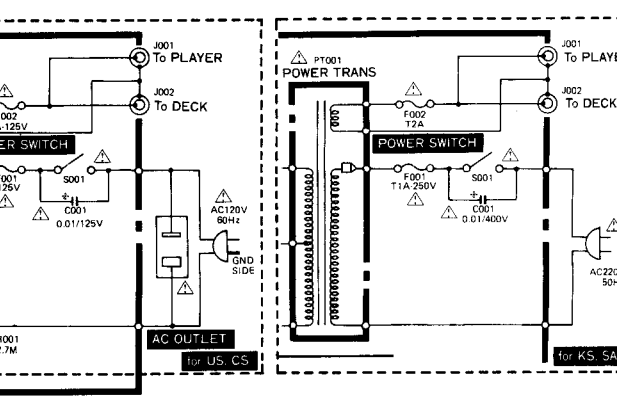
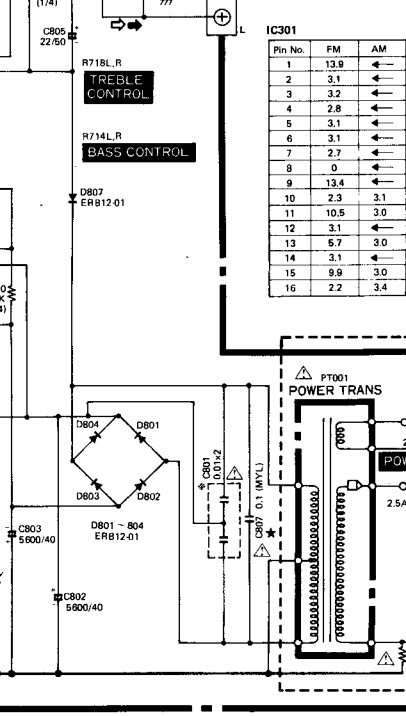
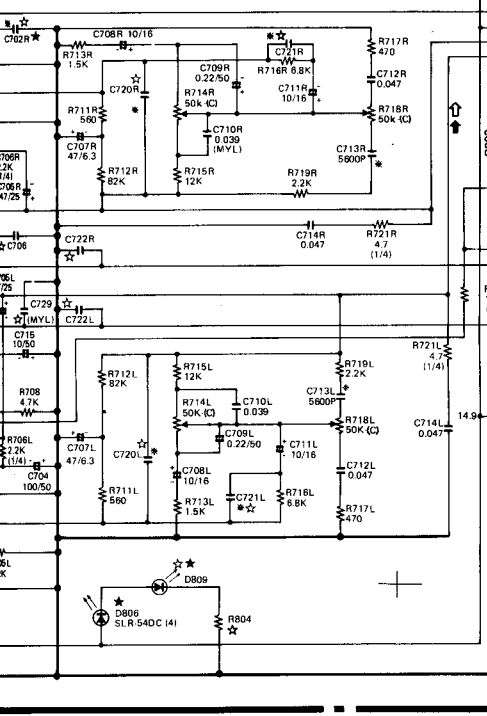

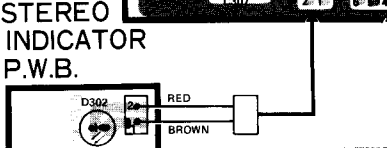
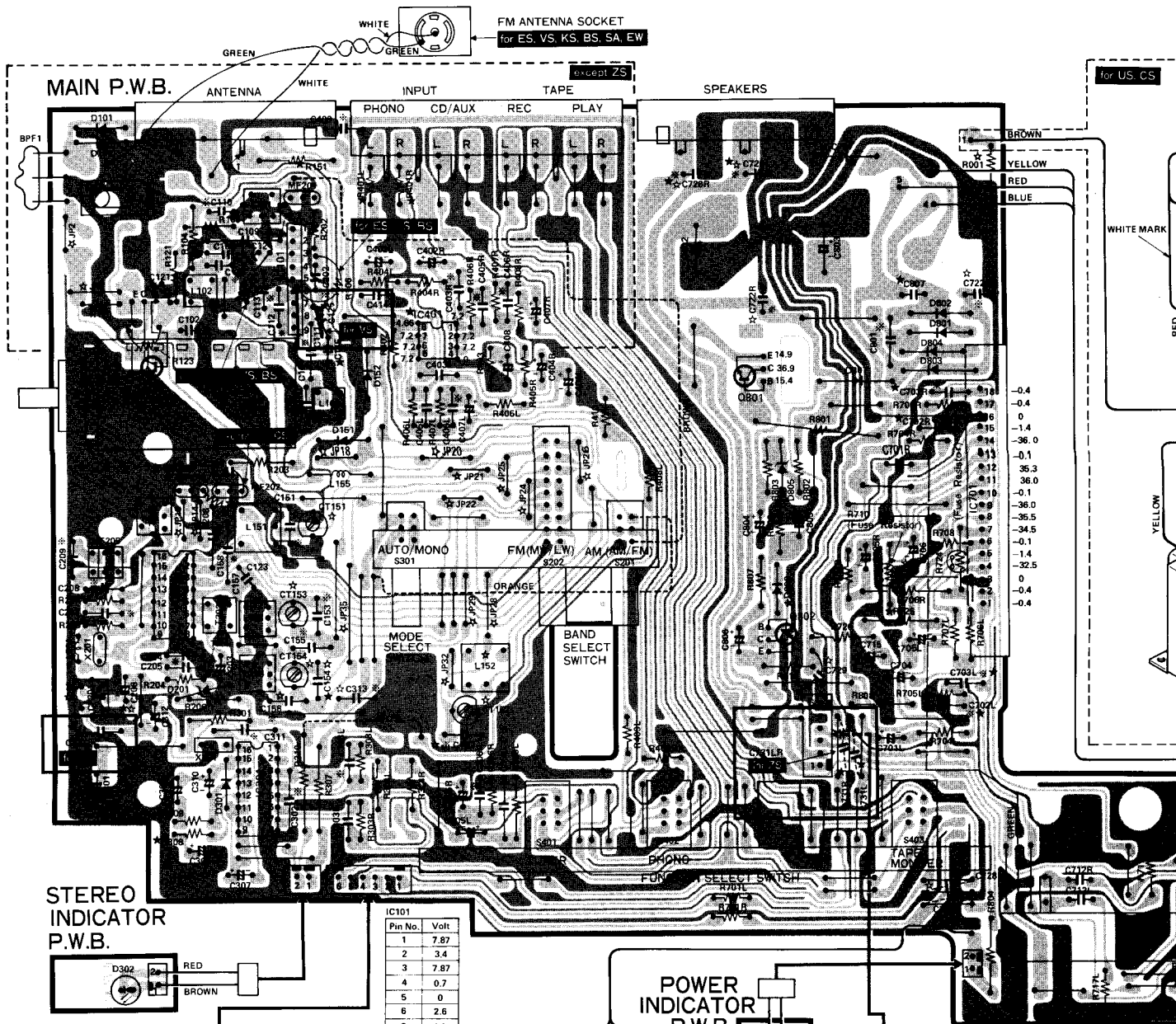

Pin No.	Volt
1	7.87
2	3.4
3	7.87
4	0.7
5	0
6	2.6
7	1.9
8	6.0
9	4.6

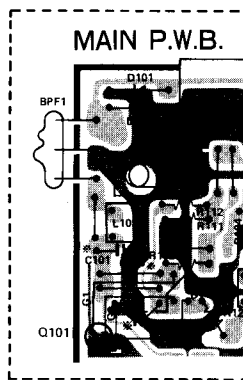
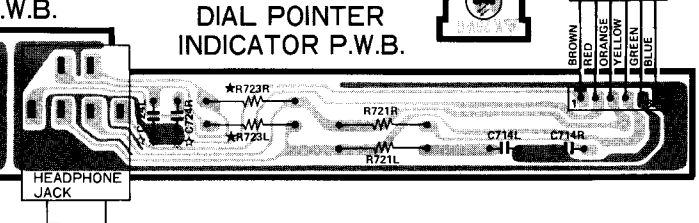
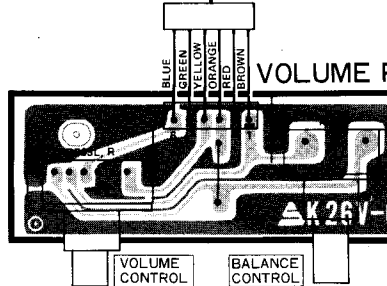
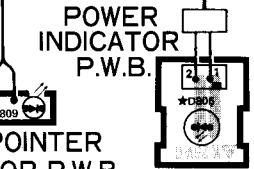

★ No.	US, CS	KS, SA	EW	ES, VS, BS	ZS
C125	Use	←	←	Use (VS only)	Use
C151	Use	←	←	Use	Use
C152	Use	←	←	Use	Use
C154	Use	←	←	Use	Use
C156	Use	←	←	Use	Use
C206	Use	←	←	Use	Use
C210	Use	←	←	Use	Use
C211	Use	←	←	Use	Use
C306L,R	Use	←	←	Use	Use
C313	Use	←	←	Use	Use
C706	Use	←	←	Use	Use
C721L,R	Use	←	←	Use	Use
C722L,R	Use	←	←	Use	Use
C724L,R	Use	←	←	Use	Use
C726L,R	Use	←	←	Use	Use
C727	Use	←	←	Use	Use
C728L,R	Use	←	←	Use	Use
C731L,R	Use	←	←	Use	Use

★ No.	US, CS	KS, SA	EW	ES, VS, BS	ZS
C729	Use	←	←	Use	Use
R001	Use	←	←	Use	Use
R208	Use	←	←	Use	Use
D809	Use	←	←	Use	Use
L152	Use	←	←	Use	Use
L154	Use	←	←	Use	Use
CT151	Use	←	←	Use	Use
CT152	Use	←	←	Use	Use
CT153	Use	←	←	Use	Use
CT154	Use	←	←	Use	Use
CP201	Use	←	←	Use	Use
MF202	Use	←	←	Use	Use
MF203	Use	←	←	Use	Use
JP2	Use	←	←	Use	Use

★ No.	US, CS	KS, SA	EW	ES, VS, BS	ZS
JP3	Use	←	←	Use	Use
JP13	Use	←	←	Use	Use
JP14	Use	←	←	Use	Use
JP18	Use	←	←	Use	Use
JP20	Use	←	←	Use	Use
JP21	Use	←	←	Use	Use
JP22	Use	←	←	Use	Use
JP24	Use	←	←	Use	Use
JP25	Use	←	←	Use	Use
JP26	Use	←	←	Use	Use
JP28	Use	←	←	Use	Use
JP29	Use	←	←	Use	Use
JP32	Use	←	←	Use	Use
JP35	Use	←	←	Use	Use

- ★ : THE DIFFERENT POINTS BETWEEN HTA-A30 AND HTA-07.
- ★ : DER UNTERSCHIEDEN ZWISCHEN HTA-A30 UND HTA-07.
- ★ : LES POINTS DES DIFFÉRENCE ENTRE HTA-A30 ET HTA-07.

Earth, [] :Others]

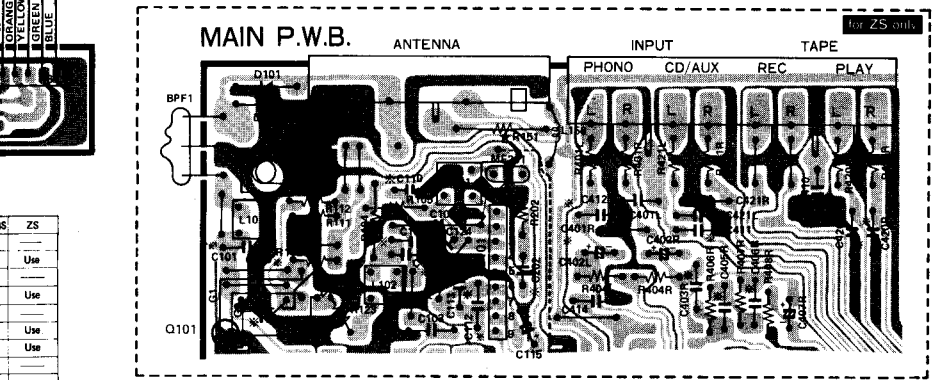
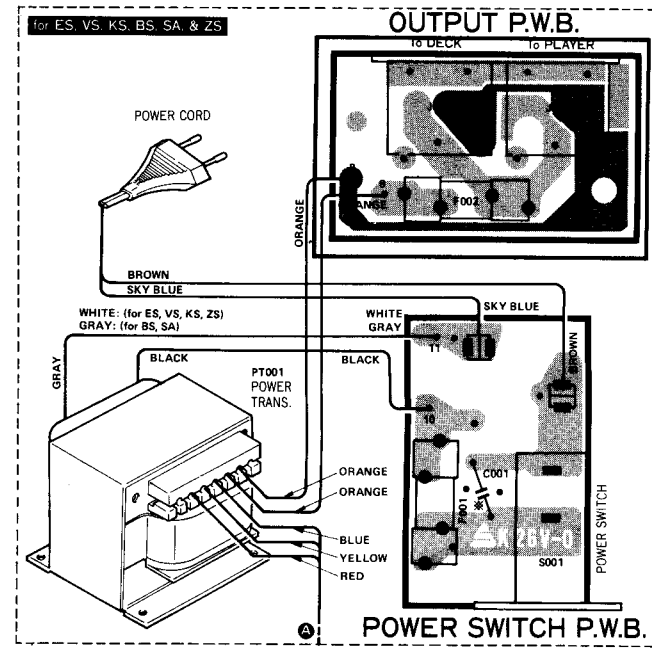
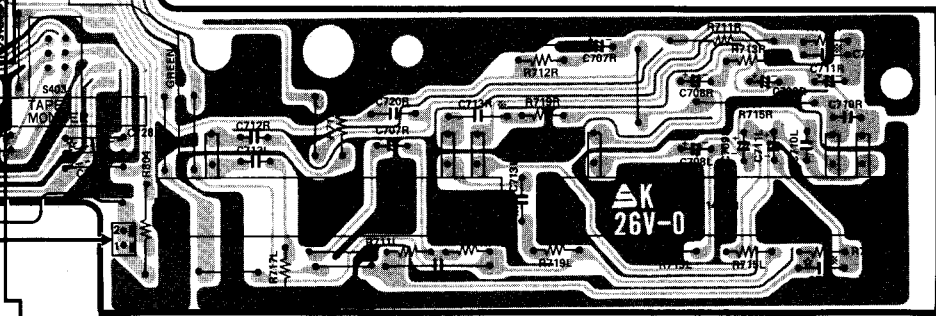
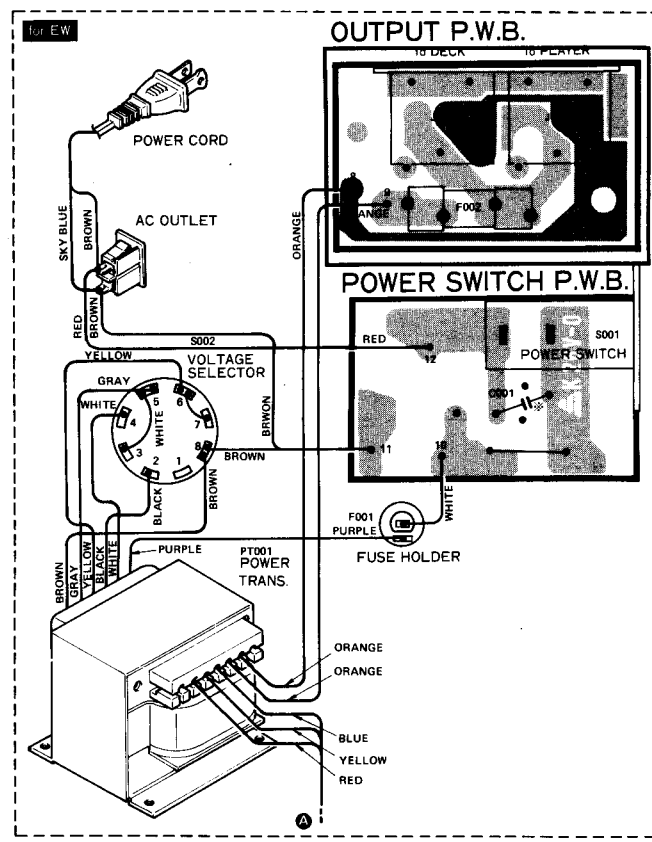
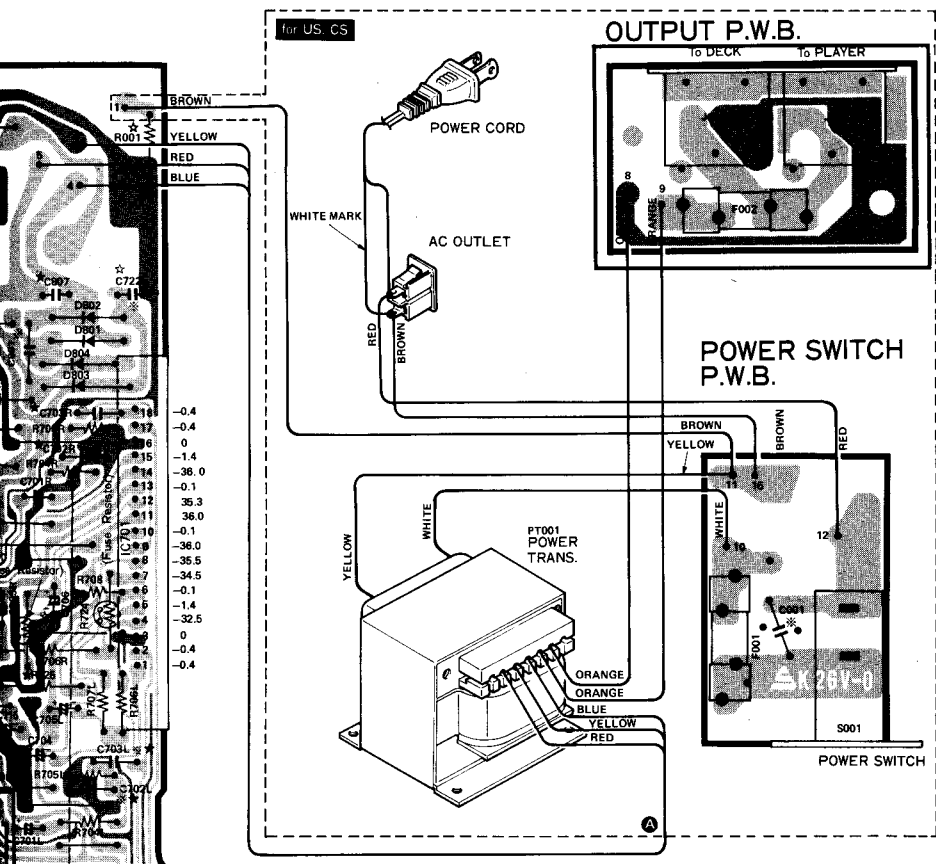

IC201

Pin No.	Volt	Pin No.	Volt
1	1.5	11	6.2
2	1.5	12	—
3	2.3	13	1.4
4	2.3	14	1.4
5	0.9	15	1.4
6	0.9	16	6.2
7	—	—	—
8	0	—	—
9	1.3	—	—
10	6.2	—	—

IC301

Pin No.	FM	AM	Pin No.	FM	AM
1	13.9	←	11	10.5	3.0
2	3.1	←	12	3.1	←
3	3.2	←	13	5.7	3.0
4	2.8	←	14	3.1	←
5	3.1	←	15	9.9	3.0
6	3.1	←	16	2.2	3.4
7	2.7	←	—	—	—
8	0	←	—	—	—
9	13.4	←	—	—	—
10	2.3	3.1	—	—	—

Color	Use
ORANGE	Use
YELLOW	Use
GREEN	Use
BLUE	Use

**HITACHI SALES EUROPA GmbH**

Postfach 801060 Rungedamm 2, 2050 Hamburg 80,
West Germany
Tel. 040-734 11-0

HITACHI SALES (U.K.) Ltd.

Hitachi House, Station Road, Hayes, Middlesex UB3
4DR, England
Tel. 01-848-8787

HITACHI SALES SCANDINAVIA AB

Rissneleden 8, Box 7138, 172-07 Sundbyberg, Sweden
Tel. 08-98 52 80

HITACHI SALES NORWAY A/S

Oerebekk 1620, Gressvik, P.O. Box 46, N-1601,
Fredrikstad, Norway
Tel. 032-28255

SUOMEN HITACHI OY

Takojankatsu 5, 15800 Lahti 80, Finland
Tel. Lahti 44 241

HITACHI SALES A/S

Kuldysen 13, DK-2630, Taastrup, Denmark
Tel. 02-999200

HITACHI SALES A.G.

Bahnhofstrasse, 19, 5600 Lenzburg, Switzerland
Tel. 064-513621

HITACHI SALES WARENHANDELS GMBH

A-1180/Wien, Kreuzgasse 27, Austria
Tel. 0222-439367

HITACHI SALES ITALIANA, S.P.A.

Via Cristoford Colombo 49, Trezzano sul naviglio
(Milano), Italy
Tel. 02-44 59 031

HITACHI SALES BELGIUM S.A.

56 Chaussee de Namur B-1400 Nivelles, Belgium
Tel. (003267) 227181

HITACHI SALES IBERICA, S.A.

Gran Via Carios Tercero, 101, 1-1, Barcelona-28,
Spain
Tel. 330-8652

HITACHI MAROC (RADIO TV ELECTRO-MANAGER), S.A.

Rue du Havre, Casablanca, Morocco
Tel. 30-73-68, 30-73-57

HITACHI CANARIAS S.A.

Calle San-Francisco No. 19, Santa Cruz de Tenerife
Canary Islands
Tel. 24-64-98

HITACHI SALES (HELLAS) LTD.

110 Syngrou St., Athens, Greece
Tel. 9219082, 9233469

HITACHI SALES (MALAYSIA) SDN. BHD.

17, Jalan 20/16, Petaling Jaya, Selangor, Malaysia
Tel. 762523, 769918, 769836, 762594

HITACHI (SINGAPORE) PTE., LTD.

Room B, C & D, 15th Floor, Yen San Building
268 Orchard Road, Singapore 9, Singapore
Tel. 7378244, 7379826

HITACHI SALES (THAILAND) LTD.

2242-48, New Petchburi Road, Bangkok, Hueykuang
Bangkok, Thailand
Tel. 314-2741

HITACHI ELECTRIC SERVICE CO., (HONG KONG) LTD.

4th Floor Leun Tai Industrial Bldg., 72-76 Kwai Cheong
Road Kwai Chung N.T., Hong Kong
Tel. 240126

HITACHI SALES AUSTRALIA PTY LTD.

153 Keys Road, Moorabbin, Victoria 3189 Australia
Tel. 555-8722

HITACHI SALES CORPORATION OF AMERICA

Eastern Regional Office
1290 Wall Street West, Lyndhurst, New Jersey 07071, U.S.A.
Tel. 201-935-8980

Mid-Western Regional Office

1400 Morse Ave., Elk Grove Village, Ill. 60007, U.S.A.
Tel. 312-593-1550

Southern Regional Office

510 Plaza Drive, College Park, Georgia 30349, U.S.A.
Tel. 404-763-0360

Western Regional Office

401 West Artesia Boulevard, Compton, California 90220 U.S.A.
Tel. 213-537-8383

HITACHI SALES CORPORATION OF HAWAII, INC.

3219 Koapaka Street, Honolulu, Hawaii 96819, U.S.A.
Tel. 808-836-3621

HITACHI (HSC) CANADA INC.

3300 Trans-Canada Highway, Pointe Claire, Quebec,
H9R 1B1, Canada
Tel. 514-697-9150

Hitachi Sales Centroamericans, S.A.

San Rafael de Excazu, (Apartado 10272), San Jose,
Costa Rica
Tel. 28-20-11, 28-00-37

Hitachi Sales Corporation de Panama, S.A.

Nuevo Repato E1 Camen, Calle Ramon Arias y Calle B
Edificio Brasil 100, (Apartado 7657) Panama 5
Panama City, Rep of Panama
Tel. 61-3100, 61-4305

Hitachi Sales de Chile Cia., Ltda.

Av. Mexico, 0183, Casilla 9793, Correo Central
Santiago, Chile
Tel. 774165

HITACHI-FRANCE S.A.

95-101 Rue Charles Michels,
93200 SAINT-DENIS,
France
Tel. 1-4821-6015

HITACHI LTD. TOKYO JAPAN

Head Office: THE HITACHI ATAGO BLDG.
No. 15-12, 2-Chome Nishi-Shinbashi
Minato-Ku, Tokyo 105, Japan
Tel. Tokyo (03) 502-2111

HTA-A30 TY No. 500 EGF