

ET94
ET93

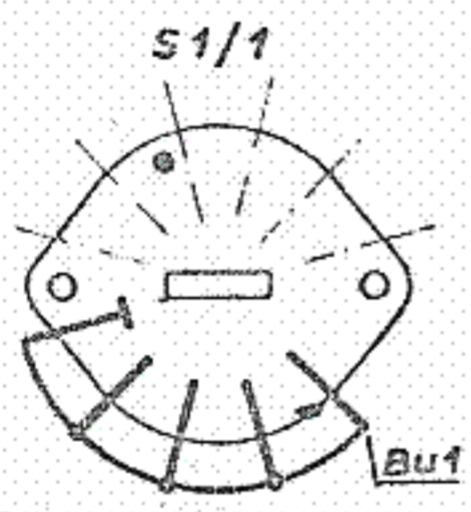

Außenseiten der Schaltebenen nach Montage im HF-Baustein

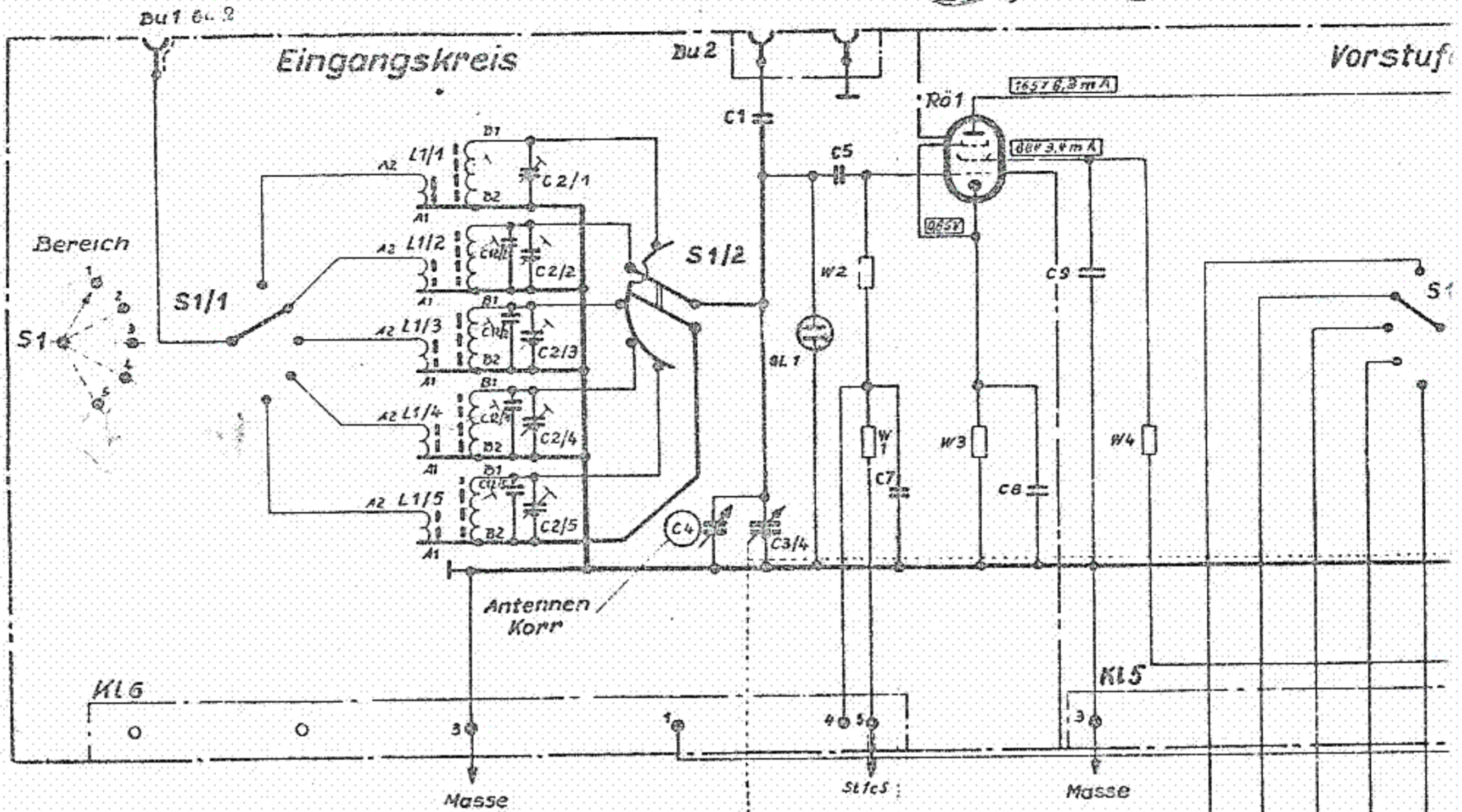
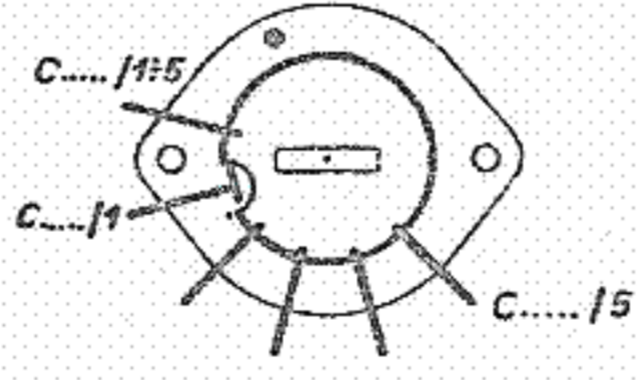
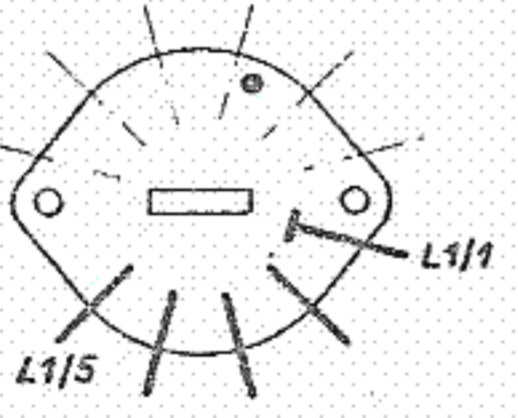
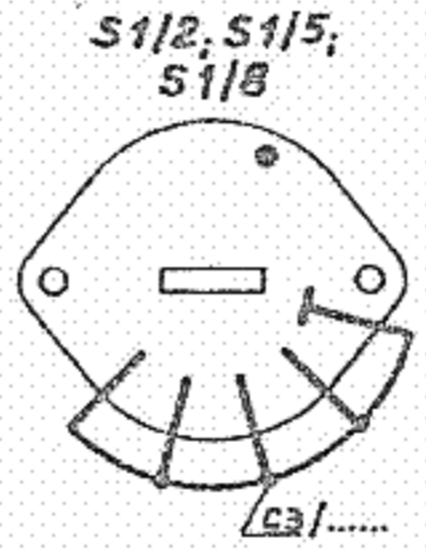

Innenseiten der Schaltebenen nach Montage im HF-Baustein.

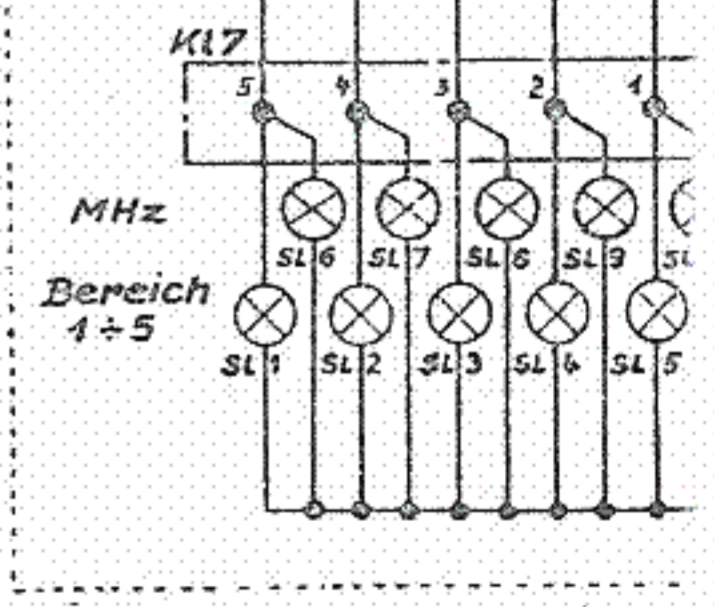

Vorstufe

Mischstufe

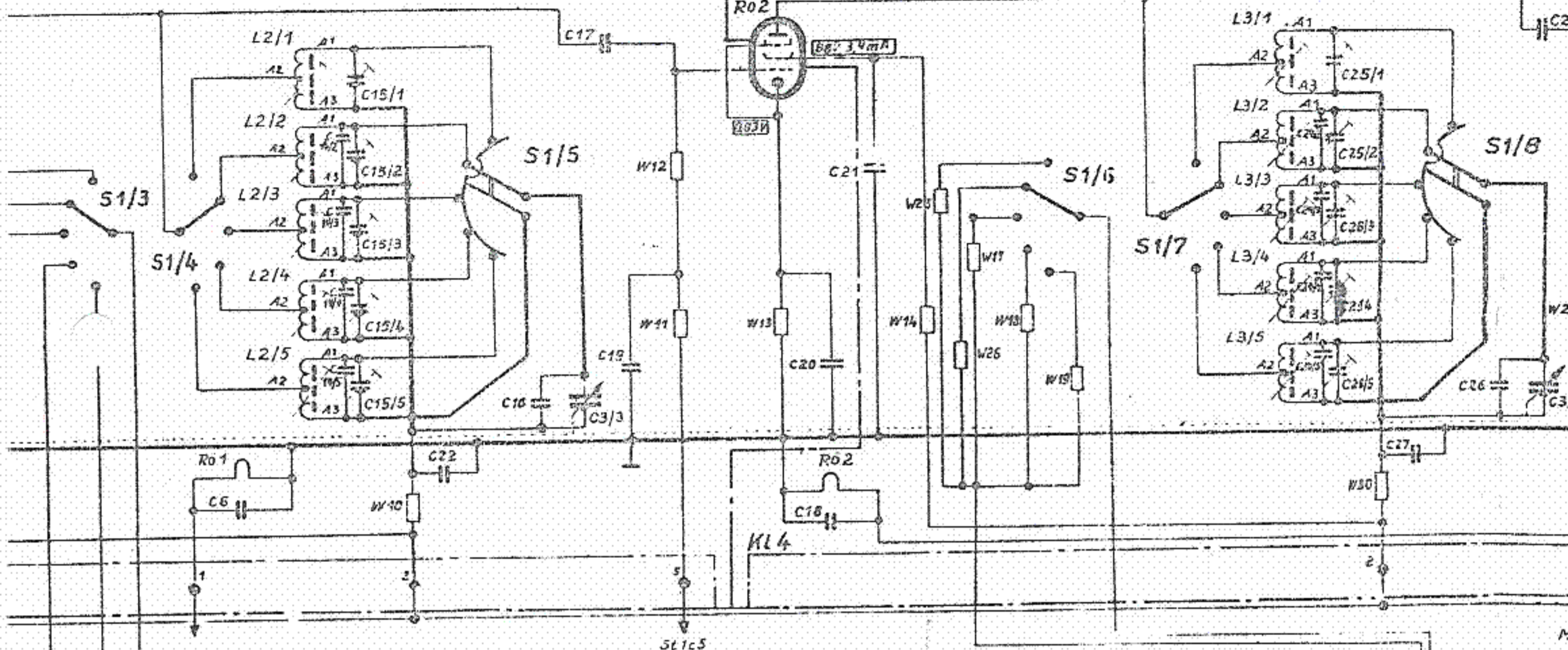

Oszillator- u. Trennstufe

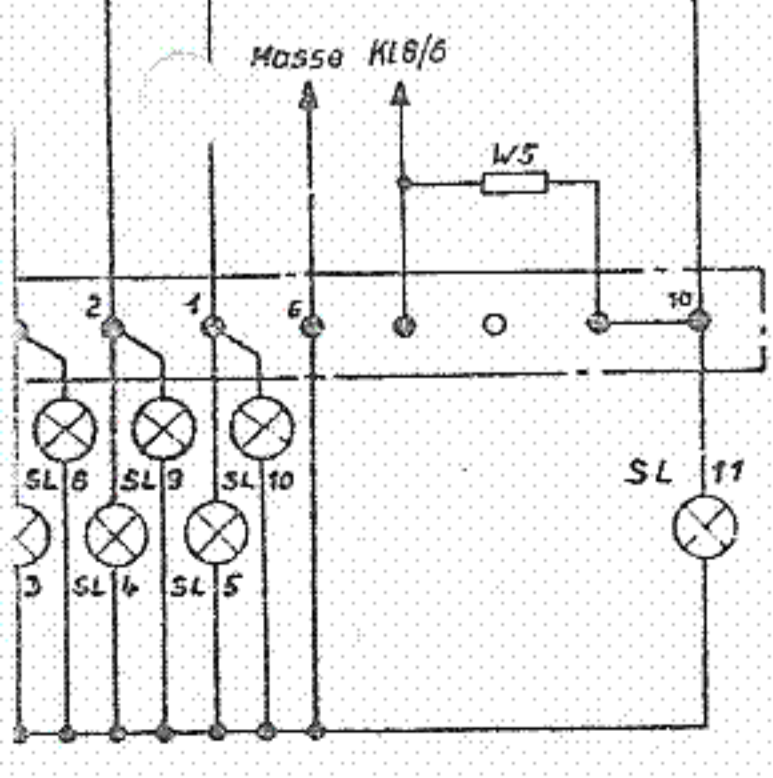
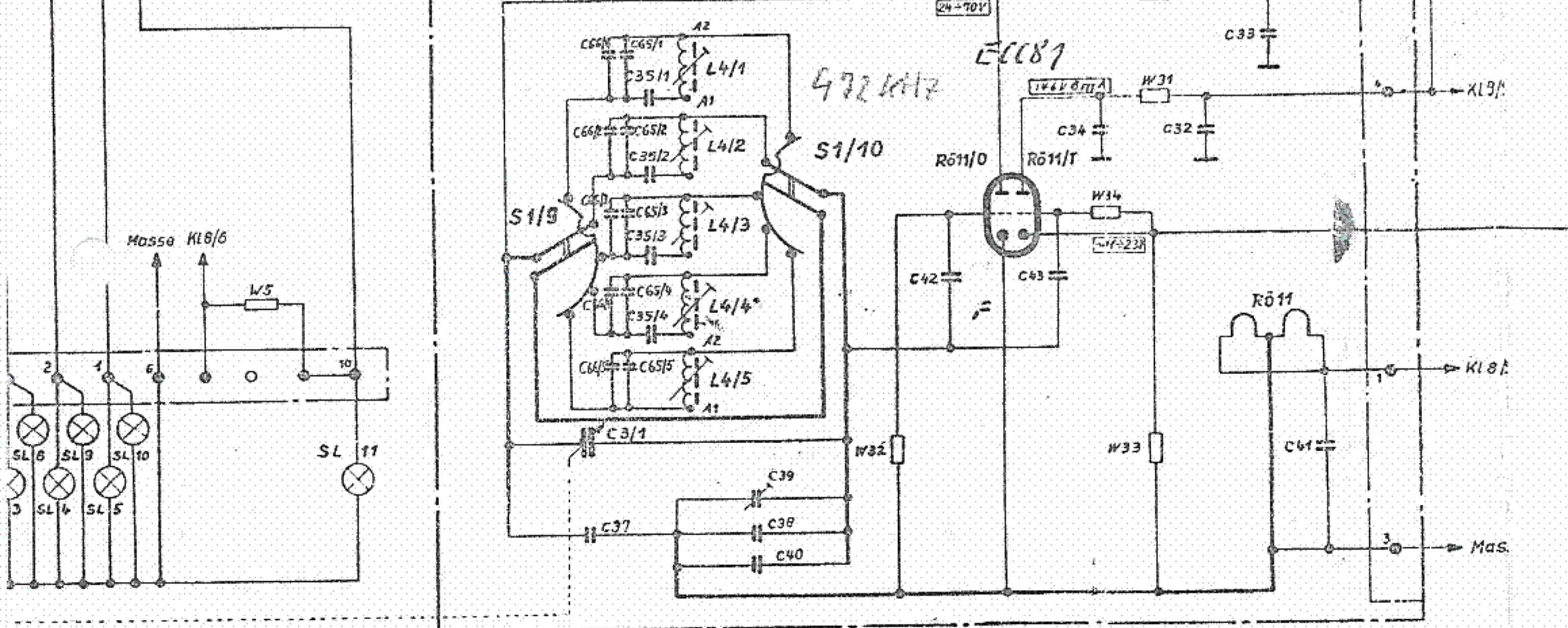

EF94

EF93

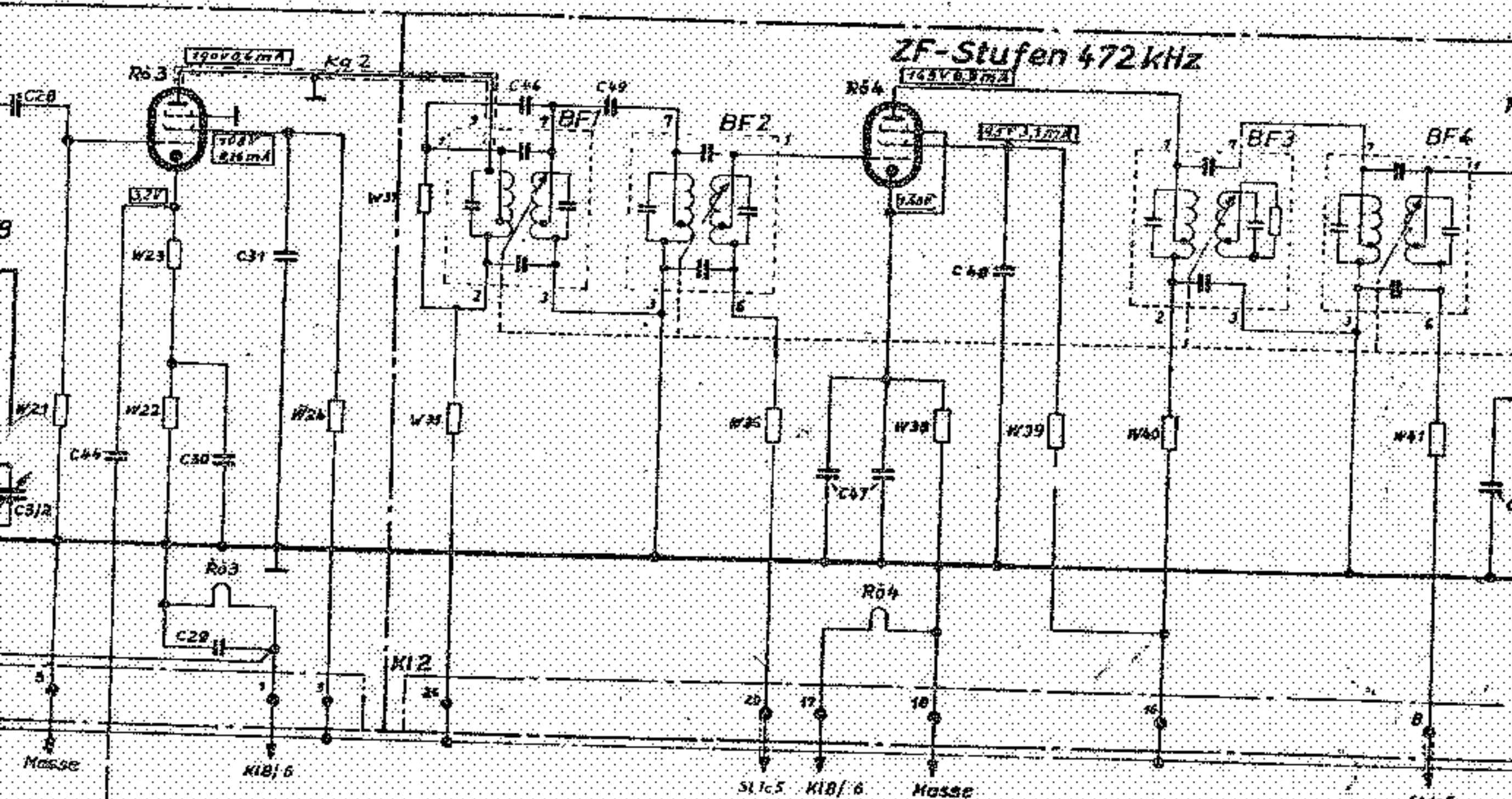

ZF-Stufen 472 kHz

S1/3 u. S1/6

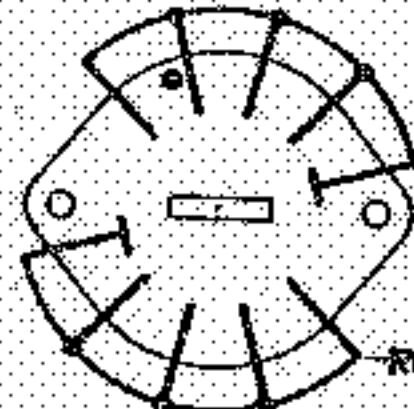

S1/9

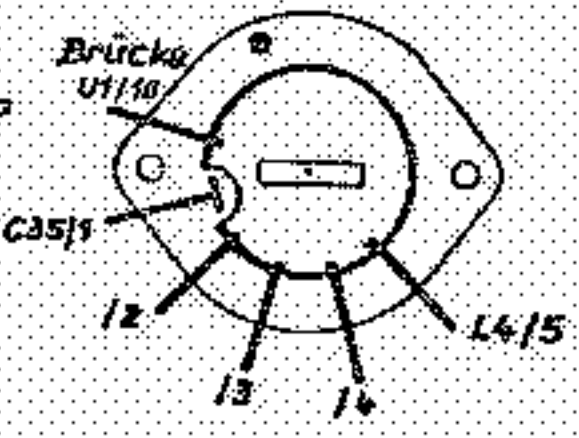

S1/10

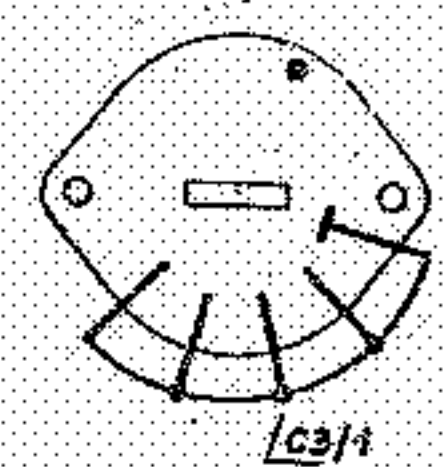

Außenseiten der Schaltebenen nach Montage im HF-Baustein

K17/3 bzw. W47 K17/4 bzw. W18

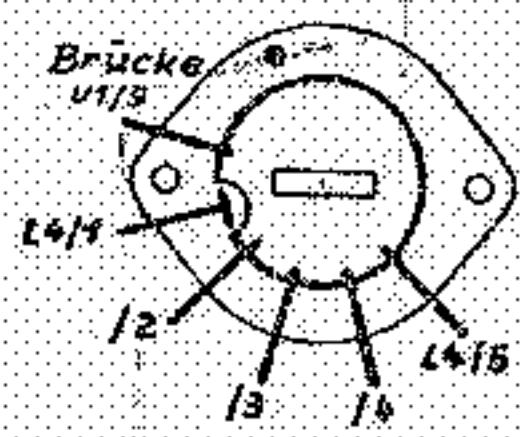
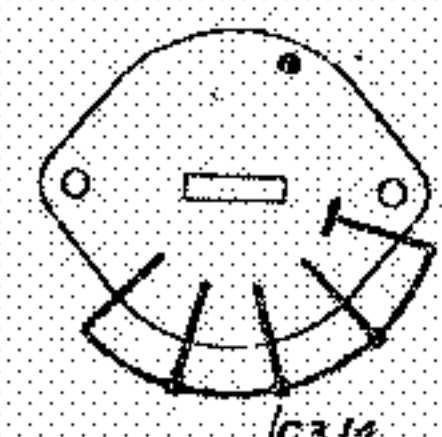
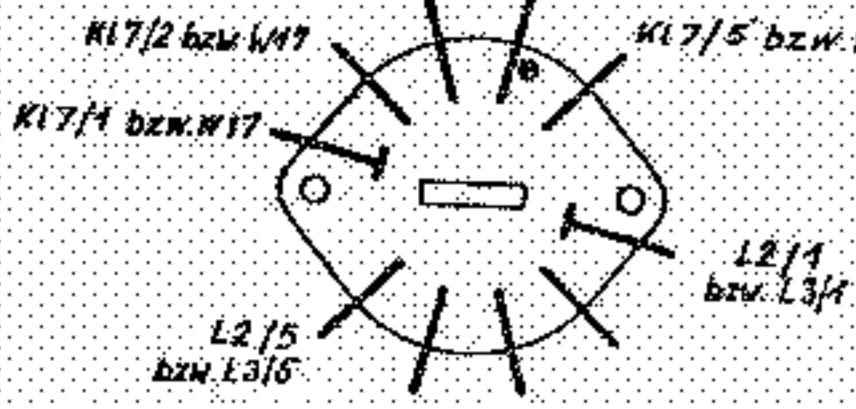

Innenseiten der Schaltebenen nach Montage im HF-Baustein

EF93

EF93

Zümm Umschalter

EF93

Regelverstärker

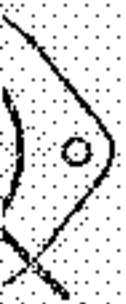
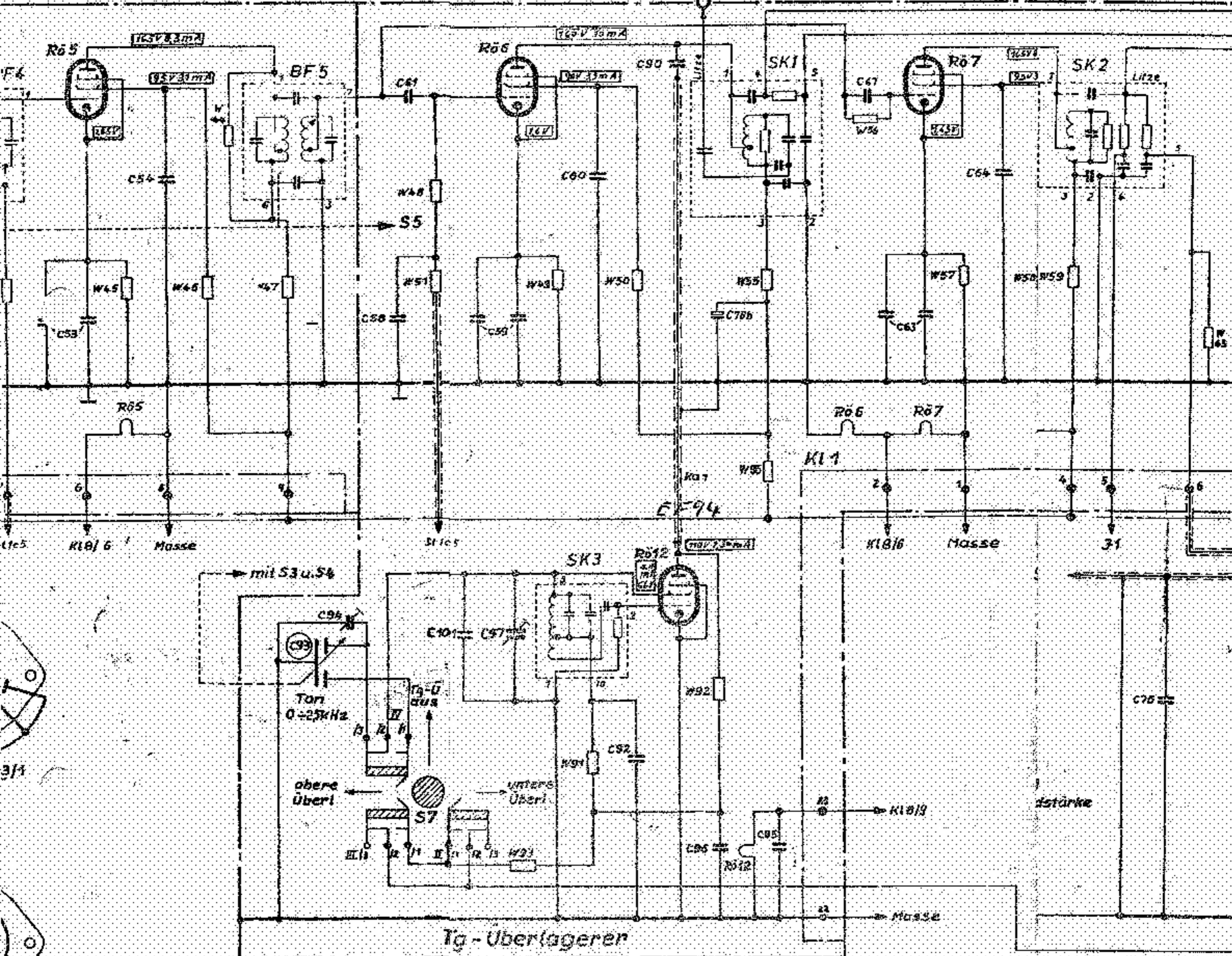

mit S3 u. S4

Tor1
Q=25kHz

obere Überl.

untere Überl.

Tg-Überlagerer

istärke

Demodulator u. NF-Stufe

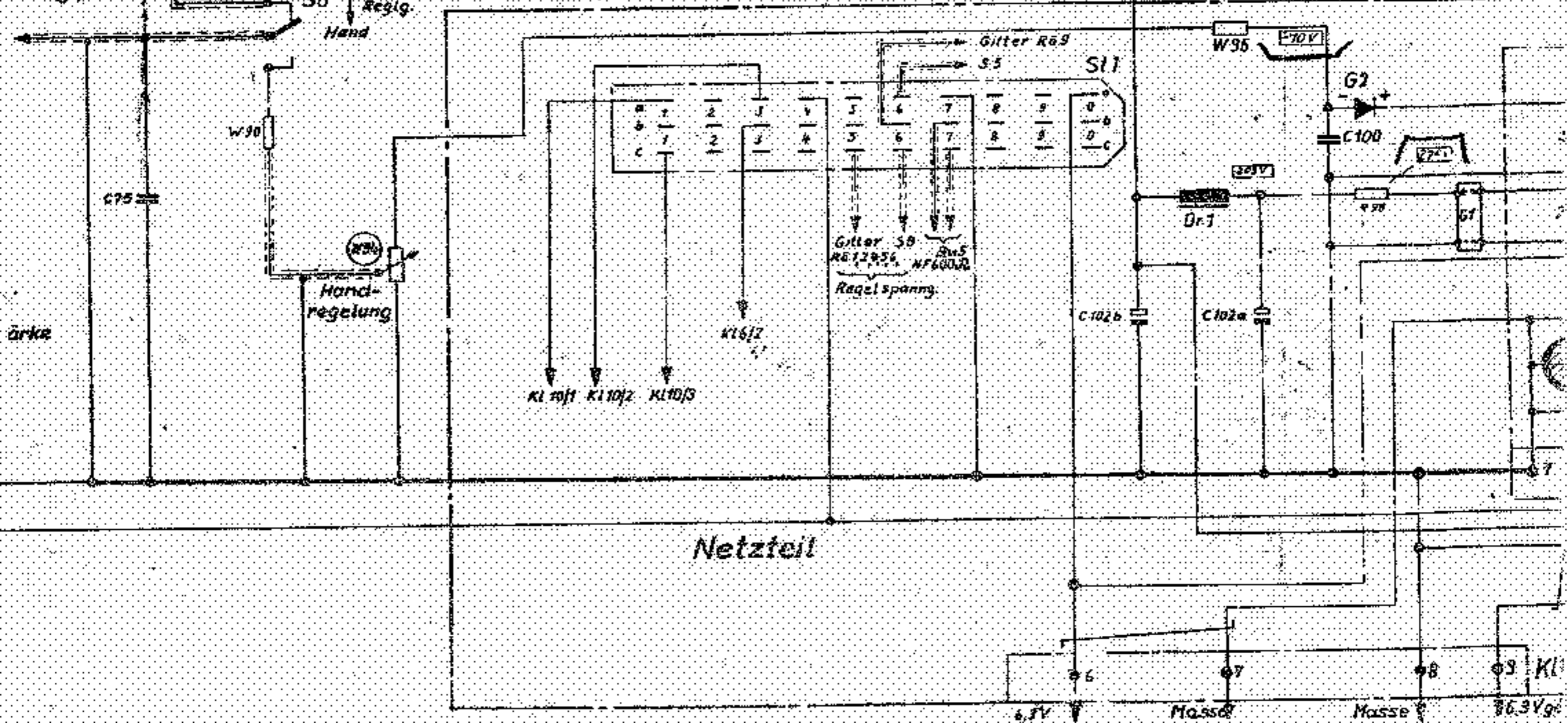
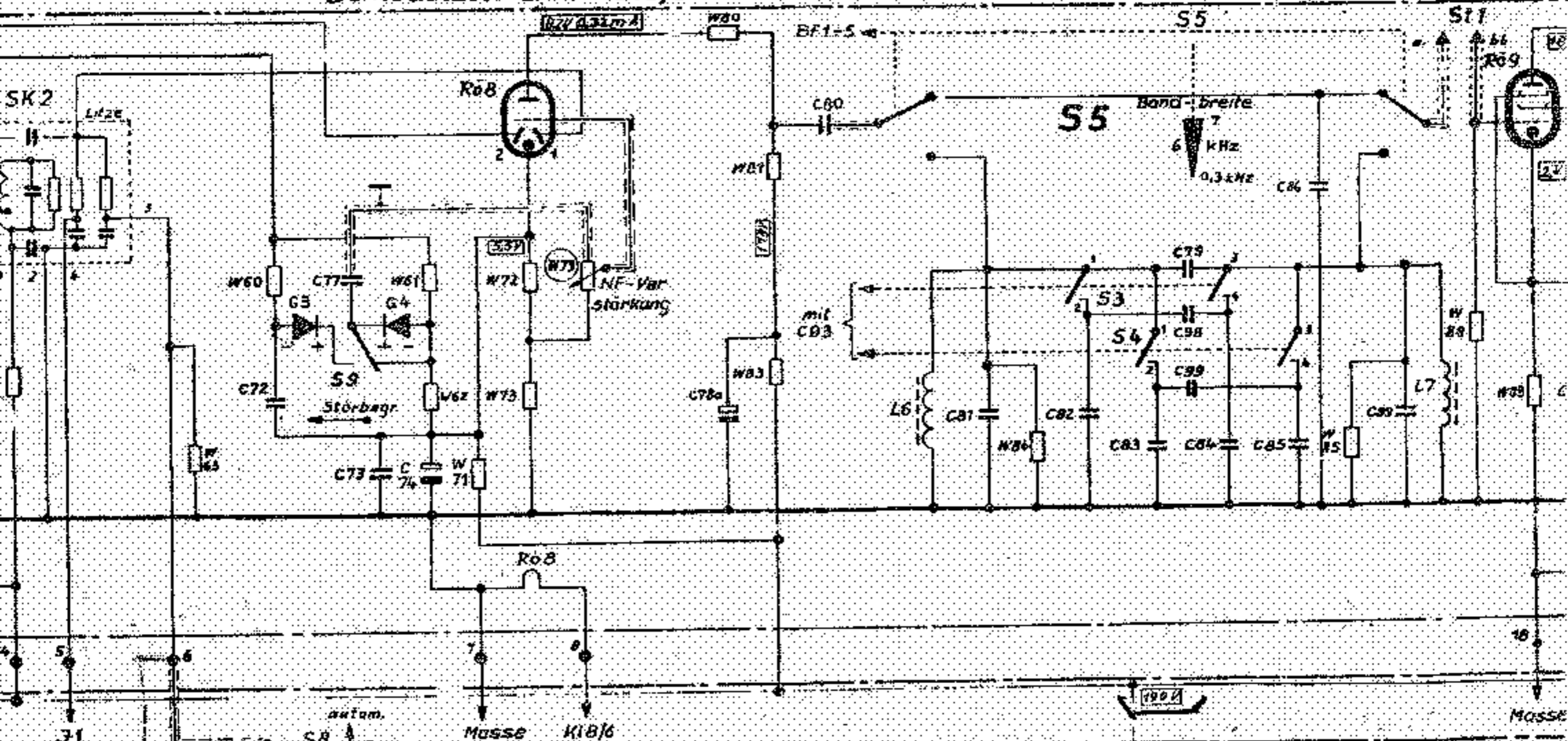

EF 94

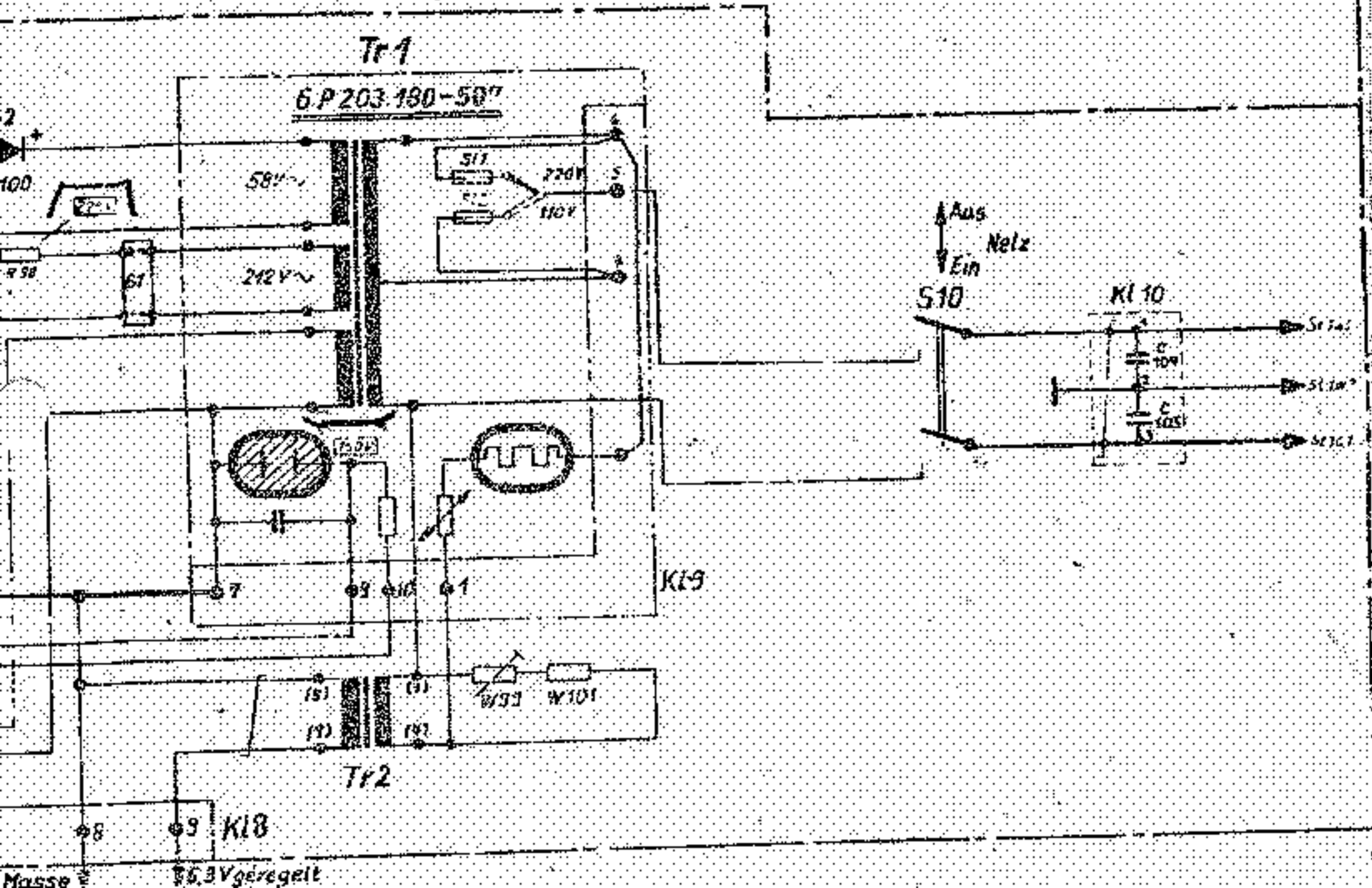
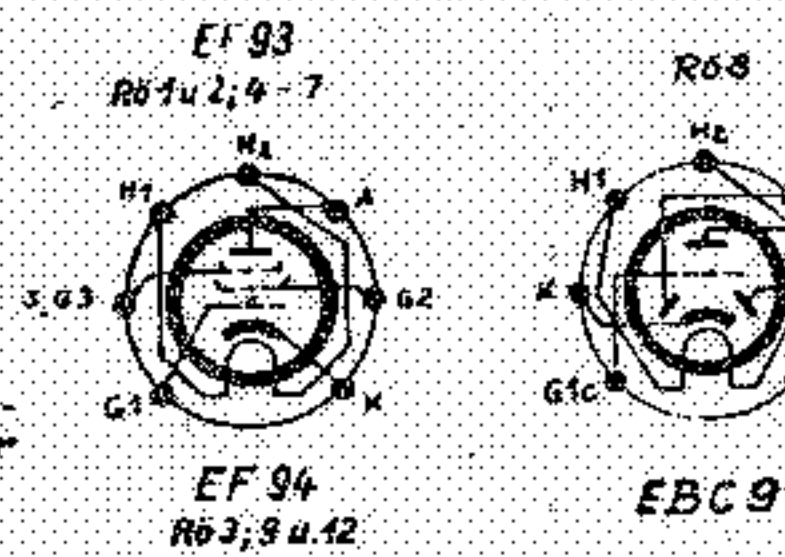
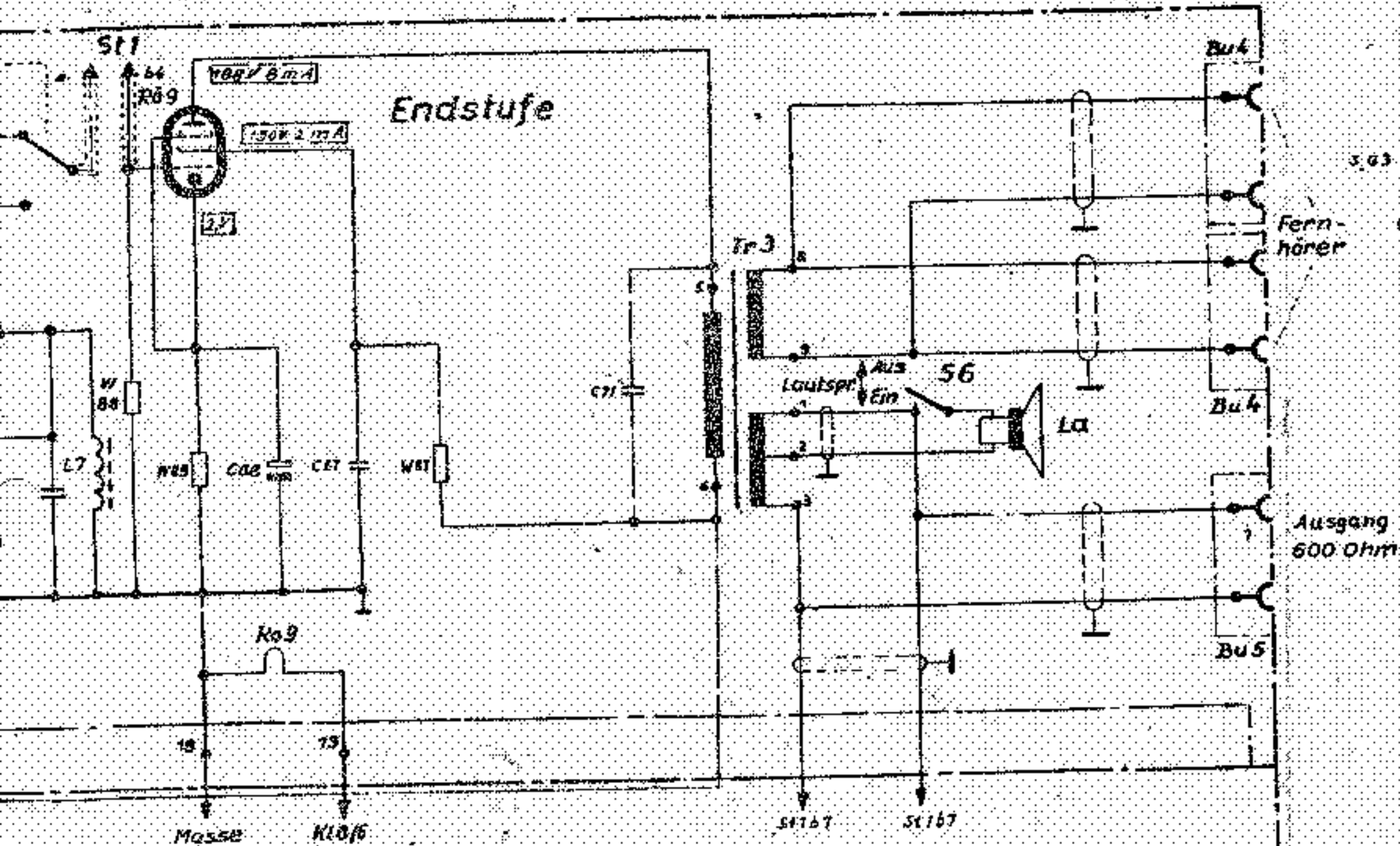

57

	II	III
21	21	13
21	21	13
	I	IV

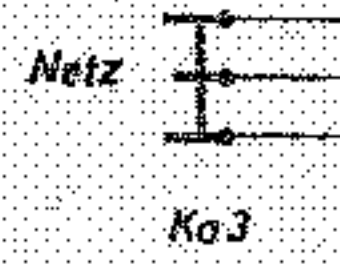

2	67.03.53
4	
Ausg.	And. Nr.
	Werkstoff.
Registrierung	



F 94
S. 12

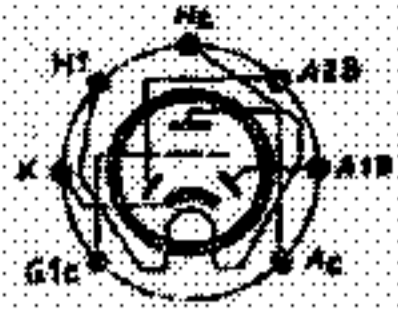

EBC 91

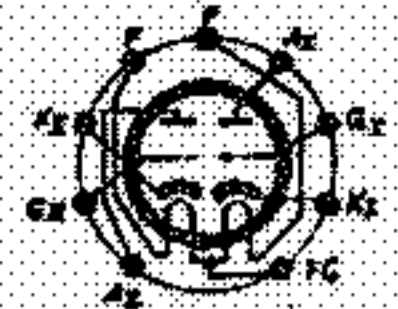

ECC 81

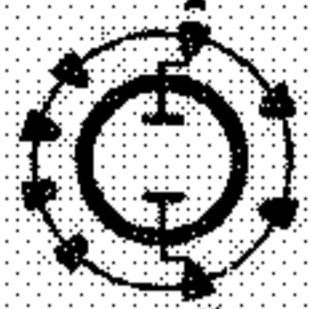

Stadi 150 01

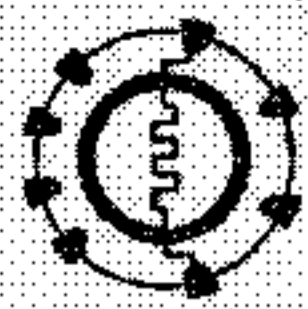

EW 30-90V/0,05A

Enthalten in 6P 203.180 507(4)

BF 1 bis 5

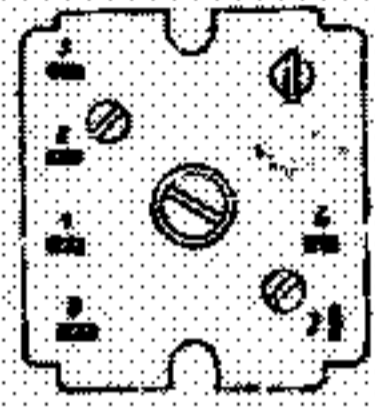

SK 3

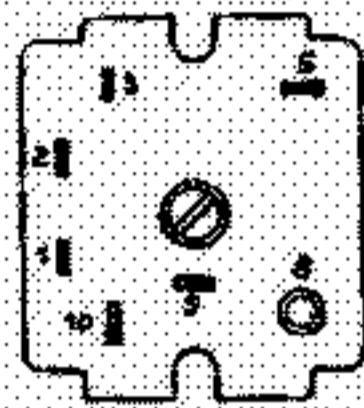

SK 1, SK 2



57

II		III	
1	2	3	4
5	6	7	8
I		IV	

S 4

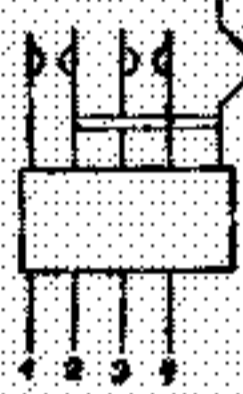

S 3

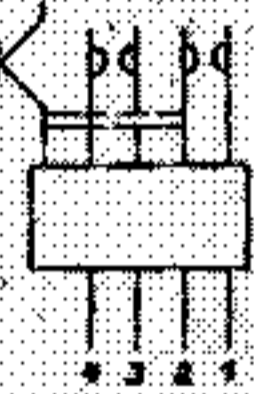

BU 3



Ko 3

Nur bei Betrieb des Empfängers außerhalb des Funkfernsehreib-Empfangsgeräts 6P 301

2	6P 203 507 14.5	Empfänger	7	6P 203 507 14.5	7												
1			3	6P 203 507 14.5	3				5	6P 203 507 14.5	5						
Ausg.	Ang. zur	Datum	Name	Empf.	Ang. zur	Datum	Name	Ausg.	Ang. zur	Datum	Name	Ausg.	Ang. zur	Datum	Name		
Veranstalt.				1956	709	Name	Träger	Zeichnung: Nr.									
				Empfänger	J-T	Kauf		6P203-507(50)									
				Geprüft				Offen									
				Empfänger				1.1.5									
Empfänger-ang.								Kurzwellen-Empfänger E1-1,5/8,5									
U-fachverleite				AM 305													
Faktor																	