

JVC

SERVICE MANUAL

REMOTE CONTROL INTEGRATED AMPLIFIER

AX-R741TN AX-R742BK

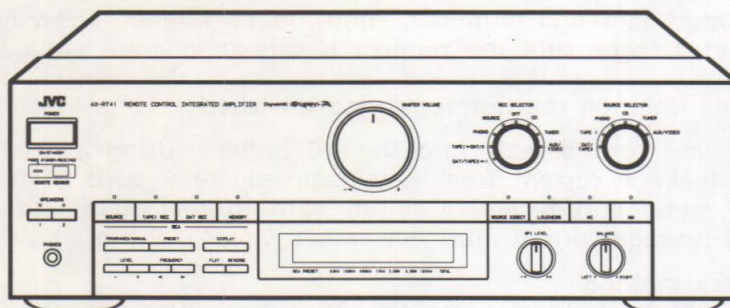
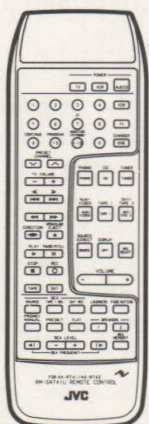

Contents

	Page		Page
Safety Precautions	1- 2	Block Diagram	1-26
Instruction Book	1- 3	Schematic Diagrams	Insertion
Description of Major ICs	1-18	Printed Circuit Boards	Insertion
Internal Block Diagram of Other ICs	1-22	Connection Diagram	Insertion
internal Wiring of FL Display	1-23	Parts List	Separate-volume Insertion
Disassembly Procedures	1-24		
Power Amplifier Adjustment Procedures	1-25		

Safety Precautions

1. The design of this product contains special hardware and many circuits and components specially for safety purposes. For continued protection, no changes should be made to the original design unless authorized in writing by the manufacturer. Replacement parts must be identical to those used in the original circuits. Services should be performed by qualified personnel only.
2. Alterations of the design or circuitry of the product should not be made. Any design alterations of the product should not be made. Any design alterations or additions will void the manufacturer's warranty and will further relieve the manufacture of responsibility for personal injury or property damage resulting therefrom.
3. Many electrical and mechanical parts in the products have special safety-related characteristics. These characteristics are often not evident from visual inspection nor can the protection afforded by them necessarily be obtained by using replacement components rated for higher voltage, wattage, etc. Replacement parts which have these special safety characteristics are identified in the Parts List of Service Manual. Electrical components having such features are identified by shading on the schematics and by (Δ) on the Parts List in the Service Manual. The use of a substitute replacement which does not have the same safety characteristics as the recommended replacement parts shown in the Parts List of Service Manual may create shock, fire, or other hazards.
4. The leads in the products are routed and dressed with ties, clamps, tubings, barriers and the like to be separated from live parts, high temperature parts, moving parts and/or sharp edges for the prevention of electric shock and fire hazard. When service is required, the original lead routing and dress should be observed, and it should be confirmed that they have been returned to normal, after re-assembling.
5. Leakage current check (Electrical shock hazard testing)
After re-assembling the product, always perform an isolation check on the exposed metal parts of the product (antenna terminals, knobs, metal cabinet, screw heads, headphone jack, control shafts, etc.) to be sure the product is safe to operate without danger of electrical shock.
Do not use a line isolation transformer during this check.

- Plug the AC line cord directly into the AC outlet. Using a "Leakage Current Tester", measure the leakage current from each exposed metal parts of the cabinet, particularly any exposed metal part having a return path to the chassis, to a known good earth ground. Any leakage current must not exceed 0.5mA AC (r.m.s.).

- Alternate check method
Plug the AC line cord directly into the AC outlet. Use an AC voltmeter having, 1,000 ohms per volt or more sensitivity in the following manner. Connect a 1,500 Ω 10 W resistor paralleled by a 0.15 μ F AC-type capacitor between an exposed metal part and a known good earth ground.

Measure the AC voltage across the resistor with the AC voltmeter.

Move the resistor connection to each exposed metal part, particularly any exposed metal part having a return path to the chassis, and measure the AC voltage across the resistor.

Now, reverse the plug in the AC outlet and repeat each measurement. Any voltage measured must not exceed 0.75 V AC (r.m.s.). This corresponds to 0.5 mA AC (r.m.s.).

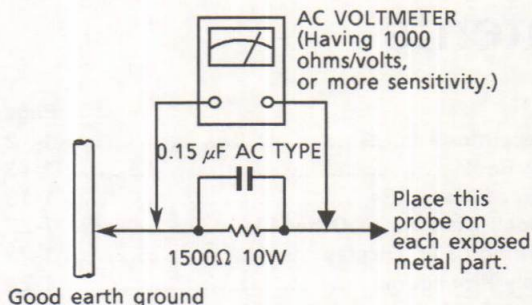

Warning

1. This equipment has been designed and manufactured to meet international safety standards.
2. It is the legal responsibility of the repairer to ensure that these safety standards are maintained.
3. Repairs must be made in accordance with the relevant safety standards.
4. It is essential that safety critical components are replaced by approved parts.
5. If mains voltage selector is provided, check setting for local voltage.

Instruction Book

Connection Diagram

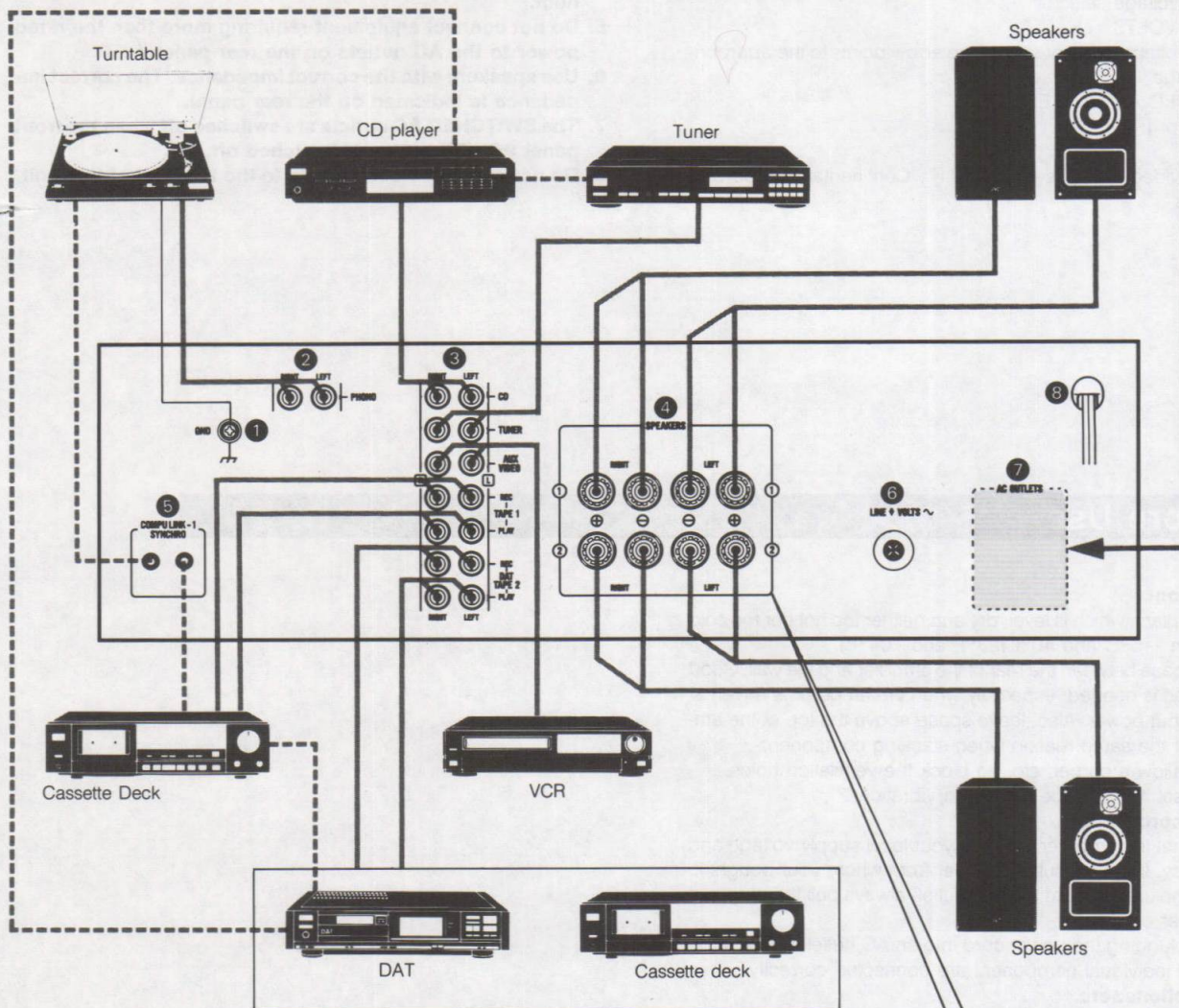
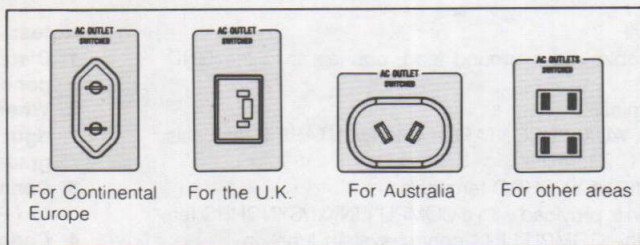

----- : Remote cable for "COMPU LINK"

Note:

- If a component is not a JVC COMPU LINK component, bypass it when making the remote connections.
- Do not make COMPU LINK connection for the cassette deck connected to DAT/TAPE 2 terminal.

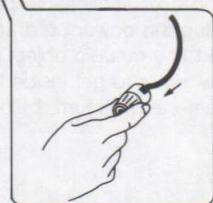

Rear Panel

- ① GND terminal
If your turntable has a ground lead, connect it to the GND terminal.
- ② PHONO terminals
- ③ CD, TUNER, AUX/VIDEO, TAPE 1 and DAT/TAPE 2 terminals
- ④ SPEAKERS 1, 2 terminals
- ⑤ COMPU LINK-1/SYNCHRO terminals
Connect to units provided with a COMPU LINK-1/SYNCHRO terminal to let the COMPU LINK control system function.
- ⑥ AC line voltage selector*
(LINE ↓ VOLTS ~)
Set the voltage selector so that the arrow points to the appropriate voltage.
- ⑦ SWITCHED AC OUTLET(S)
- ⑧ Power cord

* Not provided on units for the U.K., Continental Europe and Australia.

Notes:

1. Disconnect the power cord when connecting any component.
2. When connecting components, make the correct left and right channel connections. Reversed channels may degrade the stereo effect.
3. Connect speakers with correct polarity: (+) to (+) and (-) to (-). Reversed polarity will degrade the stereo effect.
4. Connect plugs or wires firmly. Poor contact may result in hum.
5. Do not connect equipment requiring more than the rated power to the AC outlets on the rear panel.
6. Use speakers with the correct impedance. The correct impedance is indicated on the rear panel.
7. The SWITCHED AC outlets are switched off when the front panel POWER button is switched off.
8. Do not connect video signals to the terminal of this unit.

Before Use

1. Installation

- Select a place which is level, dry and neither too hot nor too cold (between -5°C and $40^{\circ}\text{C}/23^{\circ}\text{F}$ and 104°F).
- Leave space between the rear of the amplifier and the wall. Good ventilation is needed, especially when the amplifier is driven at high output power. Also, leave space above the top of the amplifier for the same reason when stacking components.
- Do not allow a carpet, etc., to block the ventilation holes.
- Do not set it in a place subject to vibrations.

2. Power cord

- Check that the amplifier is set for your local supply voltage and frequency. If not consult the dealer from whom you bought it.
- When unplugging from the wall outlet, always pull the plug, not the power cord.
- Before plugging the power cord into an AC outlet, check to be sure the individual component are connected correctly.

3. Malfunctions, etc.

- There are no user serviceable parts inside. If anything goes wrong, unplug the power cord and consult your dealer.
- Do not insert any metallic object inside the amplifier.
- Do not allow water to get inside the amplifier.
- Set the volume at minimum, before operation.

Front Panel

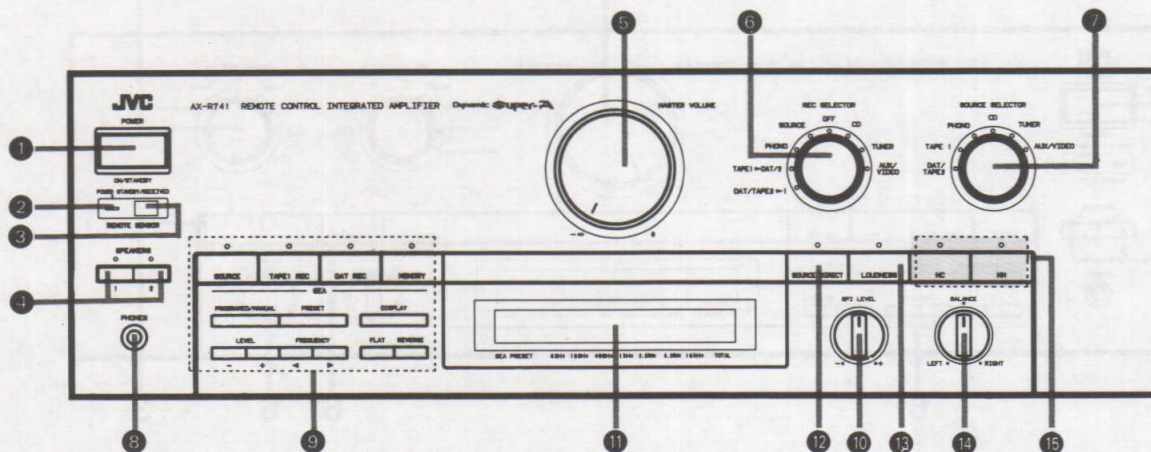

1 POWER (ON/STANDBY)

Press this button to turn the power ON. Press again to turn the power off and activate the STANDBY mode. The STANDBY indicator will light.

A small amount of power (5 watts) is consumed in the STANDBY mode. To turn the power off completely, disconnect the power cord from the wall outlet. Preset data is retained in memory while the power cord is plugged into the wall outlet. If the power cord is disconnected or a power failure occurs, data is retained for two or three days.

2 RECEIVED and POWER STANDBY indicator

Lights when signals are received from the remote control unit or when the machine is in the STANDBY mode.

3 REMOTE SENSOR

Receives signals from the remote control unit.

4 SPEAKERS 1, 2

Turns speakers 1 and 2 ON or OFF.

5 MASTER VOLUME

Adjusts the volume of sound from the speakers or headphones.

6 REC SELECTOR

DAT/TAPE 2 ▶ 1: Set to this position to dub from TAPE 2 to TAPE 1 or to record DAT onto TAPE 1.

TAPE 1 ▶ DAT/2: Set to this position to dub from TAPE 1 to TAPE 2 or to record TAPE 1 onto DAT.

PHONO: Set to this position to record PHONO.

SOURCE: Set to this position to record the source selected by the SOURCE SELECTOR.

OFF: Set to this position when recording is not made.

CD: Set to this position to record CD.

TUNER: Set to this position to record TUNER.

AUX/VIDEO: Set to this position to record the source connected to the AUX/VIDEO terminals.

7 SOURCE SELECTOR

Selects the source you want to listen.

- DAT/TAPE 2
- TAPE 1
- PHONO
- CD
- TUNER
- AUX/VIDEO

8 PHONES

Plug headphones into this jack. If you want to hear from the headphones alone, turn OFF speakers 1 and 2.

9 SEA Function

Use the following buttons for the S.E.A. Graphic Equalizer:

- SOURCE
- TAPE 1 REC
- DAT REC
- MEMORY
- PROGRAMED/MANUAL
- PRESET
- DISPLAY
- LEVEL (-, +)
- FREQUENCY (◀, ▶)
- FLAT
- REVERSE

For details, see "Using the SEA Function."

10 SPI LEVEL

Adjusts the relative display position on the spectro peak indicator so that weak or strong level signals can be displayed in an easy-to-see position. This control has no effect on the output sound level.

11 Display

Displays the functions of SEA or SPI.

12 SOURCE DIRECT

Press to play back the source with good sound quality. BALANCE and SEA system are not available.

13 LOUDNESS

Turns LOUDNESS on or off. The on position makes up for loss of the human auditory sensation when the sound volume is low.

14 BALANCE

Adjusts the volume balance between the left and right speakers.

15 CARTRIDGE

MC: Press in when using an MC cartridge having an output of less than 0.5 mV.

MM: Press again when using an MM or MC cartridge having an output of more than 0.5 mV.

Listening to Sources

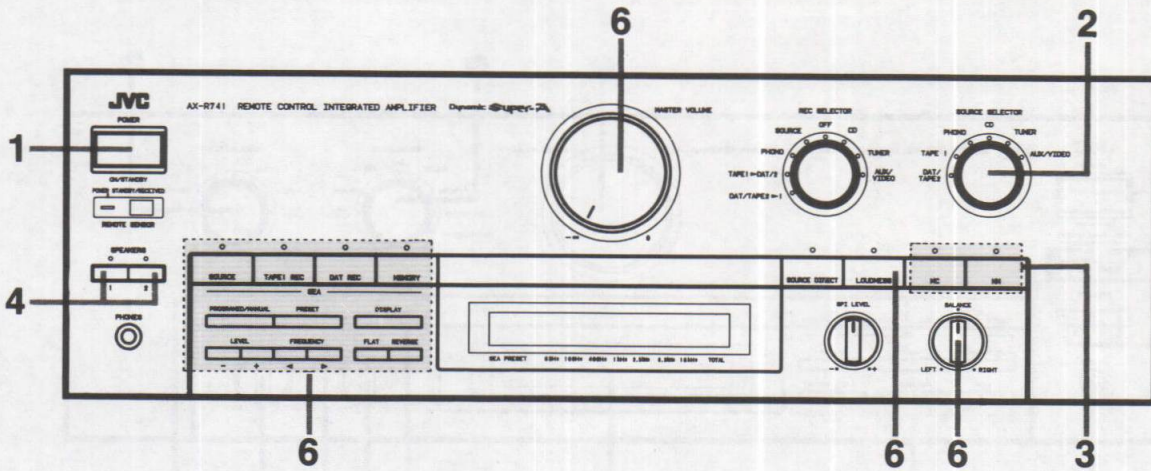

1. Turn the POWER on.

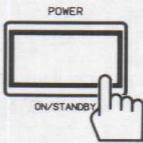

2. Adjust the SOURCE SELECTOR to select the source.

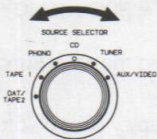

Spin the knob to light up the indicator of the source desired. The knob can be revolved fully one rotation clockwise or counterclockwise.

3. Set the CARTRIDGE as required. (for PHONO only)

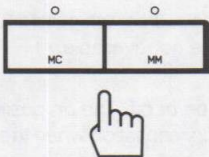

- The indicator of selected button will light up.

Note:

- Unless listening to PHONO, above operation is not necessary.

4. Select the speaker system with the SPEAKERS buttons.

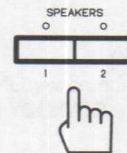

- The indicator of selected button will light up.

5. Operate the corresponding equipment according to its instruction manual.

6. Adjust the MASTER VOLUME, BALANCE, SEA Function and LOUDNESS.

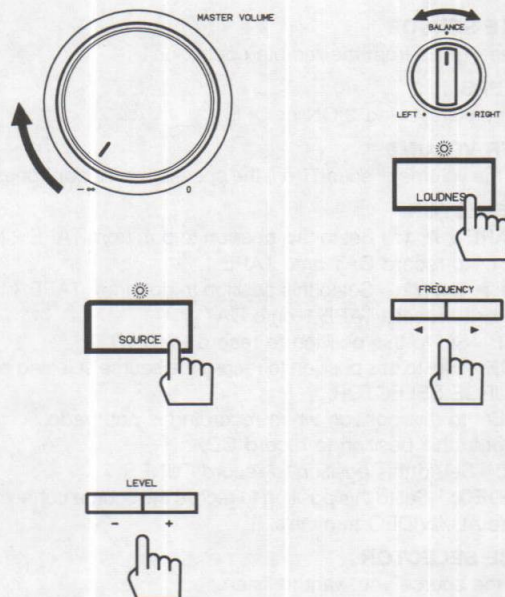

The description of SEA Function is shown on page 10.

Using the SEA Function

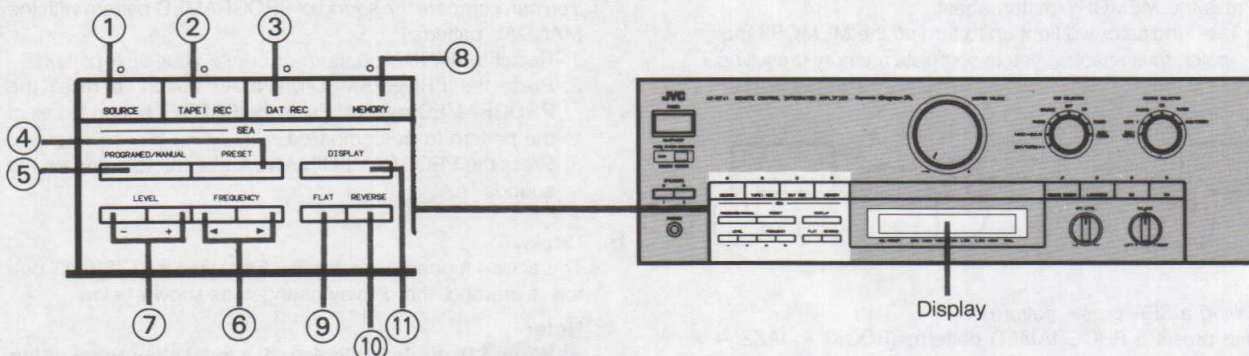

The S.E.A. graphic equalizer divides the audible frequency range into seven bands with center frequencies from 63 Hz to 16 kHz. Each band of tones can be adjusted as desired by the listener. Thus allowing you to tailor the sound to your taste.

SEA consists of two modes.

PROGRAMED mode: 6 built-in preset patterns which conform to various kinds of music.

MANUAL mode: You can create the sound by changing each frequency band to suit yourself. Up to 6 patterns can be memorized. (If memorized, it can be recalled anytime.)

- | | |
|----------------------------|--|
| ① SOURCE: | Press to activate SEA Function on the source reproduced. |
| ② TAPE 1 REC: | Press to activate SEA Function on the recording source connected to TAPE 1 terminal. |
| ③ DAT REC: | Press to activate SEA Function on the recording source connected to DAT/TAPE 2 terminal. |
| ④ PRESET: | Calls SEA preset pattern. |
| ⑤ PROGRAMED/MANUAL: | Selects the PROGRAMED or MANUAL mode. |
| ⑥ FREQUENCY: | ◀ : Calls lower frequency band display.
▶ : Calls higher frequency band display. |
| ⑦ LEVEL: | + : Sets higher SEA level.
- : Sets lower SEA level. |
| ⑧ MEMORY: | Memorizes set SEA pattern. |
| ⑨ FLAT: | Flattens SEA level. |
| ⑩ REVERSE: | Reverses +, - of the SEA pattern. |
| ⑪ DISPLAY: | Press to change the display mode. |

1. Creating an SEA pattern

1. Press the SOURCE button.



2. Press the FREQUENCY buttons ◀ or ▶ to select the frequency to be changed. (The frequency band in the display will flicker.)

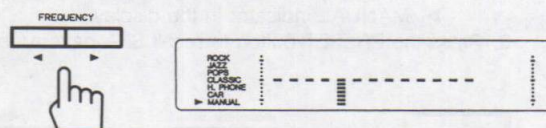

3. Press the LEVEL buttons + or - to adjust the level.

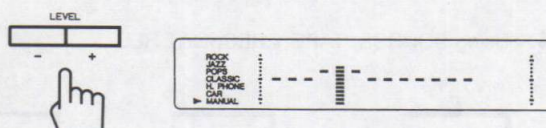

Repeat the above step 2 — 3 for each additional frequency to be changed.

2. Memorizing MANUAL pattern

1. Press the MEMORY button.
 (MEMORY indicator will light up.)
2. With MEMORY indicator on, press PRESET button to select a desired position to memorize.
 - Pressing PRESET button will move the memory position by flickering the ► indicator.
3. Press the MEMORY button again.
 - ► indicator will light up to turn off the MEMORY indicator, thus enabling you to complete memory presetting.

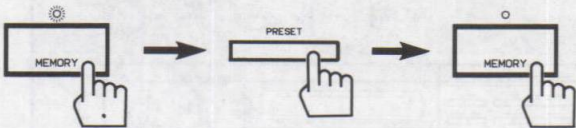

3. Recalling a SEA preset pattern

Built-in preset 6 PROGRAMED patterns (ROCK — JAZZ — POPS — CLASSIC — H. PHONE — CAR) and 6 MANUAL patterns can be recalled.

The PROGRAMED SEA patterns are:

- ROCK Boosted low and high frequencies.
- JAZZ Gives a feeling of a live atmosphere.
 Good for acoustic music.
- POPS Good for vocal music.
- CLASSIC Set for wide and dynamic sound stereo systems.
- H. PHONE When creating tapes for headphone use.
- CAR When creating tapes for use in a car stereo.

1. Press the SOURCE button.
2. Press the PROGRAMED/MANUAL button.
 - * To recall PROGRAMED pattern, turn off the ► MANUAL indicator in the display.
 - * To recall MANUAL pattern, turn on the ► MANUAL indicator in the display.
3. Press the PRESET button to recall SEA pattern desired.

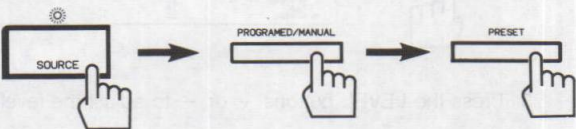

4. Using SOURCE, TAPE 1 REC, DAT REC



- SOURCE: Press to activate SEA Function on the source reproduced. (SEA recording cannot be made.)
- TAPE 1 REC: Press to activate SEA Function on the recording source connected to TAPE 1 terminal.
- DAT REC: Press to activate SEA Function on the recording source connected to DAT/TAPE 2 terminal.

Note:

- When a reproducing source and a recording source are different, SEA is activated on the one side only. In this case, the indicator of pressed button will light up and the other indicator (if it is lit) will flicker and go off.

5. Comparing two SEA patterns

You can compare the sound of PROGRAMED pattern with the MANUAL pattern.

1. Recall a MANUAL pattern or create your SEA pattern.
2. Press the PROGRAMED/MANUAL button to recall the PROGRAMED pattern. Press the PRESET button to select the pattern to be compared.
3. Press the PROGRAMED/MANUAL button to compare the sounds.

6. Display

There are 4 modes in the display. Each time the DISPLAY button is pressed, the display changes as shown below.

Note:

- When SPI mode is displayed, a level change resulting from ON/OFF operation of LOUDNESS is not displayed.

SPI (PEAK HOLD)

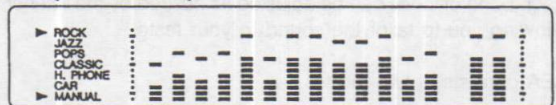

SPI (Standard)



SPI (PEAK LINE)

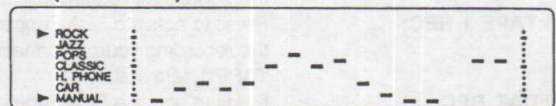

SEA Pattern

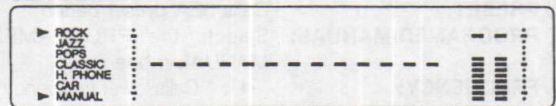

(back to the beginning)

In SPI mode, a continuous non-sound status will display SEA pattern. With signals coming in, the display will restore the previous SPI mode.

Recording Tapes

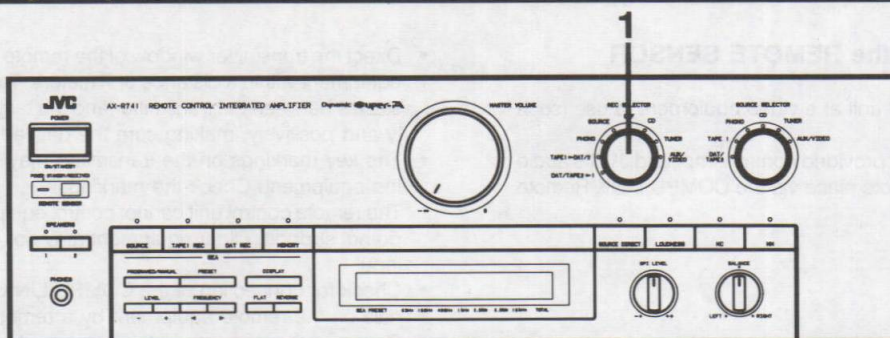

1. Set the REC SELECTOR as desired.

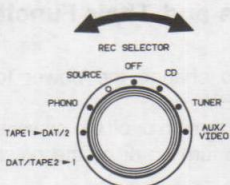

Spin the knob to light up the indicator of the source desired. The knob can be revolved fully one rotation clockwise or counterclockwise.

2. Play the source according to its instruction manual.
3. Operate the tape deck for recording.

Notes:

- To listen to another source while recording, select desired source by the SOURCE SELECTOR.
- If your tape deck is 3-head type, you can monitor the sound being recorded. In this case, adjust the SOURCE SELECTOR position to TAPE 1 or DAT/TAPE 2 connected to tape deck.
- If the REC SELECTOR is set to SOURCE, you cannot monitor the sound.
- To record with SEA, press the TAPE 1 REC or DAT REC to light up the indicator.
- When power off or STANDBY mode, recordings cannot be made.

Tape Dubbing

Dubbing between TAPE 1 and TAPE 2 is carried out as follows:

— To record from TAPE 1 to TAPE 2 —

1. Set the REC SELECTOR to TAPE 1 ▶ DAT/2.

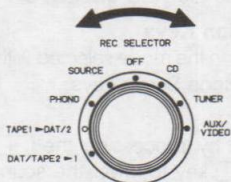

2. Play back the deck TAPE 1 and operate the deck TAPE 2 for recording.

Note:

- To monitor the recorded sound, connect 3 head-deck to DAT/TAPE 2 terminal and set the source selector to DAT/TAPE 2.

— To record from TAPE 2 to TAPE 1 —

1. Set the REC SELECTOR to DAT/TAPE 2 ▶ 1.

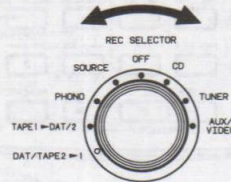

2. Play back the deck TAPE 2 and operate the deck TAPE 1 for recording.

Note:

- To monitor the recorded sound, connect 3 head-deck to TAPE 1 terminal and set the source selector to TAPE 1.

Operation with the Remote Control Unit

Aim the signals at the REMOTE SENSOR

- Aim the remote control unit at a video equipment to use (such as TV, VCR).
- The remote control unit provided control Amp. and JVC's audio visual gear from a remote place via the COMPU LINK Remote Control System.

- Direct the transmitter window of the remote control unit at target equipment within a distance of 7 meters. Take care to avoid obstacles between the transmitter and the target. Press keys slowly and positively, making sure the desired functions result.
- The key markings on the transmitter may not match those on the equipment. Check the markings.
 The remote control unit cannot control equipment functions they do not support. Older equipment may not be receptive to their input.
- Check for connection of the COMPU LINK-1/SYNCHRO terminals on the remote equipment by a remote cable.
- Switch on the power to all the equipment required before starting operation. The POWER key on the remote control unit can switch on the power to the AUDIO Amp., TV and VCR.

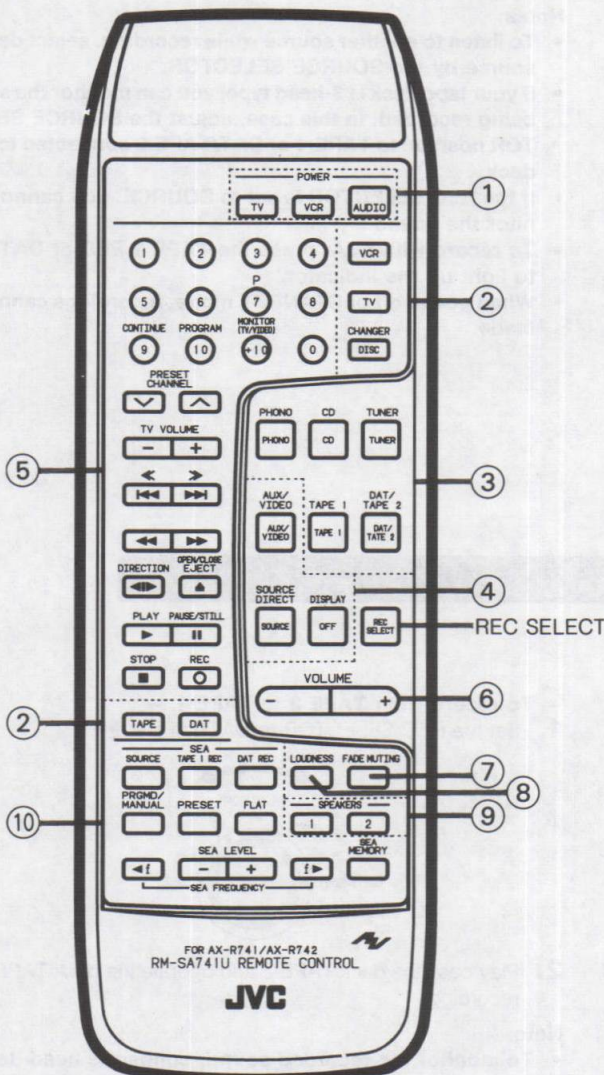

■ Name of Parts and Their Functions

- POWER**
AUDIO: Press to change the power for the Amp ON or STANDBY.
TV: Press to turn on or off the power to JVC's TV receiver.
VCR: Press to turn on or off the power to JVC's VCR.
- Function Mode Select**
 Press to select the equipment you wish to operate. Different functions are assigned to the Selectable Function keys depending on the equipment. Pressing these buttons does not change the source selected for input to the Amp.
- SOURCE SELECT**
 Press to change the source selected for input to the Amp. Different functions are assigned to the Selectable Function keys depending on the source.
- AUX/VIDEO, [AUX/VIDEO], SOURCE DIRECT, [SOURCE], [DISPLAY OFF]**
 If these keys are pressed while the REC SELECT key is kept pressed:
 It operates AUX/VIDEO, SOURCE, or OFF of REC SELECTOR.
 If these keys are pressed independently:
 It operates AUX/VIDEO, SOURCE DIRECT, or DISPLAY key.
REC SELECT
 While the REC SELECT key is kept pressed, pressing any key of ③ or ④ operates the REC SELECTOR.
- Selectable Function Keys**
 These keys function in the mode selected with SOURCE SELECT keys or Function Mode Select keys.
- VOLUME**
 Adjust the volume by processing the [+] key to raise the sound and the [-] key to lower the sound.
- FADE MUTING**
 Press this key to lower the volume in steps. The volume is further decreased each time this key is pressed.
- LOUDNESS** ⑨ **SPEAKERS** ⑩ **SEA**
 Same functions as the main unit.

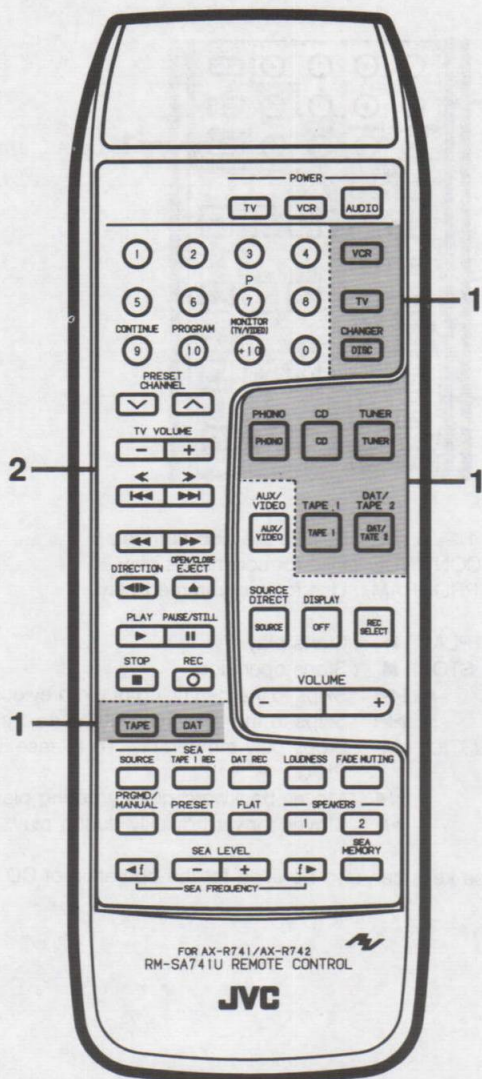

■ How to use the Selectable Functions keys

Basic Operation

1. Selects the function mode with the Function Mode Select keys or SOURCE SELECT keys.
 - SOURCE SELECT keys also change the source input to the Amp.
 - Use a Function Mode Select keys (VCR or TAPE 1) to operate an equipment while you are listening to the sound of another source, for example, to have a tape deck standby while playing a CD.
2. Use the Selectable Function keys.

— Operating the source unit —

- The functions of the numeric keys (1 — 10, +10, 0) may vary according to the unit you operate. Be sure to read the instructions for each unit.

TUNER

1. Press the TUNER key of the SOURCE SELECT keys.
2. Use the Selectable Function keys.

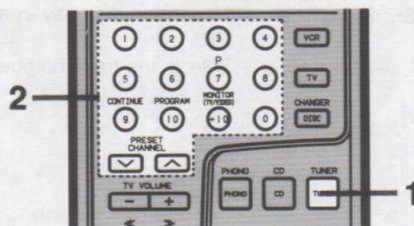

1 — 10, +10, 0 : Selects the preset channel.
PRESET CHANNEL

- ∧ : Scans to higher preset channels.
- ∨ : Scans to lower preset channels.

CD

1. Press the CD key of the SOURCE SELECT
2. Use the Selectable Function keys.

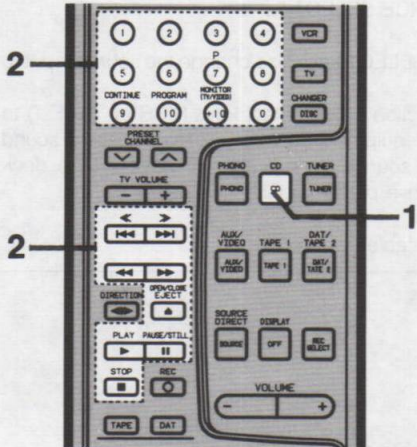

CD Auto-changer

1. Press the CHANGER/DISC key of the Function Select keys.
2. Use the Selectable Function keys.

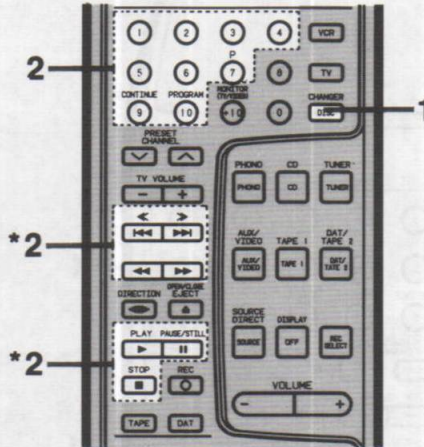

- PLAY ► : Starts play.
 - STOP ■ : Stops operation.
 - ◀ ◀◀ : Skips to the beginning of the previous track.
 - ▶▶ ▶ : Skips to the beginning of the next track.
 - PAUSE/STILL ■■ : Stops play temporarily. To release it, press PLAY ►.
 - ◀◀ : Moves backward quickly during play.
 - ▶▶ : Moves forward quickly during play.
 - OPEN/CLOSE, EJECT ▲ : Moves the disc tray in and out.
- 1 — 10, +10, 0 : Selects the track number.

- 1 — 6, 7/P : Selects the disc number.
 - CONTINUE : Use for continuous play.
 - PROGRAM : Use for programmed play.
 - PLAY ► : Starts play.
 - STOP ■ : Stops operation.
 - ◀ ◀◀ : Skips to the beginning of the previous track.
 - ▶▶ ▶ : Skips to the beginning of the next track.
 - PAUSE/STILL ■■ : Stops play temporarily. To release it, press PLAY ►.
 - ◀◀ : Moves backward quickly during play.
 - ▶▶ : Moves forward quickly during play.
- * These keys can also be used for the operation of CD.

Turntable

1. Press the PHONO key of the SOURCE SELECT keys.
2. Use the Selectable Function keys.

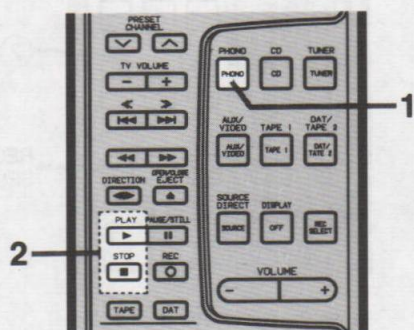

PLAY ► : Starts play.
STOP ■ : Stops play.

Cassette Deck (TAPE 1)

1. Press the TAPE 1 key of the SOURCE SELECT or TAPE key of the Function Select keys.
2. Use the Selectable Function keys.

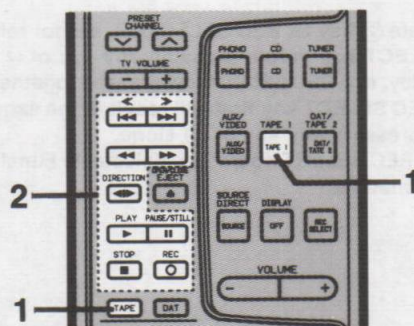

PLAY ► : Starts playback.
STOP ■ : Stops operation.
◀◀ : Skips to the beginning of the previous tune.
▶▶ : Skips to the beginning of the next tune.
PAUSE/STILL ■■ : Stops playback/recording temporarily. To release it, press PLAY ►
DIRECTION ◀▶ : Change the tape running direction.
◀◀ : Fast winds the tape from right to left.
▶▶ : Fast winds the tape from left to right.
REC ○ : Press together with PLAY ► to start recording.
Press together with PAUSE/STILL ■■ to enter record-pause mode.

VCR

1. Press the VCR key of the Function Select keys.
2. Use the Selectable Function keys.

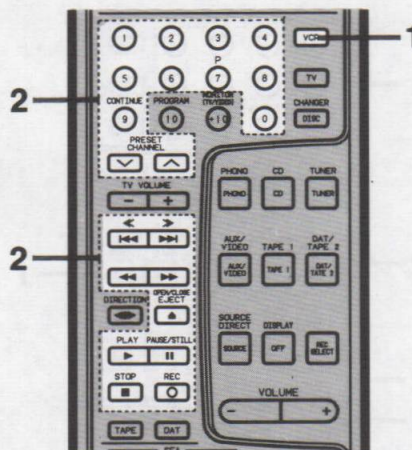

PLAY ► : Starts playback.
STOP ■ : Stops operation.
PAUSE/STILL ■■ : Stops playback/recording temporarily and enters the pause/still mode. To release it, press PLAY ►
◀◀, ▶▶ : Plays VCR having variable search function.
◀◀ : Rewinds video tape.
▶▶ : Fast-forwards video tape.
REC ○ : Press together with PLAY ► to start recording.
Press together with PAUSE/STILL ■■ to enter record-standby mode.
OPEN/CLOSE, EJECT ▲ : Moves the video cassette out.
1 — 9, 0 : Selects the VCR channel.
PRESET CHANNEL ^ : Scans to higher VCR channels.
PRESET CHANNEL v : Scans to lower VCR channels.

DAT

1. Press the DAT key of the SOURCE SELECT keys or Function Select keys.
2. Use the Selectable Function keys.

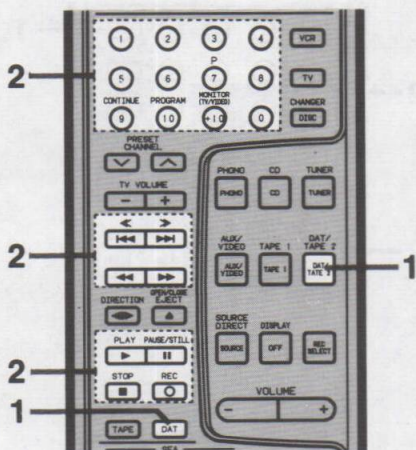

- PLAY ► : Starts playback.
- STOP ■ : Stops operation.
- ◀◀ : Skips to the beginning of the previous tune.
- ▶▶ : Skips to the beginning of the next tune.
- PAUSE/STILL ■■ : Stops playback/recording temporarily. To release it, press PLAY ► .
- ◀◀ : Rewinds tape.
- ▶▶ : Fast-forwards tape.
- REC ○ : Press together with PLAY ► to start recording. Press together with PAUSE/STILL ■■ to enter record-pause mode.

1 — 10, +10, 0 : Selects the tune number.

TV

1. Press the TV key of the Function Select keys.
2. Use the Selectable Function keys.

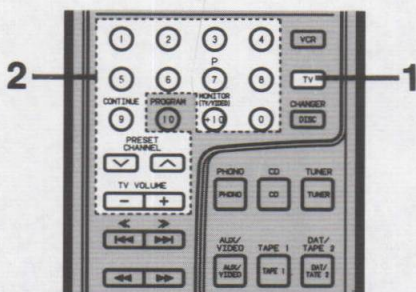

- 1 — 9, 0 : Selects the TV channel.
- PRESET CHANNEL ▲ : Scans to higher TV channels.
- PRESET CHANNEL ▼ : Scans to lower TV channels.
- TV VOLUME —, + : Adjusts the sound volume of TV.
- MONITOR (TV/VIDEO) : Changes TV or VIDEO of TV operating mode.

Using REC SELECTOR

Press ② key, while the REC SELECT key is kept pressed.

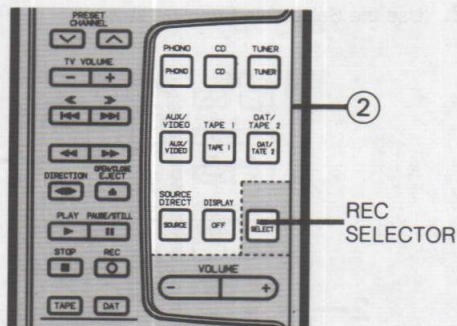

- PHONO:** Press to record from turntable.
- CD:** Press to record from CD player.
- TUNER:** Press to record from tuner.
- AUX/VIDEO:** Press to record from equipment connected to AUX/VIDEO terminal.
- TAPE 1:** Set to this position to dub from TAPE 1 to TAPE 2 or to record TAPE 1 onto DAT.
- DAT/TAPE 2:** Set to this position to dub from TAPE 2 to TAPE 1 or to record DAT onto TAPE 1.
- SOURCE:** Press to record from equipment selected by the SOURCE SELECTOR.
- OFF:** Press when recording is not made.

Note:

- To operate ② key as REC SELECTOR, do not release the REC SELECT key before pressing any key of ②.
- With ② key, and REC SELECT key pressed together, releasing of REC SELECT key first will result in the same operation as pressing any key of ② alone.
- When in REC SELECT operation, Selectable Function Keys do not function.

How to install the batteries

- If the range of the remote control unit seems shortened, the batteries may be old. Try inserting new batteries.
- Observe the polarity of the batteries when loading them.
- Do not mix new and old batteries.
- Be sure to use batteries of the same brand. Batteries may vary in voltage even though they look alike.
- If the remote control unit will not be used for a long time, remove the batteries.
- Do not heat batteries or attempt to dispose of them by burning.

1. Slide the cover of the battery case in the direction of arrow to remove it.

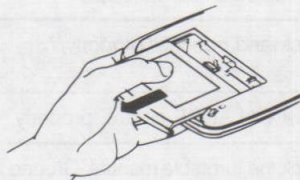

2. Install the provided batteries (AAA: UM-4, R03, 1.5 V), with their polarities properly placed.

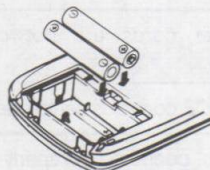

3. Re-install the cover of the battery case.



COMPU LINK Remote Control System

JVC's exclusive "COMPU LINK" remote control system connects equipment with JVC COMPU LINK-1/SYNCHRO terminals to the remote control system. The equipment can be controlled from the remote control unit, or other functions (such as automatic source selection and synchronized recording) can be used.

■ Equipment remote control

JVC COMPU LINK system can remotely control such equipment as CD player, CD auto changer, tuner, cassette deck, turntable and DAT deck.

please note:

- **In addition, JVC audio-visual equipment (such as VCRs and TVs) can also be controlled remotely. For further details, see the remote control unit description in this instructions. In that case, operate your remote control unit pointing toward, not amplifier, but VCR or TV.**

■ Automatic source selection

SOURCE selection will automatically put the corresponding source equipment into the PLAY mode. When the PLAY key on source equipment is pressed, the corresponding SOURCE is automatically set to that source. Other equipment in not operation will be shut down about 5 seconds later.

■ Synchronized recording

Synchronized recording permits a tape deck to start recording automatically in synchronism with a CD player or turntable. Set the tape deck in the REC/PAUSE mode and press the PLAY key on the CD player or turntable. The tape deck will enter the recording mode automatically, starting synchronized recording.

Synchronized recording stops automatically after the CD player or turntable has stopped and the tape deck has entered the REC/MUTE mode for about 4 seconds. For details, refer to the tape deck instructions.

Notes:

- **If the power for any connected equipment is shut off during synchronized recording, the system will not operate properly. In this case, you must start all over again.**
- **During synchronized recording the REC SELECTOR position will lock in either the CD or PHONO position. This is to prevent you from accidentally stopping the recording or changing to any other source. To change to another source you must first stop synchronized recording.**
- **If you connect a cassette deck to the DAT/TAPE 2 terminals, disconnect the remote control cable and do not use synchronized recording.**
- **If you program track numbers on a CD player and use synchronized recording, a blank space about 4 seconds long will be left between recordings. This permits music scanning.**
- **When set to the REC/PAUSE mode by pressing the PAUSE button after pressing the REC and PLAY buttons simultaneously, synchronized recording is not possible. For details, refer to your cassette deck's instruction manual.**

Troubleshooting

Problem	Possible Cause	Solutions
No sound and no illumination.	The AC plug is not connected properly.	Plug the AC plug in properly.
No sound from speakers.	The speaker cords are not connected properly.	Check and connect properly.
	The speaker switch is set to off.	Turn on the speaker switch. (The indicator will light up.)
Sound from one speaker only.	The speaker cords are not connected properly.	Check and connect properly.
	The BALANCE control is set to one extreme.	Adjust BALANCE control properly.
Loud hum during record playing.	Turntable not connected properly.	Check the turntable manual. Ground the turntable if required.
	Interference from other electrical appliances.	Try moving the power cord or plugging into a different outlet.
Howling during record playing.	Turntable too close to a speaker.	Move speakers away from the turntable.

Specifications

OVERALL CHARACTERISTICS

Output power:

- 120 watts per channel into 4 ohms at 1 kHz (DIN).
- 80 watts per channel into 8 ohms at 1 kHz (DIN).
- 75 watts per channel, min. RMS, both channels driven, into 8 ohms from 20 Hz to 20 kHz, with no more than 0.007% total harmonic distortion.
- 80 watts per channel, min. RMS, both channels driven, into 8 ohms at 1 kHz with no more than 0.003% total harmonic distortion. (measured by JVC Audio Analyzer System)

Total harmonic distortion	: 0.007% (20 Hz — 20 kHz, 8 ohms) at 75 watts
Intermodulation distortion	: 0.007% (60 Hz : 7 kHz = 4 : 1, 8 ohms) at 75 watts
Power band width	: 5 Hz — 50 kHz (IHF, 0.05%, 8 ohms both channels driven)
Frequency response	: 5 Hz — 80 kHz +0, -3 dB (8 ohms)
Damping factor	: 120 (1 kHz, 8 ohms)
Input terminals	
Input sensitivity/impedance (1 kHz)	
PHONO (MM)	: 2.5 mV/47 kohms
PHONO (MC)	: 200 μ V/100 ohms
CD/AUX/TUNER/TAPE 1/DAT	: 200 mV/47 kohms
Signal-to-noise ratio	
PHONO (MM)	: 85 dB ('66 IHF)
PHONO (MC)	: 66 dB ('66 IHF)
CD/AUX/TUNER/TAPE 1/DAT	: 100 dB ('66 IHF)
PHONO (MM)	: 74 dB (DIN)
CD/AUX/TUNER/TAPE 1/DAT	: 75 dB (DIN)

S.E.A. graphic equalizer

Center frequencies	: 63 Hz, 160 Hz, 400 Hz, 1 kHz, 2.5 kHz, 6.3 kHz, 16 kHz
Control range	: +12 dB \pm 1 dB, -12 dB \pm 1 dB
Loudness controls (Volume control at -30 dB position)	: +6 dB (at 100 Hz) +4 dB (at 10 kHz)

EQUALIZER

PHONO overload capacity (PHONO to REC OUT)	
PHONO (MM)	: 100 mV (0.04% THD)
PHONO (MC)	: 8 mV (0.04% THD)
PHONO RIAA deviation	
PHONO (MM)	: \pm 0.3 dB (20 Hz — 20 kHz)
PHONO (MC)	: \pm 0.5 dB (20 Hz — 20 kHz)
Recording output	
Output level/impedance	
TAPE 1/DAT REC	: 200 mV/1.6 kohms

GENERAL

Dimensions	: 435 (W) x 147 (H) x 348 (D) mm (17-3/16" x 5-13/16" x 13-3/4")
Weight	: 10.4 kg (23 lbs.)

Design and specifications subject to change without notice.

POWER SPECIFICATIONS

Area	Line Voltage & Frequency	Power Consumption
U.K.	AC 240 V ~, 50 Hz	690 watts
Australia		
Continental Europe	AC 230 V ~, 50 Hz	300 watts
Other areas	AC 110 / 127 / 220 / 240 V ~ selectable, 50/60 Hz	310 watts

SPANNUNGSVERSORGUNG UND LEISTUNGS-AUFNAHME

Länder	Netzspannung und Frequenz	Leistungsaufnahme
Großbritannien	240 V ~, 50 Hz	690 Watt
Australien		
Kontinental-Europa	230 V ~, 50 Hz	300 Watt
Andere Länder	umschaltbar 110 / 127 / 220 / 240 V ~ 50/60 Hz	310 Watt

CARACTERISTIQUES TECHNIQUES D'ALIMENTATION

Pays	Tension d'alimentation et fréquence	Consommation
Royaume-Uni	CA 240 V ~, 50 Hz	690 watts
Australie		
Europe Continentale	CA 230 V ~, 50 Hz	300 watts
Autres Pays	CA 110 / 127 / 220 / 240 V ~, commutable, 50/60 Hz	310 watts

SPANNINGSVEREISTEN

Gebieden	Netspanning en frekwentie	Stroomverbruik
Engeland	Net 240 V ~ 50 Hz	690 Watt
Australië		
Europese vasteland	Net 230 V ~ 50 Hz	300 Watt
Andere gebieden	Net 110 / 127 / 220 / 240 V ~ instelbaar, 50/60 Hz	310 Watt

ESPECIFICACIONES DE ALIMENTACION

Países	Voltaje y frecuencia	Consumo
Reino Unido	AC 240 V ~, 50 Hz	690 vatios
Australia		
Europa Continental	AC 230 V ~, 50 Hz	300 vatios
Otros países	AC 110 / 127 / 220 / 240 V ~ seleccionable, 50/60 Hz	310 vatios

STRÖMFÖRSÖRJNING

Områden	Nätspänning & frekvens	Effektförbrukning
Storbritannien	~240 V, 50 Hz	690 Watt
Australien		
Kontinentaleuropa	~230 V, 50 Hz	300 Watt
Övriga länder	~110 / 127 / 220 / 240 V (omkopplingsbart), 50/60 Hz	310 Watt

Description of Major ICs

■ MN71202JNZ(IC901) : System Controller

1. Terminal Layout

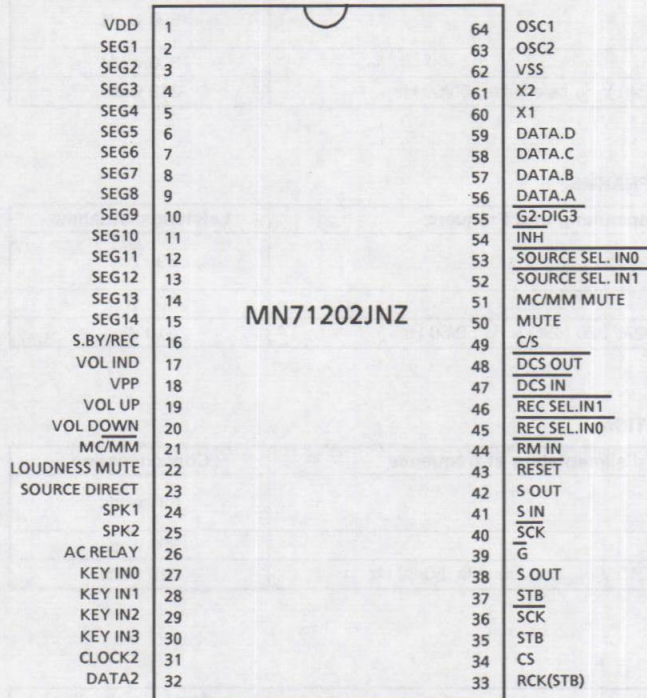

2. Key Matrix

	KEY IN 0 (pin27)	KEY IN 1 (pin28)	KEY IN 2 (pin29)	KEY IN 3 (pin30)
Y0	POWER	SEA SOURCE	MAN. / PROG.	f ◀
Y1	DIRECT	TAPE 1 SEA	SPI /SEA	SEA -
Y2	LOUDNESS	TAPE 2 SEA	PRESET	SEA +
Y3	MC	—	MEMORY	f ▶
Y4	MM	—	FLAT	REVERSE

3. Pin Function Description

Pin NO.	Symbol	I/O	Function and Operations	Pin NO.	Symbol	I/O	Function and Operations
1	VDD	--	Power supply	33	RCK(STB)	O	Control Signal for the LED Drivers
2	SEG1	O	FL segment control output	34	CS	O	A/D Converter Chip Select Signal
3	SEG2	O	/"	35	STB	O	Strobe for Analog Switch (ENH-131-2)
4	SEG3	O	/"	36	SCK	O	Clock for the SOUR., REC Selector (IC311,312)
5	SEG4	O	/"	37	STB	O	Strobe for the SOUR, REC Selector (IC311,312)
6	SEG5	O	/"	38	S OUT	O	Data for the SOURCE, REC Selector
7	SEG6	O	/"	39	G	O	Data for the LED Drivers
8	SEG7	O	/"	40	SCK	O	Clock for the LED Drivers
9	SEG8	O	/"	41	S IN	I	Data for the SEA Indication
10	SEG9	O	/"	42	S OUT	O	Data for the Analog Switch (ENB-131-2)
11	SEG10	O	/"	43	RESET	I	Reset signal input
12	SEG11	O	/"	44	RM IN	I	Input from REMOTE SENSOR
13	SEG12	O	/"	45	REC SEL. IN0	I	Input from the REC Selector (S251)
14	SEG13	O	/"	46	REC SEL. IN1	I	/"
15	SEG14	O	/"	47	DCS IN	I	Compulink signal input
16	S.BY/REC	O	Stand-By Indication Output	48	DCS OUT	O	Compulink signal output
17	VOL IND	O	Volume Indication Output	49	C/S	--	Connected to GND
18	VPP	--	Power supply for FL Display	50	MUTE	O	Muting at the Master Volume
19	VOL UP	O	Volume Control Signal	51	MC/MM MUTE	O	Muting at the Phono equalizer
20	VOL DOWN	O	/"	52	SOU. SEL. IN1	I	Input from the Source Selector (S252)
21	MC/MM	O	Phono Equalizer Gain Control Signal	53	SOU. SEL. IN0	I	/"
22	LOUD. MUTE	O	Non Connection	54	INH	I	Inhibit signal for the backup
23	SOURCE DIR.	O	Source Direct Relay Control Signal	55	G2-DIG3	O	Outpu for the Shift register (IC904)
24	SPK1	O	Speaker Relay Control Signal	56	DATA.A	O	Data for the all of the Indication
25	SPK2	O	Speaker Relay Control Signal	57	DATA.B	O	/"
26	AC RELAY	O	AC Relay Control Signal	58	DATA.C	O	/"
27	KEY IN0	I	Key Matrix Input	59	DATA.D	O	/"
28	KEY IN1	I	/"	60	X1	--	Connected to GND
29	KEY IN2	I	/"	61	X2	--	Non connection
30	KEY IN3	I	/"	62	VSS	--	GND
31	CLOCK2	O	Clock Output for the SEA	63	OSC2	O	Clock oscillation output
32	DATA2	O	Data Output for the SEA	64	OSC1	I	Clock oscillation input

■ UPD7001C(IC293)..... A/D Converter

1. Terminal Layout

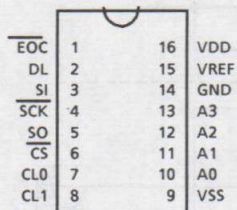

2. Block Diagram

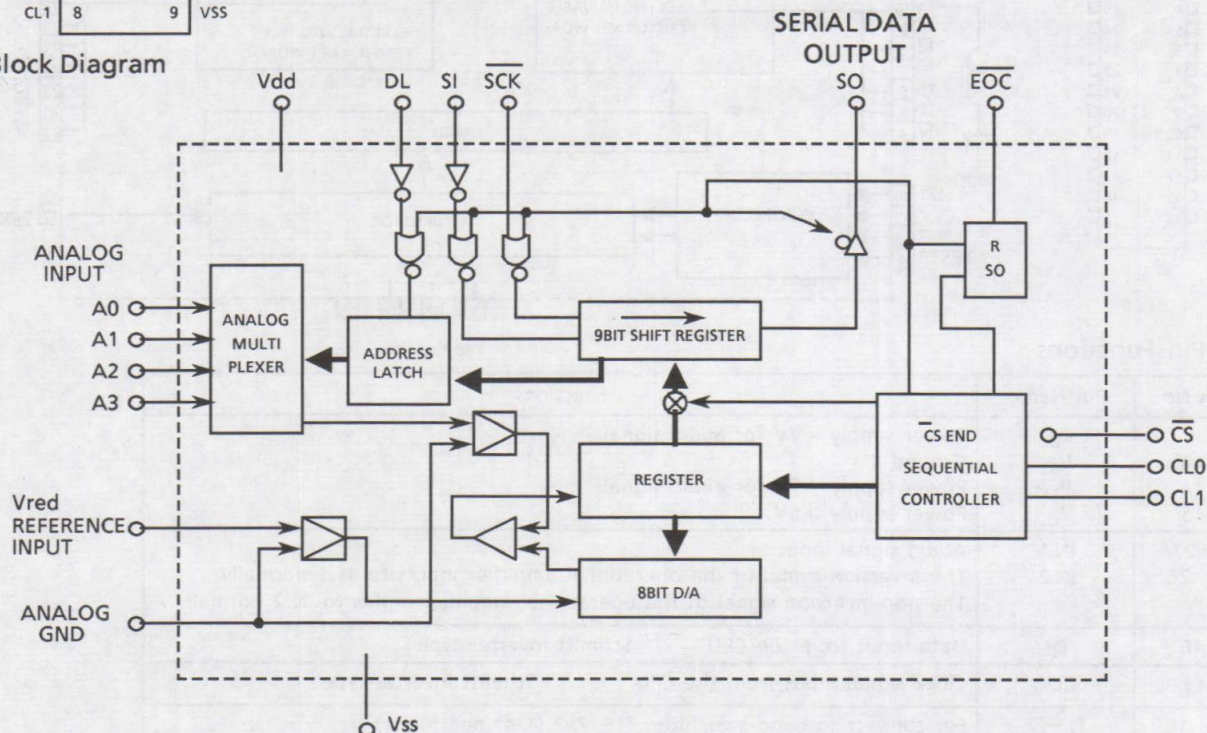

■ TC74HC595AP(IC905,907,908)..... 8 Bit Shift Register

1. Terminal Layout

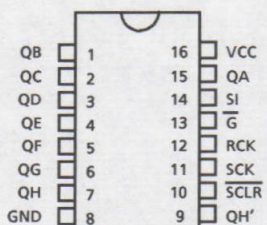

2. Function Table

Inputs					Functions
SI	SCK	SCLR	RCK	G	
X	X	X	X	H	Output (QA-QH) disable.
X	X	X	X	L	Output (QA-QH) enable.
X	X	L	X	X	Shift register is cleared.
L		H	X	X	Condition of shift register in initial stage is "L". In the other stages, data from the former stage is stored.
H		H	X	X	Condition of shift register in initial stage is "H". In the other stages, data from the former stage is stored.
X		H	X	X	Shift register does not change.
X	X	X		X	Shift register data is stored in the storage register.
X	X	X		X	Shift register does not change.

X: Don't care

■ LC7522 (IC641) : Variable Resistor for SEA Control

(1) Terminal Layout

(2) Block Diagram

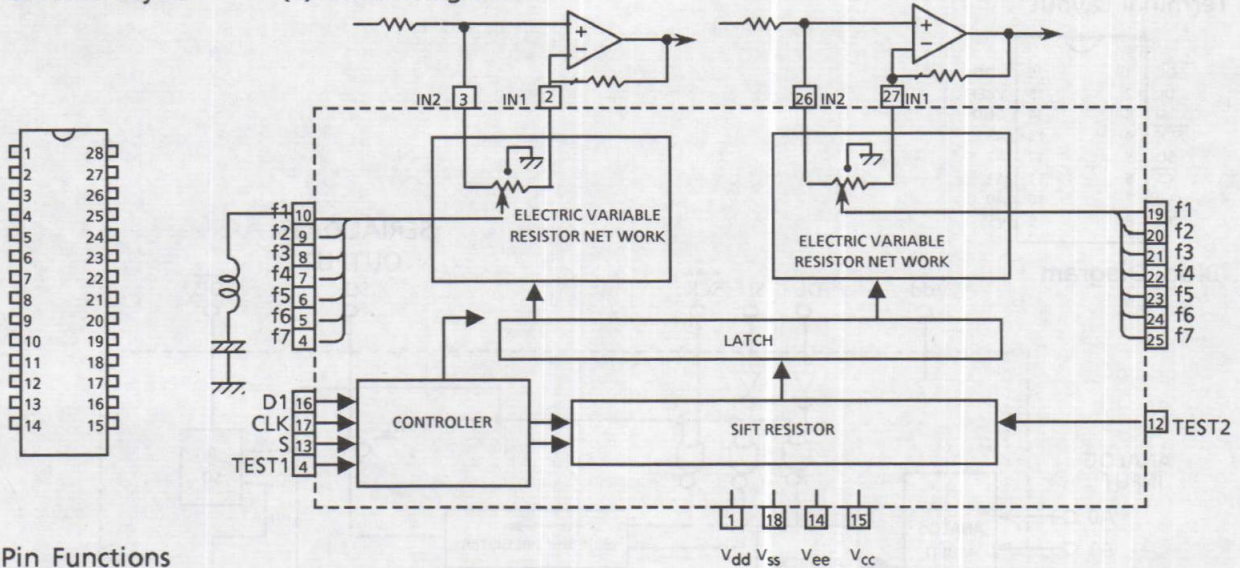

(3) Pin Functions

Pin No.	Pin Name	Functions
1	V _{DD}	Power supply +7V for audio signal
18	V _{SS}	Ground.
14	V _{EE}	Power supply -7V for audio signal.
15	V _{CC}	Power supply +5V
2,27 3,26	IN 1 IN 2	Audio signal input The inversion signal of the operational amplifier inputs to IN 1 normally. The non-inversion signal of the operational amplifier inputs to IN 2 normally.
16	DI	Data input from the CPU. Schmitt inverter type
17	CLK	Clock signal input from the CPU. Schmitt inverter type
4~10 19~25	f1~f7	For connect to band-pass filter. f1~f7x2 (Left and Right)
11	TEST 1	Not use
12	TEST 2	Not use
13	S	Chip Select
28	NC	Not use

■ LA3607S (IC643,644) : S.E.A. Graphic Equalizer

1. Functions

It makes inductive characteristic instead of coil.

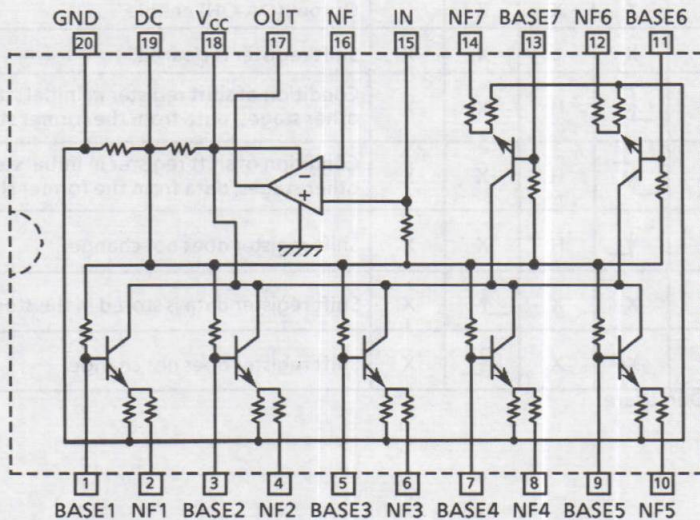

■ XR1091DCP (IC295) : Display Filter

63	1	16	Vdd
160	2	15	CLK / 2
400	3	14	CLK
1k	4	13	CLK
2k	5	12	GND
6k	6	11	L IN
16k	7	10	R IN
TOTAL	8	9	Vss

Pin No.	Symbol	Descriptions
1	63	Peak hold output of 63Hz band-pass filter
2	160	Peak hold output of 160Hz band-pass filter
3	400	Peak hold output of 400Hz band-pass filter
4	1k	Peak hold output of 1kHz band-pass filter
5	2k	Peak hold output of 2kHz band-pass filter
6	6k	Peak hold output of 6kHz band-pass filter
7	16k	Peak hold output of 16kHz band-pass filter
8	TOTAL	Total frequency output (peak hold)
9	Vss	Power supply (-6V)
10	R IN	Right channel input
11	L IN	Left channel input : Connecting to ground
12	GND	Ground terminal
13	CLK	Connecting capacitor for clock
14	CLK	Connecting resistor to pin 13 for clock
15	CLK / 2	1/2 clock output (Non connection)
16	Vdd	Power supply (+6V)

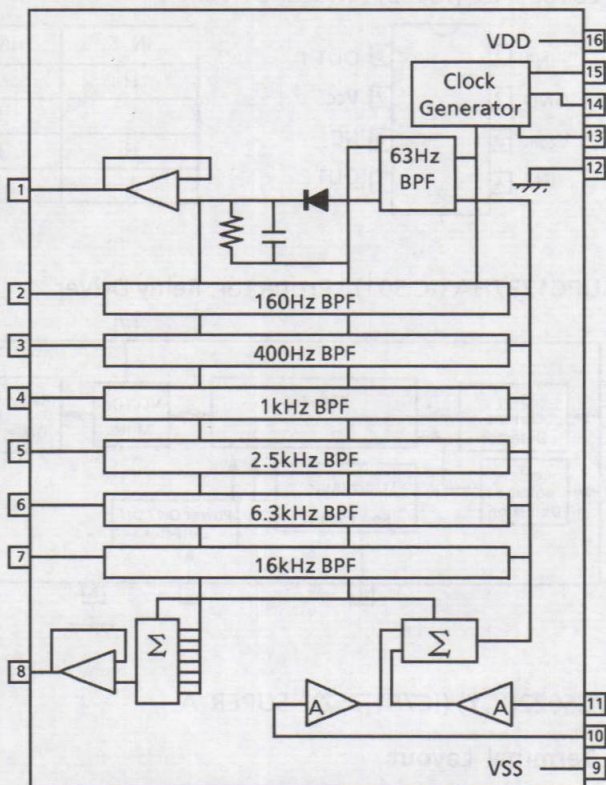

■ TC74HC154AP (IC904) : Shift Resistor

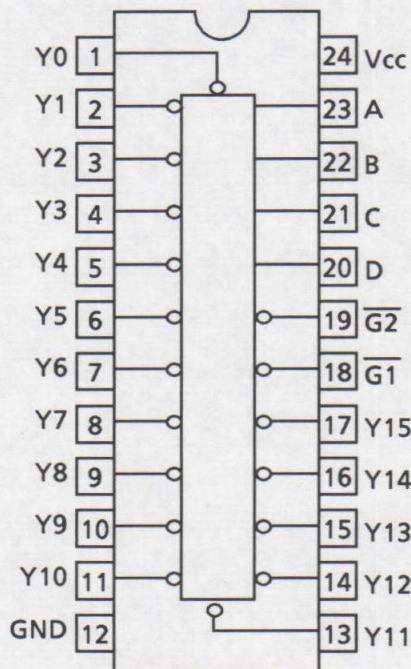

Function Table

		Input				Output
$\overline{G1}$	$\overline{G2}$	D	C	B	A	
L	L	L	L	L	L	Y0
L	L	L	L	L	H	Y1
L	L	L	L	H	L	Y2
L	L	L	L	H	H	Y3
L	L	L	H	L	L	Y4
L	L	L	H	L	H	Y5
L	L	L	H	H	L	Y6
L	L	L	H	H	H	Y7
L	L	H	L	L	L	Y8
L	L	H	L	L	H	Y9
L	L	H	L	H	L	Y10
L	L	H	L	H	H	Y11
L	L	H	H	L	L	Y12
L	L	H	H	L	H	Y13
L	L	H	H	H	L	Y14
L	L	H	H	H	H	Y15
x	H	x	x	x	x	—
H	x	x	x	x	x	—

x : Don't care

Internal Block Diagram of Other ICs

■ LB1639-CV (IC402) : Motor Driver

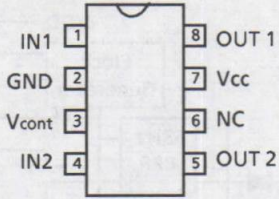

IN 1	IN 2	OUT 1	OUT 2	MOTOR
H	L	H	L	CLOCKWISE
L	H	L	H	COUNTER-CLOCKWISE
H	H	OFF	OFF	WAITING
L	L	OFF	OFF	WAITING

■ UPC1237HA (IC 501) : Protector, Relay Driver

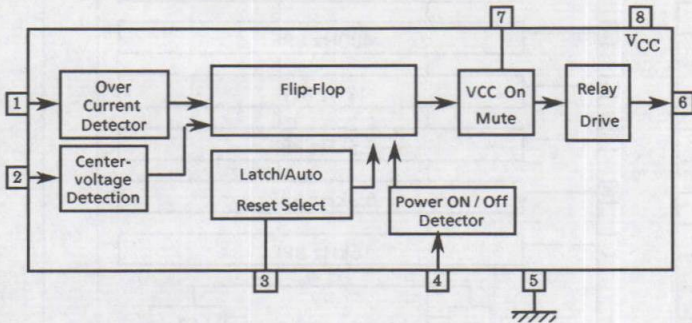

■ VC5022(X,Y) (IC751,752) : SUPER A

(1) Terminal Layout

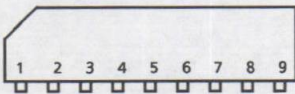

(2) Block Diagram

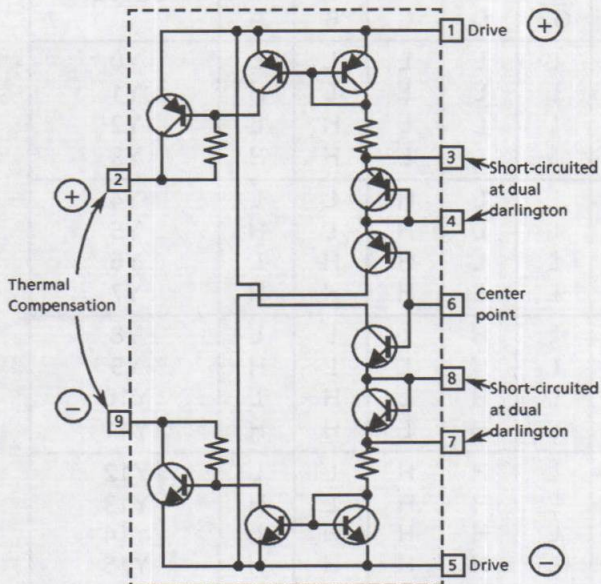

Internal Wiring of FL Display

■ ELU-0001-121 (FL901)

1. Terminal Layout

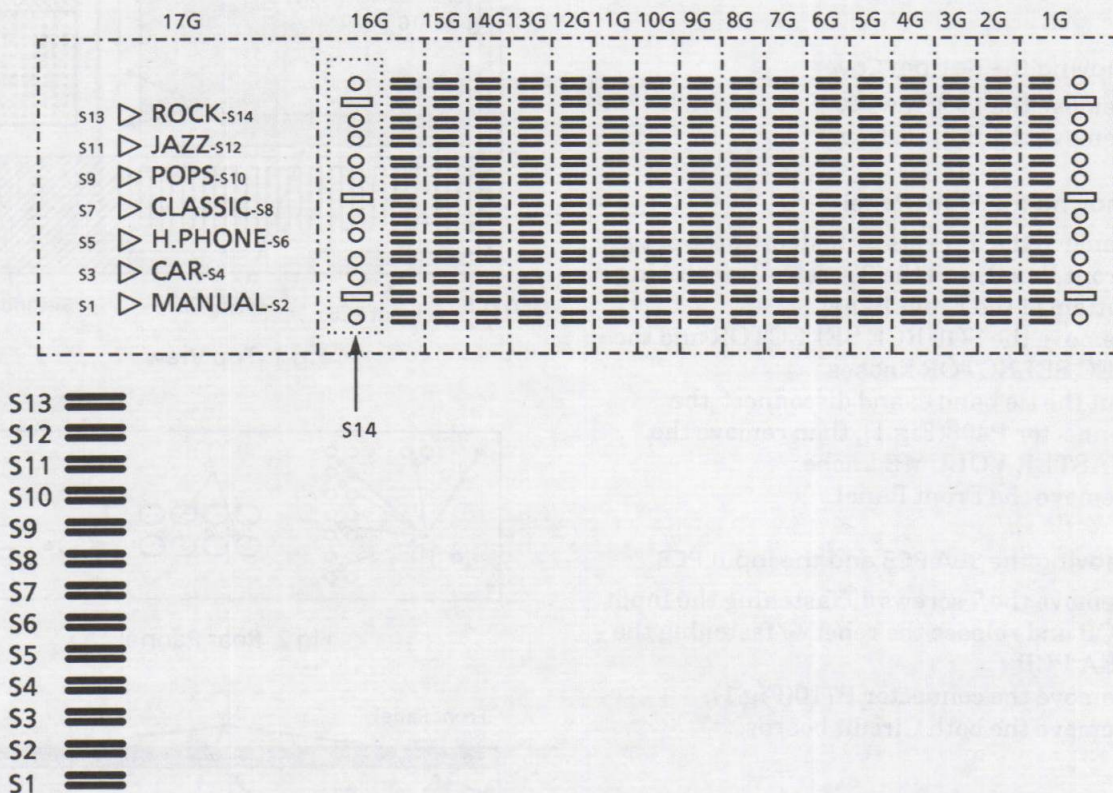

2. Pin Connection

Terminal No	1	2	3	4	5	6	7	8	9	10	11	12	13	14	15	16	17	18	19	20	21	22	23
ELECTRODE	F1	F1	NP	NC	17G	S1	S2	S3	17G	S4	S5	16G	16G	S6	15G	S7	14G	S8	13G	S9	12G	S10	11G
Terminal No	24	25	26	27	28	29	30	31	32	33	34	35	36	37	38	39	40	41	42	43	44	45	46
ELECTRODE	10G	S11	9G	S12	8G	S13	7G	S14	6G	5G	NC	4G	NC	3G	NC	2G	NC	1G	NC	1G	NP	F2	F2

Note) F: Filament NP: No Pin
G: Grid NC: No Connection
P: Anode

Disassembly Procedures

1. Removing the Top Cover

- 1) Remove the 4 screws fastening both sides of the Top Cover, and the 2 screws fastening the rear sides.
- 2) Remove the Top Cover.

2. Removing the Bottom Cover

- 1) Remove the 19 screws (K).
- 2) Remove the Bottom Cover.

3. Removing the Front Panel

- 1) Remove the 3 revets (A) fastening top of the Front Panel, and the 3 screws (L) fastening bottom of the Front Panel.
- 2) Remove the SOURCE SELECTOR and the REC SELECTOR knobs.
- 3) Cut the tie band (B) and disconnect the connector P408(Fig.1), then remove the MASTER VOLUME knob.
- 4) Remove the Front Panel.

4. Removing the SEA PCB and the Input PCB

- 1) Remove the 7 screws (H) fastening the Input PCB and release the rebet (C) fastening the SEA PCB
- 2) Remove the connector P710(Fig.1).
- 3) Remove the both Circuit boards.

5. Removing the Speaker Terminals

- 1) Remove the 2 screws (I) on the Bottom Cover.
- 2) Remove the 5 screws (E), (F).
- 3) Slide the Main PCB to the front with lifting it up.
- 4) Remove the 2 screws (I) and remove the Speaker Terminals.

6. Removing the Master Volume PCB

- 1) Remove the Master Volume knob.
- 2) Remove the nut fastening the Master Volume.
- 3) Cut the Tie Band (B), (C) and (D).
- 4) Disconnect the connector P408(Fig.1) and P407(Fig.4).
- 5) Remove the Master Volume PCB.

※ How to check the System Control PCB

- 1) Remove the 4 connectors P902, P903, P904 and P905.
- 2) Remove the 3 revets (M).
- 3) Lift the System Control PCB up above the Secondary PCB of the Transformer.
- 4) Connect the connectors P902~905 again.
- 5) Check the PCB.

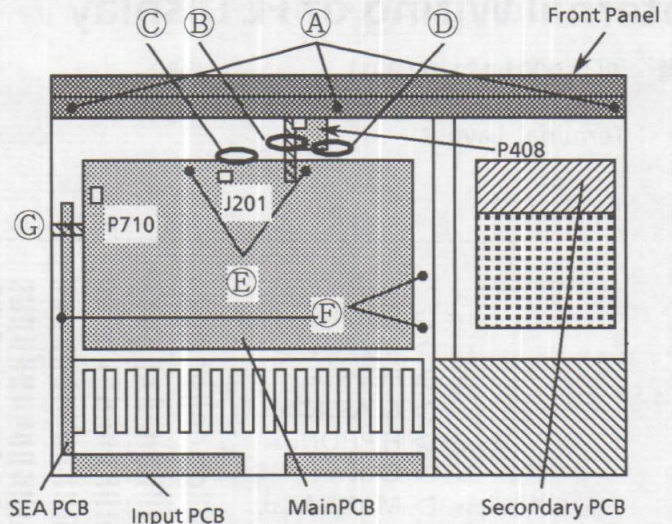

Fig 1. Top View

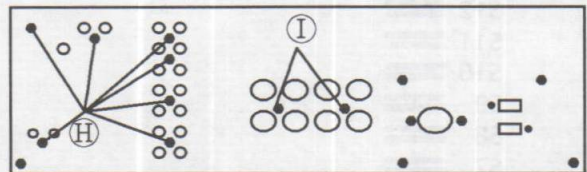

Fig 2. Rear Panel

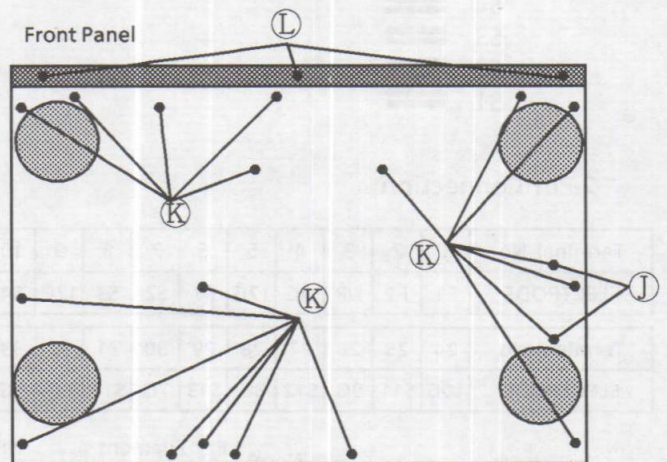

Fig 3. Bottom Cover

These PCBs are fixed by the nuts of the variable resistors.

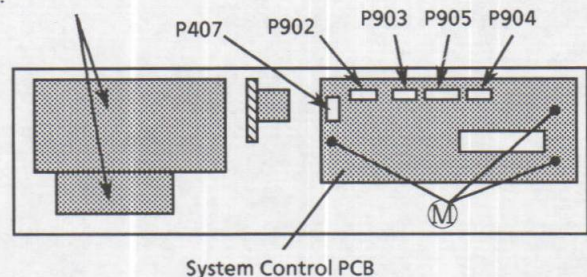
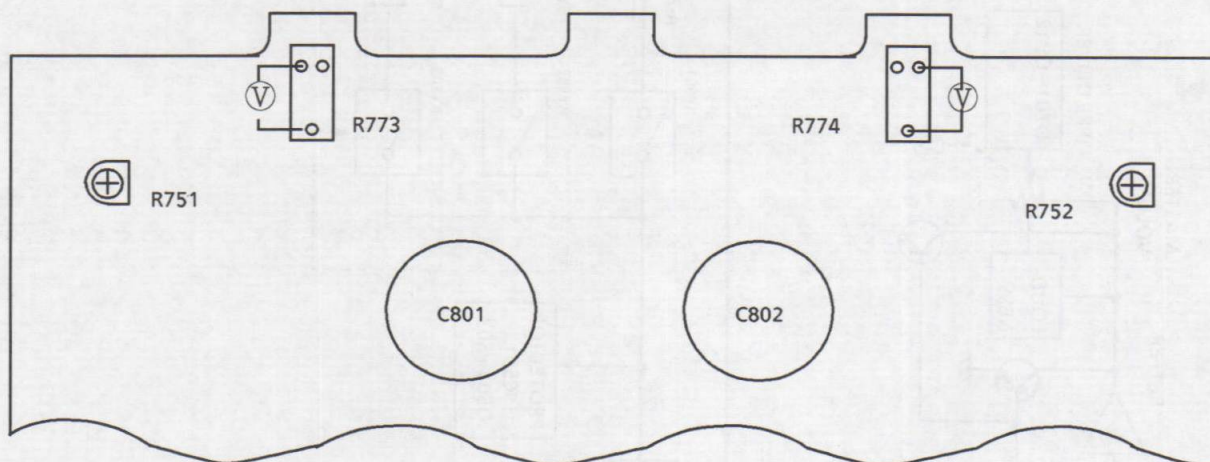

Fig 4. Rear View of the Front Panel Bracket

Power Amplifier Adjustment Procedures



■ Idling Current

- (1) Set the volume control to minimum during this adjustment.
- (2) Turn R751 and R752 fully counterclockwise before the power switch on.
- (3) Always start from cold, and allow 5 minutes to warm up before adjustment. If the heatsink is already warm from previous use the correct adjustment can not be made.
- (5) Connect a DC voltmeter to R773 resistor's leads for left channel, or to R774 for right channel.
- (6) Adjust R751 for left channel, or R752 for right channel, so that the DC voltmeter becomes 7mV ~ 15mV

Block Diagram

Audio & Power Supply Section

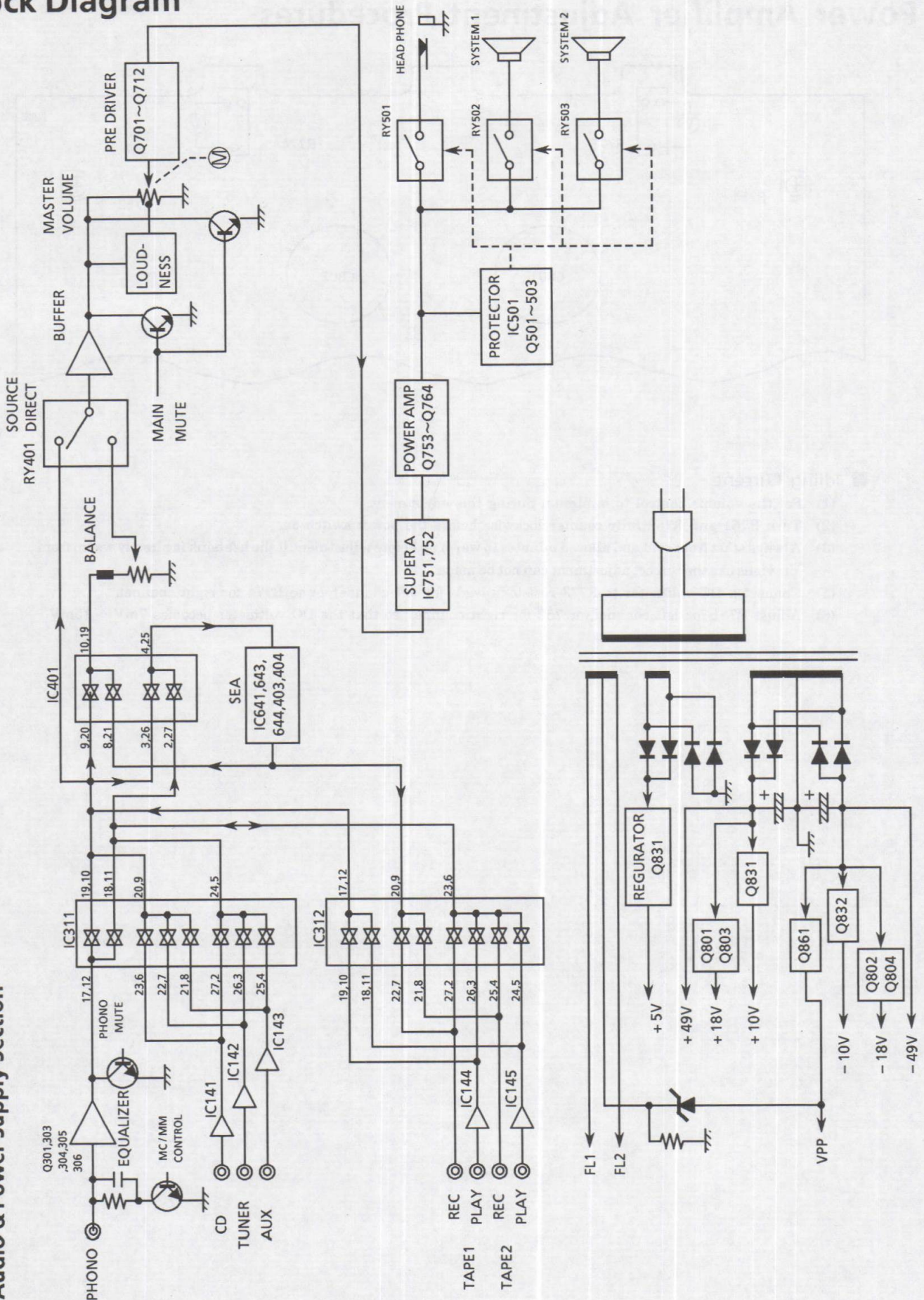

Schematic Diagrams

■ Source, REC Selector & SEA Section

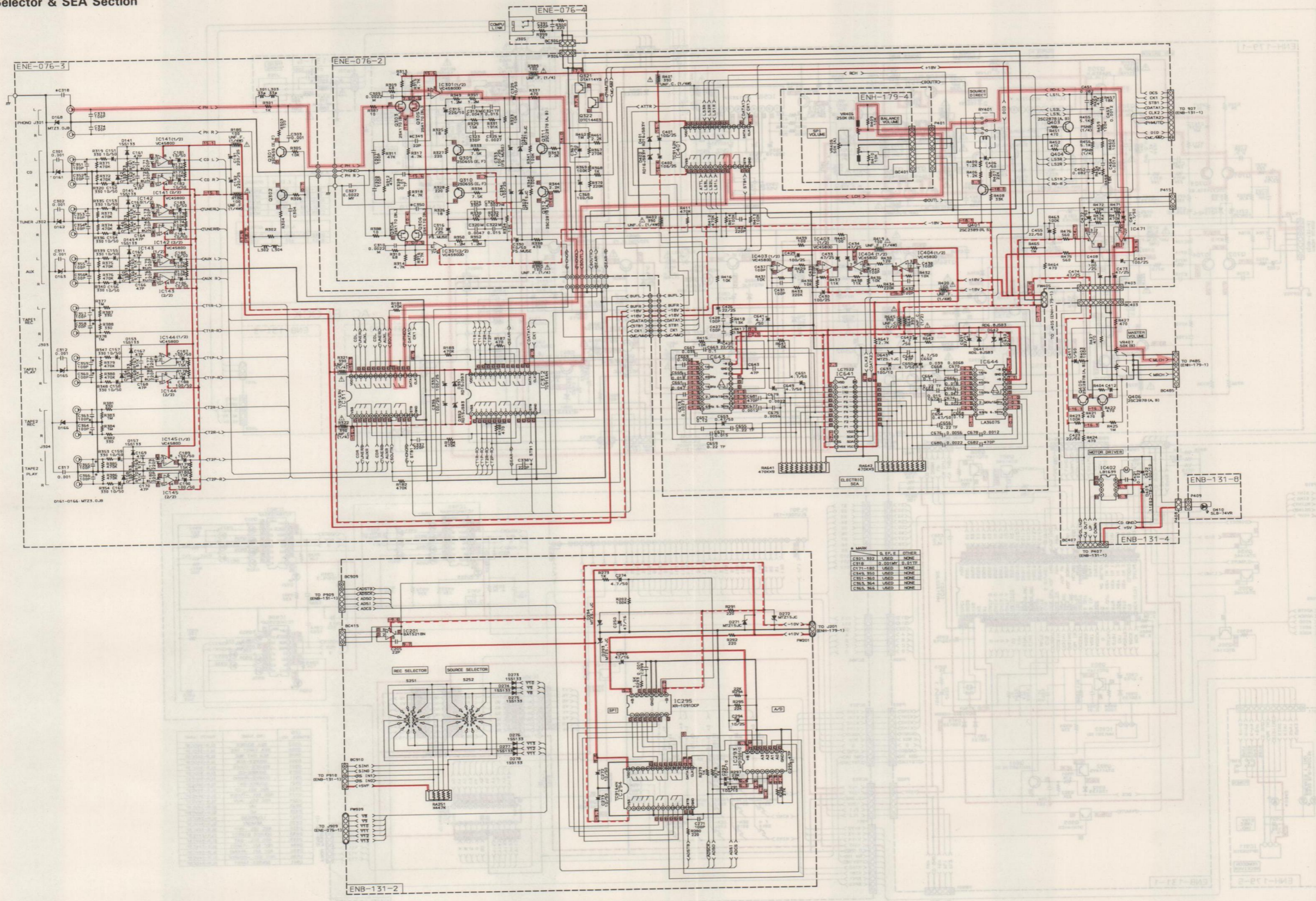

- Notes:**
1. Shows DC voltage to the chassis with no signal input.
 2. indicates +B power supply.
 3. indicates -B power supply.
 4. indicates signal path.

5. When replacing the parts in the darkened are () and those marked with Δ, be sure to use the designated parts to ensure safety.
6. This is the standard circuit diagram.
The design and contents are subject to change without notice.

Power Amplifier & System, Display Control Section

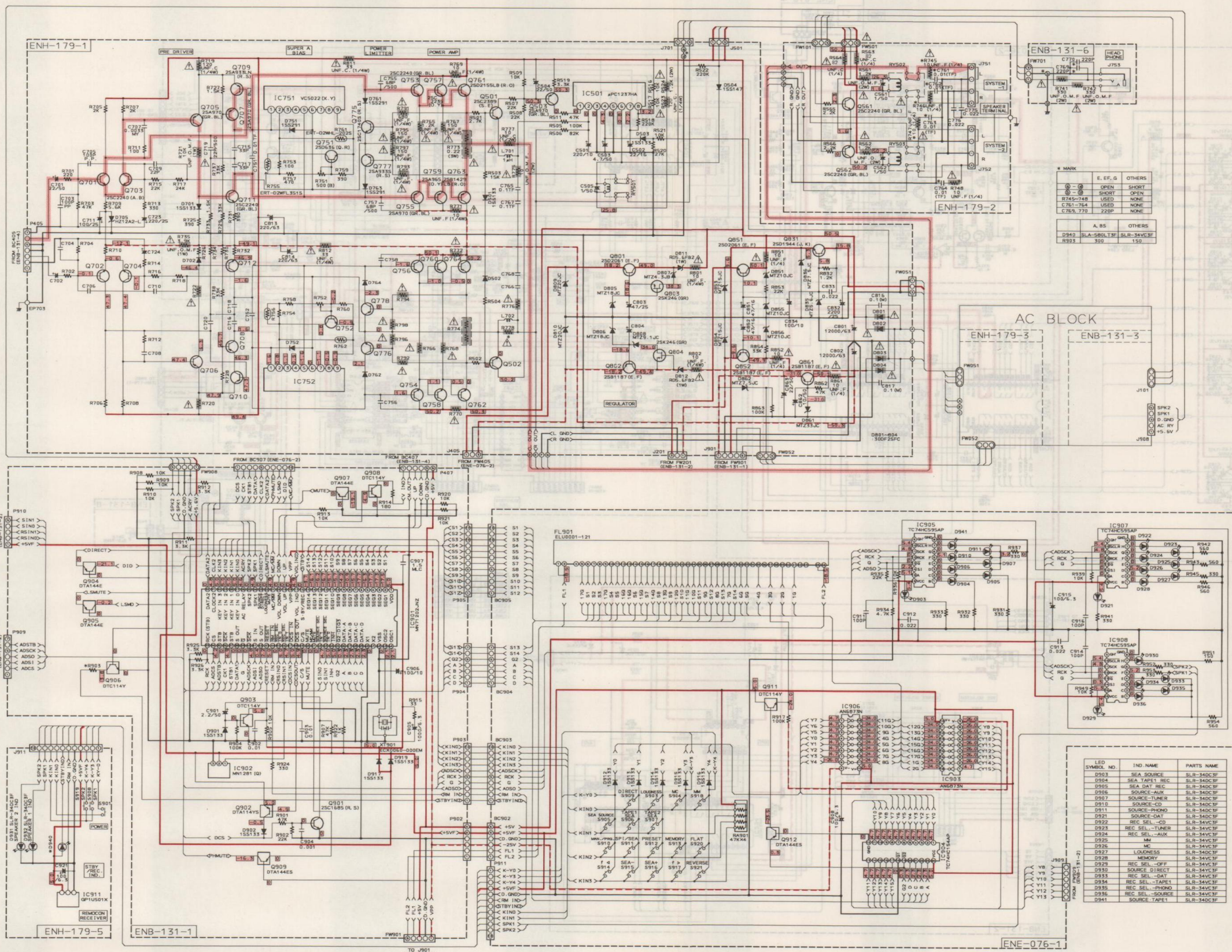

MARK

○	E.F.F.	OTHERS
○	OPEN	SHORT
○	SHORT	OPEN
○	R745-748	USED
○	C761-764	USED
○	C769, 770	220P

D940	SLA-58013P	SLR-34VC3P
R991	300	130

LED SYMBOL NO.	IND. NAME	PARTS NAME
D903	SEA SOURCE	SLR-34DC3P
D904	SEA TAPE1 REC	SLR-34DC3P
D905	SEA DAT REC	SLR-34DC3P
D906	SOURCE-AUX	SLR-34DC3P
D907	SOURCE-TUNER	SLR-34DC3P
D908	SOURCE-CD	SLR-34DC3P
D909	SOURCE-PHONO	SLR-34DC3P
D910	SOURCE-DAT	SLR-34DC3P
D911	REC SEL-CD	SLR-34VC3P
D912	REC SEL-TUNER	SLR-34VC3P
D913	REC SEL-AUX	SLR-34VC3P
D914	MC	SLR-34VC3P
D915	LOADNESS	SLR-34DC3P
D916	MEMORY	SLR-34VC3P
D917	REC SEL-OFF	SLR-34VC3P
D918	SOURCE DIRECT	SLR-34VC3P
D919	REC SEL-DAT	SLR-34VC3P
D920	REC SEL-TAPE1	SLR-34VC3P
D921	REC SEL-PHONO	SLR-34VC3P
D922	REC SEL-SOURCE	SLR-34VC3P
D923	SOURCE TAPE1	SLR-34DC3P

Notes:

- Shows DC voltage to the chassis with no signal input.
- indicates +B power supply.
- indicates -B power supply.
- indicates signal path.
- When replacing the parts in the darkened are () and those marked with Δ, be sure to use the designated parts to ensure safety.
- This is the standard circuit diagram.

Power Supply Section

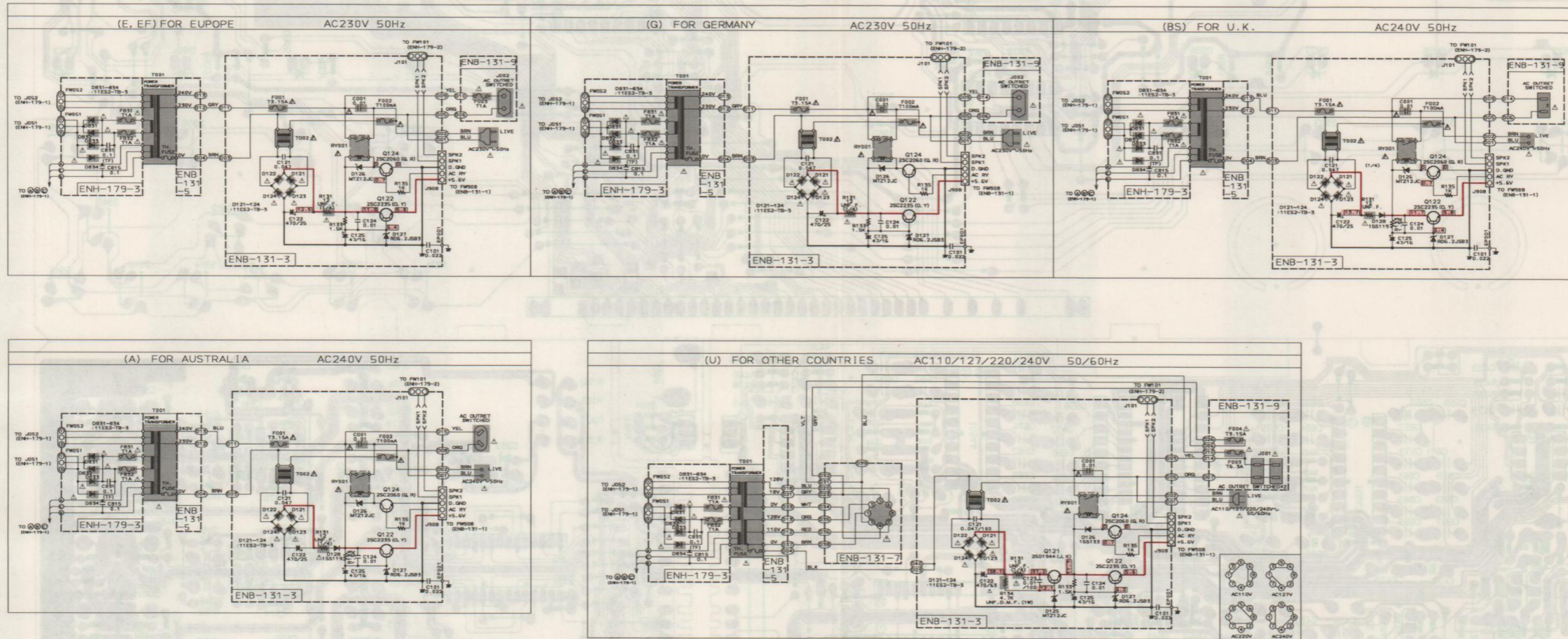

Notes:

- Shows DC voltage to the chassis with no signal input.
- indicates +B power supply.
- indicates -B power supply.
- indicates signal path.
- When replacing the parts in the darkened are () and those marked with Δ , be sure to use the designated parts to ensure safety.
- This is the standard circuit diagram. The design and contents are subject to change without notice.

Printed Circuit Boards

■ Input, SEA & Display PCB (ENE-076)

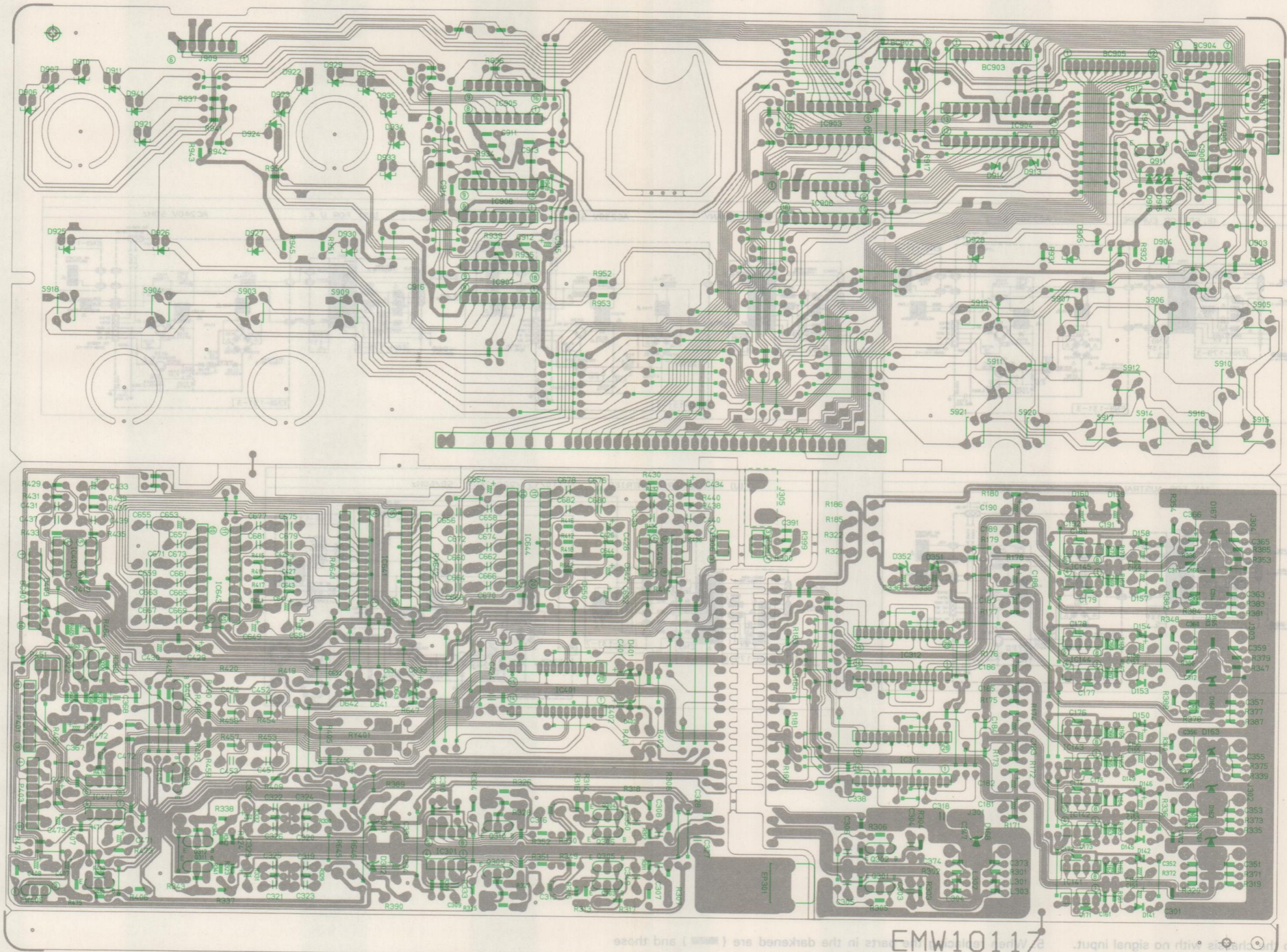

EMW10117

Power Amplifier & Speaker Terminal PCB (ENH-179)

System Control Selector, M. Volume & Power Supply PCB (ENB-131)

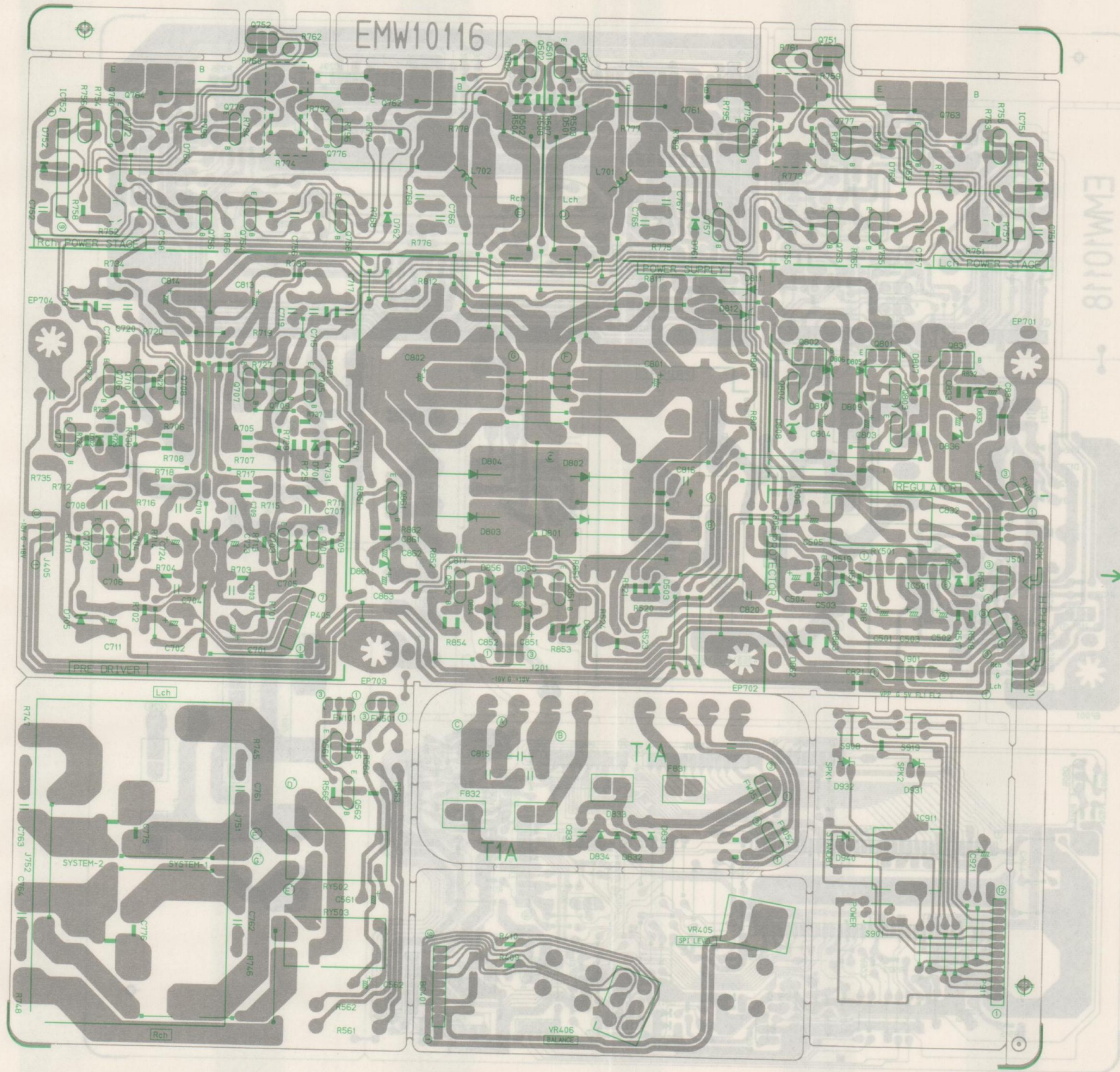

System Control, Selector, M. Volume & Power Supply PCB (ENB-131)

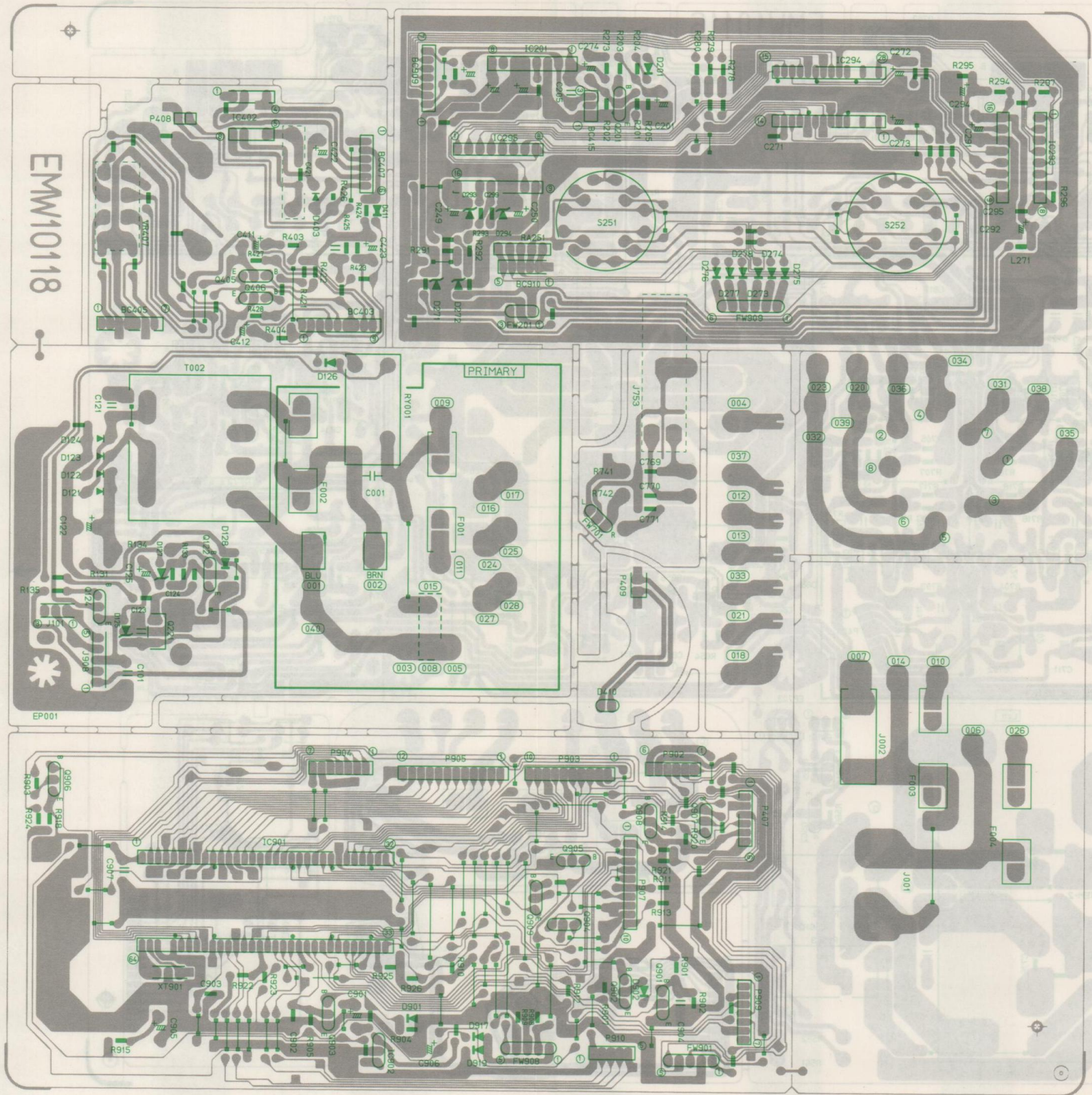

Connection Diagrams

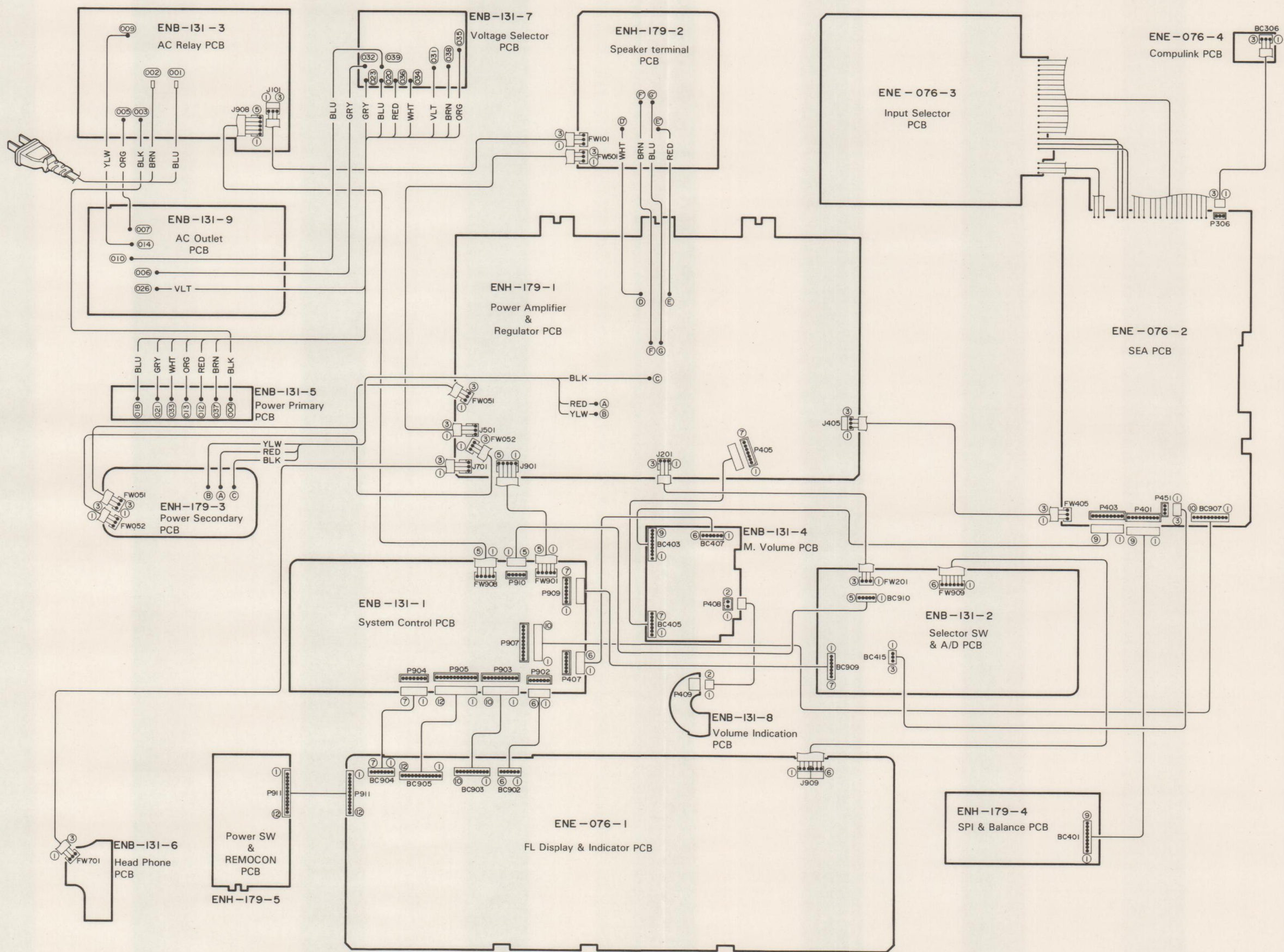

PARTS LIST

Contents

General Exploded View and Parts List	2-2
Printed Circuit Board Ass'y and Parts List	2-9
■ ENE-076 <input type="checkbox"/> Input , SEA & Display PC Board Ass'y	2-9
■ ENB-131 <input type="checkbox"/> System Control , Selector , M.Volume & Power Supply PC Board Ass'y	2-13
■ ENH-179 <input type="checkbox"/> Power Amplifier & Speaker Terminal PC Board Ass'y	2-16
Accessories List	2-19
Packing Materials and Part Numbers	2-20

General Exploded View and Parts List

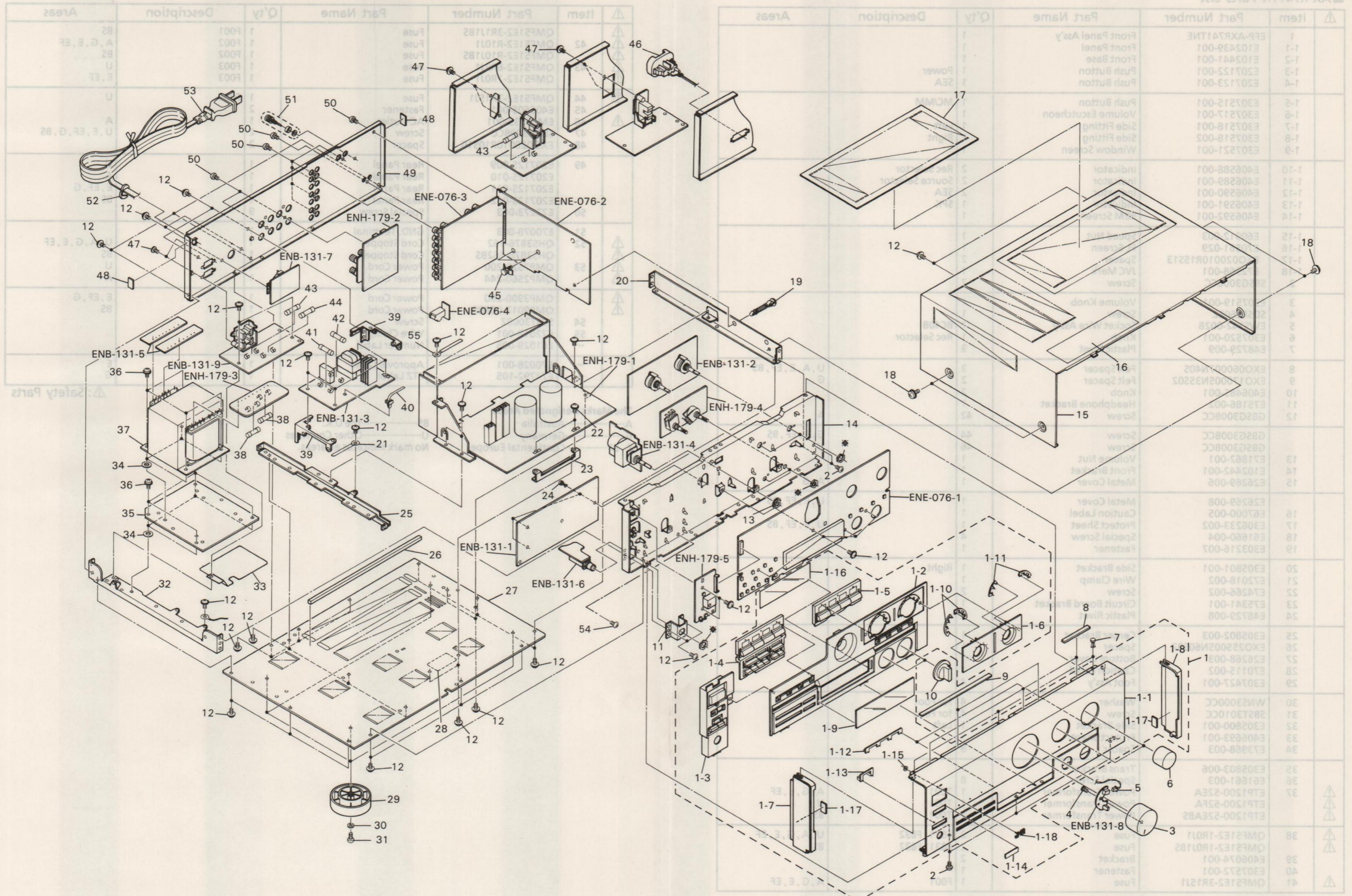

* mark indicates attached part.

■ AX-R741TN Parts List

⚠	Item	Part Number	Part Name	Q'ty	Description	Areas
	1	EFP-AXR741TNE	Front Panel Ass'y	1		
	1-1	E102439-001	Front Panel	1		
	1-2	E102441-001	Front Base	1		
	1-3	E207122-001	Push Button	1	Power	
	1-4	E207123-001	Push Button	1	SEA	
	1-5	E307515-001	Push Button	1	MC/MM	
	1-6	E307517-001	Volume Escutcheon	1		
	1-7	E307518-001	Side Fitting	1	Left	
	1-8	E307518-002	Side Fitting	1	Right	
	1-9	E307521-001	Window Screen	1		
	1-10	E406588-001	Indicator	2	Rec Selector	
	1-11	E406589-001	Indicator	2	Source Selector	
	1-12	E406590-001	Indicator	2	SEA	
	1-13	E406591-001	Indicator	1	SPK	
	1-14	E406592-001	REM Screen	1		
	1-15	E60912-003	Speed Nut	1		
	1-16	E70561-029	FL Screen	1		
	1-17	EXO020010R15S13	Spacer	2		
	1-18	E72968-001	JVC Mark	1		
	2	SBSG3008CC	Screw	7		
	3	E307519-001	Volume Knob	1		
	4	SDSF2608Z	Screw	1		
	5	EWS142-002B	Socket Wire Ass'y	1	BC408	
	6	E307520-001	Knob	1	Rec Selector	
	7	E48729-009	Plastic Rivet	3		
	8	EXO060007N40S	Felt Spacer	3		U, A, E, EF, BS
	9	EXO170005N35S02	Felt Spacer	2		G
	10	E406485-001	Knob	2		
	11	E75186-002	Headphone Bracket	1		
	12	GBSG3008CC	Screw	42		A
		GBSG3008CC	Screw	44		G, E, EF, BS
		GBSG3008CC	Screw	46		U
	13	E71862-001	Volume Nut	1		
	14	E102442-001	Front Bracket	1		
	15	E26269-006	Metal Cover	1		A, G
	16	E26269-008	Metal Cover	1		U, E, EF, BS
	17	E67000-005	Caution Label	1		
	18	E306233-002	Protect Sheet	1		U, E, EF, BS
	19	E61660-004	Special Screw	4		
	19	E303216-007	Fastener	1		
	20	E305801-001	Side Bracket	1	Right	
	21	E72018-002	Wire Clamp	1		
	22	E74266-002	Screw	2		
	23	E75341-001	Circuit Board Bracket	1		
	24	E48729-008	Plastic Rivet	3		
	25	E305802-003	Center Bracket	1		
	26	EXO255005N60S02	Spacer	1		
	27	E26268-003	Bottom Cover	1		
	28	E70115-002	Caution Label	1		
	29	E307427-001	Foot Ass'y	4		
	30	WNS3000CC	Washer	4	for Foot	
	31	SBST3010CC	Screw	4	for Foot	
	32	E305800-001	Side Bracket	1	Left	
	33	E406693-001	Protect Sheet	1		
	34	E73968-003	Spacer	8		
	35	E305803-006	Trans Bracket	1		
	36	E61661-003	Special Screw	8		
⚠	37	ETP1200-52EA	Power Transformer	1	T001	A, G, E, EF
⚠		ETP1200-52FA	Power Transformer	1	T001	U
⚠		ETP1200-52EABS	Power Transformer	1	T001	BS
⚠	38	QMF51E2-1R0J1	Fuse	2	F831, F832	U, A, G, E, EF
⚠		QMF51E2-1R0J1BS	Fuse	2	F831, F832	BS
	39	E406074-001	Bracket	2		
	40	E307572-001	Fastener	1		
⚠	41	QMF51E2-3R15J1	Fuse	1	F001	A, G, E, EF

⚠: Safety Parts

⚠	Item	Part Number	Part Name	Q'ty	Description	Areas
⚠		QMF51E2-3R1J1BS	Fuse	1	F001	BS
⚠		QMF51E2-R10J1	Fuse	1	F002	A, G, E, EF
⚠		QMF51E2-R10J1BS	Fuse	1	F002	BS
⚠	43	QMF51E2-6R3J1	Fuse	1	F003	U
⚠		QMF51E2-1R0J1	Fuse	1	F003	E, EF
⚠	44	QMF51E2-3R15J1	Fuse	1	F004	U
⚠	45	E406605-001	Fastener	2		
⚠	46	EMC0233-001	AC Outlet	1		A
	47	SBSG3008CC	Screw	2		
	48	EXO020010R10S10	Spacer	2		U, E, EF, G, BS
	49	E207125-009	Rear Panel	1		U
		E207125-010	Rear Panel	1		A
		E207125-011	Rear Panel	1		E, EF, G
		E207125-012	Rear Panel	1		BS
	50	E73273-003	Special Screw	9		
⚠	51	E70078-003	GND. Terminal	1		
⚠	52	QHS3876-162	Cord Stopper	1		U, A, G, E, EF
⚠		QHS3876-162BS	Cord Stopper	1		BS
⚠	53	QMP7520-200	Power Cord	1		U
⚠		QMP2560-244	Power Cord	1		A
⚠		QMP3900-200	Power Cord	1		E, EF, G
⚠		QMP9017-008BS	Power Cord	1		BS
	54	SBST3008Z	Screw	1		
	55	E72018-001	Wire Clamp	1		
	-	E61029-005	Number Label	1		
	-	E70028-001	Approval Label	1		E
	-	E74792-105	FTZ Label	1		G

⚠: Safety Parts

The Marks Designated Areas

A.....Australia
G.....Germany
E, EF.....Continental Europe

BS.....the U.K.
U.....Other Countries
No mark indicates all areas.

* mark indicates attached part.

■ AX-R742BK Parts List

Item	Part Number	Part Name	Q'ty	Description	Areas
1	EFP-AXR742BKE	Front Panel Ass'y	1		
1-1	E102439-002	Front Panel	1		
1-2	E102441-002	Front Base	1		
1-3	E207122-002	Push Button	1	Power	
1-4	E207123-002	Push Button	1	SEA	
1-5	E307515-002	Push Button	1	MC/MM	
1-6	E307517-002	Volume Escutchion	1		
1-7	E307518-003	Side Fitting	1	Left	
1-8	E307518-004	Side Fitting	1	Right	
1-9	E307521-002	Window Screen	1		
1-10	E406588-001	Indicator	2	Rec Selector	
1-11	E406589-001	Indicator	2	Source Selector	
1-12	E406590-001	Indicator	2	SEA	
1-13	E406591-001	Indicator	1	SPK	
1-14	E406592-001	REM Screen	1		
1-15	E60912-003	Speed Nut	1		
1-16	E70561-029	FL Screen	1		
1-18	EXO020010R15S13	Spacer	2		
1-18	E72968-001	JVC Mark	1		
2	SBSG3008CC	Screw	7		
3	E307519-002	Volume Knob	1		
4	SDSF2608Z	Screw	1		
5	EWS142-002B	Socket Wire Ass'y	1	BC408	
6	E307520-002	Knob	1	Rec Selector	
7	E48729-009	Plastic Rivet	3		
8	EXO060007N40S	Felt Spacer	3		U, A, E, EF
9	EXO170005N35S02	Felt Spacer	2		G
10	E406485-002	Knob	2		
11	E75186-002	Headphone Bracket	1		
12	GBSG3008CC	Screw	42		A
	GBSG3008CC	Screw	44		G, E, EF
	GBSG3008CC	Screw	46		U
13	E71862-001	Volume Nut	1		
14	E102442-001	Front Bracket	1		
15	E26269-007	Metal Cover	1		A, G
16	E26269-009	Metal Cover	1		U, E, EF
17	E67000-005	Caution Label	1		
18	E306233-002	Protect Sheet	1		U, E, EF
18	E61660-004	Special Screw	4		
19	E303216-007	Fastener	1		
20	E305801-001	Side Bracket	1	Right	
21	E72018-002	Wire Clamp	1		
22	E74266-002	Screw	2		
23	E75341-001	Circuit Board Bracket	1		
24	E48729-008	Plastic Rivet	3		
25	E305802-003	Center Bracket	1		
26	EXO255005N60S02	Spacer	1		
27	E26268-003	Bottom Cover	1		
28	E70115-002	Caution Label	1		
29	E307427-002	Foot Ass'y	4		
30	WNS3000CC	Washer	4	for Foot	
31	SBST3010CC	Screw	4	for Foot	
32	E305800-001	Side Bracket	1	Left	
33	E406693-001	Protect Sheet	1		
34	E73968-003	Spacer	8		
35	E305803-006	Trans Bracket	1		
36	E61661-003	Special Screw	8		
37	ETP1200-52EA	Power Transformer	1	T001	A, G, E, EF
37	ETP1200-52FA	Power Transformer	1	T001	U
38	QMF51E2-1R0J1	Fuse	2	F831, F832	U, A, G, E, EF
39	E406074-001	Bracket	2		
40	E307572-001	Fastener	1		
41	QMF51E2-3R15J1	Fuse	1	F001	A, G, E, EF
42	QMF51E2-R10J1	Fuse	1	F002	A, G, E, EF
43	QMF51E2-6R3J1	Fuse	1	F003	U

⚠: Safety Parts

Item	Part Number	Part Name	Q'ty	Description	Areas
44	QMF51E2-1R0J1	Fuse	1	F003	E, EF
45	QMF51E2-3R15J1	Fuse	1	F004	U
46	E406605-001	Fastener	2		
47	EMC0233-001	AC Outlet	1		A
47	SDSG3008CC	Screw	2		U, E, EF, G
48	EXO020010R10S10	Spacer	2		
49	E207125-013	Rear Panel	1		U
49	E207125-014	Rear Panel	1		A
49	E207125-015	Rear Panel	1		E, EF, G
50	E73273-003	Special Screw	9		
51	E70078-003	GND. Terminal	1		
52	QHS3876-162	Cord Stopper	1		U, A, G, E, EF
53	QMP7520-200	Power Cord	1		U
53	QMP2560-244	Power Cord	1		A
53	QMP3900-200	Power Cord	1		E, EF, G
54	SBST3008Z	Screw	1		
55	E72018-001	Wire Clamp	1		
-	E61029-005	Number Label	1		
-	E70028-001	Approval Label	1		E
-	E74792-106	FTZ Label	1		G

⚠: Safety Parts

The Marks Designated Areas

A.....Australia
G.....Germany
E, EF.....Continental Europe

U.....Other Countries
No mark indicates all areas.

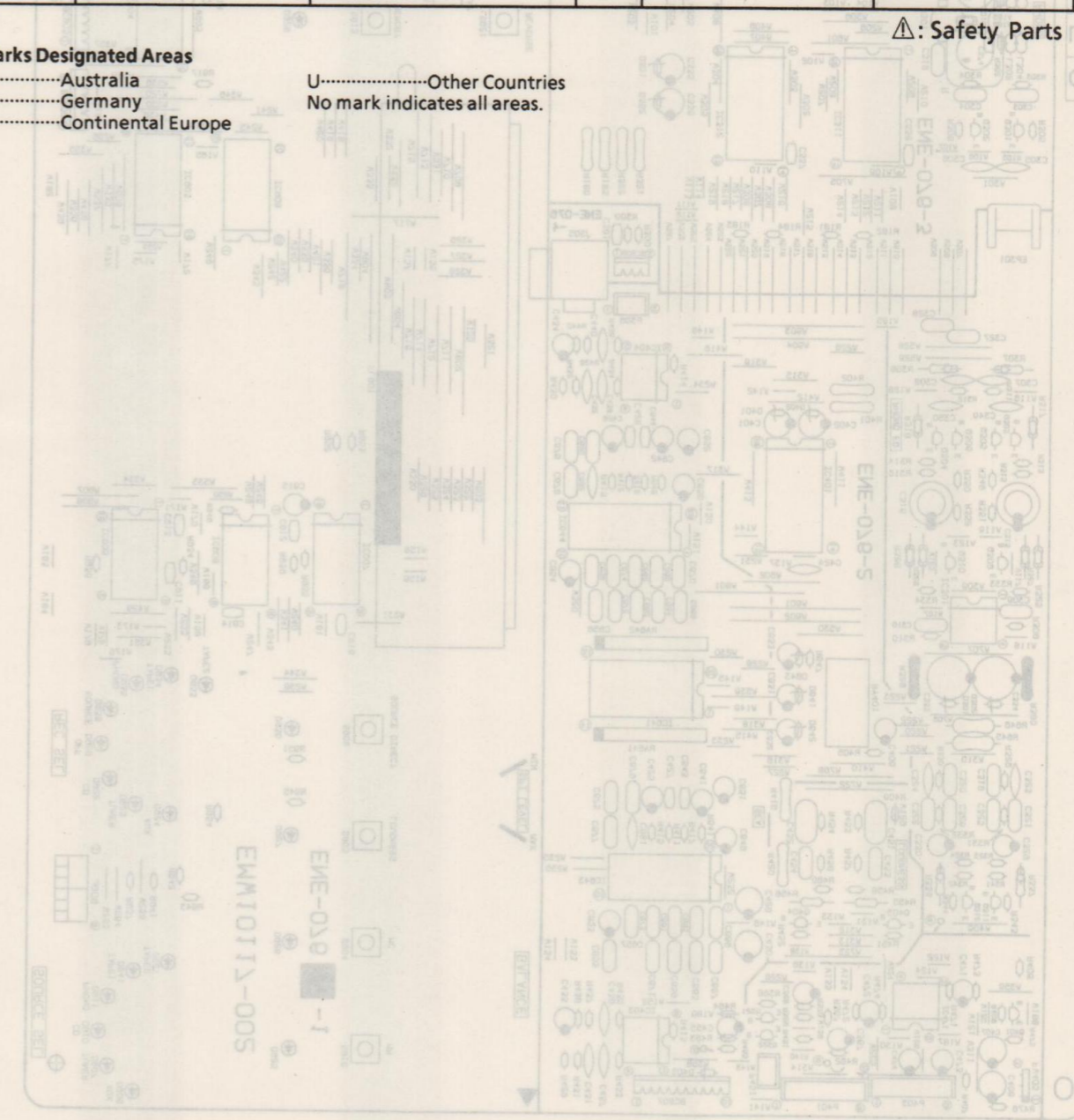

Printed Circuit Board Ass'y and Parts List

■ ENE-076 □ Input, SEA & Display PC Board Ass'y

Note : ENE-076 □ varies according to the areas employed. See note (1) when placing an order.

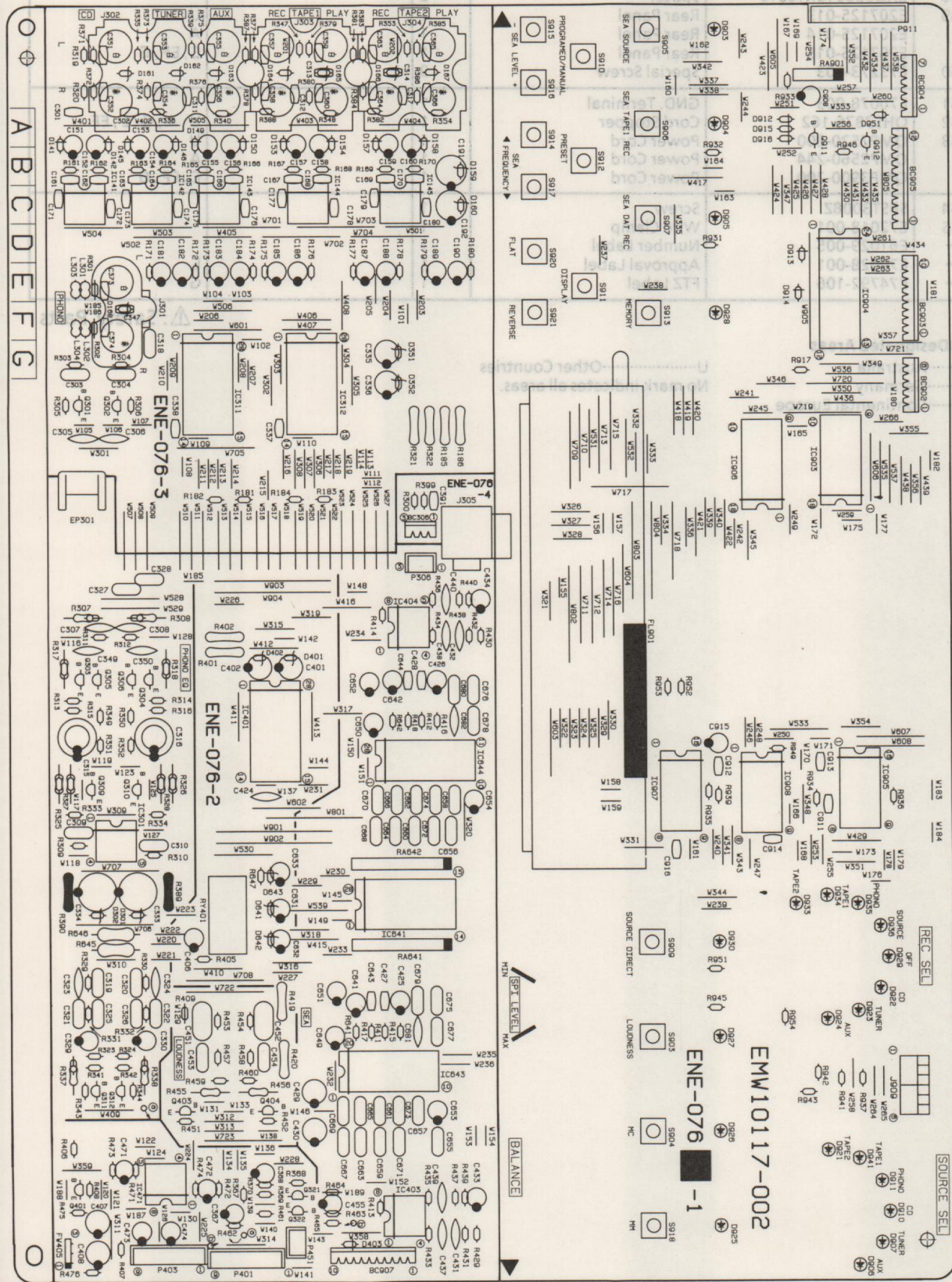

Note (1)

■ AX-R741TN

PC Board Ass'y	Designated Areas
ENE-076 A	Universal Type
ENE-076 B	Australia, the U.K.
ENE-076 C	Continental Europe, Germany

■ AX-R742BK

PC Board Ass'y	Designated Areas
ENE-076 A	Universal Type
ENE-076 B	Australia
ENE-076 C	Continental Europe, Germany

Transistors

ITEM	PART NUMBER	DESCRIPTION	AREA
Q301	2SD655(E,F)	SILICON HITACHI	
Q302	2SD655(E,F)	SILICON HITACHI	
Q303	2SK170(BL)	F.E.T TOSHIBA	
Q304	2SK170(BL)	F.E.T TOSHIBA	
Q305	2SK170(BL)	F.E.T TOSHIBA	
Q306	2SK170(BL)	F.E.T TOSHIBA	
Q309	2SD655(E,F)	SILICON HITACHI	
Q310	2SD655(E,F)	SILICON HITACHI	
Q311	2SC2878(A,B)	SILICON TOSHIBA	
Q312	2SC2878(A,B)	SILICON TOSHIBA	
Q321	DTA114YS	SILICON ROHM	
Q322	DTA114YS	SILICON ROHM	
Q401	2SC2389(S,E)	SILICON ROHM	
Q403	2SC2878(A,B)	SILICON TOSHIBA	
Q404	2SC2878(A,B)	SILICON TOSHIBA	
Q911	DTC114YS	SILICON ROHM	
Q912	DTA144ES	SILICON ROHM	

I.C.s

ITEM	PART NUMBER	DESCRIPTION	AREA
IC141	VC4580D	I.C. DAINICHI	
IC142	VC4580D	I.C. DAINICHI	
IC143	VC4580D	I.C. DAINICHI	
IC144	VC4580D	I.C. DAINICHI	
IC145	VC4580D	I.C. DAINICHI	
IC301	VC4580DD	I.C. DAINICHI	
IC311	TC9163N	I.C. TOSHIBA	
IC312	TC9164N	I.C. TOSHIBA	
IC401	TC9162N	I.C. TOSHIBA	
IC403	VC4580D	I.C. DAINICHI	
IC404	VC4580D	I.C. DAINICHI	
IC471	VC4580D	I.C. DAINICHI	
IC641	LC7522	I.C. SANYO	
IC643	LA3607S	I.C. SANYO	
IC644	LA3607S	I.C. SANYO	
IC903	AN6873N	I.C. MATSUSHITA	
IC904	TC74HC154AP	I.C. TOSHIBA	
IC905	TC74HC595AP	I.C. TOSHIBA	
IC906	AN6873N	I.C. MATSUSHITA	
IC907	TC74HC595AP	I.C. TOSHIBA	
IC908	TC74HC595AP	I.C. TOSHIBA	

Diodes

ITEM	PART NUMBER	DESCRIPTION	AREA
D141	1SS133	SILICON ROHM	
D142	1SS133	SILICON ROHM	
D145	1SS133	SILICON ROHM	
D146	1SS133	SILICON ROHM	
D149	1SS133	SILICON ROHM	
D150	1SS133	SILICON ROHM	
D153	1SS133	SILICON ROHM	
D154	1SS133	SILICON ROHM	
D157	1SS133	SILICON ROHM	
D158	1SS133	SILICON ROHM	

Diodes

ITEM	PART NUMBER	DESCRIPTION	AREA
D161	MT23.0JB	ZENER ROHM	
D162	MT23.0JB	ZENER ROHM	
D163	MT23.0JB	ZENER ROHM	
D165	MT23.0JB	ZENER ROHM	
D166	MT23.0JB	ZENER ROHM	
D168	MT23.0JB	ZENER ROHM	
D301	MT215JC	ZENER ROHM	
D302	MT215JC	ZENER ROHM	
D351	RD15JSB3	ZENER NEC	
D352	RD15JSB3	ZENER NEC	
D401	RD15JSB3	ZENER NEC	
D402	RD15JSB3	ZENER NEC	
D641	RD6.8JSB3	ZENER NEC	
D642	RD6.8JSB3	ZENER NEC	
D643	MT25.1JC	ZENER ROHM	
D903	SLR-34DC3F	L.E.D. ROHM	
D904	SLR-34DC3F	L.E.D. ROHM	
D905	SLR-34DC3F	L.E.D. ROHM	
D906	SLR-34DC3F	L.E.D. ROHM	
D907	SLR-34DC3F	L.E.D. ROHM	
D910	SLR-34DC3F	L.E.D. ROHM	
D911	SLR-34DC3F	L.E.D. ROHM	
D912	1SS133	SILICON ROHM	
D913	1SS133	SILICON ROHM	
D914	1SS133	SILICON ROHM	
D915	1SS133	SILICON ROHM	
D916	1SS133	SILICON ROHM	
D921	SLR-34DC3F	L.E.D. ROHM	
D922	SLR-34VC3F	L.E.D. ROHM	
D923	SLR-34VC3F	L.E.D. ROHM	
D924	SLR-34VC3F	L.E.D. ROHM	
D925	SLR-34VC3F	L.E.D. ROHM	
D926	SLR-34VC3F	L.E.D. ROHM	
D927	SLR-34DC3F	L.E.D. ROHM	
D928	SLR-34VC3F	L.E.D. ROHM	
D929	SLR-34VC3F	L.E.D. ROHM	
D930	SLR-34VC3F	L.E.D. ROHM	
D933	SLR-34VC3F	L.E.D. ROHM	
D934	SLR-34VC3F	L.E.D. ROHM	
D935	SLR-34VC3F	L.E.D. ROHM	
D936	SLR-34VC3F	L.E.D. ROHM	
D941	SLR-34DC3F	L.E.D. ROHM	

Capacitors

ITEM	PART NUMBER	DESCRIPTION	AREA
C151	EETB1HM-106E	10MF 50V ELECTRO	
C152	EETB1HM-106E	10MF 50V ELECTRO	
C153	EETB1HM-106E	10MF 50V ELECTRO	
C154	EETB1HM-106E	10MF 50V ELECTRO	
C155	EETB1HM-106E	10MF 50V ELECTRO	
C156	EETB1HM-106E	10MF 50V ELECTRO	
C157	EETB1HM-106E	10MF 50V ELECTRO	
C158	EETB1HM-106E	10MF 50V ELECTRO	
C159	EETB1HM-106E	10MF 50V ELECTRO	
C160	EETB1HM-106E	10MF 50V ELECTRO	
C161	QCSB1HJ-470	47PF 50V CERAMIC	
C162	QCSB1HJ-470	47PF 50V CERAMIC	
C163	QCSB1HJ-470	47PF 50V CERAMIC	
C164	QCSB1HJ-470	47PF 50V CERAMIC	
C165	QCSB1HJ-470	47PF 50V CERAMIC	
C166	QCSB1HJ-470	47PF 50V CERAMIC	
C167	QCSB1HJ-470	47PF 50V CERAMIC	
C168	QCSB1HJ-470	47PF 50V CERAMIC	
C169	QCSB1HJ-470	47PF 50V CERAMIC	
C170	QCSB1HJ-470	47PF 50V CERAMIC	
C171	QCBB1HK-221	220PF 50V CERAMIC	C
C172	QCBB1HK-221	220PF 50V CERAMIC	C
C173	QCBB1HK-221	220PF 50V CERAMIC	C
C174	QCBB1HK-221	220PF 50V CERAMIC	C
C175	QCBB1HK-221	220PF 50V CERAMIC	C
C176	QCBB1HK-221	220PF 50V CERAMIC	C
C177	QCBB1HK-221	220PF 50V CERAMIC	C
C178	QCBB1HK-221	220PF 50V CERAMIC	C
C179	QCBB1HK-221	220PF 50V CERAMIC	C
C180	QCBB1HK-221	220PF 50V CERAMIC	C
C181	EETB1HM-106E	10MF 50V ELECTRO	
C182	EETB1HM-106E	10MF 50V ELECTRO	
C183	EETB1HM-106E	10MF 50V ELECTRO	
C184	EETB1HM-106E	10MF 50V ELECTRO	
C185	EETB1HM-106E	10MF 50V ELECTRO	
C186	EETB1HM-106E	10MF 50V ELECTRO	
C187	EETB1AM-107E	100MF 10V ELECTRO	
C188	EETB1AM-107E	100MF 10V ELECTRO	
C189	EETB1AM-107E	100MF 10V ELECTRO	
C190	EETB1AM-107E	100MF 10V ELECTRO	
C191	EETB1EM-227E	220MF 25V ELECTRO	
C192	EETB1EM-227E	220MF 25V ELECTRO	
C301	QCSB1HK-102	1000PF 50V CERAMIC	
C302	QCSB1HK-102	1000PF 50V CERAMIC	
C303	QFN81HJ-102	1000PF 50V MYLAR	

Capacitors

ITEM	PART NUMBER	DESCRIPTION	AREA
C304	QFN81HJ-102	1000PF 50V MYLAR	
C307	QCS21HJ-101	100PF 50V CERAMIC	
C308	QCS21HJ-101	100PF 50V CERAMIC	
C309	QFN81HJ-222	2200PF 50V MYLAR	
C310	QFN81HJ-222	2200PF 50V MYLAR	
C311	QCGB1HK-102	1000PF 50V CERAMIC	
C312	QCGB1HK-102	1000PF 50V CERAMIC	
C315	EETB1AM-227E	220MF 10V ELECTRO	
C316	EETB1AM-227E	220MF 10V ELECTRO	
C317	QCGB1HK-102	1000PF 50V CERAMIC	
C318	QFVB1HJ-103N	0.01MF 50V T.FILM	A
C318	QFVB1HJ-103N	0.01MF 50V T.FILM	B
C318	QFN81HJ-102	1000PF 50V MYLAR	C
C319	QFN81HJ-472	4700PF 50V MYLAR	
C320	QFN81HJ-472	4700PF 50V MYLAR	
C321	QFVB1HJ-153N	0.015MF 50V T.FILM	
C322	QFVB1HJ-153N	0.015MF 50V T.FILM	
C323	QCS21HJ-331	330PF 50V CERAMIC	
C324	QCS21HJ-331	330PF 50V CERAMIC	
C325	QFN81HJ-272	2700PF 50V MYLAR	
C326	QFN81HJ-272	2700PF 50V MYLAR	
C327	QFN81HJ-222	2200PF 50V MYLAR	
C328	QFVB1HJ-103N	0.01MF 50V T.FILM	
C329	EETB1HM-106E	10MF 50V ELECTRO	
C330	EETB1HM-106E	10MF 50V ELECTRO	
C333	EETB1CM-107E	100MF 16V ELECTRO	
C334	EETB1CM-107E	100MF 16V ELECTRO	
C335	EETB1CM-107E	100MF 16V ELECTRO	
C336	EETB1CM-107E	100MF 16V ELECTRO	
C337	QCBB1HK-221	220PF 50V CERAMIC	
C338	QCBB1HK-221	220PF 50V CERAMIC	
C349	QCS21HJ-220	22PF 50V CERAMIC	
C350	QCS21HJ-220	22PF 50V CERAMIC	
C351	QCBB1HK-101	100PF 50V CERAMIC	C
C352	QCBB1HK-101	100PF 50V CERAMIC	C
C353	QCBB1HK-101	100PF 50V CERAMIC	C
C354	QCBB1HK-101	100PF 50V CERAMIC	C
C355	QCBB1HK-101	100PF 50V CERAMIC	C
C356	QCBB1HK-101	100PF 50V CERAMIC	C
C357	QCBB1HK-101	100PF 50V CERAMIC	C
C358	QCBB1HK-101	100PF 50V CERAMIC	C
C359	QCBB1HK-101	100PF 50V CERAMIC	C
C360	QCBB1HK-101	100PF 50V CERAMIC	C
C363	QCBB1HK-101	100PF 50V CERAMIC	C
C364	QCBB1HK-101	100PF 50V CERAMIC	C
C365	QCBB1HK-101	100PF 50V CERAMIC	C
C366	QCBB1HK-101	100PF 50V CERAMIC	C
C367	QETB1HM-105	1MF 50V ELECTRO	
C368	QETB1HM-107	100MF 50V ELECTRO	
C373	QCBB1HK-101	100PF 50V CERAMIC	
C374	QCBB1HK-101	100PF 50V CERAMIC	
C391	QCBB1HK-221	220PF 50V CERAMIC	
C401	EETB1CM-107E	100MF 16V ELECTRO	
C402	EETB1CM-107E	100MF 16V ELECTRO	
C406	QETB1HM-105	1MF 50V ELECTRO	
C407	EETB1CM-107E	100MF 16V ELECTRO	
C408	EETB1CM-107E	100MF 16V ELECTRO	
C424	QCS21HJ-221	220PF 50V CERAMIC	
C425	EETB1EM-226E	22MF 25V ELECTRO	
C426	EETB1EM-226E	22MF 25V ELECTRO	
C427	QCBB1HK-101	100PF 50V CERAMIC	
C428	QCBB1HK-101	100PF 50V CERAMIC	
C429	EETB1CM-107E	100MF 16V ELECTRO	
C430	EETB1CM-107E	100MF 16V ELECTRO	
C431	QCS21HJ-101	100PF 50V CERAMIC	
C432	QCS21HJ-101	100PF 50V CERAMIC	
C433	EETB1EM-476E	47MF 25V ELECTRO	
C434	EETB1EM-476E	47MF 25V ELECTRO	
C451	QFVB1HJ-823N	0.082MF 50V T.FILM	
C452	QFVB1HJ-823N	0.082MF 50V T.FILM	
C453	QFN81HJ-122	1200PF 50V MYLAR	
C454	QFN81HJ-122	1200PF 50V MYLAR	
C455	QETB1HM-226	22MF 50V ELECTRO	
C471	EETB1HM-475E	4.7MF 50V ELECTRO	
C472	EETB1HM-475E	4.7MF 50V ELECTRO	
C473	EETB1EM-476E	47MF 25V ELECTRO	
C474	EETB1EM-476E	47MF 25V ELECTRO	
C631	QETB1CM-226	22MF 16V ELECTRO	
C632	QETB1CM-226	22MF 16V ELECTRO	
C633	QETB1AM-107	100MF 10V ELECTRO	
C641	EETB1HM-475E	4.7MF 50V ELECTRO	
C642	EETB1HM-475E	4.7MF 50V ELECTRO	
C643	QCSB1HJ-470	47PF 50V CERAMIC	
C644	QCSB1HJ-470	47PF 50V CERAMIC	
C649	EETB1HM-475E	4.7MF 50V ELECTRO	
C650	EETB1HM-475E	4.7MF 50V ELECTRO	
C651	EETB1HM-475E	4.7MF 50V ELECTRO	
C652	EETB1HM-475E	4.7MF 50V ELECTRO	
C653	EETB1HM-474E	0.47MF 50V ELECTRO	
C654	EETB1HM-474E	0.47MF 50V ELECTRO	
C655	QFVB1HJ-224N	0.22MF 50V T.FILM	
C656	QFVB1HJ-224N	0.22MF 50V T.FILM	
C657	QFVB1HJ-124N	0.12MF 50V T.FILM	
C658	QFVB1HJ-124N	0.12MF 50V T.FILM	
C659	QFVB1HJ-224N	0.22MF 50V T.FILM	

Δ : SAFETY PARTS

Capacitors

ITEM	PART NUMBER	DESCRIPTION	AREA
C660	QFVB1HJ-224N	0.22MF 50V T.FILM	
C661	QFVB1HJ-473N	0.047MF 50V T.FILM	
C662	QFVB1HJ-473N	0.047MF 50V T.FILM	
C663	QFVB1HJ-104N	0.1MF 50V T.FILM	
C664	QFVB1HJ-104N	0.1MF 50V T.FILM	
C665	QFVB1HJ-183N	0.018MF 50V T.FILM	
C666	QFVB1HJ-183N	0.018MF 50V T.FILM	
C667	QFVB1HJ-393N	0.039MF 50V T.FILM	
C668	QFVB1HJ-393N	0.039MF 50V T.FILM	
C669	QFN81HJ-682	6800PF 50V MYLAR	
C670	QFN81HJ-682	6800PF 50V MYLAR	
C671	QFVB1HJ-153N	0.015MF 50V T.FILM	
C672	QFVB1HJ-153N	0.015MF 50V T.FILM	
C673	QFN81HJ-272	2700PF 50V MYLAR	
C674	QFN81HJ-272	2700PF 50V MYLAR	
C675	QFN81HJ-562	5600PF 50V MYLAR	
C676	QFN81HJ-562	5600PF 50V MYLAR	
C677	QFN81HJ-122	1200PF 50V MYLAR	
C678	QFN81HJ-122	1200PF 50V MYLAR	
C679	QFN81HJ-222	2200PF 50V MYLAR	
C680	QFN81HJ-222	2200PF 50V MYLAR	
C681	QCS21HJ-471	470PF 50V CERAMIC	
C682	QCS21HJ-471	470PF 50V CERAMIC	
C908	QERS0JM-107	100MF 6.3V ELECTRO	
C911	QCBB1HK-101	100PF 50V CERAMIC	
C912	QCHB1EZ-223	0.022MF 25V CERAMIC	
C913	QCHB1EZ-223	0.022MF 25V CERAMIC	
C914	QCBB1HK-101	100PF 50V CERAMIC	
C915	QERS0JM-107	100MF 6.3V ELECTRO	
C916	QCBB1HK-101	100PF 50V CERAMIC	

Δ : SAFETY PARTS

Resistors

ITEM	PART NUMBER	DESCRIPTION	AREA
R161	QRD167J-513	51K 1/6W CARBON	
R162	QRD167J-513	51K 1/6W CARBON	
R163	QRD167J-513	51K 1/6W CARBON	
R164	QRD167J-513	51K 1/6W CARBON	
R165	QRD167J-513	51K 1/6W CARBON	
R166	QRD167J-513	51K 1/6W CARBON	
R167	QRD167J-513	51K 1/6W CARBON	
R168	QRD167J-513	51K 1/6W CARBON	
R169	QRD167J-513	51K 1/6W CARBON	
R170	QRD167J-513	51K 1/6W CARBON	
R171	QRD167J-104	100K 1/6W CARBON	
R172	QRD167J-104	100K 1/6W CARBON	
R173	QRD167J-104	100K 1/6W CARBON	
R174	QRD167J-104	100K 1/6W CARBON	
R175	QRD167J-104	100K 1/6W CARBON	
R176	QRD167J-104	100K 1/6W CARBON	
R177	QRD167J-153	15K 1/6W CARBON	
R178	QRD167J-153	15K 1/6W CARBON	
R179	QRD167J-153	15K 1/6W CARBON	
R180	QRD167J-153	15K 1/6W CARBON	
R181	QRD167J-474	470K 1/6W CARBON	
R182	QRD167J-474	470K 1/6W CARBON	
R183	QRD167J-474	470K 1/6W CARBON	
R184	QRD167J-474	470K 1/6W CARBON	
R185	QRZ0077-101	100 1/4W FUSIBLE	
R186	QRZ0077-101	100 1/4W FUSIBLE	
R187	QRD167J-470	47 1/6W CARBON	
R188	QRD167J-470	47 1/6W CARBON	
R300	QRD167J-221	220 1/6W CARBON	
R301	QRD167J-102	1K 1/6W CARBON	
R302	QRD167J-102	1K 1/6W CARBON	
R303	QRD167J-101	100 1/6W CARBON	
R304	QRD167J-101	100 1/6W CARBON	
R305	QRD167J-103	10K 1/6W CARBON	
R306	QRD167J-103	10K 1/6W CARBON	
R307	QRD167J-100	10 1/6W CARBON	
R308	QRD167J-100	10 1/6W CARBON	
R309	QRD167J-680	68 1/6W CARBON	
R310	QRD167J-680	68 1/6W CARBON	
R311	QRD167J-473	47K 1/6W CARBON	
R312	QRD167J-473	47K 1/6W CARBON	
R313	QRD167J-472	4.7K 1/6W CARBON	
R314	QRD167J-472	4.7K 1/6W CARBON	
R315	QRD167J-472	4.7K 1/6W CARBON	
R316	QRD167J-472	4.7K 1/6W CARBON	
R317	QRD167J-472	4.7K 1/6W CARBON	
R318	QRD167J-472	4.7K 1/6W CARBON	
R319	QRD167J-331	330 1/6W CARBON	
R320	QRD167J-331	330 1/6W CARBON	
R321	QRD14CJ-391S	390 1/4W UNF. CARBON	
R322	QRD14CJ-391S	390 1/4W UNF. CARBON	
R323	QRD167J-103	10K 1/6W CARBON	
R324	QRD167J-103	10K 1/6W CARBON	
R325	QRD167J-180	18 1/6W CARBON	
R326	QRD167J-180	18 1/6W CARBON	
R327	QRD167J-221	220 1/6W CARBON	
R328	QRD167J-221	220 1/6W CARBON	
R329	QRD167J-153	15K 1/6W CARBON	
R330	QRD167J-153	15K 1/6W CARBON	
R331	QRV144F-1913A	191K 1/4W M.FILM	

Δ : SAFETY PARTS

Resistors

ITEM	PART NUMBER	DESCRIPTION	AREA
R332	QRV144F-1913A	191K 1/4W M.FILM	
R333	QRD167J-752	7.5K 1/6W CARBON	
R334	QRD167J-752	7.5K 1/6W CARBON	
R335	QRD167J-331	330 1/6W CARBON	
R336	QRD167J-331	330 1/6W CARBON	
R337	QRD167J-471	470 1/6W CARBON	
R338	QRD167J-471	470 1/6W CARBON	
R339	QRD167J-331	330 1/6W CARBON	
R340	QRD167J-331	330 1/6W CARBON	
R341	QRD167J-104	100K 1/6W CARBON	
R342	QRD167J-104	100K 1/6W CARBON	
R343	QRD167J-222	2.2K 1/6W CARBON	
R344	QRD167J-222	2.2K 1/6W CARBON	
R347	QRD167J-331	330 1/6W CARBON	
R348	QRD167J-331	330 1/6W CARBON	
R349	QRD167J-125	1.2M 1/6W CARBON	
R350	QRD167J-125	1.2M 1/6W CARBON	
R351	QRD167J-125	1.2M 1/6W CARBON	
R352	QRD167J-125	1.2M 1/6W CARBON	
R353	QRD167J-331	330 1/6W CARBON	
R354	QRD167J-331	330 1/6W CARBON	
R367	QRD167J-274	270K 1/6W CARBON	
R368	QRD167J-102	1K 1/6W CARBON	
R369	QRD167J-104	100K 1/6W CARBON	
R370	QRD167J-224	220K 1/6W CARBON	
R371	QRD167J-474	470K 1/6W CARBON	
R372	QRD167J-474	470K 1/6W CARBON	
R373	QRD167J-474	470K 1/6W CARBON	
R374	QRD167J-474	470K 1/6W CARBON	
R375	QRD167J-474	470K 1/6W CARBON	
R376	QRD167J-474	470K 1/6W CARBON	
R377	QRD167J-105	1M 1/6W CARBON	
R378	QRD167J-105	1M 1/6W CARBON	
R379	QRD167J-474	470K 1/6W CARBON	
R380	QRD167J-474	470K 1/6W CARBON	
R381	QRD167J-331	330 1/6W CARBON	
R382	QRD167J-331	330 1/6W CARBON	
R383	QRD167J-105	1M 1/6W CARBON	
R384	QRD167J-105	1M 1/6W CARBON	
R385	QRD167J-474	470K 1/6W CARBON	
R386	QRD167J-474	470K 1/6W CARBON	
R387	QRD167J-331	330 1/6W CARBON	
R388	QRD167J-331	330 1/6W CARBON	
R389	QRZ0077-101	100 1/4W FUSIBLE	
R390	QRZ0077-101	100 1/4W FUSIBLE	
R399	QRD167J-102	1K 1/6W CARBON	
R401	QRD14CJ-391S	390 1/4W UNF. CARBON	
R402	QRD14CJ-391S	390 1/4W UNF. CARBON	
R406	QRD167J-122	1.2K 1/6W CARBON	
R407	QRD167J-223	22K 1/6W CARBON	
R408	QRD167J-333	33K 1/6W CARBON	
R409	QRD167J-122	1.2K 1/6W CARBON	
R411	QRD167J-474	470K 1/6W CARBON	
R412	QRD167J-474	470K 1/6W CARBON	
R413	QRD167J-104	100K 1/6W CARBON	
R414	QRD167J-104	100K 1/6W CARBON	
R415	QRD167J-103	10K 1/6W CARBON	
R416	QRD167J-103	10K 1/6W CARBON	
R417	QRD167J-133	13K 1/6W CARBON	
R418	QRD167J-133	13K 1/6W CARBON	
R419	QRZ0077-101	100 1/4W FUSIBLE	
R420	QRZ0077-101	100 1/4W FUSIBLE	
R429	QRD167J-121	120 1/6W CARBON	
R430	QRD167J-121	120 1/6W CARBON	
R431	QRD167J-103	10K 1/6W CARBON	
R432	QRD167J-103	10K 1/6W CARBON	
R433	QRD167J-224	220K 1/6W CARBON	
R434	QRD167J-224	220K 1/6W CARBON	
R435	QRD167J-103	10K 1/6W CARBON	
R436	QRD167J-103	10K 1/6W CARBON	
R437	QRD167J-113	11K 1/6W CARBON	
R438	QRD167J-113	11K 1/6W CARBON	
R439	QRD167J-101	100 1/6W CARBON	
R440	QRD167J-101	100 1/6W CARBON	
R451	QRD167J-471	470 1/6W CARBON	
R452	QRD167J-471	470 1/6W CARBON	
R453	QRD167J-473	47K 1/6W CARBON	
R454	QRD167J-473	47K 1/6W CARBON	
R455	ERD003J-512	5.1K R.NETWORK	
R456	ERD003J-512	5.1K R.NETWORK	
R457	QRD167J-183	18K 1/6W CARBON	
R458	QRD167J-183	18K 1/6W CARBON	
R459	QRD167J-104	100K 1/6W CARBON	
R460	QRD167J-104	100K 1/6W CARBON	
R461	QRD167J-222	2.2K 1/6W CARBON	
R462	QRD167J-105	1M 1/6W CARBON	
R463	QRD167J-104	100K 1/6W CARBON	
R464	QRD167J-471	470 1/6W CARBON	
R465	QRD167J-105	1M 1/6W CARBON	
R471	QRD167J-474	470K 1/6W CARBON	
R472	QRD167J-474	470K 1/6W CARBON	
R473	QRD167J-474	470K 1/6W CARBON	
R474	QRD167J-474	470K 1/6W CARBON	
R475	QRD167J-561	560 1/6W CARBON	
R476	QRD167J-561	560 1/6W CARBON	
R641	QRD167J-103	10K 1/6W CARBON	

⚠ SAFETY PARTS

Resistors

ITEM	PART NUMBER	DESCRIPTION	AREA
R642	QRD167J-103	10K 1/6W CARBON	
R645	QRD125J-391	390 1/2W UNF. CARBON	
R646	QRD125J-391	390 1/2W UNF. CARBON	
R647	QRD167J-272	2.7K 1/6W CARBON	
R917	QRD167J-104	100K 1/6W CARBON	
R931	QRD167J-331	330 1/6W CARBON	
R932	QRD167J-331	330 1/6W CARBON	
R933	QRD167J-331	330 1/6W CARBON	
R934	QRD167J-472	4.7K 1/6W CARBON	
R935	QRD167J-223	22K 1/6W CARBON	
R936	QRD167J-103	10K 1/6W CARBON	
R937	QRD167J-331	330 1/6W CARBON	
R939	QRD167J-103	10K 1/6W CARBON	
R941	QRD167J-331	330 1/6W CARBON	
R942	QRD167J-561	560 1/6W CARBON	
R943	QRD167J-561	560 1/6W CARBON	
R945	QRD167J-331	330 1/6W CARBON	
R946	QRD167J-561	560 1/6W CARBON	
R949	QRD167J-103	10K 1/6W CARBON	
R951	QRD167J-151	150 1/6W CARBON	
R952	QRD167J-331	330 1/6W CARBON	
R953	QRD167J-331	330 1/6W CARBON	
R954	QRD167J-561	560 1/6W CARBON	
RA641	QRB095J-474	470K 1/8W R.NETWORK	
RA642	QRB095J-474	470K 1/8W R.NETWORK	
RA901	QRB045J-473	47K 1/8W R.NETWORK	

⚠ SAFETY PARTS

Others

ITEM	PART NUMBER	DESCRIPTION	AREA
J301	EMW10117-002	PRINTED BOARD	
J302	EMN00YP-253A	2P PIN JACK(PHONO)	
J303	EMN00TP-604A	6P PIN JACK(CD, TUNER, AUX)	
J303	EMN00TP-409A	4P PIN JACK(TAPE 1 REC/PLAY)	
J304	EMN00TP-409A	4P PIN JACK(TAPE 2 REC/PLAY)	
J305	QMS3501-020	MINI JACK(COMPU LINK)	
L301	EQL4004-330	INDUCTOR	
L302	EQL4004-330	INDUCTOR	
L303	EQL4004-330	INDUCTOR	
L304	EQL4004-330	INDUCTOR	
P306	EMV5109-003A	PLUG ASSY(3PIN)	
P401	EMV5109-009A	PLUG ASSY(9PIN)	
P403	EMV5109-009A	PLUG ASSY(9PIN)	
P415	EMV5109-003A	PLUG ASSY(3PIN)	
P911	EMV7120-012	CONNECTOR(12PIN)	
S903	ESPO001-018	TACT SWITCH(LOUDNESS)	
S904	ESPO001-018	TACT SWITCH(MC)	
S905	ESPO001-018	TACT SWITCH(SEA SOURCE)	
S906	ESPO001-018	TACT SWITCH(TAPE 1 SEA)	
S907	ESPO001-018	TACT SWITCH(TAPE 2 SEA)	
S909	ESPO001-018	TACT SWITCH(DIRECT)	
S910	ESPO001-018	TACT SWITCH(MAN./PRG.)	
S911	ESPO001-018	TACT SWITCH(SPI/SEA)	
S912	ESPO001-018	TACT SWITCH(PRESET)	
S913	ESPO001-018	TACT SWITCH(MEMORY)	
S914	ESPO001-018	TACT SWITCH(F LOW)	
S915	ESPO001-018	TACT SWITCH(SEA -)	
S916	ESPO001-018	TACT SWITCH(SEA +)	
S917	ESPO001-018	TACT SWITCH(F HIGH)	
S918	ESPO001-018	TACT SWITCH(MM)	
S920	ESPO001-018	TACT SWITCH(FLAT)	
S921	ESPO001-018	TACT SWITCH(REVERSE)	
BC306	EWS293-0108	SOCKET WIRE (COMPLINK PCB)	
BC902	EWS266-A908	SOCKET WIRE(6PIN)	
BC903	EWS26A-A908	SOCKET WIRE(10PIN)	
BC904	EWS267-A908	SOCKET WIRE(7PIN)	
BC905	EWS26C-A908	SOCKET WIRE(12PIN)	
BC907	EWS26A-A939	SOCKET WIRE(11PIN)	
EP301	E70225-001	EARTH PLATE	
FL901	ELU0001-121	FL TUBE	
FW405	EWR33B-13LST	FLAT WIRE(3PIN)	
JT908	EMV7122-103	CONNECTOR(3PIN)	
JT909	EMV7122-103	CONNECTOR(3PIN)	
RY401	ESK5D24-220A	RELAY(SOURCE DIRECT)	

⚠ SAFETY PARTS

■ ENB-131 □ System Control , Selector , M.Volume & Power Supply PC Board Ass'y

Note : ENB-131 □ varies according to the areas employed. See note (1) when placing an order.

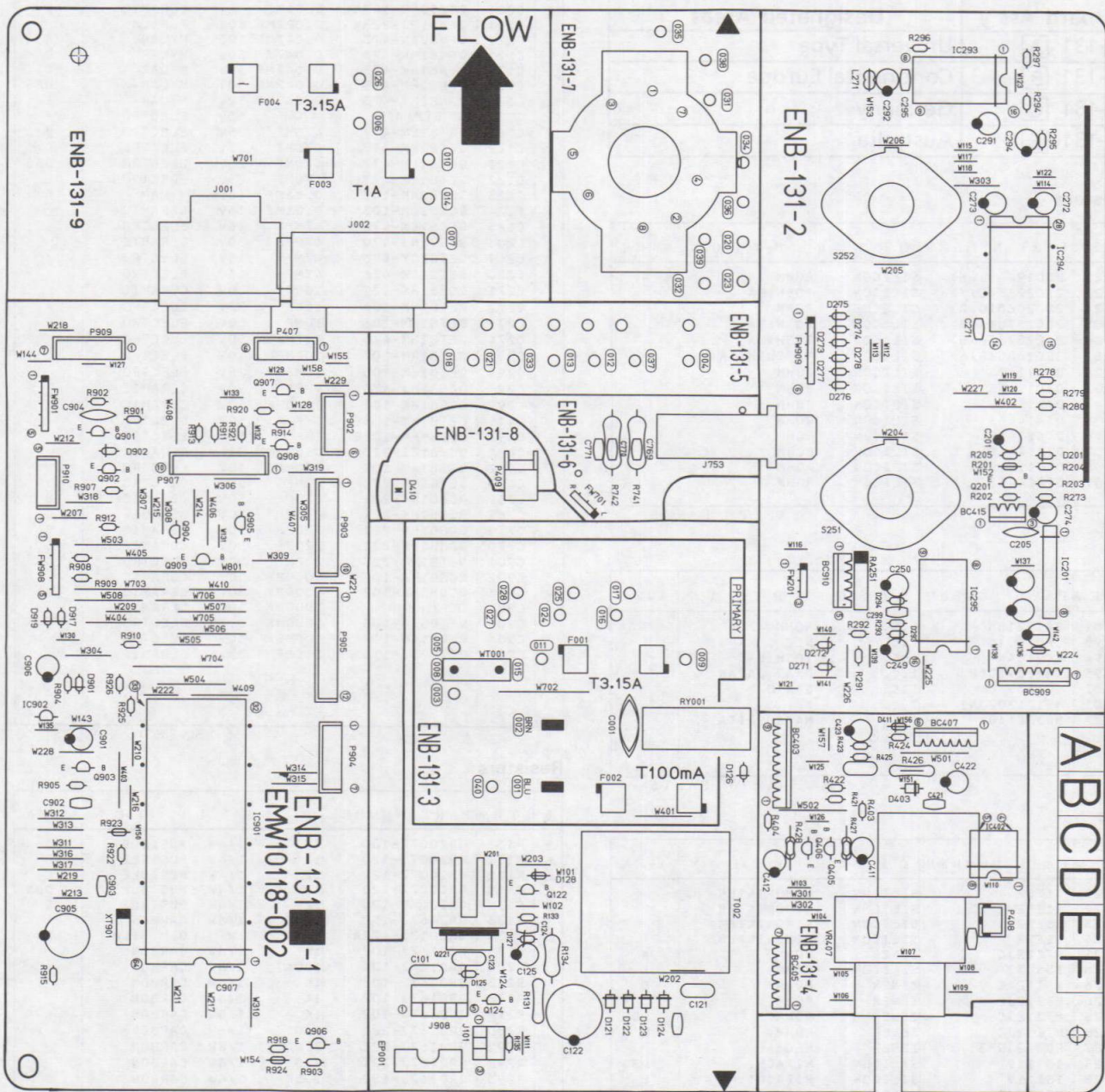

Note (1)

■ AX-R741TN

PC Board Ass'y	Designated Areas
ENB-131 A	Universal Type
ENB-131 B	Continental Europe
ENB-131 C	Germany
ENB-131 D BS	the U.K.
ENB-131 E	Australia

■ AX-R742BK

PC Board Ass'y	Designated Areas
ENB-131 A	Universal Type
ENB-131 B	Continental Europe
ENB-131 C	Germany
ENB-131 E	Australia

Transistors

Δ	ITEM	PART NUMBER	DESCRIPTION	AREA
	Q121	2SD1944(J,K)	SILICON ROHM	A
	Q122	2SC2235(O,Y)	SILICON TOSHIBA	
	Q124	2SC2060(Q,R)	SILICON ROHM	
	Q405	2SC2878(A,B)	SILICON TOSHIBA	
	Q406	2SC2878(A,B)	SILICON TOSHIBA	
	Q901	2SC1685(R,S)	SILICON MATSUSHITA	
	Q902	DTA114YS	SILICON ROHM	
	Q903	DTC114YS	SILICON ROHM	
	Q904	DTA144ES	SILICON ROHM	
	Q905	DTA144ES	SILICON ROHM	
	Q906	DTC114YS	SILICON ROHM	
	Q907	DTA144ES	SILICON ROHM	
	Q908	DTC114YS	SILICON ROHM	
	Q909	DTA144ES	SILICON ROHM	

Δ : SAFETY PARTS

I.C.s

Δ	ITEM	PART NUMBER	DESCRIPTION	AREA
	IC201	BA15218N	I.C. ROHM	
	IC293	UPD7001C	I.C. NEC	
	IC294	TC9164N	I.C. TOSHIBA	
	IC295	XR-1091DCP	I.C. EXAR JAPAN	
	IC402	LB1639-CV	I.C. SANYO	
	IC901	MN171202JNZ	I.C.	
	IC902	MN1281(Q)	I.C. MATSUSHITA	

Δ : SAFETY PARTS

Diodes

Δ	ITEM	PART NUMBER	DESCRIPTION	AREA
	D121	11ES2	SILICON NIHONINTER	
	D122	11ES2	SILICON NIHONINTER	
	D123	11ES2	SILICON NIHONINTER	
	D124	11ES2	SILICON NIHONINTER	
	D125	MTZ12JC	ZENER ROHM	A
	D126	1SS133	SILICON ROHM	A
	D126	MTZ12JC	ZENER ROHM	B
	D126	MTZ12JC	ZENER ROHM	C
	D126	MTZ12JC	ZENER ROHM	DBS
	D126	MTZ12JC	ZENER ROHM	E
	D127	RD6.2JSB3	ZENER NEC	
	D128	1SS119	SILICON HITACHI	DBS
	D128	1SS119	SILICON HITACHI	E
	D271	MTZ15JC	ZENER ROHM	
	D272	MTZ15JC	ZENER ROHM	
	D273	1SS133	SILICON ROHM	
	D274	1SS133	SILICON ROHM	
	D275	1SS133	SILICON ROHM	
	D276	1SS133	SILICON ROHM	
	D277	1SS133	SILICON ROHM	
	D278	1SS133	SILICON ROHM	
	D293	MTZ5.1JC	ZENER ROHM	
	D294	MTZ5.1JC	ZENER ROHM	
	D403	11ES2	SILICON NIHONINTER	
	D410	SLB-74VR3HLF	L.E.D. ROHM	

Δ : SAFETY PARTS

Diodes

Δ	ITEM	PART NUMBER	DESCRIPTION	AREA
	D901	1SS133	SILICON ROHM	
	D902	1SS133	SILICON ROHM	
	D917	1SS133	SILICON ROHM	
	D919	1SS133	SILICON ROHM	

Δ : SAFETY PARTS

Capacitors

Δ	ITEM	PART NUMBER	DESCRIPTION	AREA
	C001	QCZ9050-103A	0.01MF CERAMIC	A
	C001	QCZ9050-103A	0.01MF CERAMIC	B
	C001	QCZ9050-103A	0.01MF CERAMIC	C
	C001	QCZ9050-103ABS	0.01MF CERAMIC	DBS
	C001	QCZ9050-103A	0.01MF CERAMIC	E
	C101	QFVB1HJ-223N	0.022MF 50V T.FILM	
	C121	QFN82AK-473	0.047MF 100V MYLAR	A
	C121	QFN81HK-473	0.047MF 50V MYLAR	B
	C121	QFN81HK-473	0.047MF 50V MYLAR	C
	C121	QFN81HK-473	0.047MF 50V MYLAR	DBS
	C121	QFN81HK-473	0.047MF 50V MYLAR	E
	C122	QETB1JM-477	470MF 63V ELECTRO	A
	C122	QETB1EM-477	470MF 25V ELECTRO	B
	C122	QETB1EM-477	470MF 25V ELECTRO	C
	C122	QETB1EM-477	470MF 25V ELECTRO	DBS
	C122	QETB1EM-477	470MF 25V ELECTRO	E
	C123	QFN82AK-103	0.01MF 100V MYLAR	A
	C124	QCVB1CM-103	0.01MF 16V CERAMIC	
	C125	QETB1CM-476	47MF 16V ELECTRO	
	C205	QCS21HJ-470	47PF 50V CERAMIC	
	C249	QETB1CM-476	47MF 16V ELECTRO	
	C250	QETB1CM-476	47MF 16V ELECTRO	
	C271	QCB1HK-101	100PF 50V CERAMIC	
	C272	QETB1HM-106	10MF 50V ELECTRO	
	C273	QETB1HM-106	10MF 50V ELECTRO	
	C274	QETB1HM-475	4.7MF 50V ELECTRO	
	C291	QETB1AM-107	100MF 10V ELECTRO	
	C294	QETB1EM-106	10MF 25V ELECTRO	
	C295	QCSB1HJ-470	47PF 50V CERAMIC	
	C299	QCGB1HK-102	1000PF 50V CERAMIC	
	C411	EETB1HM-105E	1MF 50V ELECTRO	
	C412	EETB1HM-105E	1MF 50V ELECTRO	
	C421	QCHB1E2-223	0.022MF 25V CERAMIC	
	C422	QETB1AM-107	100MF 10V ELECTRO	
	C423	QETB1HM-226	22MF 50V ELECTRO	
	C769	QCB1HK-221	220PF 50V CERAMIC	B
	C769	QCB1HK-221	220PF 50V CERAMIC	C
	C770	QCB1HK-221	220PF 50V CERAMIC	B
	C770	QCB1HK-221	220PF 50V CERAMIC	C
	C901	QETB1HM-225	2.2MF 50V ELECTRO	
	C902	QCGB1HK-102	1000PF 50V CERAMIC	
	C903	QCGB1HK-102	1000PF 50V CERAMIC	
	C904	QCF21HP-102	1000PF 50V CERAMIC	
	C905	QETBOJM-108	1000MF 6.3V ELECTRO	
	C906	QETB1AM-107	100MF 10V ELECTRO	
	C907	QCZ0205-155	1.5MF 25V CERAMIC	

Δ : SAFETY PARTS

Resistors

Δ	ITEM	PART NUMBER	DESCRIPTION	AREA
	R131	QRZ0077-100	10 1/4W FUSIBLE	A
	R131	QRZ0077-120	12 1/4W FUSIBLE	B
	R131	QRZ0077-120	12 1/4W FUSIBLE	C
	R131	QRZ0077-120	12 1/4W FUSIBLE	DBS
	R131	QRZ0077-120	12 1/4W FUSIBLE	E
	R133	QRD167J-152	1.5K 1/6W CARBON	
	R134	QRG012J-472A	4.7K 1W O.M.FILM	A
	R135	QRD167J-102	1K 1/6W CARBON	
	R202	QRD167J-104	100K 1/6W CARBON	
	R273	QRD167J-102	1K 1/6W CARBON	
	R278	QRD167J-102	1K 1/6W CARBON	
	R279	QRD167J-102	1K 1/6W CARBON	
	R280	QRD167J-221	220 1/6W CARBON	
	R291	QRD167J-221	220 1/6W CARBON	
	R292	QRD167J-221	220 1/6W CARBON	
	R293	QRD167J-152	1.5K 1/6W CARBON	
	R294	QRD167J-223	22K 1/6W CARBON	
	R295	QRD167J-223	22K 1/6W CARBON	
	R296	QRD167J-273	27K 1/6W CARBON	
	R297	QRD167J-223	22K 1/6W CARBON	
	R403	QRD167J-104	100K 1/6W CARBON	
	R404	QRD167J-104	100K 1/6W CARBON	
	R421	QRD167J-471	470 1/6W CARBON	
	R422	QRD167J-471	470 1/6W CARBON	
	R423	QRD167J-104	100K 1/6W CARBON	

Δ : SAFETY PARTS

Resistors

Δ	ITEM	PART NUMBER	DESCRIPTION	AREA
	R424	QRD167J-471	470 1/6W CARBON	
	R425	QRD167J-105	1M 1/6W CARBON	
	R427	QRD167J-471	470 1/6W CARBON	
	R428	QRD167J-471	470 1/6W CARBON	
Δ	R741	QRG022J-331A	330 2W O.M.FILM	
Δ	R742	QRG022J-331A	330 2W O.M.FILM	
	R901	QRD167J-473	47K 1/6W CARBON	
	R902	QRD167J-223	22K 1/6W CARBON	
	R903	QRD167J-151	150 1/6W CARBON	A
	R903	QRD167J-151	150 1/6W CARBON	B
	R903	QRD167J-151	150 1/6W CARBON	C
	R903	QRD167J-301	300 1/6W CARBON	DBS
	R903	QRD167J-301	300 1/6W CARBON	E
	R904	QRD167J-104	100K 1/6W CARBON	
	R905	QRD167J-103	10K 1/6W CARBON	
	R907	QRD167J-473	47K 1/6W CARBON	
	R908	QRD167J-103	10K 1/6W CARBON	
	R909	QRD167J-103	10K 1/6W CARBON	
	R910	QRD167J-103	10K 1/6W CARBON	
	R911	QRD167J-332	3.3K 1/6W CARBON	
	R912	QRD167J-332	3.3K 1/6W CARBON	
	R913	QRD167J-103	10K 1/6W CARBON	
	R914	QRD167J-181	180 1/6W CARBON	
	R915	QRD167J-330	33 1/6W CARBON	
	R920	QRD167J-103	10K 1/6W CARBON	
	R921	QRD167J-103	10K 1/6W CARBON	
	R922	QRD167J-102	1K 1/6W CARBON	
	R925	QRD167J-332	3.3K 1/6W CARBON	
	R926	QRD167J-332	3.3K 1/6W CARBON	
	RA251	QRB045J-473	47K 1/6W R.NETWORK	
	VR407	QVDB94B-E54B	50K VARIABLE	

Δ : SAFETY PARTS

Others

Δ	ITEM	PART NUMBER	DESCRIPTION	AREA
Δ	T002	ETP1000-41EA	POWER TRANSFORMER	C
Δ	T002	ETP1000-41EABS	POWER TRANSFORMER	DBS
Δ	T002	ETP1000-41EA	POWER TRANSFORMER	E
	BC403	EWS299-1525	SOCKET WIRE(9PIN)	
	BC405	EWS297-1120	SOCKET WIRE(7PIN)	
	BC407	EWS266-A208	SOCKET WIRE(6PIN)	
	BC415	EWS293-0130	SOCKET WIRE	
	BC909	EWS267-A423	SOCKET WIRE(6PIN)	
	BC910	EWS265-A925	SOCKET WIRE(5PIN)	
	EP001	E70859-001	EARTH PLATE	
	FW201	EWR33B-13LST	FLAT WIRE(3PIN)	
	FW701	EWR33B-16LST	FLAT WIRE(3PIN)	
	FW901	EWR35B-10LST	FLAT WIRE(5PIN)	
	FW908	EWR35B-25LST	FLAT WIRE(5PIN)	
	FW909	EWR36B-10LST	FLAT WIRE(6PIN)	
	RY001	ESK1D12-118J1	RELAY	A
	RY001	ESK1D12-118J1	RELAY	B
	RY001	ESK1D12-118J1	RELAY	C
	RY001	ESK1D12-118J1BS	RELAY	DBS
	RY001	ESK1D12-118J1	RELAY	E
	WT001	E67764-202	WRAPPING TERMINAL	E
	XT901	ECX0060-000EM	RESONATOR	

Δ : SAFETY PARTS

Others

Δ	ITEM	PART NUMBER	DESCRIPTION	AREA
		EMW10118-002	PRINTED BOARD	A
		E67132-T6R3	FUSE LABEL	A
		E70945-H40B	HEAT SINK	A
		SBSG3008CC	SCREW	A
		EMW10118-002	PRINTED BOARD	B
		EWT011-124	TERMINAL WIRE	B
		EMW10118-002	PRINTED BOARD	C
		EWT011-124	TERMINAL WIRE	C
		EMW10118-002BS	PRINTED BOARD	DBS
		EMW10118-002	PRINTED BOARD	E
	001	E65508-002	TAB	
	F001	EMG7331-002	FUSE CLIP	B
	F001	EMG7331-002U	FUSE CLIP	B
	F001	EMG7331-002	FUSE CLIP	C
	F001	EMG7331-002U	FUSE CLIP	C
	F001	EMG7331-002	FUSE CLIP	DBS
	F001	EMG7331-002U	FUSE CLIP	DBS
	F001	EMG7331-002	FUSE CLIP	E
	F001	EMG7331-002U	FUSE CLIP	E
	F002	EMG7331-002	FUSE CLIP	B
	F002	EMG7331-002U	FUSE CLIP	B
	F002	EMG7331-002	FUSE CLIP	C
	F002	EMG7331-002U	FUSE CLIP	C
	F002	EMG7331-002	FUSE CLIP	DBS
	F002	EMG7331-002U	FUSE CLIP	DBS
	F002	EMG7331-002	FUSE CLIP	E
	F002	EMG7331-002U	FUSE CLIP	E
	F003	EMG7331-002	FUSE CLIP	A
	F003	EMG7331-002U	FUSE CLIP	A
	F003	EMG7331-002	FUSE CLIP	B
	F003	EMG7331-002U	FUSE CLIP	B
	F004	EMG7331-002	FUSE CLIP	A
	F004	EMG7331-002U	FUSE CLIP	A
	J001	QACA004-E01G	AC OUTLET	B
	J001	QACA004-E01G	AC OUTLET	C
	J001	QACA004-E02GBS	AC OUTLET	DBS
	J002	QACA002-E01S	AC OUTLET	A
	J101	EMV7122-103	CONNECTOR(3PIN)	
	J753	QMS6A40-021	HEADPHONE JACK	
	J908	EMV7122-005	CONNECTOR(5PIN)	
	P407	EMV5109-006A	PLUG ASSY(6PIN)	
	P408	EMV5103-002A	PLUG ASSY(2PIN)	
	P409	EMV5103-002B	PLUG ASSY(2PIN)	
	P902	EMV5109-006A	PLUG ASSY(6PIN)	
	P903	EMV5109-010A	PLUG ASSY(10PIN)	
	P904	EMV5109-007A	PLUG ASSY(7PIN)	
	P905	EMV5109-012A	PLUG ASSY(12PIN)	
	P907	EMV5109-010A	PLUG ASSY(12PIN)	
	P909	EMV5109-007A	PLUG ASSY(7PIN)	
	P910	EMV5109-005A	PLUG ASSY(5PIN)	
Δ	S001	QSR0085-018	VOLTAGE SELECTOR	A
	S251	QSR211C-E01	ROTARY SWITCH(REC SELECTOR)	
	S252	QSR211C-E01	ROTARY SWITCH(SOURCE SELECTOR)	
Δ	T002	ETP1000-412B	POWER TRANSFORMER	A
Δ	T002	ETP1000-41EA	POWER TRANSFORMER	B

Δ : SAFETY PARTS

■ ENH-179 □ Power Amplifier & Speaker Terminal PC Board Ass'y

Note : ENH-179 □ varies according to the areas employed. See note (1) when placing an order.

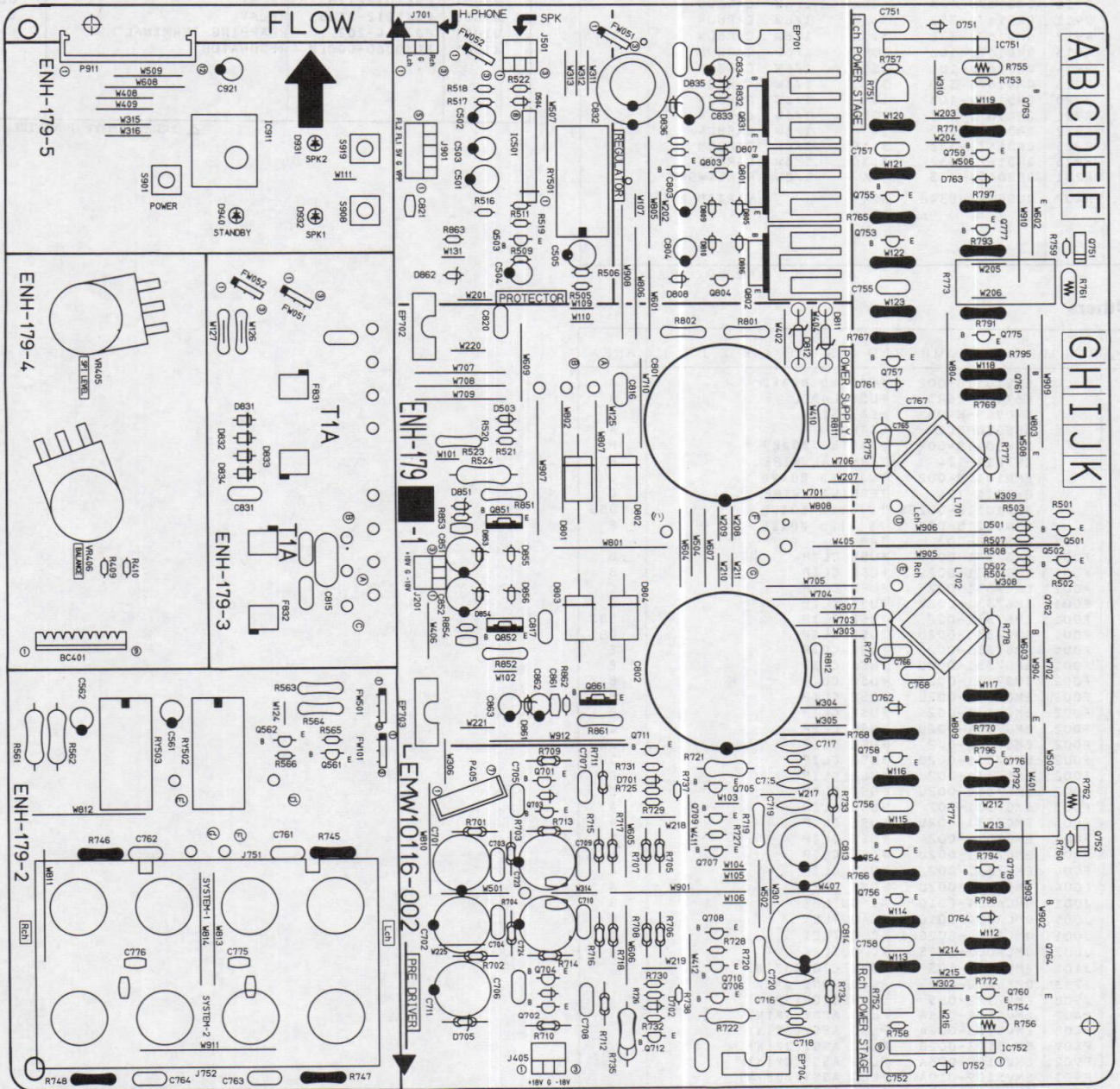

Note (1)

■ AX-R741TN

PC Board Ass'y		Designated Areas
ENH-179	A	Universal Type
ENH-179	B	Australia, the U.K.
ENH-179	C	Continental Europe, Germany

■ AX-R742BK

PC Board Ass'y		Designated Areas
ENH-179	A	Universal Type
ENH-179	B	Australia
ENH-179	C	Continental Europe, Germany

Transistors

ITEM	PART NUMBER	DESCRIPTION	AREA
Q501	2SC2389(S,E)	SILICON ROHM	
Q502	2SC2389(S,E)	SILICON ROHM	
Q503	2SA970(GR,BL)	SILICON TOSHIBA	
Q561	2SC2240(GR,BL)	SILICON TOSHIBA	
Q562	2SC2240(GR,BL)	SILICON TOSHIBA	
Q701	2SC2240(A,B)	SILICON TOSHIBA	
Q702	2SC2240(A,B)	SILICON TOSHIBA	
Q703	2SC2240(A,B)	SILICON TOSHIBA	
Q704	2SC2240(A,B)	SILICON TOSHIBA	
Q705	2SA970(GR,BL)	SILICON TOSHIBA	
Q706	2SA970(GR,BL)	SILICON TOSHIBA	
Q707	2SA970(GR,BL)	SILICON TOSHIBA	
Q708	2SA970(GR,BL)	SILICON TOSHIBA	
Q709	2SA933LN(R,S)	SILICON ROHM	
Q710	2SA933LN(R,S)	SILICON ROHM	
Q711	2SC2240(GR,BL)	SILICON TOSHIBA	
Q712	2SC2240(GR,BL)	SILICON TOSHIBA	
Q751	2SD636(Q,R)	SILICON MATSUSHITA	
Q752	2SD636(Q,R)	SILICON MATSUSHITA	
Q753	2SC2240(GR,BL)	SILICON TOSHIBA	
Q754	2SC2240(GR,BL)	SILICON TOSHIBA	
Q755	2SA970(GR,BL)	SILICON TOSHIBA	
Q756	2SA970(GR,BL)	SILICON TOSHIBA	
Q757	2SC2235(O,Y)	SILICON TOSHIBA	
Q758	2SC2235(O,Y)	SILICON TOSHIBA	
Q759	2SA965(O,Y)	SILICON TOSHIBA	
Q760	2SA965(O,Y)	SILICON TOSHIBA	
Q761	2SD2155LB(R,O)	SILICON TOSHIBA	
Q762	2SD2155LB(R,O)	SILICON TOSHIBA	
Q763	2SB1429LB(R,O)	SILICON TOSHIBA	
Q764	2SB1429LB(R,O)	SILICON TOSHIBA	
Q775	2SC1740S(R,S)	SILICON ROHM	
Q776	2SC1740S(R,S)	SILICON ROHM	
Q777	2SA933S(R,S)	SILICON ROHM	
Q778	2SA933S(R,S)	SILICON ROHM	
Q801	2SD2061(E,F)	SILICON ROHM	
Q802	2SB1187(E,F)	SILICON ROHM	
Q803	2SK246(GR)	F.E.T TOSHIBA	
Q804	2SK246(GR)	F.E.T TOSHIBA	
Q831	2SD1944(J,K)	SILICON ROHM	
Q851	2SD2061(E,F)	SILICON ROHM	
Q852	2SB1187(E,F)	SILICON ROHM	
Q861	2SB1187(E,F)	SILICON ROHM	

△ : SAFETY PARTS

I.C.s

ITEM	PART NUMBER	DESCRIPTION	AREA
IC501	UPC1237HA	I.C. NEC	
IC751	VC5022(X,Y)	I.C. ROHM	
IC752	VC5022(X,Y)	I.C. ROHM	
IC911	GPU501X	I.C. SHARP	

△ : SAFETY PARTS

Diodes

ITEM	PART NUMBER	DESCRIPTION	AREA
D501	1SS133	SILICON ROHM	
D502	1SS133	SILICON ROHM	
D503	1SS133	SILICON ROHM	
D504	1SS147	SILICON ROHM	
D701	1SS133	SILICON ROHM	
D702	1SS133	SILICON ROHM	
D705	HZ12A2-L	ZENER HITACHI	
D751	1SS291	SILICON ROHM	
D752	1SS291	SILICON ROHM	
D761	1SS291	SILICON ROHM	
D762	1SS291	SILICON ROHM	
D763	1SS291	SILICON ROHM	
D764	1SS291	SILICON ROHM	
D801	30DF2SFC	SILICON NIHONINTER	
D802	30DF2SFC	SILICON NIHONINTER	
D803	30DF2SFC	SILICON NIHONINTER	
D804	30DF2SFC	SILICON NIHONINTER	
D805	MTZ18JC	ZENER ROHM	
D806	MTZ18JC	ZENER ROHM	
D808	MTZ9.1JC	ZENER ROHM	
D809	MTZ20JC	ZENER ROHM	
D810	MTZ20JC	ZENER ROHM	
R811	RD5.6FB2	ZENER NEC	
R812	RD5.6FB2	ZENER NEC	
D831	11ES2	SILICON NIHONINTER	
D832	11ES2	SILICON NIHONINTER	
D833	11ES2	SILICON NIHONINTER	
D834	11ES2	SILICON NIHONINTER	
D835	MTZ5.6JC	ZENER ROHM	
D836	MTZ7.5JC	ZENER ROHM	
D851	MTZ10JC	ZENER ROHM	
D853	MTZ15JC	ZENER ROHM	
D854	MTZ15JC	ZENER ROHM	
D855	MTZ10JC	ZENER ROHM	
D856	MTZ10JC	ZENER ROHM	
D861	MTZ33JC	ZENER ROHM	
D862	MTZ7.5JC	ZENER ROHM	
D931	SLR-34DC3F	L.E.D. ROHM	A
D932	SLR-34DC3F	L.E.D. ROHM	B
D940	SLR-34VC3F	L.E.D. ROHM	C
D940	SLA-58OLT3F	L.E.D. ROHM	
D940	SLR-34VC3F	L.E.D. ROHM	

△ : SAFETY PARTS

Capacitors

ITEM	PART NUMBER	DESCRIPTION	AREA
C501	QETB1AM-227	220MF 10V ELECTRO	
C502	QETB1CM-226	22MF 16V ELECTRO	
C503	QETB1HM-475	4.7MF 50V ELECTRO	
C504	QETB1HM-226	22MF 50V ELECTRO	
C505	QETB1HM-105	1MF 50V ELECTRO	
C561	QETB1HM-105	1MF 50V ELECTRO	
C562	QETB1HM-105	1MF 50V ELECTRO	
C701	EETB1HM-226E	22MF 50V ELECTRO	
C702	EETB1HM-226E	22MF 50V ELECTRO	
C703	QFPB1HJ-101	100PF 50V POLY	
C704	QFPB1HJ-101	100PF 50V POLY	
C705	QFPB1HJ-101	100PF 50V POLY	
C706	QFPB1HJ-101	100PF 50V POLY	
C707	QFN81HK-332	3300PF 50V MYLAR	
C708	QFN81HK-332	3300PF 50V MYLAR	
C709	QCS21HJ-220	22PF 50V CERAMIC	
C710	QCS21HJ-220	22PF 50V CERAMIC	
C711	EETB1CM-107E	100MF 16V ELECTRO	
C715	QCS21HJ-330	33PF 50V CERAMIC	
C716	QCS21HJ-330	33PF 50V CERAMIC	
C717	QCS21HJ-330	33PF 50V CERAMIC	
C718	QCS21HJ-330	33PF 50V CERAMIC	
C719	QCS22HJ-220	22PF 500V CERAMIC	
C720	QCS22HJ-220	22PF 500V CERAMIC	
C723	EETB1EM-227E	220MF 25V ELECTRO	
C724	EETB1EM-227E	220MF 25V ELECTRO	
C751	QFVB1HJ-103N	0.01MF 50V T.FILM	C
C752	QFVB1HJ-103N	0.01MF 50V T.FILM	C
C755	QCS22HJ-680A	68PF 500V CERAMIC	
C756	QCS22HJ-680A	68PF 500V CERAMIC	
C757	QCS22HJ-680A	68PF 500V CERAMIC	
C758	QCS22HJ-680A	68PF 500V CERAMIC	
C761	QFVB1HJ-103N	0.01MF 50V T.FILM	C
C762	QFVB1HJ-103N	0.01MF 50V T.FILM	C
C763	QFVB1HJ-103N	0.01MF 50V T.FILM	C
C764	QFVB1HJ-103N	0.01MF 50V T.FILM	C
C765	QFVB1HJ-104N	0.1MF 50V T.FILM	
C766	QFVB1HJ-104N	0.1MF 50V T.FILM	
C767	QFVB1HJ-104N	0.1MF 50V T.FILM	
C768	QFVB1HJ-104N	0.1MF 50V T.FILM	
C775	QCHB1EZ-223	0.022MF 25V CERAMIC	C
C776	QCHB1EZ-223	0.022MF 25V CERAMIC	C
C801	EEW6309-129T	12000MF ELECTRO	
C802	EEW6309-129T	12000MF ELECTRO	
C803	EETB1EM-476E	47MF 25V ELECTRO	

△ : SAFETY PARTS

Capacitors

ITEM	PART NUMBER	DESCRIPTION	AREA
C804	EETB1EM-476E	47MF 25V ELECTRO	
C813	EETB1JM-227E	220MF 63V ELECTRO	
C814	EETB1JM-227E	220MF 63V ELECTRO	
C815	QFH42EK-104	0.1MF 250V M.MYLAR	
C816	QFN32AK-104	0.1MF 100V MYLAR	
C817	QFN32AK-104	0.1MF 100V MYLAR	
C831	QFVB1HJ-104N	0.1MF 50V T.FILM	
C832	QETB1EM-228	2200MF 25V ELECTRO	
C833	QCHB1EZ-223	0.022MF 25V CERAMIC	
C834	QETB1AM-107	100MF 10V ELECTRO	
C851	QETB1CM-476	47MF 16V ELECTRO	
C852	QETB1CM-476	47MF 16V ELECTRO	
C862	QETB1HM-106	10MF 50V ELECTRO	
C863	QETB1HM-226	22MF 50V ELECTRO	
C921	QER50JM-107	100MF 6.3V ELECTRO	

△ : SAFETY PARTS

Resistors

ITEM	PART NUMBER	DESCRIPTION	AREA
R409	QRD167J-103	10K 1/6W CARBON	
R410	QRD167J-103	10K 1/6W CARBON	
R501	QRD167J-272	2.7K 1/6W CARBON	
R502	QRD167J-272	2.7K 1/6W CARBON	
R503	QRD167J-153	15K 1/6W CARBON	
R504	QRD167J-153	15K 1/6W CARBON	
R505	QRD167J-104	100K 1/6W CARBON	
R506	QRD167J-823	82K 1/6W CARBON	
R507	QRD167J-223	22K 1/6W CARBON	
R508	QRD167J-223	22K 1/6W CARBON	
R509	QRD167J-103	10K 1/6W CARBON	
R511	QRD167J-473	47K 1/6W CARBON	
R516	QRD167J-103	10K 1/6W CARBON	
R517	QRD167J-103	10K 1/6W CARBON	
R518	QRD167J-224	220K 1/6W CARBON	
R519	QRD167J-332	3.3K 1/6W CARBON	
R520	QRD167J-273	27K 1/6W CARBON	
R521	QRD167J-103	10K 1/6W CARBON	
R522	QRD167J-224	220K 1/6W CARBON	
R523	QRD14CJ-121S	120 1/4W UNF. CARBON	
R524	QRG022J-122A	1.2K 2W O.M.FILM	
R561	QRG022J-122A	1.2K 2W O.M.FILM	
R562	QRG022J-122A	1.2K 2W O.M.FILM	
R563	QRD14CJ-820S	82 1/4W UNF. CARBON	
R564	QRD14CJ-820S	82 1/4W UNF. CARBON	
R565	QRD167J-222	2.2K 1/6W CARBON	
R566	QRD167J-222	2.2K 1/6W CARBON	
R701	QRD167J-221	220 1/6W CARBON	
R702	QRD167J-221	220 1/6W CARBON	
R703	QRD167J-473	47K 1/6W CARBON	
R704	QRD167J-473	47K 1/6W CARBON	
R705	QRD167J-202	2K 1/6W CARBON	
R706	QRD167J-202	2K 1/6W CARBON	
R707	QRD167J-202	2K 1/6W CARBON	
R708	QRD167J-202	2K 1/6W CARBON	
R709	QRD167J-562	5.6K 1/6W CARBON	
R710	QRD167J-562	5.6K 1/6W CARBON	
R711	QRD167J-101	100 1/6W CARBON	
R712	QRD167J-101	100 1/6W CARBON	
R713	QRD167J-331	330 1/6W CARBON	
R714	QRD167J-331	330 1/6W CARBON	
R715	QRD167J-223	22K 1/6W CARBON	
R716	QRD167J-223	22K 1/6W CARBON	
R717	QRD167J-243	24K 1/6W CARBON	
R718	QRD167J-243	24K 1/6W CARBON	
R719	QRD14CJ-121S	120 1/4W UNF. CARBON	
R720	QRD14CJ-121S	120 1/4W UNF. CARBON	
R721	QRG012J-103AM	10K 1W O.M.FILM	
R722	QRG012J-103AM	10K 1W O.M.FILM	
R725	QRD167J-391	390 1/6W CARBON	
R726	QRD167J-391	390 1/6W CARBON	
R727	QRD167J-152	1.5K 1/6W CARBON	
R728	QRD167J-152	1.5K 1/6W CARBON	
R729	QRD167J-333	33K 1/6W CARBON	
R730	QRD167J-333	33K 1/6W CARBON	
R731	QRD167J-391	390 1/6W CARBON	
R732	QRD167J-391	390 1/6W CARBON	
R733	QRD167J-152	1.5K 1/6W CARBON	
R734	QRD167J-152	1.5K 1/6W CARBON	
R735	QRG012J-392A	3.9K 1W O.M.FILM	
R737	QRD167J-333	33K 1/6W CARBON	
R738	QRD167J-333	33K 1/6W CARBON	
R745	QRZ0077-100	10 1/4W FUSIBLE	C
R746	QRZ0077-100	10 1/4W FUSIBLE	C
R747	QRZ0077-100	10 1/4W FUSIBLE	C
R748	QRZ0077-100	10 1/4W FUSIBLE	C
R751	QVPE601-501	500 0.15W VARIABLE	
R752	QVPE601-501	500 0.15W VARIABLE	
R753	QRD167J-101	100 1/6W CARBON	
R754	QRD167J-101	100 1/6W CARBON	

△ : SAFETY PARTS

Resistors

ITEM	PART NUMBER	DESCRIPTION	AREA
R755	ERT-D2WFL351S	350 1/4W THERMISTOR	
R756	ERT-D2WFL351S	350 1/4W THERMISTOR	
R757	QRD167J-471	470 1/6W CARBON	
R758	QRD167J-471	470 1/6W CARBON	
R759	QRD167J-391	390 1/6W CARBON	
R760	QRD167J-391	390 1/6W CARBON	
R761	ERT-D2WHL202S	2K 1/4W THERMISTOR	
R762	ERT-D2WHL202S	2K 1/4W THERMISTOR	
R765	QRZ0077-122	1.2K 1/4W FUSIBLE	
R766	QRZ0077-122	1.2K 1/4W FUSIBLE	
R767	QRZ0077-151	150 1/4W FUSIBLE	
R768	QRZ0077-151	150 1/4W FUSIBLE	
R769	QRZ0077-100	10 1/4W FUSIBLE	
R770	QRZ0077-100	10 1/4W FUSIBLE	
R771	QRZ0077-100	10 1/4W FUSIBLE	
R772	QRZ0077-100	10 1/4W FUSIBLE	
R773	ERF032K-R22	0.22 3W CEMENT	
R774	ERF032K-R22	0.22 3W CEMENT	
R775	QRG022J-100A	10 2W O.M.FILM	
R776	QRG022J-100A	10 2W O.M.FILM	
R777	QRD125J-100	10 1/2W UNF. CARBON	
R778	QRD125J-100	10 1/2W UNF. CARBON	
R791	QRZ0077-681	680 1/4W FUSIBLE	
R792	QRZ0077-681	680 1/4W FUSIBLE	
R793	QRZ0077-681	680 1/4W FUSIBLE	
R794	QRZ0077-681	680 1/4W FUSIBLE	
R795	QRZ0077-151	150 1/4W FUSIBLE	
R796	QRZ0077-151	150 1/4W FUSIBLE	
R797	QRZ0077-151	150 1/4W FUSIBLE	
R798	QRZ0077-151	150 1/4W FUSIBLE	
R801	QRZ0077-100	10 1/4W FUSIBLE	
R802	QRZ0077-100	10 1/4W FUSIBLE	
R804	QRD167J-477	470K 1/6W CARBON	
R811	QRD14CJ-330S	33 1/4W UNF. CARBON	
R812	QRD14CJ-330S	33 1/4W UNF. CARBON	
R832	QRD167J-122	1.2K 1/6W CARBON	
R851	QRZ0077-100	10 1/4W FUSIBLE	
R852	QRZ0077-100	10 1/4W FUSIBLE	
R853	QRD167J-223	22K 1/6W CARBON	
R854	QRD167J-333	33K 1/6W CARBON	
R861	QRZ0077-100	10 1/4W FUSIBLE	
R862	QRD167J-473	47K 1/6W CARBON	
R863	QRD167J-104	100K 1/6W CARBON	
VR405	QVDA87A-E54B	50K VARIABLE	
VR406	QVDB87M-EF5F	250K VARIABLE	

△ : SAFETY PARTS

Others

ITEM	PART NUMBER	DESCRIPTION	AREA
	EMW10116-002	PRINTED BOARD	
	EW69F-42RR2	WIRE	
	EW69G-42RR2	WIRE	
	EW69H-28RR2	WIRE	
	E300209-043	HEAT SINK	
	E305991-001	HEAT SINK BRACKET	
	E305992-001	HEAT SINK BRACKET	
	E70945-H25B	HEAT SINK	
	E70945-H60B	HEAT SINK	
	E72018-002	WIRE CLAMP	
	E73525-001	SPECIAL SCREW	
	E73525-003	SCREW	
	GBSG3008CC	SCREW	
	WNS3000CC	WASHER	
	E48269-001	SPACER	
F831	EMG7331-002	FUSE CLIP	
F831	EMG7331-002U	FUSE CLIP	
F832	EMG7331-002	FUSE CLIP	
F832	EMG7331-002U	FUSE CLIP	
J201	EMV7122-103	CONNECTOR(3PIN)	
J405	EMV7122-103	CONNECTOR(3PIN)	
J501	EMV7122-103	CONNECTOR(3PIN)	
J701	EMV7122-103	CONNECTOR(3PIN)	
J751	EMBO0TP-801H	SPEAKER TERMINAL	A
J751	EMBO0TP-801G	SPEAKER TERMINAL	B
J751	EMBO0TP-801H	SPEAKER TERMINAL	C
J901	EMV7122-005	CONNECTOR(5PIN)	
L701	EGL0001-1R0	INDUCTOR	
L702	EGL0001-1R0	INDUCTOR	
P405	EMV5109-007A	PLUG ASSY(7PIN)	
P911	EMV5120-012	PLUG ASSY(12PIN)	
S901	ESPO001-018	TACT SWITCH(POWER)	
S908	ESPO001-018	TACT SWITCH(SPK 1)	
S919	ESPO001-018	TACT SWITCH(SPK 2)	
BC401	EWS299-1513	SOCKET WIRE(9PIN)	
EP702	E70859-001	EARTH PLATE	
EP703	E70859-001	EARTH PLATE	
FW051	EWR33B-13SST	FLAT WIRE(3PIN)	
FW052	EWR33B-13SST	FLAT WIRE(3PIN)	
FW101	EWR33B-10LST	FLAT WIRE(3PIN)	
FW501	EWR33B-30LST	FLAT WIRE(3PIN)	
RY501	ESK7D24-2120	RELAY(PROTECTOR)	
RY502	ESK7D24-2120	RELAY(SYSTEM-1)	
RY503	ESK7D24-2120	RELAY(SYSTEM-2)	

△ : SAFETY PARTS

Accessories List

■ AX-R741TN

⚠	Part Number	Part Name	Q'ty	Description	Areas
	E30580-1750A E30580-1750ABS BT-20117 BT20060 BT-20122	Instruction Book Instruction Book Warranty Card Warranty Card Warranty Card	1 1 1 1 1		U, A, G, E, EF BS G BS A
	BT-20122-1 BT20066A QZL1008-001 E43486-340A E43486-371A	Sticker EEC Agency FTZ Information Sheet Safety Sheet Sheet	1 1 1 1 1		A BS G BS BS
⚠ ⚠	EMC0202-001BS E04056 E35497-019 RM-SA741U UR52EC860	AC Plug Siemens Plug Caution Sheet Remote Controller Battery Cover	1 1 1 1 1	220V	BS U U
	UM-4NJ-2PSA E41202-2 E41202-2B	Battery Envelope Envelope	1 1 1		U, A, G, E, EF BS

⚠: Safety Parts

The Marks Designated Areas

A.....Australia

G.....Germany

E, EF.....Continental Europe

BS.....the U.K.

U.....Other Countries

No mark indicates all areas.

■ AX-R742BK

⚠	Part Number	Part Name	Q'ty	Description	Areas
	E30580-1750A BT-20117 BT-20122 BT-20122-1 QZL1008-001	Instruction Book Warranty Card Warranty Card Sticker FTZ Information Sheet	1 1 1 1 1		U, A, G, E, EF G A A G
⚠	E04056 E35497-019 RM-SA741U UR52EC860 UM-4NJ-2PSA	Siemens Plug Caution Sheet Remote Controller Battery Cover Battery	1 1 1 1 1	220V	U U
	E41202-2	Envelope	1		

⚠: Safety Parts

The Marks Designated Areas

A.....Australia

G.....Germany

E, EF.....Continental Europe

U.....Other Countries

No mark indicates all areas.

Packing Materials and Part Numbers

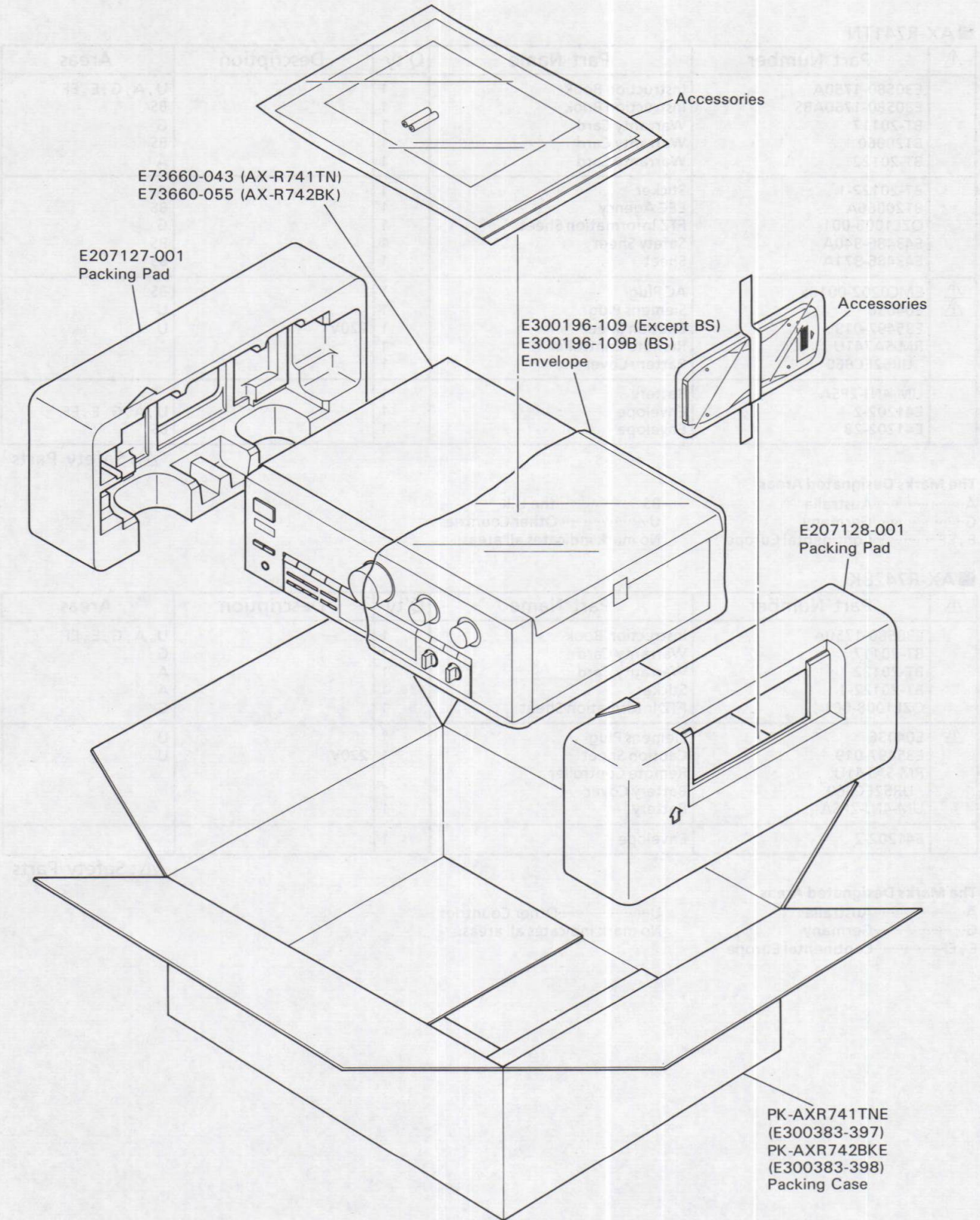

■ AX-R741TN	
The Marks Designated Areas	
A.....Australia	BS.....the U.K.
G.....Germany	U.....Other Countries
E, EF.....Continental Europe	No mark indicates all areas.

■ AX-R742BK	
The Marks Designated Areas	
A.....Australia	U.....Other Countries
G.....Germany	No mark indicates all areas.
E, EF.....Continental Europe	

■ System control & Display Section

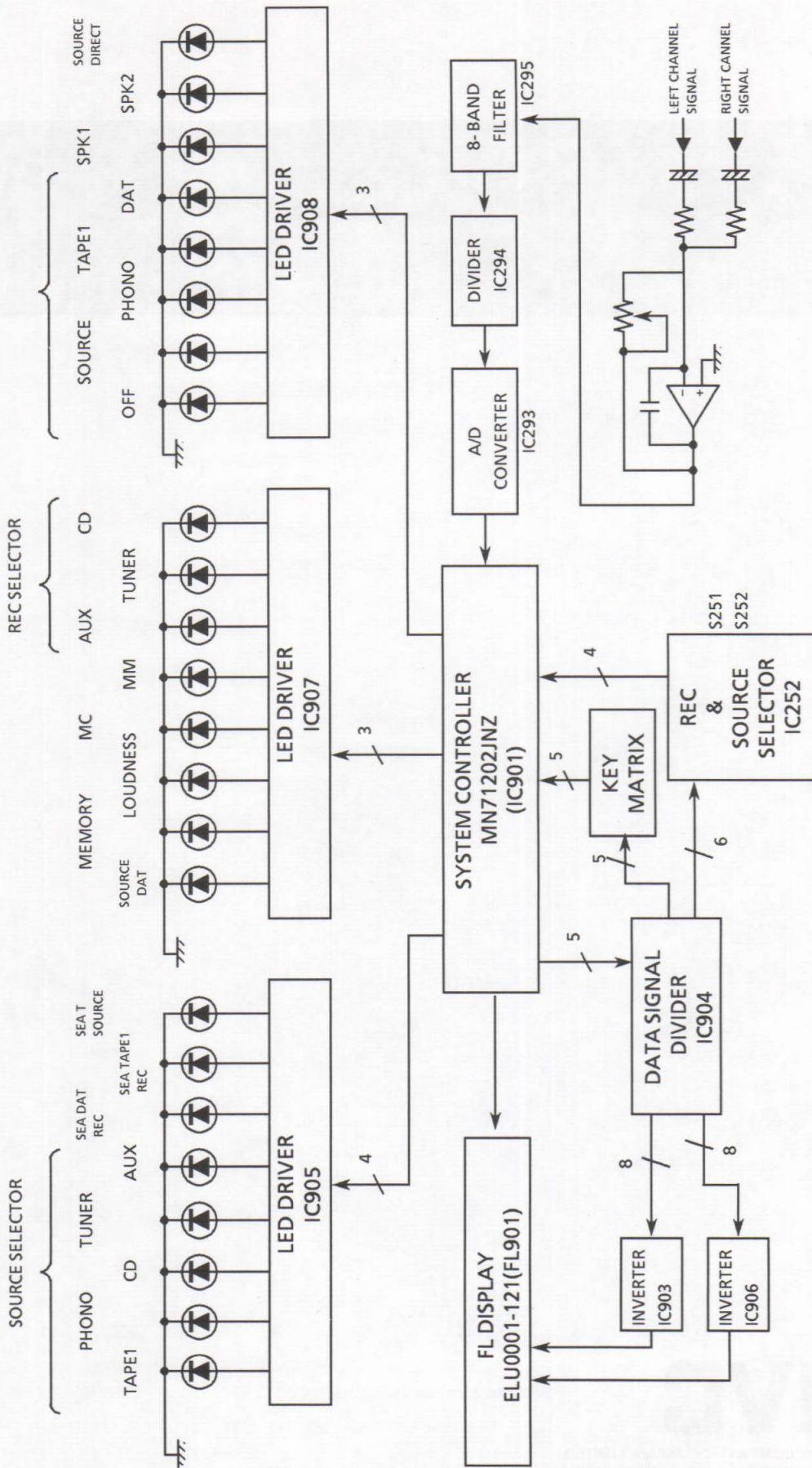

JVC

VICTOR COMPANY OF JAPAN, LIMITED
AUDIO DIVISION, 1644, SHIMOTSURUMA, YAMATO-SHI, KANAGAWA-KEN, 242, JAPAN