

Safety Precautions

1. The design of this product contains special hardware and many circuits and components specially for safety purposes. For continued protection, no changes should be made to the original design unless authorized in writing by the manufacturer. Replacement parts must be identical to those used in the original circuits. Service should be performed by qualified personnel only.
2. Alterations of the design or circuitry of the product should not be made. Any design alterations of the product should not be made. Any design alterations or additions will void the manufacturer's warranty and will further relieve the manufacturer of responsibility for personal injury or property damage resulting therefrom.
3. Many electrical and mechanical parts in the product have special safety-related characteristics. These characteristics are often not evident from visual inspection nor can the protection afforded by them necessarily be obtained by using replacement components rated for higher voltage, wattage, etc. Replacement parts which have these special safety characteristics are identified in the Parts List of Service Manual. Electrical components having such features are identified by shading on the schematics and by (Δ) on the Parts List in the Service Manual. The use of a substitute replacement which does not have the same safety characteristics as the recommended replacement part shown in the Parts List of Service Manual may create shock, fire, or other hazards.
4. The leads in the products are routed and dressed with ties, clamps, tubings, barriers and the like to be separated from live parts, high temperature parts, moving parts and/or sharp edges for the prevention of electric shock and fire hazard. When service is required, the original lead routing and dress should be observed, and it should be confirmed that they have been returned to normal, after re-assembling.
5. Leakage current check (Electric shock hazard testing)

After re-assembling the product, always perform an isolation check on the exposed metal parts of the product (antenna terminals, knobs, metal cabinet, screw heads, headphone jack, control shafts, etc.) to be sure the product is safe to operate without danger of electrical shock.

Do not use a line isolation transformer during this check.

- Plug the AC line cord directly into the AC outlet. Using a "Leakage Current Tester", measure the leakage current from each exposed metal part of the cabinet, particularly any exposed metal part having a return path to the chassis, to a known good earth ground. Any leakage current must not exceed 0.5 mA AC (r.m.s).

- Alternate check method

Plug the AC line cord directly into the AC outlet. Use an AC voltmeter having 1,000 ohms per volt or more sensitivity in the following manner. Connect a 1,500 Ω 10 W resistor paralleled by a 0.15 μF AC type capacitor between an exposed metal part and a known good earth ground.

Measure the AC voltage across the resistor with the AC voltmeter.

Move the resistor connection to each exposed metal part, particularly any exposed metal part having a return path to the chassis, and measure the AC voltage across the resistor. Now, reverse the plug in the AC outlet and repeat each measurement. Any voltage measured must not exceed 0.75 V AC (r.m.s). This corresponds to 0.5 mA AC (r.m.s).

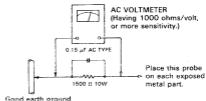

Warning

1. This equipment has been designed and manufactured to meet international safety standards.
2. It is legal responsibility of the repairer to ensure that these safety standards are maintained.
3. Repairs must be made in accordance with the relevant safety standards.
4. It is essential that safety critical components are replaced by approved parts.
5. If mains voltage selector is provided, check setting for local voltage.

SPECIFICATIONS

CIRCUITRY

- Preamplifier : ICL MCRM equalizer with EL-FETs in its initial stage
- Power amplifier : "DIGITAL PURE A TYPE II" "Dynamic Super-A" power amplifier with Om circuit

OVERALL CHARACTERISTICS

Output power
180 watts per channel, min. RMS, both channels driven into 8 ohms from 20 Hz to 20 kHz, with no more than 0.004% total harmonic distortion (U.S.A. and Canada only)

105 watts per channel, min. RMS, into 8 ohms at 1 kHz, with no more than 0.002% total harmonic distortion (U.S.A. and Canada only)

100 watts per channel, min. RMS, into 8 ohms at 1 kHz, with no more than 0.002% total harmonic distortion (Continental Europe, the U.K., Australia and other areas)

100 watts per channel, min. RMS, both channels driven, into 8 ohms at 1 kHz with no more than 0.7% total harmonic distortion (THD) (Continental Europe, the U.K., Australia and other areas)

180 watts 1 kHz, 4 ohms 0.7% (THD) (Continental Europe, the U.K., Australia and other areas)

Total harmonic distortion
U.S.A. and Canada
(CD IN → SP, OUT)

0.004% (20 Hz → 20 kHz, 8 ohms) at 100 watts

(PHONO IN → SP, OUT at volume)

0.009% (20 Hz → 20 kHz, 8 ohms) at 100 watts

Continental Europe, the U.K., Australia and other areas
(CD IN → SP, OUT)

0.004% (20 Hz → 20 kHz, 8 ohms) at 90 watts

(PHONO IN → SP, OUT at volume)

0.009% (20 Hz → 20 kHz, 8 ohms) at 90 watts

Intermodulation distortion
U.S.A. and Canada
(CD IN → SP, OUT)

0.004% (60 Hz : 7 kHz = 4 : 1, 8 ohms) at 100 watts

Continental Europe, the U.K., Australia and other areas
(CD IN → SP, OUT)

0.004% (60 Hz : 7 kHz = 4 : 1, 8 ohms) at 90 watts

Power band width
(CD IN → SP, OUT)

5 Hz → 60 kHz (HF, 0.03%, 8 ohms both channels driven)

Frequency response : 5 Hz to 100 kHz, +0 dB, -3 dB/8 ohms

Damping factor : 200 (1 kHz, 8 ohms)

Input sensitivity/impedance (1 kHz)

PHONO (MM) : 4 mV/47 kohms

PHONO (MC) : 300 μ V/75 kohms

CD, LINE 1 : 300 mV/30 kohms

LINE 2, LINE 3, DAT 1/TAPE 2, TAPE 1/DAT 2

Signal to noise ratio

PHONO (MM) : 69 dB/73 dB

PHONO (MC) : 77 dB

CD, LINE 1 : 112 dB/73 dB

LINE 2, LINE 3, DAT 1/TAPE 2, TAPE 1/DAT 2 (56 IHF/DM)

U.S.A. and Canada only
PHONO (MM) : 82 dB (Rec Out)

PHONO (MC) : 73 dB (Rec Out)

CD, LINE 1 : 86 dB (Speaker Out)

LINE 2, LINE 3, DAT 1/TAPE 2 (75 IHF)

Base control : 0 → +5 dB (50 Hz, MASTER LEVEL -30 dB)

Recording output
Output level/impedance : 300 mV/16 kohms (Analog)

2.0 V/16 kohms (Digital)

DIGITAL INPUT/OUTPUT
DIGITAL-1 : -23 → -14 dBm

DIGITAL-2 : 0.5 Vp-p/75 ohms

DAT REC : 0.5 Vp-p/75 ohms

DAT PLAY : 0.5 Vp-p/75 ohms

D/A CONVERTER SECTION
Sampling : 32 kHz, 44.1 kHz

frequencies (Auto selection) : 48 kHz

Total harmonic distortion (1 kHz) : 0.0003%

Dynamic range (1 kHz) : 96 dB

Signal-to-noise ratio : 107 dB

EQUALIZER
PHONO overload capacity

PHONO → TAPE 1 REC out ("TAPE 1 MONITOR on")

PHONO (MM) : 100 mV (1 kHz, 0.02% THD)

PHONO (MC) : 7 mV (1 kHz, 0.03% THD)

PHONO RIAA deviation : ±0.2 dB (20 Hz → 20 kHz)

GENERAL
Dimensions : 435 (W) x 173 (H) x 459 (D) mm (17.516" x 6.81316" x 18.111")

Weight : 16.8 kg (38 lbs)

Design and specifications subject to change without notice

(*measured by JVC Audio Analyzer System)

POWER SPECIFICATIONS

Area	Line Voltage & Frequency	Power Consumption
U.S.A.	AC 120 V ~, 60 Hz	550 watts / 720 VA
Canada		
Continental Europe	AC 220 V ~, 50 Hz	400 watts
U.K.		
Australia	AC 240 V ~, 50 Hz	560 watts
Other areas	AC 110 / 127 / 220 / 240 V ~, selectable, 50/60 Hz	

CONNECTION DIAGRAM

ANSCHLUSS- DIAGRAMM

DIAGRAMME DES RACCORDEMENTS

CD player
CD-Player
Lecteur de disques compacts
Kompakt diskspeler
Tocadiscos compacto
CD spelare

Tuner
Tuner
Synthesizer
Tuner
Synthesizer
Tuner

Hi-Fi VCR
Hi-Fi videorecorder
Magnétoscope de haute fidélité
Hi-Fi videorecorder
Grabador de videocassettes
Hi-fi videorecorder

Hi-Fi VCR
Hi-Fi videorecorder
Magnétoscope de haute fidélité
Hi-Fi videorecorder
Grabador de videocassettes
Hi-fi videorecorder

DAT deck
DA-Tonbandgerät
Enregistreur audiovisuel
DAT digital deck
Magnétoscope digital
Digitalkassetdeck

Tapc deck
Kassetdeck
Plateine d'enregistrement
Cassetdeck
Magnétoscope
Kasset bandspeler

SEA graphic equalizer
Grafische SEA Equalizer
Égaliseur graphique SEA
SEA grafische equalizer
Equalizator grafic SEA
SEA grafik equalizer



Turntable
Platine
Tourne disques
Diskspeler
Tocadiscos
Skivspeler



Speakers
Lautsprecher
Ensemble acoustique
Lautsprecher
Atacoras
Högspalter

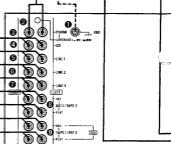

For the USA and Canada
Für die USA und Kanada
Pour les États-Unis et le Canada
Voor de USA en Canada
Para los EE.UU. y Canada
For USA och Kanada

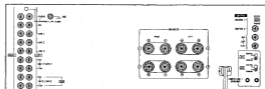

Fig. 2
Abb. 2
Afb. 2

For Continental Europe, the U.K., and Australia
Für Europa, Großbritannien und Australien
Pour l'Europe Continentale, le Royaume-Uni et l'Australie
Voor het vasteland van Europa, U.K. en Australië
Para Europa Continental, el Reino Unido y Australia
Für kontinentale Europa, Großbritannien und Australien

ANSLUITINGS- DIAGRAM

Speakers
Lautsprecher
Enceintes acoustiques
Lautsprecher
Altoparlanti
Högskåpa



DIAGRAMA DE CONEXIONES

Optical cable
Optikkabel
Câble optique
Optische kabel
Cable optico
Optisk kabel

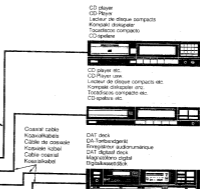

Coaxial cable
Köaxialkabel
Câble de coaxiale
Köaxiale kabel
Cable coaxial
Köaxialkabel

Note:
When connecting a CD player and a DAT deck that will accommodate COMPU LINK, use this switch to select which will be made to accommodate COMPU LINK, a digital system or an analog system.

Hinweis:

Beim Anschluß eines CD-Spielers und eines DAT-Decks, die mit COMPU LINK kompatibel sind, geben Sie mit diesem Schalter vor, ob die Verbindung durch COMPU LINK über eine digitale oder eine analoge Anlage hergestellt werden soll.

Remarque:

Lors du raccordement d'un lecteur de disque numérique et d'une platine DAT qui permettent d'utiliser le système COMPU LINK, régler ce commutateur pour sélectionner le système, numérique ou analogique, qui acceptera COMPU LINK.

Opmerking:

Bij het aansluiten van een CD-speler en DAT-deck geschikt voor COMPU LINK, dient met deze schakelaar het systeem te worden gekozen voor COMPU LINK, digital of analog.

Nota:

Cuando conecta un reproductor de discos compactos y un magnetofono DAT que acomoden el COMPU LINK, utilice este interruptor para seleccionar cuál sistema, el digital o el analógico, será el que acomodará el COMPU LINK.

Ann.:

Vid anslutning av en CD-spelare och ett DAT-kassettdäck med COMPU LINK, skall du använda denna ankopplingsen för att välja den ljudkälla som skall anslutas med COMPU LINK, ett digitalt eller analogt system.

Remote cable for "COMPU LINK"
Fernbedienkabel für "COMPU LINK"
Câble de télécommande pour "COMPU LINK"
Afsandbedieningskabel voor "COMPU LINK"
Cable de mando a distancia para "COMPU LINK"
Fjärrstyningsskåpa för "COMPU LINK"

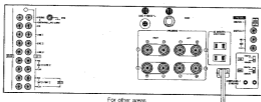

For other areas
Anderen Gebiete
Pour d'autres pays
Voor andere landen
Para otros países
För andra länder

Fig. 1
Abb. 1
Abf. 1

Fig. 3
Abb. 3
Abf. 3

- 1 GND terminal
- 2 Phono selector switch (CARTRIDGE) (- MC, MM) — This switch selects between MC and MM type cartridges. When depressed, MC is selected. When returned to the original position MM is selected.
- 3 PHONO terminals
- 4 CD terminals
- 5 LINE 1 terminals
- 6 LINE 2 terminals
- 7 LINE 3 terminals
- 8 DAT 1/TAPE 2 terminals
- 9 TAPE 1/DAT 2, SEA terminals
- 10 AC voltage selector*
When this equipment is used in an area where the supply voltage is different from the preset voltage, reset the voltage selector to the correct position.
- 11 FUSE holder**
- 12 SPEAKERS terminals
Connect the speaker cords following the figures.
- 13 AC OUTLETS**
UNSWITCHED AC outlets
- 14 Power cord
- 15 DIGITAL Terminals:
DIGITAL 1: Connect the optical digital output of CD player, etc. Connect the attached optical fiber cable after removing the connector cover.
DIGITAL 2: Connect the coaxial digital output of CD player, etc.
DAT REC: Connect the digital input of DAT deck.
DAT PLAY: Connect the digital output of DAT deck.
Digital coaxial cable: Use 75 ohm coaxial cable with RCA pins at both ends to connect the DIGITAL 2 and DAT terminals.
- 16 COMPU LINK-1/SYNCHRO terminals
Connect to units provided with a COMPU LINK-1/SYNCHRO terminal to let the COMPU LINK control system function.

Note:

- **COMPU LINK changeover switch**
When operating an automatic playback or a synchronized recording, be sure to set this switch to the correct position to perform desired operation.

* Not provided on units for the U.S.A., Canada, Continental Europe, the U.K. and Australia.

** Not provided on units for Continental Europe, the U. K. and Australia.

Notes:

1. Switch the power off when connecting any component.
2. Connect source components with left and right channels connected correctly. Reversed channels may degrade the stereo effect.
3. Connect speakers with correct polarity; (+) to (+) and (-) to (-). Reversed polarity will degrade the stereo effect.
4. Connect plugs or wires firmly. Poor contact may result in hum or damage the unit.
5. Do not connect equipment requiring more than the rated power to the AC OUTLETS on the rear panel.
6. The AC OUTLETS are not switched off when the front panel power switch is switched off.
7. If your turntable has a separate ground lead, connect it to the GND terminal.
8. Use speakers with the correct impedance within the value indicated on the rear panel.
9. Connection of digital signal cable
Before connecting the optical cable to the DIGITAL 1 optical input terminal remove the cover from the terminal. Since optical cable is made of plastic or glass material be careful not to bend sharply.
10. When connected by COMPU LINK the cassette deck should be connected to the corresponding TAPE 1/DAT 2 terminals on the amplifier and the DAT deck should be connected to the corresponding DAT 1/TAPE 2 terminals. Although it is possible to connect a cassette deck and a DAT deck with the DAT 1/TAPE 2 terminals and the TAPE 1/DAT 2 terminals respectively, when connecting with an equipment corresponding to COMPU LINK of JVC, do not connect the COMPU LINK cable with the cassette deck or the DAT deck.
11. When a JVC's CD player is connected by COMPU LINK in digital system, connect to DIGITAL 1 and CD (analog system) terminals of this unit, and set the COMPU LINK changeover switch (CD) to "DIGITAL" position.

FRONT PANEL

1 POWER

Turns the power on and off. When the power is turned on, the upper indicator will flicker then light. Power is alternated on and off everytime the button is pressed.

Note:**• Back up circuit**

Even if the power is turned off or there is a power failure, the back up circuit will continue to operate and maintain the button settings for about three days. However, after this period has been exceeded the memory circuit will cancel and the button settings will be lost. In this situation press the buttons you want once more.

2 Sampling frequency indicator

In response to a digital signal input a sampling frequency will be displayed in this section.

3 DIA CONVERTER DIRECT

When this button is pressed the indicator will light and a signal from a CD player or some other component connected to the **DIGITAL** terminal will input directly into the power amplifier. Very high quality HiFi sound reproduction with DIGITAL PURE A TYPE II is achieved.

4 MASTER LEVEL CONTROL

This knob is used to adjust the volume of the speakers or headphones.

5 PHONES (headphone jack)**6 REMOTE SENSOR**

This sensor receives the signal transmitted from the remote control unit. When a signal is being received the indicator will light.

7 SPEAKERS

These are the on/off buttons for speakers 1 and 2. When this button is pressed to on, the indicator above the button will light.

8 Analog input selector

Changes the analog system source connected to the CD, LINE 1-3, PHONO, and DAT 1/TAPE 2 terminals.

When each button is pressed, the indicator above the button will light. When DIA CONVERTER DIRECT or **9 DAT MONITOR** is operated, the indicator will be off and the source will be changed to the digital system.

9 TAPE 1/DAT 2 (TAPE 1 ▶ DAT 1)

Turn ON when adding a tape deck connected to the TAPE 1/DAT 2 terminal to replay/record monitor, when using equipment such as a SEA graphic equalizer, or when copying (dubbing) from TAPE 1/DAT 2 to DAT 1/TAPE 2.

When it is turned ON, the MONITOR/COPY indicator above the button will light. The power is alternated ON/OFF everytime the button is pressed. (Even if another source is selected, it will not automatically be turned OFF.) Since this button (source) has the highest priority of all sources, set 4 OFF except in the above cases.

10 Digital input selector

This can be used to change the digital system source connected to the DIGITAL 1 and DIGITAL 2 terminals.

When each button is pressed, the indicator above the button will light. When the analog input selector is operated, the indicator will be off and the source will be changed to the analog system.

11 DAT MONITOR

Press this button to on when monitoring playback/recording of a DAT deck connected to the DAT digital terminals. When this button is pressed to on, the indicator above the button will light. ON/OFF is alternated everytime the button is pressed. (Selecting another digital source does not turn it off automatically.)

12 BASS CONTROL

When music volume is turned down the human ear tends to become less aware of bass sound. This can be compensated for by adjusting the bass control knob so that you can enjoy powerful bass even at low sound level.

13 BALANCE

This knob adjusts the volume balance between the left and right speakers. Normally it is set to the center. (When DIA CONVERTER DIRECT is being used this knob will not operate.)

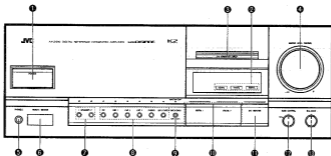

Fig. 4

HOW TO OPERATE

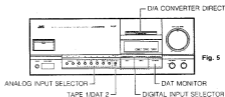

Fig. 5

Turn the MASTER LEVEL CONTROL knob down before turning on the power. Connect the tuner and video components to LINE 1 – 3 respectively in accordance with the diagram on page 5, 6 (showing connections).

Drehen Sie den MASTER LEVEL CONTROL-Knopf herunter, bevor Sie den Netzstrom einschalten. Schließen Sie den Tuner und die Video-Komponenten an die Buchsen LINE 1 – 3 an, wie im Anschlussdiagramm auf Seite 5, 6 gezeigt.

Abaisser le bouton de contrôle de niveau principal (MASTER LEVEL CONTROL) avant de fournir l'alimentation. Raccorder le sintoniseur et les appareils vidéo à la ligne 1 – 3 (LINE 1 – 3) respectivement suivant le diagramme de page 5, 6 indiquant les raccordements.

When have you selected? Sound Was haben Sie gewählt? Ton		When have you selected? Sound Was haben Sie gewählt? Ton			
		ANALOG INPUT SELECTOR	TAPE 1 / DAT 2 (TAPE 1 ▶ DAT 1)	DIGITAL INPUT SELECTOR	DAT MONITOR
RECORD (Turntable, Plattenspieler, Tourne-disque)		PHONO (MM/MC)		—	
CD	OUTPUT	OPTICAL DIGITAL		DIGITAL 1	OFF
		ANALOG	CD	—	
FM/AM Broadcast FM/AM-Rundfunksendungen Emission en FM/AM		LINE 1	OFF	—	
VIDEO (Hi-Fi VIDEO, etc.)		LINE 2, LINE 3		—	
TAPE BAND BANDE	OUTPUT	COAXIAL DIGITAL DAT		—	ON
		ANALOG DAT 1/TAPE 2	DAT 1/TAPE 2	—	OFF
		ANALOG TAPE 1/DAT 2	—	ON	—

Fig. 6

DIA CONVERTER DIRECT switch

When this switch is operated the digital input is received directly by the power amplifier and the balance circuit and source selector circuit are bypassed. The DIA CONVERTER (Digital Analog Converter) output is input directly into MASTER LEVEL CONTROL and very clear high-fidelity performance is achieved. Accordingly, when the DIA CONVERTER DIRECT function is on, ANALOG recording and the balance function will not operate.

Notes:

- During the reception of television or FM radio signals, depending on the broadcasting station frequency, noise might appear in this type of situation, cut off the power to the digital unit.

DIA CONVERTER DIRECT-Schalter

Wenn Sie diesen Schalter betätigen, wird das Digitaleingangssignal direkt vom Endverstärker empfangen, wobei Balance-Schaltkreis und Signalquellenwahl-Schaltkreis umgangen werden. Der DIA CONVERTER-Ausgang (Digital-Analog-Umsetzer) liegt direkt am MASTER LEVEL CONTROL an, wodurch höchste Hi-Fi-Registrierung gewährleistet ist. Wenn die DIA CONVERTER DIRECT-Funktion eingeschaltet ist, sind ANALOG-Aufnahmefunktion und Balanceeinstellungsfunktion also nicht aktiv.

Hinweise:

- Während des Empfangs von Fernseh- oder UKW-Signalen können — je nach der Frequenz der Signalfrequenz — durch Digitalgeräte wie CD-Spieler Geräusche auftreten. In diesem Falle die Stromversorgung zum Digitalgerät abschalten.

Commutateur direct de convertisseur numérique-analogique (DIA CONVERTER DIRECT)

Lorsque ce commutateur est manipulé, l'entrée numérique est directement reçue par l'amplificateur de puissance, et le circuit de balance et le circuit de sélecteur de source sont ignorés. La sortie de convertisseur numérique-analogique (DIA CONVERTER) est directement entrée dans le contrôle de niveau principal (MASTER LEVEL CONTROL), et la reproduction sonore de très haute fidélité est ainsi réalisée. Par conséquent, lorsque la touche de fonction direct de convertisseur numérique-analogique (DIA CONVERTER DIRECT) est sur la position marche, l'enregistrement analogique (ANALOG) et la commande de balance ne s'effectuent pas.

Remarques:

- Pendant la réception des signaux de la télévision ou de la radio FM, selon la fréquence de la station émettrice, le bruit pourrait se produire des appareils numériques tels que le lecteur de disques compacts. Dans une telle situation, couper l'alimentation de l'appareil numérique.

- When pressing DIGITAL INPUT SELECTOR, DAT MONITOR or D/A CONVERTER DIRECT button, while analog system source is selected, there is about 4-seconds blank before switching to digital system source.

Recording

1. Choose either an analog or a digital source that can be heard through the speakers. In this situation a 3 head tape deck connected to the REC terminal of either DAT 1/TAPE 2 or TAPE 1/DAT 2 can receive a recording signal and recording is possible. Recording level is adjusted from the tape deck, not from the MASTER LEVEL CONTROL. (Please refer to the table on page 17, 19 which shows button settings for various source and recording combinations.)
2. As the amplifier has both DIGITAL and ANALOG type input output terminals for a tape deck a variety of combinations are possible.

- Wenn Sie bei Betrieb eines Analog-systems auf DIGITAL INPUT SELECTOR, DAT MONITOR oder D/A CONVERTER DIRECT umschalten, vergehen etwa 4 Sekunden, bevor das Gerät auf die digitale Tonquelle umschaltet.

Aufnahme

1. Verwenden Sie eine Analog- oder Digital-Signalkette, die über die Lautsprecher zu hören ist. Ein 3-Tonkopf-Kassettendeck, das an die REC-Anschlüsse von entweder DAT 1/TAPE 2 oder TAPE 1/DAT 2 angeschlossen ist, kann ein Aufnahmeignal empfangen und ermöglicht damit die Aufnahme. Der Aussteuerungspegel wird vom Kassettendeck her kontrolliert und nicht von MASTER LEVEL CONTROL. (Bitte beachten Sie sich auf die Tabelle von Seite 17, 19, wo die verschiedenen Knopf- und Tasteneinstellungen für Signalketten- und Aufnahme-Kombinationen aufgeführt sind.)
2. Da der vorliegende Verstärker für das Kassettendeck sowohl über DIGITAL- als auch ANALOG Ein/Ausgangsbuchsen verfügt, sind viele Zusammenstellungen möglich.

- Lorsque le sélecteur d'entrée numérique (DIGITAL INPUT SELECTOR), le bouton de DAT MONITOR ou D/A CONVERTER DIRECT est enfoncé, alors qu'une source de système analogique est sélectionnée, il y a une coupure d'environ 4 seconds avant la commutation sur la source de système numérique.

Enregistrement

1. Choisir une source analogique ou numérique qui peut être écoutée à travers les haut-parleurs. Dans ce cas, une platine d'enregistrement à 3 têtes raccordée à la borne d'enregistrement (REC) du magnétophone audionumérique 1 bande 2 (DAT 1/TAPE 2) ou du bande 1/magnétophone audionumérique 2 (TAPE 1/DAT 2) peut recevoir un signal d'enregistrement, permettant ainsi l'enregistrement. Le niveau d'enregistrement est réglé depuis la platine d'enregistrement, et non pas depuis la commande de niveau sonore principal (MASTER LEVEL CONTROL). (Se référer à la table de page 17, 19 indiquant le réglage des touches pour diverses combinaisons de source et d'enregistrement.)
2. Cet amplificateur est muni des bornes d'entrée/sortie numérique et analogique pour un lecteur de bandes, et diverses combinaisons sont donc possibles.

Which combination of source combinations? Quelle combinaison?		Operation capabilities Befähigungskombinationen Fonction technique source			
		ANALOG INPUT SELECTOR	TAPE 1/DAT 2 (TAPE 1 ▶ DAT 1)	DIGITAL INPUT SELECTOR	DAT MONITOR
DIGITAL → DIGITAL					
DIGITAL 1 (OPTICAL)	DAT (COAXIAL)	Digital recording cannot be made from a CD or other media that has a copy prohibition code included in the digital signal. Digital-Aufnahme von einer CD-Platte oder einer anderen Klangquelle mit Kopierschutzcode in den Digital-Signalen ist nicht möglich. Il n'est pas possible de faire un enregistrement numérique à partir d'un CD ou par un autre moyen comportant un code interdisant tout enregistrement, qui est intégré dans le signal numérique.			
DIGITAL 2 (COAXIAL)	DAT (COAXIAL)	—	—	DIGITAL 2	— [Monitoring is possible when ON.] (Mithören möglich, wenn eingeschaltet.) (Le contrôle est possible lorsque système est allumé.)
DIGITAL → ANALOG					
DIGITAL 1 (OPTICAL)	DAT 1/TAPE 2	—	OFF	—	—
DIGITAL 2 (COAXIAL)	TAPE 1/DAT 2	—	— (Monitoring is possible when ON.) (Mithören möglich, wenn eingeschaltet.) (Le contrôle est possible lorsque le système est allumé.)	Select the source you want to record. Die aufzunehmende Klangquelle auswählen. Selecter la source désirée.	OFF
DAT (COAXIAL)	DAT 1/TAPE 2	Recording is impossible. Aufnahme ist nicht möglich. L'enregistrement n'est pas possible.			
	TAPE 1/DAT 2	—	— (Monitoring is possible when ON.) (Mithören möglich, wenn eingeschaltet.) (Le contrôle est possible lorsque le système est allumé.)	—	ON

Fig. 8

When D/A Converter is Off (D/A Converter Direct Converter)		Operation of Main System during the D/A Converter is Off (D/A Converter Direct Converter)			
Analog Input Selection		ANALOG INPUT SELECTOR	TAPE 1/DAT 2 (TAPE 1 ▶ DAT 1)	DIGITAL INPUT SELECTOR	DAT MONITOR
ANALOG - ANALOG			OFF		
CD LINE 1 LINE 2 LINE 3 PHONE	DAT 1/TAPE 2	Select the source you want to record. Die zuzunehmende Klangquelle anwäh- len. Sélectionner la source désirée.	— (Monitoring is possible when ON.) (Mithören möglich, wenn eingeschaltet.) (Le contrôle est possible lorsque le système est allumé.)	—	—
	TAPE 1/DAT 2				
DAT 1/TAPE 2	TAPE 1/DAT 2	DAT 1/TAPE 2	— (Monitoring is possible when ON.) (Mithören möglich, wenn eingeschaltet.) (Le contrôle est possible lorsque le système est allumé.)		
TAPE 1/DAT 2	DAT 1/TAPE 2	Select other than DAT 1/TAPE 2. Eine andere als die Position DAT 1/TAPE 2 wählen. Sélectionner autre que DAT 1/TAPE 2.	ON		

Fig. 10

Note:

- This table shows the status when the D/A CONVERTER DIRECT is off.

Hinweis:

- Diese Tabelle zeigt den Betriebszustand, wenn D/A CONVERTER DIRECT ausgeschaltet ist.

Remarque:

- Ce tableau indique le statut lorsque D/A CONVERTER DIRECT est désactivé.

Notes:

- When recording to a tape deck of analog system, set the D/A CONVERTER DIRECT button to off.
- DAT which is connected to the DIGITAL terminal from the source of the analog system cannot be recorded.
- Regarding CD software and digital signals which have a copy prohibit code in the source, a digital recording cannot be made.
- When monitoring a recording to a 3 head tape deck should be connected to TAPE 1/DAT 2 terminals and the TAPE 1/DAT 2 button should be on.
- During synchronized recording, the source is locked to CD or PHONE position to avoid accidental stops or changing to another source.

Hinweise:

- Für Aufnahmen auf das Kassettendeck einer Analoganlage schalten Sie die D/A CONVERTER DIRECT Taste ausgeschaltet ist.
- Wenn der DIGITAL-Anschluß mit der Signalkette eines Analog-Systems verbunden ist, kann kein DAT-Band aufgenommen werden.
- Wenn CD-Software und digitale Signale mit einer Kopiersperrodcodierung versehen sind, kann keine digitale Aufnahme durchgeführt werden.
- Wenn die Aufnahme auf ein 3-Tonkopf-kassettendeck mit der Monitor-Funktion überwacht werden soll, sollte das Kassettendeck an die TAPE 1/DAT 2-Anschlußbuchsen angeschlossen werden und der TAPE 1/DAT 2 Schalter eingeschaltet sein.
- Bei Synchro-Aufnahme wird die Signalquelleneinstellung für CD oder PHONE verriegelt, so daß unbeabsichtigte Unterbrechungen oder Umschaltung auf andere Signalquellen vermieden werden.

Remarques:

- Lors d'un enregistrement vers un magnétocassette de système analogique, régler la touche D/A CONVERTER DIRECT sur la position désactivé.
- Il est impossible d'effectuer l'enregistrement du magnétophone audionumérique raccordé à la borne numérique (DIGITAL) de la source du système analogique.
- Pour les signaux des logiciels ou numériques du disque compact/disque compact vidéo (CD) comportant un code d'interdiction de copie dans la source, il est impossible d'effectuer l'enregistrement numérique.
- Lors du contrôle d'un enregistrement pour une platine d'enregistrement à 3 têtes (3 head tape deck), la platine doit être raccordée aux bornes de bande 1/magnétophone audionumérique 2 (TAPE 1/DAT 2), et le commutateur du moniteur de bande 1/magnétophone audionumérique 2 (TAPE 1/DAT 2) doit être mis sur la position marche.
- Pendant l'enregistrement synchronisé, la source est verrouillée à la position CD ou PHONE pour éviter des arrêts accidentels ou de changer de source.

Digital Pure A TYPE II

If an amplifier is equipped with the built-in D/A converter, "signal time base control" becomes easy owing to the special characteristics of digital signals.

Utilization of this special characteristics allows an amplifier to perform optimal A class operation. Although the A class operation can be said to be the ideal type for amplifiers, for an A class amplifier with mass output, even at low level restart, a mass current was always flowing to the power unit. This caused a remarkable loss in the power unit and generated unnecessary heat. Digital Pure A Type II realizes the effective ideal A class operation to curb unnecessary heat from the low level to the high level consisting of three blocks by varying the operation current in the power unit to the optimum level for each signal. Accordingly, a relaxing yet powerful and silk-like smooth sound quality can be enjoyed.

Time Base Processor by memory time shift circuit ①

Arranged just before the D/A converter to slightly shift the time axis of the input digital signal.

Prediction Signal Processor ②

Creates a prediction signal from the input digital signal based on the information obtained from the input signal to the time base processor, and outputs an operation point control signal grounded on the created prediction signal.

Programmable Bias Current Controller ③

Receives the control signal in ④, alters the biasing current by the optical BIAS circuit and leads to the Hi-Power Pure A class operation to curb unnecessary heat.

- ① Input
- ② Time base processor
- ③ D/A converter
- ④ VOLUME
- ⑤ Power amplifier
- ⑥ Output
- ⑦ Prediction signal processor
- ⑧ Programmable bias current controller

COMPU LINK REMOTE CONTROL SYSTEM

The COMPU LINK REMOTE CONTROL SYSTEM was developed by JVC. You can control each COMPU LINK component from the remote control unit, and also perform the following advanced operations with ease.

Automatic source selection

If the remote cable is used to connect this unit to other JVC components with COMPU LINK-15YIN-CHRO terminals. By pressing the remote control unit source selector button or the play button of each connected equipment, the source changeover and regenerated start can be performed automatically.

When switching from one component to another, such as a cassette deck, turntable or CD player, the previous component will stop playing after about five seconds.

Synchronized recording

Synchronized recording refers to the process whereby a cassette deck automatically commences recording, in synchronization with the CD player or turntable.

Set the cassette deck to the REC/PAUSE mode according to the procedures in the instruction manual.

When synchronously recording the CD player, push the PLAY button on the CD player. The cassette deck enters the record mode the moment the CD player starts and synchronized recording commences.

Synchronized recording stops automatically when the CD player stops playing.

To cancel synchronized recording, push the STOP button of the CD player, turntable or cassette deck.

Note:

- When operating a CD player or a DAT deck, select analog or digital system by the COMPU LINK changeover switch of this unit. If the switch is set to the wrong position, desired operation cannot be performed.

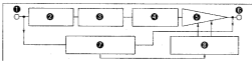

Fig. 12

REMOTE CONTROL UNIT (RM-SA1010U)

Batteries

• How to install the batteries (Fig. 13)

1. Remove the battery cover by sliding the cover of the battery case in the direction of the arrow.
2. Install the provided batteries ("AA": UM-3, R6, 1.5 V), with their polarities properly placed. Positive and negatives facing the correct direction.
3. Re-install the battery cover.

• Battery life

The batteries can be used for an average of 1 year.

• Battery replacement time

When the distance at which the remote control unit functions begins to decrease, replace the batteries ("AA": UM-3, R6, 1.5 V).

To operate the amplifier with the remote control unit (RM-SA1010U) point it towards the "REMOTE SENSOR" and press the buttons you want. The remote control unit will activate the amplifier within a range of about 7 meters (23 ft) if the remote control unit is operated while being held at an oblique angle the effective range will be reduced. Try to point the unit directly towards the REMOTE SENSOR of the amplifier.

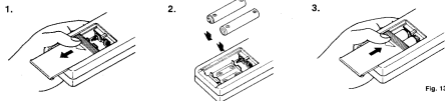

Fig. 13

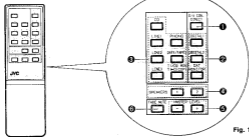

Fig. 14

DESCRIPTION AND FUNCTIONS

1. D/A CON. DIRECT

When this button is pressed the indicator will light and with DIGITAL PURE A TYPE is a CD player or some other component connected to the DIGITAL INPUT terminals will be heard in very high grade HFI sound.

2. Source Selector

[Digital type]

(Unit connected by COMPU LINK can be automatically operated using the remote control unit)

DIGITAL 1: Press this button to play a unit connected to the DIGITAL 1 terminal.

DIGITAL 2: Press this button to play a unit connected to the DIGITAL 2 terminal.

DAT MONITOR: Press this button to monitor a recording or to play the DAT deck connected to the DAT **DIGITAL** REC or PLAY terminals on the amplifier. If pressed again the function will stop.

3. Source Selector

[Analog type]

(Unit connected by COMPU LINK can be automatically operated using the remote control unit)

CD: To play the CD player press the CD button on the remote control unit.

PHONO: To play the turntable press the PHONO button on the remote control unit.
LINE 1: Press the LINE 1 button to play a unit connected to the LINE 1 terminals on the amplifier.

LINE 2: Press this button to play a unit connected to the LINE 2 terminals on the amplifier.

LINE 3: Press this button to play a unit connected to the LINE 3 terminals on the amplifier.

DAT 1/TAPE 2: Press this button to play a unit connected to the DAT 1/TAPE 2 terminals.

T 1/D 2 MON, T 1 - D 1 copy: Press this button to on when monitoring playback/recording of a tape deck connected to TAPE 1/DAT 2 terminals, or when using SEA graphic equalizer, or when copying (dubbing) from TAPE 1/DAT 2 to DAT 1/TAPE 2.

4. SPEAKERS

These are the on/off buttons for speakers 1 and 2.

5. MASTER LEVEL

→ As this button is being pressed the MASTER LEVEL CONTROL knob will slowly turn counterclockwise and the volume will be reduced.

← As this button is being pressed the MASTER CONTROL LEVEL will slowly turn clockwise and the volume will be increased.

6. FADE MUTE

When this button is pressed the MASTER LEVEL CONTROL knob will turn down and the sound will be softened.

(Each time the button is pressed the sound will be further reduced.)

USING S.E.A. GRAPHIC EQUALIZER/ PROCESSOR

To enjoy HiFi SOUND FIELD control and TONE adjustment you can connect a SEA graphic equalizer or a DAP (Digital Acoustics Processor) to the TAPE 1/DAT 2 terminals of the amplifier.

Note:

- When the D/A CONVERTER DIRECT function is on, the SEA graphic equalizer connection will not operate.

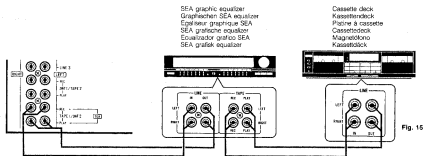

■ Connecting to SEA (Fig. 15)

- When operating SEA or playing back a deck connected to SEA, turn on the TAPE 1/DAT 2 button and turn off the D/A CONVERTER DIRECT button of this unit.

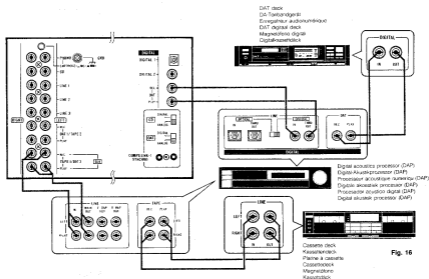

■ Connecting to processors

(Fig. 16)

Connecting to a JVC's DAP

- When operating DAP or playing back a deck connected to DAP, operate the button of this unit as follows.

Digital connection:

DAT MONITOR button → on

TAPE 1/DAT 2 button → off

Analog connection:

TAPE 1/DAT 2 button → on

DIA CONVERTER DIRECT button → off

- When connecting this unit to a JVC's DAP, set the OFFS DELAY parameter of the DAP as follows.

Input source of this unit Eingangsansignal des Geräts Source d'entrée de cet appareil	OFFS DELAY setting value of DAP OFFS DELAY Einstellwert des DAP Valeur de réglage OFFS DELAY du DAP		
DIGITAL	fs 48 kHz 10 ms	fs 44,1 kHz 10 ms	fs 32 kHz 10 ms
ANALOG	0 ms		

TROUBLESHOOTING

Check the following points before calling for repairs.

There is a difference between the sound level from the record player and the level from another source.

The MM/MC type cartridge selector switch is not set in the correct position.

— Set the selector switch on the back of the amplifier correctly.

No sound output

Erroneous cable connection

— Correct the connection

The input selector switch is not in the right position.

— Set SW1CH in the correct position.

The TAPE 1/DAT 2 switch is in the "on" position.

— Press the TAPE 1/DAT 2 button so that the indicator light goes off.

Speaker line are disconnected.

— Check connections between the back of the amplifier and the speakers.

Sound is only coming from one speaker.

The lines going to a speaker are disconnected.

— Check connections between the speakers and the back of the amplifier.

The BALANCE knob is turned completely to one side.

— Return the BALANCE knob to the center.

When the volume is turned up while listening to a record there is a booming sound.

The record player is picking up vibrations from the speakers. (howling)

— Move the speakers well away from the record player and place the record player on a firm base.

Description of Technology

1. Digital Pure-A

The "Digital Pure-A" is an operation system materialized based upon the new concept of "signal prediction". In a conventional digital amplifier, the input digital signal is decoded by the built-in digital decoder and is applied to the D/A converter as it is. In the "Digital Pure-A", however, the input digital signal is once stored in a memory circuit and, after the large lapse of a certain period, is output to the D/A converter, in which way the signal is delayed so that signal prediction is thus made possible by the preceding signal. In the AX-Z1010TN, the Digital Pure-A operation is performed by varying the bias current according to the level of the signal preceding 10 msec.

2. Prediction Signal Generation Circuit

(1) Preceding signal (H.O, DZ)

Of the serial data output from pin 17 of IC106 (YM3623B), two bits of MSB and 2SB are latched by IC261 in to an EX-OR circuit, the output of which becomes "H" when the playback signal level exceeds -6 dB and is held at C262 on the way for a certain time and is emitted from pin 1 of J403. (Half Over signal)

In addition, concurrently with this, the serial data is held at C269 for a certain time and is emitted from pin 3 of J403. (Digital Zero signal)

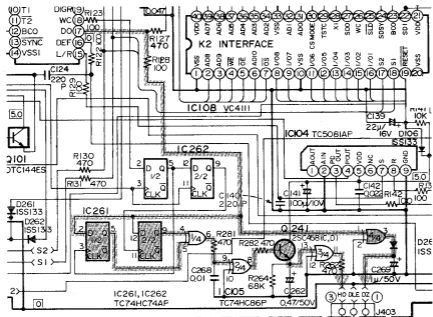
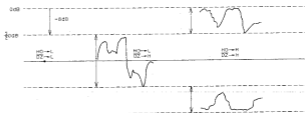

Figure 1. Prediction Signal Generation Circuit

Then, by these two signals, judgement is made as to at which level the musical signal is.



(2) Delay signal (Vb)

The time base processor (IC108) writes in a 16-Kbyte SRAM the serial data sent from the digital interface receiver and at the same time reads the serial data which has been delayed 10 msec and outputs this delayed serial data to the D/A converter.

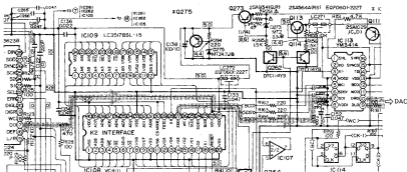

Figure 2. Delay Circuit

(3) Full-wave rectification outputs (VL, VR)

The delayed analog signal which is power amplified in the power amplification stage is subject to full-wave rectification (IC701 and IC702), the output of which is held at C703 for a certain time. This time constant is determined by R719.

The L-ch and R-ch outputs of this full-wave rectification circuit are here assumed as VL and VR.

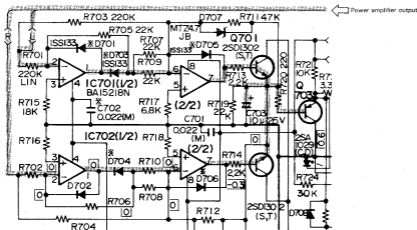

Figure 3. Full-wave Rectification Circuit

(4) Judgement circuit and bias current control

The outputs (from the emitters of Q707 and Q708) of the generated preceding signals (H.O, \overline{DZ}) are subject to comparison with the full-wave rectification outputs (VL, VR). The greater outputs enter to the bases of Q705 and Q706 by way of Q703, thus the collector outputs drive the photocoupler (IC403, IC404) to control the bias current.

Removal Procedures

■ Removing the Top Cover

1. Remove the four screws from the top plate, then the eight screws, each four from either side, and the three screws from the rear side.
2. Lift up off the top cover gently by its rear section. (Figure 1)



Figure 1.

■ Removing the Front Panel

1. Remove the top cover.
2. Detach the volume control knob.
3. Remove the two plastic rivets fixing the bracket of the indicator board (ENE-051-4), then also the two plastic rivets for ENE-015-5.
4. Remove the six screws fixing the front panel (three from its upper side and the other three from its lower side).

■ Removing the Front PC Board and the Key Input PC Board

1. Remove the front panel.
2. Disconnect the flat wires from connectors J905, J903 and J906 on the front PC board.
3. Remove the six plastic rivets fixing the front PC board and the key input PC board.

Note: Before disconnecting the flat wires, be sure to unlock the connectors.

■ Disconnecting the Protector PC Board

1. Remove the five foot pieces from the bottom cover.
2. Remove the twenty five screws of the bottom cover, then take out the bottom cover.
3. Disconnect all the flat wires from the connectors on the protector PC board.
4. Remove the four screws fixing the protector PC board. (Figure 2)

Cable
Protect PC board | Power supply PC board

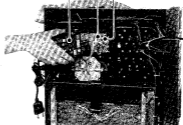

Figure 2.

■ Disconnecting the Power Supply PC Board and Removing the Sub Heat Sink

1. Remove the top cover.
2. Remove the protector PC board.
3. Disconnect the cables fastened round the soldering face of the power supply PC board.
4. Remove the four screws fixing the power supply PC board.
5. Unsolder the sub heat sink from the power supply PC board. (Figure 3)

Sub heat sink

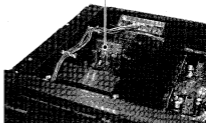

Figure 3.

■ Removing the DAC PC Board

1. Remove the top cover.
2. Remove the bottom cover.
3. Remove the five screws, then release the cable from the four wire bundle bands, and detach the shield cover.

4. Remove the three screws of the rear panel holding the DAC PC board.
5. Disconnect all the flat wires from the connectors on the DAC PC board.
6. Remove the six plastic rivets fixing the DAC PC board to the chassis.

■ Disconnecting the Analog Input PC Board

1. Remove the top cover.
2. Remove the bottom cover.
3. Remove the five screws fixing the pin jacks on the rear panel.
4. Disconnect the flat wires from the connectors on the analog input PC board.
5. Remove the two plastic rivets and detach the analog input PC board from the chassis. (Figure 4)

Note: For reinstalling the board, it seems difficult to insert the plastic rivets into the board as they were. In that case, insert them from the side frame.

■ Disconnecting the Motor Control Input Board

1. Remove the front panel.
2. Detach the bass control and balance control knobs.
3. Remove the nut and screw fixing the shaft of the volume control.
4. Remove two screws fixing the shield plate to the chassis.
5. Remove two plastic rivets fixing the board to the bracket.
6. Disconnect the flat wire from the connector on the motor control input board, and unsolder FW552. (Figure 5)

■ Disconnecting the Power Amplifier PC Board and the Power Transistors

1. Remove the top cover.
2. Remove the bottom cover.
3. Remove the eight screws fixing the power amplifier PC board and the heat sink to the heat sink bracket.
4. Unsolder the eight power transistors.
5. Remove the eight nuts fixing the power transistors by a wrench.

■ Disconnecting the Relay PC Board

1. Remove the top cover.
2. Remove the bottom cover.
3. Remove the twenty three screws and take out the rear panel. (Figure 6)



Figure 4.

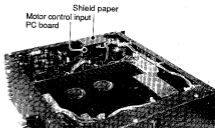

Figure 5.

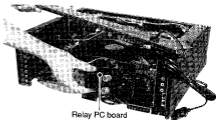

Figure 6.

Adjustment Procedures

■ Power Amplifier Adjustment (Idling Adjustment)

• Idling current adjustment VRs

L-ch ... R461

R-ch ... R462

• Idling current detection voltage check points

L-ch ... TP401 pin ⑤ and pin ④ (Pin ⑤ is the negative side.)

R-ch ... TP401 pin ① and pin ② (Pin ① is the negative side.)

- 1) Rotate idling VRs (R461, R462) fully counterclockwise.
- 2) Set the power switch to ON.
- 3) Adjust R461 and R462 so that each voltage becomes the following value.
 After one minute 5mV
 When stabilized (after 10 minutes) 10mV

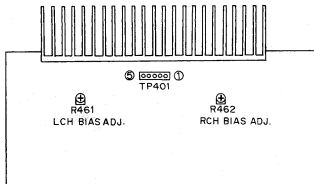

Description of Major ICs

■ TORX172 (J101): Optical Receiving Module

(1) Circuit Configuration

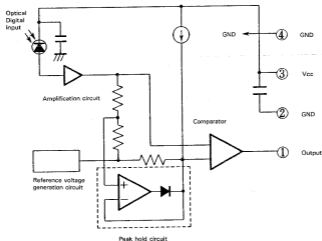

(2) Circuit Description

When an optical is input to the Si-PIN photodiode, a current flows with a sensitivity of 0.3 A/W ($\lambda_p=650$ [nm]) or less. This current is impedance-converted and amplified by the amplifier circuit, and the resulting signal voltage is input to the comparator.

On the other hand, the reference voltage of the comparator is given by the ATC (Automatic Threshold Control) circuit. The ATC circuit is made up of a peak hold circuit which detects the peak value of the input voltage and holds this peak value for a certain period. The period during which the peak value is held is known as the "time constant". It is set to 1–3 μ sec in case of "Toslink".

The signal voltage from the amplifier circuit is divided in two by a resistor and is input to the peak hold circuit. Thus, the comparator performs a comparison between the output voltage of the amplifier circuit and the peak value that is 1/2 the output voltage.

By virtue of this, the comparator output can accurately reproduce the signal transmitted from the optical transmission module of the transmitter at any time, even when the optical input varies.

Moreover, since the reference voltage generation circuit is provided to keep the output voltage at the same level as the voltage output of the amplifier circuit when there is no optical input, so that the reference voltage varies according to the temperature drift in the amplifier circuit to minimize the change in property due to the temperature variation.

In addition, a constant current power supply is provided and the reference voltage of the comparator is set slightly higher than the output voltage of the reference voltage generation circuit so that the transmission is made accurately even under the condition that there is no optical input for a long period.

■ YM3623B (IC106): Digital Audio Interface Receiver

(1) Function

- 1) A PLL circuit is incorporated to synchronize with a digital signal (conforming to the Digital Audio Interface Format) which is transmitted from the outside. Therefore, the sampling frequency is followed up automatically.
- 2) This outputs the audio signal with its MSB first. In synchronism with it, this outputs the timing clock for sampling and holding the D/A output, the L-channel and R-channel signals.
- 3) Since this is provided with pins to output the subcode, it is feasible to pick up the subcode.
- 4) This can output the sampling frequency, the copy enable signal, and the signals indicating the presence/absence of emphasis and the existence/nonexistence of error in the audio signal transmitted.
- 5) When an error is detected in a digital signal conforming to the Digital Audio Interface Format, the previous audio data is output again.

(2) Appearance

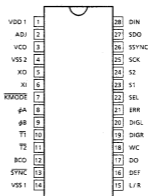

(3) Block Diagram

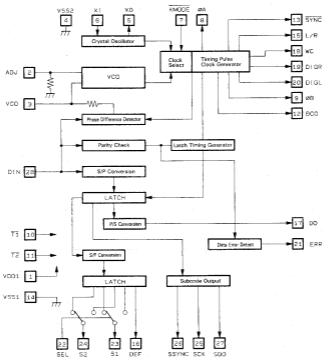

(4) Pin Description

Any pin accompanied by "(PU)" is pulled up internally.

Pin No.	Pin Name	V/O	Function
1	VDD		System power supply (+5V)
2	ADJ	I	VCO oscillation frequency adjustment pin. No. connection
3	VCO	I/O	Externally connected capacitor pin for VCO circuit
4	VSS2		GND pin for VCO circuit. Connected in common with VSS1. They are not common inside the LSI.
5	XO	O	Ceramic oscillator pin (18.00 MHz)
6	XI	I	Ceramic oscillator pin
7	KMODE	I(PU)	H: Activates the PLL circuit when a signal is input to the DIN pin. Operates on the ceramic oscillator when no signal is input to the DIN pin. L: Operates on the ceramic oscillator independent of the state of the DIN pin.
8	ϕA	O	18.00 MHz when the ceramic oscillator is engaged. When the PPL circuit is engaged, the frequency varies according to the data rate of the signal input to the DIN pin. (Approx. 16.9344 MHz when fs=44.1 kHz)
9	ϕB	O	1/3 divided ϕA when the ceramic oscillator is engaged. When the PPL circuit is engaged, the frequency varies according to the data rate of the signal input to the DIN pin. (Approx. 5.6448 MHz when fs=44.1 kHz)
10	T1	I(PU)	Internal circuit check pin
11	T2	I(PU)	Internal circuit check pin
12	BCO	O	Timing clock of signal output from DO pin
13	SYNC	O	Sync signal
14	VSSi	O	System GND
15	L/R	O	H: Indicates that the L-channel data is output from the DO pin. L: Indicates that the R-channel data is output from the DO pin.
16	DEF	O	H: Indicates that the input data has been emphasized. L: Indicates that the input data has not been emphasized.
17	DO	O	18-bit data output
18	WC	O	Indicates that the data is output to the DO pin.
19	DIGR	O	R-channel deglitch signal
20	DIGL	O	L-channel deglitch signal
21	ERR	O	H: Indicates a parity error, or operation on the ceramic oscillator. L: Indicates no error.
22	SEL	I(PU)	Refer to the table below.
23	S1	O	Refer to the table below.
24	S2	O	Refer to the table below.
25	SCK	O	Clock for subcode output
26	SSYNC	O	Signal for subcodes
27	SDD	O	Subcode data output pin
28	DIN	I(PU)	Data input pin

***Concerning S1, S2 and SEL:**

The S1 and S2 pins have a multiplied output function.

The S1 and S2 outputs are changed by switching the SEL pin input.

Input	Output		Output	
	S1	Function	S2	Function
L	L	Copy inhibit	L	CD (other than DAT)
	H	Copy enable	H	DAT
H	L		L	DIN input signal's sampling frequency 44.1 kHz
	L		H	48 kHz
	H		H	32 kHz
	H		L	—

As shown above, the required data is picked up from the input digital signal conforming to the Digital Audio Interface Format and output to the S1 and S2 pins.

■ VC4111 (IC108): K2 Interface and Delay Circuit

(1) Appearance

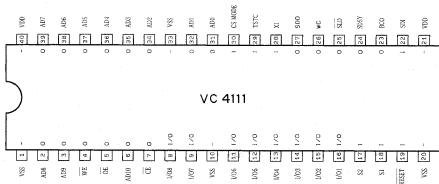

(2) Internal Block Diagram

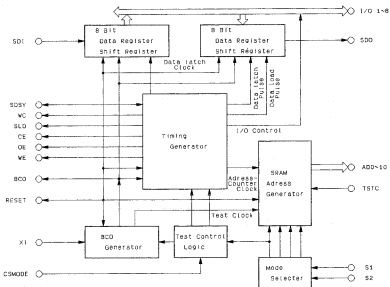

(3) Pin Description

Pin No.	Pin Name	I/O	Function															
1	VSS	—	GND															
2	AD8	O	SRAM memory address signal output pins															
3	AD9	O																
4	WE	O																
5	OE	O	SRAM memory OE signal output pin															
6	AD10	O	SRAM memory address signal output pin															
7	CE	O	SRAM memory CE signal output pin															
8	I/O8	I/O	SRAM memory data signal I/O pin															
9	I/O7	I/O																
10	VSS	—	GND															
11	I/O6	I/O	SRAM memory data signal I/O pins															
12	I/O5	I/O																
13	I/O4	I/O																
14	I/O3	I/O																
15	I/O2	I/O																
16	I/O1	I/O																
17	S2	I	LSI operation mode select input pin															
18	S1	I(CMOS)																
			<table border="1"> <thead> <tr> <th>S2</th> <th>S1</th> <th>Selection</th> </tr> </thead> <tbody> <tr> <td>L</td> <td>L</td> <td>Fs = 44.1 kHz selected</td> </tr> <tr> <td>L</td> <td>H</td> <td>Test mode</td> </tr> <tr> <td>H</td> <td>L</td> <td>Fs = 48 kHz selected</td> </tr> <tr> <td>H</td> <td>H</td> <td>Ps = 32 kHz selected</td> </tr> </tbody> </table>	S2	S1	Selection	L	L	Fs = 44.1 kHz selected	L	H	Test mode	H	L	Fs = 48 kHz selected	H	H	Ps = 32 kHz selected
S2	S1	Selection																
L	L	Fs = 44.1 kHz selected																
L	H	Test mode																
H	L	Fs = 48 kHz selected																
H	H	Ps = 32 kHz selected																
19	RESET	I(CMOS)	LSI reset input pin. The LSI is initialized with RESET "L".															
20	VSS	—	GND															
21	VDD	—	Supply voltage															
22	SDI	I(CMOS)	Serial data input pin. The data synchronized with the fall of the BCO clock is input in the MSB first mode.															
23	BCO	O(CMOS)	Serial data shift clock output pin															
24	SDSY	O(CMOS)	Fs signal (sampling frequency) output pin															
25	SLD	O	At the rise of the WC output signal, outputs an "L" signal with a width of two clock pulses in synchronization with the rise of the BCO clock.															
26	WC	O	Outputs the 2Fs signal synchronized with the Fs signal.															
27	SDO	O	Serial data output pin Outputs the serial data previous 10 msec and read from the SRAM, in the MSB first mode in synchronization with the fall of the BCO clock.															
28	XI	I(CMOS)	Clock input pin															
29	TSTC	I(CMOS)	Input pin to select the test status of the address counter in the LSI when the test mode is engaged.															
30	CS MODE	I(CMOS)	Input pin to select the LSI operating condition.															
31	AD0	O	SRAM memory address signal output pins															
32	AD1	O																
33	VSS	—		GND														
34	AD2	O																
35	AD3	O																
36	AD4	O																
37	AD5	O																
38	AD6	O																
39	AD7	O	SRAM memory address signal output pins															
40	VDD	—	Supply voltage pin															

■ YM3414 (IC113): Octuple Oversampling (18-bit resolution) · Digital Filter

(1) Appearance

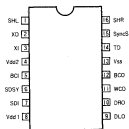

(2) Internal Block Diagram

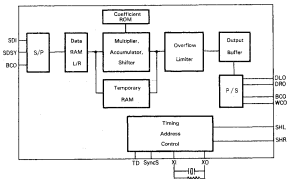

(3) Pin Description

Pin No.	Pin Name	I/O	Function
1	SHL	O	When operating with 1 D/A converter (TD="L"): L-channel deglitcher signal (for quadruple mode) When operating with 2 D/A converters (TD="H"): L/R-channel deglitcher signal (for octuple mode)
2	XO	O	Crystal oscillates between XI-XO.
3	XI	I	16.9344 MHz (External clock can also be input directly.)
4	Vdd2	—	+5V power supply pin for crystal oscillator and deglitcher signal
5	BCI	I	Input data bit clock input pin
6	SDSY	I	Input data L-channel input timing clock input pin
7	SDI	I	Data input pin
8	Vdd1	—	+5V power supply pin for digital signal system
9	DLO	O	When operating with 1 D/A converter (TD="L"): L/R-channel data output pin (for quadruple mode) When operating with 2 D/A converters (TD="H"): L-channel data output pin (for octuple mode)
10	DRO	O	R-channel data output pin
11	WCO	O	Word clock for output data DLO and DRO
12	BCD	O	Output data bit clock
13	Vss	—	GND pin
14	TD	I	1 DAC/2 DACs select pin. 1 DAC (for quadruple mode)="L", 2 DACs (for octuple mode)="H"
15	Syncs	I	Day sync input jitter absorption sync signal (Syncs="H": complete sync input, Syncs="L": SDSY inhibit)
16	SHR	O	R-channel deglitcher signal when operating with 1 DAC

■ μ PD75104CW-150 (IC901): System Control Microcomputer

Pin No.	Symbol	Description	Pin No.	Symbol	Description
1	1	"CompuLink" signal input	64	64	Connected to GND
2	2	Protection circuit operation sensing input	65	65	"CompuLink" signal output
3	3	Remote control signal input	66	66	Volume indicator output
4	4	Power OFF detection	67	67	Volume down control output
5	5	Connected to GND	68	68	Volume up control output
6	6	Connected to GND	69	69	LINE1 (TUNER) input select display output
7	7	Connected to GND	70	70	PHONE input select display output
8	8	Connected to GND	71	71	TAPE/VIDEO input select display output
9	9	Digital (ICDCDV) input select display output	72	72	LINE2 input select display output
10	10	Digital (DNT) input select display output	73	73	CONVY input select display output
11	11	Digital delay ON signal output	74	74	LINE3 (AUX) input select display output
12	12	DAC enabling signal output	75	75	DAT/VIDEO2 input select display output
13	13	Analogue signal muting signal output	76	76	DIGITAL/VIDEO OPT display output
14	14	Strobe output to IC281	77	77	AUX (DIGITAL2) display output
15	15	Connected to GND	78	78	DATA (DIGITAL3) display output
16	16	Data output to IC351	79	79	DAC DIRECT input select display output
17	17	Check output to IC351	80	80	Connected to GND
18	18	Connected to GND	81	81	Check/blew connection pin
19	19	Connected to GND	82	82	Decoder connection pin
20	20	Connected to GND	83	83	Reset signal input
21	21	Digital input from IC106 (YMS6238)	84	84	Power indicator output
22	22	Digital input from IC106 (YMS6238)	85	85	Power indicator output
23	23	Digital input from IC106 (YMS6238)	86	86	Sampling frequency 48 kHz display output
24	24	Key matrix output	87	87	Sampling frequency 44 kHz display output
25	25	Key matrix output	88	88	Sampling frequency 32 kHz display output
26	26	Key matrix output	89	89	Speaker 1 indication, select output
27	27	Key matrix input	90	90	Speaker 2 indication, select output
28	28	Key matrix input	91	91	Digital (source) input select
29	29	Key matrix input	92	92	DST HEAD MONITOR, LBSOURCE selected by DS2
30	30	Key matrix input	93	93	DST HEAD MONITOR, LBSOURCE selected by DS2
31	31	Key matrix input	94	94	DS1 H. AUX. LCD
32	32	Power supply pin	95	95	DS2 H. AUX. LCD

Internal Block Diagrams of Other ICs

■ LC3517BSL-15 (IC109): Static RAM

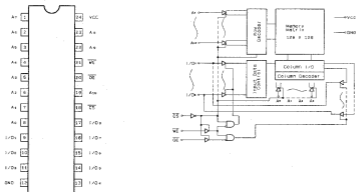

■ PCM56P (IC201, IC202): D/A converters

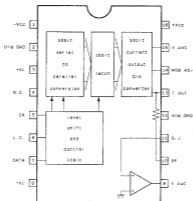

■ SN74LS624N (IC110): Voltage Controlled Oscillator (VCO)

(1) Pin Connections



(2) Block diagram

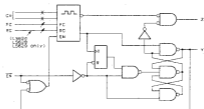

■ LB1639-CV (IC551): Motor Driver

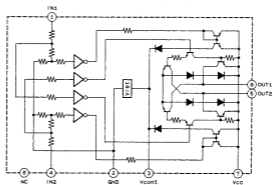

■ VC5022-2 (IC405, IC406): Super-A ICs

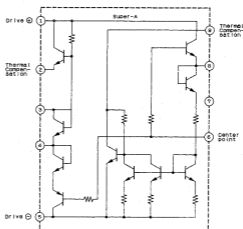

■ μ PC1237HA (IC551): Protector

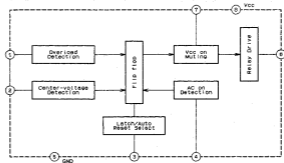

TC74HCU04P (IC101): CMOS Inverter

(1) Pin Connections

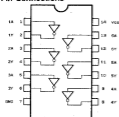

(TOP VIEW)

(2) Block Diagram

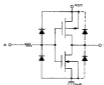

TC74HCOOP (IC102, IC103): CMOS 2-Input NAND Gates

(1) Pin Connections

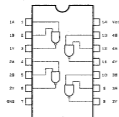

(TOP VIEW)

(2) Block Diagram

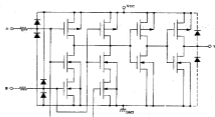

TC74HC86P (IC105): CMOS Exclusive OR Gates

(1) Pin Connections

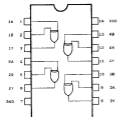

(TOP VIEW)

(2) Block Diagram

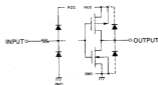

TC74HC74AP (IC114, IC115, IC116, IC261, IC262): CMOS D Type Flip-flops

(1) Pin Connections

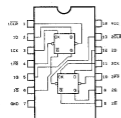

(TOP VIEW)

(2) Truth Table

INPUTS					OUTPUTS		FUNCTION
CLR	PR	D	CK	Q	Q̄		
L	H	X	X	L	H	CLEAR	
H	L	X	X	H	L	PRESET	
L	L	X	X	H	H	—	
H	H	L	↓	L	H	—	
H	H	H	↓	H	L	—	
H	H	X	⌊	Q _n	Q̄ _n	NO CHANGE	

X : Don't care

■ TC74HC123P (IC263): CMOS 2-circuit Monostable · Multivibrator

(1) Pin Connections

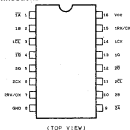

(2) Truth Table

INPUTS			OUTPUTS		NOTE
A	B	CL	Q	\bar{Q}	
\downarrow	H	H			OUTPUT ENABLE
X	L	H	L	H	INHIBIT
H	X	H	L	H	INHIBIT
L	\downarrow	H			OUTPUT ENABLE
L	H	\downarrow			OUTPUT ENABLE
X	X	L	L	H	INHIBIT

X : Don't care

■ TC5081AP (IC104): Phase Detector for PLL Frequency Synthesizer Phase

The phase comparator detects the difference in phase between two input pulses and outputs a negative or positive pulse proportional to this detection to the PD OUT pin.

(1) Pin Connections



(2) Logic Diagram

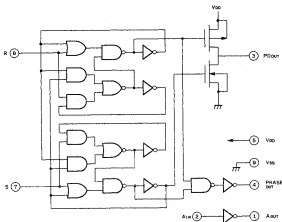

(3) Phase Comparator Timing Chart



MEMO

MEMO



JVC

VICTOR COMPANY OF JAPAN LIMITED
AUDIO PRODUCTS DIVISION, YAMATO PLANT, 1644, SHIMOTSURUMA, YAMATO-SHI, KANAGAWA-KEN, 242, JAPAN

(No. 20115)



Printed in Japan
8906 (G)

PARTS LIST

Contents

Exploded Views and Parts List.....	2-3
Printed Circuit Board Ass'y and Parts List.....	2-7
■ ENP-014 □ Digital & Power PC Board Ass'y.....	2-7
■ ENE-051 □ Equalizer & Microcomputer PC Board Ass'y.....	2-11
■ END-056 □ Power Primary PC Board Ass'y.....	2-14
■ ENH-120 □ Power Amplifier PC Board Ass'y.....	2-15
Packing Materials and Part Numbers.....	2-19
Accessories List.....	2-20

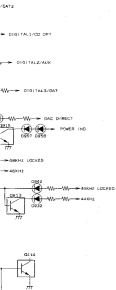

Circuit



Connection Diagram

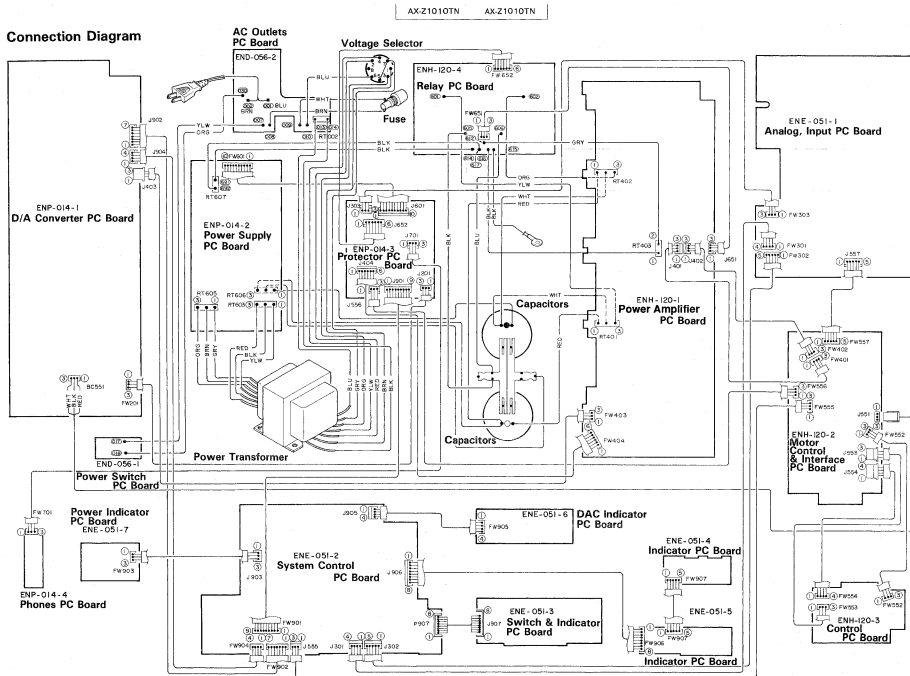

Printed Circuit Board A'ssay

■ Font & Analog Input PC Board (ENE-051)

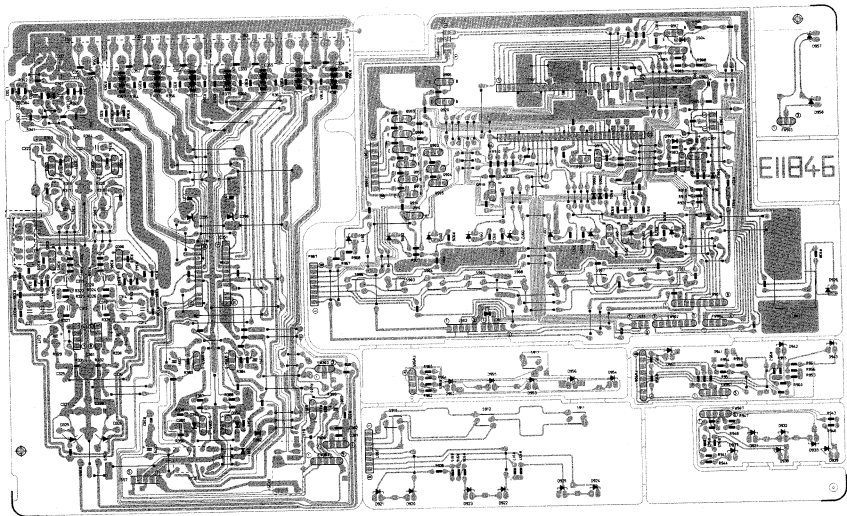

■ Power Switch & AC Outlets PC Board (END-056)

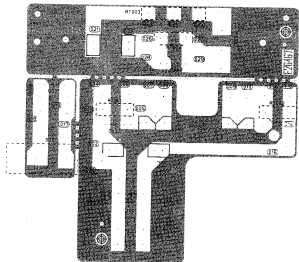

■ Power Amplifier PC Board (ENH-120)

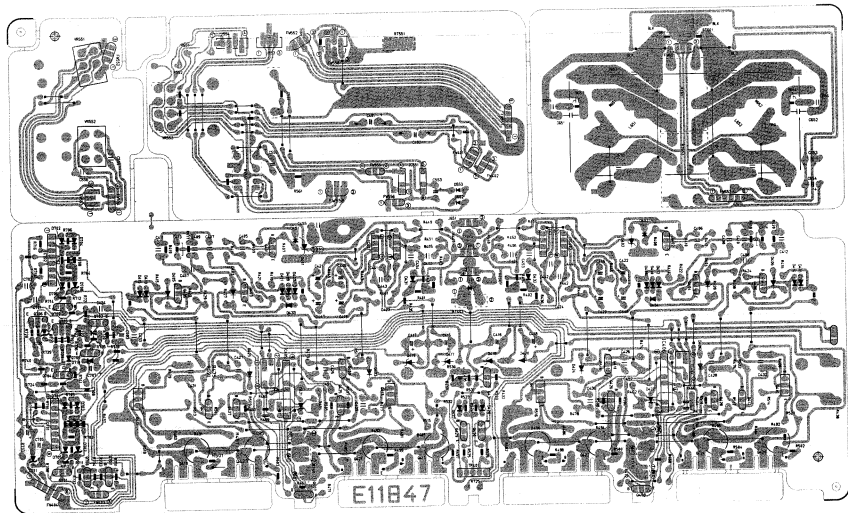

■ DAC & Power Supply PC Board (ENP-014)

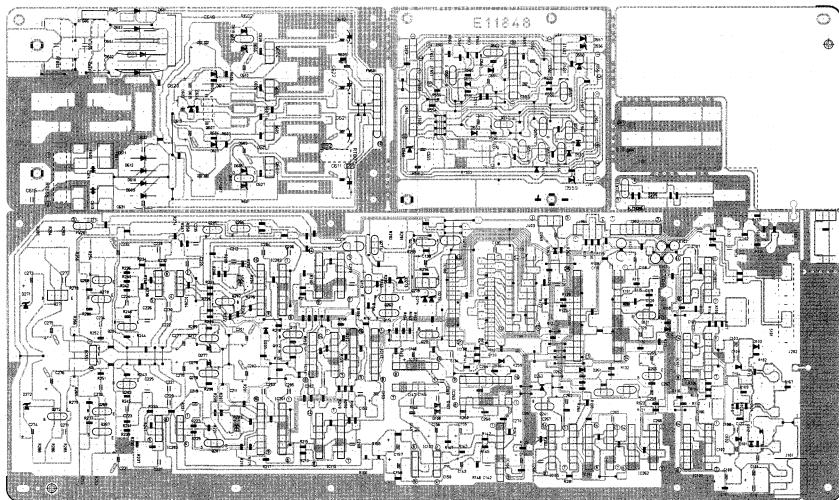

Exploded Views and Parts List

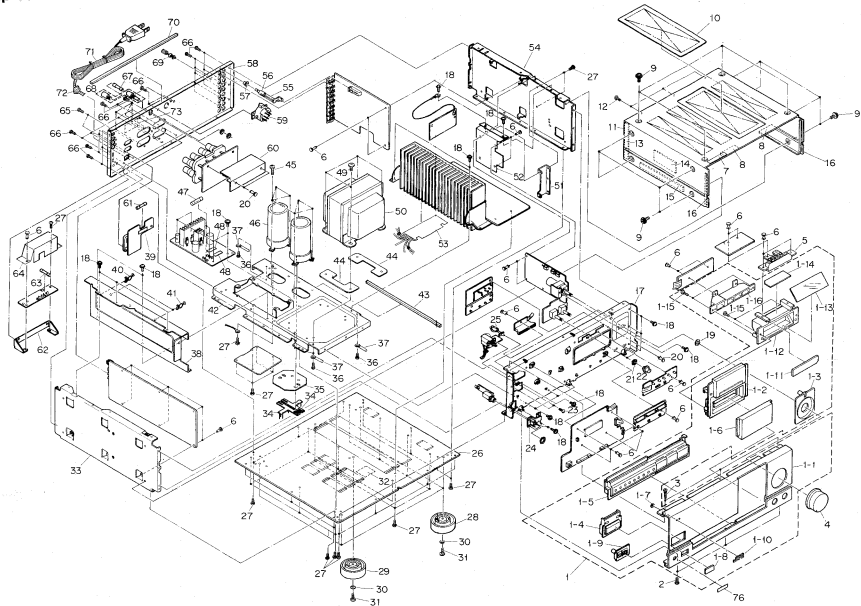

■ Parts List

△	Item	Part Number	Part Name	Q'ty	Description	Areas
	1	EFP-AXZ1010TNE	Front Panel Assy	1		
	1-1	E11839-002	Front Panel	1		
	1-2	E26167-002	Front Escutcheon Assy	1		
	1-3	E304949-004	Knob Ring	1		
	1-4	E305684-003	Push Button Assy	1		
	1-5	E305689-002	Push Button Assy	1		
	1-6	E305730-002	Window Screen	1		
	1-7	E60912-003	Speed Nut	1		
	1-8	E75006-001	Plate	1		
	1-9	E75007-001	Remote Control Escutcheon	1		
	1.10	PQ42376-1-3	JVC Mark	1		
	1.11	E75013-001	Plate	1		
	1.12	E26169-001	Back Cover	1		
	1.13	E75011-001	Plate	1		
	1.14	E75014-001	Plate	1		
	1.15	S85F3008CC	Screw	4		
	1	E30607-001	LED Holder	1		
	2	S05S3008MCP	Screw	3		
	3	E66052-006	Special Screw	3		
	4	E305699-002	Volume Knob	1		
	5	E305698-002	LED Holder	1		
	6	E48729-008	Plastic Rivet	25		
	7	E48729-008	Plastic Rivet	28		
	7	E67000-005	Caution Label	1		
	8	EX0100040N60502	Spacer	2		
	9	E61660-004	Special Screw	12		
	10	E306233-001	Protect Sheet	1		
	11	E26173-004	Metal Cover	1		
	12	E26173-005	Sheet	1		
	12	S85S3008MCP	Screw	3		
	13	EX0130004R20510	Spacer	2		
	14	EX0075040N40502	Spacer	2		
	15	EX0150010R30510	Spacer	2		
	16	E75185-001	Sheet	1		
	17	E11841-002	Front Bracket	1		
	18	G85S3008CC	Screw	27		
	19	E71862-003	Volume Nut	2		
	20	E48729-007	Volume Nut	2		
	21	E71862-001	Volume Nut	2		
	22	E75016-003	Knob	2		
	23	S85T3006CC	Screw	2		
	24	E75017-001	Headphone Bracket	1		
	25	E305946-001	Wire Clamp	1		
	26	E11538-004	Bottom Cover	1		
	27	S85G3008CC	Screw	28		
	28	S85S3008CC	Screw	29		
	28	E75018-005	Foot Assy	4		
	29	E75018-006	Foot Assy	4		
	30	WNS4400CC	Washer	5		
	31	E61661-005	Special Screw	5		
	32	E70781-001	Caution Label	1		
	33	E70115-002	Caution Label	1		
	34	E11537-003	Frame	1		
	35	E73690-002	Earth Plate	2		
	35	E75065-003	Sheet	1		
	36	S85T3006M	Screw	4		
	37	E50870-005	Wire Clamp	1		
	38	E26172-003	Shield Cover	1		
	39	E61380-022	Fuse Label	1		
	40	QHW2052-001	Wire Clamp	1		

△ Safety Parts

△	Item	Part Number	Part Name	Q'ty	Description	Areas
	41	QHW2115-001	Wire Clamp	2		
	42	E11840-003	Trans Base	1		
	43	EX0270005N60502	Felt Spacer	1		
	44	E75097-003	Trans Sheet	2		
	45	S05T4010CC	Screw	6		
	46	EEY6302-189	Electrolytic Capacitor	2		
	47	QMF5101-1R255	Fuse	2		
	47	QMF51E2-1R25J1	Fuse	2		
	47	QMF51E2-1R2J1B5	Fuse	2		
	48	E61380-029	Caution Label	2		
	49	E63389-006	Special Screw	4		
	50	E1P1300-051A	Power Transformer	1		
	50	E1P1300-05FA	Power Transformer	1		
	50	E1P1300-05EA	Power Transformer	1		
	50	E1P1300-05EAB5	Power Transformer	1		
	51	E75020-001	Circuit Board Bracket	1		
	52	E30642-001	Shield Plate	1		
	53	E75166-001	Shield Plate Assy	1		
	54	E11537-004	Frame	1		
	55	E69317-001	Push Shaft	1		
	56	E66226-001	Push Shaft	1		
	57	E60755-002	Push Knob	1		
	58	E26170-002	Rear Panel	1		
	58	E26170-003	Rear Panel	1		
	58	E26170-004	Rear Panel	1		
	59	E303260-199	Rating Label	1		
	59	QSR00B5-009	Voltage Selector	1		
	60	E75478-001	Circuit Board Cover	1		
	61	QMF51R11-100	Fuse	1		
	62	E71074-002	Bracket	1		
	63	QMF51E2-5R011	Fuse	1		
	64	QMF51E2-5R011B5	Fuse	1		
	66	E72922-004	Primary Cover	2		
	65	E74304-002	Special Screw	2		
	66	E73273-003	Special Screw	23		
	67	E73273-003	Special Screw	25		
	67	QMF51E2-5R011	Fuse	1		
	68	QMG0201-003	Fuse Holder	1		
	69	E70078-001	GND Terminal	1		
	70	EX0300010N40502	Spacer	1		
	71	QMP1480-200H	Power Cord	1		
	71	QMP7520-200	Power Cord	1		
	71	QMP3900-200	Power Cord	1		
	71	QMP2560-244	Power Cord	1		
	71	QMP39A0-200	Power Cord	1		
	72	QMP9017-00B85	Power Cord	1		
	72	QHS3771-108	Cord Stopper	1		
	73	QHS3771-108B5	Cord Stopper	1		
	73	E67199-001	Caution Label	1		
	73	E65507-001	Caution Label	1		
	74	E73684-002	Wire Cover	1		
	75	EW4690-36RL2	Para Wire	2		
	76	E49267-001	Origin Marking Label	1		

△ Safety Parts

The Marks for Designated Areas

J	-----the U.S.A.	G	-----West Germany
C	-----Canada	BS	-----the U.K.
A	-----Australia	U	-----Other Countries
E,EF	-----Continental Europe		

No mark indicates all areas.

Printed Circuit Board Ass'y and Parts List

■ ENP-014 □ Digital & Power PC Board Ass'y

Note: ENP-014 □ varies according to the areas employed. See note (1) when placing an order.

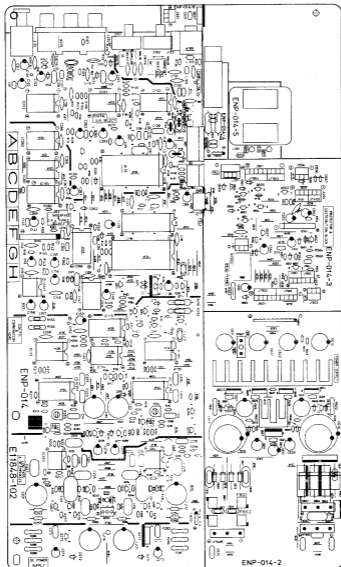

Note (1)

PC Board Ass'y	Designated Areas
ENP-014 [B]	the U.S.A., Canada
ENP-014 [C]	Other Countries
ENP-014 [D]	Australia, Continental Europe, the U.K.
ENP-014 [E]	West Germany

Transistors

ITEM	PART NUMBER	DESCRIPTION	AREA	MAKER	
Q101	DTC144ES	SILICON ROHM			
Q111	2SA1029(C,D)	SILICON HITACHI			
Q112	2SC335(C)	SILICON HITACHI			
Q113	2SA944A(B,S)	SILICON MATSUSHITA			
Q114	DTC114YS	SILICON ROHM			
Q201	2SK170(F)	F.E.T. TOSHIBA			
Q202	2SK170(V)	F.E.T. TOSHIBA			
Q203	2SC306B	SILICON SANYO			
Q204	2SC306B	SILICON SANYO			
Q205	DTA114YS	SILICON ROHM			
Q241	2SC45B(C,S)	SILICON HITACHI			
Q262	DTC114YS	SILICON ROHM			
Q264	DTC114YS	SILICON ROHM			
Q265	2SC4485(R,S)	SILICON MATSUSHITA			
Q266	DTA114YS	SILICON ROHM			
Q267	2SC306B	SILICON SANYO			
Q268	2SC306B	SILICON SANYO			
Q269	2SC306B	SILICON SANYO			
Q270	2SC306B	SILICON SANYO			
Q271	2SD3274(R,S)	SILICON SANYO			
Q272	2SC2060(G,R)	SILICON ROHM			
Q273	2SA934(G,R)	SILICON ROHM			
Q275	2SA1015(Y,G)	SILICON TOSHIBA			
Q275	2SD1271(R,S)	SILICON SANYO			
Q275	2SD1271(R,S)	SILICON SANYO			
Q275	2SD1271(R,S)	SILICON SANYO			
Q277	2SC2060(G,R)	SILICON ROHM			
Q278	2SA1015(Y,G)	SILICON TOSHIBA			
Q551	DTA114YS	SILICON ROHM			
Q552	DTC114YS	SILICON ROHM			
Q553	DTA114YS	SILICON ROHM			
Q554	DTA114YS	SILICON ROHM			
Q555	DTC114YS	SILICON ROHM			
Q556	DTC114YS	SILICON ROHM			
Q557	DTC114YS	SILICON ROHM			
Q601	2SK244(C,F)	F.E.T. TOSHIBA			
Q602	2SK244(F)	F.E.T. TOSHIBA			
Q603	2SD2045(F,G)	SILICON ROHM			
Q604	2SD1287(F,G)	SILICON ROHM			
Q605	2SD2041(F,G)	SILICON ROHM			
Q606	2SD1287(F,G)	SILICON ROHM			
Q607	2SD1944(L,K)	SILICON ROHM			

I.C.s

ITEM	PART NUMBER	DESCRIPTION	AREA	MAKER	
IC101	TC74HC00AP	I.C.		TOSHIBA	
IC102	TC74HC00AP	I.C.		TOSHIBA	
IC103	TC74HC00AP	I.C.		TOSHIBA	
IC104	TC5081AP	I.C.		TOSHIBA	
IC105	TC74HC00AP	I.C.		TOSHIBA	
IC106	YM35023B	I.C.		YAMAHA	
IC107	MJM5400D	I.C.		DAIICHI	
IC108	VC4111	I.C.		MATSUSHITA	
IC109	LC3517BSL-15	I.C.		SANYO	
IC110	5M7615624M	I.C.		MATSUBU	
IC113	7F3514	I.C.		YAMAHA	
IC114	TC74HC74AP	I.C.		TOSHIBA	
IC115	TC74HC74AP	I.C.		TOSHIBA	
IC116	TC74HC74AP	I.C.		TOSHIBA	
IC201	PCMS5P	I.C.		NIDHARBU	
IC202	PCMS5P	I.C.		NIDHARBU	
IC203	NM3532D	I.C.		DAIICHI	
IC204	NM3532D	I.C.		DAIICHI	
IC265	TC74HC74AP	I.C.		TOSHIBA	
IC262	TC74HC74AP	I.C.		TOSHIBA	
IC263	TC74HC123P	I.C.		TOSHIBA	
IC255	UPC1237HA	I.C.		NEC	

Diodes

ITEM	PART NUMBER	DESCRIPTION	AREA	MAKER	
D101	1SS133	SILICON ROHM			
D102	1SS133	SILICON ROHM			
D103	1SS133	SILICON ROHM			
D104	1SS133	SILICON ROHM			
D106	1SS133	SILICON ROHM			
D107	1SS133	SILICON ROHM			
D108	1SS133	SILICON ROHM			
D205	MAT900	ZENER MATSUSHITA			
D261	1SS133	SILICON ROHM			
D262	1SS133	SILICON ROHM			
D263	1SS133	SILICON ROHM			
D271	RD9-1J5B3	ZENER NEC			
D272	RD9-1J5B3	ZENER NEC			
D273	MT23.3JB	ZENER ROHM			
D275	MT24.7JB	ZENER ROHM			
D277	RD5-6J5B3	ZENER NEC			
D278	RD5-6J5B3	ZENER NEC			
D551	1SS133	SILICON ROHM			
D552	1SS133	SILICON ROHM			
D553	1SS133	SILICON ROHM			
D554	1SS133	SILICON ROHM			
D555	1SS133	SILICON ROHM			
D556	MT220JC	ZENER ROHM			
D557	MT220JC	ZENER ROHM			
D558	MT27.5JC	ZENER ROHM			
D559	MT13JC	ZENER ROHM			
D601	300P25FC	SILICON NIDHARBU			
D602	300P25FC	SILICON NIDHARBU			
D603	300P25FC	SILICON NIDHARBU			
D604	300P25FC	SILICON NIDHARBU			
D605	RD1J5B3	ZENER NEC			
D606	RD1J5B3	ZENER NEC			
D609	20E2FA-5	DIODE NIDHARBU			
D610	20E2FA-5	DIODE NIDHARBU			
D611	20E2FA-5	DIODE NIDHARBU			
D612	20E2FA-5	DIODE NIDHARBU			
D613	RD1J5B3	ZENER NEC			
D614	RD1J5B3	ZENER NEC			
D615	MT24.8JC	ZENER ROHM			
D616	MT10JC	ZENER ROHM			

Δ: SAFETY PARTS

Capacitors

ITEM	PART NUMBER	DESCRIPTION	AREA	MAKER	
C100	GETB1M-106	10MF 50V ELECTRO			
C101	GETB1M-107	100MF 25V ELECTRO			
C102	GETB1M-474	47MF 25V ELECTRO			
C103	GETB1M-474	47MF 25V ELECTRO			
C104	CC02005-155	1.5MF 25V CERAMIC			
C105	CC021E8-473	0.047MF 25V CERAMIC			
C106	CC021E8-473	0.047MF 25V CERAMIC			
C107	CC021E8-473	0.047MF 25V CERAMIC			
C108	0FV81HJ-103	0.01MF 50V T.FILM			
C109	0FV81HJ-103	0.01MF 50V T.FILM			
C110	CC02105-155	1.5MF 25V CERAMIC			
C111	CC021E8-473	0.047MF 25V CERAMIC			
C112	CC02005-155	1.5MF 25V CERAMIC			
C113	CC02005-155	1.5MF 25V CERAMIC			
C115	GETB1M-107	100MF 25V ELECTRO			
C116	CC021E8-473	0.047MF 25V CERAMIC			
C118	CC021HJ-471	47PF 50V CERAMIC			
C119	CC030UJ-220	22PF 50V CERAMIC			
C120	CC030UJ-220	22PF 50V CERAMIC			
C121	CC021HJ-221	220PF 50V CERAMIC			
C122	CC021HJ-221	220PF 50V CERAMIC			
C124	0FV81M-223	220PF 50V CERAMIC			
C127	CC030UJ-220	22PF 50V CERAMIC			
C128	0FV81HJ-822	8200PF 50V MYLAR			
C129	0FV81M-225	2.2MF 50V ELECTRO			
C132	CC021HJ-221	220PF 50V CERAMIC			
C136	CC021E8-473	0.047MF 25V CERAMIC			
C136	CC021E8-473	0.047MF 25V CERAMIC			
C138	GETB1M-107	100MF 25V ELECTRO			
C139	0FV81M-226	22MF 50V ELECTRO			
C140	0FV81M-223	220PF 50V CERAMIC			
C141	GETB1M-107	100MF 25V ELECTRO			
C142	CC021E8-223	0.022MF 25V CERAMIC			
C143	GETB1M-107	100MF 25V ELECTRO			
C145	CC031HJ-331	330PF 50V CERAMIC			
C146	0FV81HJ-393	390PF 50V MYLAR			
C147	CC021HJ-270	27PF 50V CERAMIC			
C148	GETB1M-107	100MF 25V ELECTRO			
C152	CC021E8-473	0.047MF 25V CERAMIC			
C153	GETB1M-107	100MF 25V ELECTRO			

Capacitors

ITEM	PART NUMBER	DESCRIPTION	AREA
C135	GEF81EM-107	1000PF 25V ELECTRO	
C136	GEF81EM-107	1000PF 25V ELECTRO	
C137	GEF81EM-474	4.7MF 25V ELECTRO	
C138	GEF81EM-476	4.7MF 25V ELECTRO	
C139	GCC21EM-473	0.047MF 25V CERAMIC	
C201	EEZ2503-107	1000PF ELECTRO	
C202	EEZ2503-107	1000PF ELECTRO	
C203	EFZ0101-2235	0.022MF M.MYLAR	
C204	EFZ0101-2235	0.022MF M.MYLAR	
C205	EFZ0101-2235	0.022MF M.MYLAR	
C206	EFZ0101-2235	0.022MF M.MYLAR	
C207	GCC21EM-473	0.047MF 25V CERAMIC	
C208	GCC21EM-473	0.047MF 25V CERAMIC	
C209	GCC21EM-473	0.047MF 25V CERAMIC	
C211	GFV81NJ-103	0.01MF 50V T.FILM	
C212	GFV81NJ-103	0.01MF 50V T.FILM	
C219	EPF0010-2710	P.P. CAPACI	
C220	EPF0010-2715	P.P. CAPACI	
C221	EFZ0101-1035	0.01MF M.MYLAR	
C222	EFZ0101-1035	0.01MF M.MYLAR	
C223	GFPE1HG-683	0.068MF 50V POLY	
C224	GFPE1HG-683	0.068MF 50V POLY	
C225	GFPE1HG-202	0.0002PF 50V POLY	
C226	GFPE1HG-202	0.0002PF 50V POLY	
C227	GFPE1HG-113	0.011MF 50V POLY	
C228	GFPE1HG-113	0.011MF 50V POLY	
C229	EFZ0101-1035	0.01MF M.MYLAR	
C230	EFZ0101-1035	0.01MF M.MYLAR	
C231	EEZ5006-107	1000PF ELECTRO	
C232	EEZ5006-107	1000PF ELECTRO	
C234	EFZ0101-8225	82000PF M.MYLAR	
C235	EFZ0101-8225	82000PF M.MYLAR	
C236	GFNB1NJ-103	0.01MF 50V MYLAR	
C239	GEF81EM-225	2.2MF 50V ELECTRO	
C240	GC881HK-121	120PF 50V CERAMIC	
C241	GCC21EM-223	0.022MF 25V CERAMIC	
C242	GEF81EM-474	4.7MF 50V ELECTRO	
C243	GCV81CM-103	0.01MF 50V CERAMIC	
C244	GC881HK-331	330PF 50V CERAMIC	
C245	GCC21EM-473	0.047MF 25V CERAMIC	
C246	GCC21EM-473	0.047MF 25V CERAMIC	
C247	GCC21EM-473	0.047MF 25V CERAMIC	
C248	GCC21EM-103	0.01MF 25V CERAMIC	
C249	GTB1EM-103	10MF 50V ELECTRO	
C270	GCCT1EM-225	2.2MF 50V CERAMIC	
C271	GFV81NJ-73	0.047MF 50V T.FILM	
C272	GFV81NJ-473	0.047MF 50V T.FILM	
C273	EEZ2505-476	4.7MF ELECTRO	
C274	EEZ2505-476	4.7MF ELECTRO	
C275	EEZ2503-107	1000PF ELECTRO	
C276	EEZ2503-107	1000PF ELECTRO	
C277	EEZ5009-107	1000PF ELECTRO	
C278	EEZ5009-107	1000PF ELECTRO	
C551	GEY81EM-475	4.7MF 50V ELECTRO	
C552	GEY81EM-226	22MF 16V ELECTRO	
C553	GEY81EM-227	22MF 10V ELECTRO	
C554	GEY81EM-105	1MF 50V ELECTRO	
C555	GEY81EM-105	1MF 50V ELECTRO	
C557	GC881HK-221	220PF 50V CERAMIC	E
C558	GC881HK-221	220PF 50V CERAMIC	E
C559	GFV81NJ-103	0.01MF 50V T.FILM	E
C561	GCC21EM-473	0.047MF 25V CERAMIC	D
C601	EFZ0096-103	0.01MF M.MYLAR	B
C601	EFZ0096-103	0.01MF M.MYLAR	B
C601	EFZ0096-473	0.047MF M.MYLAR	C
C609	EEZ2503-476	4.7MF ELECTRO	
C610	EEZ2503-476	4.7MF ELECTRO	
C611	EEZ2503-107	1000PF ELECTRO	
C612	EEZ2503-107	1000PF ELECTRO	
C613	GC881E2-223	0.022MF 25V CERAMIC	B
C613	GC881E2-223	0.022MF 25V CERAMIC	B
C613	GC881E2-223	0.022MF 25V CERAMIC	D
C613	GFV81NJ-104	0.1MF 50V T.FILM	E
C614	GC881E2-223	0.022MF 25V CERAMIC	B
C614	GC881E2-223	0.022MF 25V CERAMIC	D
C614	GFV81NJ-104	0.1MF 50V T.FILM	E
C615	GFV81NJ-104	0.1MF 50V T.FILM	B
C615	GFV81NJ-223	0.022MF 50V T.FILM	C
C615	GFV81NJ-223	0.022MF 50V T.FILM	D
C617	EEZ2503-228	2200PF ELECTRO	
C618	EEZ2503-228	2200PF ELECTRO	
C619	GEY81EM-107	1000PF 16V ELECTRO	
C620	GEY81EM-107	1000PF 16V ELECTRO	
C621	EEZ2505-227	220MF ELECTRO	
C622	EEZ2505-227	220MF ELECTRO	
C623	GEY81EM-474	4.7MF 10V ELECTRO	
C624	GC881HK-102	10000PF 50V CERAMIC	

Capacitors

ITEM	PART NUMBER	DESCRIPTION	AREA
C625	GC881HK-102	10000PF 50V CERAMIC	
C626	GC881HK-102	10000PF 50V CERAMIC	
C627	GC881HK-102	10000PF 50V CERAMIC	
C628	GC881HK-102	10000PF 50V CERAMIC	
C631	EFZ0096-223	0.022MF M.MYLAR	
C632	EFZ0096-223	0.022MF M.MYLAR	

Δ : SAFETY PARTS

Resistors

ITEM	PART NUMBER	DESCRIPTION	AREA
R101	8RD167J-750	75 1/6W CARBON	
R102	8RD167J-750	75 1/6W CARBON	
R103	8RD167J-100	10 1/6W CARBON	
R104	8RD167J-103	10K 1/6W CARBON	
R105	8RD167J-103	10K 1/6W CARBON	
R106	8RD167J-222	2.2K 1/6W CARBON	
R107	8RD167J-222	2.2K 1/6W CARBON	
R108	8RD167J-472	4.7K 1/6W CARBON	
R109	8RD167J-820	82 1/6W CARBON	
R110	8RD167J-301	30 1/6W CARBON	
R111	8RD167J-271	270 1/6W CARBON	
R112	8RD167J-471	470 1/6W CARBON	
R113	8RD167J-183	18K 1/6W CARBON	
R114	8RD167J-183	18K 1/6W CARBON	
R115	8RD167J-105	1M 1/6W CARBON	
R116	8RD167J-103	10K 1/6W CARBON	
R117	8RD167J-103	10K 1/6W CARBON	
R118	8RD167J-471	470 1/6W CARBON	
R119	8RD167J-101	100 1/6W CARBON	
R120	8RD167J-105	1M 1/6W CARBON	
R121	8RD167J-471	470 1/6W CARBON	
R122	8RD167J-101	100 1/6W CARBON	
R123	8RD167J-101	100 1/6W CARBON	
R125	8RD167J-101	100 1/6W CARBON	
R126	8RD167J-101	100 1/6W CARBON	
R127	8RD167J-471	470 1/6W CARBON	
R128	8RD167J-101	100 1/6W CARBON	
R129	8RD167J-101	100 1/6W CARBON	
R130	8RD167J-471	470 1/6W CARBON	
R131	8RD167J-471	470 1/6W CARBON	
R132	8RD167J-472	4.7K 1/6W CARBON	
R133	8RD167J-102	1K 1/6W CARBON	
R134	8RD167J-221	22 1/6W CARBON	
R139	8RD167J-103	10K 1/6W CARBON	
R141	8RD167J-103	10K 1/6W CARBON	
R142	8RD167J-101	100 1/6W CARBON	
R143	8RD167J-392	3.9K 1/6W CARBON	
R145	8RD167J-103	10K 1/6W CARBON	
R146	8RD167J-103	10K 1/6W CARBON	
R147	8RD167J-152	1.5K 1/6W CARBON	
R148	8RD167J-222	2.2K 1/6W CARBON	
R149	8RD167J-101	100 1/6W CARBON	
R151	8RD167J-472	4.7K 1/6W CARBON	
R152	8RD167J-101	100 1/6W CARBON	
R154	8RD167J-102	1K 1/6W CARBON	
R155	8RD167J-103	10K 1/6W CARBON	
R156	8RD167J-152	1.5K 1/6W CARBON	
R158	8RD167J-101	100 1/6W CARBON	
R159	8RD167J-101	100 1/6W CARBON	
R160	8RD167J-101	100 1/6W CARBON	
R161	8RD167J-101	100 1/6W CARBON	
R162	8RD167J-221	220 1/6W CARBON	
R163	8RD167J-221	220 1/6W CARBON	
R164	8RD167J-221	220 1/6W CARBON	
R165	8RD167J-471	470 1/6W CARBON	
R166	8RD167J-471	470 1/6W CARBON	
R167	8RD167J-101	100 1/6W CARBON	
R201	8RD167J-224	220K 1/6W CARBON	
R202	8RD167J-224	220K 1/6W CARBON	
R203	GVZ3510-104	100K 0.1W VARIABLE	
R204	GVZ3510-104	100K 0.1W VARIABLE	
R205	8RD167J-105	1M 1/6W CARBON	
R206	8RD167J-105	1M 1/6W CARBON	
R207	8RD167J-474	470K 1/6W CARBON	
R208	8RD167J-474	470K 1/6W CARBON	
R209	8RD167J-472	4.7K 1/6W CARBON	
R210	8RD167J-101	100 1/6W CARBON	
R213	8RD167J-114	110K 1/6W CARBON	
R214	8RD167J-114	110K 1/6W CARBON	
R215	8RD167J-224	220K 1/6W CARBON	
R216	8RD167J-224	220K 1/6W CARBON	
R217	8RD167J-330	33 1/6W CARBON	
R219	8RD167J-104	100K 1/6W CARBON	
R220	8RD167J-104	100K 1/6W CARBON	

Δ : SAFETY PARTS

Resistors

Δ	ITEM	PART NUMBER	DESCRIPTION	AREA
	R220	QRD167J-272	2.7K 1/6W CARBON	
	R222	QRD167J-272	2.7K 1/6W CARBON	
	R223	QRD167J-152	1.5K 1/6W CARBON	
	R224	QRD167J-152	1.5K 1/6W CARBON	
	R225	QRD167J-471	470 1/6W CARBON	
	R226	QRD167J-471	470 1/6W CARBON	
	R231	QRD167J-471	470 1/6W CARBON	
	R232	R77-67J-671	470 1/6W CARBON	
	R233	QRD167J-300	300 1/6W CARBON	
	R234	QRD167J-300	300 1/6W CARBON	
	R235	QRD167J-621	620 1/6W CARBON	
	R236	QRD167J-621	620 1/6W CARBON	
	R237	QRD167J-681	680 1/6W CARBON	
	R238	QRD167J-681	680 1/6W CARBON	
	R239	QRD167J-221	220 1/6W CARBON	
	R240	QRD167J-221	220 1/6W CARBON	
	R241	QRD167J-150	15 1/6W CARBON	
	R242	QRD167J-150	15 1/6W CARBON	
	R243	QRD167J-182	1.8K 1/6W CARBON	
	R244	QRD167J-182	1.8K 1/6W CARBON	
	R246	QRD167J-103	1K 1/6W CARBON	
	R247	QRD167J-103	1K 1/6W CARBON	
	R248	QRD167J-101	100 1/6W CARBON	
	R249	QRD167J-101	100 1/6W CARBON	
	R251	QRD167J-101	100 1/6W CARBON	
	R251	QRD167J-224	220K 1/6W CARBON	
	R252	QRD167J-224	220K 1/6W CARBON	
	R253	QRD167J-1515	150 1/6W CARBON	
	R254	QRD167J-1515	150 1/6W CARBON	
	R255	QRD167J-1515	150 1/6W CARBON	
	R256	QRD167J-1515	150 1/6W CARBON	
	R257	QRD167J-104	100K 1/6W CARBON	
	R258	QRD167J-105	10 1/6W CARBON	
	R259	QRD167J-104	100K 1/6W CARBON	
	R260	QRD167J-182	1.8K 1/6W CARBON	
	R261	QRD167J-471	470 1/6W CARBON	
	R264	QRD167J-683	68K 1/6W CARBON	
	R265	QRD167J-1015	10 1/6W CARBON	
	R266	QRD167J-1015	10 1/6W CARBON	
	R267	QRD167J-102	1K 1/6W CARBON	
	R271	QRD167J-473	4.7K 1/6W CARBON	
	R274	QRD167J-104	100K 1/6W CARBON	
	R275	QRD167J-221	220 1/6W CARBON	
	R276	QRD167J-221	220 1/6W CARBON	
	R277	QRD167J-103	10K 1/6W CARBON	
	R278	QRD167J-103	10K 1/6W CARBON	
	R279	QRD167J-103	10K 1/6W CARBON	
	R280	QRD167J-103	10K 1/6W CARBON	
	R281	QRD167J-471	470 1/6W CARBON	
	R282	QRD167J-471	470 1/6W CARBON	
Δ	R283	QRD14CJ-2705	27 1/4W UNF. CARBON B	
Δ	R285	QRZ0077-270	27 1/4W FUSIBLE D	
Δ	R285	QRZ0077-270	27 1/4W FUSIBLE D	
Δ	R283	QRZ0077-270	27 1/4W FUSIBLE E	
Δ	R284	QRZ14CJ-2705	27 1/4W UNF. CARBON B	
Δ	R284	QRZ0077-270	27 1/4W FUSIBLE C	
Δ	R284	QRZ0077-270	27 1/4W FUSIBLE D	
Δ	R285	QRZ14CJ-3305	33 1/4W UNF. CARBON B	
Δ	R285	QRZ0077-330	33 1/4W FUSIBLE C	
Δ	R285	QRZ0077-330	33 1/4W FUSIBLE D	
Δ	R285	QRZ0077-330	33 1/4W FUSIBLE E	
Δ	R286	QRD14CJ-3305	33 1/4W UNF. CARBON B	
Δ	R286	QRZ0077-330	33 1/4W FUSIBLE C	
Δ	R286	QRZ0077-330	33 1/4W FUSIBLE D	
Δ	R287	QRD14CJ-3315	330 1/4W UNF. CARBON B	
Δ	R288	QRD14CJ-3315	330 1/4W UNF. CARBON B	
Δ	R289	QRD167J-561	560 1/6W CARBON	
Δ	R291	QRD125J-470	47 1/2W UNF. CARBON C	
Δ	R291	QRD125J-470	47 1/2W UNF. CARBON D	
Δ	R291	QRD125J-470	47 1/2W UNF. CARBON E	
Δ	R291	QRD14CJ-4705	47 1/4W UNF. CARBON B	
Δ	R292	QRD125J-470	47 1/2W UNF. CARBON C	
Δ	R292	QRD125J-470	47 1/2W UNF. CARBON D	
Δ	R292	QRD125J-470	47 1/2W UNF. CARBON E	
Δ	R292	QRD14CJ-4705	47 1/4W UNF. CARBON B	
Δ	R294	QRD167J-321	320 1/6W CARBON	
Δ	R295	QRD167J-1212	1.2K 1/6W CARBON B	
Δ	R333	QRD167J-473	47K 1/6W CARBON	
Δ	R351	QRD167J-472	4.7K 1/6W CARBON	
Δ	R352	QRD167J-242	2.4K 1/6W CARBON	
Δ	R353	QRD167J-274	270K 1/6W CARBON	
Δ	R354	QRD167J-104	100K 1/6W CARBON	
Δ	R354	QRD167J-623	62K 1/6W CARBON	
Δ	R354	QRD167J-102	1K 1/6W CARBON	
Δ	R357	QRG022J-331A	330 2W D.M.FILM	
Δ	R358	QRG022J-331A	330 2W D.M.FILM	

Δ : SAFETY PARTS

RESISTORS

Δ	ITEM	PART NUMBER	DESCRIPTION	AREA
Δ	R562	QRD14CJ-8205	82 1/4W UNF. CARBON C	
Δ	R562	QRD14CJ-8205	82 1/4W UNF. CARBON D	
Δ	R562	QRD14CJ-8205	82 1/4W UNF. CARBON E	
Δ	R501	QRD14CJ-1005	10 1/4W UNF. CARBON B	
Δ	R601	QRZ0077-100	10 1/4W FUSIBLE C	
Δ	R601	QRZ0077-100	10 1/4W FUSIBLE D	
Δ	R601	QRZ0077-100	10 1/4W FUSIBLE E	
Δ	R602	QRD14CJ-1005	10 1/4W UNF. CARBON C	
Δ	R602	QRZ0077-100	10 1/4W FUSIBLE C	
Δ	R602	QRZ0077-100	10 1/4W FUSIBLE D	
Δ	R602	QRZ0077-100	10 1/4W FUSIBLE E	
Δ	R603	QRD167J-561	560 1/6W CARBON	
Δ	R604	QRD167J-561	560 1/6W CARBON	
Δ	R605	QRD167J-561	560 1/6W CARBON	
Δ	R606	QRD167J-561	560 1/6W CARBON	
Δ	R607	QRD167J-222	2.2K 1/6W CARBON	
Δ	R609	QRD167J-362	3.6K 1/6W CARBON	
Δ	R610	QRD167J-362	3.6K 1/6W CARBON	

Others

Δ	ITEM	PART NUMBER	DESCRIPTION	AREA
		E11848-102	CIRCUIT BOARD	
		E33754-001	TIE BAND	
		E48249-001	SPACER	C
		E48249-001	SPACER	D
		E48249-001	SPACER	E
		E67132-1R25	FUSE LABEL	C
		E67132-1R25	FUSE LABEL	D
		E7094-5-440	HEAT SINK	S
		E73525-001	SCREW	
		E73525-001	SCREW	
		E73525-001	SCREW	
		E75085-001	HEAT SINK	
	F601	EMW7331-002U	FUSE CLIP	
	F601	EMW7331-002	FUSE CLIP	
	F602	EMW7331-002U	FUSE CLIP	
	F602	EMW7331-002	FUSE CLIP	
	J101	TRK172-VA	OPTICAL JACK	
	J102	EMW010-507A	3P PIN JACK	
	J103	MS3501-020	WIRE JACK	
	J201	EMW112-003	CONNECTOR	
	J303	EMW122-003	CONNECTOR	
	J403	EMW112-003R	CONNECTOR	
	J551	MS6640-021	HEADPHONE JACK	
	J552	EMW122-004	CONNECTOR	
	J701	EMW122-005	CONNECTOR	
	J902	EMW112-007R	CONNECTOR	
	J904	EMW112-004R	CONNECTOR	
	K101	EW18101-007	INDUCTOR	
	K103	EW18101-007	INDUCTOR	
	L102	EW44004-540	INDUCTOR	
	L102	EW44004-487	INDUCTOR	
	L103	EW44004-1R0	INDUCTOR	
	S101	EW36A12-201	SLIDE SWITCH	
	S103	EW36A12-201	SLIDE SWITCH	
	W251	IC20018-000R5	RESISTOR	
	W251	EW9313-259	ROCKET WIRE	
	F601	EW338-30KST	FLAT WIRE	
	F601	EW338-13.5T	FLAT WIRE	
	F701	EW338-50.5T	FLAT WIRE	
	U7402	EMW722-005	CONNECTOR	
	U7402	EMW722-003	CONNECTOR	
	U7401	EMW722-005	CONNECTOR	
	U7402	EMW722-005	CONNECTOR	
	U7401	EMW722-003	CONNECTOR	
	U7402	EMW722-003	CONNECTOR	
	U7404	EMW722-005	CONNECTOR	
	LC271	EW6061-222T	SRI FILTER	
	LC272	EW6061-222T	SRI FILTER	
	RT605	E67764-103	WRAPPING TERMINAL	
	RT606	E67764-503	WRAPPING TERMINAL	
	RT607	E67764-102	WRAPPING TERMINAL	
	RY532	ESK312-214	RELAY	

Δ : SAFETY PARTS

■ ENE-051 □ Equalizer & Microcomputer PC Board Ass'y

Note: ENE-051 □ varies according to the areas employed. See note (1) when placing an order.

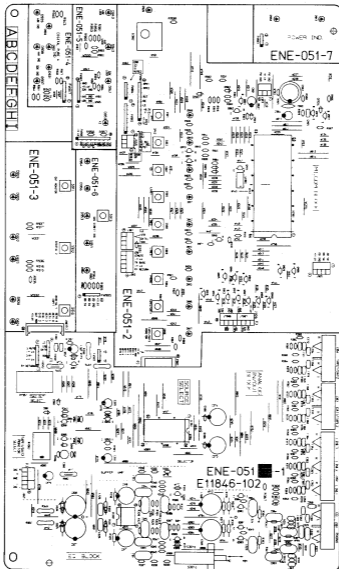

Note (1)

PC Board Ass'y	Designated Areas
ENE-051 [B]	the U.S.A., Canada
ENE-051 [C]	Australia, Continental Europe, the U.K., Other Countries
ENE-051 [D]	West Germany

Transistors

ITEM	PART NUMBER	DESCRIPTION	AREA	
			MAKER	
Q301	25K170(CGR-BL)	F.E.T	MATSUSHITA	
Q302	25K170(CGR-BL)	F.E.T	MATSUSHITA	
Q303	25K170(CGR-BL)	F.E.T	MATSUSHITA	
Q304	25K170(CGR-BL)	F.E.T	MATSUSHITA	
Q305	25C2240(CGR-BL)	SILICON	TOSHIBA	
Q306	25C2240(CGR-BL)	SILICON	TOSHIBA	
Q353	25K246(CGR-BL)	F.E.T	MATSUSHITA	
Q354	25K246(CGR-BL)	F.E.T	MATSUSHITA	
Q355	25K165(L11)	F.E.T	NEC	
Q356	25K165(L11)	F.E.T	NEC	
Q357	DTA114YS	SILICON	ROHM	
Q901	DTC144ES	SILICON	ROHM	
Q902	DTC144ES	SILICON	ROHM	
Q903	DTC114YS	SILICON	ROHM	
Q904	DTC114YS	SILICON	ROHM	
Q905	DTC114YS	SILICON	ROHM	
Q906	DTC114YS	SILICON	ROHM	
Q907	DTC114YS	SILICON	ROHM	
Q908	DTC114YS	SILICON	ROHM	
Q909	DTC114YS	SILICON	ROHM	
Q910	DTC114YS	SILICON	ROHM	
Q911	DTC114YS	SILICON	ROHM	
Q912	DTC114YS	SILICON	ROHM	
Q913	DTC114YS	SILICON	ROHM	
Q914	DTC114YS	SILICON	ROHM	
Q915	DTC114YS	SILICON	ROHM	
Q916	DTC114YS	SILICON	ROHM	
Q917	DTA114YS	SILICON	ROHM	
Q918	DTA114YS	SILICON	ROHM	
Q919	25C16B5(R-S)	SILICON	MATSUSHITA	
Q920	DTC114YS	SILICON	ROHM	

△ : SAFETY PARTS

I.C.s

ITEM	PART NUMBER	DESCRIPTION	AREA	
			MAKER	
IC301	NJM456090	I.C.	DAIICHI	
IC351	TC9164N	I.C.	TOSHIBA	
IC901	UPD73104CW-150	I.C.	NEC	
IC902	A19H302190	I.C.	MATSUSHITA	

△ : SAFETY PARTS

Diodes

ITEM	PART NUMBER	DESCRIPTION	AREA	
			MAKER	
D324	R016/583	ZENER	NEC	
D325	R016/583	ZENER	NEC	
D381	155133	SILICON	ROHM	
D382	155133	SILICON	ROHM	
D391	155133	SILICON	ROHM	
D392	155133	SILICON	ROHM	
D394	155133	SILICON	ROHM	
D395	R016/583	ZENER	NEC	
D906	R016/583	ZENER	NEC	
D901	155133	SILICON	ROHM	
D902	155133	SILICON	ROHM	
D903	155133	SILICON	ROHM	
D904	155133	SILICON	ROHM	
D905	155133	SILICON	ROHM	
D906	155133	SILICON	ROHM	
D911	SLR-34DC3F	L.E.D.	ROHM	
D912	SLR-34DC3F	L.E.D.	ROHM	
D913	SLR-34DC3F	L.E.D.	ROHM	
D914	SLR-34DC3F	L.E.D.	ROHM	
D915	SLR-34DC3F	L.E.D.	ROHM	

Diodes

ITEM	PART NUMBER	DESCRIPTION	AREA	
			MAKER	
D916	SLR-34DC3F	L.E.D.	ROHM	
D917	SLR-34DC3F	L.E.D.	ROHM	
D918	SLR-34DC3F	L.E.D.	ROHM	
D919	SLR-34DC3F	L.E.D.	ROHM	
D920	SLV-31DC3F	L.E.D.	ROHM	
D921	SLV-31DC3F	L.E.D.	ROHM	
D922	SLV-31DC3F	L.E.D.	ROHM	
D923	SLV-31DC3F	L.E.D.	ROHM	
D924	SLV-31DC3F	L.E.D.	ROHM	
D925	SLV-31DC3F	L.E.D.	ROHM	
D926	SLR-34DC3F	L.E.D.	ROHM	
D927	SLV-31DC3F	L.E.D.	ROHM	
D928	SLV-31DC3F	L.E.D.	ROHM	
D929	SLV-31DC3F	L.E.D.	ROHM	
D930	SLV-31DC3F	L.E.D.	ROHM	
D931	SLV-31DC3F	L.E.D.	ROHM	
D932	SLV-31DC3F	L.E.D.	ROHM	
D933	SLV-31DC3F	L.E.D.	ROHM	
D934	SLV-31DC3F	L.E.D.	ROHM	
D935	SLV-31DC3F	L.E.D.	ROHM	
D936	SLV-31DC3F	L.E.D.	ROHM	
D937	SLV-31DC3F	L.E.D.	ROHM	
D938	SLV-31DC3F	L.E.D.	ROHM	
D939	SLV-31DC3F	L.E.D.	ROHM	
D940	SLV-31DC3F	L.E.D.	ROHM	
D941	SLV-31DC3F	L.E.D.	ROHM	
D942	SLV-31DC3F	L.E.D.	ROHM	
D943	SLV-31DC3F	L.E.D.	ROHM	
D944	SLV-31DC3F	L.E.D.	ROHM	
D945	SLV-31DC3F	L.E.D.	ROHM	
D946	SLV-31DC3F	L.E.D.	ROHM	
D947	SLV-31DC3F	L.E.D.	ROHM	
D948	SLV-31DC3F	L.E.D.	ROHM	
D949	SLV-31DC3F	L.E.D.	ROHM	
D950	SLV-31DC3F	L.E.D.	ROHM	
D951	SLV-31DC3F	L.E.D.	ROHM	
D952	SLV-31DC3F	L.E.D.	ROHM	
D953	SLV-31DC3F	L.E.D.	ROHM	
D954	SLV-31DC3F	L.E.D.	ROHM	
D955	SLV-31DC3F	L.E.D.	ROHM	
D956	SLV-31DC3F	L.E.D.	ROHM	
D957	SLV-31DC3F	L.E.D.	ROHM	
D958	SLV-31DC3F	L.E.D.	ROHM	

△ : SAFETY PARTS

Capacitors

ITEM	PART NUMBER	DESCRIPTION	AREA	
			MAKER	
C301	EF2010-2218	220PF	M.MYLAR	0
C302	EF2010-1015	100PF	M.MYLAR	0
C303	EF2010-1015	100PF	M.MYLAR	C
C304	EF2010-2215	220PF	M.MYLAR	0
C305	EF2010-1025	1000PF	M.MYLAR	0
C306	EF2010-1025	1000PF	M.MYLAR	C
C307	EF2010-2218	220PF	M.MYLAR	0
C308	EF2010-1025	1000PF	M.MYLAR	0
C309	EF2010-1025	1000PF	M.MYLAR	C
C30A	EF2010-1025	1000PF	M.MYLAR	0
C304	EF2010-2215	220PF	M.MYLAR	0
C305	EZ20402-228	2200PF	ELECTRO	0
C306	EZ20402-228	2200PF	ELECTRO	0
C311	EPF0010-8829		P.P. CAPAC	0
C312	EPF0010-6822		P.P. CAPAC	0
C313	EPF0010-1035		P.P. CAPAC	0
C314	EPF0010-1030		P.P. CAPAC	0
C315	EPF0010-4725		P.P. CAPAC	0
C316	EPF0010-4725		P.P. CAPAC	0
C317	EE25006-226	22MF	ELECTRO	0
C318	EE25006-226	22MF	ELECTRO	0
C319	EF2010-5625	5600PF	M.MYLAR	0
C320	EF2010-5625	5600PF	M.MYLAR	0
C321	EF2010-3315	330PF	M.MYLAR	0
C322	EF2010-3315	330PF	M.MYLAR	0
C323	EF2010-6805	68PF	M.MYLAR	0
C324	EF2010-6805	68PF	M.MYLAR	0
C325	EP20101-2220	22PF		0
C326	EP20101-2220			0
C327	EE2505-227	220MF	ELECTRO	0
C328	EE2505-227	220MF	ELECTRO	0
C332	GCVB10H-103	0.01MF	50V CERAMIC	0
C333	GCVB10H-103	0.01MF	16V CERAMIC	0
C334	GCVB10H-103	0.01MF	16V CERAMIC	0
C335	GCVB10H-103	0.01MF	16V CERAMIC	0
C336	GCVB10H-103	0.01MF	16V CERAMIC	0
C337	GCVB10H-103	0.01MF	16V CERAMIC	0
C338	GCVB10H-103	0.01MF	16V CERAMIC	0
C339	GCVB10H-103	0.01MF	16V CERAMIC	0
C340	GCVB10H-103	0.01MF	16V CERAMIC	0
C341	GCVB10H-103	0.01MF	16V CERAMIC	0
C342	GCVB10H-103	0.01MF	16V CERAMIC	0
C343	GCVB10H-103	0.01MF	16V CERAMIC	0
C344	GCVB10H-103	0.01MF	16V CERAMIC	0
C345	GCVB10H-103	0.01MF	16V CERAMIC	0
C346	GCVB10H-103	0.01MF	16V CERAMIC	0
C347	GCVB10H-103	0.01MF	16V CERAMIC	0
C348	GCVB10H-103	0.01MF	16V CERAMIC	0
C349	GCVB10H-103	0.01MF	16V CERAMIC	0
C350	GCVB10H-103	0.01MF	16V CERAMIC	0
C351	GCVB10H-103	0.01MF	16V CERAMIC	0
C352	GCVB10H-103	0.01MF	16V CERAMIC	0
C353	GCVB10H-103	0.01MF	16V CERAMIC	0
C354	GCVB10H-103	0.01MF	16V CERAMIC	0
C355	GCVB10H-103	0.01MF	16V CERAMIC	0
C356	GCVB10H-103	0.01MF	16V CERAMIC	0
C357	GCVB10H-103	0.01MF	16V CERAMIC	0
C358	GCVB10H-103	0.01MF	16V CERAMIC	0
C359	GCVB10H-103	0.01MF	16V CERAMIC	0
C360	GCVB10H-103	0.01MF	16V CERAMIC	0
C361	GCVB10H-103	0.01MF	16V CERAMIC	0
C362	GCVB10H-103	0.01MF	16V CERAMIC	0
C363	GCVB10H-103	0.01MF	16V CERAMIC	0
C364	GCVB10H-103	0.01MF	16V CERAMIC	0
C365	GCVB10H-103	0.01MF	16V CERAMIC	0
C366	GCVB10H-103	0.01MF	16V CERAMIC	0
C367	GCVB10H-103	0.01MF	16V CERAMIC	0
C368	GCVB10H-103	0.01MF	16V CERAMIC	0
C369	GCVB10H-103	0.01MF	16V CERAMIC	0
C370	GCVB10H-103	0.01MF	16V CERAMIC	0
C371	GCVB10H-103	0.01MF	16V CERAMIC	0

△ : SAFETY PARTS

Capacitors

Δ	ITEM	PART NUMBER	DESCRIPTION	AREA
	C372	GC091HK-221	220PF 50V CERAMIC	D
	C373	EZ35004-226	220PF ELECTRO	
	C374	EZ35004-226	220PF ELECTRO	
	C379	GE783HM-105	10NF 50V ELECTRO	
	C380	GE783HM-125	2.2NF 50V NON POLY	
	C381	GC093HK-541	540PF 50V CERAMIC	
	C382	GC093HK-541	540PF 50V CERAMIC	
	C383	GC783HM-105	10NF 50V ELECTRO	
	C391	GE783HM-475	4.7NF 50V ELECTRO	
	C392	GE783HM-475	4.7NF 50V ELECTRO	
	C393	GE783HM-475	4.7NF 50V ELECTRO	
	C902	GE780JM-108	1000PF 6.3V ELECTRO	
	C903	GC751MP-223	0.022MF 50V CERAMIC	
	C904	GE783JM-107	1000PF 10V ELECTRO	
	C905	GC951Z-223	0.022MF 25V CERAMIC	

Δ : SAFETY PARTS

Resistors

Δ	ITEM	PART NUMBER	DESCRIPTION	AREA
	R301	QRD167J-473	47K 1/4W CARBON	
	R302	QRD167J-473	47K 1/4W CARBON	
	R303	ERD141J-5R65	5.6 1/4W CARBON	
	R304	ERD141J-5R65	5.6 1/4W CARBON	
	R305	QRD167J-222	2.2K 1/4W CARBON	
	R306	QRD167J-222	2.2K 1/4W CARBON	
	R307	QRD167J-222	2.2K 1/4W CARBON	
	R308	QRD167J-222	2.2K 1/4W CARBON	
	R311	QRD167J-470	47 1/4W CARBON	
	R312	QRD167J-470	47 1/4W CARBON	
	R313	QRD167J-471	470 1/4W CARBON	
	R314	QRD167J-471	470 1/4W CARBON	
	R315	QRD167J-821	820 1/4W CARBON	
	R316	QRD167J-821	820 1/4W CARBON	
	R317	ERD141J-2205	22 1/4W CARBON	
	R318	ERD141J-2205	22 1/4W CARBON	
	R319	ERD141J-2714	270 1/4W CARBON	
	R320	ERD141J-2718	270 1/4W CARBON	
	R321	QRD167J-102	1K 1/4W CARBON	D
	R322	QRD167J-102	1K 1/4W CARBON	D
Δ	R323	RV144F-1002	10K 1/4W N.FILM	
Δ	R324	RV144F-1002	10K 1/4W N.FILM	
Δ	R325	RV144F-1803	180K 1/4W N.FILM	
Δ	R326	RV144F-1803	180K 1/4W N.FILM	
Δ	R327	RV144F-1602	16K 1/4W N.FILM	
Δ	R328	RV144F-1602	16K 1/4W N.FILM	
Δ	R329	ERD141J-1015	100 1/4W CARBON	
Δ	R330	ERD141J-1015	100 1/4W CARBON	
Δ	R331	QRD167J-104	100K 1/4W CARBON	
Δ	R332	QRD167J-104	100K 1/4W CARBON	
Δ	R333	QRD167J-475	4.7M 1/4W CARBON	
Δ	R334	QRD167J-475	4.7M 1/4W CARBON	
Δ	R335	QRD167J-475	4.7M 1/4W CARBON	
Δ	R336	QRD167J-475	4.7M 1/4W CARBON	
Δ	R337	QRD167J-275	2.7M 1/4W CARBON	
Δ	R338	QRD167J-275	2.7M 1/4W CARBON	
Δ	R339	QRD167J-475	4.7M 1/4W CARBON	
Δ	R340	QRD167J-475	4.7M 1/4W CARBON	
Δ	R341	QRD167J-471	470 1/4W CARBON	
Δ	R342	QRD167J-471	470 1/4W CARBON	
Δ	R343	QRD167J-332	3.3K 1/4W CARBON	
Δ	R344	QRD167J-332	3.3K 1/4W CARBON	
Δ	R347	QRD167J-155	15K 1/4W CARBON	
Δ	R348	QRD167J-155	15K 1/4W CARBON	
Δ	R349	QRD167J-155	15K 1/4W CARBON	
Δ	R349	RFID077-470	47 1/4W FUSIBLE	C
Δ	R349	RFID077-470	47 1/4W FUSIBLE	D
Δ	R350	QRD14CJ-4705	47 1/4W UNF. CARBON	B
Δ	R350	QRD1077-470	47 1/4W FUSIBLE	C
Δ	R350	QRD1077-470	47 1/4W FUSIBLE	D
Δ	R351	QRD167J-331	330 1/4W CARBON	
Δ	R352	QRD167J-331	330 1/4W CARBON	
Δ	R353	QRD167J-331	330 1/4W CARBON	
Δ	R354	QRD167J-331	330 1/4W CARBON	
Δ	R355	QRD167J-331	330 1/4W CARBON	
Δ	R356	QRD167J-331	330 1/4W CARBON	
Δ	R357	QRD167J-331	330 1/4W CARBON	
Δ	R358	QRD167J-331	330 1/4W CARBON	
Δ	R359	QRD167J-331	330 1/4W CARBON	
Δ	R360	QRD167J-331	330 1/4W CARBON	
Δ	R361	QRD167J-331	330 1/4W CARBON	
Δ	R362	QRD167J-331	330 1/4W CARBON	
Δ	R363	QRD167J-331	330 1/4W CARBON	
Δ	R364	QRD167J-331	330 1/4W CARBON	
Δ	R365	QRD167J-331	330 1/4W CARBON	
Δ	R366	QRD167J-331	330 1/4W CARBON	
Δ	R367	QRD167J-476	470K 1/4W CARBON	

Resistors

Δ	ITEM	PART NUMBER	DESCRIPTION	AREA
	R368	QRD167J-474	470K 1/4W CARBON	
	R369	QRD167J-474	470K 1/4W CARBON	
	R370	QRD167J-474	470K 1/4W CARBON	
	R371	QRD167J-474	470K 1/4W CARBON	
	R372	QRD167J-474	470K 1/4W CARBON	
	R373	QRD167J-474	470K 1/4W CARBON	
	R374	QRD167J-474	470K 1/4W CARBON	
	R375	QRD167J-105	1M 1/4W CARBON	
	R376	QRD167J-105	1M 1/4W CARBON	
	R377	QRD167J-474	470K 1/4W CARBON	
	R378	QRD167J-474	470K 1/4W CARBON	
	R379	QRD167J-105	1M 1/4W CARBON	
	R380	QRD167J-105	1M 1/4W CARBON	
	R381	QRD167J-474	470K 1/4W CARBON	
	R382	QRD167J-474	470K 1/4W CARBON	
	R384	QRD167J-802	8.2K 1/4W CARBON	
	R385	QRD167J-221	220 1/4W CARBON	
	R386	QRD167J-221	220 1/4W CARBON	
	R391	QRD167J-563	56K 1/4W CARBON	
Δ	R392	QRD140J-8205	82 1/4W UNF. CARBON	C
Δ	R392	QRD140J-8205	82 1/4W UNF. CARBON	D
Δ	R394	QRD167J-824	820K 1/4W CARBON	
Δ	R399	QRD14CJ-1025	1.0K 1/4W UNF. CARBON	
Δ	R400	QRD14CJ-1825	1.8K 1/4W UNF. CARBON	
	R901	QRD167J-103	10K 1/4W CARBON	
	R902	QRD167J-103	10K 1/4W CARBON	
	R903	QRD167J-473	47K 1/4W CARBON	
	R904	QRD167J-103	10K 1/4W CARBON	
	R905	QRD167J-101	100 1/4W CARBON	
	R906	QRD167J-391	390 1/4W CARBON	
	R907	QRD167J-105	10K 1/4W CARBON	
	R908	QRD167J-473	47K 1/4W CARBON	
	R909	QRD167J-333	33K 1/4W CARBON	
	R910	QRD167J-104	100K 1/4W CARBON	
	R913	QRD167J-223	22K 1/4W CARBON	
	R914	QRD167J-223	22K 1/4W CARBON	
	R915	QRD167J-302	30K 1/4W CARBON	
	R916	QRD167J-101	100 1/4W CARBON	
	R917	QRD167J-303	30K 1/4W CARBON	
	R918	QRD167J-103	10K 1/4W CARBON	
	R919	QRD167J-103	10K 1/4W CARBON	
	R920	QRD167J-103	10K 1/4W CARBON	
	R921	QRD167J-105	10K 1/4W CARBON	
	R922	QRD167J-271	270 1/4W CARBON	
	R923	QRD167J-271	270 1/4W CARBON	
	R924	QRD167J-271	270 1/4W CARBON	
	R925	QRD167J-271	270 1/4W CARBON	
	R926	QRD167J-271	270 1/4W CARBON	
	R927	QRD167J-271	270 1/4W CARBON	
	R928	QRD167J-271	270 1/4W CARBON	
	R929	QRD167J-271	270 1/4W CARBON	
	R930	QRD167J-472	4.7K 1/4W CARBON	
	R931	QRD167J-151	150 1/4W CARBON	
	R932	QRD167J-321	320 1/4W CARBON	
	R933	QRD167J-201	200 1/4W CARBON	
	R934	QRD167J-201	200 1/4W CARBON	
	R937	QRD167J-201	200 1/4W CARBON	
	R938	QRD167J-241	240 1/4W CARBON	
	R939	QRD167J-473	47K 1/4W CARBON	
	R940	QRD167J-241	240 1/4W CARBON	
	R941	QRD167J-241	240 1/4W CARBON	
	R942	QRD167J-241	240 1/4W CARBON	
	R943	QRD167J-241	240 1/4W CARBON	
	R944	QRD167J-271	270 1/4W CARBON	
	R945	QRD167J-271	270 1/4W CARBON	
	R946	QRD167J-271	270 1/4W CARBON	
	R947	QRD167J-151	150 1/4W CARBON	
	R948	QRD167J-181	180 1/4W CARBON	
	R951	QRD167J-201	200 1/4W CARBON	
	R952	QRD167J-201	200 1/4W CARBON	
	R953	QRD167J-201	200 1/4W CARBON	
	R954	QRD167J-271	270 1/4W CARBON	
	R955	QRD167J-271	270 1/4W CARBON	
	R956	QRD167J-271	270 1/4W CARBON	
	R957	QRD167J-201	200 1/4W CARBON	
	R958	QRD167J-271	270 1/4W CARBON	
	R959	QRD167J-102	1K 1/4W CARBON	
	R960	QRD167J-102	1K 1/4W CARBON	
	R961	QRD167J-102	1K 1/4W CARBON	
	R962	QRD167J-151	150 1/4W CARBON	
	R963	QRD167J-151	150 1/4W CARBON	
	R964	QRD167J-201	200 1/4W CARBON	
	R965	QRD167J-221	220 1/4W CARBON	
	R967	QRD167J-471	470 1/4W CARBON	
	R968	QRD167J-471	470 1/4W CARBON	
	R975	QRD167J-472	4.7K 1/4W CARBON	

Δ : SAFETY PARTS

Others

ITEM	PART NUMBER	DESCRIPTION	AREA
	E15846-102	CIRCUIT BOARD	
	E305488-001	HOLDER	
	E305493-001	HOLDER	
	E46729-008	PLASTIC RIVET	
J301	EMV7122-004	CONNECTOR	
J302	EMV7122-005	CONNECTOR	
J351	EMN00TV-4084	4P PIN JACK	
J352	EMN00TV-6054	4P PIN JACK	
J353	EMN00TV-4084	4P PIN JACK	
J354	EMN00TV-4084	4P PIN JACK	
J355	EMV7122-003	CONNECTOR	
J357	EMV7122-005	CONNECTOR	
J903	EMV7122-003	CONNECTOR	
J905	EMV7122-004	CONNECTOR	
J904	EMV7122-004	CONNECTOR	
J907	EMV5120-008	PLUG ASSY	
L301	E9L4004-820	INDUCTOR	D
L302	E9L4004-820	INDUCTOR	D
L303	E9L4004-820	INDUCTOR	3
L304	E9L4004-820	INDUCTOR	D
P907	EMV7120-008	CONNECTOR	
S301	B8T9101-804	PUSH SWITCH	
S901	ESP0001-018	FACT SWITCH	
S902	ESP0001-018	FACT SWITCH	
S903	ESP0001-018	FACT SWITCH	
S904	ESP0001-018	FACT SWITCH	
S905	ESP0001-018	FACT SWITCH	

Others

ITEM	PART NUMBER	DESCRIPTION	AREA
S906	ESP0001-018	FACT SWITCH	
S907	ESP0001-018	FACT SWITCH	
S908	ESP0001-018	FACT SWITCH	
S909	ESP0001-018	FACT SWITCH	
S910	ESP0001-018	FACT SWITCH	
S911	ESP0001-018	FACT SWITCH	
S912	ESP0001-018	FACT SWITCH	
S913	ESP0001-018	FACT SWITCH	
CK901	CKX0004-194KM	RESONATOR	
FW301	EMR348-45LST	FLAT WIRE	
FW302	EMR338-45LST	FLAT WIRE	
FW303	EMR338-45LST	FLAT WIRE	
FW901	EMR338-40LST	FLAT WIRE	
FW902	EMR378-45KST	FLAT WIRE	
FW903	EMR338-10LST	FLAT WIRE	
FW904	EMR348-45KST	FLAT WIRE	
FW905	EMR348-10LST	FLAT WIRE	
FW906	EMR388-13LST	FLAT WIRE	
FW907	EMR338-085ST	FLAT WIRE	
JT901	EMV7122-003	CONNECTOR	
JT902	EMV7122-004	CONNECTOR	
JT906	EMV7122-004	CONNECTOR	
JT907	EMV7122-004	CONNECTOR	
RY351	ESK8024-212	RELAY	
RY352	ESK9012-214	RELAY	

△ : SAFETY PARTS

 END-056 Power Primary PC Board Ass'y

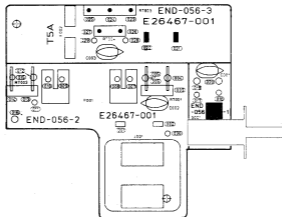
 Note: END-056 varies according to the areas employed. See note (1) when placing an order.

Note (1)

PC Board Ass'y	Designated Areas
END-056 A	the U.S.A., Canada
END-056 B	Other Countries
END-056 C	Australia, Continental Europe, West Germany
END-056 D BS	the U.K.

Capacitors

ITEM	PART NUMBER	DESCRIPTION	AREA
C001	Q219038-105	0.01MF	CERAMIC
C001	Q219038-103	0.01MF	CERAMIC A
C001	Q219038-103	0.01MF	CERAMIC B
C001	Q219038-103	0.01MF	CERAMIC C
C001	Q219038-103BS	0.01MF	CERAMIC DBS

△ : SAFETY PARTS

Others

ITEM	PART NUMBER	DESCRIPTION	AREA
EMG7331-001	FUSE CLIP		A
E03475-004	FUSE CLIP		A
E24447-001	CIRCUIT BOARD		A
E24447-001	CIRCUIT BOARD		B
E24447-001	CIRCUIT BOARD		C
E24447-001B9	CIRCUIT BOARD		DBS
E304242-001	WIRE CLAMP		A
E304242-001	WIRE CLAMP		B
E65508-002	TAB		C
J001	RMCO437-002	AC OUTLET	B

Others

ITEM	PART NUMBER	DESCRIPTION	AREA
J001	RMCO440-001	AC OUTLET	A
RT002	E67764-302	WRAPPING TERMINAL	A
RT002	E67764-302	WRAPPING TERMINAL	B
RT003	E67764-203	WRAPPING TERMINAL	C
RT003	E67764-203	WRAPPING TERMINAL	DBS
SP001	SPS1106-005	POWER SWITCH	A
SP001	SPS1106-005	POWER SWITCH	B
SP001	SPS1106-005	POWER SWITCH	C
SP001	SPS1106-005B5	POWER SWITCH	DBS

△ : SAFETY PARTS

■ ENH-120 □ Power Amplifier PC Board Ass'y

Note: ENH-120 □ varies according to the areas employed. See note (1) when placing an order.

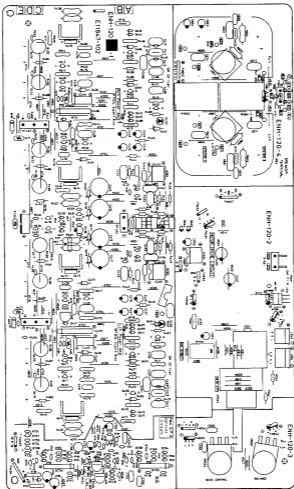

Note (1)

PC Board Assy	Designated Areas
ENH-120 B	the U.S.A., Canada
ENH-120 C	Australia, Continental Europe the U.K., Other Countries
ENH-120 D	West Germany

Transistors

ITEM	PART NUMBER	DESCRIPTION	AREA	
			MAKER	
9401	25C2910(S-T)	SILICON SANYO		
9402	25C2910(S-T)	SILICON SANYO		
9403	25A1208(S-T)	SILICON SANYO		
9404	25A1208(S-T)	SILICON SANYO		
9405	25C2910(S-T)	SILICON SANYO		
9406	25C2910(S-T)	SILICON SANYO		
9407	25D634(G-R)	SILICON MATSUSHITA		
9408	25B634(G-R)	SILICON MATSUSHITA		
9409	25C2909(S-T)	SILICON SANYO		
9410	25C2909(S-T)	SILICON SANYO		
9411	25A1207(S-T)	SILICON SANYO		
9412	25A1207(S-T)	SILICON SANYO		
9413	25B649A(B-C)	SILICON HITACHI		
9414	25B649A(B-C)	SILICON HITACHI		
9415	25B649A(B-C)	SILICON HITACHI		
9416	25B649A(B-C)	SILICON HITACHI		
9417	25D2155L(B-C)	SILICON TOSHIBA		
9418	25D2155L(B-C)	SILICON TOSHIBA		
9419	25B1429L(B-C)	SILICON TOSHIBA		
9420	25B1429L(B-C)	SILICON TOSHIBA		
9421	25D2155L(B-C)	SILICON TOSHIBA		
9422	25D2155L(B-C)	SILICON TOSHIBA		
9423	25B1429L(B-C)	SILICON TOSHIBA		
9424	25B1429L(B-C)	SILICON TOSHIBA		
9425	25C2240(SR-8L)	SILICON FOSHIBA		
9426	25C2240(SR-8L)	SILICON FOSHIBA		
9427	25A970(GR-8L)	SILICON TOSHIBA		
9428	25A970(GR-8L)	SILICON TOSHIBA		
9429	25C2909(S-T)	SILICON SANYO		
9430	25C2909(S-T)	SILICON SANYO		
9431	25A970(GR-8L)	SILICON TOSHIBA		
9432	25D1302(S-T)	SILICON MATSUSHITA		
9702	25D1302(S-T)	SILICON MATSUSHITA		
9703	25A1029(C-R)	SILICON HITACHI		
9704	DT1314Y	SILICON ROHM		
9705	25C458(C-C)	SILICON HITACHI		
9706	25C458(C-C)	SILICON HITACHI		
9707	25C458(C-C)	SILICON HITACHI		
9708	25C458(C-C)	SILICON HITACHI		
9709	DT1344E	SILICON ROHM		

Δ : SAFETY PARTS

I.C.s

ITEM	PART NUMBER	DESCRIPTION	AREA	
			MAKER	
IC405	VC45800V	I.C. DAINICHI		
IC406	VC45800V	I.C. DAINICHI		
IC403	PC837A	I.C. SHARP		
IC404	PC837A	I.C. SHARP		
IC405	V5302-2	I.C. SANYO		
IC406	V5302-2	I.C. SANYO		
IC553	LS1629-CV	I.C. SANYO		
IC703	8A15218M	I.C. ROHM		
IC702	8A15218M	I.C. ROHM		

Δ : SAFETY PARTS

Diodes

ITEM	PART NUMBER	DESCRIPTION	AREA	
			MAKER	
9401	834.7692	ZENER NEC		B
9402	834.7692	ZENER NEC		B
9403	158817D	SILICON HITACHI		
9404	158817D	SILICON HITACHI		
9405	158817D	SILICON HITACHI		
9406	158817D	SILICON HITACHI		
9407	158133	SILICON ROHM		
9408	158133	SILICON ROHM		

2-16 (No. 20115)

Diodes

ITEM	PART NUMBER	DESCRIPTION	AREA	
			MAKER	
9409	158133	SILICON ROHM		
9410	158133	SILICON ROHM		
9411	158133	SILICON ROHM		
9412	158133	SILICON ROHM		
9413	158133	SILICON ROHM		
9414	158133	SILICON ROHM		
9415	158133	SILICON ROHM		
9416	158133	SILICON ROHM		
9417	H115-1LT0	ZENER HITACHI		
9418	H115-1LT0	ZENER HITACHI		
9419	H115-1LT0	ZENER HITACHI		
9420	H115-1LT0	ZENER HITACHI		
9421	158133	SILICON ROHM		
9422	158133	SILICON ROHM		
9423	158133	SILICON ROHM		
9424	158133	SILICON ROHM		
9425	158133	SILICON ROHM		
9426	158133	SILICON ROHM		
9427	158133	SILICON ROHM		
9428	158133	SILICON ROHM		
9429	158133	SILICON ROHM		
9430	158133	SILICON ROHM		
9431	158133	SILICON ROHM		
9432	158133	SILICON ROHM		
9433	158133	SILICON ROHM		
9434	158133	SILICON ROHM		
9435	SLR-34M50F124	L.E.D. ROHM		C
9436	SLR-34M50F124	L.E.D. ROHM		D
9437	SLR-34M50F124	L.E.D. ROHM		C
9438	SLR-34M50F124	L.E.D. ROHM		D
9439	25A1029-C2L1	SILICON KVOUDOU		
9440	25A1029-C2L1	SILICON KVOUDOU		
9703	158133	SILICON ROHM		
9704	158133	SILICON ROHM		
9705	158133	SILICON ROHM		
9706	158133	SILICON ROHM		
9707	MT1A.7JB	ZENER ROHM		
9708	MT1A.7JB	ZENER ROHM		
9709	158133	SILICON ROHM		
9710	158133	SILICON ROHM		
9711	MT10JC	ZENER ROHM		
9712	MT1A.7JB	ZENER ROHM		

Capacitors

ITEM	PART NUMBER	DESCRIPTION	AREA	
			MAKER	
CA03	EF20101-1015	100PF		N.MYLAR
CA04	EF20101-1015	100PF		N.MYLAR
CA05	EFF001J-220			F.W. CAPACIT
CA06	EFF001J-220			F.W. CAPACIT
CA07	EFF001J-220			F.W. CAPACIT
CA08	EFF001J-220			F.W. CAPACIT
CA09	EF20101-4725	4700PF		N.MYLAR
CA10	EF20101-4725	4700PF		N.MYLAR
CA11	EF20101-4725	4700PF		N.MYLAR
CA12	EF20101-4725	4700PF		N.MYLAR
CA13	EE25006-10Y	100NF		ELECTRO
CA16	EE25006-107	100NF		ELECTRO
CA17	EE25006-107	100NF		ELECTRO
CA18	EE25006-107	100NF		ELECTRO
CA19	GET81NH-475	4.7NF	50V	ELECTRO
CA20	GET81NH-475	4.7NF	50V	ELECTRO
CA21	GET81NH-475	4.7NF	50V	ELECTRO
CA22	GET81NH-475	4.7NF	50V	ELECTRO
CA23	EFF001J-220			F.W. CAPACIT
CA24	EFF001J-220			F.W. CAPACIT
CA25	EFF001J-220			F.W. CAPACIT
CA26	EFF001J-220			F.W. CAPACIT
CA27	EFF001J-220			F.W. CAPACIT
CA28	EFF001J-220			F.W. CAPACIT
CA29	GET81NH-104	10NF	50V	ELECTRO
CA31	GFV81HJ-104	0.1NF	50V	T.FILM B
CA32	GFV81HJ-104	0.1NF	50V	T.FILM C
CA33	GFV81HJ-223	0.022NF	50V	T.FILM D
CA34	GFV81HJ-104	0.1NF	50V	T.FILM B
CA35	GFV81HJ-104	0.1NF	50V	T.FILM C
CA36	GFV81HJ-104	0.1NF	50V	T.FILM D
CA37	GFV81HJ-104	0.1NF	50V	T.FILM C
CA38	GFV81HJ-104	0.1NF	50V	T.FILM C
CA39	GFV81HJ-104	0.1NF	50V	T.FILM C
CA40	GFV81HJ-104	0.1NF	50V	T.FILM C
CA41	GFV81HJ-104	0.1NF	50V	T.FILM C
CA42	GFV81HJ-104	0.1NF	50V	T.FILM C
CA43	GFV81HJ-104	0.1NF	50V	T.FILM C
CA44	GFV81HJ-104	0.1NF	50V	T.FILM C
CA45	GFV81HJ-104	0.1NF	50V	T.FILM C
CA46	GFV81HJ-104	0.1NF	50V	T.FILM C
CA47	GFV81HJ-104	0.1NF	50V	T.FILM C
CA48	GFV81HJ-104	0.1NF	50V	T.FILM C
CA49	GFV81HJ-104	0.1NF	50V	T.FILM C
CA50	GFV81HJ-104	0.1NF	50V	T.FILM C
CA51	GET81NH-475	4.7NF	50V	ELECTRO
CA52	GET81NH-475	4.7NF	50V	ELECTRO
CA53	GET81NH-475	4.7NF	50V	ELECTRO
CA54	GET81NH-475	4.7NF	50V	ELECTRO
CA55	GET81NH-475	4.7NF	50V	ELECTRO
CA56	GFV81HJ-562	5600PF	50V	N.MYLAR
CA57	GFV81HJ-562	5600PF	50V	N.MYLAR
CA58	GFV81HJ-2215	220PF	50V	N.MYLAR D
CA59	EF20101-2215	220PF	50V	N.MYLAR D
CA60	EF20101-3915	390PF	50V	N.MYLAR D
CA61	EF20101-2225	2200PF	50V	N.MYLAR D

Δ : SAFETY PARTS

Capacitors

ITEM	PART NUMBER	DESCRIPTION	AREA
C456	CFZ0101-2220	2200PF	M.MYLAR
C532	GC801E1-223	0.022MF	25V CERAMIC
C532	QETB3HM-105	1MF	50V ELECTRO
C533	QETB3HM-107	100MF	10V ELECTRO
C533	QFVB3HJ-104	0.1MF	50V T.FILM
C534	QFVB3HJ-104	0.1MF	50V T.FILM
C653	QETB3HM-105	1MF	50V ELECTRO
C654	QETB3HM-105	1MF	50V ELECTRO
C655	QFVB3HJ-104	0.1MF	50V T.FILM
C656	QFVB3HJ-104	0.1MF	50V T.FILM
C657	QFVB3HJ-104	0.1MF	50V T.FILM
C658	QFVB3HJ-104	0.1MF	50V T.FILM
C672	QFVB3HJ-103	0.01MF	50V T.FILM
C673	QFVB3HJ-103	0.01MF	50V T.FILM
C674	QFVB3HJ-103	0.01MF	50V T.FILM
C700	QFNB3HJ-223	0.022MF	50V MYLAR
C702	QFNB3HJ-223	0.022MF	50V MYLAR
C703	QETB3EM-106	10MF	25V ELECTRO
C705	QETB3EM-107	10MF	25V ELECTRO
C706	QETB3EM-107	10MF	25V ELECTRO
C707	QETB3EM-105	10MF	25V ELECTRO
C708	QETB3EM-476	47MF	25V ELECTRO

Resistors

ITEM	PART NUMBER	DESCRIPTION	AREA
R401	QRD167J-684	680K	1/4W CARBON
R402	QRD167J-684	680K	1/4W CARBON
R403	ERD141J-1015	100	1/4W CARBON
R404	ERD141J-1015	100	1/4W CARBON
R405	ERD141J-1015	100	1/4W CARBON
R406	ERD141J-1015	100	1/4W CARBON
R407	ERD141J-2225	2.2K	1/4W CARBON
R408	ERD141J-2225	2.2K	1/4W CARBON
R409	QRD14CJ-8205	82	1/4W UNF. CARBON B
R409	QRD14CJ-8205	82	1/4W UNF. CARBON B
R409	QRZ0077-820	82	1/4W FUSIBLE C
R410	QRD14CJ-8205	82	1/4W UNF. CARBON B
R410	QRZ0077-820	82	1/4W FUSIBLE C
R410	QRZ0077-820	82	1/4W FUSIBLE C
R411	QRD14CJ-1015	100	1/4W UNF. CARBON B
R411	QRZ0077-330	33	1/4W FUSIBLE C
R411	QRZ0077-330	33	1/4W FUSIBLE C
R412	QRD14CJ-1015	100	1/4W UNF. CARBON B
R412	QRZ0077-330	33	1/4W FUSIBLE C
R412	QRZ0077-330	33	1/4W FUSIBLE C
R413	QRD14CJ-4705	47	1/4W UNF. CARBON B
R413	QRZ0077-470	47	1/4W FUSIBLE C
R413	QRZ0077-470	47	1/4W FUSIBLE C
R414	QRD14CJ-4705	47	1/4W UNF. CARBON B
R414	QRZ0077-470	47	1/4W FUSIBLE C
R414	QRZ0077-470	47	1/4W FUSIBLE C
R415	QRD14CJ-8205	82	1/4W UNF. CARBON B
R415	QRZ0077-820	82	1/4W FUSIBLE C
R415	QRZ0077-820	82	1/4W FUSIBLE C
R416	QRD14CJ-8205	82	1/4W UNF. CARBON B
R416	QRZ0077-820	82	1/4W FUSIBLE C
R416	QRZ0077-820	82	1/4W FUSIBLE C
R417	QRD167J-562	5.6K	1/4W CARBON
R418	QRD167J-562	5.6K	1/4W CARBON
R419	QRD167J-562	5.6K	1/4W CARBON
R420	QRD167J-562	5.6K	1/4W CARBON
R421	QRD14CJ-1215	120	1/4W UNF. CARBON
R422	QRD14CJ-1215	120	1/4W UNF. CARBON
R423	QRD14CJ-1215	120	1/4W UNF. CARBON
R424	QRD14CJ-1215	120	1/4W UNF. CARBON
R425	QRD14CJ-8K25	8.2	1/4W UNF. CARBON B
R426	QRD14CJ-8K25	8.2	1/4W UNF. CARBON B
R427	ERD141J-2235	22K	1/4W CARBON
R428	ERD141J-2235	22K	1/4W CARBON
R429	ERD141J-2235	22K	1/4W CARBON
R430	ERD141J-2235	22K	1/4W CARBON
R431	QRG022J-272A	2.7K	2W D.M. FILM
R432	QRG022J-272A	2.7K	2W D.M. FILM
R433	QRD167J-475	47K	1/4W CARBON
R434	QRD167J-475	47K	1/4W CARBON
R435	QRD167J-333	33K	1/4W CARBON
R436	QRD167J-333	33K	1/4W CARBON
R437	QRG022J-272A	2.7K	2W D.M. FILM
R438	QRG022J-272A	2.7K	2W D.M. FILM
R441	QRD141J-2235	2.2K	1/4W CARBON
R442	ERD141J-2225	2.2K	1/4W CARBON
R443	ERD141J-1050	1M	1/4W CARBON
R444	ERD141J-1050	1M	1/4W CARBON
R445	ERD141J-1050	1M	1/4W CARBON
R446	ERD141J-1050	1M	1/4W CARBON

Resistors

ITEM	PART NUMBER	DESCRIPTION	AREA
R447	ERD141J-1235	12K	1/4W CARBON
R448	ERD141J-1235	12K	1/4W CARBON
R449	ERD141J-1525	1.5K	1/4W CARBON
R450	ERD141J-1525	1.5K	1/4W CARBON
R451	ERD141J-1515	150	1/4W CARBON
R452	ERD141J-1515	150	1/4W CARBON
R461	QVP601-202	2K	0.15W VARIABLE
R462	QVP601-202	2K	0.15W VARIABLE
R463	QRD167J-101	100	1/4W CARBON
R464	QRD167J-101	100	1/4W CARBON
R465	ERT-02WFL3515	350	1/4W THERMISTOR C
R466	ERT-02WFL3515	350	1/4W THERMISTOR C
R467	QRD167J-332	3.3K	1/4W CARBON
R468	QRD167J-332	3.3K	1/4W CARBON
R469	QRD167J-561	560	1/4W CARBON
R470	QRD167J-561	560	1/4W CARBON
R471	SDT250		THERMISTOR C
R471	SDT250		THERMISTOR C
R472	SDT250		THERMISTOR C
R472	SDT250		THERMISTOR C
R473	QRD14CJ-2715	270	1/4W UNF. CARBON B
R473	QRZ0077-271	270	1/4W FUSIBLE C
R473	QRZ0077-271	270	1/4W FUSIBLE C
R474	QRD14CJ-2715	270	1/4W UNF. CARBON B
R474	QRZ0077-271	270	1/4W FUSIBLE C
R474	QRZ0077-271	270	1/4W FUSIBLE C
R475	QRD14CJ-2715	270	1/4W UNF. CARBON B
R475	QRZ0077-271	270	1/4W FUSIBLE C
R475	QRZ0077-271	270	1/4W FUSIBLE C
R476	QRD14CJ-2715	270	1/4W UNF. CARBON B
R476	QRZ0077-271	270	1/4W FUSIBLE C
R476	QRZ0077-271	270	1/4W FUSIBLE C
R477	QRD14CJ-4875	4.7	1/4W UNF. CARBON B
R477	QRZ0077-487	4.7	1/4W FUSIBLE C
R477	QRZ0077-487	4.7	1/4W FUSIBLE C
R478	QRD14CJ-4875	4.7	1/4W UNF. CARBON B
R478	QRZ0077-487	4.7	1/4W FUSIBLE C
R478	QRZ0077-487	4.7	1/4W FUSIBLE C
R479	QRD14CJ-4875	4.7	1/4W UNF. CARBON B
R479	QRZ0077-487	4.7	1/4W FUSIBLE C
R479	QRZ0077-487	4.7	1/4W FUSIBLE C
R480	QRD14CJ-4875	4.7	1/4W UNF. CARBON B
R480	QRZ0077-487	4.7	1/4W FUSIBLE C
R480	QRZ0077-487	4.7	1/4W FUSIBLE C
R481	QRD125J-2R2	2.2	1/2W UNF. CARBON B
R481	QRX012J-R22A	0.22	1W M.FILM C
R481	QRX012J-R22A	0.22	1W M.FILM C
R482	QRD125J-2R2	2.2	1/2W UNF. CARBON B
R482	QRX012J-R22A	0.22	1W M.FILM C
R482	QRX012J-R22A	0.22	1W M.FILM C
R483	QRD125J-2R2	2.2	1/2W UNF. CARBON B
R483	QRX012J-R22A	0.22	1W M.FILM C
R483	QRX012J-R22A	0.22	1W M.FILM C
R484	QRD125J-2R2	2.2	1/2W UNF. CARBON B
R484	QRX012J-R22A	0.22	1W M.FILM C
R484	QRX012J-R22A	0.22	1W M.FILM C
R485	QRD125J-2R2	2.2	1/2W UNF. CARBON B
R485	QRX012J-R22A	0.22	1W M.FILM C
R485	QRX012J-R22A	0.22	1W M.FILM C
R486	QRD125J-2R2	2.2	1/2W UNF. CARBON B
R486	QRX012J-R22A	0.22	1W M.FILM C
R486	QRX012J-R22A	0.22	1W M.FILM C
R487	QRD125J-2R2	2.2	1/2W UNF. CARBON B
R487	QRX012J-R22A	0.22	1W M.FILM C
R487	QRX012J-R22A	0.22	1W M.FILM C
R488	QRD125J-2R2	2.2	1/2W UNF. CARBON B
R488	QRX012J-R22A	0.22	1W M.FILM C
R488	QRX012J-R22A	0.22	1W M.FILM C
R489	ERZ0001-R22	0.22	5W SMITTER
R490	ERZ0001-R22	0.22	5W SMITTER
R491	ERZ0001-R22	0.22	5W SMITTER
R492	ERZ0001-R22	0.22	5W SMITTER
R493	ERZ0001-R22	0.22	5W SMITTER
R494	ERZ0001-R22	0.22	5W SMITTER
R495	ERZ0001-R22	0.22	5W SMITTER
R496	ERZ0001-R22	0.22	5W SMITTER
R497	QRD167J-100	10	1/4W CARBON
R498	QRD167J-100	10	1/4W CARBON
R499	QRD167J-100	10	1/4W CARBON
R500	QRD167J-100	10	1/4W CARBON
R501	QRD167J-621	620	1/4W CARBON
R502	QRD167J-621	620	1/4W CARBON
R503	QRD167J-621	620	1/4W CARBON
R504	QRD167J-621	620	1/4W CARBON
R505	QRD167J-271	270	1/4W CARBON

A : SAFETY PARTS

Resistors

ITEM	PART NUMBER	DESCRIPTION	AREA
R306	80D167J-271	270	1/4W CARBON
R307	80D167J-820	82	1/4W CARBON
R308	80D167J-820	82	1/4W CARBON
R309	80D167J-520	52	1/4W CARBON
R310	80D167J-820	82	1/4W CARBON
R311	80D14CJ-1825	1.8K	1/4W UNF. CARBON B
R312	80Z0077-182	1.8K	1/4W FUSIBLE C
R313	80Z0077-182	1.8K	1/4W FUSIBLE D
R314	80D14CJ-1825	1.8K	1/4W UNF. CARBON B
R315	80Z0077-182	1.8K	1/4W FUSIBLE C
R316	80Z0077-151	150	1/4W FUSIBLE C
R317	80D14CJ-1515	150	1/4W UNF. CARBON B
R318	80Z0077-151	150	1/4W FUSIBLE C
R319	80Z0077-151	150	1/4W FUSIBLE D
R320	80D14CJ-1515	150	1/4W UNF. CARBON B
R321	80Z0077-151	150	1/4W FUSIBLE C
R322	80D14CJ-2R25	2.2	1/4W R-NETWORK B
R323	80Z0076-2R2	2.2	1/4W FUSIBLE C
R324	80Z0076-2R2	2.2	1/4W FUSIBLE D
R325	80D14CJ-2R25	2.2	1/4W R-NETWORK B
R326	80Z0076-2R2	2.2	1/4W FUSIBLE C
R327	80D14CJ-1005	10	1/4W UNF. CARBON B
R328	80Z0077-100	10	1/4W FUSIBLE C
R329	80Z0077-100	10	1/4W FUSIBLE D
R330	80D14CJ-1005	10	1/4W UNF. CARBON B
R331	80Z0077-100	10	1/4W FUSIBLE C
R332	80Z0077-100	10	1/4W FUSIBLE D
R333	80D14CJ-2R25	2.2	1/4W R-NETWORK B
R334	80Z0076-2R2	2.2	1/4W FUSIBLE C
R335	80Z0076-2R2	2.2	1/4W FUSIBLE D
R336	80D14CJ-2R25	2.2	1/4W R-NETWORK B
R337	80Z0076-2R2	2.2	1/4W FUSIBLE C
R338	80D14CJ-1005	10	1/4W UNF. CARBON B
R339	80Z0077-100	10	1/4W FUSIBLE C
R340	80Z0077-100	10	1/4W FUSIBLE D
R341	80D14CJ-1005	10	1/4W UNF. CARBON B
R342	80Z0077-100	10	1/4W FUSIBLE C
R343	80Z0077-100	10	1/4W FUSIBLE D
R344	80D14CJ-1005	10	1/4W UNF. CARBON B
R345	80Z0077-100	10	1/4W FUSIBLE C
R346	80Z0077-100	10	1/4W FUSIBLE D
R347	80D167J-183	18K	1/4W CARBON
R348	80D167J-183	18K	1/4W CARBON
R349	80D167J-222	2.2K	1/4W CARBON
R350	80D167J-222	2.2K	1/4W CARBON
R351	80D167J-103	50K	1/4W CARBON
R352	80D167J-332	5.3K	1/4W CARBON
R353	80D14CJ-4705	47	1/4W UNF. CARBON
R354	80D14CJ-1035	10E	1/4W CARBON
R355	80D14CJ-1035	10E	1/4W CARBON
R356	80D14CJ-8205	82	1/4W UNF. CARBON C
R357	80D14CJ-8205	82	1/4W UNF. CARBON D
R358	80D125J-100	10	1/2W UNF. CARBON
R359	80D125J-100	10	1/2W UNF. CARBON
R360	80D22J-100A	10	2W D.M.FILM
R701	80D167J-224	220K	1/6W CARBON
R702	80D167J-224	220K	1/6W CARBON
R703	80D167J-224	220K	1/6W CARBON
R704	80D167J-224	22K	1/6W CARBON
R705	80D167J-225	22K	1/6W CARBON
R706	80D167J-225	22K	1/6W CARBON
R707	80D167J-225	22K	1/6W CARBON
R708	80D167J-225	22K	1/6W CARBON
R709	80D167J-225	22K	1/6W CARBON
R710	80D167J-225	22K	1/6W CARBON
R711	80D167J-473	47K	1/6W CARBON
R712	80D167J-473	47K	1/6W CARBON
R713	80D167J-222	2.2K	1/6W CARBON
R714	80D167J-222	2.2K	1/6W CARBON
R715	80D167J-183	18K	1/6W CARBON
R716	80D167J-183	18K	1/6W CARBON
R717	80D167J-682	6.8K	1/6W CARBON
R718	80D167J-682	6.8K	1/6W CARBON
R719	80D167J-224	22K	1/6W CARBON
R720	80D167J-224	22K	1/6W CARBON
R721	80D167J-103	10K	1/6W CARBON
R722	80D167J-332	3.3K	1/6W CARBON
R723	80D167J-471	470	1/6W CARBON
R724	80D167J-305	30K	1/6W CARBON
R725	PTK59F048F222T5		POSISTOR
R727	80D167J-153	15K	1/6W CARBON
R728	80D167J-153	15K	1/6W CARBON
R729	80D167J-822	8.2K	1/6W CARBON
R730	80D167J-822	8.2K	1/6W CARBON
R731	80D167J-332	3.3K	1/6W CARBON
R732	80D167J-562	5.6K	1/6W CARBON
R733	80D167J-682	6.8K	1/6W CARBON
R734	80D167J-682	6.8K	1/6W CARBON

RESISTORS

ITEM	PART NUMBER	DESCRIPTION	AREA
R735	80D167J-333	33K	1/6W CARBON
R736	80D167J-332	3.3K	1/6W CARBON
R737	80D14CJ-4715	470	1/4W UNF. CARBON
R738	80D14CJ-3915	390	1/4W UNF. CARBON
VR551	80D87M-EF58	250K	VARIABLE
VR552	80D87M-EZ49	250K	VARIABLE
VR553	80D884J-E158	100K	VARIABLE

Others

ITEM	PART NUMBER	DESCRIPTION	AREA
BUSH-PUL		BUSHING	
EMT011-071		TERMINAL WIRE	D
EMT011-088		TERMINAL WIRE	D
EMT011-117		TERMINAL WIRE	
E11847-102		CIRCUIT BOARD	
E304346-005		HEAT SINK	
E304952-001		BRACKET	
E304952-002		BRACKET	
E305489-001		COVER	B
E30570-003		TIE BAND	
E70306-002		WIRE CLAMP	
E70306-002		HEAT SINK	
E70309-001		EARTH PLATE	D
E72018-002		WIRE CLAMP	
E72018-002		WIRE CLAMP	
E73498-001		SPACER	
E74265-001		BRACKET	
E74266-002		SPECIAL SCREW	D
E75019-001		VOLUME BRACKET	
88823008CC		SCREW	
88823008CC		SCREW	
88823008CC		SCREW	
88823012CC		SCREW	B
88823012CC		SCREW	
895T2604M		SCREW	
J405	EMV7122-005	CONNECTOR	
J406	EMV7122-003	CONNECTOR	
J551	80V500A-003K	PLUG ASSY	
J552	EMW7112-003R	CONNECTOR	
J554	EMV7112-004R	CONNECTOR	
J451	EMV7122-003	CONNECTOR	
J455	EM8007P-801F	SPEAKER TERMINAL	
L455	80L0003-1R0	INDUCTOR	
L452	80L0003-1R0	INDUCTOR	
FW401	EMR23C-161M	FLAT WIRE	
FW402	EMR338-161ST	FLAT WIRE	
FW403	EMR338-558ST	FLAT WIRE	
FW404	EMR368-015ST	FLAT WIRE	
FW522	EMR23C-161M	FLAT WIRE	
FW553	EMR23C-252N	FLAT WIRE	
FW554	EMR348-258ST	FLAT WIRE	
FW555	EMR338-015ST	FLAT WIRE	
FW556	EMR338-551ST	FLAT WIRE	
FW557	EMR338-081ST	FLAT WIRE	
FW558	EMR23C-081M	FLAT WIRE	
FW559	EMR23C-401M	FLAT WIRE	
FW560	EMR348-131ST	FLAT WIRE	
RT401	EM7764-503	WRAPPING TERMINAL	
RT402	EM7764-503	WRAPPING TERMINAL	
RT403	EM7764-503	WRAPPING TERMINAL	
RY551	ESK5512-124	RELAY	
RY552	ESK5524-214	RELAY	
RY552	ESK5524-214	RELAY	
TP401	80V500S-905K	PLUG ASSY	D
EMT011-071		WIRE ASSY	D
EMT011-088		WIRE ASSY	D

Δ : SAFETY PARTS

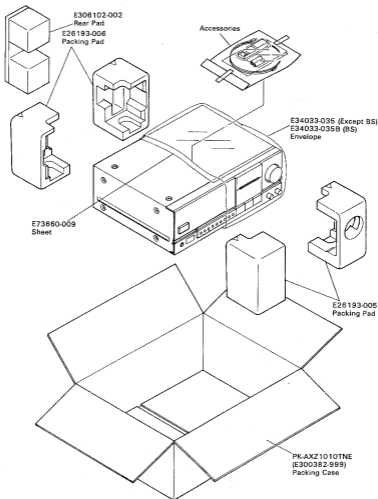

Packing Materials and Part Numbers



The Marks for Designated Areas

J.....the U.S.A.	G.....West Germany
C.....Canada	BS.....the U.K.
A.....Australia	U.....Other Countries
E,EF.....Continental Europe	No mark indicates all areas.

Accessories List

	Part Number	Part Name	Q'ty	Description	Areas
	E30580-1540A	Instruction Book	1		Except B5
	E30580-1540AB5	Instruction Book	1		B5
	BT-20048C	Warranty Card	1		J
	BT-20025K	Warranty Card	1		C
	BT-20117	Warranty Card	1		G
	BT20029C	Warranty Card	1		A
	BT20060	Warranty Card	1		B5
	BT20044F	Safety Instruction Sheet	1		J
	BT20108	Service Information Card	1		J
	BT20071A	Service Center List	1		C
	BT20098	Audio Warranty	1	for New Zealand	A
	BT20066A	ECC Agency	1		B5
	TOCP172-1MB-IV	Optical Fiber	1		
	E72360-001	Caution Sheet	1		C
	QMF51A2-100J1	Fuse	1	F003	U
	E67142-T10R0	Fuse Label	1		U
	E04056	Siemens Plug	1		U
	E35497-015	Caution Sheet	1	220V	U
	QZL1008-001	FTZ Information Sheet	1		G
	E43486-340A	Safety Sheet	1		B5
	RM-5A1010U	Remote Controler	1		
	UM-3(DJ)-2PSA	Battery	1		
	E66416-003	Envelope	1		J
	E6581-4	Envelope	1		U
	E41202-2	Envelope	1	for instruction Book	Except B5
	E41202-2B	Envelope	1	for instruction Book	B5

 Safety Parts

The Marks for Designated Areas

J-----the U.S.A.

C-----Canada

A-----Australia

E,EF-----Continental Europe

G-----West Germany

B5-----the U.K.

U-----Other Countries

No mark indicates all areas.

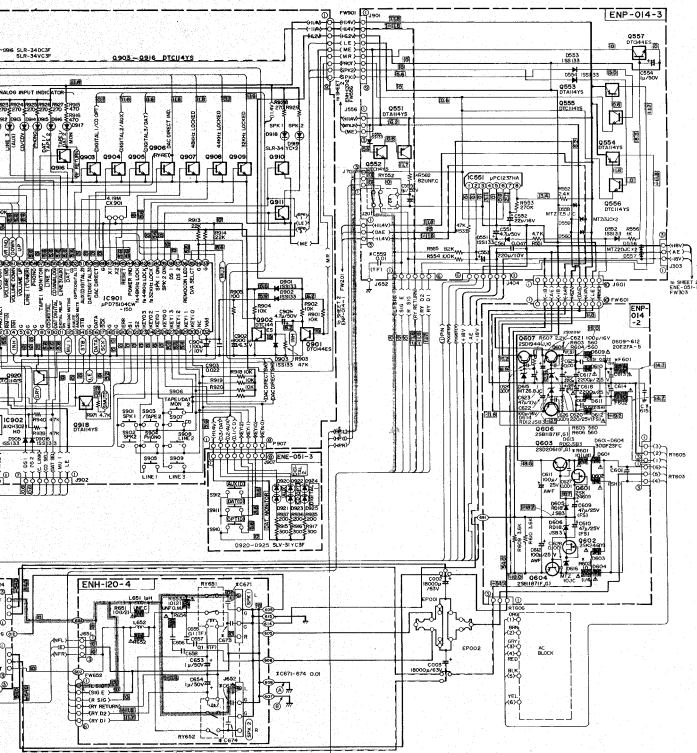

Schematic Diagrams

Source Input and Power Amplifier Section

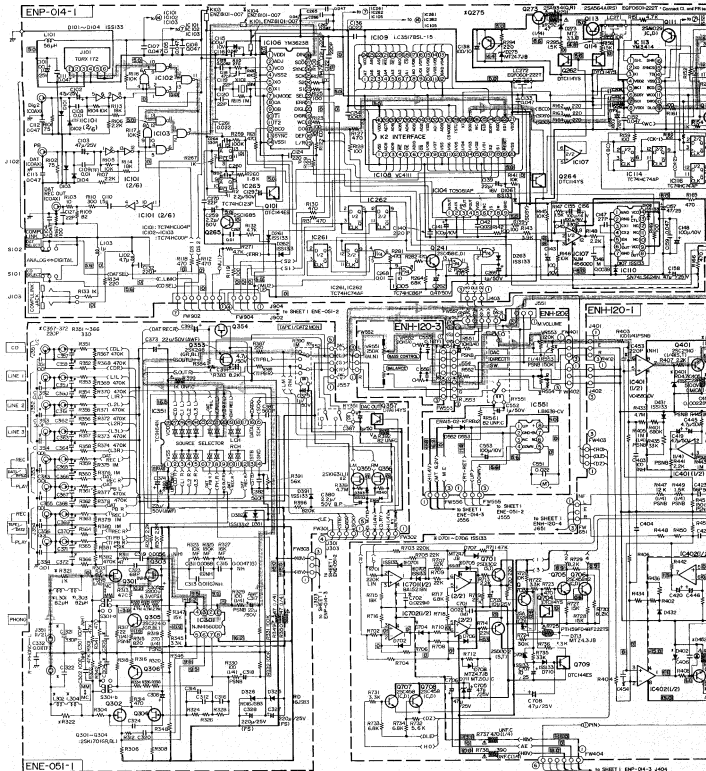

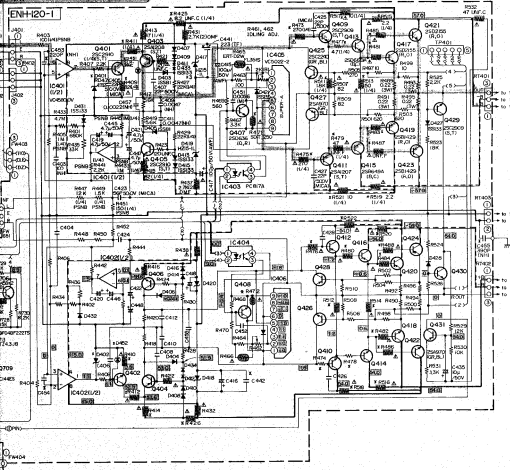
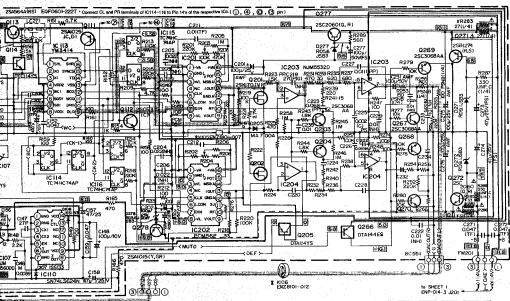

10 SHEET 014-00-1
 10 SHEET 014-00-2
 10 SHEET 014-00-3
 10 SHEET 014-00-4
 10 SHEET 014-00-5
 10 SHEET 014-00-6
 10 SHEET 014-00-7
 10 SHEET 014-00-8
 10 SHEET 014-00-9
 10 SHEET 014-00-10