

SERVICE MANUAL

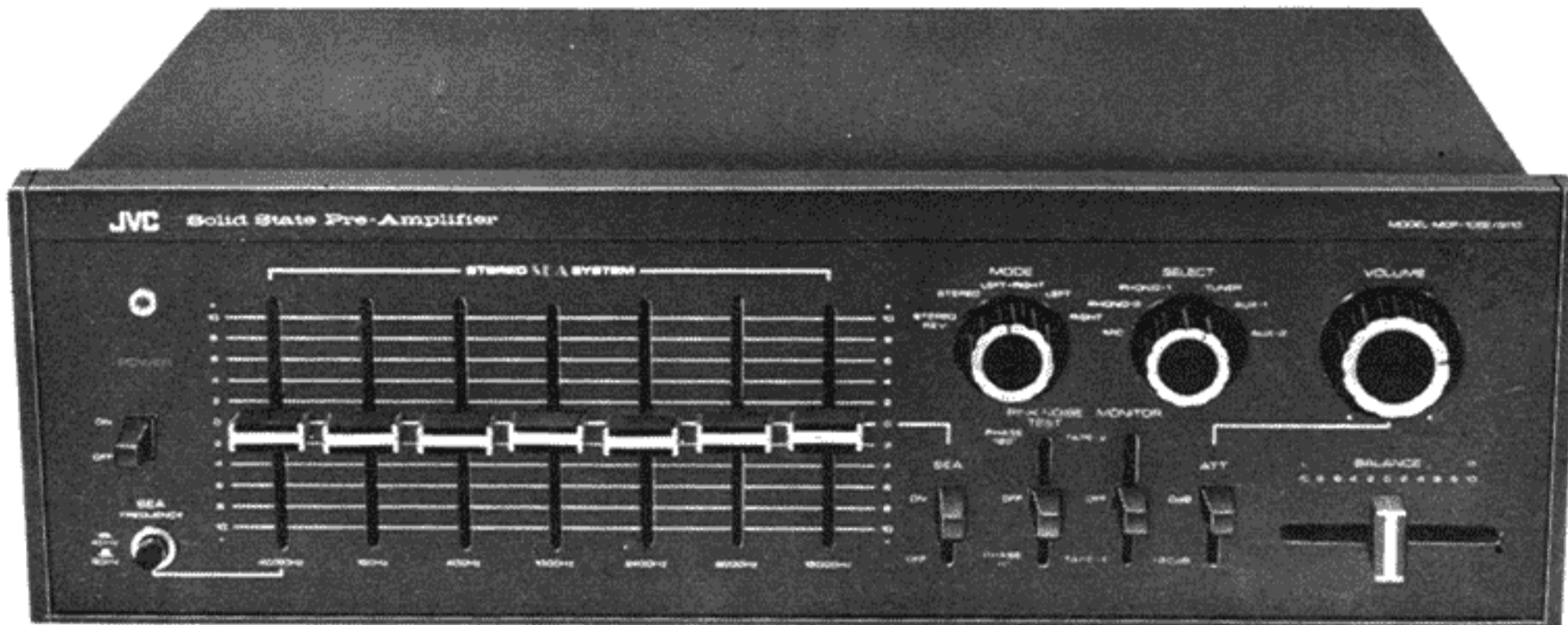

MODEL MCP-105E/5110

SOLIDE STATE STEREO PRE-AMPLIFIER SYSTEM WITH S.E.A.

Dimensions Hight 5-7/16" Width 16-9/16" Depth 11-5/12" Weight 18.7lbs.

SPECIFICATIONS

OUTPUT VOLTAGE	: Pre-out 1V 0.5K Ω 5V 0.5K Ω Max.
OUTPUT IMPEDANCE	: 12K Ω at 300mV. (Pre-out) 80K Ω at 30mV. (DIN)
FREQUENCY RESPONSE	: Phono RIAA within +0.5dB MIC 18Hz Subsonic filter - 50KHz +0.5dB AUX
T.H.D.	: Less than 0.03% at 1KHz, 1V.
I.M.	: Less than 0.1% at 1KHz, 1V.
S/N	: Phono -80db MIC -85dB AUX -100dB.
INPUT IMPEDANCE	: Phono 1.2mV. 50K Ω) MIC 1.2mV (300K Ω) Tape play 120mV (80K Ω) DIN 120mV (80K Ω) AUX 120mV (180K Ω)
S.E.A. CENTOR FREQUENCY	: 40/60Hz, 150Hz, 400Hz, 1KHz, 2.4KHz, 6KHz, 15KHz.
S.E.A. CONTROL RANGE	: +10dB.
POWER SOURCE	: 100, 120, 220, 240V Selectable. 50/60Hz.
POWER CONSUMPTION	: 4.5W

MAIN PARTS ARRANGEMENT

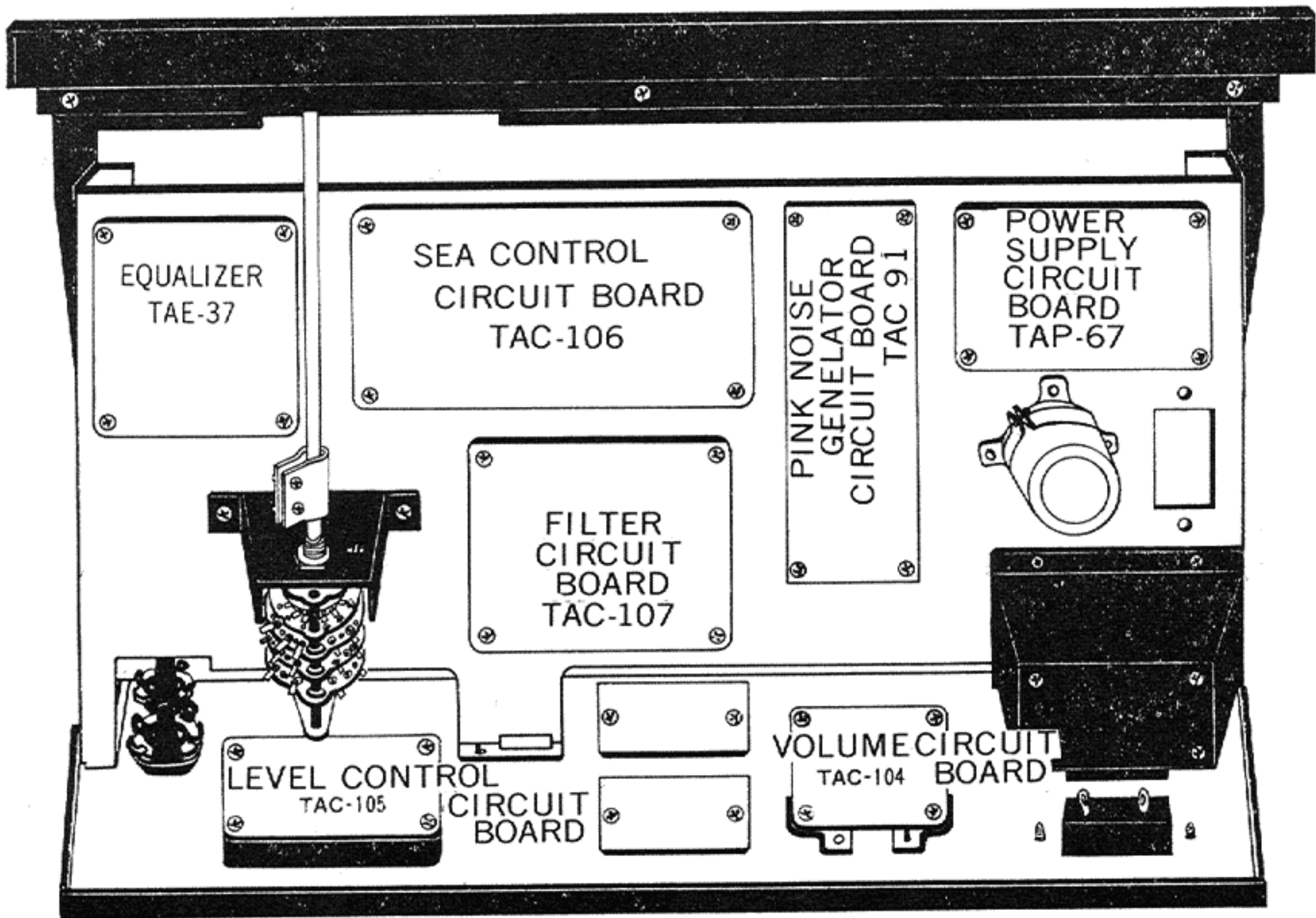

Fig. 1

SWITCH CIRCUIT

Push switch Power switch

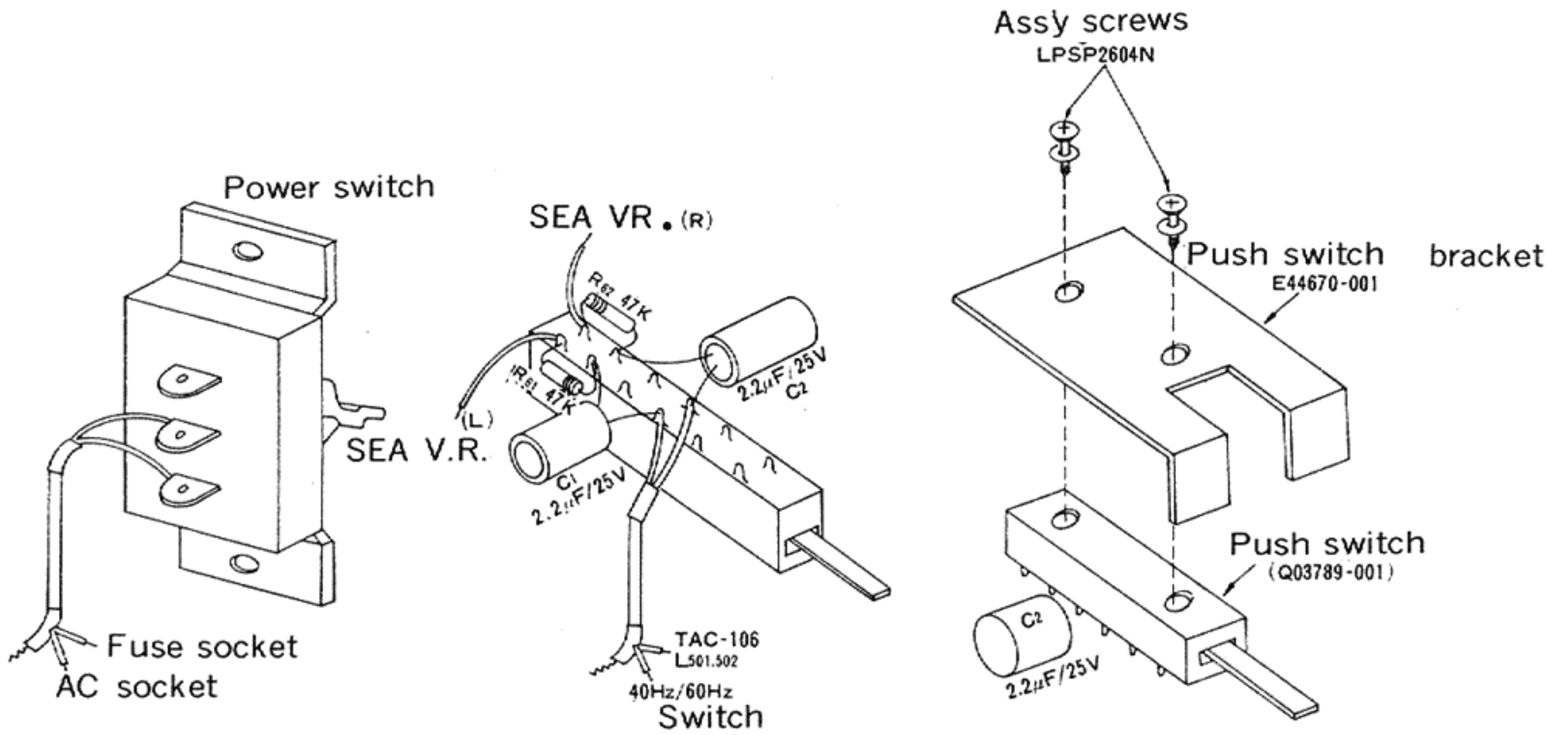

Fig. 2

SEA SELECT SWITCH

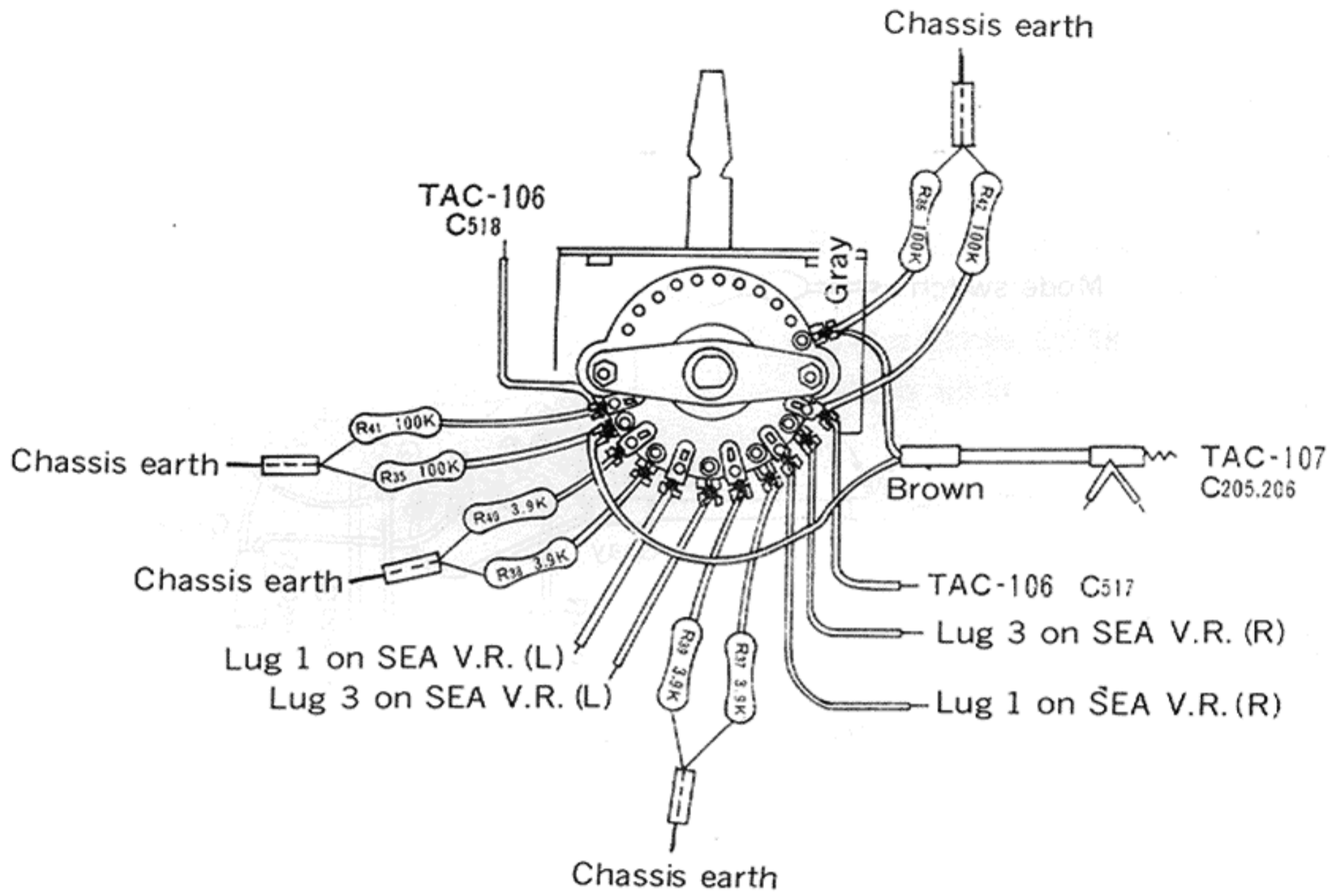

Fig. 3

PINK NOISE SELECT SWITCH

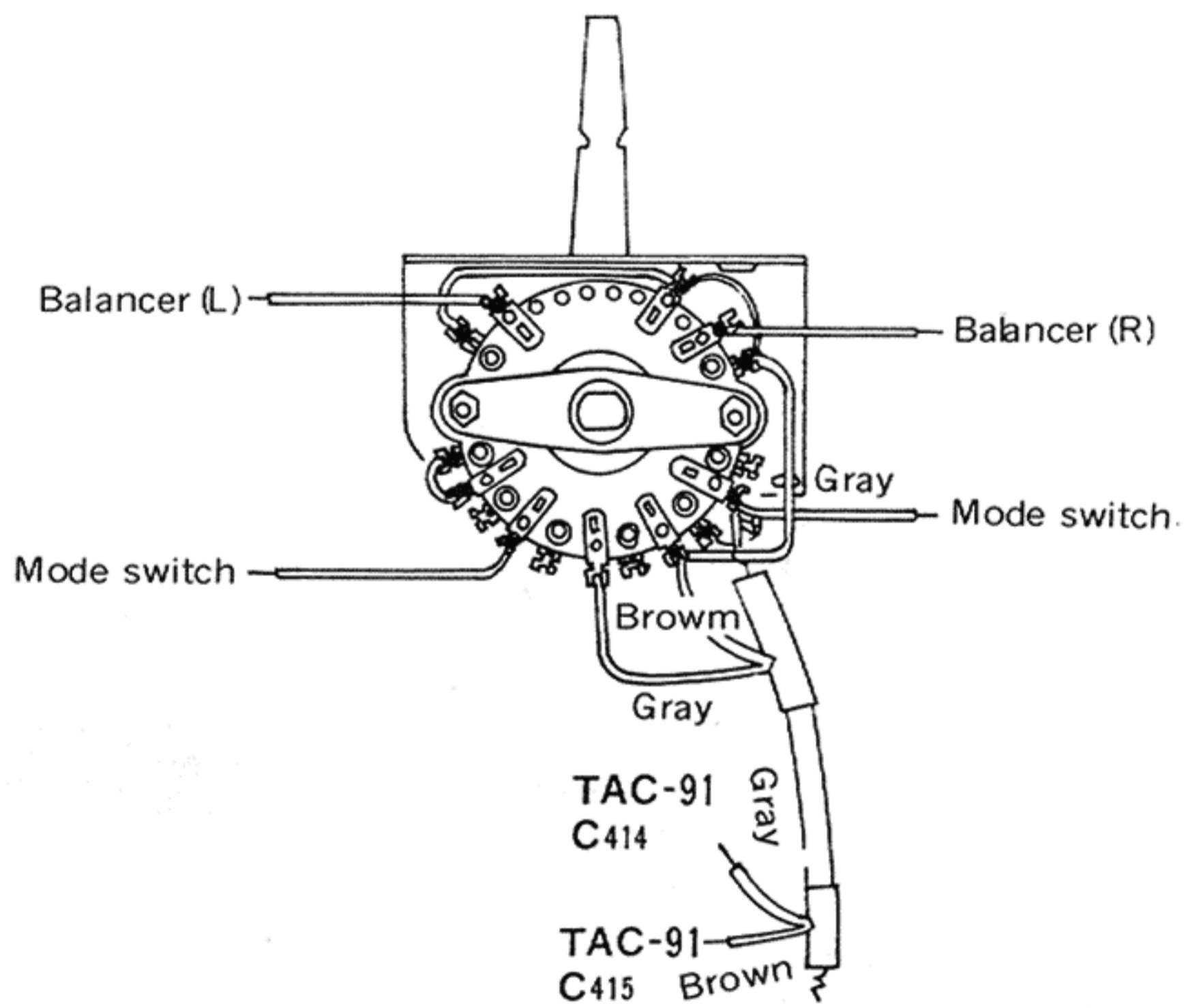

Fig. 6

Fig. 4

TAPE MONITOR SELECT SWITCH

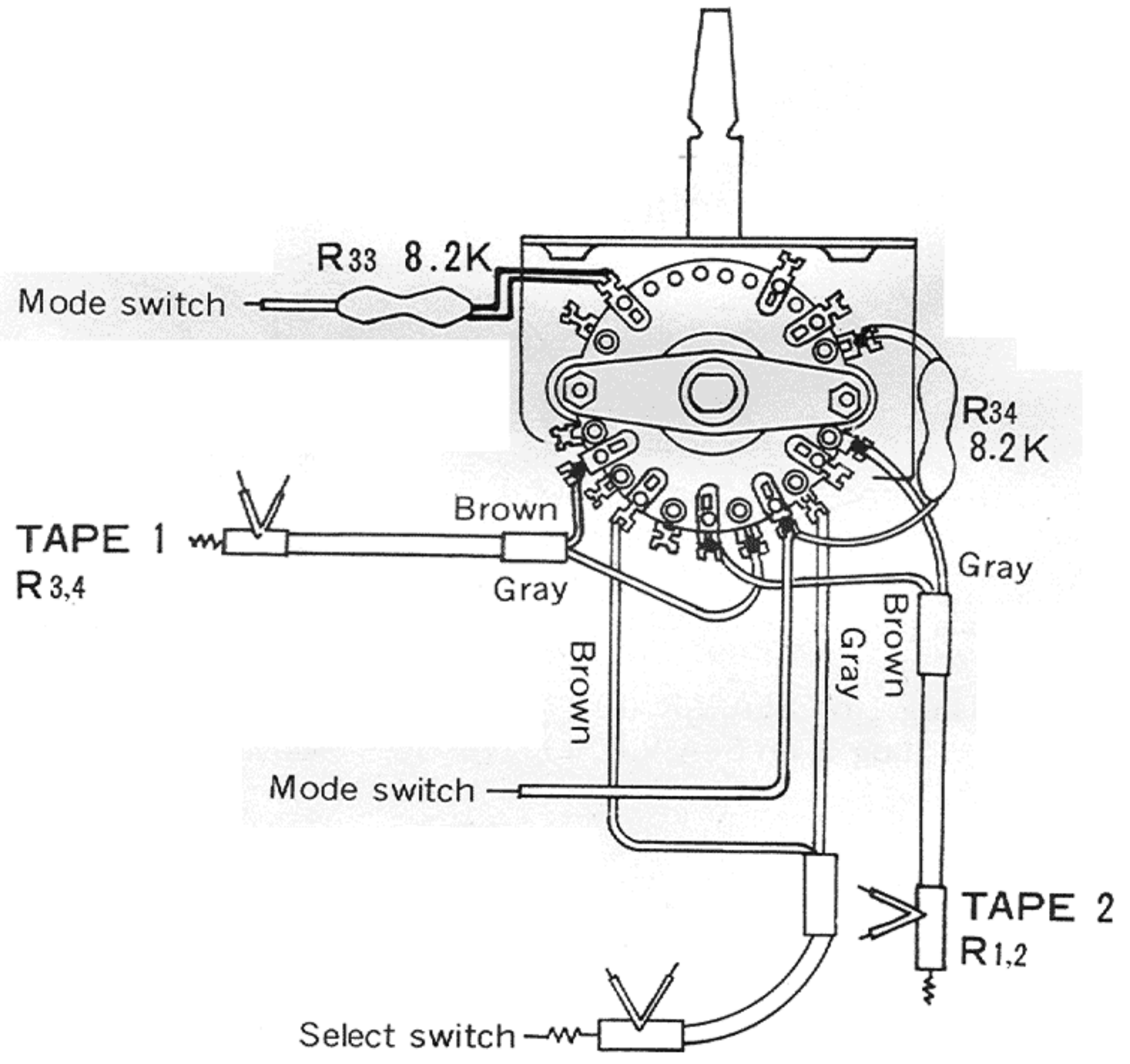

Fig. 5

ATTENUATER SELECT SWITCH

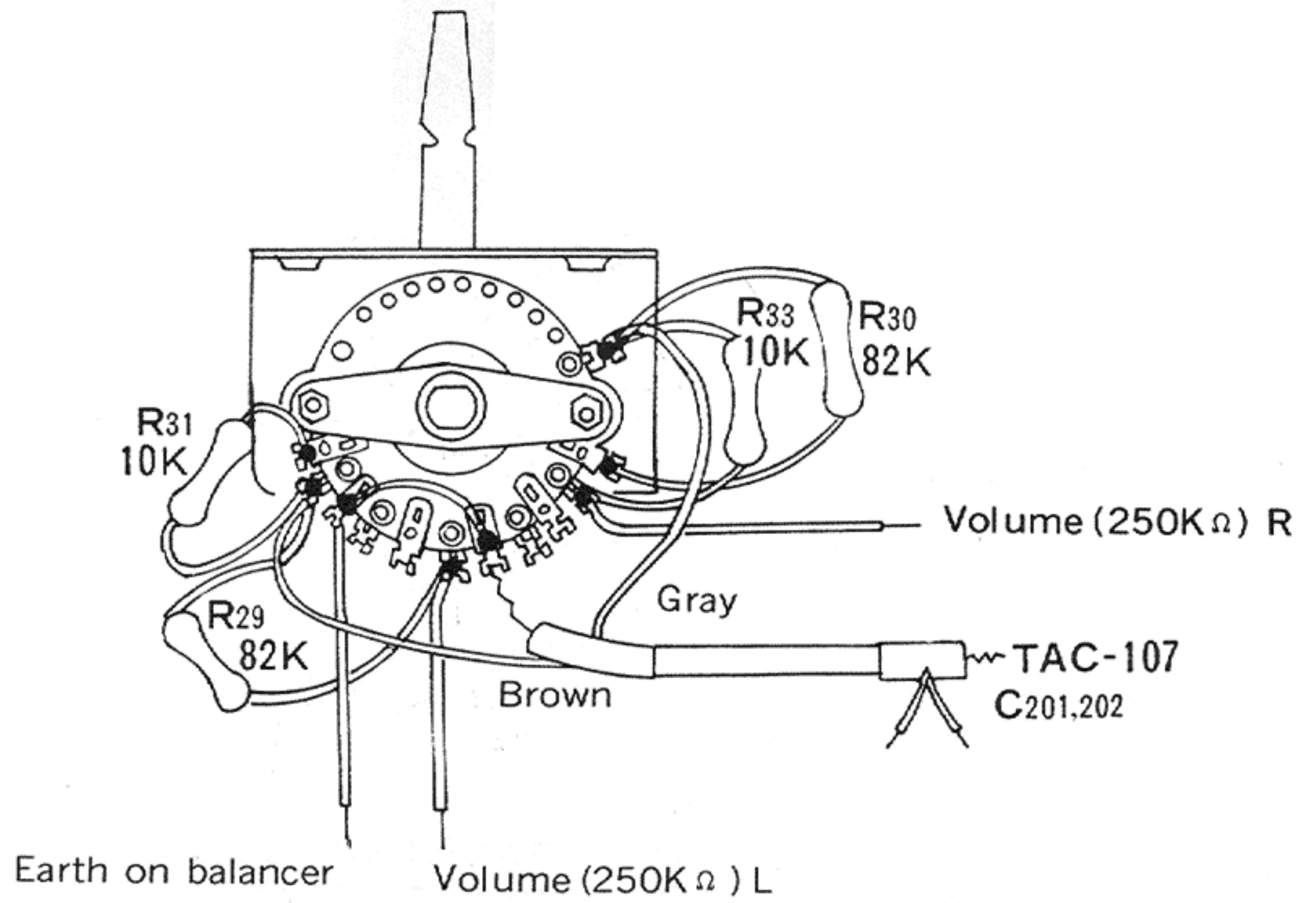

Fig. 6

SELECT SWITCH

JOHN W. PETERSON, JR. U.S. PATENT OFFICE

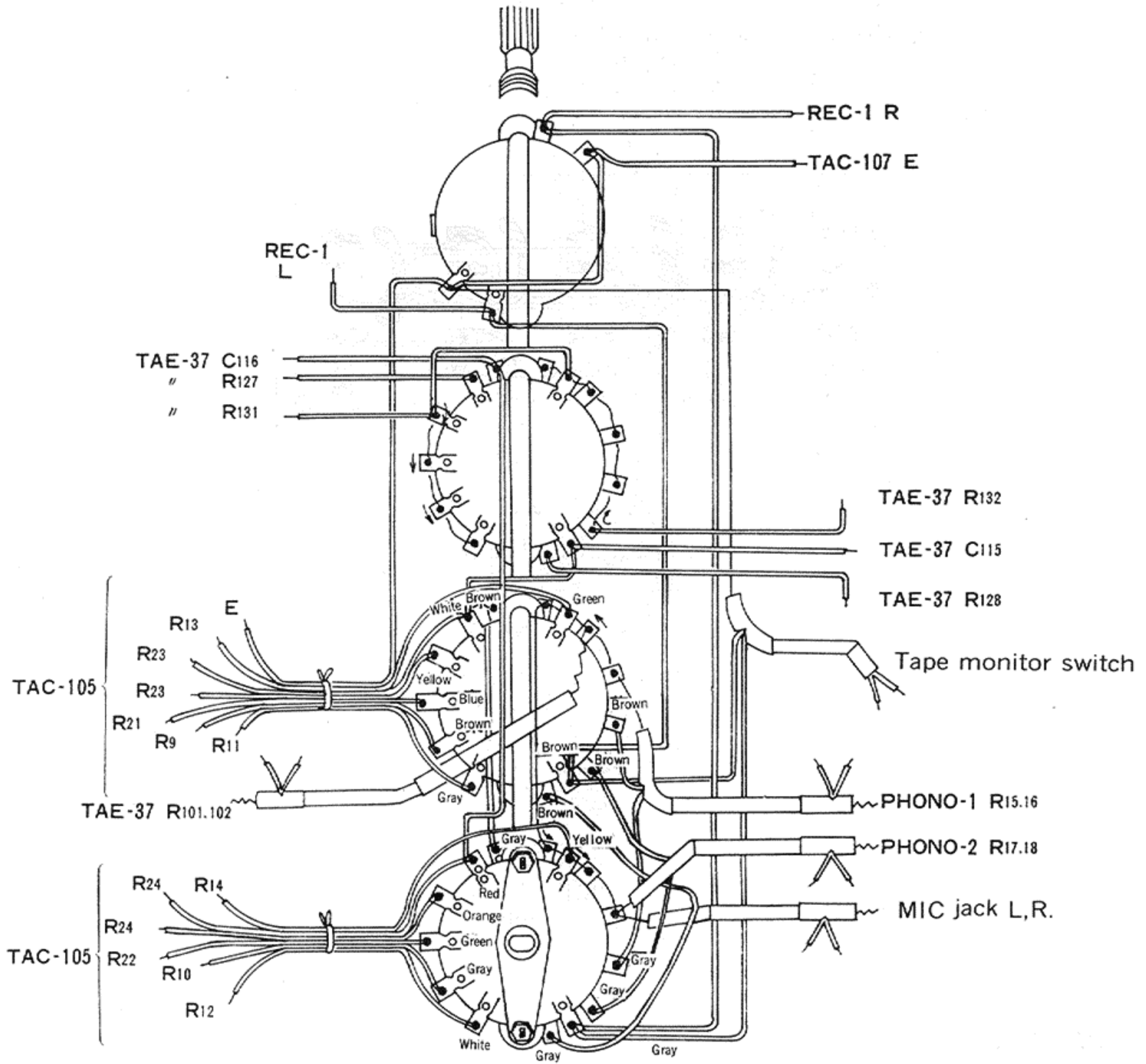

Fig. 7

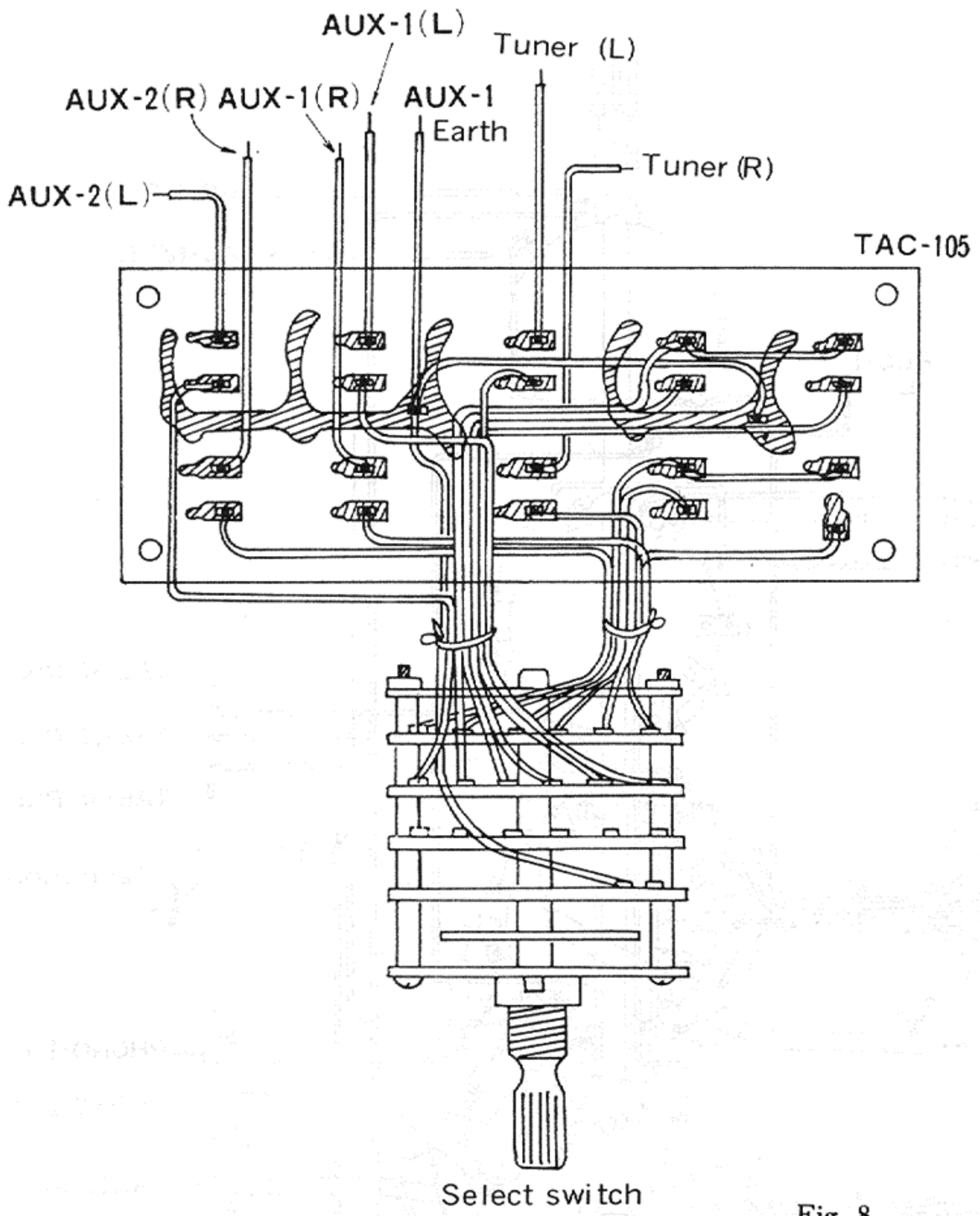

Fig. 8

MODE SWITCH

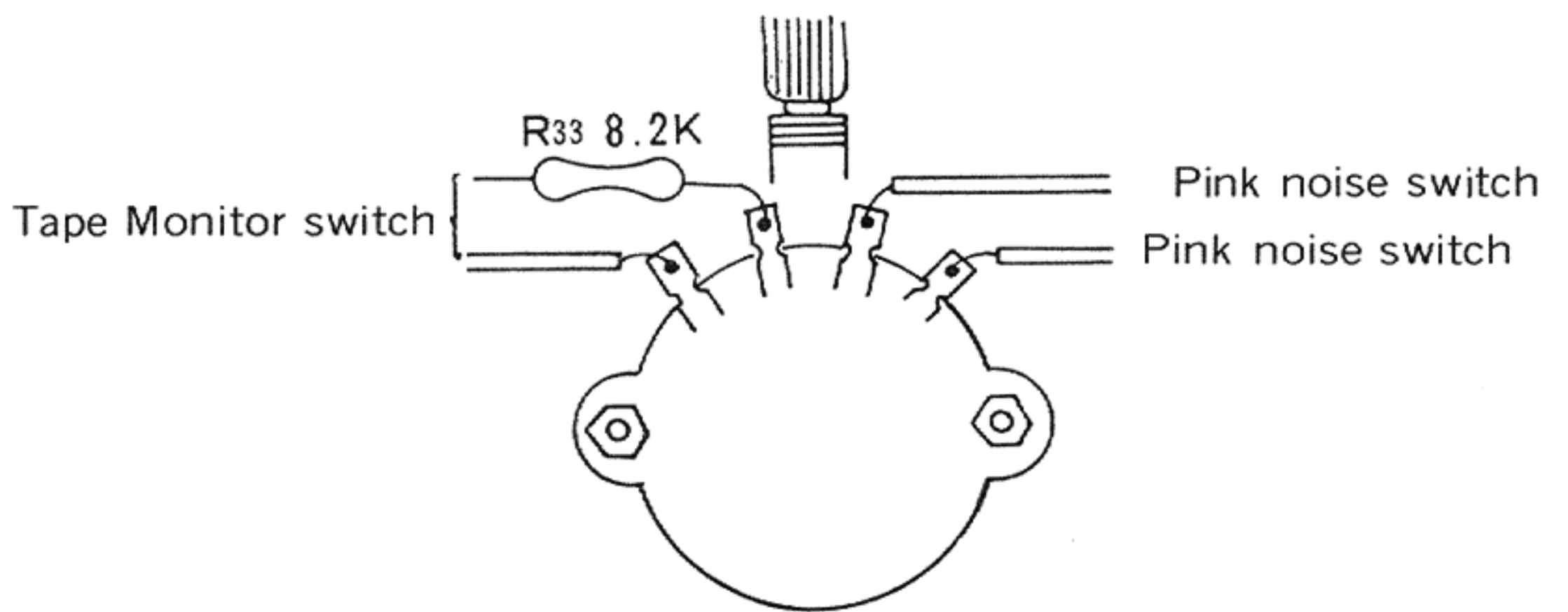

Fig. 9

EQUALIZER CIRCUIT BOARD ASS'Y (TOP VIEW)

TAE-37

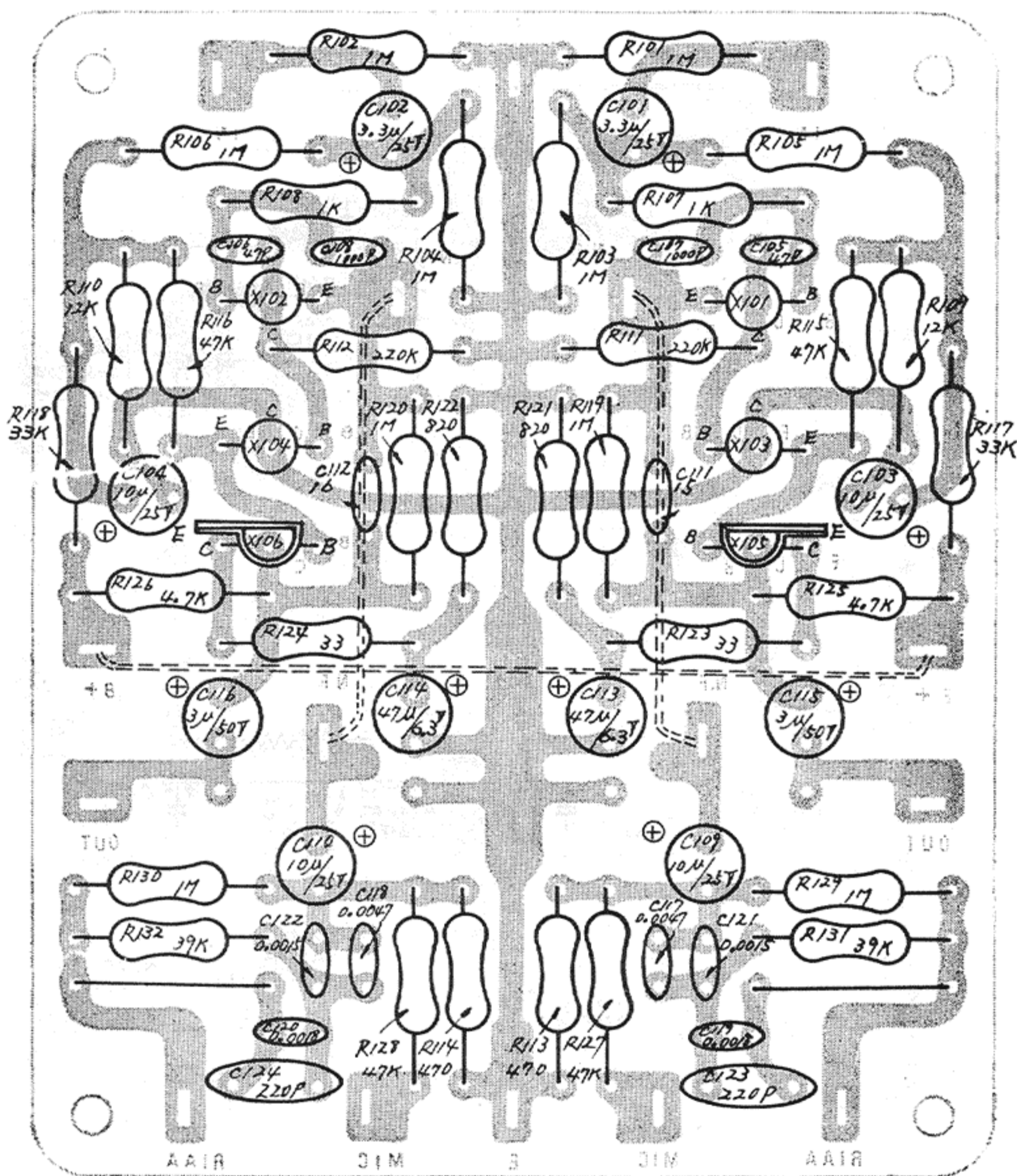

Fig. 10

FILTER CIRCUIT BOARD ASS'Y (BACK VIEW)

TAE-37

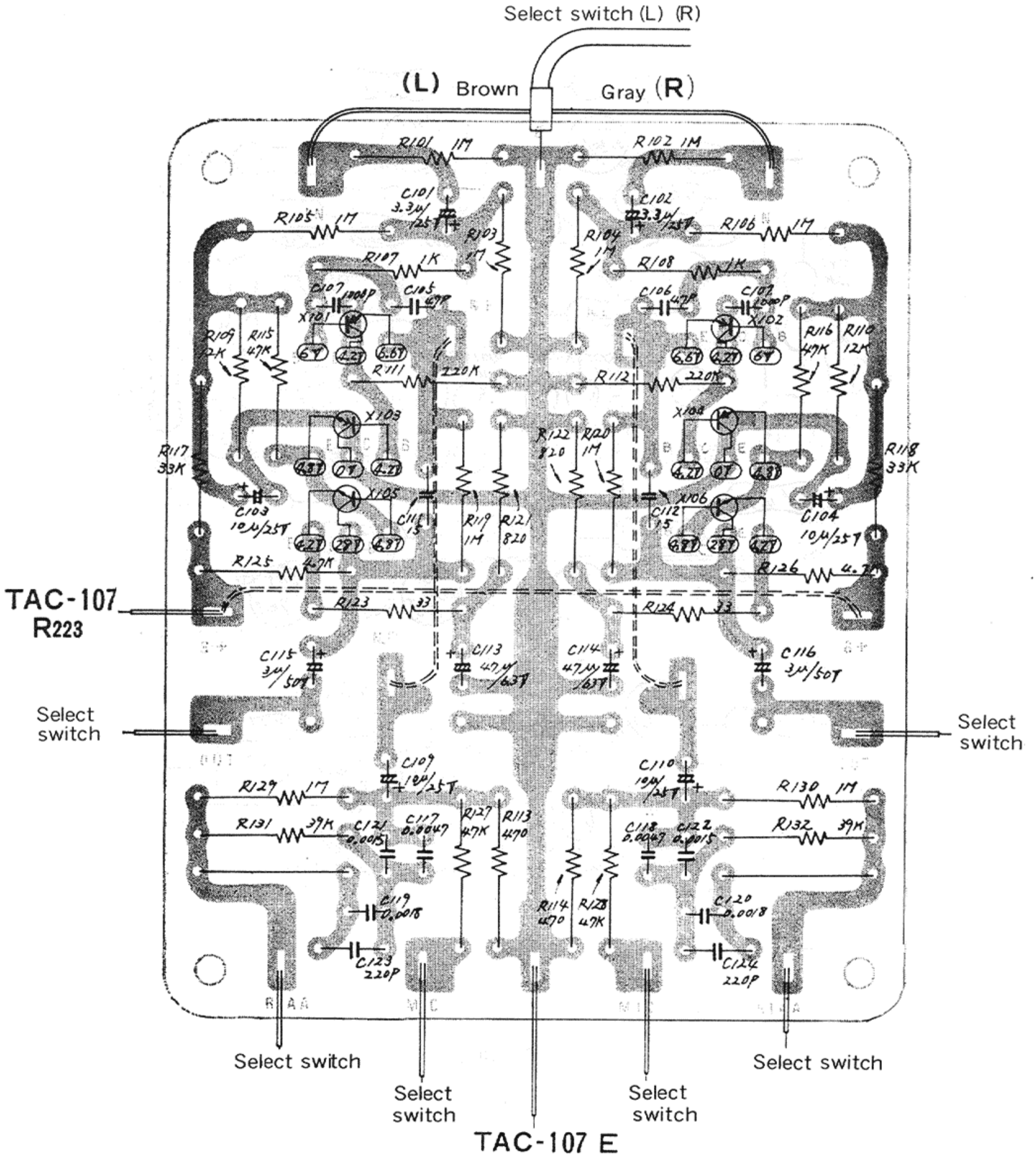

Fig. 11

PINK NOISE GENERATOR CIRCUIT BOARD (TOP VIEW)

TAC-91

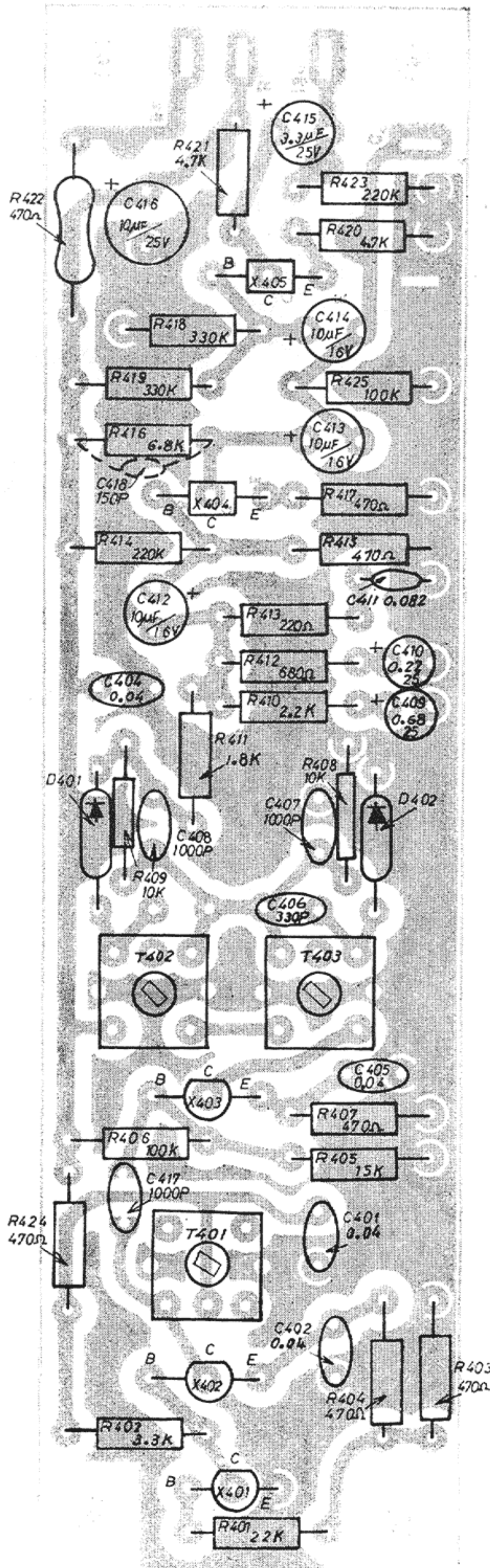

Fig. 12

PINK NOISE GENERATOR CIRCUIT BOARD (BOTTOM VIEW)

TAC-91

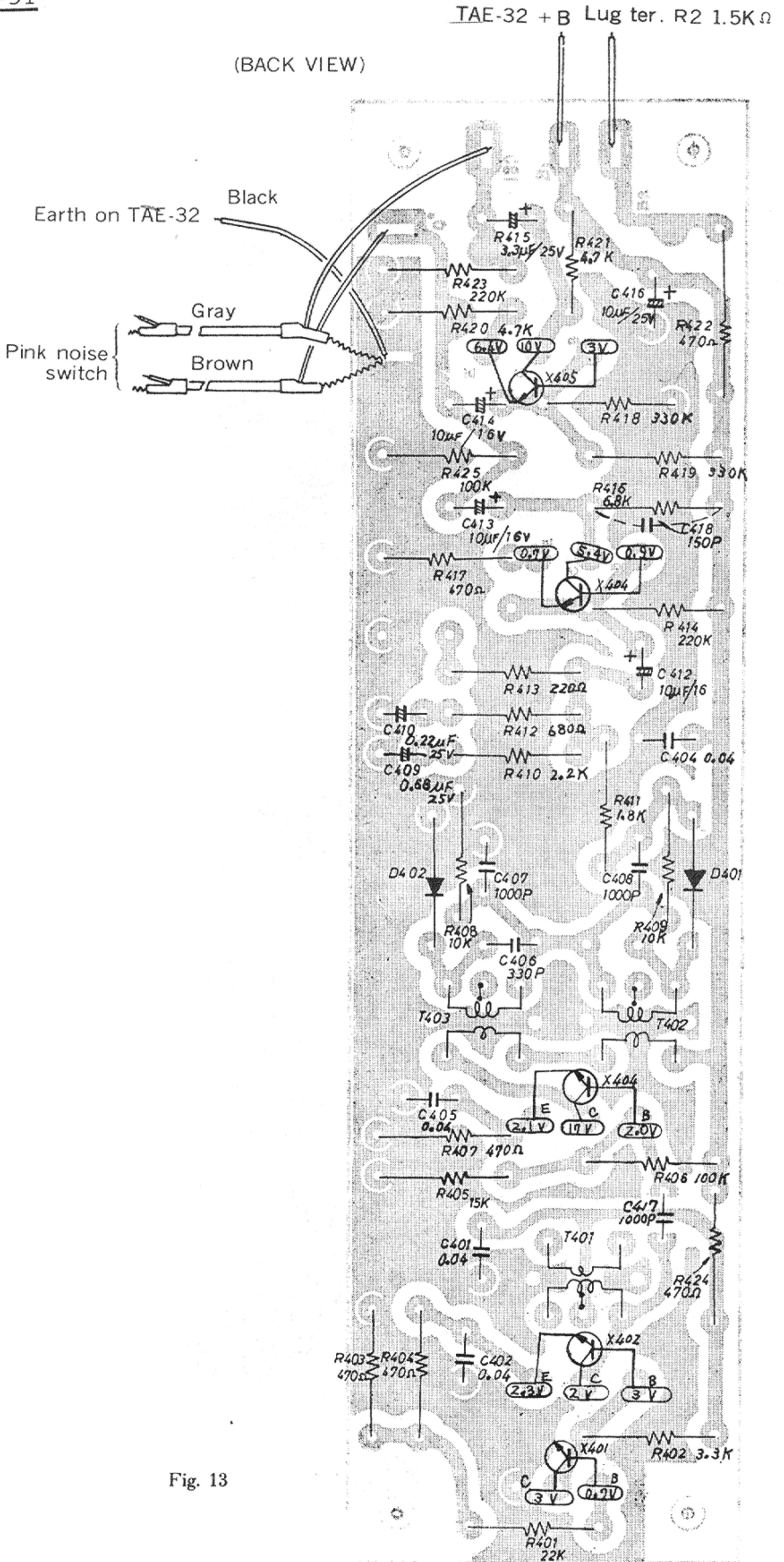

Fig. 13

SEA CONTROL CIRCUIT BOARD ASS'Y (TOP VIEW)

TAC-106

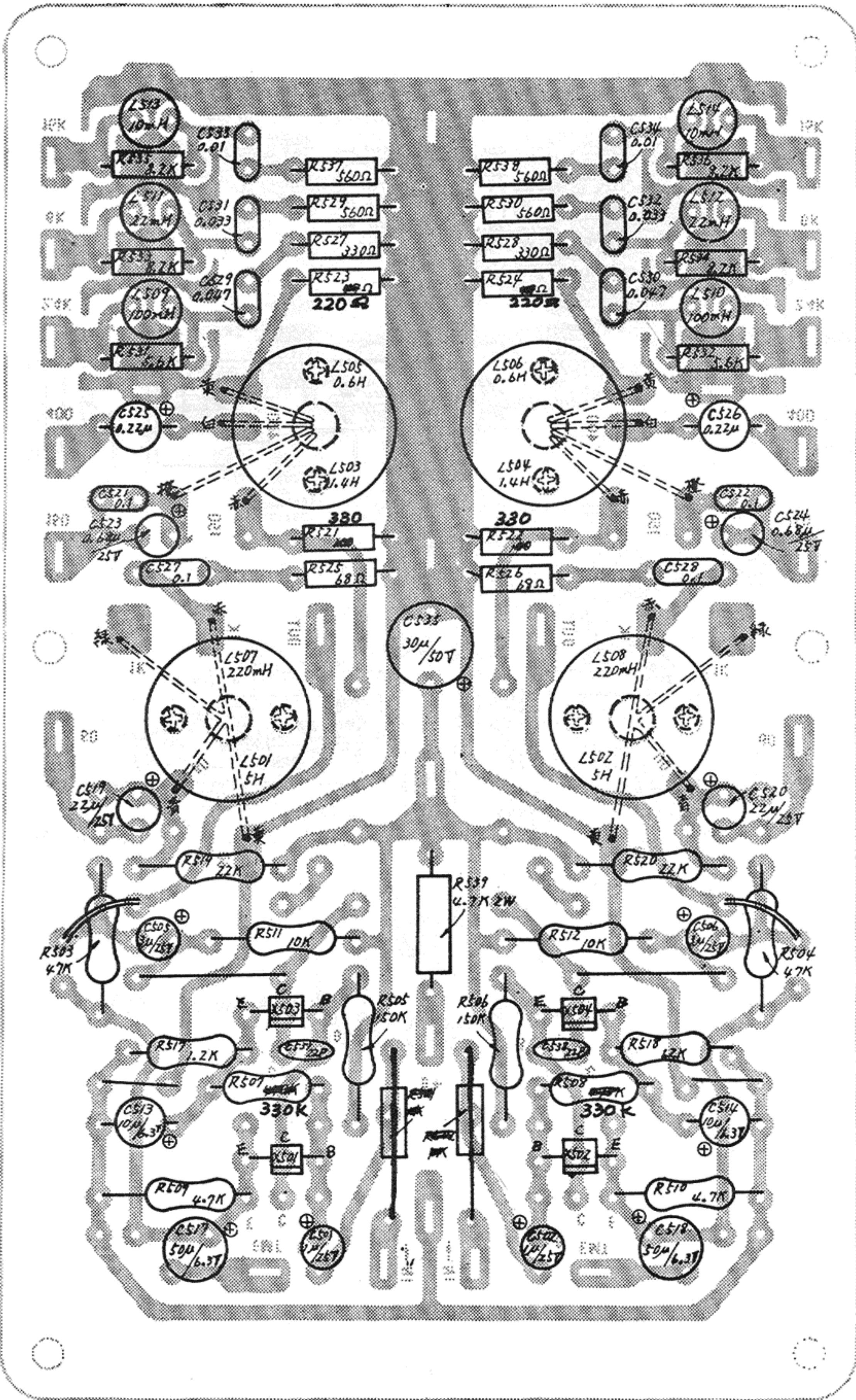

Fig. 14

SEA CONTROL CIRCUIT BOARD ASS'Y (BACK VIEW)

TAC-106

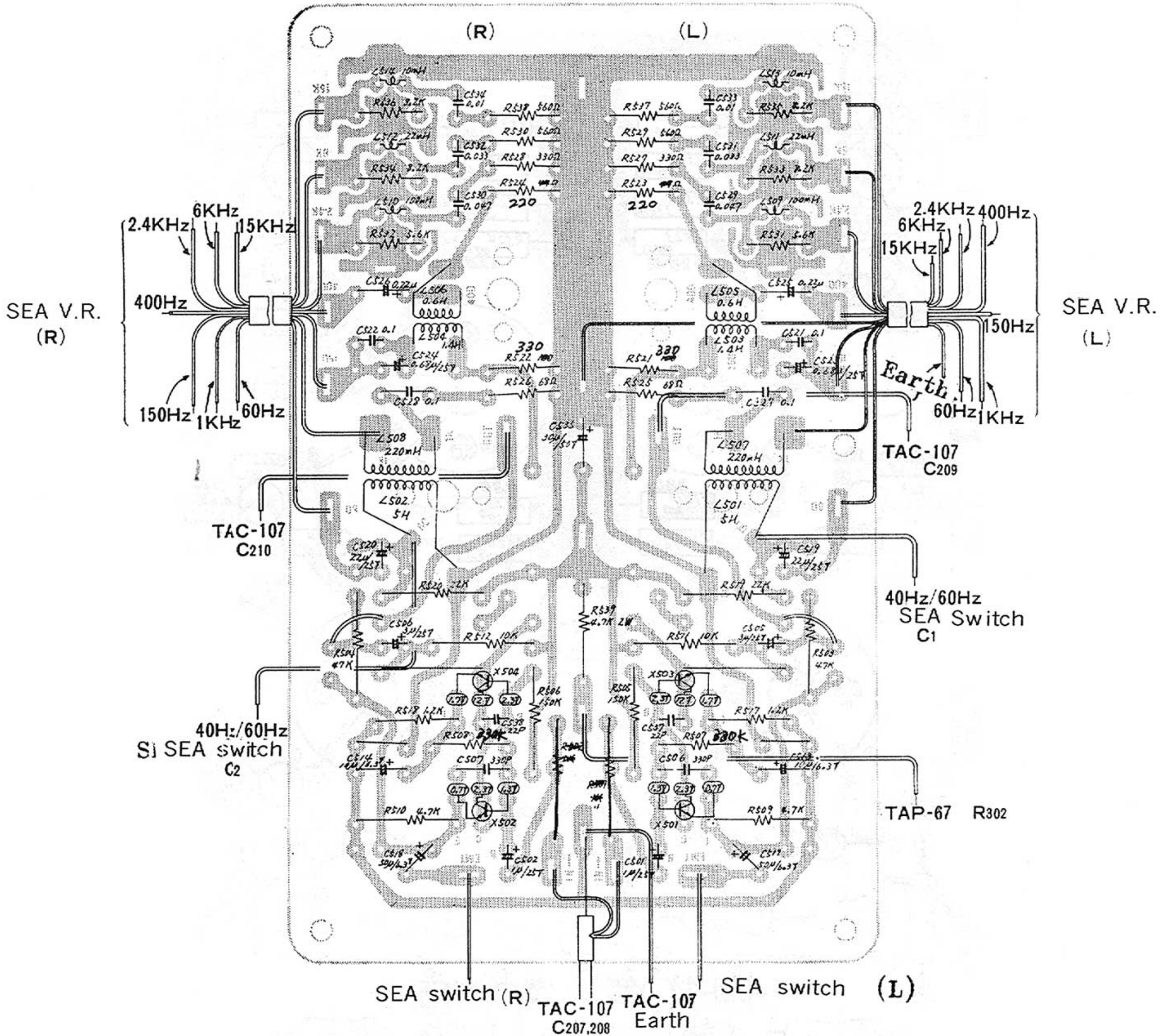

Fig. 15

FILTER CIRCUIT BOARD ASS'Y (TOP VIEW)

TAC-107

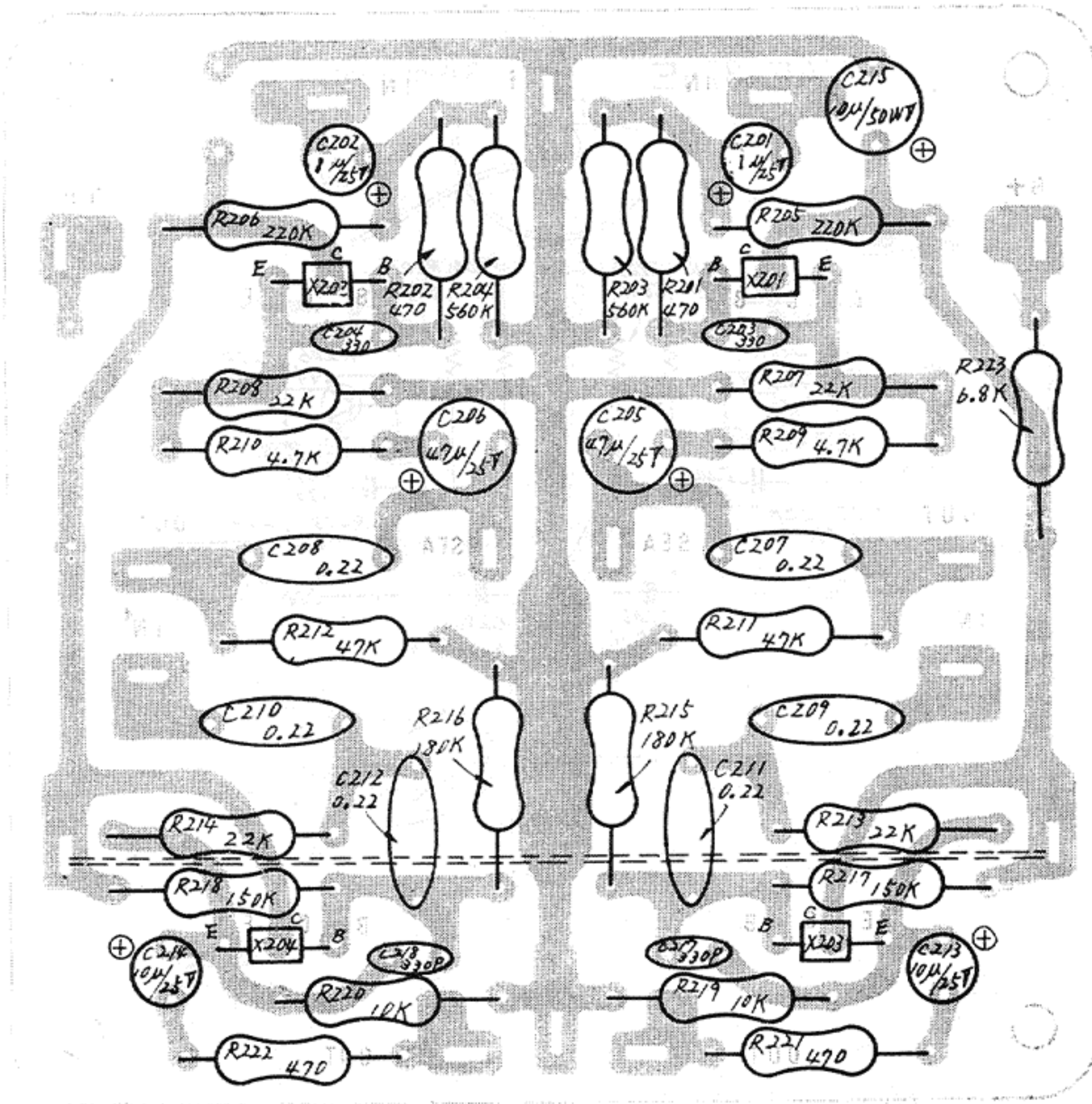

Fig. 16

FILTER CIRCUIT BOARD ASS'Y (BACK VIEW)

TAC-107

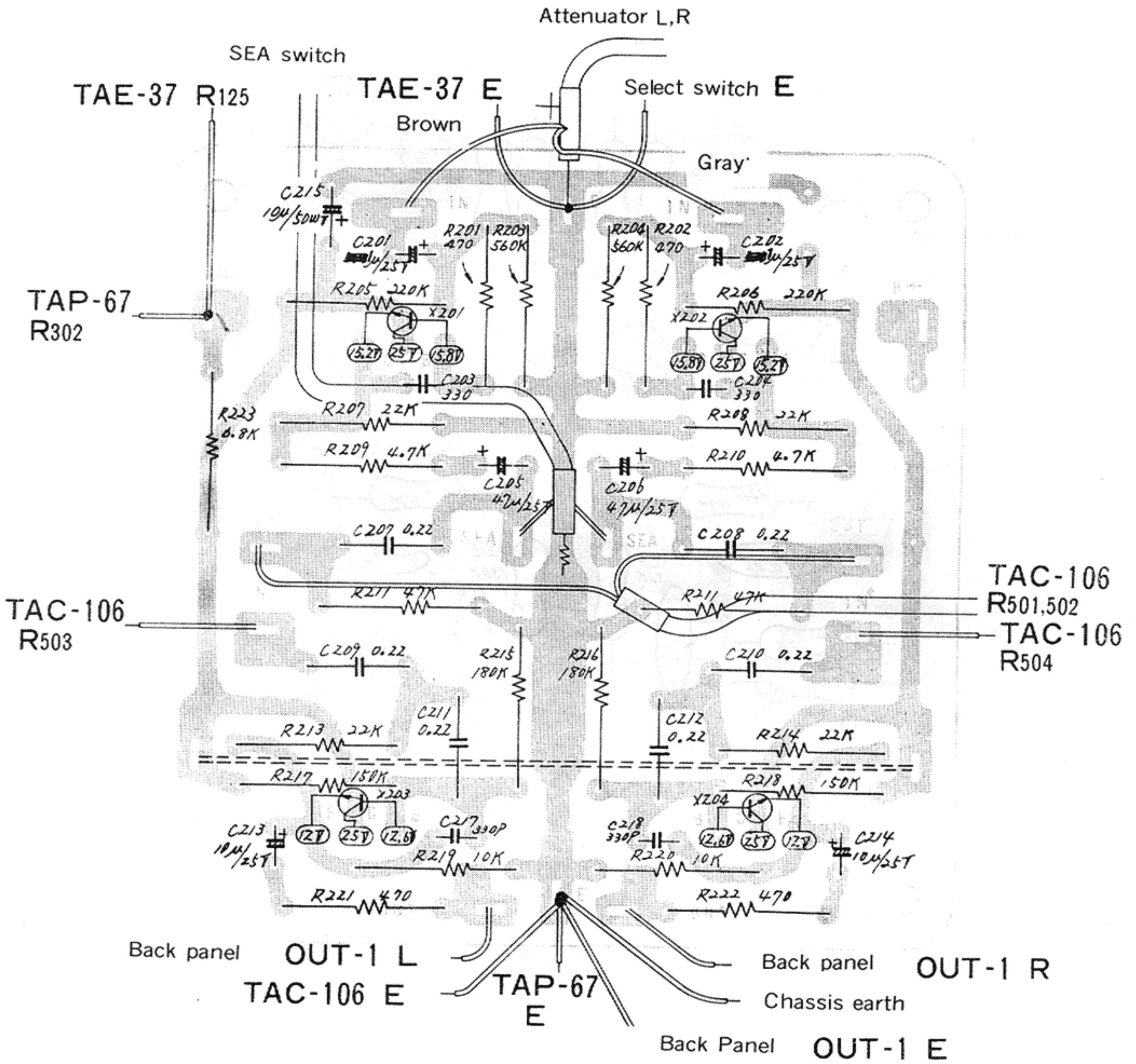

Fig. 17

LEVEL CONTROL CIRCUIT BOARD ASS'Y (TOP VIEW)

TAC-105

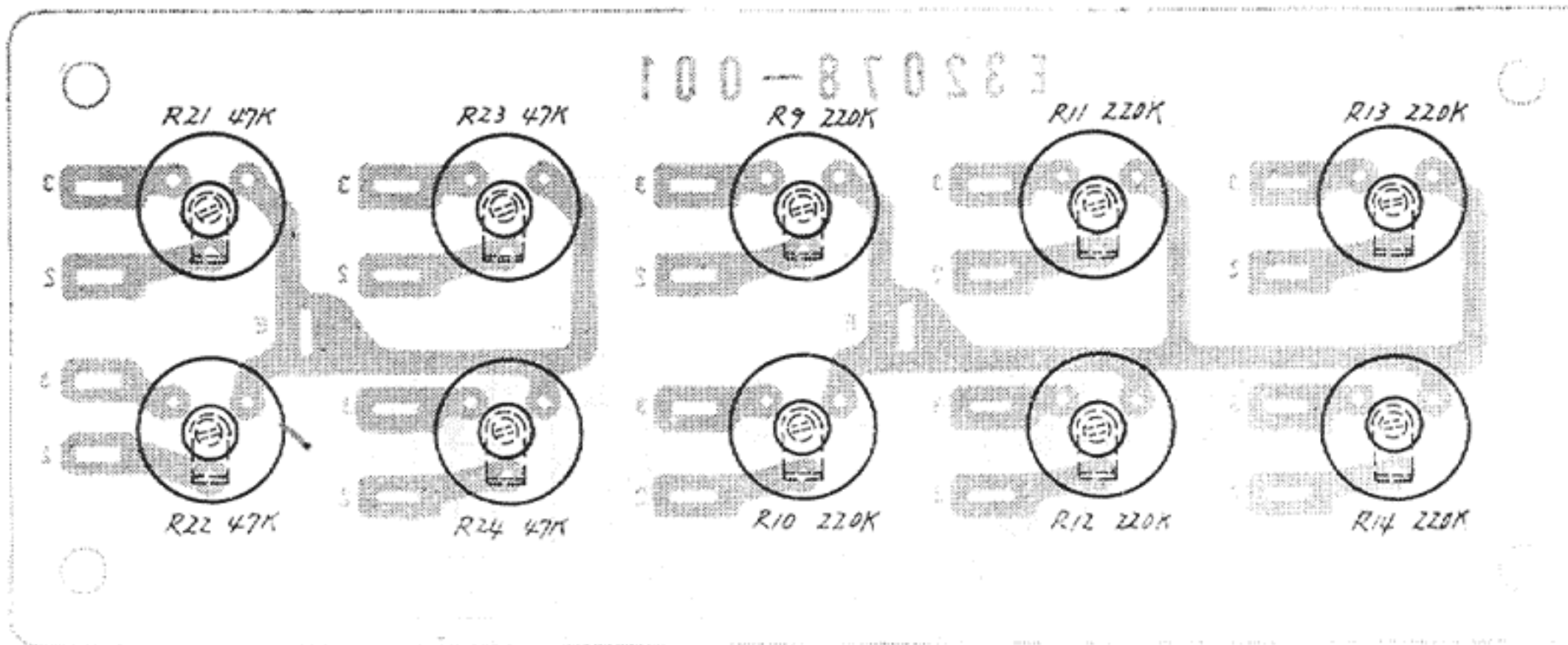

Fig. 18

LEVEL CONTROL CIRCUIT BOARD ASS'Y (BACK VIEW)

TAC-105

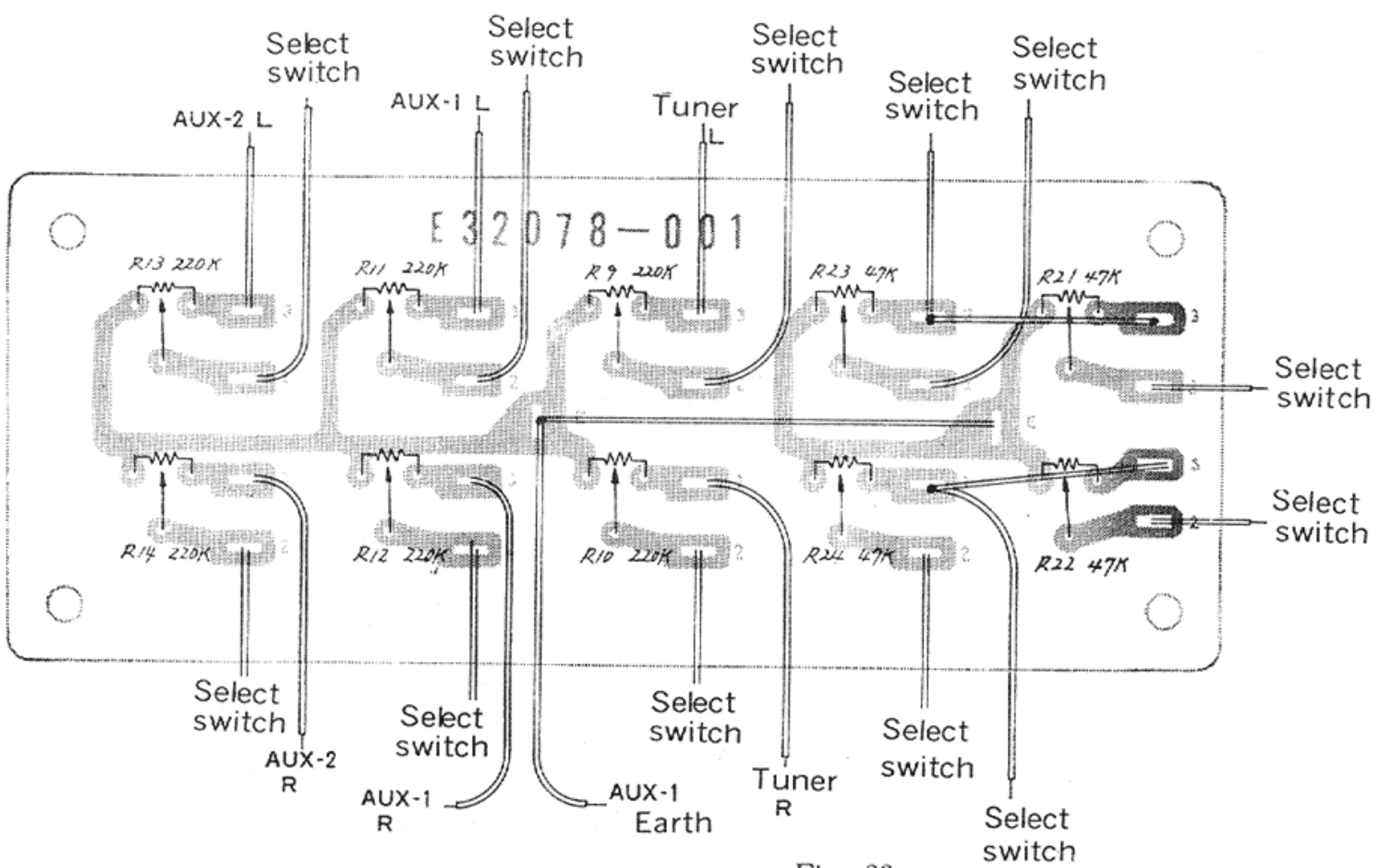

Fig. 23

Fig. 19

POWER SUPPLY CIRCUIT BOARD (TOP VIEW)

TAP-67B

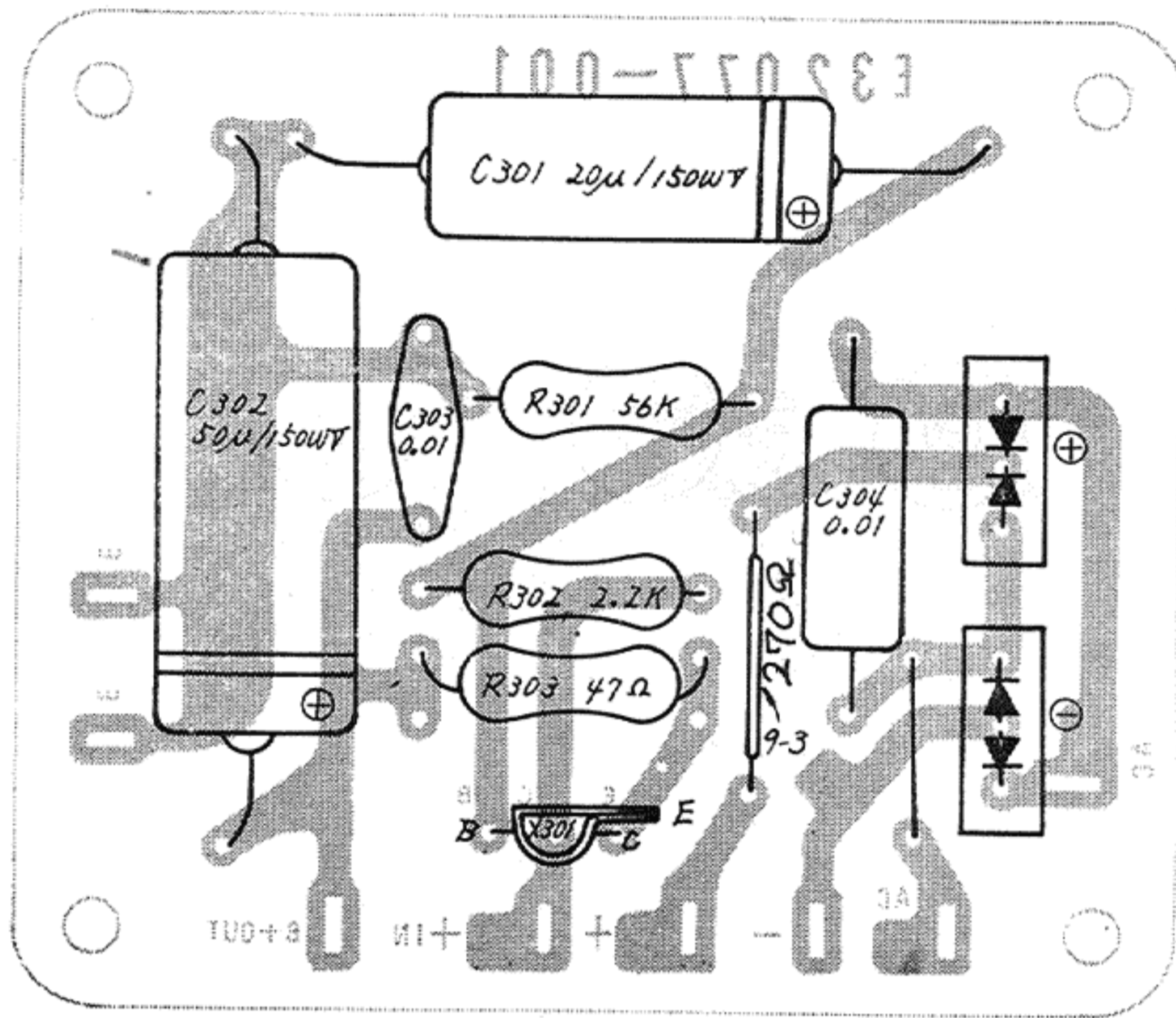

Fig. 20

POWER SUPPLY CIRCUIT BOARD (BACK VIEW)

TAP-67B

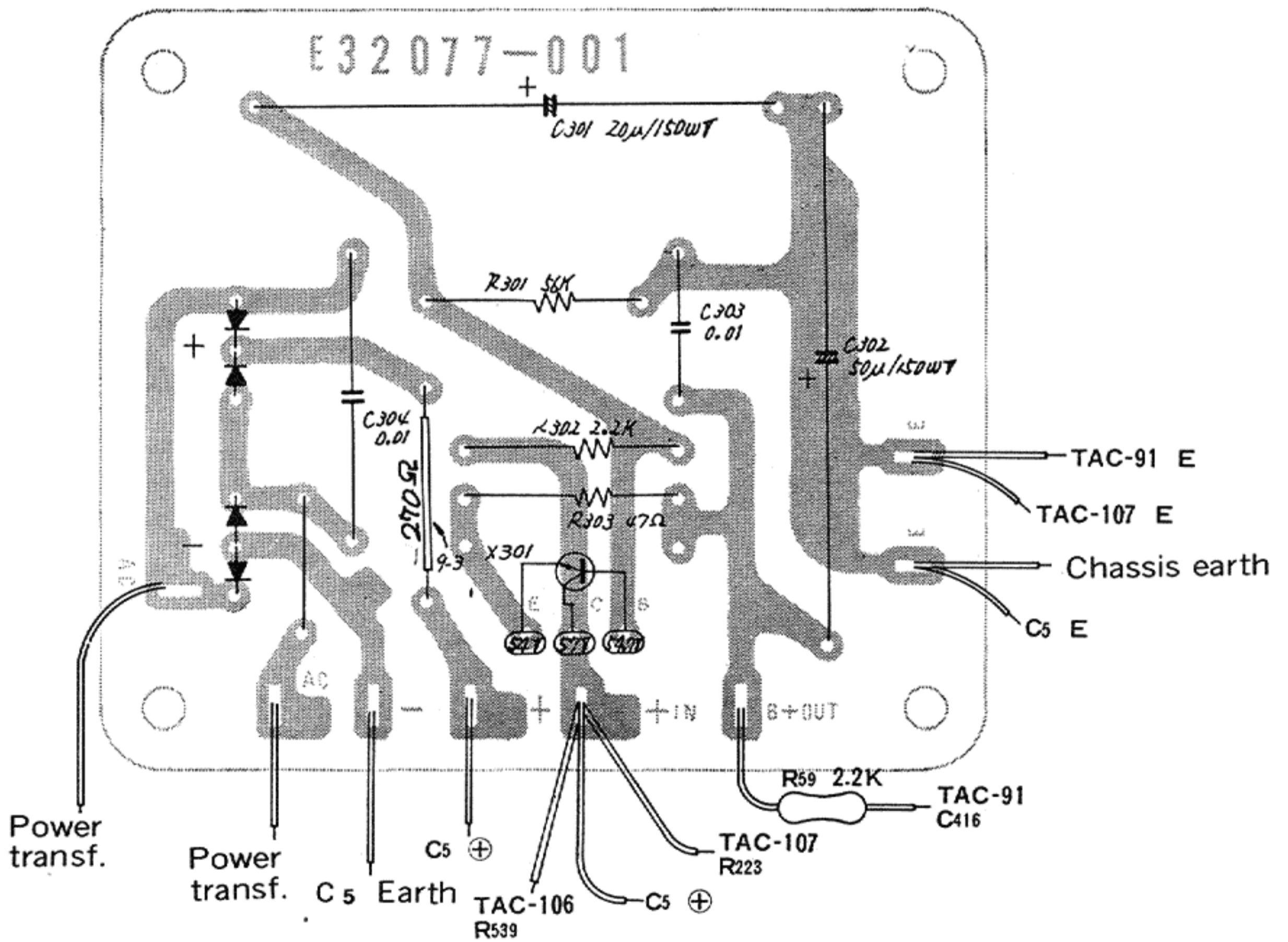

Fig. 21

VOLUME CIRCUIT BOARD ASS'Y (TOP VIEW)

TAC-104

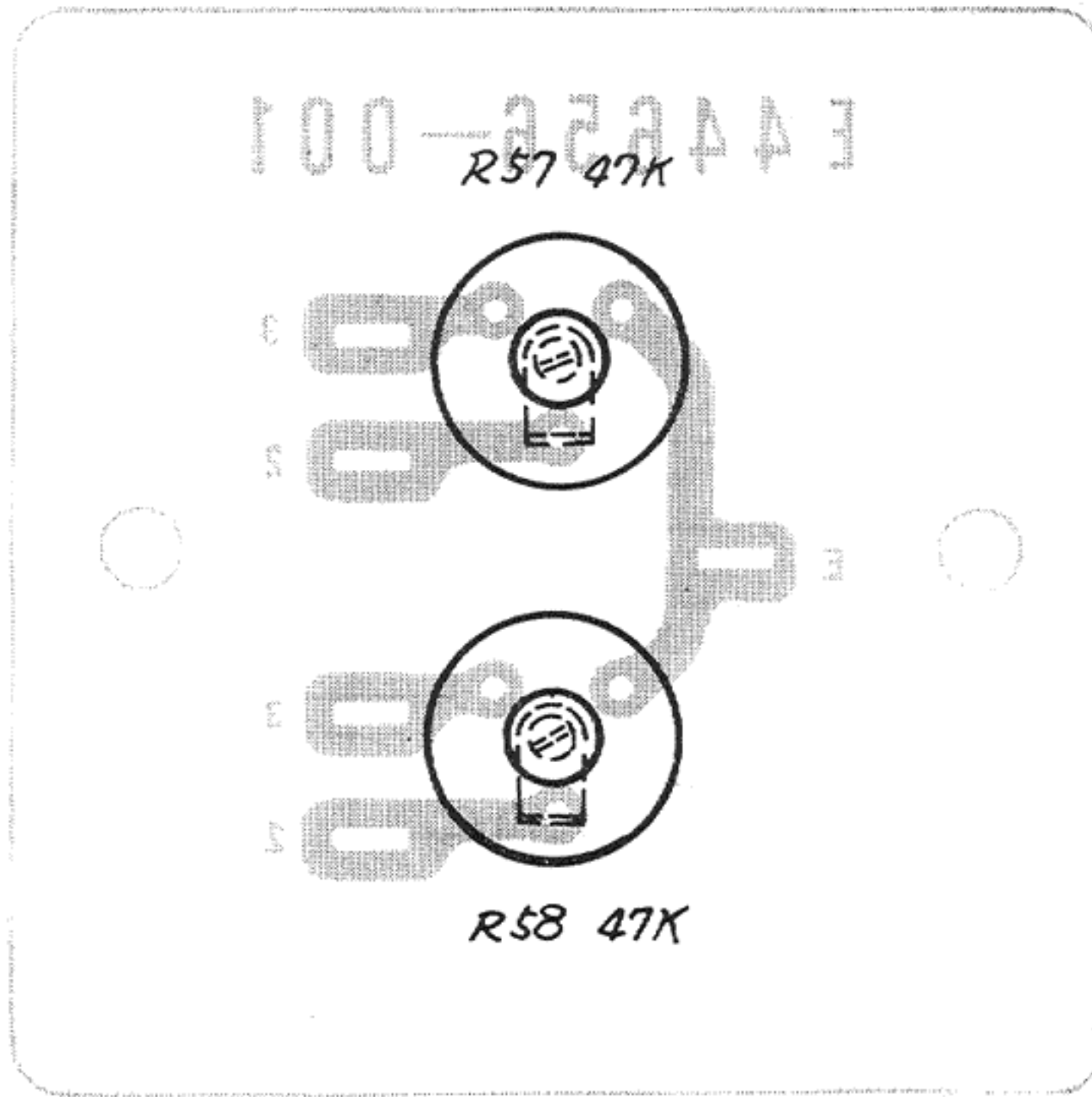

Fig. 22

VOLUME CIRCUIT BOARD ASS'Y (BACK VIEW)

TAC-104

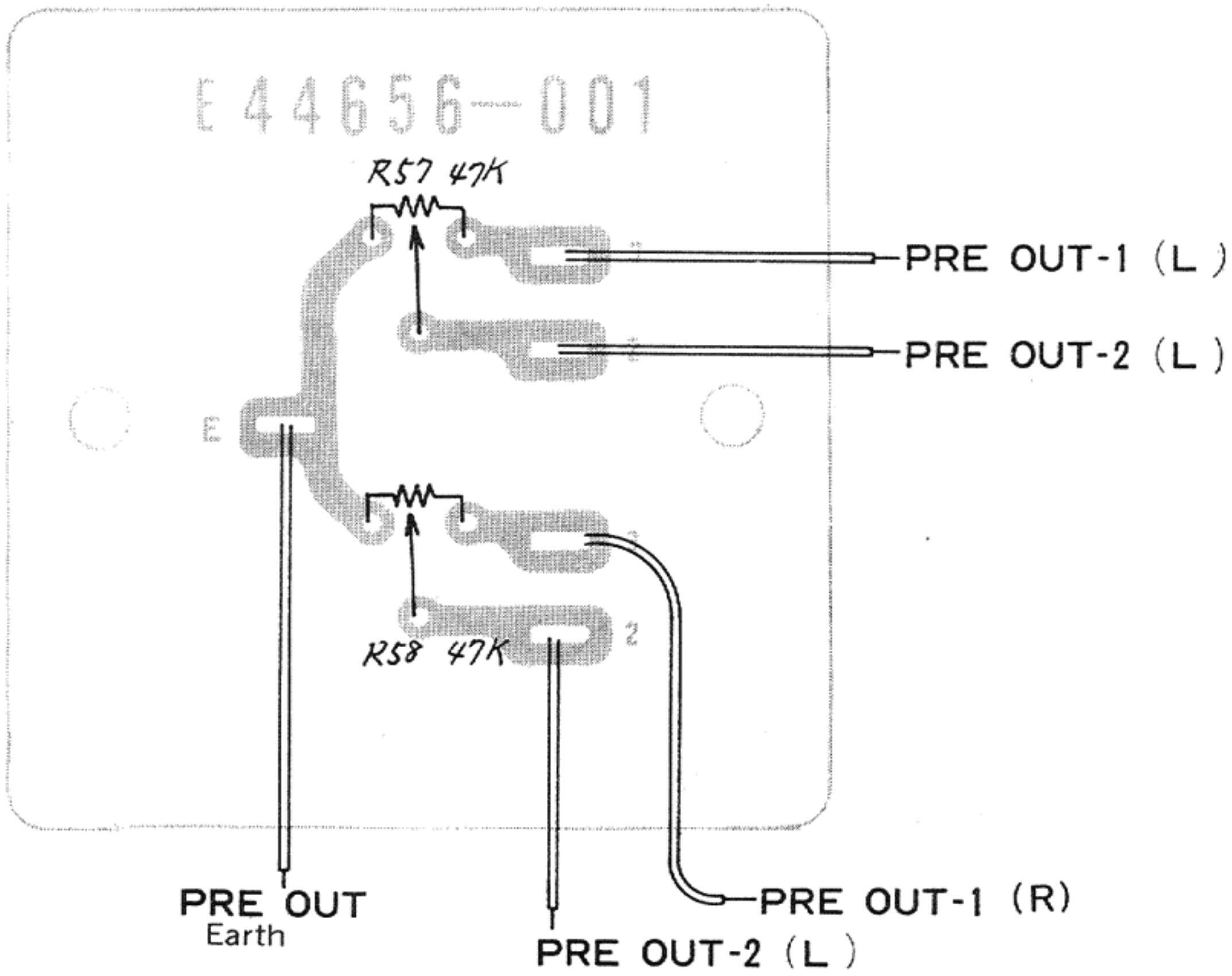

Fig. 23

ACCESSORIES

E30580-219A	Inst. Book	1.
E61101-001	Polishing Cloth	1.
E64208-001	Envelope	1.
04112-0.8	Fuse	1.
04112-0.5	Fuse	1.

PACKING ILLUSTRATION

PARTS NO.	PARTS NAME
MCP-105E-PK	CARTON BOX
MCP-105E-NZ	PACKING MATERIALS
E64204-062	ENVELOPE

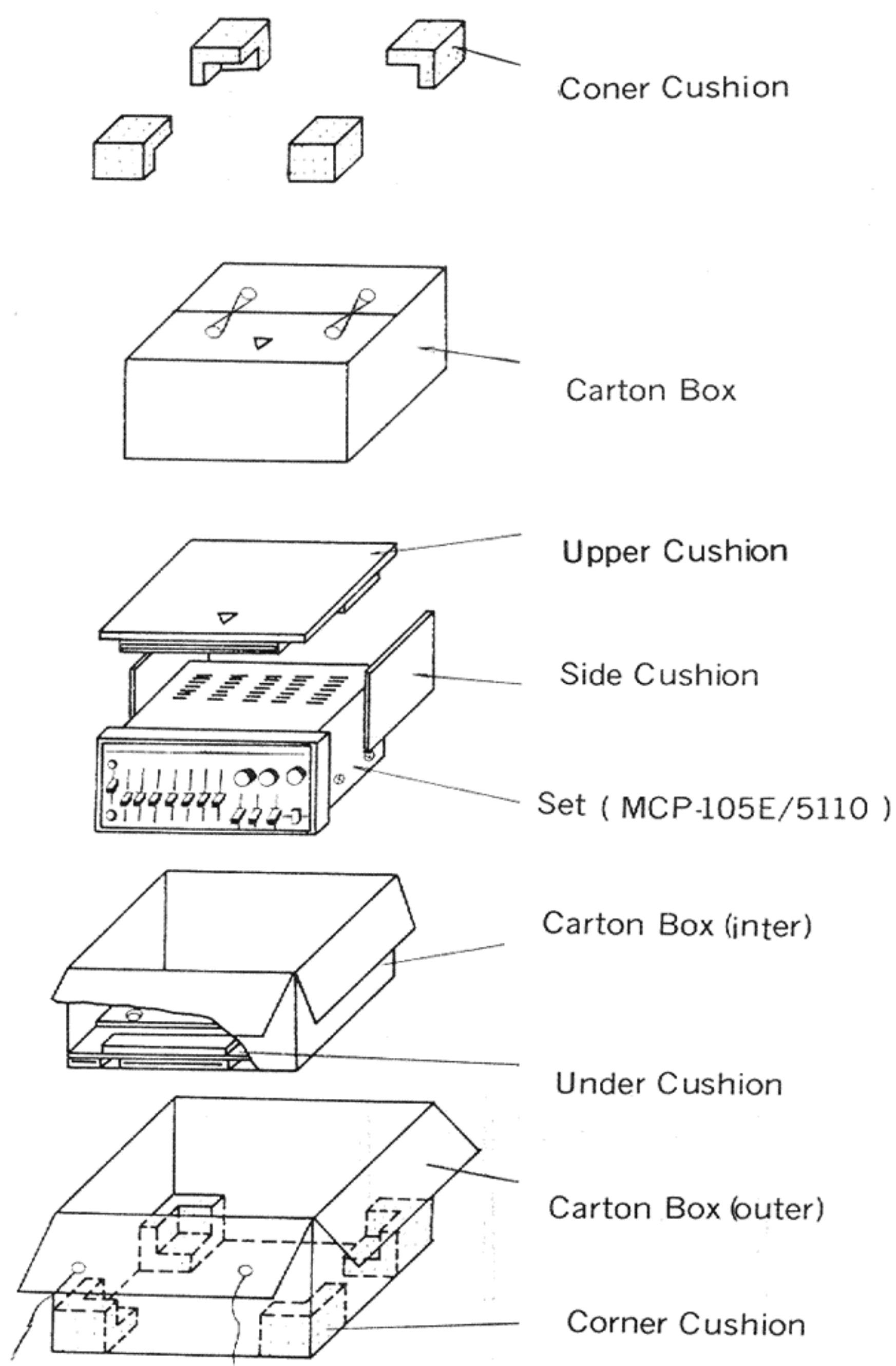

Fig. 24

POWER TRANSFORMER CONNECTION

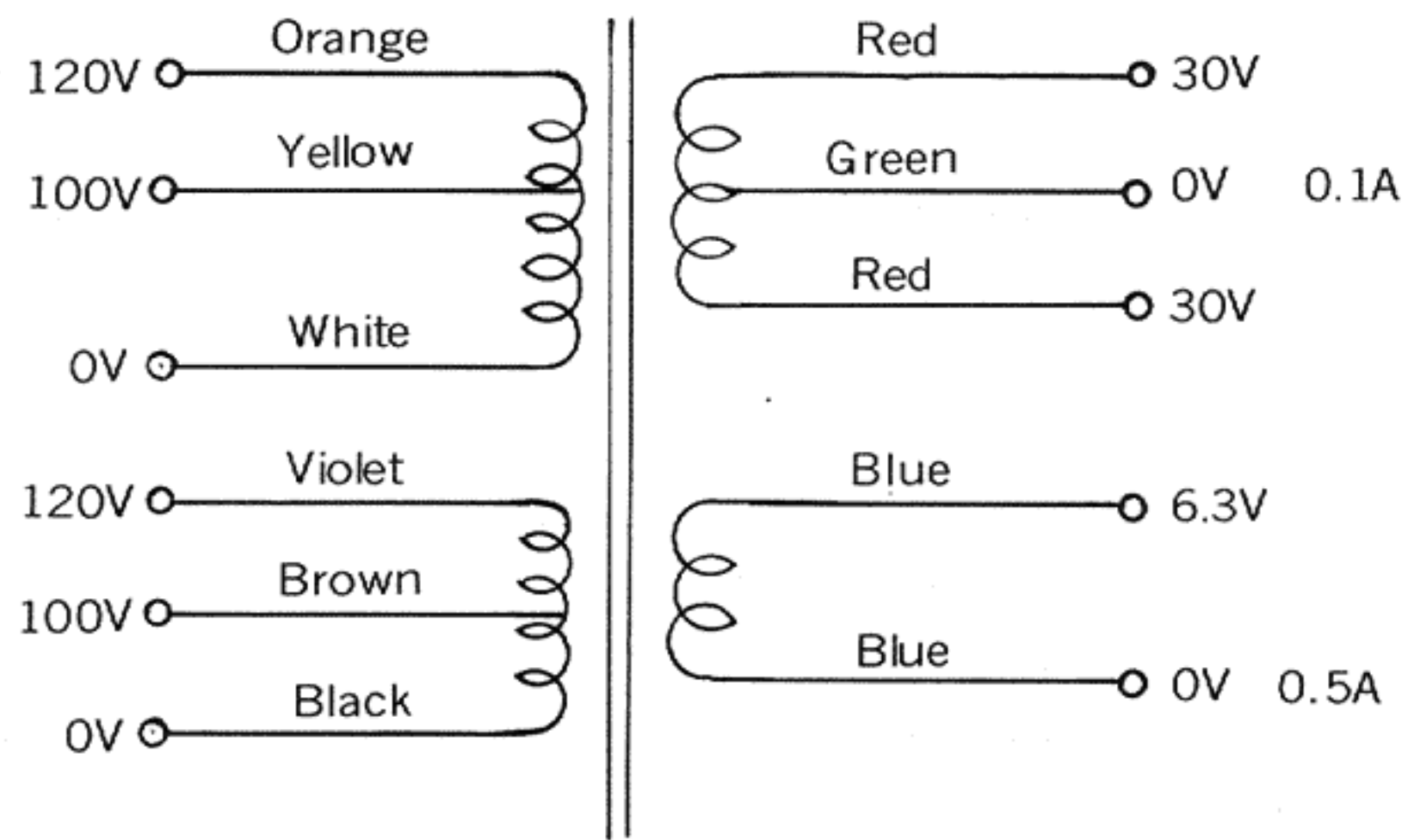
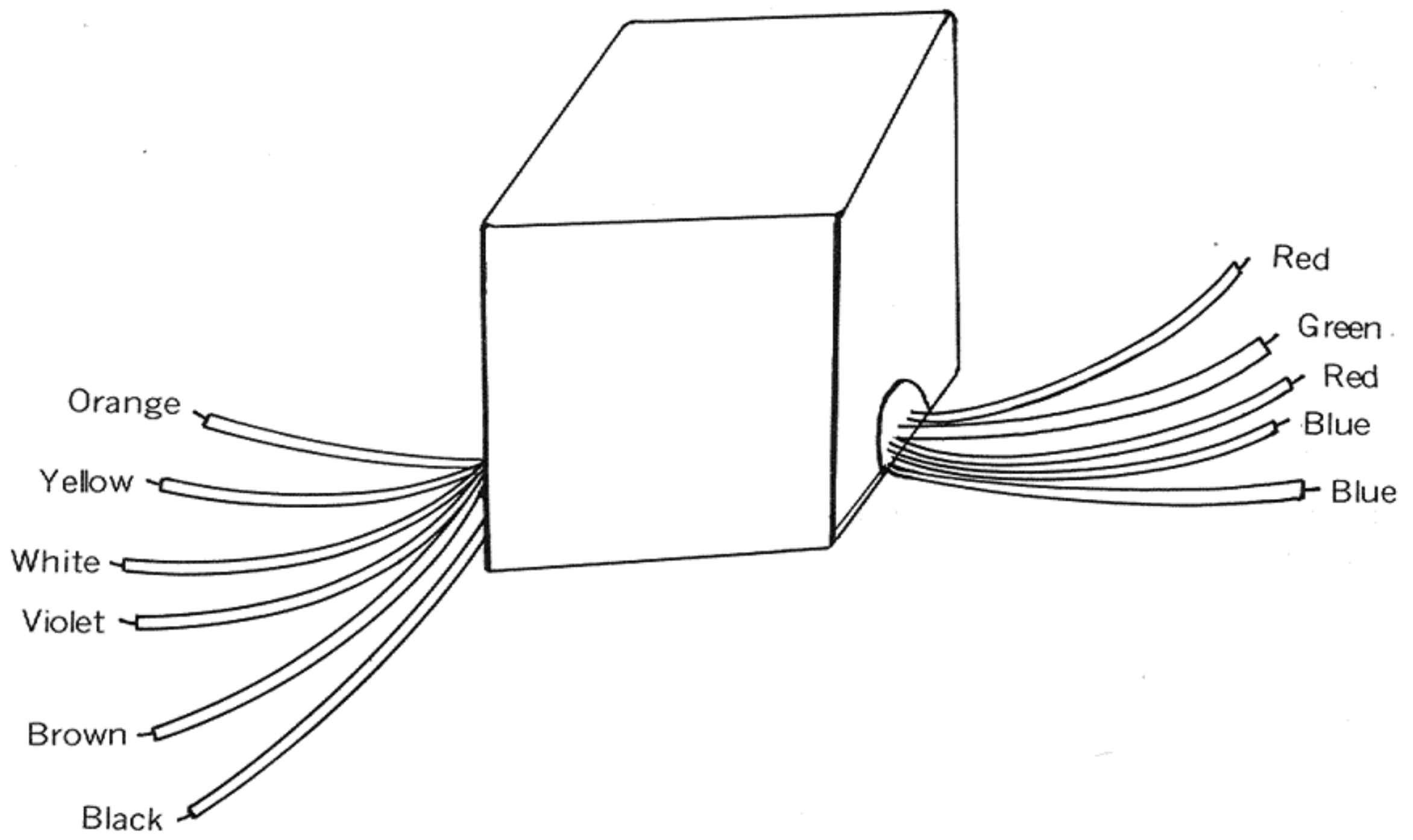

Fig. 25

The List of Main Parts for Replacement

Parts NO.	Parts Name	Description
E20468-002	Front panel ass'y	
E32473-001	Name plate	
E20466-002S	Front bracket	
E41302-002	Escutcheon ring	For power and pilot lamp.
E50571-5	Special nut	
E44658-001	Select shaft	For selector switch.
E44657-001	Bushing	
E44659-001	Stopper pin	
E50571-5	Special nut	
E20469-001	Back panel	
E43069-001	Escutcheon ring	For push switch
E50571-3	Special nut	
E45891-001	Rating plate	
E20457-001	Bottom plate	
Q05905	Foot	
E20471-001	Cover	
SDBP4008RS	Locking washer	
Knob		
E44081-001	Lever knob	For lever switch
E44363-001	Slide knob	For SEA control and balancer
E44360-001	Knob	For volume control
E44361-001	Knob	For mode & selector switch
E43099-001	Push knob	For 40/60Hz switch
Switch		
E03162-001	Rotary switch	For selector
E44808-001S	Connector	
Q03086-001	Lever switch	For power switch
Q03789-001	Push switch	For 40/60Hz switch
Q03076-001	Lever switch	For SEA & attenuator switch
E03161-001	Rotary switch	For mode
Variable Resistor		
E03192-001S	Slide V.R.	For SEA control 50K Ω (W)R43-56
E03181-005		For balance 250K Ω MN
E03179-001	V.R.	For Volume 250K Ω A
Socket, Jack & terminal		
Q30110-A	Pilot lamp socket Ass'y	For Power indicator
Q03967	DIN socket	
Q30121-001	AC outlet	
Q30210-001	Fuse socket	
Q03961-1	Jack ass'y	For microphone
E03043-101	Pin Jack ass'y	For phono 1, 2 and AUX. 1, 2.
E04043-40		For tape pre-out.
E04069S	Push terminal	For earth
Main capacitor etc.		
E03164-3	Power transformer	
TAE-37	Equalizer circuit board Ass'y	
TS-39	Transistor	X101-104

Parts NO.	Parts Name	Description
2SC853L	Transistor	X105-106
Q03110-10	E. Cap.	10 μ F/25V C103, 104, 109, 110.
Q03104-50	"	50 μ F/6V C113, 114.
Q03112-3	"	3.3 μ F/50V C115, 116.
TAC-104	Volume circuit board ass'y	
Q04880-47K	V.R.	47K Ω R21-24, 57, 58.
" -220K		220K Ω R9-14.
TAC-106	SEA circuit board ass'y	
2SC458LGC	Transistor	X501, 502, 503, 504.
Q03112-30	E. Cap.	33 μ F/50V C535.
Q03104-10	"	10 μ F/6. V C513,514.
Q03110-3	"	3.3 μ F/25V C503,506.
Q03104-50	"	47 μ F/6.3V C517,518.
E03108-9	Inductor	
" -10	"	
E0747-8	Ferri Inductor	100mH L509,510.
" -9	"	10mH L511,512.
" -10	"	22mH L513,514.
TAC-107	Filter circuit board ass'y	
2SC458LGC	Transistor	X201,202.
Q03112-10	E. Cap.	10 μ F/50V C215.
Q03110-50	"	47 μ F/50V C205,206.
" -10	"	10 μ F/25V C213,214.
TAP-67B	Power Supply circuit board ass'y	
E03155-001	Si diode	D302.
E03155-002	"	D301.
2SC853L	Transistor	X301.
Q03151-50	E. cap.	50 μ F/150V C302.
" -20	"	20 μ F/150V C301.
TAC-91	Pink noise generator circuit board ass'y	
2SC458LC	Transistor	X404,405.
2SC829C	"	X401-403.
E03062-5	I.F.T.	T40 1.
" -6	"	T402,403.
1S188AM	Diode	D401,402.
Q03110-10	E. Cap.	C421-423.
Q03108-10	"	C416
Q03600-21	E. Cap.	1000 μ F/80V C5
Q04967-4	Pilot lamp	8V 0.14A.
E41427-1	Rabbit eye	
Q4112-0.8	Fuse	0.8A
Q4112-0.5	"	0.5A
E31704-001	Cor ^d stopper	
Q03056-14	AC cord with plug	
E37430-128	Final packing ass'y	

THE LIST OF FRONT MECHANICAL PARTS FOR REPLACEMENT

DWG. NO.	PARTS NO.	PARTS NAME	DESCRIPTION
1	E20468-002	FRONT PANEL ASS'Y	FIXED FRONT PANEL
2	E44081-001	LEVER KNOB	
3	E43099-001	PUSH KNOB	
4	E44363-001	SLIDE KNOB	
5	E44361-001	KNOB	
6	E44360-001	KNOB	
7	SBSB3008M	TAPPING SCREW	
8	E20466-002S	FRONT BRACKET	
9	SSSP3005NS	SCREW	
10	E50571-5	NUT	
11	Q03091-133	WASHER	
12	E44657-001	BUSHING	
13	E44653-001S	LIGHT SHIELD	
14	Q04967-4	PILOT LAMP	
15	Q30110-A	LAMP SOCKET ASS'Y	POWER SWITCH
16	Q03086-001	LEVER SWITCH	
17	E45187-001	SHIELD COVER	
18	Q03789-001	PUSH SWITCH	
19	E44670-001	PUSH SWITCH BRACKET	
20	E03192-001S	SLIDE VARIABLE RESISTOR	
21	Q03076-001	LEVER SWITCH	
22	Q03078-001	"	
23	E03179-001	VARIABLE RESISTOR	
24	E03181-005	SLIDE VARIABLE RESISTOR	
25	E03161-001	ROTARY SWITCH	MODE
26	E44658-001	SELECT SHAFT	SELECT
27	E44660-001	SELECT BRACKET	
28	E03162-001	ROTARY SWITCH	
29	E44865-001	SCREW	
30	E44659-001	STOPER PIN	

EXPLODED VIEW OF FRONT PANEL

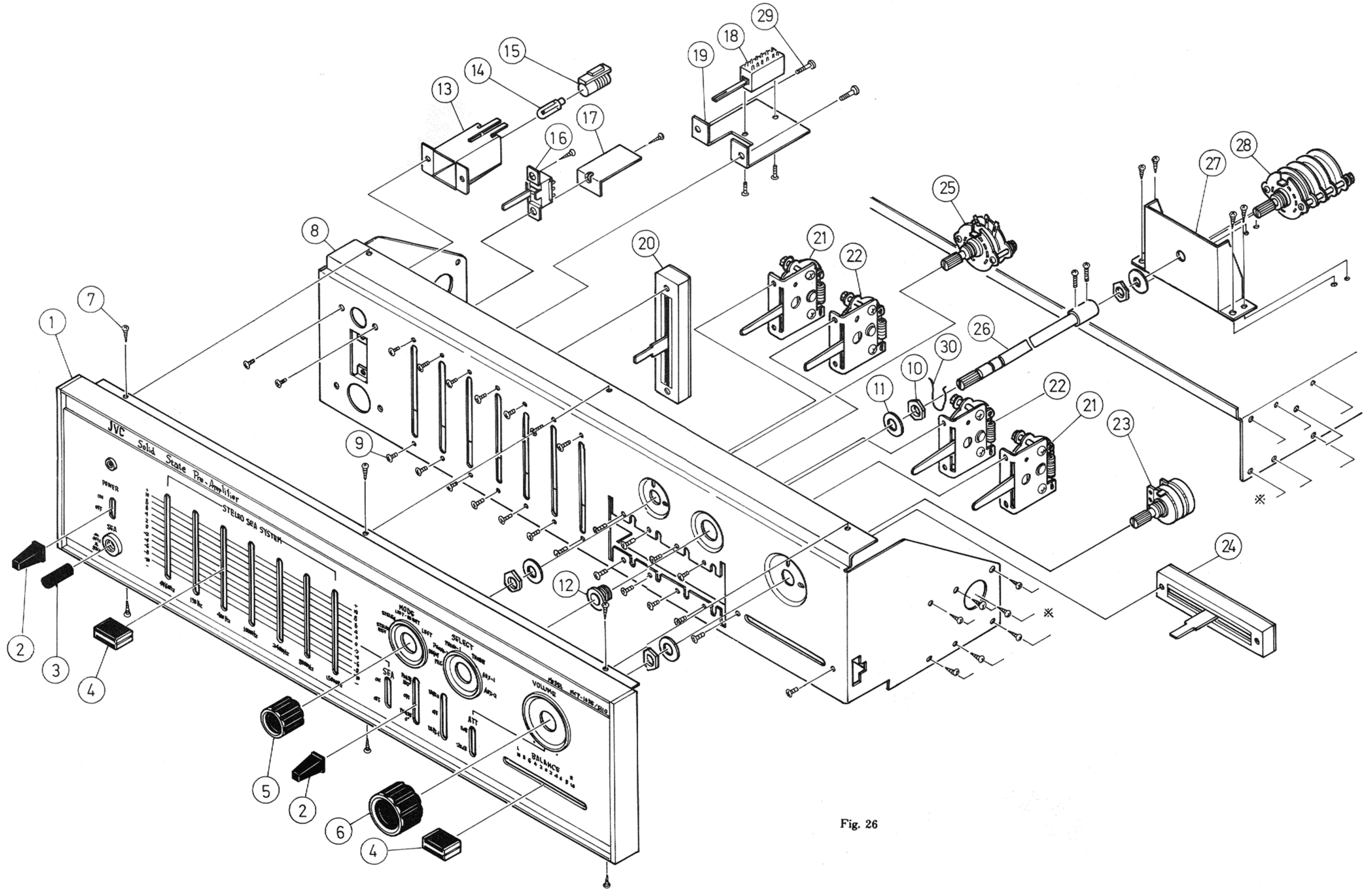

Fig. 26

EXPLODED VIEW OF REAR PANEL PARTS

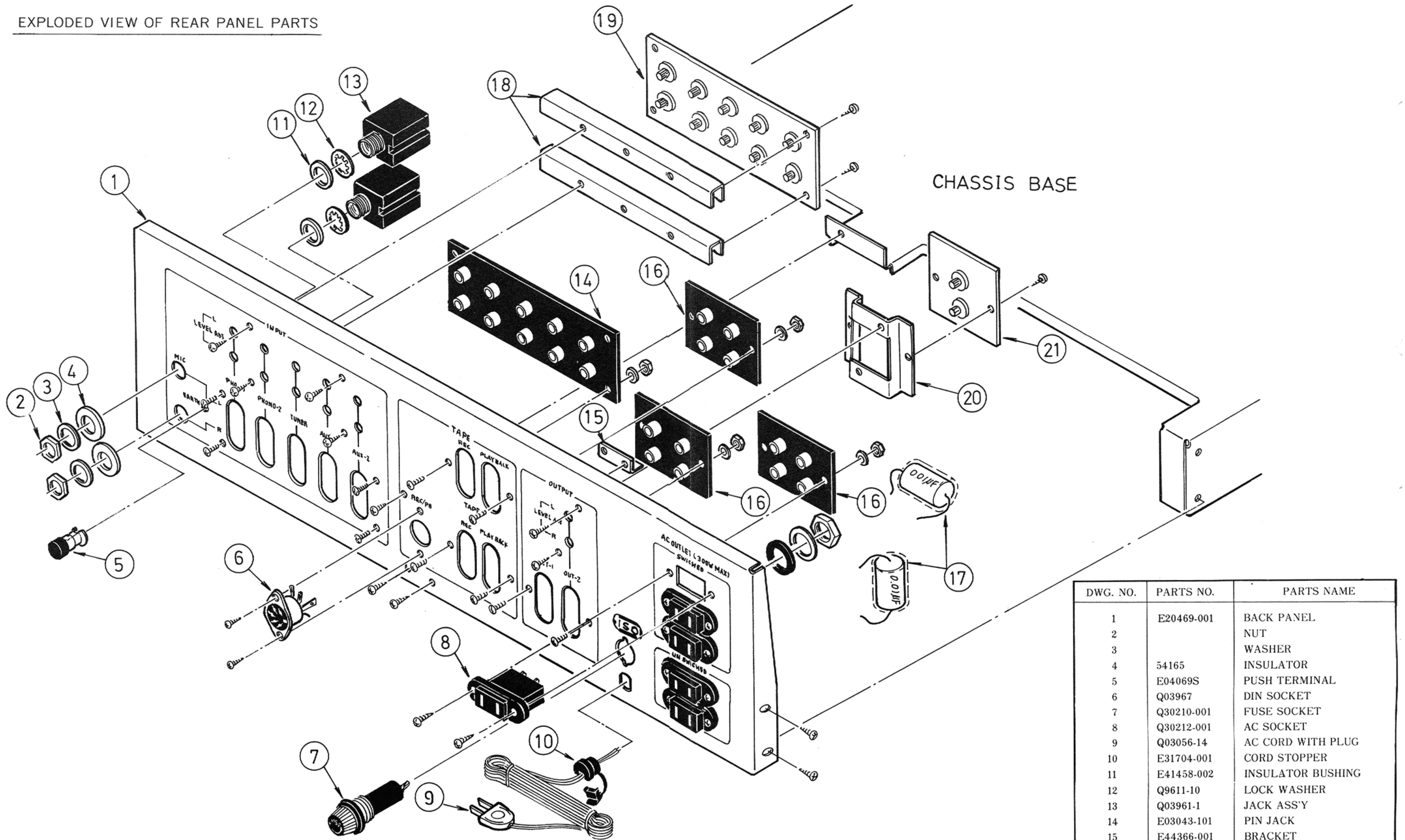
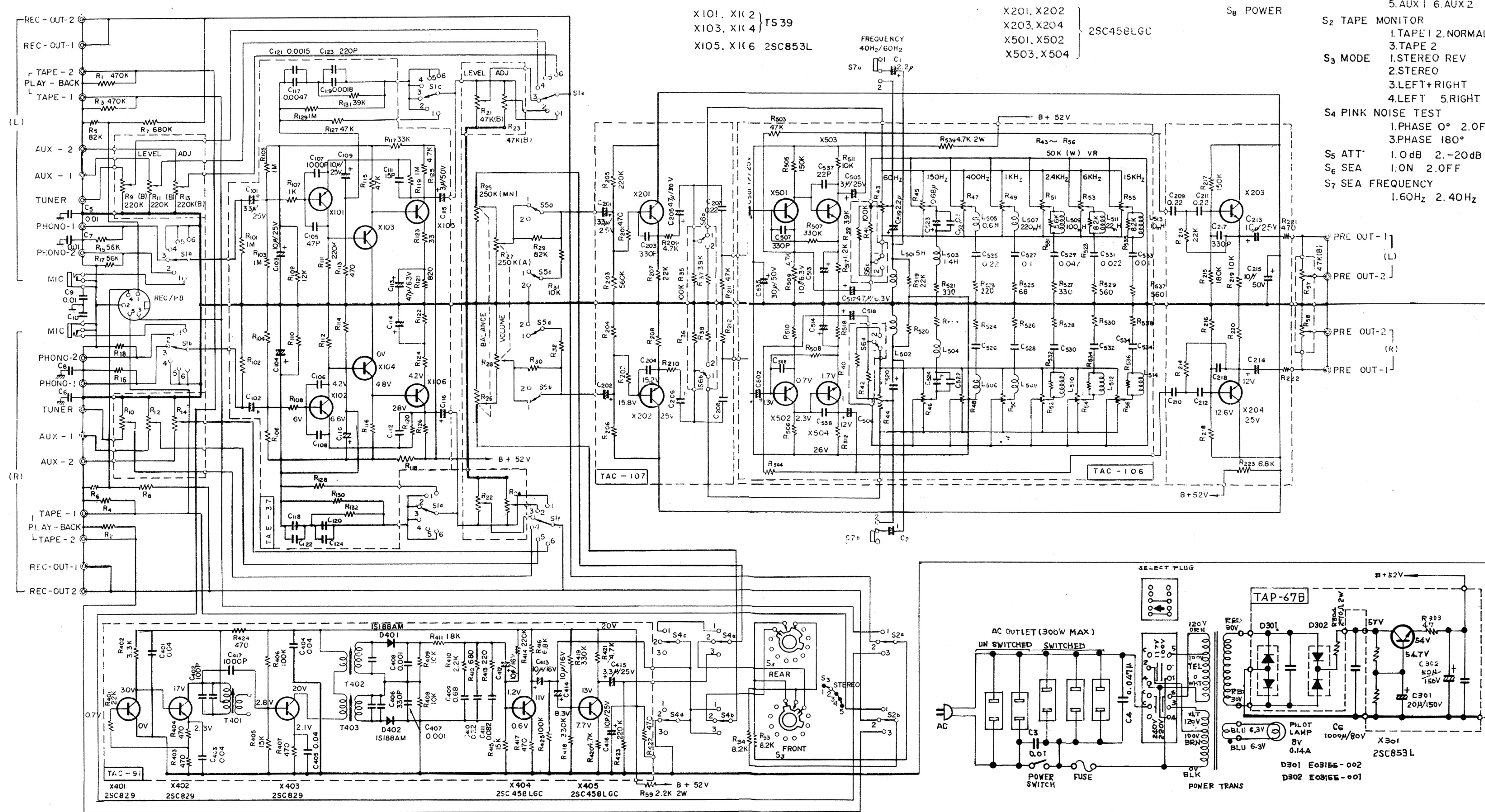

Fig. 27

DWG. NO.	PARTS NO.	PARTS NAME
1	E20469-001	BACK PANEL
2		NUT
3		WASHER
4	54165	INSULATOR
5	E04069S	PUSH TERMINAL
6	Q03967	DIN SOCKET
7	Q30210-001	FUSE SOCKET
8	Q30212-001	AC SOCKET
9	Q03056-14	AC CORD WITH PLUG
10	E31704-001	CORD STOPPER
11	E41458-002	INSULATOR BUSHING
12	Q9611-10	LOCK WASHER
13	Q03961-1	JACK ASS'Y
14	E03043-101	PIN JACK
15	E44366-001	BRACKET
16	E03043-40	PIN JACK
17	Q03212-103M	O.F.T CAPACITOR
18	E44664-001	BRACKET
19	TAC-105	CIRCUIT BOARD ASS'Y
20	E44809-001S	BRACKET
21	TAC-104	CIRCUIT BOARD ASS'Y



- S₁ SELECT 1. MIC 2. PHONO 2
(a~f) 3. PHONO 4. TUNER
5. AUX 1 6. AUX 2
- S₂ TAPE MONITOR
1. TAPE 1 2. NORMAL
3. TAPE 2
- S₃ MODE 1. STEREO REV
2. STEREO
3. LEFT+RIGHT
4. LEFT 5. RIGHT
- S₄ PINK NOISE TEST
1. PHASE 0° 2. OFF
3. PHASE 180°
- S₅ ATT' 1. 0dB 2. -20dB
- S₆ SEA 1. ON 2. OFF
- S₇ SEA FREQUENCY
1. 60Hz 2. 40Hz

AC100,120V 0.8V A AC220,240V 0.5A

NOTE : A sort of Resistor's Parts Number shown below.

Parts NO.	Sort of Resistor	Parts No.
Q04804-	Carbon Resistor	1/2W
Q04800-		1/4W
04091-	Composition Resistor	1/2W
04090-		1/4W
Q04772-	Metal Oxide Resistor	2W

When you order Resistor, write required Resistor value in addition to the right-hand of hyphen.

For example: Q04804-1K = Carbon Resistor 1K Ω 1/2W.

Q04772-100 = Metal Oxide Resistor 100 Ω 2W.

Q04800-4.7K = Carbon Resistor 4.7K Ω 1/4W.

04091-5.6K = Composition Resistor 5.6K Ω 1/2W.

CHECK POINT AFTER REPAIR

Please make sure of the following respect when repair is completes.

1. Normal gain and output are obtained.
2. Both high and low range of audio frequency are not decreased exceptionally.
3. Normal fuse used :

100V ~ 120V	0.8A	}	For NIVICO
200V ~ 240V	0.5A		

Requirement to Customers

- For the purpose of prompt supply of service parts ,inscribe parts number, parts name and model name correctly when you order.
- If possible please give an order for spare cabinet in early opportunity since it is very difficult to remanufacture cabinet after production of the set was discontinued.



JVC AMERICA, INC.
 50-35, 56th Road, Maspeth
 New York, N. Y. 11378.
 Manufactured by
 VICTOR COMPANY OF JAPAN, LIMITED

The List of **JVC NIVICO** Service Manual

(Phonograph)

No.	Model	No.	Model	No.	Model	No.	Model	No.	Model
2081	4TR-3U	2091	ARC-30A, 30B	2101	N760ME, N99U	2111(B)	STC-707C(R#-2)	2121	5007
2082	N-55T	2092	4TR-55	2102	SRP-472E	2112	SST-61	2122	L-21M
2083	SRE-103E	2093	{N670, N770 4TR-99u, etc	2103	SRP-469E	2113	{FRS-103EH.V (R#-2)	2123	ARC-10 Series
2084	N590F, 4TR-590F	2094	STP-7LA	2104	ARC-10L	2114	STP-808C	2124(B)	5003 (Revised)
2085	ARC-40A	2095	TRE-26C	2105	{BLA-204, 208 BLA-304, 30E	2115	SSL-95E	2125	L-311C
2086	TRE-12F	2096	STP-7F	2106	AST-140E	2116	MSL-16T	2126	5204
2087	SRP-467E	2097	N-880 (R#-2)	2107	ARC-12C, E	2117	AST-215E	2127	{4210, 4220, 4230 & (R#-2)
2088	SRP-468E	2098	N-163	2108	CSL-1E	2118	SRC-700U	2128	5305
2089	ECA-101E	2099	4TR-6U	2109	MSL-8E	2119	AST-102E	2129	TRE-12T
2090	STC-19	2100	MSL-15E	2110	SST-31	2120	No. 200E Series	2130	5304

No.	Model	No.	Model	No.	Model	No.	Model	No.	Model
2131	STP-808A	2141	5320, 5340	2151(B)	5040 (R#-2)	2161	4333U	2171	5202
2132	ARC-41, 42	2142	L-311D	2152	{SSL-46E SSL-46EA	2162	MPX-18B	2172	5220
2133	TRE-666C	2143	6102, 6103, 6104	2153	MSL-300ES	2163	MCA-104E	2173	ARC-15A
2134(B)	4TR-990DX (a)	2144	ARC-10	2154	4330	2164	SEA-100E/5100	2174	4344, 4344U
2135	5001	2145	5011/PST-1000E 5012/MST-1000E	2155	N-404, N-404Y	2165	5240B	2175(B)	4450, 4450U
2136	SRP-B30E/5230	2146	5201	2156(B)	MSL-501E	2166	4330U	2176	CSL-130SE
2137	N-65F	2147	MSL-300E	2157	N202, 303	2167	MCA-105E/5107	2177	5020/5020U
2138	4TR-511D, L511D	2148	5310	2158	4211	2168	5030/5030U	2178	MTR-10ME
2139(B)	SRP-B40E/5240	2149	MSL-110S	2159(B)	4333U, 4333	2169	SRC-900	2179	5010L
2140	5203	2150	5205	2160	5010	2170	5200	2180	4TR-1000

No.	Model	No.	Model	No.	Model	No.	Model	No.	Model
2181(B)	4400, 4400U	2191	MCM-105E, 5111	2201		2211	BLA-500E	2221	4431U
2182	ARC-50	2192	5395	2202	MSL-201S/SA	2212	MCT-V7E/5109	2222	4310U
2183	MCT-105E/5108	2193	MSL-201E	2203	4431	2213	5306	2223	N-303FYE
2184	SCR-500	2194	MCA-V7E	2204	4310	2214	N-203/RUN No.2	2224	MCA-104Z
2185	4330M	2195	SRC-800	2205	N-303YE	2215	5250U	2225	MSL-501E, 201E SUPPLIEMENT
2186	N-404F Series	2196	5301/GB-2E	2206	5500/5500U	2216	5444/5444U	2226	MCP-105E/5110
2187	5325, 5335	2197	5390	2207	5540/5540U	2217	5910		
2188	MSL-501L	2198	MSL-201L	2208	MTR-15ME	2218	MCT-V5E		
2189	MSA-404E	2199	5341/5341K	2209	5550/5550U	2219	5100		
2190	N-202FMY	2200	5331/5331K	2210	5351/5351K	2220	5020, 5030, 5040 SUPPLIEMENT		

No.	Model	No.	Model	No.	Model	No.	Model	No.	Model