

RX-558VBK  
RX-558RBK

# JVC

## SERVICE MANUAL

AUDIO VIDEO CONTROL RECEIVER

### RX-558VBK RX-558RBK

#### Area Suffix (RX-558VBK)

J ..... The U.S.A  
C ..... Canada  
U ..... Universal  
UY..... Argentina

#### Area Suffix (RX-558RBK)

E ..... Continental Europe  
EN ..... Northern Europe  
B ..... U.K.

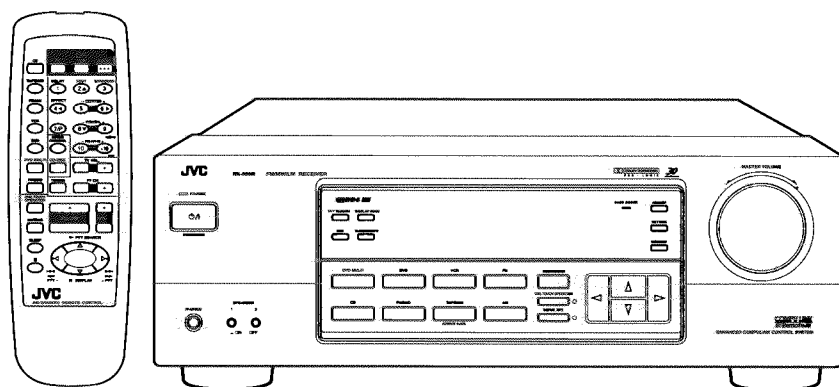

This Illustration is RX-558RBK

**COMPU LINK**  
/// Remote ///

**3D**  
3D-PHONIC

**R-D-S EON**

**DOLBY SURROUND**  
PRO - LOGIC

### Contents

Safety Precautions .....	1-2	Adjustment Procedures .....	2-14
Instruction Book (RX-558RBK) .....	1-3	Block Diagrams .....	2-15
Description of Major ICs .....	2-1	Schematic Diagrams .....	2-17
Internal Connection of Display .....	2-11	Printed Circuit Boards .....	2-25
Disassembly Procedures .....	2-12	Parts List .....	3-1-3-19

## Safety Precautions

1. This design of this product contains special hardware and many circuits and components specially for safety purposes. For continued protection, no changes should be made to the original design unless authorized in writing by the manufacturer. Replacement parts must be identical to those used in the original circuits. Services should be performed by qualified personnel only.
2. Alterations of the design or circuitry of the product should not be made. Any design alterations of the product should not be made. Any design alterations or additions will void the manufacturer's warranty and will further relieve the manufacture of responsibility for personal injury or property damage resulting therefrom.
3. Many electrical and mechanical parts in the products have special safety-related characteristics. These characteristics are often not evident from visual inspection nor can the protection afforded by them necessarily be obtained by using replacement components rated for higher voltage, wattage, etc. Replacement parts which have these special safety characteristics are identified in the Parts List of Service Manual. Electrical components having such features are identified by shading on the schematics and by ( $\Delta$ ) on the Parts List in the Service Manual. The use of a substitute replacement which does not have the same safety characteristics as the recommended replacement parts shown in the Parts List of Service Manual may create shock, fire, or other hazards.
4. The leads in the products are routed and dressed with ties, clamps, tubings, barriers and the like to be separated from live parts, high temperature parts, moving parts and/or sharp edges for the prevention of electric shock and fire hazard. When service is required, the original lead routing and dress should be observed, and it should be confirmed that they have been returned to normal, after re-assembling.

### 5. Leakage current check (Electrical shock hazard testing)

After re-assembling the product, always perform an isolation check on the exposed metal parts of the product (antenna terminals, knobs, metal cabinet, screw heads, headphone jack, control shafts, etc.) to be sure the product is safe to operate without danger of electrical shock. Do not use a line isolation transformer during this check.

- Plug the AC line cord directly into the AC outlet. Using a "Leakage Current Tester", measure the leakage current from each exposed metal parts of the cabinet, particularly any exposed metal part having a return path to the chassis, to a known good earth ground. Any leakage current must not exceed 0.5mA AC (r.m.s.)

- Alternate check method

Plug the AC line cord directly into the AC outlet. Use an AC voltmeter having, 1,000 ohms per volt or more sensitivity in the following manner. Connect a 1,500 $\Omega$  10W resistor paralleled by a 0.15 $\mu$ F AC-type capacitor between an exposed metal part and a known good earth ground.

Measure the AC voltage across the resistor with the AC voltmeter.

Move the resistor connection to each exposed metal part, particularly any exposed metal part having a return path to the chassis, and measure the AC voltage across the resistor. Now, reverse the plug in the AC outlet and repeat each measurement. voltage measured Any must not exceed 0.75 V AC (r.m.s.). This corresponds to 0.5 mA AC (r.m.s.).

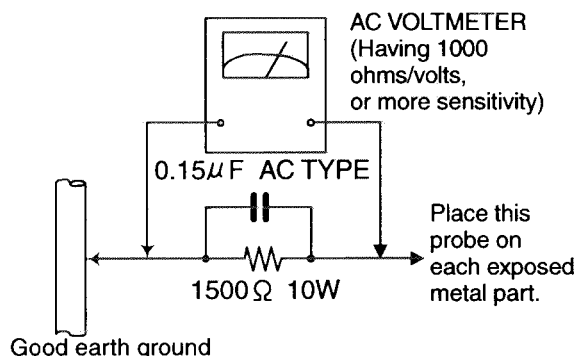

## Warning

1. This equipment has been designed and manufactured to meet international safety standards.
2. It is the legal responsibility of the repairer to ensure that these safety standards are maintained.
3. Repairs must be made in accordance with the relevant safety standards.
4. It is essential that safety critical components are replaced by approved parts.
5. If mains voltage selector is provided, check setting for local voltage.

**⚠ CAUTION** Burrs formed during molding may be left over on some parts of the chassis. Therefore, pay attention to such burrs in the case of performing repair of this system.

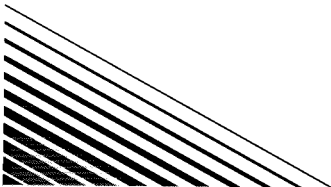

# JVC



## FM/MW/LW RECEIVER

UKW/MW/LW-RECEIVER  
AMPLI/TUNER FM/PO/GO  
FM/MG/LG TUNER/VERSTERKER  
RECEPTOR FM/MW/LW  
RICEVITORE MF/OM/OL

# RX-558RBK

# JVC

VICTOR COMPANY OF JAPAN, LIMITED

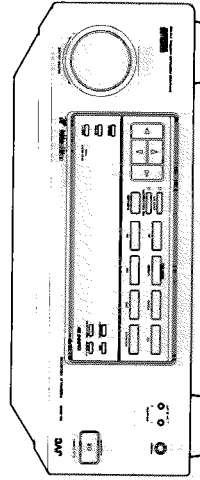
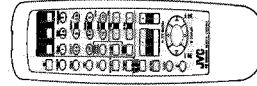

COMPU LINK  
Remote III

3D  
3D-PHONIC

RD-S EON

DOLBY SURROUND  
PRO LOGIC

## INSTRUCTIONS

BEDIENUNGSANLEITUNG  
MANUEL D'INSTRUCTIONS  
GEBRUIKSAANWIJZING  
MANUAL DE INSTRUCCIONES  
ISTRUZIONI

For Customer Use:  
Enter below the Model No. and Serial No. which are located either on the rear, bottom or side of the cabinet. Retain this information for future reference.

Model No.	
Serial No.	



**Parts Identification** ..... 2

**Getting Started** ..... 3

    Before Installation ..... 3

    Checking the Supplied Accessories ..... 3

    Connecting the FM and AM (MW/LW) Antennas ..... 3

    Connecting the Speakers ..... 4

    Connecting Other Components ..... 4

    Connecting the Power Cord ..... 7

    Putting Batteries in the Remote Control ..... 7

**Basic Operations** ..... 8

    Turning the Power On and Off (Standby) ..... 8

    Selecting the Source to Play ..... 8

    Adjusting the Volume ..... 9

    Selecting the Front Speakers ..... 9

    Muting the Sound ..... 9

    Recording a Source ..... 9

    Attenuating the Input Signal ..... 10

    Adjusting the Front Speaker Output Balance ..... 10

    Reinforcing the Bass ..... 10

    Adjusting the Tune ..... 10

**Basic Settings** ..... 11

    Changing the Source Name ..... 11

    Setting Center and Rear Speakers for the DSP Modes ..... 11

    Storing the Basic Settings and Adjustments — One-Touch Operation ..... 12

    Using the Sleep Timer ..... 12

**Receiving Radio Broadcasts** ..... 13

    Tuning in Stations Manually ..... 13

    Using Preset Tuning ..... 13

    Selecting the FM Reception Mode ..... 14

    Using the RDS (Radio Data System) to Receive FM Stations ..... 14

    Searching for a Program by PTY Codes ..... 15

    Switching to a Broadcast Program of Your Choice Temporarily ..... 16

**Using the DSP Modes** ..... 17

    Available DSP Modes According to the Speaker Arrangement ..... 18

    Adjusting the 3D-PHONIC Modes ..... 19

    Adjusting the DAP Modes ..... 19

    Adjusting the Surround Modes — Dolby Surround and JVC Theater Surround ..... 20

    Activating the DSP Modes ..... 21

**Using the DVD MULTI Playback Mode** ..... 22

    Activating the DVD MULTI Playback Mode ..... 22

**COMPU LINK Remote Control System** ..... 23

**Operating Other Components** ..... 24

**Troubleshooting** ..... 26

**Specifications** ..... 27

Become familiar with the buttons and controls on the receiver before use. Refer to the pages in parentheses for details.

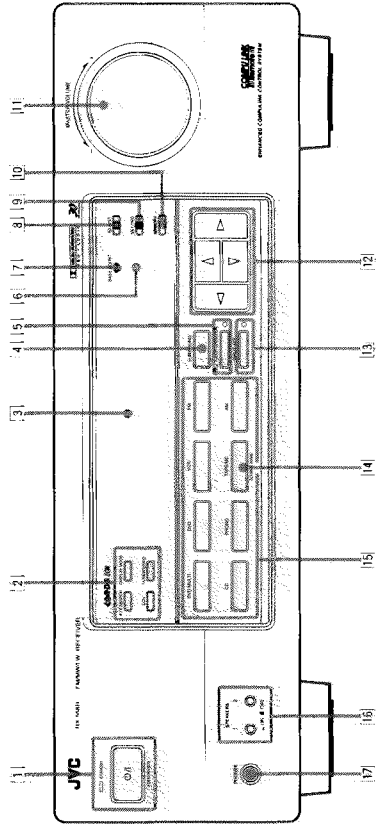

**Front Panel**

- 11 STANDBY/ON (S/O) button and STANDBY lamp (8)
- 12 RDS operation buttons (14)
- 13 PTY SEARCH, DISPLAY MODE, EON, TAPE/RECALL, PHONO, NEW SOUNFO
- 14 Display (8)
- 15 SURROUND button (18)
- 16 ONE TOUCH OPERATION button and lamp (12)
- 17 Remote sensor (7)
- 18 BASS BOOST lamp (10)
- 19 ADJUST button (10) \*
- 20 SETTING button (11) \*
- 21 MEMORY button (13)
- 22 MASTER VOLUME control (9)
- 23 Cursor control buttons (24)
- 24 INPUT ATT button and lamp (10)
- 25 SOURCE NAME button (11)
- 26 Source selecting buttons (8)
- 27 DVD MULTI, DVD, VCR, FM, AM\*, TAPE/RECALL, PHONO, CD
- 28 SPEAKERS 1/2 buttons (9)
- 29 PHONES jack (9)

**Remote Control**

- 11 (S/O) buttons (8, 25)
- 12 TV, VCR, AUDIO
- 13 CD, TAPE/RECALL, PHONO, VCR, DVD, DVD MULTI, PHONO
- 14 ONE TOUCH OPERATION button (12)
- 15 VOLUME +/- buttons (9)
- 16 MUTE button (9)
- 17 SLEEP button (12)
- 18 Operating buttons for audio/video components (24)
- 19 RDS operation buttons (14)
- 20 PTY SEARCH, PTY +/-, DISPLAY
- 21 \* 10 keys for selecting preset channel (13, 24)
- 22 \* 10 keys for adjusting sound (12, 19, 24)
- 23 \* 10 keys for operating audio/video components (24)
- 24 SOUND CONTROL button (12, 19, 24)
- 25 TV VOL. +/- buttons (25)
- 26 CD-DISC button (24)
- 27 TV CH +/- buttons (25)
- 28 TV/VIDEO button (25)
- 29 VCR CH +/- buttons (25)

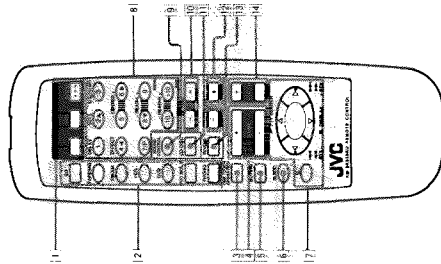

**IMPORTANT:**

To use the Cursor control buttons (12) on the front panel: What these buttons actually do depends on which function you are trying to adjust. Before using these buttons, select the function by pressing one of the buttons marked with \*

## Getting Started

This section explains how to connect audio/video components and speakers to the receiver, and how to connect the power supply.

### Before Installation

#### General

- Be sure your hands are dry.
- Turn the power off to all components.
- Read the manuals supplied with the components you are going to connect.

#### Locations

- Install the receiver in a location that is level and protected from moisture.
- The temperature around the receiver must be between -5° and 35° C (23° and 95° F).
- Make sure there is good ventilation around the receiver. Poor ventilation could cause overheating and damage the receiver.

#### Handling the receiver

- Do not insert any metal object into the receiver.
- Do not disassemble the receiver or remove screws, covers, or cabinet.
- Do not expose the receiver to rain or moisture.

### Checking the Supplied Accessories

Check to be sure you have all of the following items, which are supplied with the receiver. The number in the parentheses indicates quantity of the pieces supplied.

- Remote Control (1)
- Batteries (2)
- AM (MW/LW) Loop Antenna (1)
- FM Antenna (1)

If anything is missing, contact your dealer immediately.

### Connecting the FM and AM (MW/LW) Antennas

#### FM Antenna Connections

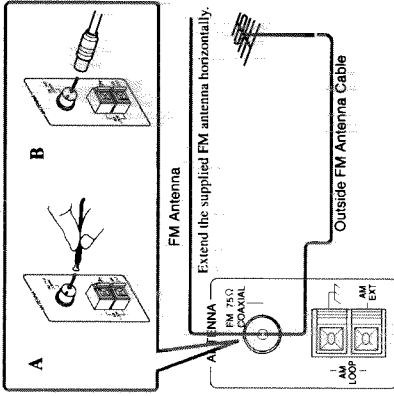

#### A. Using the Supplied FM Antenna

The FM antenna provided can be connected to the FM 75Ω COAXIAL terminal as temporary measure.

#### B. Using the Standard Type Connector (Not Supplied)

A standard type connector (IEC or DIN45325) should be connected to the FM 75Ω COAXIAL terminal.

#### Note:

If reception is poor, connect the outside antenna. Before attaching a 75Ω coaxial cable (the kind with a round wire going to an outside antenna), disconnect the supplied FM antenna.

### AM (MW/LW) Antenna Connections

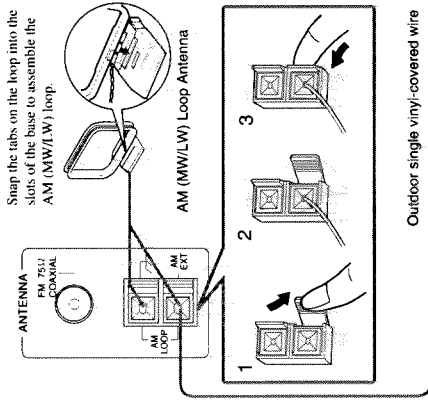

#### Turn the loop until you have the best reception.

#### Notes:

- Make sure the antenna conductors do not touch any other terminals, connecting cords and power cord. This could cause poor reception.
- If reception is poor, connect an outdoor single vinyl-covered wire to the AM EXT terminal. (Keep the AM (MW/LW) loop antenna connected.)

### Connecting the Speakers

You can connect the following speakers:

- Two pairs of front speakers to produce normal stereo sound.
- One pair of rear speakers to enjoy the surround effect.
- One center speaker to produce more effective surround effect (to emphasize human voices).
- One subwoofer to enhance the bass.

#### IMPORTANT:

After connecting the speakers listed above, set the speaker setting information properly to obtain the best possible DSP effect. For details, see page 11.

For each speaker (except for a subwoofer), connect the (-) and (+) terminals on the rear panel to the (-) and (+) terminals marked on the speakers. For connecting a subwoofer, see page 5.

#### CAUTION:

Use speakers with the SPEAKER IMPEDANCE indicated by the speaker terminals.

### Basic connecting procedure

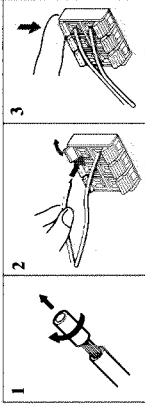

1 Cut, twist and remove the insulation at the end of each speaker signal cable.

2 Open the terminal and then insert the speaker signal cable.

3 Close the terminal.

### Connecting the front speakers

You can connect two pairs of front speakers (one pair to the FRONT SPEAKERS (1) terminals, and another pair to the FRONT SPEAKERS (2) terminals).

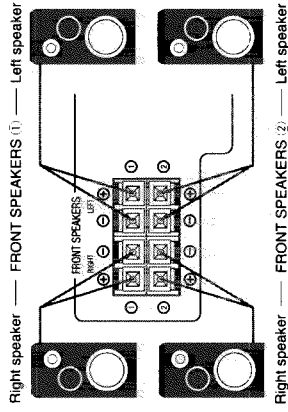

**Connecting the rear and center speakers**

Connect rear speakers to the REAR SPEAKERS terminals and a center speaker to the CENTER SPEAKER terminals.

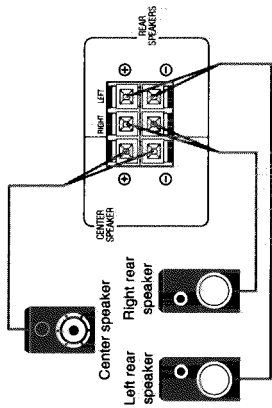

**Connecting the subwoofer speaker**

You can enhance the bass by connecting a subwoofer. Connect the input jack of a powered subwoofer to the SUBWOOFER OUT jack on the rear panel, using a cable with RCA pin plugs.

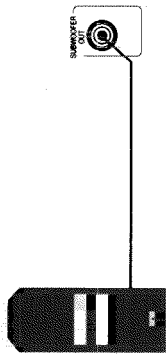

Powered subwoofer

**Connecting Other Components**

You can connect the following audio/video components to this receiver using cables with RCA pin plugs (not supplied). Refer also to the manuals supplied with your components.

Use the cables with RCA pin plugs (not supplied). Connect the white plug to the audio left jack, and the red plug to the audio right jack.

**Audio component connections**

**CAUTION:**

If you connect a sound-enhancing device such as a graphic equalizer between the source components and this receiver, the sound output through this receiver may be distorted.

**Turntable**

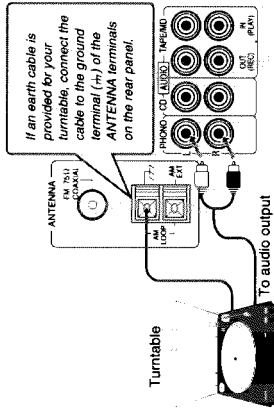

**Note:**

Any turntables incorporating a small-output cartridge such as an MC (moving-coil type) must be connected to this receiver through a commercial head amplifier or step-up transformer. Direct connection may result in insufficient volume.

**CD player**

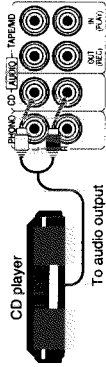

**Cassette deck or MD recorder**

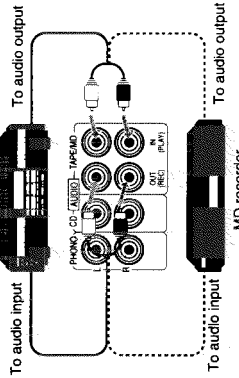

**Note:**

You can connect either a cassette deck or an MD recorder to the TAPE/MD jacks. When connecting an MD recorder to the TAPE/MD jacks, change the source name, which will be shown on the display when selected as the source to "M.D." See page 11 for details.

**If your audio components have a COMPU LINK-3 terminal**

See also page 23 for detailed information about the connection and the COMPU LINK-3 remote control system.

**Video component connections**

You can connect the following video components to this receiver.

- You can reproduce only the sound from the video equipment through this receiver.

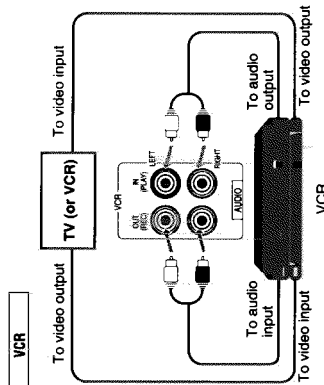

**DVD player**

When you connect the DVD player with stereo output jacks:

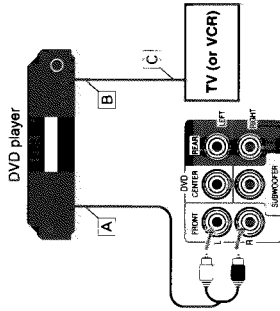

- A To front left/right channel audio output (or to audio mixed output if necessary)
- B To video output
- C To video input

When you connect the DVD player with its analog discrete output (5.1 CH reproduction) jacks:

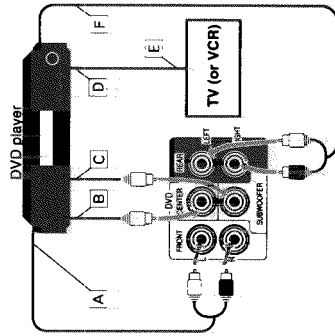

- A To front left/right channel audio output
- B To center channel audio output
- C To subwoofer audio output
- D To video output
- E To video input
- F To rear left/right channel audio output

## Basic Operations

The following operations are commonly used when you play any sound source.

### Turning the Power On and Off (Standby)

#### On the front panel:

To turn on the power, press STANDBY/ON . The STANDBY lamp goes off. The name of the current source (or station frequency) appears on the display.

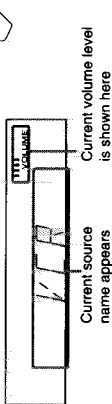

Current volume level is shown here

#### To turn off the power (into standby mode),

press STANDBY/ON again. The STANDBY lamp lights up. A small amount of power is consumed in standby mode. To turn the power off completely, unplug the AC power cord.

#### From the remote control:

To turn on the power, press AUDIO . The STANDBY lamp goes off. The name of the current source (or station frequency) appears on the display.

#### To turn off the power (into standby mode),

press AUDIO again. The STANDBY lamp lights up.

### Selecting the Source to Play

Press one of the source selecting buttons.

#### On the front panel:

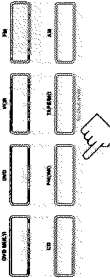

#### From the remote control:

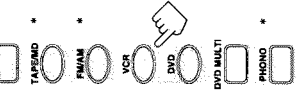

#### Note:

When you press one of the source selecting buttons, marked above with an asterisk (\*), on the remote control, the receiver automatically turns on.

### Putting Batteries in the Remote Control

Before using the remote control, put two supplied batteries first. When using the remote control, aim the remote control directly at the remote sensor on the receiver.

- On the back of the remote control, remove the battery cover as illustrated.

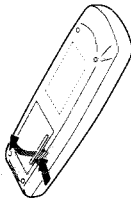

- Insert batteries. Make sure to observe the proper polarity: (+) to (+) and (-) to (-).

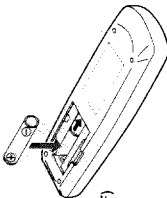

R6P (SUM-3)/AA (1.5F)

- Replace the cover.

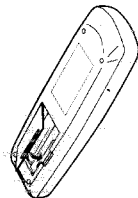

If the range or effectiveness of the remote control decreases, replace the batteries. Use two R6P (SUM-3)/AA (1.5F) type dry-cell batteries.

#### CAUTION:

- Follow these precautions to avoid leaking or cracking cells:
- Place batteries in the remote control so they match the polarity indicated: (+) to (+) and (-) to (-).
  - Use the correct type of batteries. Batteries that look similar may differ in voltage.
  - Always replace both batteries at the same time.
  - Do not expose batteries to heat or flame.

### Connecting the Power Cord

Before plugging the receiver into an AC outlet, make sure that all connections have been made.

Plug the power cord into an AC outlet.

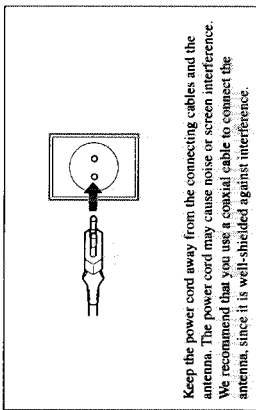

Keep the power cord away from the connecting cables and the antenna. The power cord may cause noise or screen interference. We recommend that you use a coaxial cable to connect the antenna. Since it is well-shielded against interference.

#### Note:

The power settings such as preset channels and sound adjustment may be erased in a few days in the following cases:

- When you unplug the power cord.
- When a power failure occurs.

#### CAUTIONS:

- Do not touch the power cord with wet hands.
- Do not pull on the power cord to unplug the cord. When unplugging the cord, always grasp the plug so as not to damage the cord.

#### On the front panel:

Select the DVD player for viewing the digital video disc, using the analog discrete output mode (S1CH reproduction) on the DVD player.

To enjoy the DVD MULTI playback, see page 22. Select the DVD player for viewing the stereo digital video disc.

Select the video component connected to the VCR jacks.

Select an FM broadcast.

Select an AM (MW/LW) broadcast.

Select the cassette deck (or the MD recorder).

Select the turntable.

Select the CD player.

#### From the remote control:

Select an FM or AM (MW/LW) broadcast. Each time you press the button, the band alternates between FM and AM (MW/LW).

- Other buttons function in the same way as the buttons on the front panel.

#### Note:

When connecting an MD recorder (to the TAPE/MD jacks), change the source name that appears on the display. See page 11 for details.



### Adjusting the Volume

#### On the front panel:

To increase the volume, turn MASTER VOLUME clockwise.

To decrease the volume, turn it counterclockwise.

- When you turn MASTER VOLUME rapidly, the volume level also changes rapidly.
- When you turn MASTER VOLUME slowly, the volume level also changes slowly.

#### From the remote control:

To increase the volume, press VOLUME +.

To decrease the volume, press VOLUME -.

#### CAUTION:

Always set the volume to the minimum before starting any source. If the volume is set at its high level, the sudden blast of sound energy can permanently damage your hearing and/or ruin your speakers.

#### Note:

The volume level can be adjusted within the range of "0" (minimum) to "80" (maximum).

### Selecting the Front Speakers

#### On the front panel ONLY:

When you have connected two pairs of the front speakers, you can select which to use. Pressing SPEAKERS 1 or SPEAKERS 2 activates the respective set of speakers.

- To use the speakers connected to the FRONT SPEAKERS (1) terminals, press SPEAKERS 1 to set it in the **ON** position, and press SPEAKERS 2 to set it in the **OFF** position.
- To use the speakers connected to the FRONT SPEAKERS (2) terminals, press SPEAKERS 2 to set it in the **ON** position, and press SPEAKERS 1 to set it in the **OFF** position.
- To use both sets of the speakers, press SPEAKERS 1 to set it in the **ON** position, and press SPEAKERS 2 to set it in the **ON** position.
- To use neither set of the speakers, press SPEAKERS 1 and SPEAKERS 2 to set them in the **OFF** position.

#### Note:

When only one set of the speakers is connected to either the FRONT SPEAKERS (1) or (2) terminals, do not activate both pairs of the speakers. If you do, no sound comes out of the front speakers.

### Listening only with headphones

1. Connect a pair of headphones to the PHONES jack on the front panel.
2. Press SPEAKERS 1 and SPEAKERS 2 to set them in the **OFF** position.

#### CAUTION:

Be sure to turn down the volume before connecting or putting on headphones, as high volume can damage both the headphones and your hearing.

#### Note:

You cannot shut off the sound through the other speakers using the SPEAKERS 1 and 2 buttons.

### Muting the Sound

#### From the remote control ONLY:

Press MUTING to mute the sound through all speakers and headphones connected.

"MUTING" appears on the display and the volume turns off (the volume level indicator gives off).

To restore the sound, press MUTING again.

- Turning MASTER VOLUME or pressing VOLUME +/- also restores the sound.

### Recording a Source

You can record any source playing through the receiver to a cassette deck (or an MD recorder) connected to the TAPE/MD jacks and the VCR connected to the VCR jacks at the same time.

While recording, you can listen to the selected sound source at whatever sound level you like, without affecting the sound levels of the recording.

#### Note:

The output volume level, tone adjustment (see page 10), Bass Boost (see page 10) and DSP modes (see page 17) cannot affect the recording.

#### IMPORTANT:

Before recording, turn off the DVD MULTI playback mode.

### Attenuating the Input Signal

When the input level of the playing source is too high, the sounds will be distorted. If this happens, you need to attenuate the input signal level to prevent the sound distortion.

#### On the front panel ONLY:

Press INPUT ATT. so that the lamp next to the button lights up.

- Each time you press the button, the Input Attenuator mode turns on or off.

#### Note:

When selecting "DUALMULTI" as the source, this effect only applies to front left and right channel signals.

### Adjusting the Front Speaker Output Balance

If the sounds you hear from the front right and left speakers are unequal, you can adjust the speaker output balance.

#### Before you start, remember...

- There is a time limit in doing the following steps. If the setting is canceled before you finish, start from step 1 again.

#### On the front panel ONLY:

1. Press ADJUST so that the cursor control  $\Delta/\nabla$  buttons work for adjusting the sound.

2. Press cursor control  $\Delta/\nabla$  repeatedly until "BALANCE" appears on the display.

3. Press cursor control  $\Delta/\nabla$  to adjust the balance.

- Pressing  $\Delta$  decreases the right channel output.
- Pressing  $\nabla$  decreases the left channel output.

### Reinforcing the Bass

With this Bass Boost function, you can boost the bass level.

#### Before you start, remember...

- There is a time limit in doing the following steps. If the setting is canceled before you finish, start from step 1 again.

#### On the front panel ONLY:

1. Press ADJUST so that the cursor control  $\Delta/\nabla$  buttons work for adjusting the sound.

2. Press cursor control  $\Delta/\nabla$  repeatedly until "B-BOOST" appears on the display.

3. Press cursor control  $\Delta/\nabla$  to switch this function "ON" or "OFF".

- When this function is switched "ON", the BASS BOOST lamp on the front panel lights up.

#### Note:

The Bass Boost function affects the front speaker sounds only.

### Adjusting the Tone

You can adjust the treble and bass sounds as you like.

#### Before you start, remember...

- There is a time limit in doing the following steps. If the setting is canceled before you finish, start from step 1 again.

#### On the front panel ONLY:

1. Press ADJUST so that the cursor control  $\Delta/\nabla$  buttons work for adjusting the sound.

2. Press cursor control  $\Delta/\nabla$  repeatedly until "BASS +" or "TREBLE+" appears on the display.

- Select "BASS +" to adjust the bass sound level.
- Select "TREBLE+" to adjust the treble sound level.

3. Press cursor control  $\Delta/\nabla$  to adjust the bass or treble sound level within the range of -10 to +10.

- Each time you press the button, the sound level changes by 2.2 steps.

## Basic Settings

Some of the following settings are required after connecting and positioning your speakers in your listening room, while others will make operations easier.

### Changing the Source Name

When you have connected an MD recorder to the TAPE/MD jacks on the rear panel, change the source name shown on the display when you select the MD recorder as the source.

#### On the front panel ONLY:

1. Press TAPE/MD.
  - Make sure "TAPE" appears on the display.
2. Press and hold SOURCE NAME (the same button as TAPE/MD) until "M D" appears on the display.

To change the source name from "M D" to "TAPE," repeat the same procedure above (in step 1, make sure "M D" appears on the display).

#### Note:

- Without changing the source name, you can still use the connected components. However, there may be some inconvenience.
- TAPE will appear on the display when you select the MD recorder.
- You cannot use the COMPO LINK remote control system (see page 29) to operate the MD recorder.

### Setting Center and Rear Speakers for the DSP Modes

To obtain the best possible surround sound of the DSP (Digital Signal Processor) modes (see page 17), you have to register the information about the speaker arrangement after all connections are completed.

#### Center Speaker Setting

Register the center speaker size.

Before you start, remember...

- There is a time limit in doing the following steps. If the setting is canceled before you finish, start from step 1 again.

#### On the front panel ONLY:

1. Press SETTING so that the cursor control  $\Delta/\nabla$  buttons work for setting the center speaker size.
2. Press cursor control  $\Delta/\nabla$  repeatedly until "CNTR SPK" (Center Speaker) appears on the display.

#### On the front panel:

1. Press SETTING so that the cursor control  $\Delta/\nabla$  buttons work for setting the delay time.
2. Press cursor control  $\Delta/\nabla$  repeatedly until "DELAY +" appears on the display.
3. Press cursor control  $\Delta/\nabla$  to select an appropriate delay time.

DELAY 1: Select this mode when the distance from you to your rear speakers is greater than that to the front speakers.

DELAY 2: Select this mode when the distance from you to your rear speakers is almost equal to that to the front speakers.

DELAY 3: Select this mode when the distance from you to your rear speakers is less than that to the front speakers.

#### From the remote control:

1. Press SOUND CONTROL.
2. Press SURROUND repeatedly until "PROLOGIC" appears on the display.
3. Press DELAY repeatedly until an appropriate delay time appears on the display.

### Storing the Basic Settings and Adjustments — One Touch Operation

JVC's One Touch Operation function is used to assign and store different sound settings for each different playing source. By using this function, you do not have to change the settings every time you change the source. The stored settings for the newly selected source are automatically recalled.

The following can be stored for each source:

- Volume level (see page 9)
- Input Attenuator (see page 10)
- Balance (see page 10)
- Bass Boost (see page 10)
- Tone adjustment (see page 10)
- DSP modes
  - 3D-Phonic mode settings (see page 19)
  - DAP mode settings (see page 19)
  - Surround mode settings (see page 20)
- DVD MULTI playback mode settings (see page 22)

#### To store the sound settings

1. Press ONE TOUCH OPERATION.
  - The ONE TOUCH OPERATION lamp lights up, then the previously memorized settings are recalled.
2. Adjust the sound using the functions listed to the left.
  - The newly adjusted settings are memorized.

#### To recall the sound settings

With the ONE TOUCH OPERATION lamp lit, the settings for the currently selected source are recalled, when the source is selected.

#### To cancel the One Touch Operation function

Press ONE TOUCH OPERATION so that the lamp goes off. (Even though the One Touch Operation function is canceled, the recalled sound effects remain active.)

#### Notes:

- If the source is FM or AM (MW/LW), you can assign a different setting for each band.
- The DSP modes and DVD MULTI playback mode cannot be used at the same time.

#### Using the Sleep Timer

Using the Sleep Timer, you can fall asleep to music and know the receiver will turn off by itself rather than play all night.

#### From the remote control ONLY:

- Press SLEEP repeatedly.
- The SLEEP indicator lights up on the display, and the shut-off time changes as follows (in minutes):

10 — 20 — 30 — 40 — 50 — 60 — 70 — 80 — 0 (Canceled)

When the shut-off time comes

The receiver turns off automatically.

#### To check or change the time remaining until the shut-off time

Press SLEEP once. The remaining time until the shut off time appears in minutes.

- To change the shut-off time, press SLEEP repeatedly.

#### To cancel the Sleep Timer

Press SLEEP repeatedly until "0" appears on the display. (The SLEEP indicator goes off.) Turning off the power also cancels the Sleep Timer.

3. Press cursor control  $\Delta/\nabla$  to select your center speaker size.

LARGE: Select this mode when the size of the center speaker is the same as that of the front speakers.

SMALL: Select this mode when the size of the center speaker is smaller than that of the front speakers.

NO: Select this mode when you do not use a center speaker.

#### Rear Speaker Setting

Register whether you have connected the rear speakers or not.

Before you start, remember...

- There is a time limit in doing the following steps. If the setting is canceled before you finish, start from step 1 again.

#### On the front panel ONLY:

1. Press SETTING so that the cursor control  $\Delta/\nabla$  buttons work for setting the rear speaker information.
2. Press cursor control  $\Delta/\nabla$  repeatedly until "REAR SPK" (Rear Speaker) appears on the display.
3. Press cursor control  $\Delta/\nabla$  to register whether you have connected the rear speakers.

YES: Select this mode when you use rear speakers.

NO: Select this mode when you do not use rear speakers.

#### Note:

When you change your speakers, you need to register the information about the speakers again.

#### Delay Time Setting

Register the delay time of the sound from the rear speakers, comparing the sound from the front speakers.

Before you start, remember...

- There is a time limit in doing the following steps. If the setting is canceled before you finish, start from step 1 again.
- You can adjust the delay time only when you have connected the rear speakers and have set "REAR SPK" to "YES" (See above).
- Delay time setting is only valid for "PROLOGIC" (see page 17).

## Receiving Radio Broadcasts

You can browse through all the stations or use the preset function to go immediately to a particular station.

### Tuning in Stations Manually

#### On the front panel ONLY:

1. Press FM or AM.

The last station of the selected band is tuned in.

- The cursor control  $\Delta$  /  $\nabla$  /  $\triangleleft$  /  $\triangleright$  buttons can be now used for operating the tuner.

2. Press cursor control  $\Delta$  /  $\nabla$  repeatedly until “-TUNING+” appears on the display.

3. Press cursor control  $\triangleleft$  /  $\triangleright$  until you find the frequency you want.
  - Pressing  $\triangleleft$  decreases the frequency.
  - Pressing  $\triangleright$  increases the frequency.

#### Notes:

- When you hold cursor control  $\triangleleft$  /  $\triangleright$  in step 3, the frequency keeps changing until a station is tuned in.
- When a station of sufficient signal strength is tuned in, the TUNED indicator lights up on the display.
- When an FM stereo program is received, the STEREO indicator also lights up.

### Using Preset Tuning

Once a station is assigned to a channel number, the station can be quickly tuned. You can preset up to 30 FM and 15 AM (MW/LW) stations.

In order to use the special functions available for RDS broadcasts, you need to preset the RDS stations. Both PTY Search and EON functions (see pages 15 and 16) are applicable only to preset stations.

#### To store the preset stations

Before you start, remember...

- There is a time limit in doing the following steps. If the setting is canceled before you finish, start from step 1 again.

#### On the front panel ONLY:

1. Tune in the station you want to preset (see above). If you want to store the FM reception mode for this station, select the FM reception mode you want. See “Selecting the FM Reception Mode” on page 14.

#### Press MEMORY.

“CH-” appears and the channel number position starts flashing on the display for about 5 seconds.

3. Press cursor control  $\triangleleft$  /  $\triangleright$  to select a channel number while the channel number position is flashing.

### Selecting the FM Reception Mode

When an FM stereo broadcast is hard to receive or noisy

You can change the FM reception mode while receiving an FM broadcast.

#### On the front panel ONLY:

1. Press FM.
  - The cursor control  $\Delta$  /  $\nabla$  /  $\triangleleft$  /  $\triangleright$  buttons can be now used for operating the tuner.
2. Press cursor control  $\Delta$  /  $\nabla$  repeatedly until “FM MODE” appears on the display.

3. Press cursor control  $\triangleleft$  /  $\triangleright$  to switch the FM reception “FM AUTO” or “FM MONO.”

**FM AUTO:** When a program is broadcasted in stereo, you will hear stereo sound; when in monaural, you will hear monaural sounds. This mode is also useful to suppress static noise between stations. The MUTE/AUTO indicator lights up on the display.

**FM MONO:** Reception will be improved although you will lose the stereo effect. In this mode, you will hear noise while tuning into the stations. The MUTE/AUTO indicator goes off on the display.

### Using the RDS (Radio Data System) to Receive FM Stations

RDS allows FM stations to send an additional signal along with their regular program signals. For example, the stations send their station names, as well as information about what type of program they broadcast, such as sports or music, etc.

When tuned to an FM station which provides the RDS service, the RDS indicator lights up on the display. With the receiver, you can receive the following types of RDS signals.

**PS (Program Service):** shows commonly known station names.

**PTY (Program Type):** shows types of broadcast programs

**RT (Radio Text):** shows text messages the station sends

**EON (Enhanced Other Network):** see page 16.

#### Notes:

- RDS is not available for AM (MW/LW) broadcasts.
- RDS may not operate correctly if the station tuned is not transmitting RDS signal properly or if the signal strength is weak.

### What Information Can RDS Signals Provide?

You can see the RDS signals the station sends on the display.

To show the RDS signals  
Press DISPLAY MODE on the front panel (or DISPLAY on the remote control) while listening to an FM station.



On the front panel

- Each time you press the button, the display changes to show you the following information:



#### PS (Program Service):

While searching, “PS” appears and then the station names will be displayed. “NO PS” appears if no signal is sent.

#### PTY (Program Type):

While searching, “PTY” appears and then the type of the broadcast program will be displayed. “NO PTY” appears if no signal is sent.

#### RT (Radio Text):

While searching, “RT” appears and then text messages the station sends will be displayed. “NO RT” appears if no signal is sent.

#### Frequencies:

Station frequency (non-RDS service)

#### About characters shown on the display

When the display shows PS, PTY, or RT signals, the following characters are used.

- The display cannot differentiate upper case and lower case letters and always uses upper case letters.
- The display cannot show accented letters. “A,” for instance, may stand for accented “Å,” like “Å, Å, Å, Å, Å, and Å.”

#### Notes:

- When pressing DISPLAY on the remote control, make sure that you have selected FM station using the remote control. If not, the DISPLAY button does not work for tuner operation. (Pressing FM/AM activates the remote control for tuner operation.)
- If searching finishes at once, “PS”, “PTY”, and “RT” will not appear on the display.

**Searching for a Program by PTY Codes**

One of the advantages of the RDS service is that you can locate a particular kind of program from the preset channels (see page 13) by specifying the PTY codes.

- To stop searching any time during the process, press **PTY SEARCH** while searching.
- When pressing the buttons on the remote control, make sure that you have selected the FM station using the remote control. If not, the RDS operation buttons do not work for RDS operation. (Pressing **FM/AM** activates the remote control for RDS operation.)

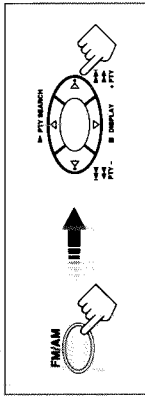

**To search for a program using the PTY codes**

Before you start, remember...

- The PTY Search is only applicable to preset stations only.
- There is a time limit in doing the following steps. If the setting is cancelled before you finish, start from step 1 again.

1. Press **PTY SEARCH** while listening to an FM station. "PTY" and "SELECT" alternate on the display.



2. Press and hold cursor control  $\triangleleft/\triangleright$  on the front panel (or **PTY SELECT + / -** on the remote control) until the PTY code you want appears on the display, while "PTY" and "SELECT" are flashing alternately.

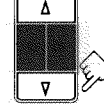

3. Press **PTY SEARCH** again, while the PTY code selected in the previous step is still on the display.

While searching, "SEARCH" and the selected PTY code alternate on the display. The receiver searches 30 preset FM stations, stops when it finds the one you have selected, and tunes in that station.

To continue searching after the first stop Press **PTY SEARCH** again while the indications on the display are flashing. If no program is found, "NOTFOUND" appears on the display.

**PTY codes**

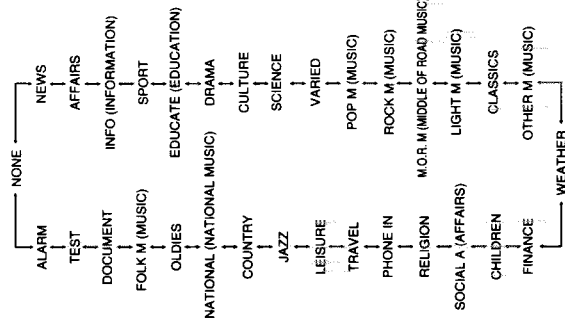

When an emergency broadcast (ALARM signal) is sent from an FM station: The receiver automatically tunes in the station except in the following cases:

- When you are listening to non-RDS stations (all AM — MW/LW and some FM stations).
- When the receiver is in standby mode.

While receiving an emergency broadcast, "ALARM" appears on the display.

The **TEST** signal is used for equipment test — whether it can receive the ALARM signal correctly. The TEST signal makes the receiver work in the same way as the ALARM signal does. If the TEST signal is received, the receiver automatically switches to the station broadcasting the TEST signal. While receiving the test signal, "TEST" appears on the display.

**Switching to a Broadcast Program of Your Choice Temporarily**

Another convenient RDS service is called "EON (Enhanced Other Network)". The EON indicator lights up while receiving a station with the EON code.

This allows the receiver to switch temporarily to a broadcast program of your choice (NEWS, TA, and/or INFO) from a different station except in the following cases:

- When you are listening to non-RDS stations (all AM — MW/LW and some FM stations).
- When the last received FM station is a non-RDS station.
- When the receiver is in standby mode.

Before you start, remember...

- The EON function is only applicable to preset stations only.

**On the front panel ONLY:**

1. Press **EON** so that the last selected program type appears on the display.

The receiver enters EON standby mode. When the receiver is in EON standby mode, the receiver is ready to receive the EON data (TA/NEWS/INFO) you select.

2. Press **TA/NEWS/INFO** until the program type you want appears on the display.

- Each time you press the button, the display changes to show the following:

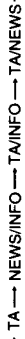

TA: Traffic Announcement in your area.

NEWS: News.

INFO: Program the purpose of which is to impart advice in the widest sense.

**CASE 1** If there is no station broadcasting the program you have selected

The receiver continues playing the current source (all sources except AM — MW/LW).



When a station starts broadcasting the program you have selected, the receiver automatically switches to the station. The indicator of received PTY code starts flashing.



When the program is over, the receiver goes back to the previously selected source, but still remains in EON standby mode. The indicator of received PTY code stops flashing and remains lit.

**CASE 2**

If there is a station broadcasting the program you have selected

The receiver changes the source (all sources except AM—MW/LW), and tunes in the station. The indicator of received PTY code starts flashing.



When the program is over, the receiver goes back to the previously selected source, but still remains in EON standby mode. The indicator of received PTY code stops flashing and remains lit.

**CASE 3**

If the FM station you are listening to is broadcasting the program you have selected

The receiver continues to receive the station, but the indicator of received PTY code starts flashing.



When the program is over, the indicator of received PTY code stops flashing and remains lit, but the receiver remains in EON standby mode.

**To stop listening to the program selected by EON**

Press **EON** so that the program type (TA/NEWS/INFO) indicator goes off from the display. The receiver enters EON off mode and goes back to the previously selected source.

- Each time you press **EON**, the EON mode alternates between standby mode and off mode.

**Notes:**

- EON data sent from some stations may not be compatible with this receiver.
- In EON standby mode, if you change the source to AM (MW/LW) or if you carry out synchronized recording (see page 23), EON standby mode is cancelled temporarily. The receiver goes back to EON standby mode again when you have finished that operation.
- While listening to a program tuned in by the EON function, you can not use the source selecting buttons and **PTY SEARCH** button.

**CAUTION:**

When the source alternates intermittently between the station tuned in by the EON function and the currently selected source, press **EON** to cancel the EON function. If you do not press the button, the currently tuned station is received finally, and the indication of the EON program type flashing on the display disappears.

## Using the DSP Modes

The built-in Surround Processor provides three types of the DSP (Digital Signal Processor) mode — 3D-PHONIC mode, DAP (Digital Acoustic Processor) mode and Surround mode (Dolby Pro Logic and JVC Theater Surround).

### 3D-PHONIC mode

The 3D-PHONIC mode gives you such a nearly surround effect as it is reproduced through the Dolby Surround decoder, which is widely used to reproduce sounds with a feeling of movement like those experienced in movie theaters. The 3D-PHONIC mode is the result of research on sound localization technology carried out at JVC for many years. **This mode can be used when two front speakers are connected to this receiver (without respect to the rear/center speaker connection).** You can select either 3D ACTION or 3D THEATER to your preference.

**3D ACTION:** Best for action and war movies — where the action is fast and explosive.

**3D THEATER:** Reproduces the sound field of a large theater.

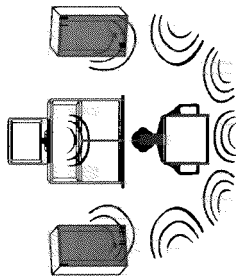

### DAP modes

The sound heard in a concert hall or club consists of direct sound and indirect sound — early reflections and reflections from behind. Direct sounds reach the listener directly without any reflection. On the other hand, indirect sounds are delayed by the distances of the ceiling and walls. These direct sounds and indirect sounds are the most important elements of the acoustic surround effects. The DAP mode can create these important elements, and gives you a real "being there" feeling. **This mode can be used when the front speakers are connected to this receiver (without respect to the rear/center speaker connection).** You can select one of the following to your preference.

**DANCE CLUB:** Gives a throbbing bass beat.

**LIVE CLUB:** Gives the feeling of a live music club with a low ceiling.

**HALL:** Gives clear vocal and the feeling of a concert hall.

**PAVILION:** Gives the spacious feeling of a pavilion with a high ceiling.

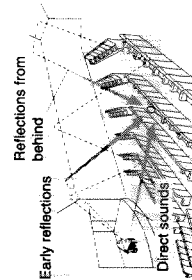

## Available DSP Modes According to the Speaker Arrangement

Available DSP modes will vary depending on how many speakers are used with this receiver. **Make sure that you have set the speaker information correctly (see page 11).**

Speaker arrangements	Available DSP modes
	Each time you press SURROUND, the DSP modes change as follows: <ul style="list-style-type: none"> <li>• 3D THEATER</li> <li>• DANCE C (DANCE CLUB)</li> <li>• LIVE C (LIVE CLUB)</li> <li>• HALL</li> <li>• PAVILION</li> <li>• 3D ACTION</li> <li>• OFF (DSP mode is canceled)</li> </ul>
	Each time you press SURROUND, the DSP modes change as follows: <ul style="list-style-type: none"> <li>• 3 STEREO</li> <li>• 3D THEATER</li> <li>• DANCE C (DANCE CLUB)</li> <li>• LIVE C (LIVE CLUB)</li> <li>• HALL</li> <li>• PAVILION</li> <li>• 3D ACTION</li> <li>• OFF (DSP mode is canceled)</li> </ul>
	Each time you press SURROUND, the DSP modes change as follows: <ul style="list-style-type: none"> <li>• PRO LOGIC</li> <li>• THEATER</li> <li>• DANCE C (DANCE CLUB)</li> <li>• LIVE C (LIVE CLUB)</li> <li>• HALL</li> <li>• PAVILION</li> <li>• 3D ACTION</li> <li>• OFF (DSP mode is canceled)</li> </ul>
	Each time you press SURROUND, the DSP modes change as follows: <ul style="list-style-type: none"> <li>• PRO LOGIC</li> <li>• THEATER</li> <li>• DANCE C (DANCE CLUB)</li> <li>• LIVE C (LIVE CLUB)</li> <li>• HALL</li> <li>• PAVILION</li> <li>• 3D ACTION</li> <li>• OFF (DSP mode is canceled)</li> </ul>

### Surround Modes

With this receiver, you can use two types of the Surround modes.

#### • Dolby Surround

Dolby Surround has been developed to reproduce the important elements of the acoustic surround at home.

To watch the soundtracks of video software bearing the mark which includes the same encoded surround information as found in Dolby Stereo films, the receiver can provide you with Dolby Surround decoder.

There are two types of Dolby Surround — "Pro Logic" and "3 Stereo". "Pro Logic" can be used when the front speakers and rear speakers are connected to this receiver (regardless of the center speaker connection). On the other hand, "3 Stereo" can be used when the rear speakers are not connected (center speaker must be connected).

#### • JVC Theater Surround

In order to reproduce a more realistic sound field in your listening room while playing soundtracks of video software bearing the mark , JVC Theater Surround has been designed to give you clearer vocals and to create a real "being there" feeling. **This mode can be used when the front speakers and rear speakers are connected to this receiver (without respect to the center speaker connection).**

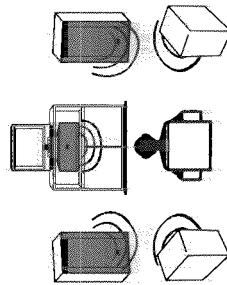

### Notes:

- The DSP modes have no effect on monaural sources.
- The DSP modes cannot be used for recording.
- When you select "DVMULTI" as the source to play, you cannot select or adjust the DSP modes.

### IMPORTANT:

Before recording, turn off the DVD MULTI playback mode.

As for the DVD MULTI playback mode, see page 22.

• Manufactured under license from Dolby Laboratories Licensing Corporation. "Dolby," the double-D symbol, and "Pro Logic" are trademarks of Dolby Laboratories Licensing Corporation.

**Adjusting the 3D-PHONIC Modes**

Before you start, remember...  
 • Make sure that you have set the speaker information correctly (see page 11).  
 • There is a time limit in doing the following steps. If the setting is canceled before you finish, start from step 1 again.  
 • You can only adjust the rear speaker output level when you have connected the rear speakers and have set "REAR SPK" to "YES."  
 See page 11.

**On the front panel:**  
 1. Press SURROUND repeatedly until "3D-ACTION" or "3D-THEATR" appears on the display.  
 The 3D-PHONIC and PRO LOGIC indicators also light up on the display.

2. Press ADJUST so that the cursor control  $\Delta/\nabla/\triangleleft/\triangleright$  buttons work for adjusting the surround setting.

3. Press cursor control  $\Delta/\nabla$  repeatedly until "EFFECT +" appears on the display.

4. Press cursor control  $\triangleleft/\triangleright$  to select an effect level you want.  
 • Each time you press the button, the effect level changes as follows:  
 EFFECT 1  $\leftrightarrow$  EFFECT 2  $\leftrightarrow$  EFFECT 3  $\leftrightarrow$  EFFECT 4  $\leftrightarrow$  EFFECT 5

As the number increases, the selected 3D-PHONIC mode becomes stronger.

**From the remote control:**

1. Press SOUND CONTROL. The 10 keys are activated for sound adjustments.  
 2. Press SURROUND repeatedly until "3D-ACTION" or "3D-THEATR" appears on the display.  
 The 3D-PHONIC and PRO LOGIC indicators also light up on the display.

3. Press EFFECT to select an effect level you want.  
 • Each time you press the button, the effect level changes as follows:  
 EFFECT 1  $\leftrightarrow$  EFFECT 2  $\leftrightarrow$  EFFECT 3  $\leftrightarrow$  EFFECT 4  $\leftrightarrow$  EFFECT 5

As the number increases, the selected 3D-PHONIC mode becomes stronger.

**Adjusting the DAP Modes**

Before you start, remember...  
 • Make sure that you have set the speaker information correctly (see page 11).  
 • There is a time limit in doing the following steps. If the setting is canceled before you finish, start from step 1 again.  
 • You can only adjust the rear speaker output level when you have connected the rear speakers and have set "REAR SPK" to "YES."  
 See page 11.

**On the front panel:**

1. Press SURROUND repeatedly until the DAP mode — DANCE CLUB, LIVE CLUB, HALL, or PAVILION — appears on the display.  
 The DAP indicator also lights up on the display.

2. Press ADJUST so that the cursor control  $\Delta/\nabla/\triangleleft/\triangleright$  buttons work for adjusting the DSP setting.

3. Press cursor control  $\Delta/\nabla$  repeatedly until "REAR +" appears on the display.

4. Press cursor control  $\triangleleft/\triangleright$  to adjust the rear speaker output level (from -10 to +10).

**Note:**  
 You cannot adjust the left and right rear speaker output levels separately.

5. Press cursor control  $\Delta/\nabla$  repeatedly until "EFFECT +" appears on the display.

6. Press cursor control  $\triangleleft/\triangleright$  to select an effect level you want.  
 • Each time you press the button, the effect level changes as follows:  
 EFFECT 1  $\leftrightarrow$  EFFECT 2  $\leftrightarrow$  EFFECT 3  $\leftrightarrow$  EFFECT 4  $\leftrightarrow$  EFFECT 5

As the number increases, the selected DAP mode becomes stronger.

**From the remote control:**

1. Press SOUND CONTROL. The 10 keys are activated for sound adjustments.  
 2. Press SURROUND repeatedly until the DAP mode — DANCE CLUB, LIVE CLUB, HALL, or PAVILION — appears on the display.  
 The DAP indicator also lights up on the display.

3. Press REAR-L, - / + to adjust the rear speaker output level.  
 • Pressing REAR-L, - decreases the output level up to -10 dB.  
 • Pressing REAR-L, + increases the output level up to +10 dB.

**Note:**  
 You cannot adjust the left and right rear speaker output levels separately.

4. Press EFFECT to select an effect level you want.  
 • Each time you press the button, the effect level changes as follows:  
 EFFECT 1  $\leftrightarrow$  EFFECT 2  $\leftrightarrow$  EFFECT 3  $\leftrightarrow$  EFFECT 4  $\leftrightarrow$  EFFECT 5

As the number increases, the selected DAP mode becomes stronger.

**Adjusting the Surround Modes — Dolby Surround and JVC Theater Surround**

Before you start, remember...  
 • Make sure that you have set the speaker information correctly (see page 11).  
 • There is a time limit in doing the following steps. If the setting is canceled before you finish, start from step 1 again.  
 • You can only adjust the effect level when selecting JVC Theater Surround.  
 • You can only adjust the rear and/or center speaker output levels when you have connected rear speakers and/or a center speaker and have set "REAR SPK" and/or "CNTR SPK" correctly. See page 11.

**From the remote control:**

1. Press SOUND CONTROL. The 10 keys are activated for sound adjustments.  
 2. Press SURROUND repeatedly until the mode — "PROLOGIC," "3-STEREO," or "THEATER" — appears on the display.  
 • For "PROLOGIC" and "3-STEREO," the PRO LOGIC indicator lights up on the display.  
 • For "THEATER," the PRO LOGIC and DAP indicators light up on the display.

3. Press TEST to check the speaker output balance.  
 "TEST" starts flashing on the display, and a test tone comes out of the speakers in the following order:  
 Left front speaker — Center speaker — Rear speaker — Right front speaker

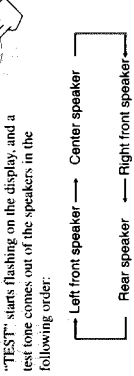

**Note:**  
 You can adjust the speaker output levels without outputting the test tone.

4. Press CENTER - / + repeatedly to adjust the center speaker output level (from -10 to +10).

5. Press REAR-L, - / + to adjust the rear speaker output level (from -10 to +10).

**Note:**  
 • You cannot adjust the left and right rear speaker output levels separately.  
 • You cannot use the REAR-R, - / + buttons to adjust the rear speaker output level.

6. Press TEST again to stop the test tone.

7. ONLY FOR "THEATER":  
 Press EFFECT to select an effect level you want.  
 • Each time you press the button, the effect level changes as follows:  
 EFFECT 1  $\leftrightarrow$  EFFECT 2  $\leftrightarrow$  EFFECT 3  $\leftrightarrow$  EFFECT 4  $\leftrightarrow$  EFFECT 5

As the number increases, JVC Theater Surround becomes stronger.

### On the front panel:

You can also use the buttons on the front panel to adjust the Surround modes. However, no test tone is available when using the buttons on the front panel. So, make adjustments while listening to the sound of the source played back.

1. Press SURROUND repeatedly until the mode — "PROLOGIC," "3 STEREO," or "THEATER," — appears on the display.  
The PROLOGIC indicator also lights up on the display.

2. Press ADJUST so that the cursor control  $\Delta / \nabla / \triangleleft / \triangleright$  buttons work for adjusting the DSP setting.

3. Press cursor control  $\Delta / \nabla$  repeatedly until "CENTER+" appears on the display.

4. Press cursor control  $\triangleleft / \triangleright$  to adjust the center speaker output level (from -10 to +10).

5. Press cursor control  $\Delta / \nabla$  repeatedly until "-REAR +" appears on the display.

6. Press cursor control  $\triangleleft / \triangleright$  to adjust the rear speaker output level (from -10 to +10).

**Note:**  
You cannot adjust the left and right rear speaker output levels separately.

7. ONLY FOR "THEATER":  
Press cursor control  $\Delta / \nabla$  repeatedly until "-EFFECT+" appears on the display.

8. ONLY FOR "THEATER":  
Press cursor control  $\triangleleft / \triangleright$  to select an effect level you want.

Each time you press the button, the effect level changes as follows:

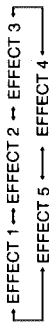

As the number increases, JVC Theater Surround becomes stronger.

### Activating the DSP Modes

Once you have finished adjustments for the DSP modes, you can use the same adjustments every time you want to use these modes.

#### On the front panel:

1. Press SURROUND repeatedly until the DSP mode you want appears on the display.  
• Each time you press the button, the DSP modes change. (See page 18 for more details.)

2. Select and play a sound source.

• To enjoy the 3D-PHONIC, Dolby Surround, and JVC Theater Surround, play back a software which was processed with Dolby Surround and is labeled with mark.

#### To cancel the DSP mode

Press SURROUND repeatedly until "OFF" appears on the display.

#### From the remote control:

1. Press SOUND CONTROL.  
The 10 keys are activated for sound adjustments.

2. Press SURROUND repeatedly until the DSP mode you want appears on the display.  
• Each time you press the button, the DSP modes change. (See page 18 for more details.)

3. Select and play a sound source.

• To enjoy the 3D-PHONIC, Dolby Surround, and JVC Theater Surround, play back a software which was processed with Dolby Surround and is labeled with mark.

#### To cancel the DSP mode

Press SURROUND repeatedly until "OFF" appears on the display in step 2 above.

## Using the DVD MULTI Playback Mode

This receiver provides the DVD MULTI playback mode for reproducing the analog discrete output mode of the DVD player. Before playing back a DVD, refer also to the manual supplied with the DVD player.

### Activating the DVD MULTI Playback Mode

You can adjust the DVD MULTI playback mode while playing back a DVD using the analog discrete output mode on the DVD player.

Once you made adjustments, the receiver memorizes the adjustments until you change them.

Before you start, remember...

- Make sure that you have set the speaker information correctly (see page 11).
- There is a time limit in doing the following steps. If the setting is canceled before you finish, start from step 1 again.
- You can only adjust the rear and/or center speaker output levels when you have connected rear speakers and/or a center speaker and have set "REAR SPK" and/or "CNTR SPK" correctly. (See page 11).

#### On the front panel:

1. Press DVD MULTI so that "DVDMULTI" appears on the display.

**Note:**

When you select "DVDMULTI" as the source to play, the DSP mode is canceled temporarily, and the SURROUND button does not work.

2. Select the analog discrete output mode on the DVD player, and start playing a DVD.

• Refer to the manual supplied with the DVD player.

If you need to make any adjustment, go to the following steps.

3. Press ADJUST so that the cursor control  $\Delta / \nabla / \triangleleft / \triangleright$  buttons work for adjusting the DVD MULTI playback setting.

4. Press cursor control  $\Delta / \nabla$  repeatedly until "CENTER+" appears on the display.

5. Press cursor control  $\triangleleft / \triangleright$  to adjust the center speaker output level (from -10 to +10).

6. Press cursor control  $\Delta / \nabla$  repeatedly until "-REAR L+" appears on the display.

7. Press cursor control  $\triangleleft / \triangleright$  to adjust the left rear speaker output level (from -10 to +10).

8. Press cursor control  $\Delta / \nabla$  repeatedly until "-REAR R+" appears on the display.

9. Press cursor control  $\triangleleft / \triangleright$  to adjust the right rear speaker output level (from -10 to +10).

#### From the remote control:

1. Press DVD MULTI so that "DVDMULTI" appears on the display.

**Note:**

When you select "DVDMULTI" as the source to play, the DSP mode is canceled temporarily, and the SURROUND button does not work.

2. Select the analog discrete output mode on the DVD player, and start playing a DVD.

• Refer to the manual supplied with the DVD player.

If you need to make any adjustment, go to the following steps.

3. Press SOUND CONTROL.  
The 10 keys are activated for adjusting the sound.

4. Press CENTER - / + to adjust the center speaker output level.  
• Pressing CENTER - decreases the output level up to -10 dB.  
• Pressing CENTER + increases the output level up to +10 dB.

5. Press REAR L - / + to adjust the left rear speaker output level.  
• Pressing REAR L - decreases the output level up to -10 dB.  
• Pressing REAR L + increases the output level up to +10 dB.

6. Press REAR R - / + to adjust the right rear speaker output level.  
• Pressing REAR R - decreases the output level up to -10 dB.  
• Pressing REAR R + increases the output level up to +10 dB.





**Cassette deck**

After pressing TAPE/MD, you can perform the following operations on a cassette deck:

- ▶ Starts playing.
- ▶ Fast winds the tape from right to left.
- ▶ Fast winds the tape from left to right.
- ▶ Stops operations.
- ▶ Pauses playing. To release it, press ▶.

**Note:**

To operate the cassette deck or MD recorder using the COMPULINK remote control system, set the source name correctly. (See page 11.)

**MD recorder**

After pressing TAPE/MD, you can perform the following operations on the MD recorder:

- ▶ Starts playing.
- ▶ Returns to the beginning of the current (or previous) track.
- ▶ Skips to the beginning of the next track.
- ▶ Stops playing.
- ▶ Pauses playing. To release it, press ▶.

**Note:**

To operate the cassette deck or MD recorder using the COMPULINK remote control system, set the source name correctly. (See page 11.)

**IMPORTANT:**

- To operate JVC's video components using this remote control:
  - Aim the remote control directly at the remote sensor on the VCR, DVD player or TV, not on the receiver.
  - Some JVC VCRs can accept two types of the control signals: remote code "A" and "B." Before using this remote control, make sure that the remote control code of the VCR connected to the VCR locks is set to code "A."

**VCR**

You can always perform the following operations:

- VCR ◁/▶: Turns on or off the VCR.
- VCR CH +/-: Changes the channels on the VCR.

After pressing VCR, you can perform the following operations on the VCR:

- ▶ Starts playing.
- ▶ Rewinds a tape.
- ▶ Fast winds a tape.
- ▶ Stops operations.
- ▶ Pauses playing. To release it, press ▶.

**Troubleshooting**

Use this chart to help you solve daily operational problems. If there is any problem you cannot solve, contact your JVC service center.

PROBLEM	POSSIBLE CAUSE	SOLUTION
The display does not light up.	The power cord is not plugged in.	Plug the power cord into an AC outlet.
No sound from speakers.	Speaker signal cables are not connected.	Check speaker wiring and reconnect if necessary.
	The SPEAKERS 1 and 2 buttons are not set correctly.	Press SPEAKERS 1 and 2 correctly.
	An incorrect source is selected.	Select the correct source.
	Muting is activated.	Press MUTING to cancel the mute.
Sound from one speaker only.	Speaker signal cables are not connected properly.	Check speaker wiring and reconnect if necessary.
	The balance is set to one extreme.	Adjust the balance properly (see page 10).
Continuous hiss or buzzing during FM reception.	Incoming signal is too weak.	Connect an outside FM antenna or contact your dealer.
	The station is too far away.	Select a new station.
	An incorrect antenna is used.	Check with your dealer to be sure you have the correct antenna.
	Antennas are not connected properly.	Check connections.
Occasional cracking noise during FM reception.	Ignition noise from automobiles.	Move the antenna farther from automobile traffic.
Howling during record playing.	Your turntable is too close to speakers.	Move speakers away from the turntable.
"OVERLOAD" starts flashing on the display.	Speakers are overloaded because of high volume.	Rotate the MASTER VOLUME control counterclockwise three or four times, then press STANDBY/ON ◁/▶ on the front panel. If "OVERLOAD" does not disappear, unplug the AC power cord, then plug it back again.
	Speakers are overloaded because of short circuit of speaker terminals.	Press STANDBY/ON ◁/▶ on the front panel, then check the speaker wiring. If "OVERLOAD" does not disappear, unplug the AC power cord, then plug it back again. If speaker wiring is not short-circuited, contact your dealer.
Remote control does not work.	There is an obstruction in front of the remote sensor on the receiver.	Remove the obstruction.
	Batteries are weak.	Replace batteries.

**Specifications**

**Amplifier**

**Output Power**

At Stereo operation: 55 watts per channel, min. RMS, both channels driven into 4 ohms at 1kHz, with no more than 0.9 % total harmonic distortion. (IEC268-3/DIN)

At Surround operation:

**Front Channel:** 50 watts per channel, min. RMS, driven into 4 ohms at 1 kHz, with no more than 0.8 % total harmonic distortion.

**Center channel:** 50 watts, min. RMS, driven into 4 ohms at 1 kHz, with no more than 0.8 % total harmonic distortion.

**Rear channel:** 50 watts per channel, min. RMS, driven into 4 ohms at 1 kHz, with no more than 0.8 % total harmonic distortion.

**Total Harmonic Distortion** (4 ohms, 1 kHz): 0.8 % \* at 55 watts output (\* Measured by JVC Audio Analysis System)

**Audio Input Sensitivity/Impedance** (1 kHz):  
 PHONO (MM): 1.5 mV/47 k ohms  
 CD, TAPE/MD, VCR, DVD: 120 mV/47 k ohms

**Audio Output Level:** TAPE/MD, VCR 120 mV

**Signal-to-Noise Ratio** (66 IHF/DIN):  
 PHONO: 70 dB/66 dB  
 CD, TAPE/MD, VCR, DVD: 87 dB/67 dB

**Frequency Response** (8 ohms):  
 PHONO: 20 Hz to 20 kHz (±1 dB)  
 CD, TAPE/MD, VCR, DVD: 20 Hz to 20 kHz (±1 dB)

**RIAA Phono Equalization:** ±1.0 dB (20 Hz to 20 kHz)

**FM tuner (DHF)**

**Tuning Range:** 87.50 MHz to 108.00 MHz

**Usable Sensitivity:** Monaural: 17.0 dBf (1.95 µV/75 ohms)

**50 dB Quieting Sensitivity:**  
 Monaural: 21.3 dBf (3.2 µV/75 ohms)  
 Stereo: 41.3 dBf (31.5 µV/75 ohms)

**Signal-to-Noise Ratio (IHF-A weighted):**  
 Monaural: 78 dB at 85 dBf  
 Stereo: 73 dB at 85 dBf

**Total Harmonic Distortion:**  
 Monaural: 0.4 % at 1 kHz  
 Stereo: 0.6 % at 1 kHz

**Stereo Separation at REC OUT:** 35 dB at 1 kHz

**Alternate Channel Selectivity:** 60 dB (±400 kHz)

**Frequency Response:** 30 Hz to 15 kHz, (+0.5 dB, -3 dB)

**AM (MW/LW) tuner**

**Tuning Range:** MW: 522 kHz to 1,629 kHz  
 LW: 144 kHz to 288 kHz

**Usable Sensitivity:** Loop antenna 400 µV/m (MW)

**Signal-to-Noise Ratio:** 50 dB (100 mV/m)

**General**

**Power Requirements:** AC 230V<sup>~</sup>, 50 Hz

**Power Consumption:** 170 watts (at operation)  
 2 watts (in standby mode)

**Dimensions (W x H x D):** 435 x 146 x 403.5 mm  
 (17 1/8 x 5 7/8 x 15 7/16 inches)

**Mass:** 8.9 kg (19.7 lbs)

Designs & specifications are subject to change without notice.

## Description of Major ICs

### ■ MN173222BA(IC401) : System Controller

#### 1.Key Matrix

	KEY OUT 0	KEY OUT1	KEY OUT 2	KEY OUT 3	KEY OUT 4	KEY OUT 5
KEY IN 0	POWER	SURROUND	DVD MULTI	←	CD	EON
KEY IN 1	ADJUST	ONE TOUCH OPERATION	DVD	→	PHONE	TA/NEWS INFO
KEY IN 2	SETTING	INPUT ATT	VCR	↑	TAPE/MD	PTY SEARCH
KEY IN 3	MEMORY	—————	FM	↓	AM	DISPLAY MODE

#### 2.Pin Function (1/2)

Pin No.	Symbol	I/O	Function
1,2	IN1,2	I	Volume jog signal input
3,4	VIDEO1,2	O	Video signal switch output
5	PROTECT	I	Protect signal input of speaker
6	POWER	O	Power ON output
7~10	KI0~3	I	Key matrix signal input
11	VCR /S/C	-	Not used
12~21	G11~G2	O	FL grid signal output
22	G1/KO7	O	FL grid signal output / Key matrix signal output
23	VPP	-	Power supply
24~39	S1~16	O	FL segment control signal output
40	B.BOOST LED	O	Bass boost indicator control
41	CLK.D	O	Clock signal output to DSP
42	DATAIN.D	I	Data signal input from DSP
43	DATAOUT.D	O	Data signal output to DSP
44	INH	I	Inhibit detection signal input
45	RDS CLK	I	Clock signal input from RDS
46	RDS DATA	I	Data input from RDS
47	SW DATA	O	Function switch data signal output
48	REMOCON IN	I	Remote control signal input
49	RDS D.ST	I	Data start signal for block data to output serial data
50	STEREO	I	Stereo indicator output. Stereo "L" Mono "H"
51	TUNED	I	When the set is tuning, this terminal becomes "L"
52	CE.PLL	O	Chip enable output to IC121
53	CK.PLL	I/O	Clock signal for IC121
54	SW.CLK	O	Function switch clock signal output
55	DO.PLL	I/O	Tuner PLL data
56	DCS IN	I	Compulink signal input
57	DCS OUT	O	Compulink signal output
58	ERR.DSP	I	DSP control data input
59	IFOK.DSP	I	DSP control data input
60	ACK.DSP	I	DSP control data input
61	CD.DSP	O	DSP control data output
62	RELAY Sch	O	Rear ch relay control signal output
63	T.MUTE	O	TUNER mute signal outut
64	TV COUNT	O	Subwoofer mute signal output

## RX-558VBK/RX-558RBK

### 2.Pin Function (2/2)

Pin No.	Symbol	I/O	Function
65	TV OUT	-	Not used
66	VCR OUT	-	Not used
67	VCR IN	-	Not used
68	RESET IN	I	Reset signal input
69	X1	-	Connect to GND
70	X2	-	Non connect
71	VSS	-	Connect to GND
72	OSC2	-	Oscillation terminal
73	OSC1	-	Oscillation terminal
74	VDD	-	Power supply
75	RELAY Cch	O	Center ch relay control signal output
76	RELAY L/R	O	Front ch relay control signal output
77	SURROUND	O	Surround ON/OFF control
78	INPUT ATT LED	O	INPUT ATT. Indicator control
79	ONE T. LED	O	ONE TOUCH OPERATION indicator control
80	STANDBY LED	O	STANDBY indicator control
81	STB-SW	O	Strobe signal output of function seitch
82	VOLUME DATA	O	Data output to IC341
83	VOLUME CLK	O	Clock signal output to IC341
84	VOLUMESTB	O	Strobe signal output to IC341

**■ LA1838(IC102): FM AM IF AMP&detector, FM MPX Decoder**

1. Block Diagram

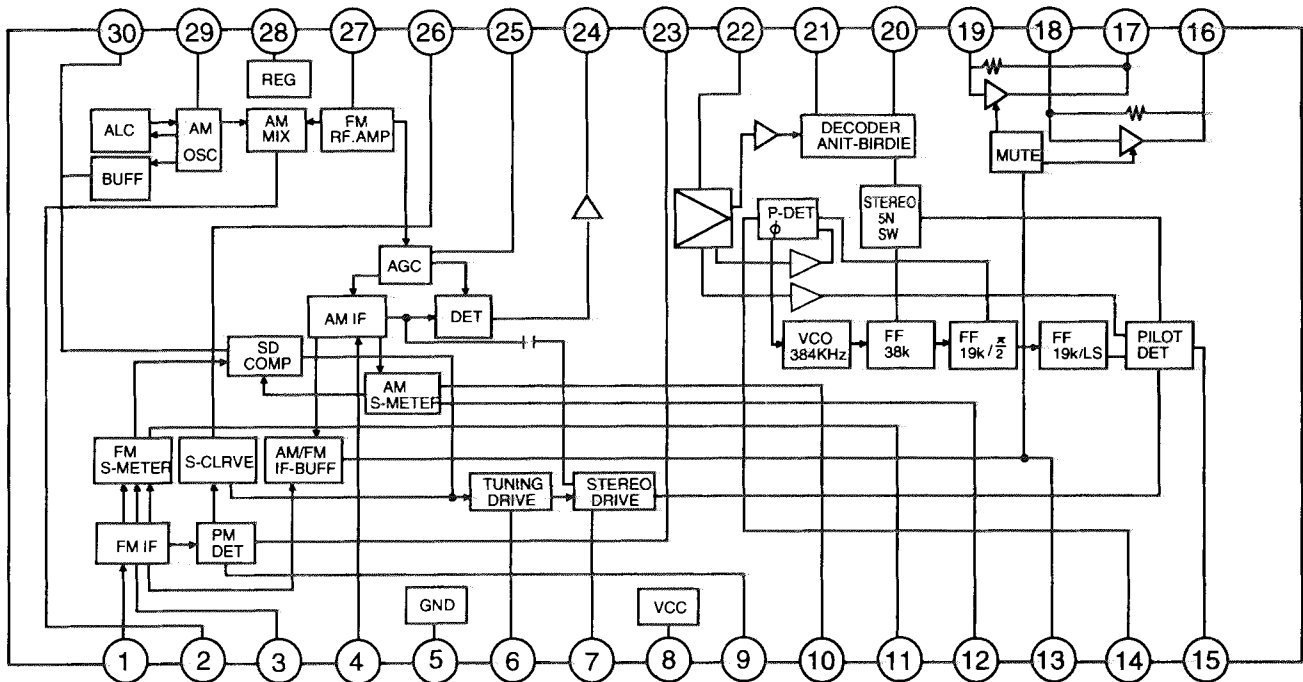

2. Pin Function

Pin No.	Symbol	I/O	Function	Pin No.	Symbol	I/O	Function
1	FM IN	I	This is an input terminal of FM IF signal.	16	L OUT	O	Left channel signal output.
2	AM MIX	O	This is an out put terminal for AM mixer.	17	R OUT	O	Right channel signal output.
3	FM IF	I	Bypass of FM IF	18	L IN	I	Input terminal of the Left channel post AMP.
4	AM IF	I	Input of AM IF Signal.	19	R IN	I	Input terminal of the Right channel post AMP.
5	GND	—	This is the device ground terminal.	20	RO	O	Mpx Right channel signal output.
6	TUNED	O	When the set is tuning,this terminal becomes "L".	21	LO	O	Mpx Left channel signal output.
7	STEREO	O	Stereo indicator output. Stereo "L", Mono: "H"	22	IF IN	I	Mpx input terminal
8	VCC	—	This is the power supply terminal.	23	FM OUT	O	FM detection output.
9	FM DET	—	FM detect transformer.	24	AM DET	O	AM detection output.
10	AM SD	—	This is a terminal of AM ceramic filter.	25	AM AGC	I	This is an AGC voltage input terminal for AM
11	FM VSM	O	Adjust FM SD sensitivity.	26	AFC	—	This is an output terminal of voltage for FM-AFC.
12	AM VSM	O	Adjust AM SD sensitivity.	27	AM RF	I	AM RF signal input.
13	MUTE	I/O	When the signal of IF REQ of IC121( LC72131) appear, the signal of FM/AM IF output. //Muting control input.	28	REG	O	Register value between pin 26 and pin28 desides the frequency width of the input signal.
14	FM/AM	I	Change over the FM/AM input. "H" :FM, "L" : AM	29	AM OSC	—	This is a terminal of AM Local oscillation circuit.
15	MONO/ST	O	Stereo : "H", Mono: "L"	30	OSC BUFFER	O	AM Local oscillation Signal output.

■ LC72136N(IC121):PLL Frequency synthesizer

1. Layout

XT	1	22	XT
FM/AM	2	21	GND
CE	3	20	LPFOUT
DI	4	19	LPFIN
CLOCK	5	18	PD
DO	6	17	VCC
FM/ST/VCO	7	16	FMIN
AM/FM	8	15	AMIN
	9	14	
	10	13	IFCONT
SDIN	11	12	IFIN

2. Block

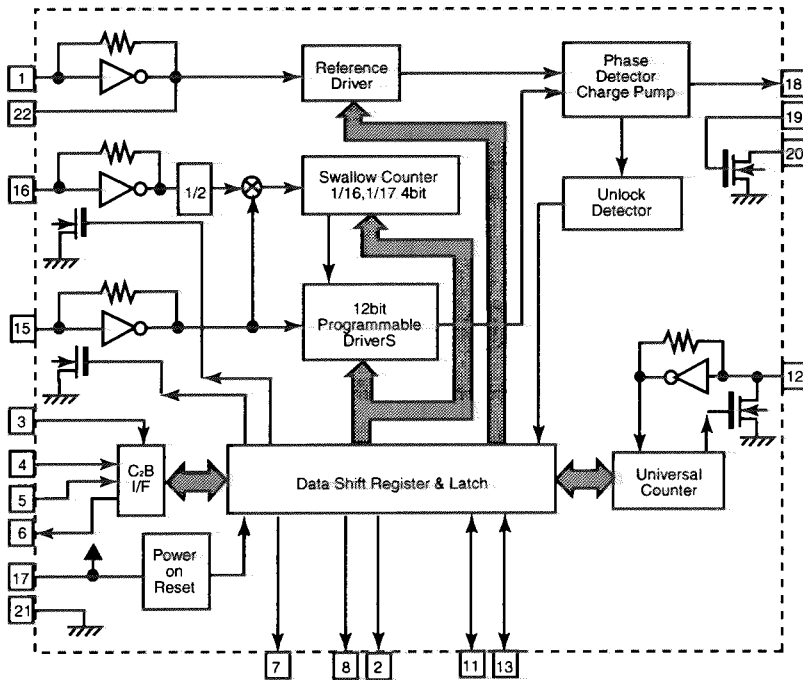

3. Function

Pin No.	Symbol	I/O	Function	Pin No.	Symbol	I/O	Function
1	XT	I	X'tal oscillator connect (75kHz)	12	IFIN	I	IF counter signal input
2	FM/AM	O	LOW:FM mode	13	IFCONT	O	IF signal output
3	CE	I	When data output/input for 4pin(input) and 6pin(output): H	14		-	Not use
4	DI	I	Input for receive the sirisl data from controller	15	AMIN	I	AM Local OSC signal output
5	CLOCK	I	Sync signal input use	16	FMIN	I	FM Local OSC signal input
6	DO	O	Data output for Controller Output port	17	VCC	-	Power supply(VDD=4.5-5.5V) When power ON:Reset circuit move
7	FM/ST/VCO	O	"Low": MW mode	18	PD	O	PLL charge pump output(H: Local OSC frequency Height than Reference frequency. L: Low Agreement: Height impedance)
8	AM/FM	O	Not use	19	LPFIN	I	Input for active lowpassfilter of PLL
9		-	Not use	20	LPFOUT	O	Output for active lowpassfilter of PLL
10		-	Input/output port	21	GND	-	Connected to GND
11	SDIN	I/O	Data input/output	22	XT	I	X'tal oscillator(75KHz)

■ M62446FP(IC341): 6CH MASTER VOLUME

1. Block Diagram

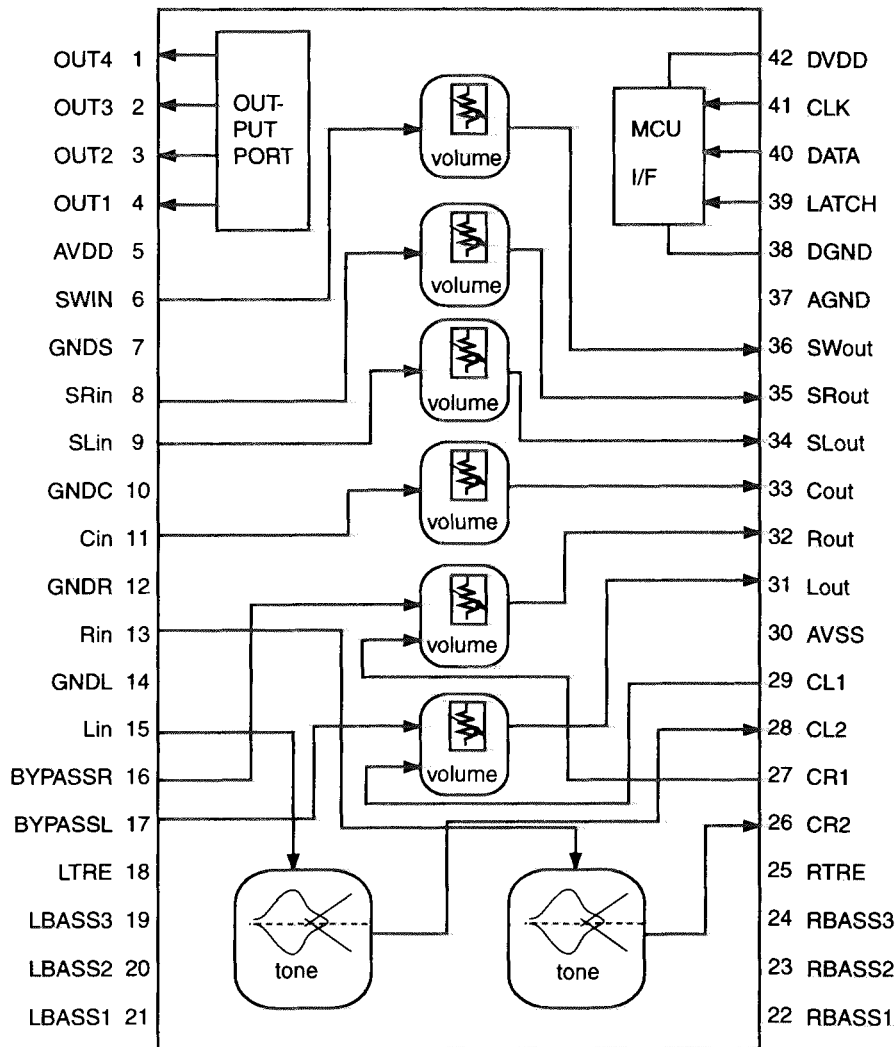

## RX-558VBK/RX-558RBK

### 2.Pin Function

Pin No.	Symbol	I/O	Descriptions
1	SURROUND	O	SURROUND control terminal
2	BASS BOOST	O	BASS BOOST control terminal
3	INPUT-ATT	O	Input attenuator control terminal
4	MUTING	O	MUTING control terminal
5	AVDD	-	Analog positive power supply terminal
6	SWIN	I	SUB Woofer volume signal input terminal
7	A.GND	-	Analog ground terminal
8	RR IN	I	R ch volume signal input terminal for rear speaker
9	RL IN	I	L ch volume signal input terminal for rear speaker
10	A.GND	-	Analog ground terminal
11	C IN	I	Center volume signal input terminal
12	A.GND	-	Analog ground terminal
13	R IN	I	R ch volume signal input terminal
14	A.GND	-	Analog ground terminal
15	L IN	I	L ch volume signal input terminal
16,17		-	Non connect
18		-	Frequency adjustment terminal tone/treble
19~21		-	Frequency adjustment terminal tone/bass
22		O	Tone output terminal
23,24		-	Frequency adjustment terminal tone/bass
25		-	Frequency adjustment terminal tone/treble
26		-	Frequency adjustment terminal tone/bass
27		I	L/R volume input terminal
28		O	Tone output terminal
29		I	L/R volume input terminal
30	AVSS	-	Analog negative power supply terminal
31	L OUT	O	L ch output
32	R OUT	O	R ch output
33	C OUT	O	Center volume signal output terminal
34	RL OUT	O	L ch volume signal output terminal for rear speaker
35	RR OUT	O	R ch volume signal output terminal for rear speaker
36	SW OUT	O	SUB Woofer volume signal output terminal
37	A.GND	-	Analog ground terminal
38	D.GND	-	Digital ground terminal
39	VOL STB	I	Latch input terminal
40	VOL DATA	I	Volume data input terminal
41	VOL CLK	I	Clock input terminal for data transfer
42	DVDD	-	Digital power supply terminal



■ SAA6588 (IC191) : RDS Detector (only RX-558RBK)

1.Terminal Layout



2.Pin Functiont

Pin No.	Symbol	I/O	Function
1	MRO	O	Multi-path rectifier output
2	NC	-	Non connect
3	GND	I	Test control input pin
4	OSCO	O	Oscillator output
5	OSCI	I	Oscillator input
6	VSSD	-	Digital ground (0V)
7	VDDD	-	Digital power supply (5V)
8	DAVN	O	Data available output (active LOW)
9	SDA	I/O	IC-bus serial data I/O
10	SCL	I	IC-bus serial clock input
11	NC	-	Non connect
12	GND	-	Connect to ground
13	NC	-	Non connect
14	VDDA	-	Analog power supply (5V)
15	VSSA	-	Connect to ground
16	MPX	I	Multiplex input signal
17	Vref	O	Reference voltage output
18	SCOUT	O	Band-pass filter output
19	CIN	O	Comparator output
20	NC	I	Level input

3.Block Diagram

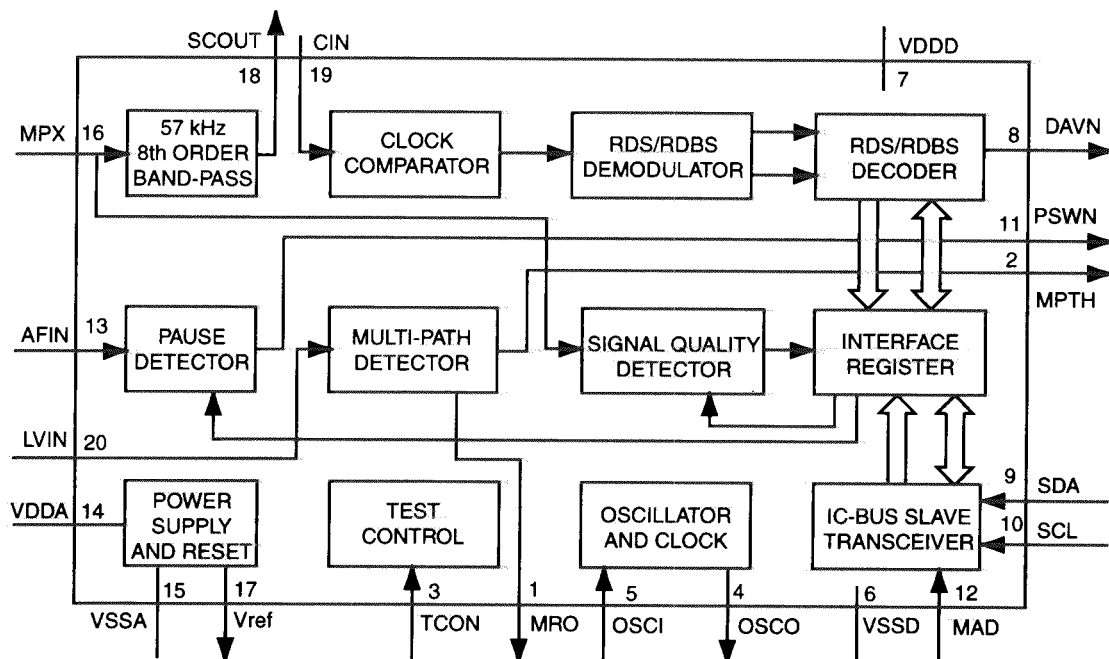

■ TC9471F(IC601) : Dolby Prologic

1. Block Diagram

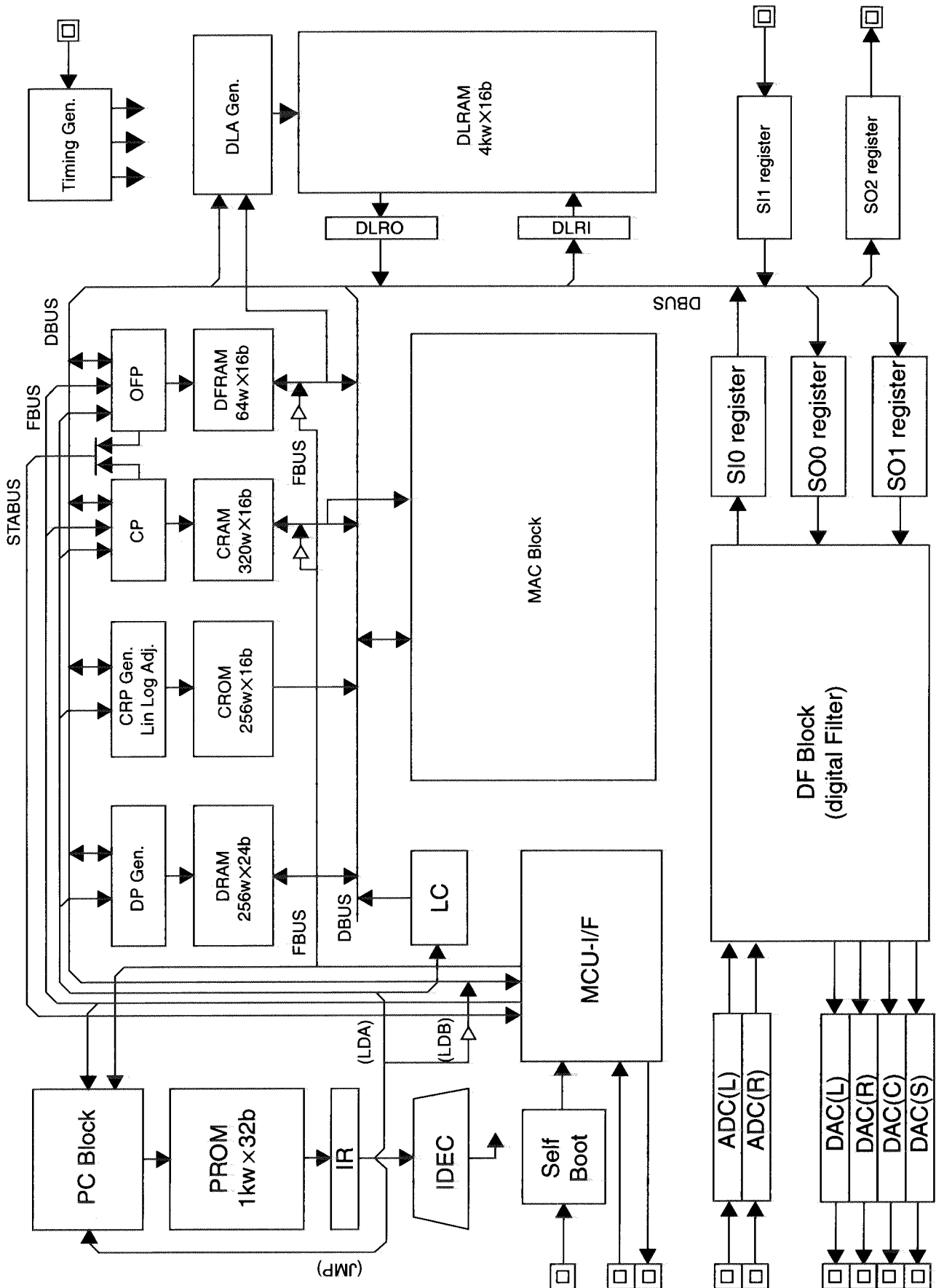

## 2.Pin Function (1/2)

Pin No.	Symbol	I/O	Function
1	ECKO	-	Non connect
2	ECKI	I	Amplifier input terminal for external clock input.
3	A.GND	-	Ground terminal.(For crystal oscillator circuit)
4	A.GND	-	Ground terminal.(For DAC L channel)
5	LchOUT	O	DAC analog signal output terminal.(L channel)
6	V-REF1	-	Reference voltage terminal.(For DAC L channel)
7	A.5V	-	Power supply terminal.(For DAC L channel)
8	A.5V	-	Power supply terminal.(For DAC R channel)
9	V-REF2	-	Reference voltage terminal.(For DAC R channel)
10	RchOUT	O	DAC analog signal output terminal.(R channel)
11	A.GND	-	Ground terminal.(For DAC R channel)
12	A.GND	-	Ground terminal.(For DAC C channel)
13	N.C	O	DAC analog signal output terminal.(C channel)
14	CchOUT	O	DAC analog signal output terminal with attenuator.(For C channel)
15	V-REF3	-	Reference voltage terminal.(For DAC C channel)
16	A.5V	-	Power supply terminal.(For DAC C channel)
17	VRO	O	Reference voltage terminal for attenuator.(Output buffer)
18	VRI	I	Reference voltage terminal for attenuator.(Input buffer)
19	A.5V	-	Power supply terminal.(For DAC S channel)
20	V-REF4	-	Reference voltage terminal.(For DAC S channel)
21	SchOUT	O	DAC analog signal output terminal with attenuator.(For S channel)
22	NC	-	Non connect.
23	A.GND	-	Ground terminal.(For DAC S channel)
24	D.GND	-	Ground terminal.
25~29	NC	-	Non connect.
30	D.5V	-	Power supply terminal.
31	D.5V	-	Power supply terminal.(For DLRAM)
32	D.GND	-	Ground terminal.(For DLRAM)
33~43	NC	-	Non connect.
44	D.GND	-	Ground terminal.
45.46	NC	-	Non connect.
47	D.5V	-	Power supply terminal.
48~53	NC	-	Non connect.
54		-	Ground terminal.
55		-	Power supply.
56		-	Ground terminal.
57	RESET	I	Power supply.

# RX-558VBK/RX-558RBK

## 2.Pin Function (2/2)

Pin No.	Symbol	I/O	Function
58	D.5V	-	Power supply terminal
59~71		-	Non connect.
72	DSP-CS	I	Chip select signal input terminal.(MCU interface)
73	DSP-CLK	I	Data sift clock input terminal.(MCU interface)
74	DATA-IN	I/O	Data input terminal.(MCU interface) At the IC bus mode,data input /output terminal.
75	DATA-OUT	O	Data output terminal.(MCU interface) At the IC bus mode,normally open.
76	DSP-IFOK	O	Operation flag output terminal.(MCU interface)
77	DSP-ACK	O	Acknowledge signal output terminal.(MCU interface)
78	DSP-ERR	O	Error flag output terminal.(MCU interface)
79	I2CS	I	IC bus mode select terminal.
80	BOOT	I	Self-boot control terminal.
81,82			Non connect.
83	D.5V	-	Power supply terminal.
84~87		-	Ground terminal.
88	D.GND	-	Digital ground terminal.(For ADC L channel)
89	A.GND	-	Analog ground terminal.(For ADC L channel)
90	LchIN	I	ADC analog signal input terminal.(L channel)
91	V-REF5	-	Reference voltage terminal.(For ADC L channel)
92,93	A.5V	-	Analog power supply terminal.
94	V-REF6	-	Reference voltage terminal.(For ADC R channel)
95	RchIN	-	ADC analog signal input terminal.(R channel)
96,97	A.GND	-	Analog ground terminal.(For ADC R channel)
98	XI	I	Crystal oscillator connection terminal.(input)
99	XO	O	Crystal oscillator connection terminal.(output)
100	A.5V	-	Power supply terminal.(For crystal oscillator circuit)

## ■ NJM2246D(IC201):Video Switch

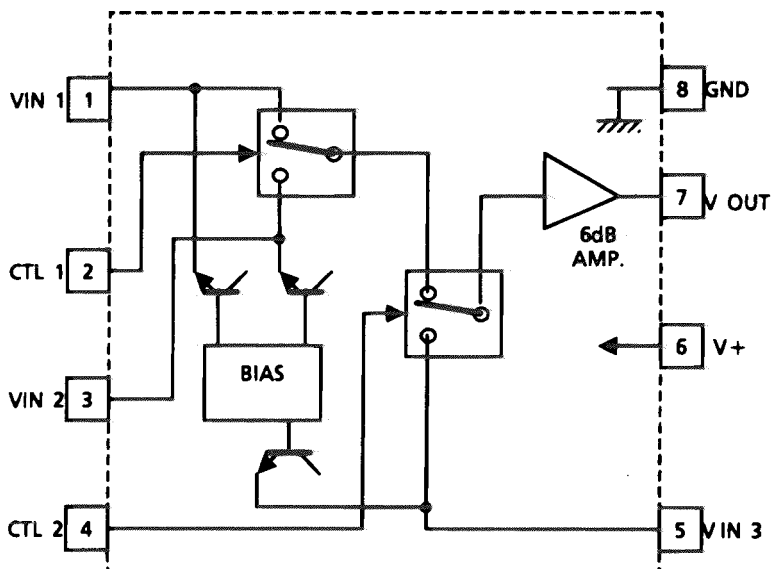

Control Signal - Output Signal

CTL 1	CTL 2	Output
L	L	VIN 1
H	L	VIN 2
L/H	H	VIN 3



## Disassembly Procedures

### (1) Top cover removal (Fig.1)

- 1.Remove 4 screws "A" on both sides of the top cover and 3 screws "B" on the rear side.
- 2.Lift the back of the top cover spreading both sides to remove.

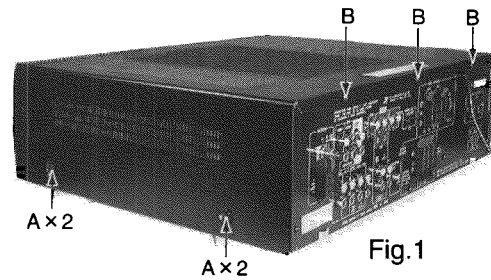

### (2) Front panel assembly removal (Fig.2,3)

- 1.Remove the top cover.
- 2.Remove 4 screws "C" on the bottom side and 3 screws "D" on the top side.
- 3.Disconnect the wire CN811 on the MAIN P.C.Board.
- 4.Disconnect the wire CN314 on the AUDIO P.C.Board.
- 5.Remove the front panel assembly.

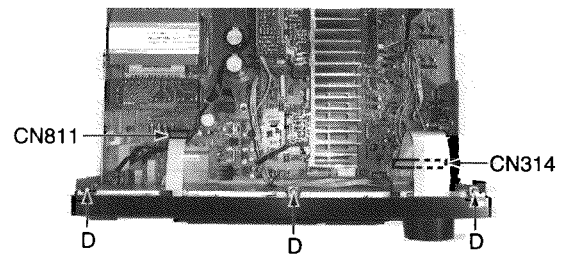
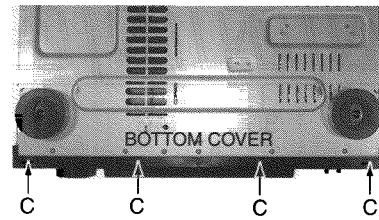

### (3) Rear panel removal (Fig.4)

- 1.Remove the top cover.
- 2.Remove 21 screws "E" on the rear panel.  
\* In U version, the screws "E" is 24  
\* In E,EN,B version, the screws "E" is 17
- 3.Remove the power cord stopper up side.
- 4.Remove the rear panel.

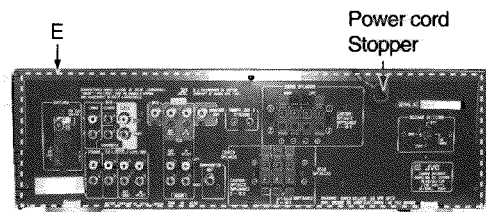

### (4) Remove TUNER P.C.Board and VIDEO P.C.Board (Fig.5)

- 1.Remove the rear panel.
- 2.Remove 1 screw "F" on the VIDEO P.C.Board
- 3.Disconnect the connector CN311 on the VIDEO P.C.Board
- 4.Disconnect the connector CN111 on the AUDIO P.C.Board.

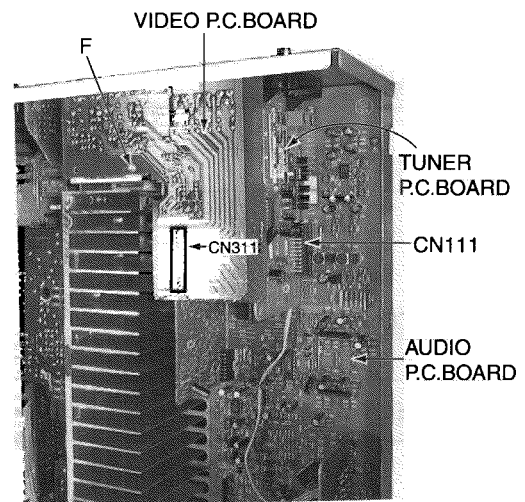

**(5)AUDIO P.C.BOARD Removal (Fig.6)**

- 1.Remove the rear panel.
- 2.Remove the VIDEO P.C.Board and TUNER P.C.Board.
- 3.Disconnect the connector CN512 on the AUDIO P.C.Board.
- 4.Disconnect to the card wire CN314 on the AUDIO P.C.Board.
- 5.Disconnect the connector CN712 on the AMP P.C.Board.
- 6.Pullout the connector P.C.Board.
- 7.Remove 4 screws "G" on the AUDIO P.C.Board.
- 8.Remove the AUDIO P.C.Board.

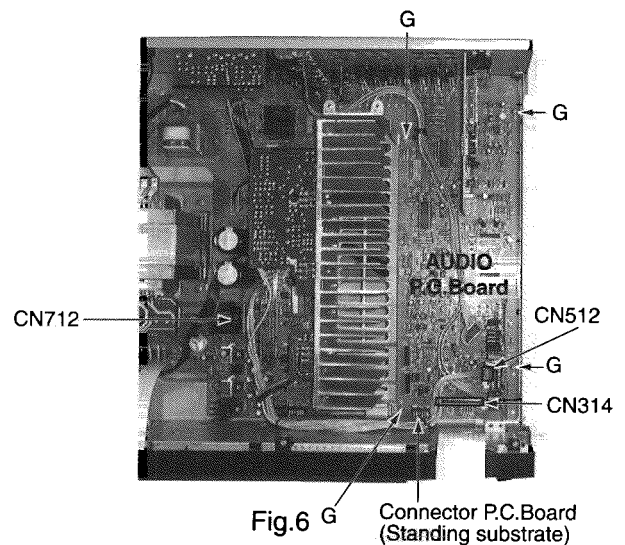

**(6)MAIN P.C.BOARD Removal (Fig.6,7,8)**

- 1.Remove the rear panel.
- 2.Pull out the AMP P.C.Board and connector P.C.Board.
- 3.Remove 8 screws "H" on the MAIN P.C.Board.
- 4.Remove 8 screws "I" on the Power transistor.
- 5.Disconnect the connector CN511 and wire CN831 on the MAIN P.C.Board.
- 6.Each tie band is cut out.
- 7.Remove 2 screws "J" on push switch of the front side.
- 8.Remove nut on terminal of the headphone.
- 9.The solder of the wire connected with the transformer is removed.
- 10.Remove the MAIN P.C.Board.

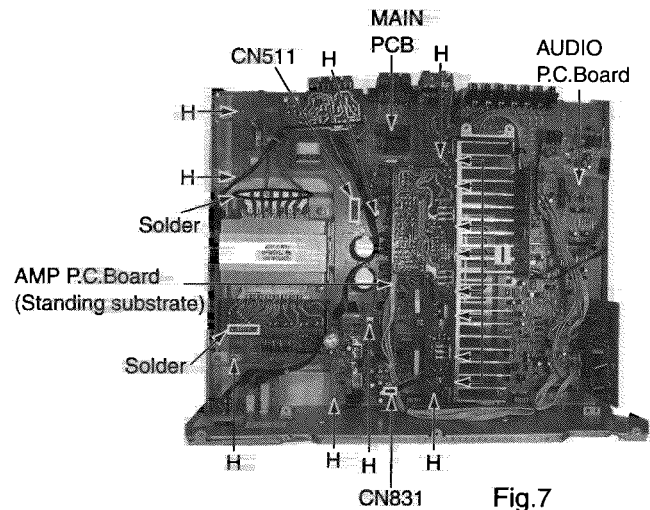

**(7)Front P.C.BOARD Removal (Fig.9)**

- 1.Remove the top cover.
- 2.Remove the Front panel assembly.
- 3.Remove the master volume knob and nut.
- 4.Remove the 13 screws "K" on the Front P.C.Board.

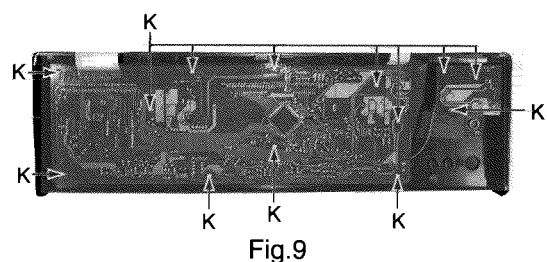
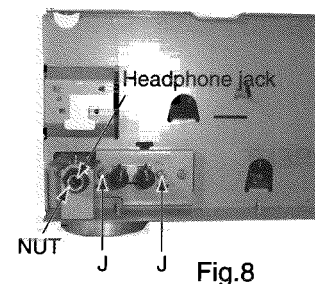

## ADJUSTMENT PROCEDURES

### ■ TUNER SECTION

#### 1. Tuner range

FM	87.5MHz~108.0MHz
AM(MW)	530kHz~1710kHz (RX-558VBK only Ver.J,C) 522kHz~1629kHz (RX-558RBK)
	531kHz~1602kHz 530kHz~1600kHz (RX-558VBK except Ver. J,C)
LW	144kHz~288kHz (RX-558RBK)

### ■ POWER AMPLIFIER SECTION

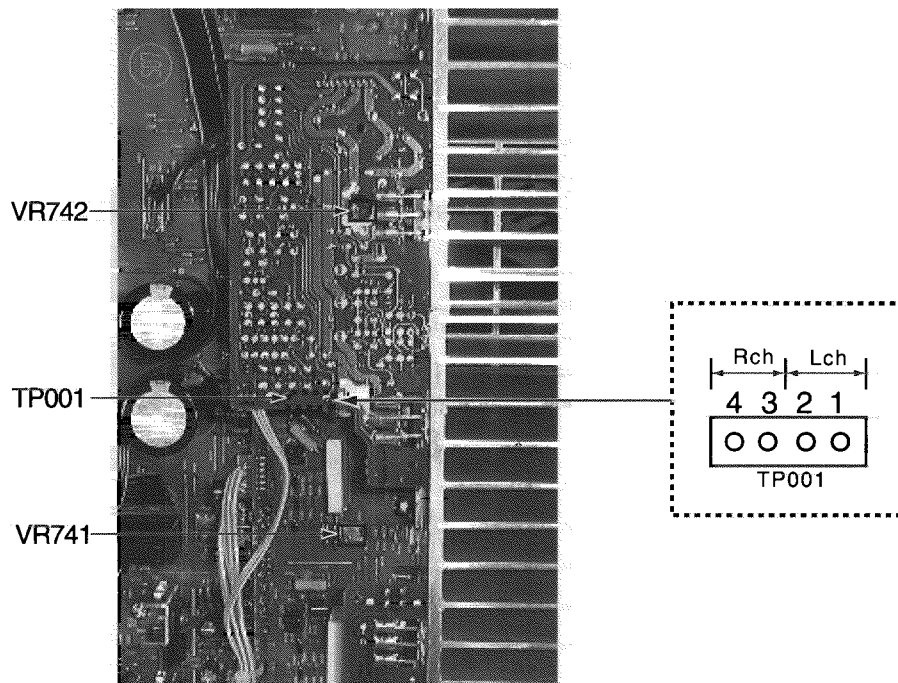

### IDLING CURRENT

1. Set the volume control to minimum during this adjustment.
2. Set the surround mode. RX-558VBK : OFF RX-558RBK : ON.
2. Turn VR741 and VR742 fully counterclockwise to warm up before adjustment.  
If the heat sink is already warm from previous use the correct adjustment can not be made.
3. For L-ch, connect a DC voltmeter between TP001's pin1 and pin2 (Lch)  
And, connect it between pin3 and pin4 (Rch).
4. 30 minutes later after power on, adjust VR741 for L-ch, or VR742 for R-ch so that the DC voltmeter value has 1mV~10mV.



**BLOCK DIAGRAM**

Amplifier/Control section

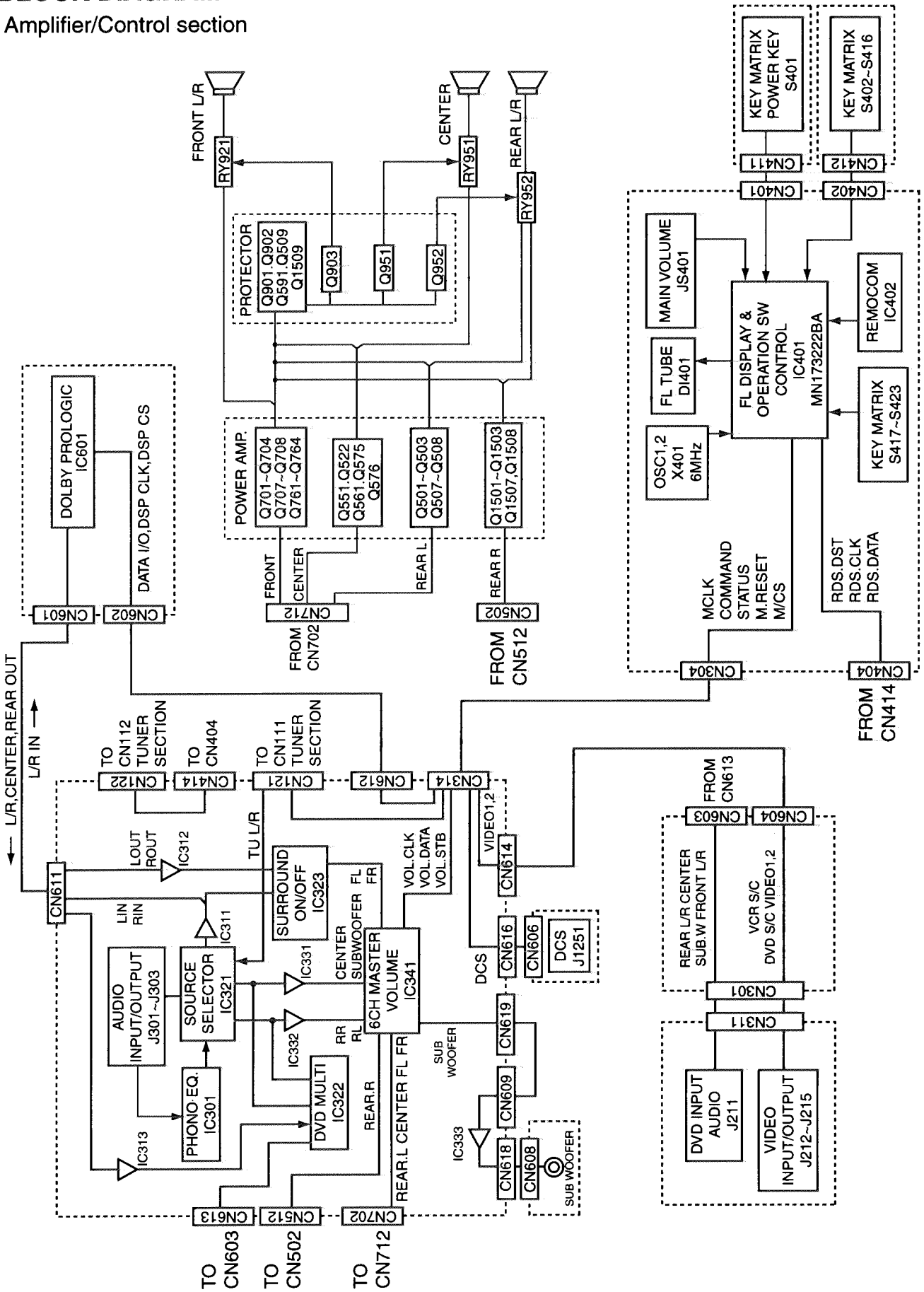

# RX-558VBK/RX-558RBK

## Tuner Section

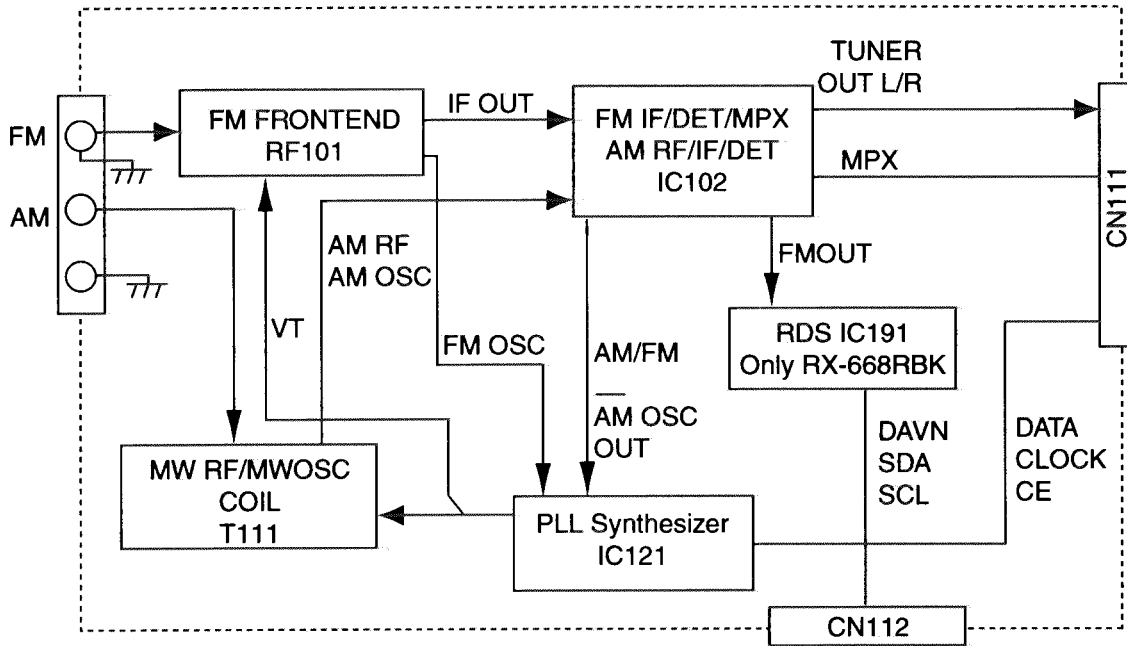

## Power Supply Section

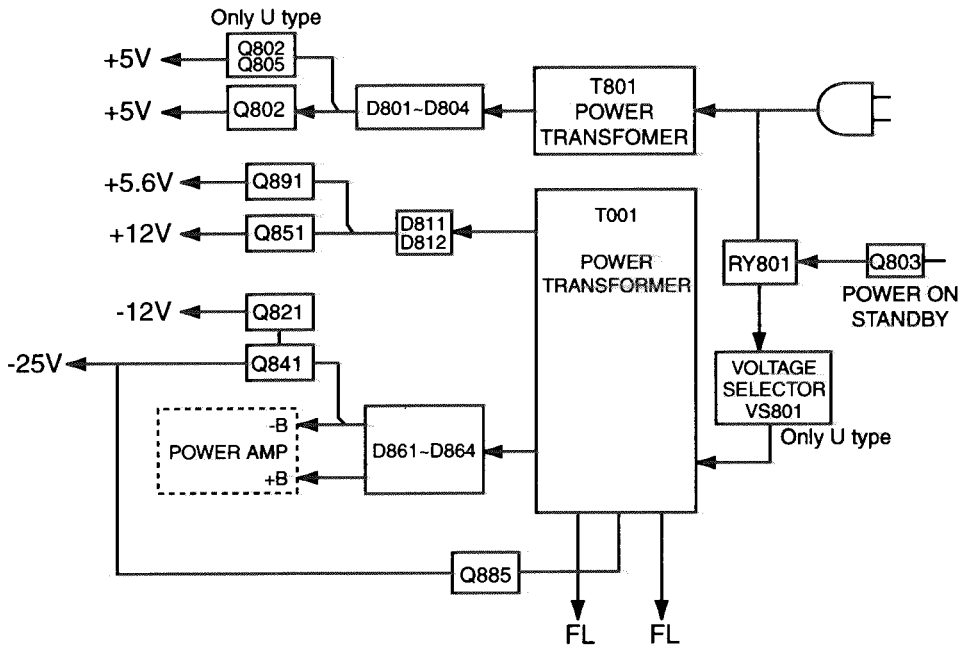



# Standard Schematic Diagrams

## Power Primary Section

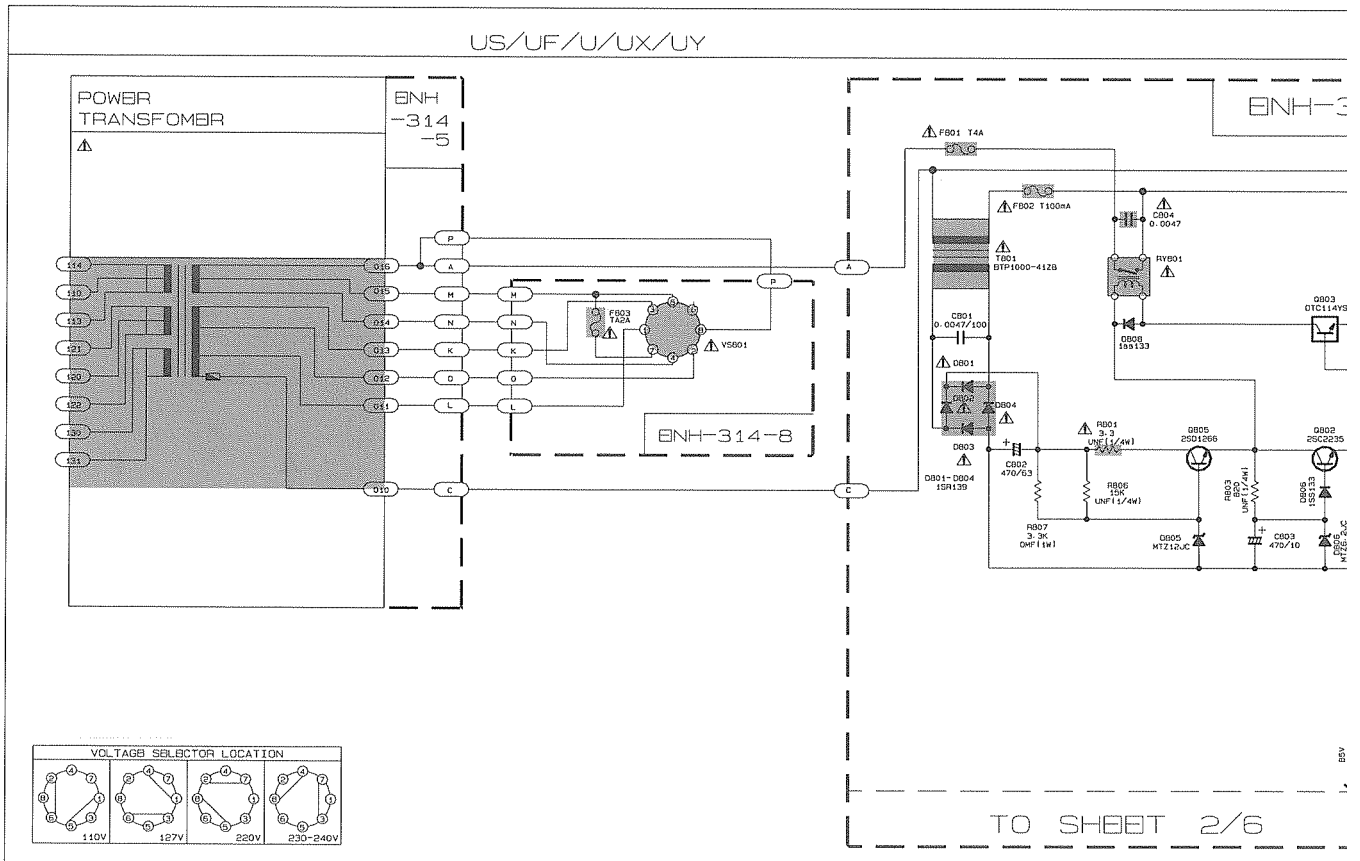
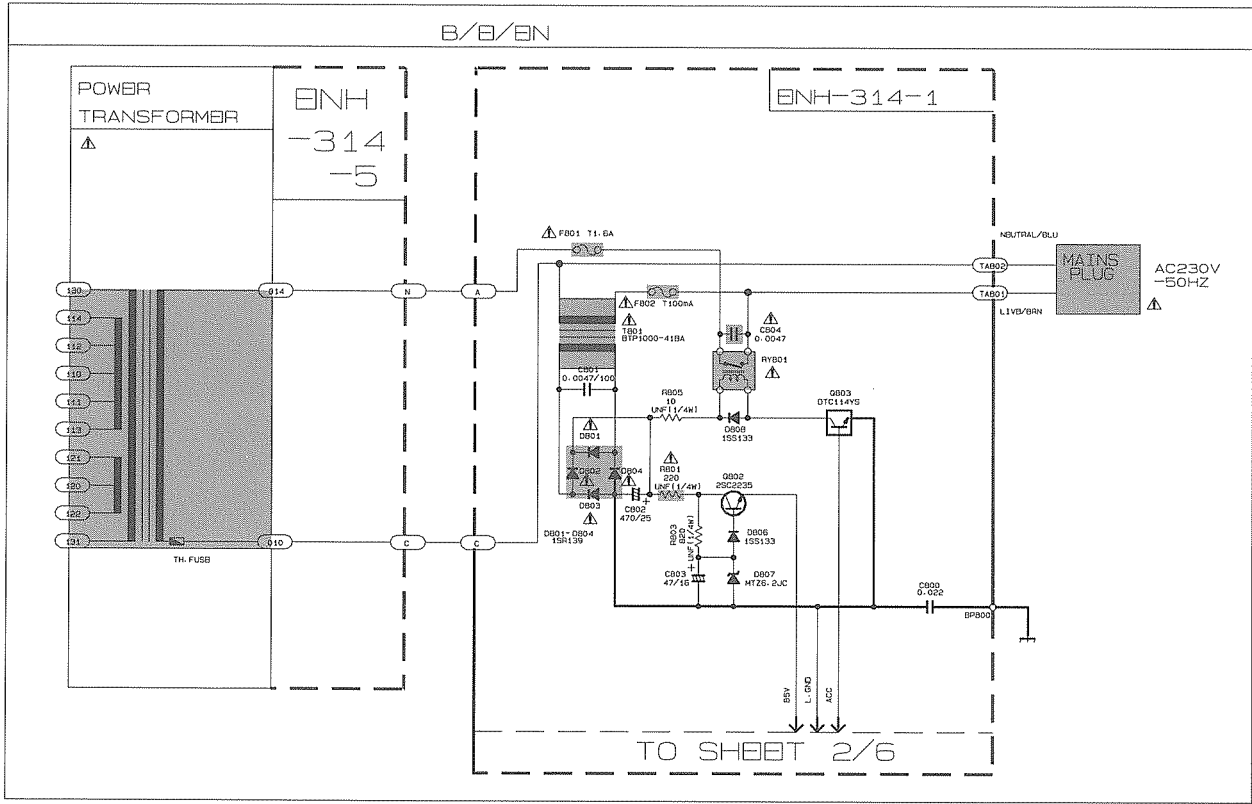

A

B

C

D

E

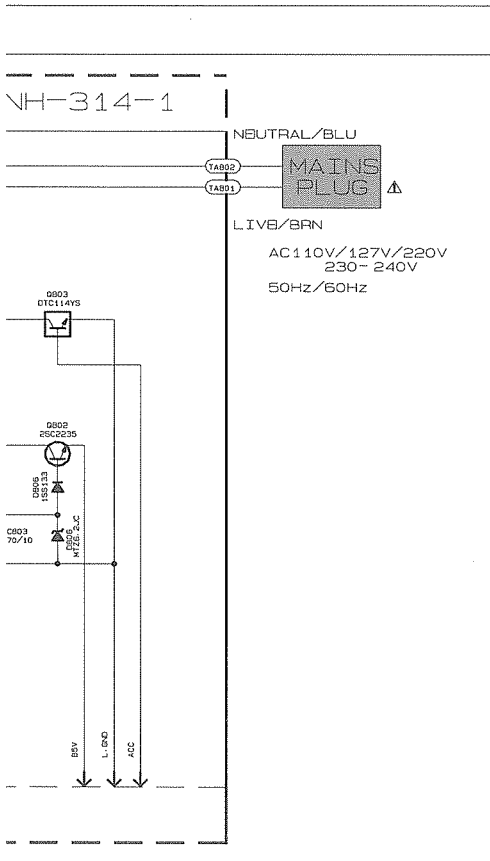
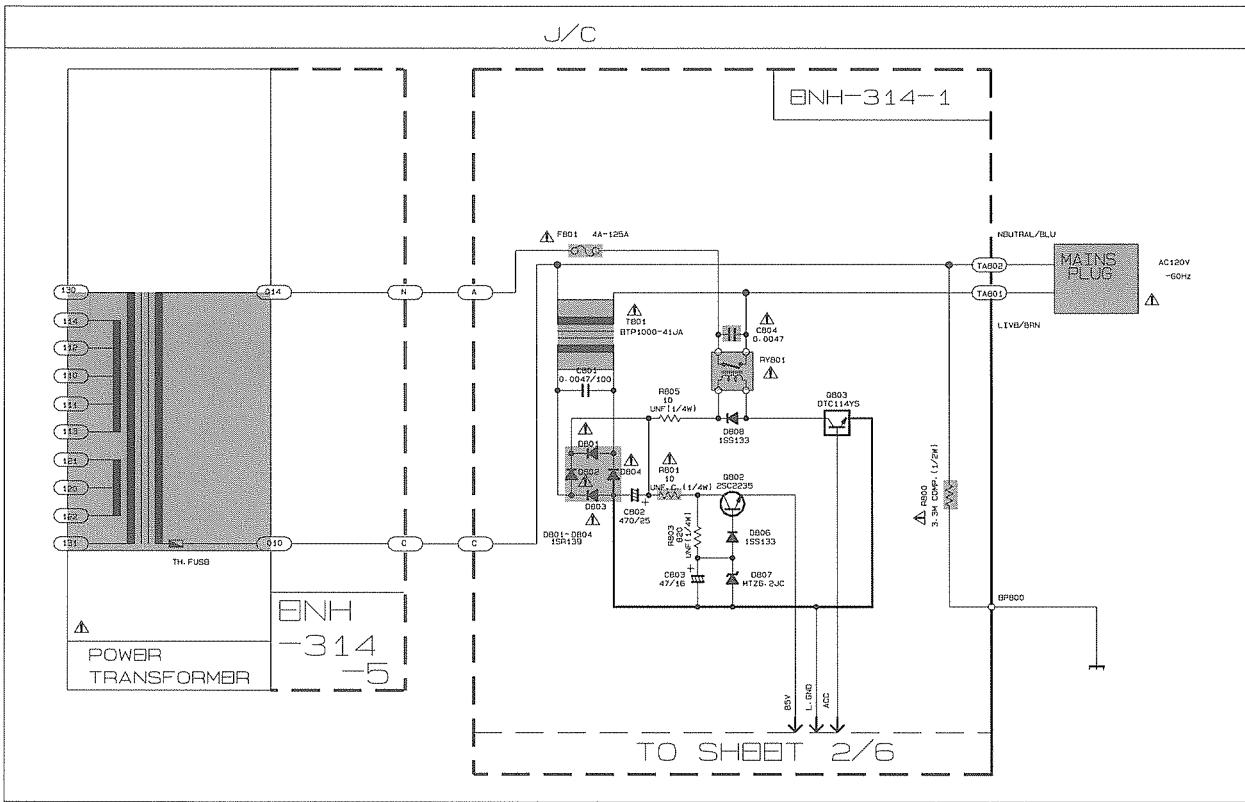

VERSION CODES

- EN: NORDIC COUNTRIES
- B: CONTINENTAL EUROPE
- B: U. K.
- C: CANADA
- J: U. S. A.
- US: SINGAPORE
- UF: CHINA
- U: UNIVERSAL EXCEPT ALL OF ABOVE
- UX: SAUDI ARABIA
- UY: ARGENTINA

NOTES:

MARK(\*) IS TO SHOW DEVIATION IN VERSIONS.  
 DETAILS ARE EXPLAINED NEAR THE MARK.

EXPLANATION OF OVERALL OF SCHEMA.

MODEL RX-558VBK/RX-558RBK/RX-559VGD

SHEET NUMBER	CIRCUIT DESCRIPTION
1/6	PRIMARY
2/6	RECTIFIER/REGULATOR /AUDIO AMP./SPEAKER TERMINAL
3/6	AUDIO SIGNAL INPUT TERMINAL /FRONT REAR CENTER VOLUME
4/6	AUDIO VIDEO SIGNAL INPUT TERMINAL /SOURCE SELECT IC
5/6	USER CONTROL KEYS/SYSTEM CONTROL LSI /FL DISPLAY
6/6	SURROUND IC

⚠ Parts are safety assurance parts.  
 When replacing those parts make sure to use the specified one.

MODEL  
 RX-558VBK/558RBK/559VGD

SHEET  
 1/6



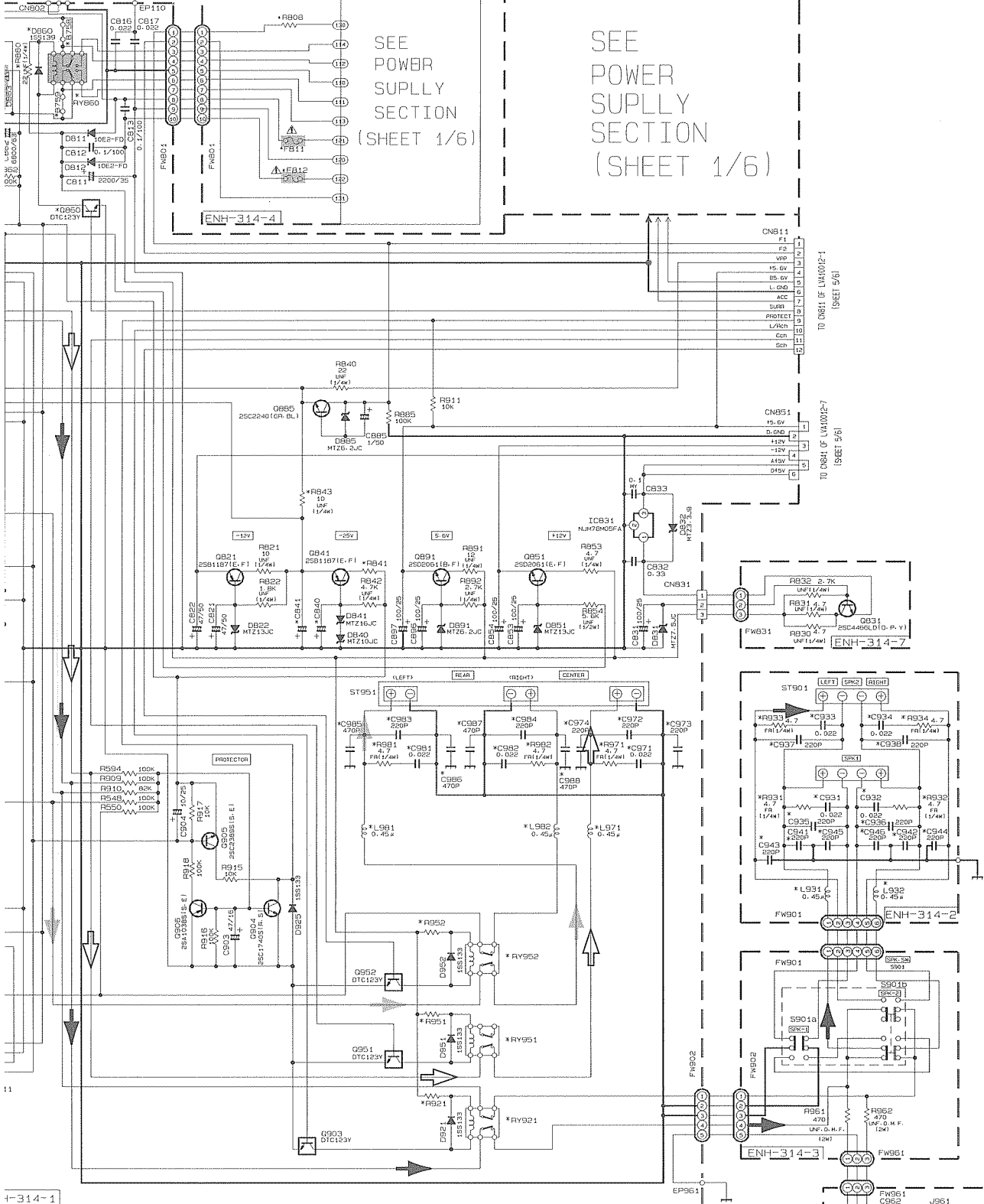

SEE POWER SUPPLY SECTION (SHEET 1/6)

SEE POWER SUPPLY SECTION (SHEET 1/6)

TO CH11 OF LV41002-1 (SHEET 5/6)

TO CH24 OF LV41002-7 (SHEET 5/6)

TO CH24 OF LV41002-7 (SHEET 5/6)

TO CH24 OF LV41002-7 (SHEET 5/6)

- ▷ MAIN SIGNAL
- ▷ REAR SIGNAL
- ▷ CENTER SIGNAL

Parts are safety assurance parts. When replacing those parts make sure to use the specified one.

MARK	RK-558VBK	0	RK-558RBK/559VGD	RK-558RBK
CHAD-CH41	47/50	47/50	10 10K US (1/4W)	BS-5 EN
RB41	10 FR1/1/4W	10 FR1/1/4W	10 FR1/1/4W	2.2 UNF1/4W
RB43	USED	USED	USED	NONE
CHB02	NONE	NONE	NONE	USED

# Audio Signal Input Section

7  
6  
5  
4  
3  
2  
1

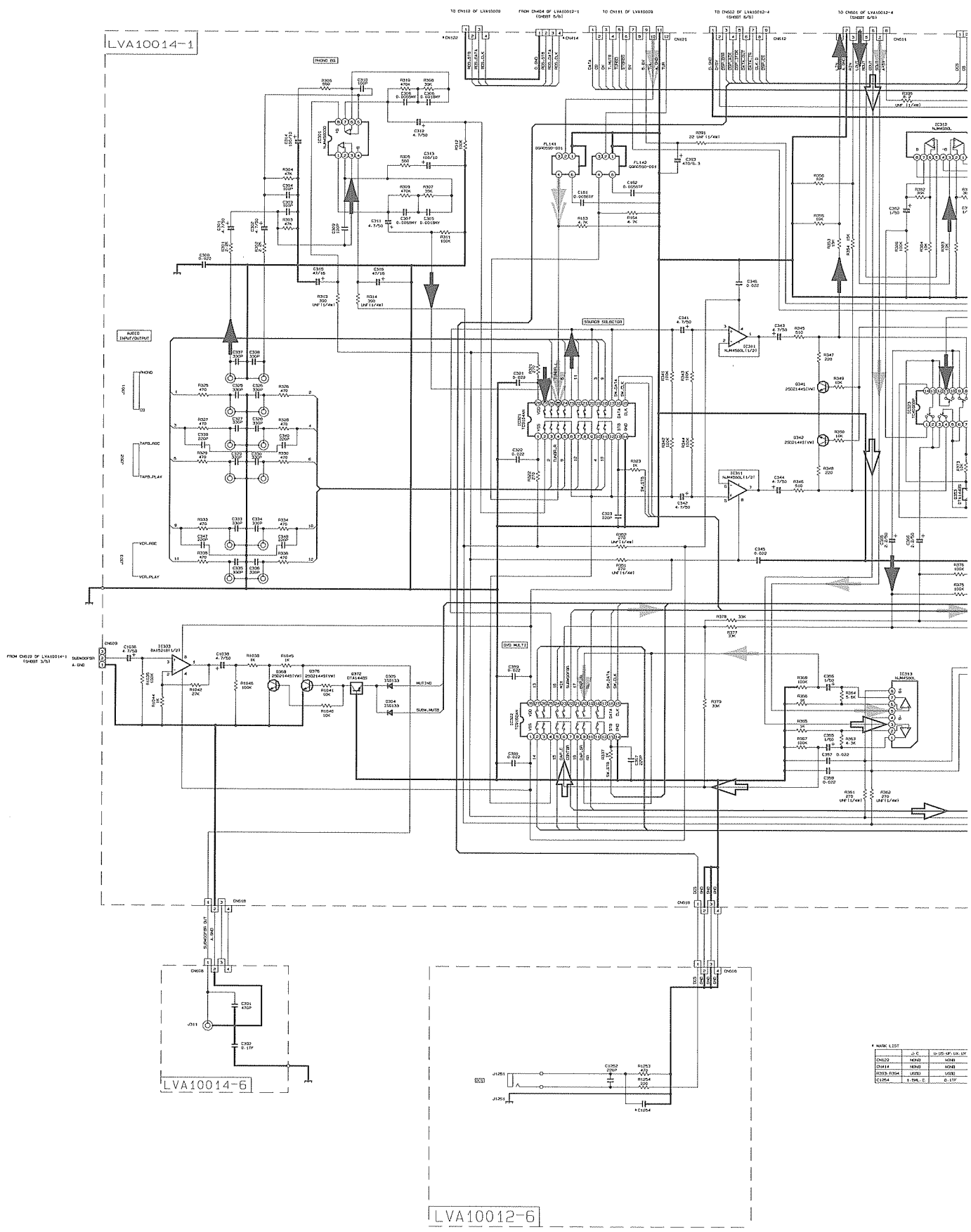

\* MARK LIST

MARK	QTY	DESCRIPTION
D610	1	CONN
D611	1	CONN
D612	1	CONN
D613	1	CONN
D614	1	CONN
D615	1	CONN
D616	1	CONN
D617	1	CONN
D618	1	CONN
D619	1	CONN
D620	1	CONN
D621	1	CONN
D622	1	CONN
D623	1	CONN
D624	1	CONN
D625	1	CONN
D626	1	CONN
D627	1	CONN
D628	1	CONN
D629	1	CONN
D630	1	CONN
D631	1	CONN
D632	1	CONN
D633	1	CONN
D634	1	CONN
D635	1	CONN
D636	1	CONN
D637	1	CONN
D638	1	CONN
D639	1	CONN
D640	1	CONN
D641	1	CONN
D642	1	CONN
D643	1	CONN
D644	1	CONN
D645	1	CONN
D646	1	CONN
D647	1	CONN
D648	1	CONN
D649	1	CONN
D650	1	CONN
D651	1	CONN
D652	1	CONN
D653	1	CONN
D654	1	CONN
D655	1	CONN
D656	1	CONN
D657	1	CONN
D658	1	CONN
D659	1	CONN
D660	1	CONN
D661	1	CONN
D662	1	CONN
D663	1	CONN
D664	1	CONN
D665	1	CONN
D666	1	CONN
D667	1	CONN
D668	1	CONN
D669	1	CONN
D670	1	CONN
D671	1	CONN
D672	1	CONN
D673	1	CONN
D674	1	CONN
D675	1	CONN
D676	1	CONN
D677	1	CONN
D678	1	CONN
D679	1	CONN
D680	1	CONN
D681	1	CONN
D682	1	CONN
D683	1	CONN
D684	1	CONN
D685	1	CONN
D686	1	CONN
D687	1	CONN
D688	1	CONN
D689	1	CONN
D690	1	CONN
D691	1	CONN
D692	1	CONN
D693	1	CONN
D694	1	CONN
D695	1	CONN
D696	1	CONN
D697	1	CONN
D698	1	CONN
D699	1	CONN
D700	1	CONN

A B C D E





Video Signal Input Section

LVA10014-2

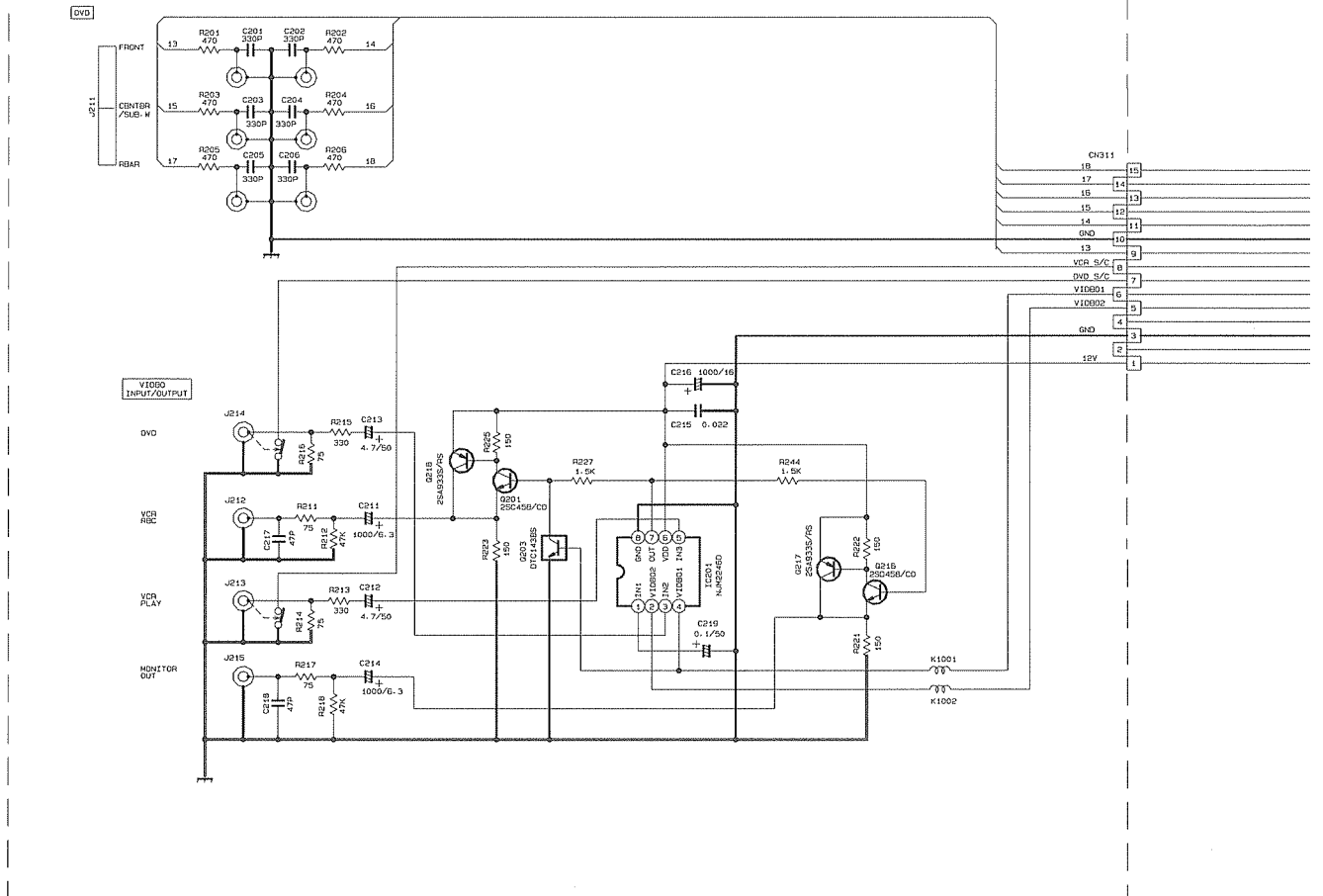

LVA10014-3

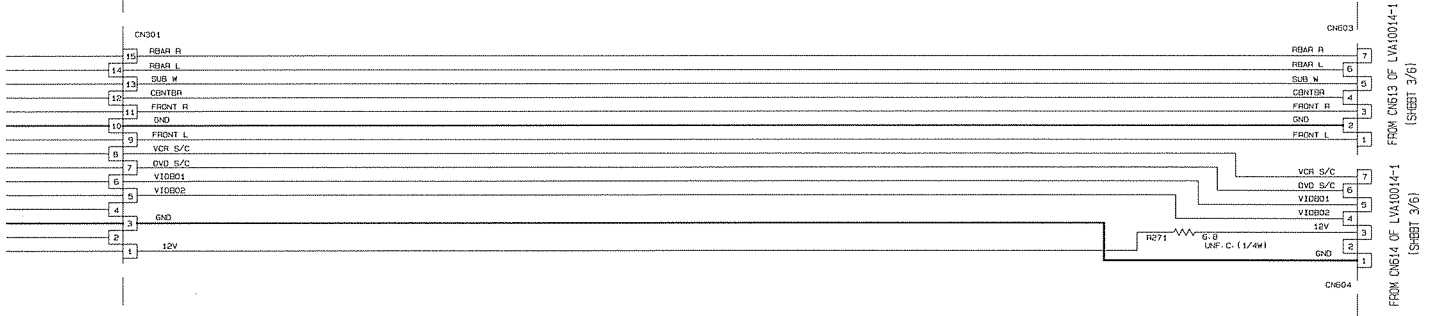

FROM CN603 OF LVA10014-1 (SHEET 3/6)

FROM CN604 OF LVA10014-1 (SHEET 3/6)

MODEL RX-558/559 SHEET 4/6

# FL Display & System Control Section

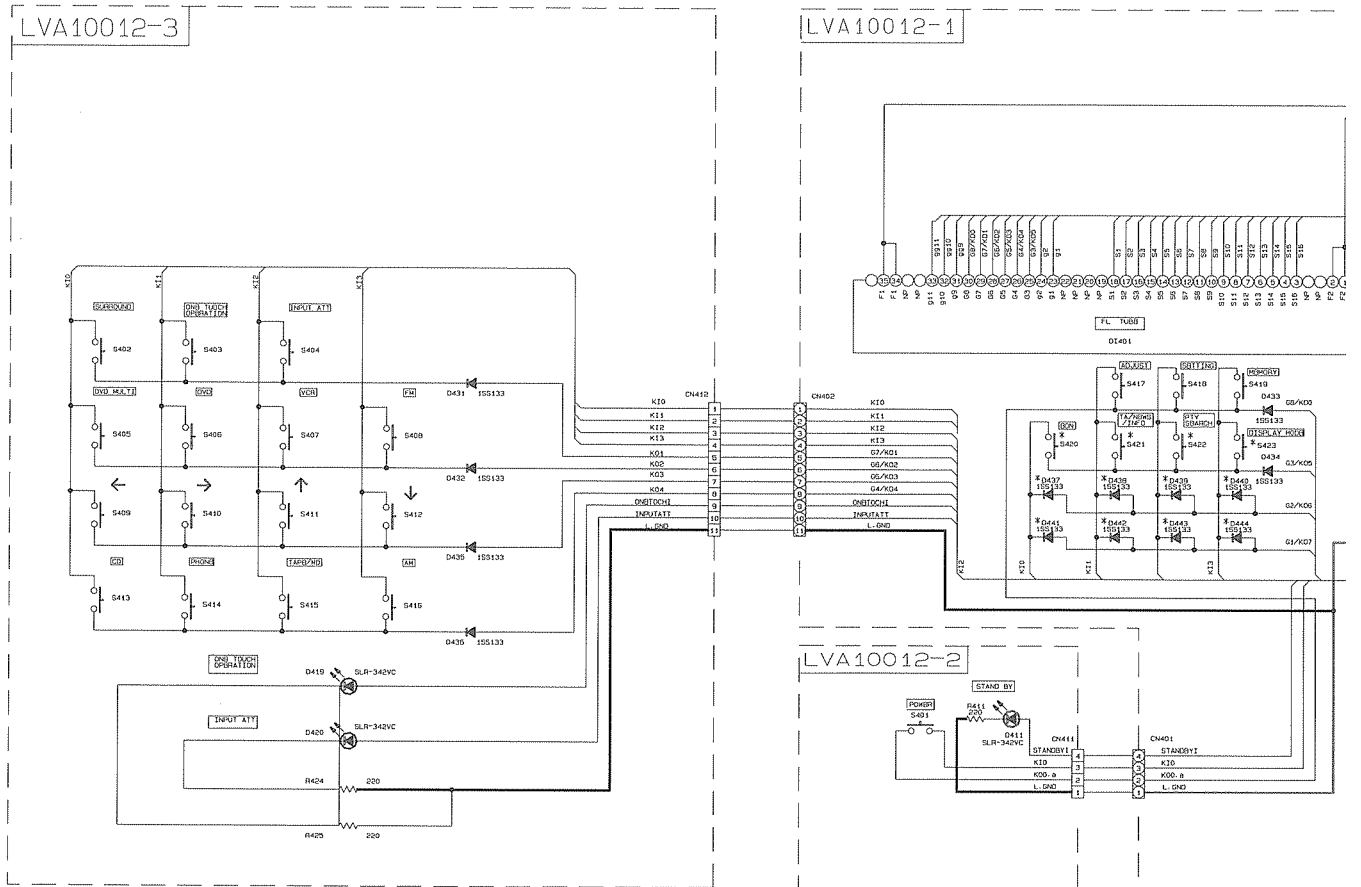

#MARK LIST

	VEKJ	VEKC	VEKU	VEKUF	VEKUS	VEKUX	VEKLY	VGOLF	VGOLF	FBKB	FBKB	FBKBN
D437	NONE	NONE	NONE	NONE	NONE	NONE	NONE	USED	USED	USED	USED	USED
D438	NONE	NONE	NONE	NONE	NONE	NONE	NONE	USED	USED	USED	NONE	NONE
D439	NONE	NONE	USED	USED	USED	USED	USED	USED	USED	NONE	NONE	NONE
D440	NONE	NONE	NONE	NONE	NONE	NONE	NONE	NONE	NONE	NONE	NONE	NONE
D441	NONE	NONE	NONE	NONE	NONE	NONE	NONE	NONE	NONE	NONE	NONE	NONE
D442	NONE	NONE	NONE	NONE	NONE	NONE	NONE	NONE	NONE	NONE	NONE	NONE
D443	NONE	NONE	NONE	NONE	NONE	NONE	NONE	NONE	NONE	NONE	NONE	NONE
D444	NONE	NONE	NONE	NONE	NONE	NONE	NONE	NONE	NONE	NONE	NONE	NONE
CN404	NONE	NONE	NONE	NONE	NONE	NONE	NONE	NONE	NONE	USED	USED	USED
S420	NONE	NONE	NONE	NONE	NONE	NONE	NONE	NONE	NONE	USED	USED	USED
S421	NONE	NONE	NONE	NONE	NONE	NONE	NONE	NONE	NONE	USED	USED	USED
S422	NONE	NONE	NONE	NONE	NONE	NONE	NONE	NONE	NONE	USED	USED	USED
S423	NONE	NONE	NONE	NONE	NONE	NONE	NONE	NONE	NONE	USED	USED	USED

TO CN314 OF LVA10014-1  
(SHEET 3/6)

TO CN14 OF LVA10014-1  
(SHEET 3/6)

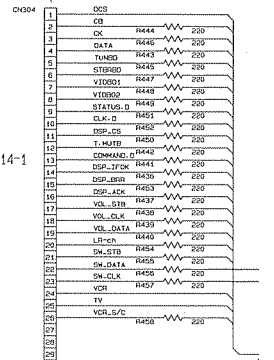

# CN404

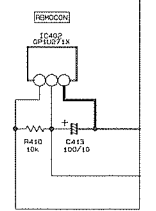

7  
6  
5  
4  
3  
2  
1

A B C D E

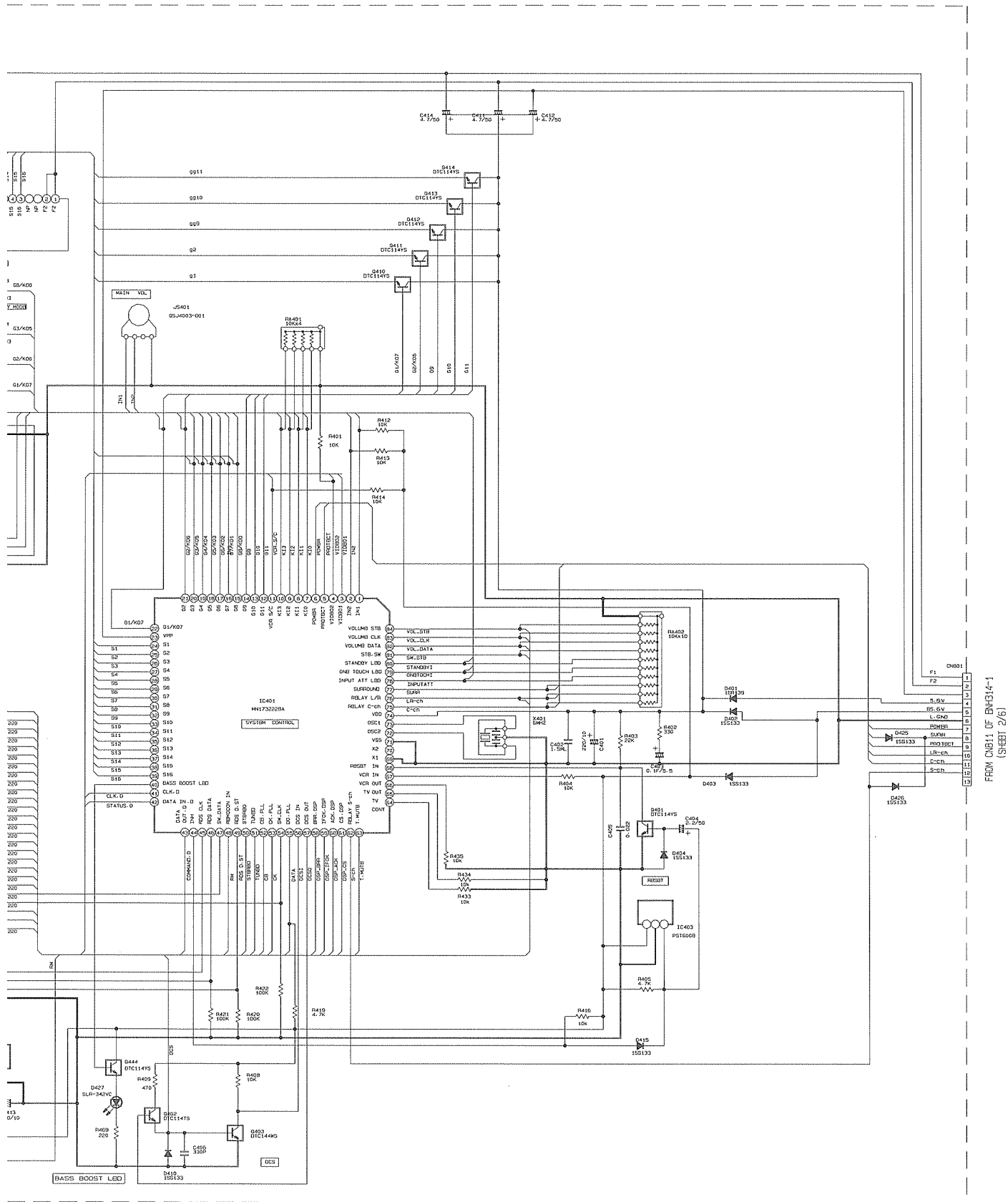

■ Dsp Control Section

LVA10012-4

7  
6  
5  
4  
3  
2  
1

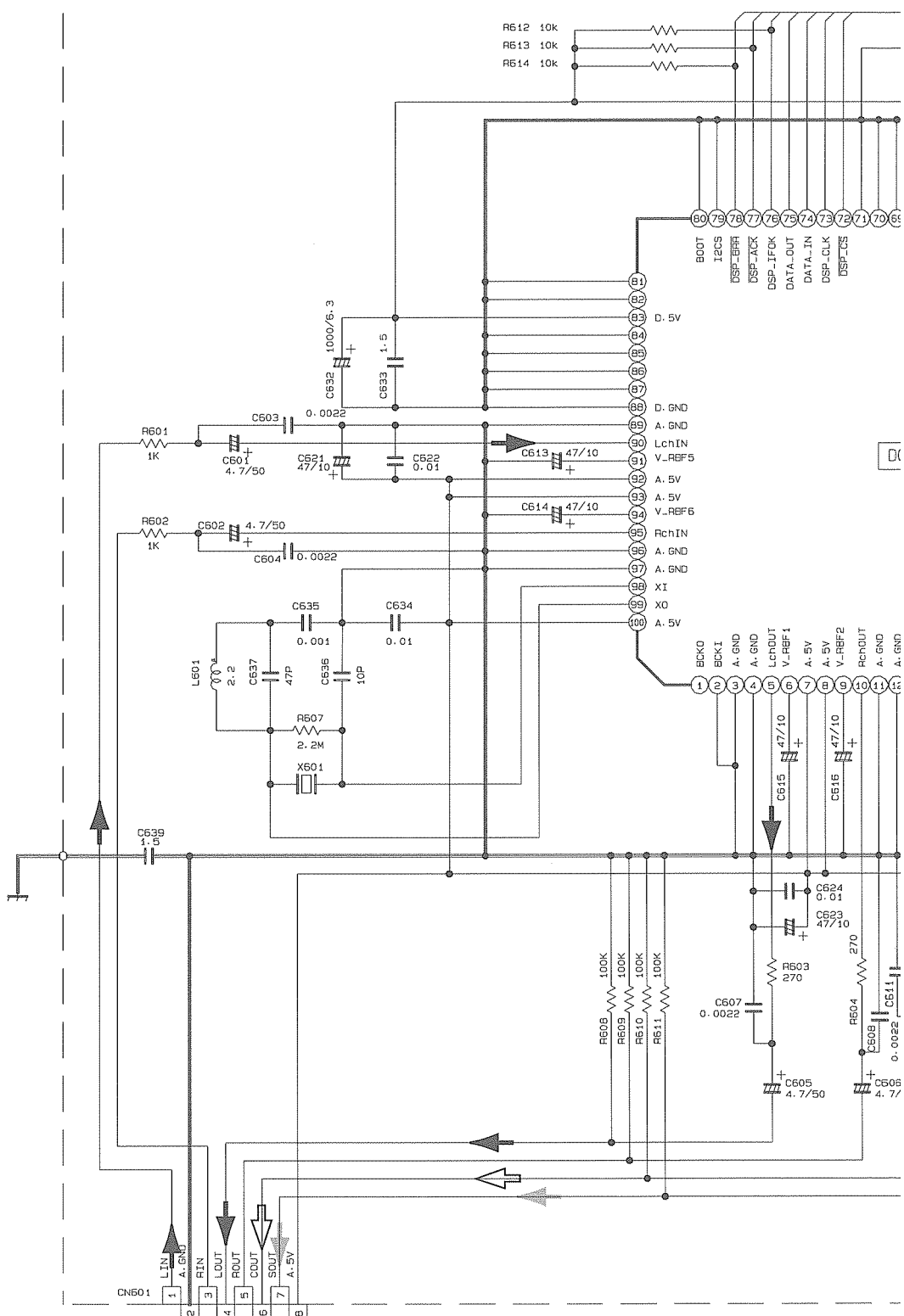

FROM CN611 OF LVA10014-1 (SHEET 3/6)

- ➔ MAIN SIGNAL
- ➡ REAR SIGNAL
- ⏏ CENTER SIGNAL

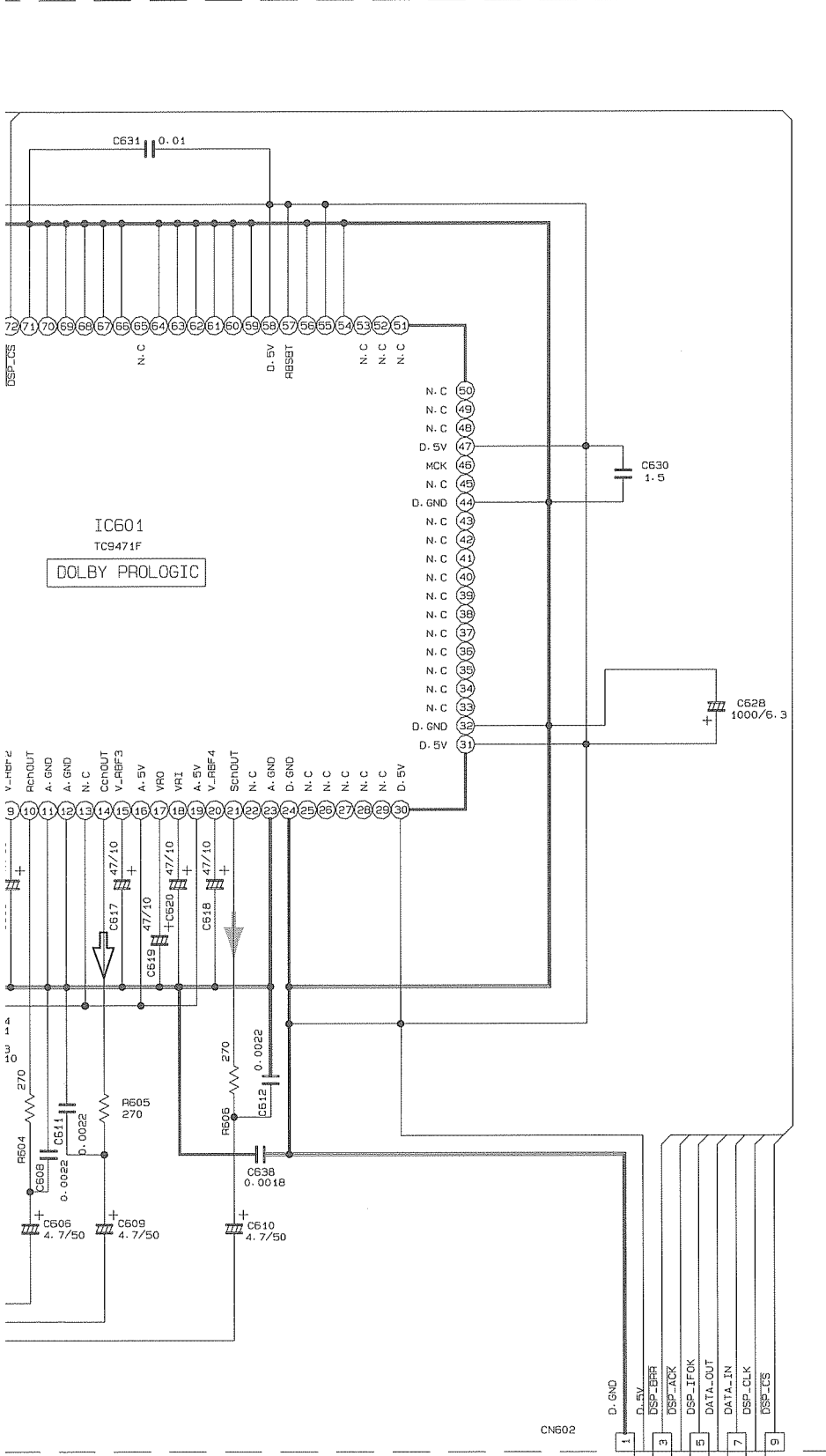

IC601  
TC9471F  
DOLBY PROLOGIC

MODEL  
RX-558/559

SHBBT  
6/6

FROM CN612 OF LVA10014-1  
(SHBBT 3/6)

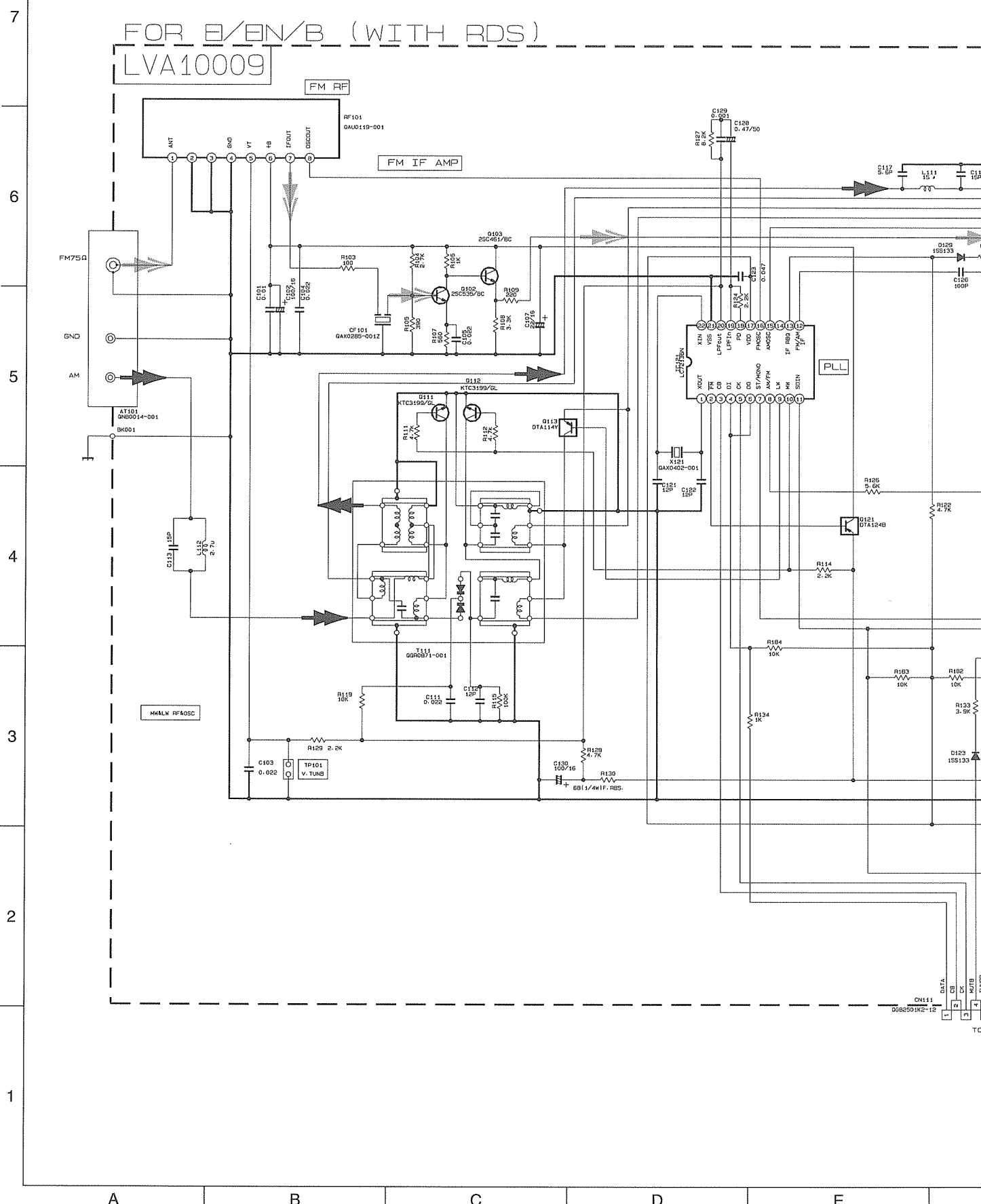

■ Tuner Section

FOR E/EN/B (WITH RDS)  
LVA10009



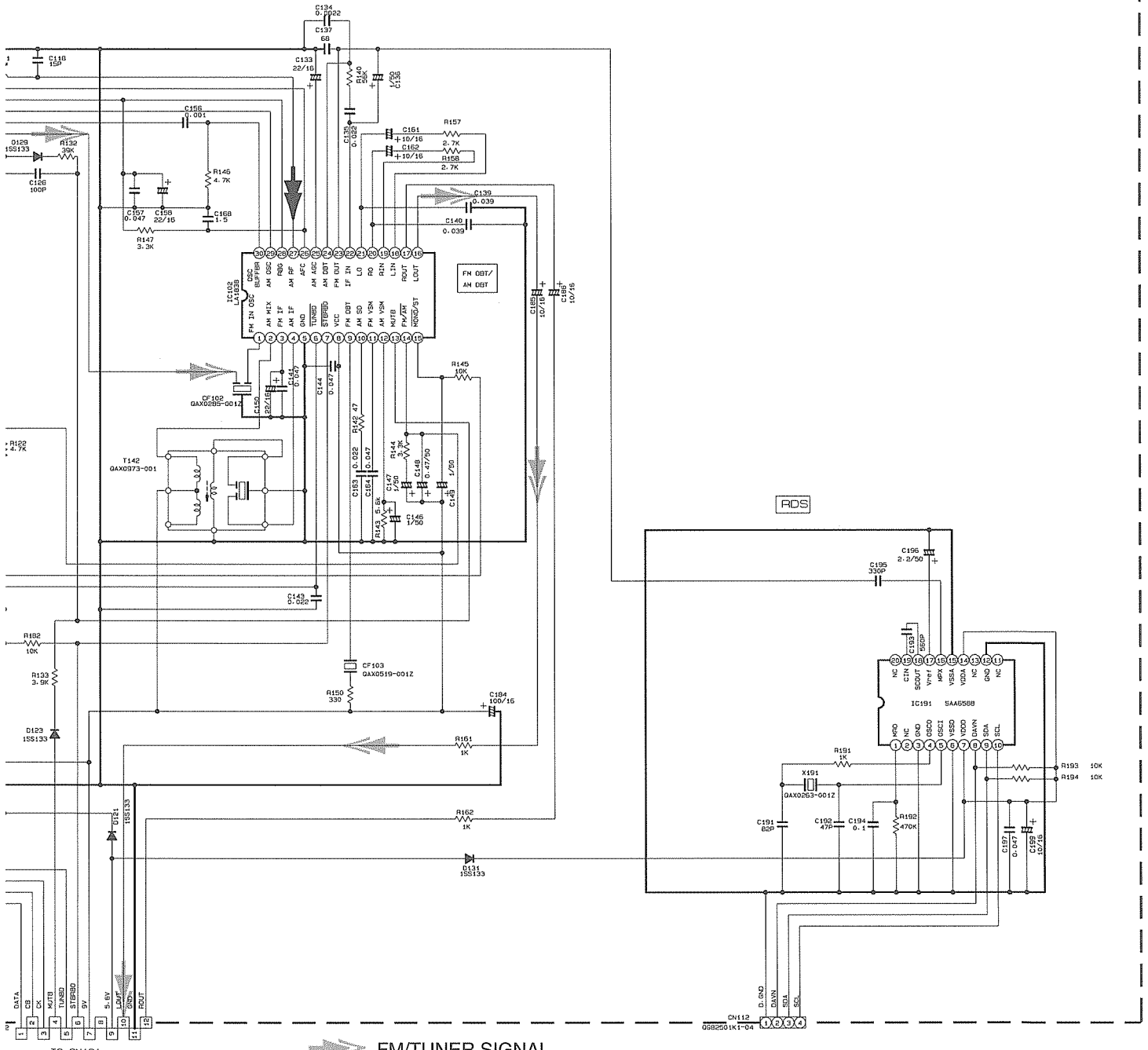



 FM/TUNER SIGNAL  
 AM SIGNAL

F

G

H

I

J

■ Tuner Section

FOR J, C, U, A

LVA10009

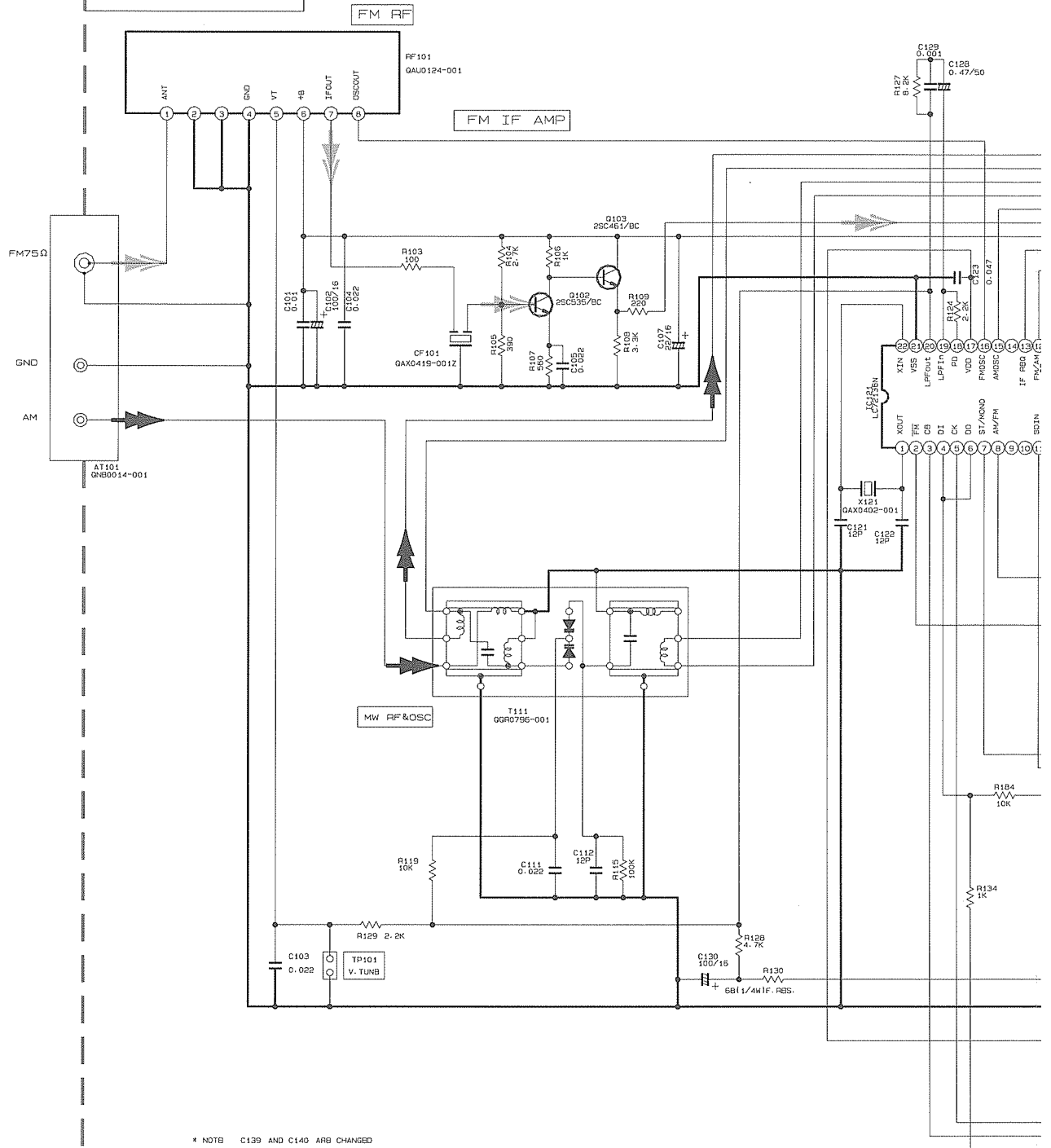

\* NOTE C139 AND C140 ARB CHANGED AS BELOW TABLE.

	C139, C140
J. C	0.033
U. A	0.022

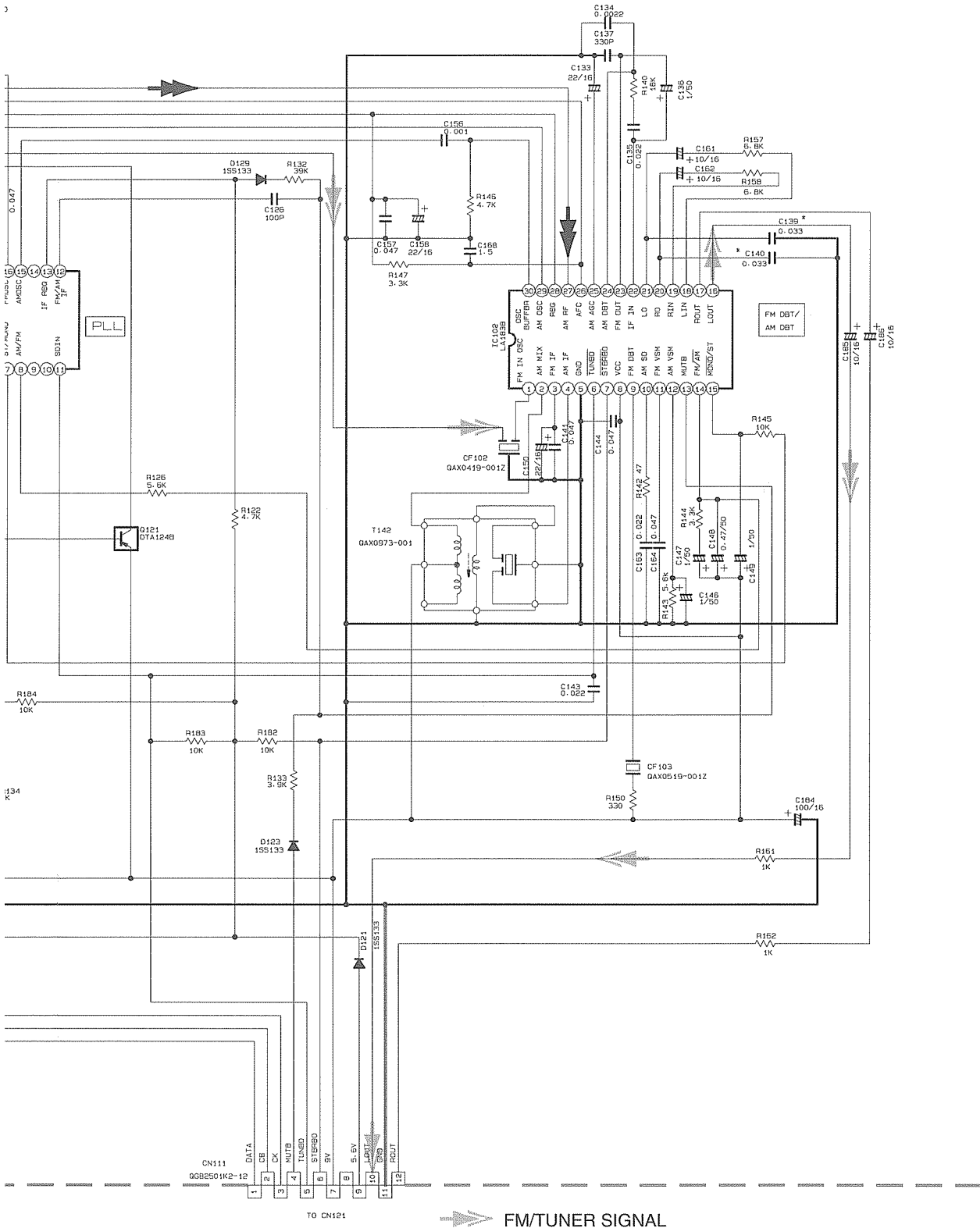

TO CN121

FM/TUNER SIGNAL

AM SIGNAL

F G H I J



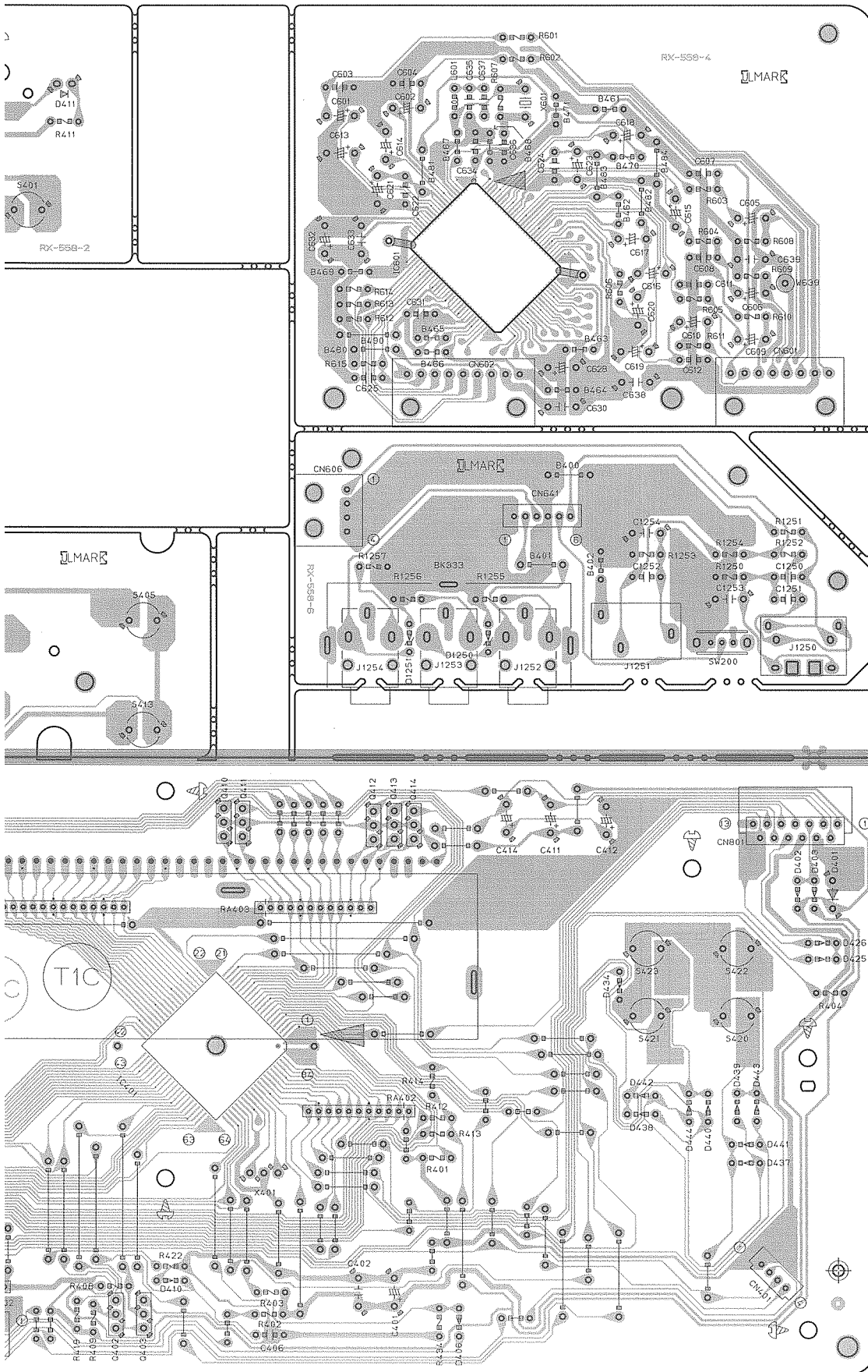

F G H I J

■ Audio/Video Input P.C. Board

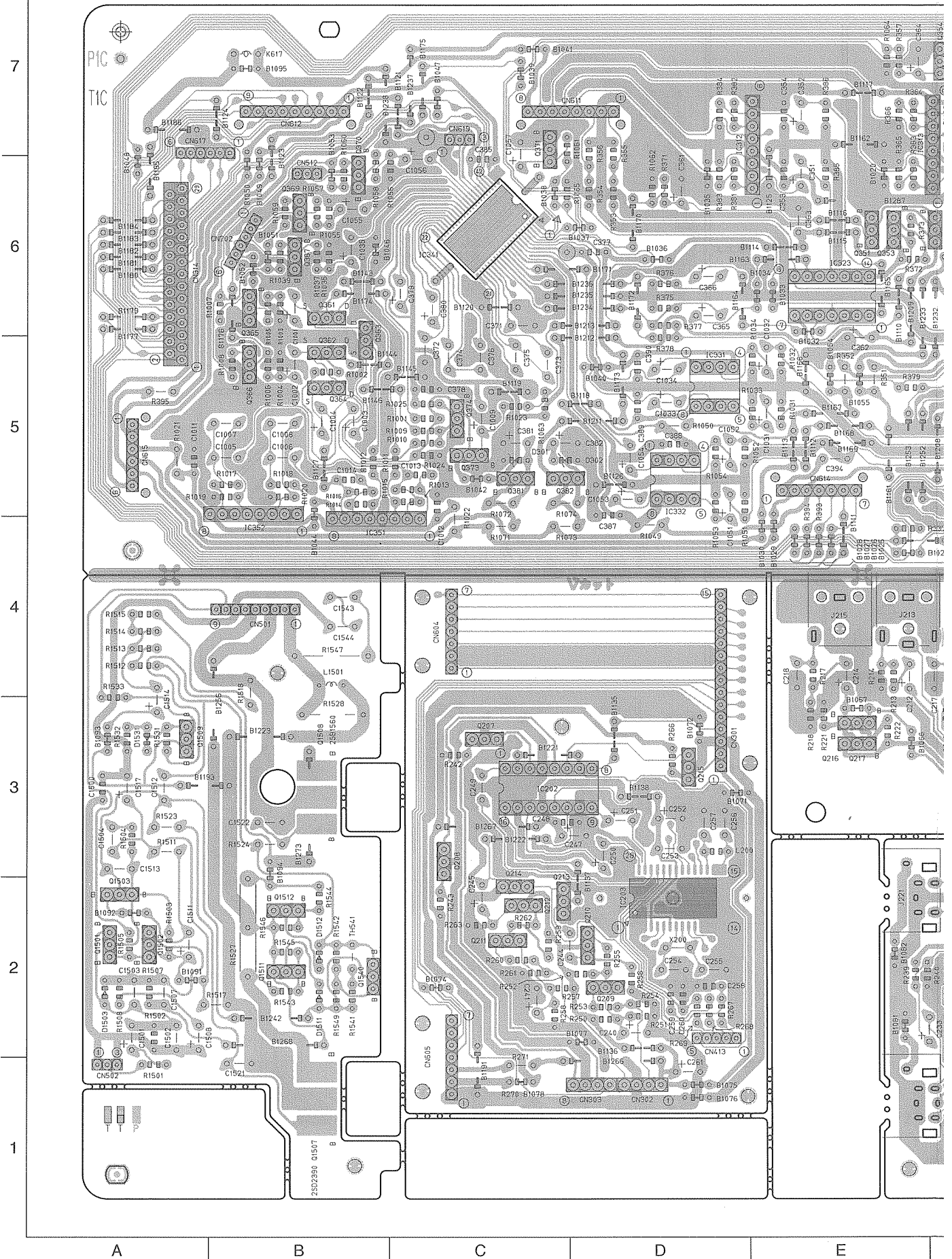



# ■ Main P.C. Board

7  
6  
5  
4  
3  
2  
1

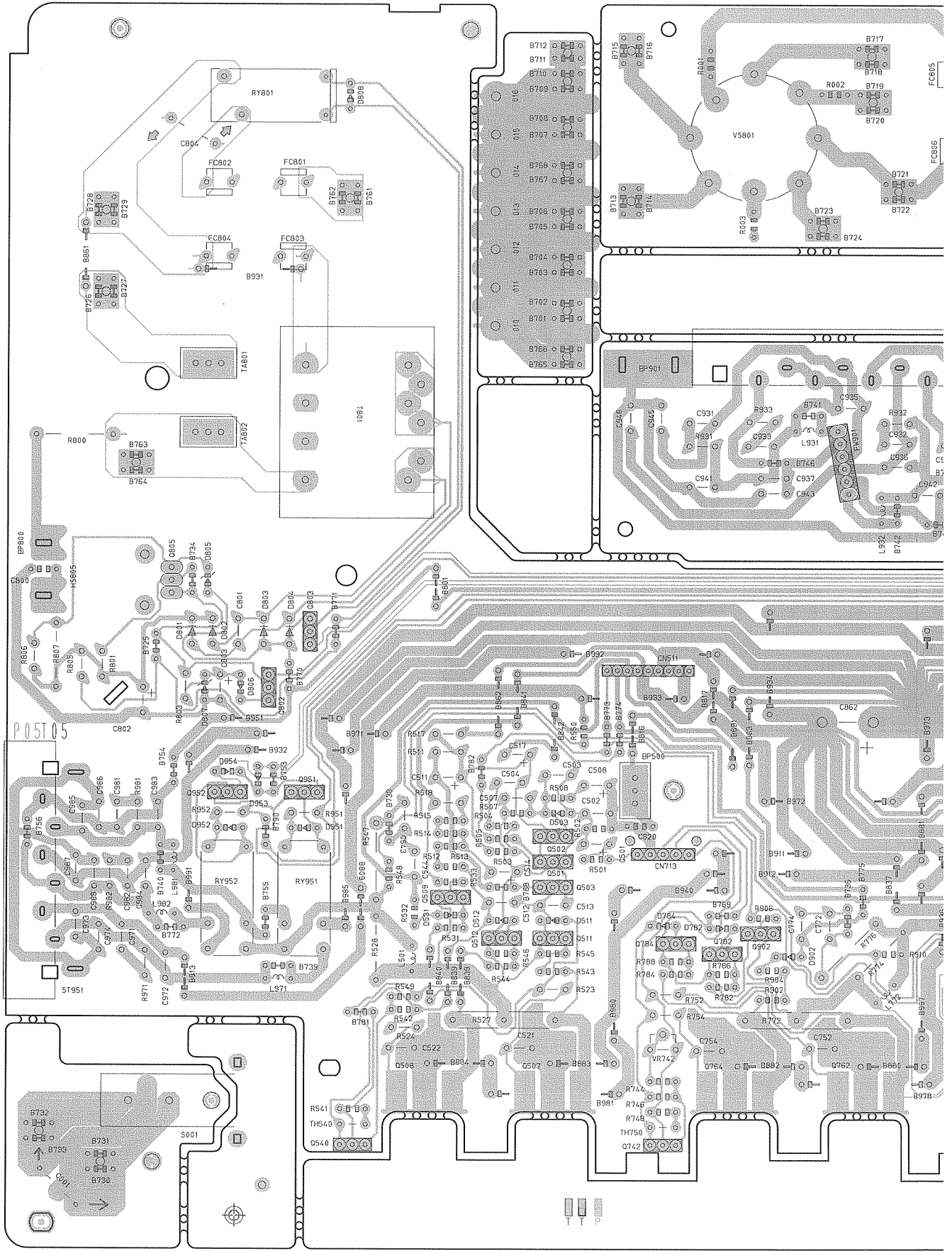

A B C D E







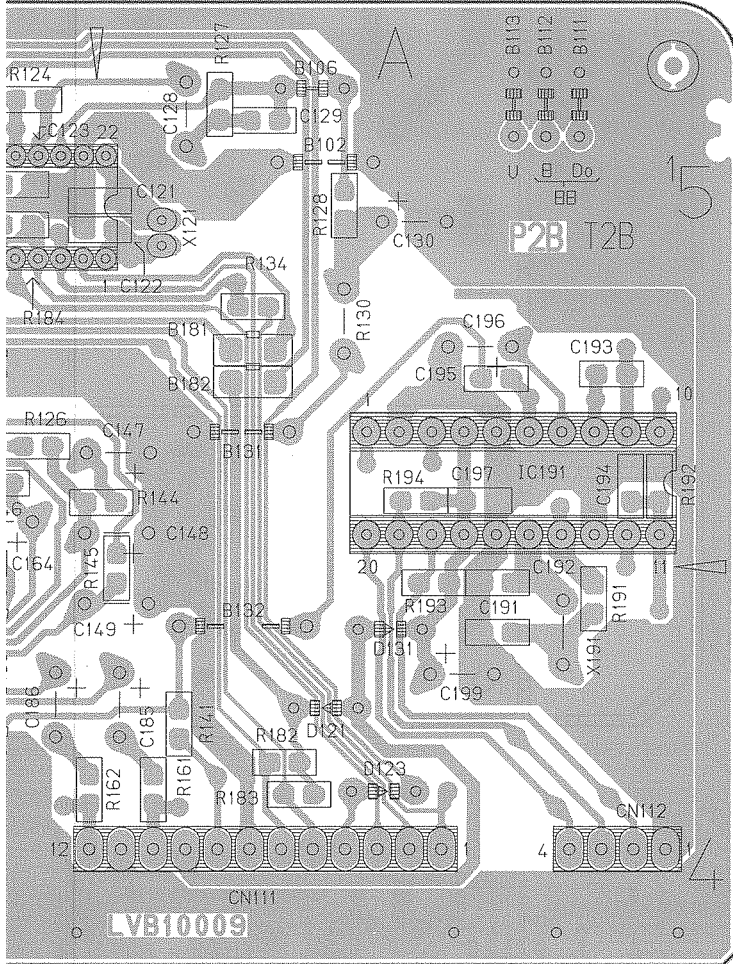



**PARTS LIST**

[ RX-558VBK ]  
[ RX-558RBK ]

\* All printed circuit boards and its assemblies are not available as service parts.

Areas Suffix	
RX-558VBK	
J	----- The U.S.A.
C	----- Canada
U	----- Universal
UY	----- Argentina
RX-558RBK	
E	----- Continental Europe
EN	----- Northern Europe
B	----- U.K.

- Contents -

Exploded View of General Assembly and Parts List ..... 3-3  
Electrical Parts List ..... 3-5  
Packing Materials and Accessories Parts List ..... 3-18

RX-558VBK/RX-558RBK

## MEMO



# Exploded View of General Assembly and Parts List

Block No. **M T M M**

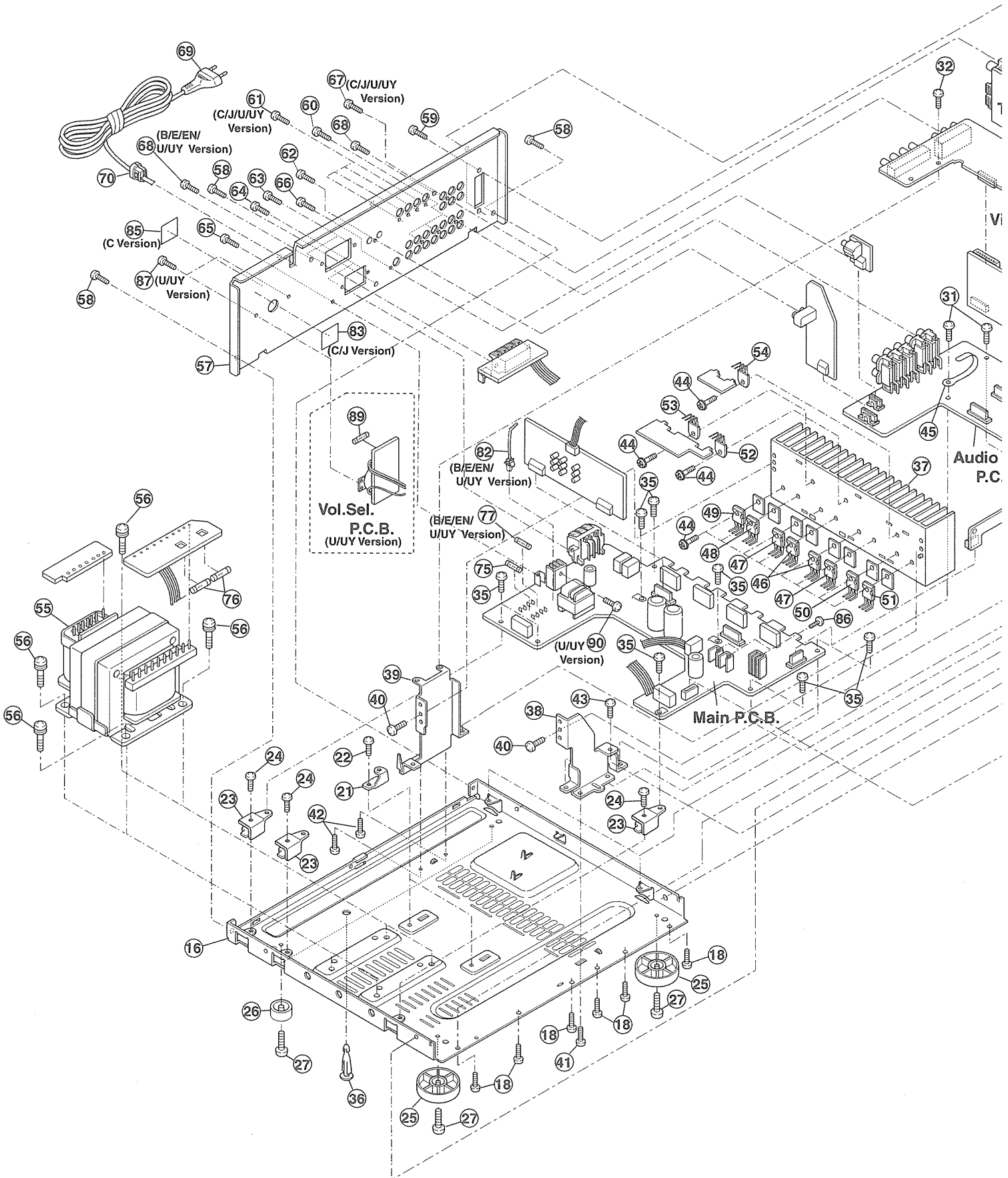



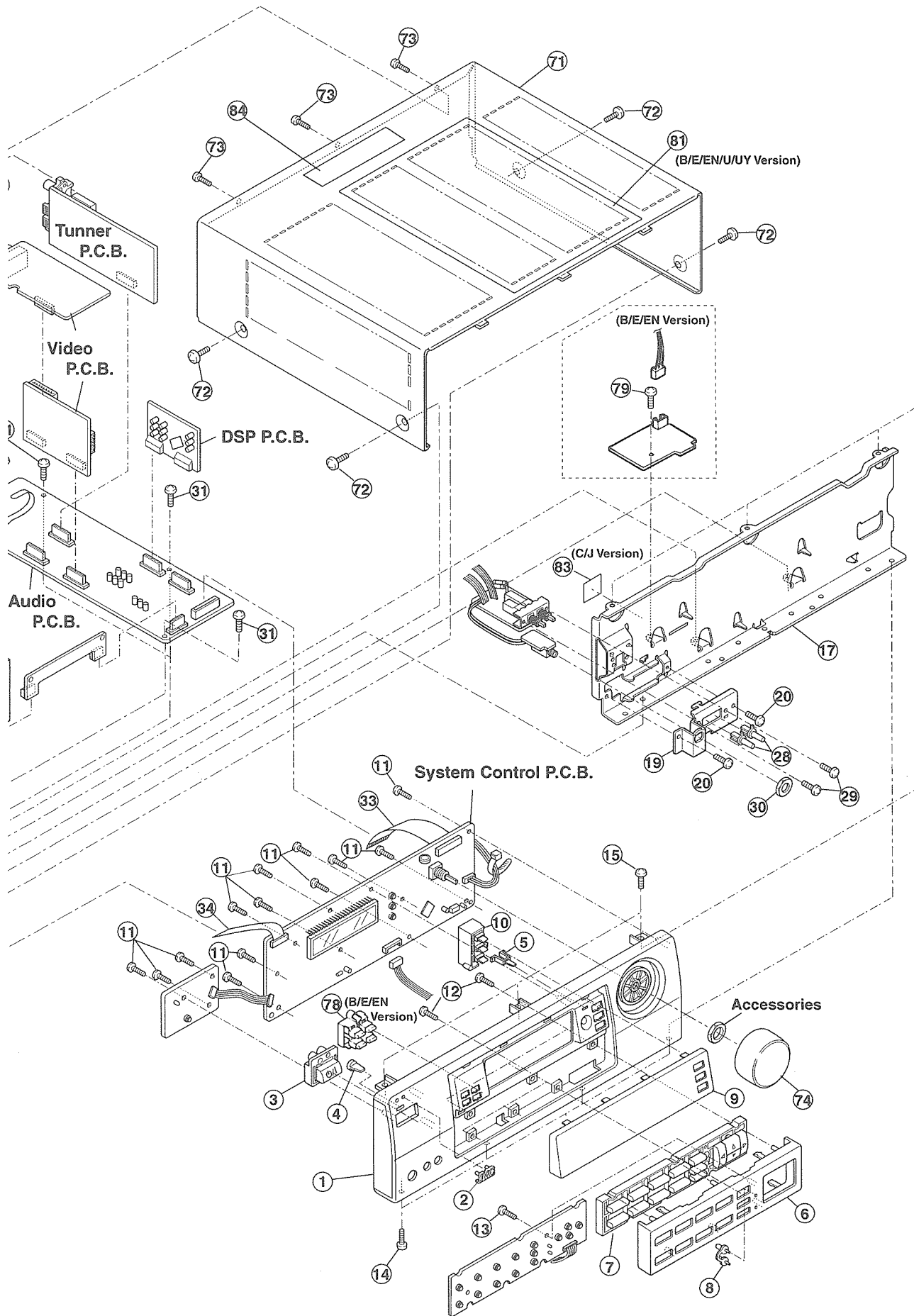

## ■ Parts List (General Assembly)

BLOCK NO. 

△	REF.	PARTS NO.	PARTS NAME	REMARKS	QTY	SUFFIX	CLR
	1	LV10128-017A	FRONT PANEL	RX-558RBK	1	B,E,EN	
		LV10128-016A	FRONT PANEL	RX-558VBK	1	U,UY	
		LV10128-015A	FRONT PANEL	RX-558VBK	1	C,J	
	2	VJD5429-001SS	JVC MARK		1		
	3	LV30684-001A	POWER BUTTON		1	C,J	
		LV30684-002A	POWER BUTTON		1	B,E,EN,U,UY	
	4	FSJD4001-002	INDICATOR	POWER	1		
	5	LV40767-001A	INDICATOR	BASS BOOST	1		
	6	LV20228-003A	FRONT ESC.		1		
	7	LV20227-001A	PUSH BUTTON	SOURCE	1		
	8	LV40604-001A	INDICATOR		1		
	9	LV20229-004A	LENS	RX-558VBK	1	C,J,U,UY	
		LV20229-005A	LENS	RX-558RBK	1	B,E,EN	
	10	LV30685-001A	PUSH BUTTON	SEA	1		
	11	QYSDSF2608Z	SCREW	F.C.B-F.PANEL	13		
	12	QYSDSF2608Z	SCREW	F.ESC.-F.PANEL	6		
	13	QYSDSF2608Z	SCREW	C.B-F.ESC.	1		
	14	QYSDSG3008M	SCREW	F.P-F.B(LOW)	4		
	15	QYSBSG3008E	T.SCREW	F.P-F.B(UP)	3		
	16	LE10081-004A	CHASSIS BASE		1		
	17	LV20230-001A	FRONT BKT		1		
	18	QYSBSG3008E	T.SCREW	C.B-F.B	6		
	19	LV30687-001A	BRACKET		1		
	20	QYSBSG3008E	T.SCREW	BKT-F.B	2		
	21	E68587-223SM	CB BKT		2		
	22	QYSBST3006E	TAP.SCREW	C.B-BKT	2		
	23	LE40138-001A	BRACKET		3		
	24	QYSBSG3008E	T.SCREW	BKT-C.B	3		
	25	QZF6018-001	FOOT		2		
	26	QZF6018-001	FOOT		2	B,E,EN,U,UY	
		E47227-036	FOOT		2	C,J	
	27	QYSBST3010Z	TH TAP SCREW	FOOT	4		
	28	E407321-002SM	PUSH BUTTON	SPK	2		
	29	QYSBST3006E	TAP.SCREW	SPK SW C.B	2		
	30	VKZ4150-001	SPECIAL NUT		1		
	31	QYSBSG3008E	T.SCREW	PRI.C.B-FRAME	4		
	32	QYSBSG3008E	T.SCREW		1		
	33	QUQ412-2918CJ	FLAT WIRE ASSY	FW304	1		
	34	QUQ412-1316CJ	FFC CABLE	FW811	1		
	35	QYSBSG3008E	T.SCREW		8		
	36	LV30384-001A	FASTENER	M.C.B	1		
	37	LV30351-001A	HEAT SINK		1		
	38	E310171-001SM	H.S BKT	FRONT SIDE	1		
	39	E310172-001SM	H.S BKT	REAR SIDE	1		
	40	QYSBSG3008E	T.SCREW	H.S BKT-H.S	2		
	41	QYSDSG3008M	SCREW	H.BKT(F)-C.BASE	1		
	42	QYSDSG3008M	SCREW	H.BKT(R)-C.BASE	2		
	43	QYSBSG3008E	T.SCREW	H.BKT(F)-F.BKT	1		
	44	E73525-003SS	SCREW	P.TR	11		
	45	VKZ4001-111S	WIRE CLAMP		1		
△	46	2SD2390LD/OPY/	TRANSISTOR	Q761,Q762	2	C,J,U,UY	
△		2SD2389LD/OPY/	TRANSISTOR	Q761,Q762	2	B,E,EN	
△	47	2SB1559LD/OPY/	TRANSISTOR	Q763,Q764	2	B,E,EN	
△		2SB1560LD/OPY/	TRANSISTOR	Q763,Q764	2	C,J,U,UY	
△	48	2SD2390LD/OPY/	TRANSISTOR	Q507	1	C,J,U,UY	
△		2SD2389LD/OPY/	TRANSISTOR	Q507	1	B,E,EN	
△	49	2SB1559LD/OPY/	TRANSISTOR	Q508	1	B,E,EN	
△		2SB1560LD/OPY/	TRANSISTOR	Q508	1	C,J,U,UY	
△	50	2SD2390LD/OPY/	TRANSISTOR	Q575	1	C,J,U,UY	
△		2SD2389LD/OPY/	TRANSISTOR	Q575	1	B,E,EN	

BLOCK NO. M1MM

REF.	PARTS NO.	PARTS NAME	REMARKS	QTY	SUFFIX	CLR
51	2SB1559LD/OPY/	TRANSISTOR	Q576	1	B,E,EN	
	2SB1560LD/OPY/	TRANSISTOR	Q576	1	C,J,U,UY	
52	2SD2390LD/OPY/	TRANSISTOR	Q1507	1	C,J,U,UY	
	2SD2389LD/OPY/	TRANSISTOR	Q1507	1	B,E,EN	
53	2SB1560LD/OPY/	TRANSISTOR	Q1508	1	C,J,U,UY	
	2SB1559LD/OPY/	TRANSISTOR	Q1508	1	B,E,EN	
54	2SC4466LD/OPY/	TRANSISTOR	Q831	1		
55	QQT0240-001	POWER TRANSF.		1	B,E,EN	
	QQT0187-001	POWER TRANSF.		1	C,J	
	QQT0239-001	POWER TRANSF.		1	U,UY	
56	QYSDSTL4008E	SPECIAL SCREW	POWER TRANSF.	4		
57	LE20127-032A	REAR PANEL	RX-558VBK	1	C,J	
	LE20127-035A	REAR PANEL	RX-558RBK	1	B,E,EN	
	LE20127-033A	REAR PANEL	RX-558VBK	1	U,UY	
58	QYSBSGY3008M	SPECIAL SCREW	R.P-C.BASE	3		
59	QYSBSGY3008M	SPECIAL SCREW	TUNER	2		
60	QYSBSGY3008M	SPECIAL SCREW	INPUT	3		
61	QYSBSGY3008M	SPECIAL SCREW	VIDEO	4	C,J,U,UY	
62	QYSBSGY3008M	SPECIAL SCREW	DCS	1		
63	QYSBSGY3008M	SPECIAL SCREW	F.SPK	2		
64	QYSBSGY3008M	SPECIAL SCREW	SURROUND	2		
65	QYSBSGY3008M	SPECIAL SCREW	MAIN C.B	1		
66	QYSBSGY3008M	SPECIAL SCREW	SUB.WOOF	1		
67	QYSBSGY3008M	SPECIAL SCREW		1	C,J,U,UY	
68	QYSBSGY3008M	SPECIAL SCREW		1	C,J	
	QYSBSGY3008M	SPECIAL SCREW		2	U,UY,B,E,EN	
69	QMPD220-200-JD	POWER CORD		1	C,J	
	QMP5530-0085LBS	POWER CORD		1	B	
	QMP3900-200L	POWER CORD		1	E,EN,U	
	QMPR160-200-JC	POWER CORD		1	UY	
70	QHS3771-108	CORD STOPPER		1		
71	LE20131-002A/S/	METAL COVER		1	B,E,EN,U,UY	
	LE20131-001A/S/	METAL COVER		1	C,J	
72	E406308-003	SPECIAL SCREW	M.COVER-FRAME	4		
73	QYSBSGY3008M	SPECIAL SCREW	M.COVER-R.PANEL	3		
74	LV30480-001A	VOL KNOB ASS'Y		1		
75	QMF51U1-6R3-J1	FUSE	F801	1	C,J	
	QMF51E2-6R3-J1	FUSE	F801	1	U,UY	
	QMF51E2-1R6-J1	FUSE	F801	1	B,E,EN	
76	QMF51E2-2R0-J1	FUSE	F811,F812	2	B,E,EN,U,UY	
	QMF51U1-2R0-J1	FUSE	F811,F812	2	C,J	
77	QMF51E2-R10-J1	FUSE	F802	1	B,E,EN,U,UY	
78	LV30686-001A	PUSH BUTTON	RDS	1	B,E,EN	
79	QYSBSG3008E	T.SCREW	SUB CB	1	B,E,EN	
81	E208294-001SM	PROTECT SHEET		1	B,E,EN,U,UY	
82	E307572-001	FASTENER		1	B,E,EN,U,UY	
83	E65507-001	CAUTION LABEL		2	C	
	E67199-001	CAUTION LABEL		2	J	
84	E409394-001	CAUTION LABEL		1	J	
	E409396-001	CAUTION LABEL		1	B,E,EN	
	E409396-001	CAUTION LABEL		1	C,U,UY	
85	E408632-002	RATING LABEL		1	C	
86	QYSBSG3008E	T.SCREW		3		
87	QYSBSGY3008M	SPECIAL SCREW	VOL.SEL	2	U,UY	
89	QMF51E2-3R15-J1	FUSE	F803	1	U,UY	
90	QYSBSG3008E	T.SCREW		1	U,UY	



# Electrical Parts List

## ■ System Control & D.S.P. P.C.B.

BLOCK NO. 01		BLOCK NO. 01		
A. REF.	PARTS NO.	PARTS NAME	REMARKS	SUFFIX
C 401	QEC1AM-227Z	E CAPACITOR	220PF 20% 10V	
C 402	QZ0202-155Z	ML C CAPACITOR	1.5MF	
C 403	QEZ0329-104Z	E CAPACITOR	PF	
C 404	QEK41HM-225	E CAPACITOR	2.2MF 20% 50V	
C 405	QDV81E2-223Y	C CAPACITOR	330PF 10% 50V	
C 406	QCB1HK-331Y	E CAPACITOR	4.7MF 20% 50V	
C 411	QEK1HM-475Z	E CAPACITOR	4.7MF 20% 50V	
C 412	QEK1HM-475Z	E CAPACITOR	4.7MF 20% 50V	
C 413	QEK1AM-107Z	E CAPACITOR	100PF 5% 50V	
C 414	QEK1HM-475Z	E CAPACITOR	4.7MF 20% 50V	
C 551	QETN1HM-106Z	E CAPACITOR	10MF 20% 50V	
C 552	QCS11HJ-271	C CAPACITOR	270PF 5% 50V	
C 553	QCS11HJ-101	C CAPACITOR	100PF 5% 50V	
C 553	QCS11HJ-101	C CAPACITOR	100PF 5% 50V	
C 553	QCS31HJ-221Z	C CAPACITOR	220PF 5% 50V	
C 556	QCS31HK-152Z	C CAPACITOR	1500PF 10% 50V	
C 557	QCS11HJ-220	C CAPACITOR	22PF 5% 50V	
C 558	QET41CM-476	E CAPACITOR	47MF 20% 16V	
C 561	QETN1HM-225Z	E CAPACITOR	2.2MF 20% 50V	
C 562	QCS32HJ-330Z	C CAPACITOR	33PF 5% 500V	
C 563	QELC1HJ-103Z	M CAPACITOR	.010MF 5% 50V	
C 564	QET41HM-476	E CAPACITOR	47MF 20% 50V	
C 601	QET41HM-475	E CAPACITOR	4.7MF 20% 50V	
C 602	QET41HM-475	E CAPACITOR	4.7MF 20% 50V	
C 603	QDXB1CM-222Y	C CAPACITOR	220PF 5% 50V	
C 604	QDXB1CM-222Y	C CAPACITOR	220PF 5% 50V	
C 605	QET41HM-475	E CAPACITOR	4.7MF 20% 50V	
C 606	QET41HM-475	E CAPACITOR	4.7MF 20% 50V	
C 607	QDXB1CM-222Y	C CAPACITOR	220PF 5% 50V	
C 608	QDXB1CM-222Y	C CAPACITOR	220PF 5% 50V	
C 609	QET41HM-475	E CAPACITOR	4.7MF 20% 50V	
C 610	QET41HM-475	E CAPACITOR	4.7MF 20% 50V	
C 611	QDXB1CM-222Y	C CAPACITOR	220PF 5% 50V	
C 612	QDXB1CM-222Y	C CAPACITOR	220PF 5% 50V	
C 613	QET41AM-476	E CAPACITOR	47MF 20% 10V	
C 614	QET41AM-476	E CAPACITOR	47MF 20% 10V	
C 615	QET41AM-476	E CAPACITOR	47MF 20% 10V	
C 616	QET41AM-476	E CAPACITOR	47MF 20% 10V	
C 617	QET41AM-476	E CAPACITOR	47MF 20% 10V	
C 618	QET41AM-476	E CAPACITOR	47MF 20% 10V	
C 619	QET41AM-476	E CAPACITOR	47MF 20% 10V	
C 620	QET41AM-476	E CAPACITOR	47MF 20% 10V	
C 621	QET41AM-476	E CAPACITOR	47MF 20% 10V	
C 622	QDYB1CM-103Y	C CAPACITOR	1000MF 20% 6.3V	
C 623	QET41AM-476	E CAPACITOR	47MF 20% 10V	
C 624	QDYB1CM-103Y	C CAPACITOR	1000MF 20% 6.3V	
C 628	QETN0JM-108Z	E CAPACITOR	1.5MF	
C 630	QCZ0202-155Z	ML C CAPACITOR	1.5MF	
C 631	QDYB1CM-103Y	C CAPACITOR	1000MF 20% 6.3V	
C 632	QETN0JM-108Z	E CAPACITOR	1.5MF	
C 633	QCZ0202-155Z	ML C CAPACITOR	1.5MF	
C 634	QDYB1CM-103Y	C CAPACITOR	1000MF 20% 6.3V	
C 635	QDGB1HK-102Y	C CAPACITOR	10PF 5% 50V	
C 636	QCS11HJ-100	C CAPACITOR	47PF 5% 50V	
C 637	QCS11HJ-470	C CAPACITOR	1800PF 10% 50V	
C 638	QCS31HK-182Z	C CAPACITOR	1800PF 10% 50V	

BLOCK NO. 01		BLOCK NO. 01		
A. REF.	PARTS NO.	PARTS NAME	REMARKS	SUFFIX
C 639	QCZ0202-155Z	ML C CAPACITOR	1.5MF	
C 701	QETN1HM-106Z	E CAPACITOR	10MF 20% 50V	
C 702	QETN1HM-106Z	E CAPACITOR	10MF 20% 50V	
C 703	QCS11HJ-271	C CAPACITOR	270PF 5% 50V	
C 704	QCS11HJ-271	C CAPACITOR	270PF 5% 50V	
C 705	QCS11HJ-101	C CAPACITOR	100PF 5% 50V	
C 706	QCS11HJ-101	C CAPACITOR	100PF 5% 50V	
C 711	QET41CM-107	E CAPACITOR	100MF 20% 16V	
C 712	QET41CM-107	E CAPACITOR	100MF 20% 16V	
C 713	QCS11HJ-220	C CAPACITOR	22PF 5% 50V	
C 714	QCS11HJ-220	C CAPACITOR	22PF 5% 50V	
C 717	QCS31HK-152Z	C CAPACITOR	1500PF 10% 50V	
C 718	QCS31HK-152Z	C CAPACITOR	1500PF 10% 50V	
C 721	QCS32HJ-220Z	C CAPACITOR	22PF 5% 500V	
C 722	QCS32HJ-220Z	C CAPACITOR	22PF 5% 500V	
C 723	QETN1HM-225Z	E CAPACITOR	2.2MF 20% 50V	
C 724	QETN1HM-225Z	E CAPACITOR	2.2MF 20% 50V	
C 727	QELC1HJ-103Z	M CAPACITOR	.010MF 5% 50V	
C 728	QELC1HJ-103Z	M CAPACITOR	.010MF 5% 50V	
C 739	QETN1JM-107Z	E CAPACITOR	100MF 20% 63V	
C 750	QETN1HM-227Z	E CAPACITOR	220MF 20% 50V	B,E,EN
C 751	QETN1JM-227Z	E CAPACITOR	220MF 20% 63V	B,E,EN
C 752	QETN1HM-226Z	E CAPACITOR	22MF 20% 50V	B,E,EN
C 753	QETN1HM-226Z	E CAPACITOR	22MF 20% 50V	B,E,EN
CN304	QGF1210G1-29	FFC/FPC CONNE		
CN401	QJB002-041004	SIN ID C-B WIRE		
CN402	QGA2001F1-11	11P CN RIG		
CN404	QJB001-043004	SOCKET WIRE ASS		
CN411	QGA2001F1-04	4P PLUG ASSY		
CN412	QJB002-111004	SKT-WIRE ASSY		
CN601	QGB2510K1-08	CONNECTOR		
CN602	QGB2510K1-09	CONNECTOR		
CN605	QGB2510K1-06	CONNECTOR		
CN606	QGB2510K1-04	CONNECTOR		
CN701	QGB2510K1-10	CONNECTOR		
CN703	QGB2510K1-05	CONNECTOR		
CN712	QGA2001F1-06	6P PLUG ASSY		
CN801	QGF1205F1-13	CONNECTOR		
CN812	QGA2501C1-03	3P CONNECTOR		
CN841	QGB2510K1-06	CONNECTOR		
C1252	QCB81HK-231Y	C CAPACITOR	220PF 10% 50V	
C1254	QCZ0202-155Z	ML C CAPACITOR	1.5MF	
C1254	GFVJ1HJ-104Z	TF CAPACITOR	.10MF 5% 50V	
D 401	1SR139-200-T4	DIODE		C,J
D 402	1SS133-T2	DIODE		B,E,EN,U,UY
D 403	1SS133-T2	DIODE		
D 404	1SS133-T2	DIODE		
D 410	1SS133-T2	DIODE		
D 411	SLR-342VC-T	LED	(STAND-BY)	
D 415	1SS133-T2	DIODE		
D 419	SLR-342VC-T	LED	ONE TOUCH	
D 420	SLR-342VC-T	LED	INPUT ATT	
D 425	1SS133-T2	DIODE		
D 426	1SS133-T2	DIODE		
D 427	SLR-342VC-T	LED		

BLOCK NO. 01

A. REF.	PARTS NO.	PARTS NAME	REMARKS	SUFFIX
R 404	QRE141J-103Y	C RESISTOR	10K 5% 1/4W	
R 405	QRE141J-472Y	C RESISTOR	4.7K 5% 1/4W	
R 406	QRE141J-103Y	C RESISTOR	10K 5% 1/4W	
R 407	QRE141J-471Y	C RESISTOR	470 5% 1/4W	
R 410	QRE141J-103Y	C RESISTOR	10K 5% 1/4W	
R 411	QRE141J-221Y	C RESISTOR	220 5% 1/4W	
R 412	QRE141J-103Y	C RESISTOR	10K 5% 1/4W	
R 413	QRE141J-103Y	C RESISTOR	10K 5% 1/4W	
R 414	QRE141J-103Y	C RESISTOR	10K 5% 1/4W	
R 416	QRE141J-103Y	C RESISTOR	10K 5% 1/4W	
R 419	QRE141J-472Y	C RESISTOR	4.7K 5% 1/4W	
R 420	QRE141J-104Y	C RESISTOR	100K 5% 1/4W	
R 421	QRE141J-104Y	C RESISTOR	100K 5% 1/4W	
R 422	QRE141J-104Y	C RESISTOR	100K 5% 1/4W	
R 424	QRE141J-221Y	C RESISTOR	220 5% 1/4W	
R 425	QRE141J-221Y	C RESISTOR	220 5% 1/4W	
R 434	QRE141J-103Y	C RESISTOR	10K 5% 1/4W	
R 435	QRE141J-103Y	C RESISTOR	10K 5% 1/4W	
R 436	QRE141J-221Y	C RESISTOR	220 5% 1/4W	
R 437	QRE141J-221Y	C RESISTOR	220 5% 1/4W	
R 438	QRE141J-221Y	C RESISTOR	220 5% 1/4W	
R 439	QRE141J-221Y	C RESISTOR	220 5% 1/4W	
R 440	QRE141J-221Y	C RESISTOR	220 5% 1/4W	
R 441	QRE141J-221Y	C RESISTOR	220 5% 1/4W	
R 442	QRE141J-221Y	C RESISTOR	220 5% 1/4W	
R 443	QRE141J-221Y	C RESISTOR	220 5% 1/4W	
R 444	QRE141J-221Y	C RESISTOR	220 5% 1/4W	
R 445	QRE141J-221Y	C RESISTOR	220 5% 1/4W	
R 446	QRE141J-221Y	C RESISTOR	220 5% 1/4W	
R 447	QRE141J-221Y	C RESISTOR	220 5% 1/4W	
R 448	QRE141J-221Y	C RESISTOR	220 5% 1/4W	
R 449	QRE141J-221Y	C RESISTOR	220 5% 1/4W	
R 450	QRE141J-221Y	C RESISTOR	220 5% 1/4W	
R 451	QRE141J-221Y	C RESISTOR	220 5% 1/4W	
R 452	QRE141J-221Y	C RESISTOR	220 5% 1/4W	
R 453	QRE141J-221Y	C RESISTOR	220 5% 1/4W	
R 454	QRE141J-152Y	C RESISTOR	1.5K 5% 1/4W	
R 455	QRE141J-221Y	C RESISTOR	220 5% 1/4W	
R 456	QRE141J-221Y	C RESISTOR	220 5% 1/4W	
R 457	QRE141J-221Y	C RESISTOR	220 5% 1/4W	
R 458	QRE141J-221Y	C RESISTOR	220 5% 1/4W	
R 469	QRE141J-221Y	C RESISTOR	220 5% 1/4W	
R 551	QRE141J-222Y	C RESISTOR	2.2K 5% 1/4W	
R 552	QRE141J-563Y	C RESISTOR	56K 5% 1/4W	
R 553	QRE141J-302Y	C RESISTOR	3.0K 5% 1/4W	
R 555	QRE141J-183Y	C RESISTOR	18K 5% 1/4W	
R 556	QRE141J-101Y	C RESISTOR	100 5% 1/4W	
R 558	QRE141J-391Y	C RESISTOR	390 5% 1/4W	
R 560	QRE141J-563Y	C RESISTOR	56K 5% 1/4W	
R 561	QRJ146J-331X	C RESISTOR	330 5% 1/4W	
R 563	QRJ146J-332Y	C RESISTOR	3.3K 5% 1/4W	
R 564	QRJ146J-332Y	C RESISTOR	3.3K 5% 1/4W	
R 565	QRJ146J-332Y	C RESISTOR	3.3K 5% 1/4W	
R 566	QRJ146J-332Y	C RESISTOR	3.3K 5% 1/4W	
R 569	QRJ146J-100X	C RESISTOR	10 5% 1/4W	

BLOCK NO. 01

A. REF.	PARTS NO.	PARTS NAME	REMARKS	SUFFIX
D 431	1S8133-T2	DIODE		
D 432	1S8133-T2	DIODE		
D 433	1S8133-T2	DIODE		B,E,EN
D 434	1S8133-T2	DIODE		
D 435	1S8133-T2	DIODE		
D 436	1S8133-T2	DIODE		
D 437	1S8133-T2	DIODE		B,E,EN
D 438	1S8133-T2	DIODE		UY
D 439	1S8133-T2	DIODE		U,UY
D 533	1S8133-T2	DIODE		
D 703	1S8133-T2	DIODE		
D 704	1S8133-T2	DIODE		
D 711	SLR-342MC-T	LED		
D 712	SLR-342MC-T	LED		
D 750	1SR139-200-T4	DIODE		B,E,EN
D 751	1SR139-200-T4	DIODE		B,E,EN
D 752	1SR139-200-T4	DIODE		B,E,EN
D 753	MT224C-T2	ZENER		B,E,EN
D1401	QLF0002-001	FL		
FH001	E309106-001SM	FL HOLDER		
FS001	E3400-444	FELT SPACER		
FS002	E3400-444	FELT SPACER		
HL401	VYH7653-001	IC HOLDER		
HL601	VYH7237-002	IC HOLDER		
IC401	MN173222BA	IC		
IC402	GP1U281X	IR DETECT UNIT		
IC403	IC-PST600/E/-T	IC		
IC601	TC9471F	IC		
JS401	QSW0502-001	PUSH SWITCH		
J1251	QNS0083-001	3.5 JACK		
L 601	QLI21M-2R2Y	INDUCTOR		
Q 401	DTC114YSA-T	D-TRANSISTOR		
Q 402	DTC114YSA-T	D-TRANSISTOR		
Q 403	DTC114YSA-T	D-TRANSISTOR		
Q 410	DTC114YSA-T	D-TRANSISTOR		
Q 411	DTC114YSA-T	D-TRANSISTOR		
Q 412	DTC114YSA-T	D-TRANSISTOR		
Q 413	DTC114YSA-T	D-TRANSISTOR		
Q 414	DTC114YSA-T	D-TRANSISTOR		
Q 444	DTC114YSA-T	D-TRANSISTOR		
Q 551	2SC2240/L/-T	TRANSISTOR		
Q 552	2SC2240/L/-T	TRANSISTOR		
Q 561	2SA1038S/SE/-T	TRANSISTOR		
Q 701	2SC2240/L/-T	TRANSISTOR		
Q 702	2SC2240/L/-T	TRANSISTOR		
Q 703	2SC2240/L/-T	TRANSISTOR		
Q 704	2SC2240/L/-T	TRANSISTOR		
Q 707	2SA1038S/SE/-T	TRANSISTOR		
Q 708	2SA1038S/SE/-T	TRANSISTOR		
Q 711	2SC389S/SE/-T	TRANSISTOR		
Q 712	2SC389S/SE/-T	TRANSISTOR		
Q 750	2SB1357/EF/-T	TRANSISTOR		
R 401	QRE141J-103Y	C RESISTOR	10K 5% 1/4W	B,E,EN
R 402	QRE141J-331Y	C RESISTOR	330 5% 1/4W	
R 403	QRE141J-223Y	C RESISTOR	22K 5% 1/4W	

BLOCK NO. 01111111

A	REF.	PARTS NO.	PARTS NAME	PARTS NO.	PARTS NAME	REMARKS	SUFFIX
	S 413	QSW0683-001Z	PUSH SWITCH			CD	
	S 414	QSW0683-001Z	PUSH SWITCH			PHONO	
	S 415	QSW0683-001Z	PUSH SWITCH			TAPE/MD	
	S 416	QSW0683-001Z	PUSH SWITCH			AM	
	S 417	QSW0683-001Z	PUSH SWITCH			ADJUT	
	S 418	QSW0683-001Z	PUSH SWITCH			SETTING	
	S 419	QSW0683-001Z	PUSH SWITCH			MEMORY	
	S 420	QSW0683-001Z	PUSH SWITCH			EON	B/E,EN
	S 421	QSW0683-001Z	PUSH SWITCH			TA/NEWS/INFO	B/E,EN
	S 422	QSW0683-001Z	PUSH SWITCH			PTY	B/E,EN
	S 423	QSW0683-001Z	PUSH SWITCH			DISPLAY	B/E,EN
	TH750	QAD0095-4R7Z	P-THERMISTOR				B/E,EN
	X 401	QAX0112-001Z	CRYSTAL				B/E,EN
	X 601	QAX0257-001Z	CRYSTAL				B/E,EN

BLOCK NO. 01111111

A	REF.	PARTS NO.	PARTS NAME	REMARKS	SUFFIX
	R 570	QRJ146J-100X	C RESISTOR	10 5% 1/4W	
	R 601	QRE141J-271Y	C RESISTOR	270 5% 1/4W	
	R 602	QRE141J-271Y	C RESISTOR	270 5% 1/4W	
	R 603	QRE141J-271Y	C RESISTOR	270 5% 1/4W	
	R 604	QRE141J-271Y	C RESISTOR	270 5% 1/4W	
	R 605	QRE141J-271Y	C RESISTOR	270 5% 1/4W	
	R 606	QRE141J-271Y	C RESISTOR	270 5% 1/4W	
	R 607	QRE141J-225Y	C RESISTOR	2.2M 5% 1/4W	
	R 608	QRE141J-104Y	C RESISTOR	100K 5% 1/4W	
	R 609	QRE141J-104Y	C RESISTOR	100K 5% 1/4W	
	R 610	QRE141J-104Y	C RESISTOR	100K 5% 1/4W	
	R 611	QRE141J-104Y	C RESISTOR	100K 5% 1/4W	
	R 612	QRE141J-103Y	C RESISTOR	10K 5% 1/4W	
	R 613	QRE141J-103Y	C RESISTOR	10K 5% 1/4W	
	R 614	QRE141J-103Y	C RESISTOR	10K 5% 1/4W	
	R 701	QRE141J-222Y	C RESISTOR	2.2K 5% 1/4W	
	R 702	QRE141J-222Y	C RESISTOR	2.2K 5% 1/4W	
	R 703	QRE141J-563Y	C RESISTOR	56K 5% 1/4W	
	R 704	QRE141J-563Y	C RESISTOR	56K 5% 1/4W	
	R 705	QRE141J-332Y	C RESISTOR	3.3K 5% 1/4W	
	R 706	QRE141J-332Y	C RESISTOR	3.3K 5% 1/4W	
	R 709	QRE141J-183Y	C RESISTOR	18K 5% 1/4W	
	R 710	QRE141J-183Y	C RESISTOR	18K 5% 1/4W	
	R 711	QRE141J-391Y	C RESISTOR	390 5% 1/4W	
	R 712	QRE141J-391Y	C RESISTOR	390 5% 1/4W	
	R 713	QRE141J-563Y	C RESISTOR	56K 5% 1/4W	
	R 714	QRE141J-563Y	C RESISTOR	56K 5% 1/4W	
	R 717	QRE141J-101Y	C RESISTOR	100 5% 1/4W	
	R 718	QRE141J-101Y	C RESISTOR	100 5% 1/4W	
	R 721	QRJ146J-331X	C RESISTOR	330 5% 1/4W	
	R 722	QRJ146J-331X	C RESISTOR	330 5% 1/4W	
	R 727	QRE141J-473Y	C RESISTOR	47K 5% 1/4W	
	R 728	QRE141J-473Y	C RESISTOR	47K 5% 1/4W	
	R 729	QRJ146J-331X	C RESISTOR	330 5% 1/4W	
	R 730	QRJ146J-331X	C RESISTOR	330 5% 1/4W	
	R 739	QRJ146J-100X	C RESISTOR	10 5% 1/4W	
	R 740	QRJ146J-100X	C RESISTOR	10 5% 1/4W	B/E,EN
	R 750	QRJ146J-562X	C RESISTOR	5.6K 5% 1/4W	B/E,EN
	R 751	QRE141J-223Y	C RESISTOR	22K 5% 1/4W	B/E,EN
	RA401	QRB049J-103	R-NETWORK	10K 5% 1/4W	
	RA402	QRB109J-103	R-NETWORK	10K 5% 1/0W	
	R1253	QRE141J-471Y	C RESISTOR	470 5% 1/4W	
	R1254	QRE141J-221Y	C RESISTOR	220 5% 1/4W	
	S 401	QSW0683-001Z	PUSH SWITCH	POWER	
	S 402	QSW0683-001Z	PUSH SWITCH	SURROUND	
	S 403	QSW0683-001Z	PUSH SWITCH	ONE TOUCH	
	S 404	QSW0683-001Z	PUSH SWITCH	INPUT ATT	
	S 405	QSW0683-001Z	PUSH SWITCH	DVD	
	S 406	QSW0683-001Z	PUSH SWITCH	DVD MULTI	
	S 407	QSW0683-001Z	PUSH SWITCH	VCR	
	S 408	QSW0683-001Z	PUSH SWITCH	FM	
	S 409	QSW0683-001Z	PUSH SWITCH	CONTROL	
	S 410	QSW0683-001Z	PUSH SWITCH	CONTROL	
	S 411	QSW0683-001Z	PUSH SWITCH	CONTROL	
	S 412	QSW0683-001Z	PUSH SWITCH	CONTROL	

■ Main P.C.B.

BLOCK NO. 02

A REF.	PARTS NO.	PARTS NAME	REMARKS	SUFFIX
C 501	QETN1HM-106Z	E CAPACITOR	10MF 20% 50V	
C 502	QGS11HJ-271	C CAPACITOR	270PF 5% 50V	C-J,U,UY
C 503	QGS11HJ-101	C CAPACITOR	100PF 5% 50V	B,E,EN
C 503	QGS31HJ-331Z	C CAPACITOR	330PF 5% 50V	
C 504	QGB31HK-153Z	C CAPACITOR	1500PF 10% 50V	
C 507	QGS11HJ-220	C CAPACITOR	22PF 5% 50V	C-J,U,UY
C 507	QGS31HJ-100Z	C CAPACITOR	10PF 5% 50V	B,E,EN
C 508	QET41CM-476	E CAPACITOR	47MF 20% 16V	
C 511	QETN1HM-225Z	E CAPACITOR	2.2MF 20% 50V	
C 512	QFLC1HJ-103Z	M CAPACITOR	.010MF 5% 50V	
C 513	QGS32HJ-330Z	C CAPACITOR	33PF 5% 500V	
C 514	QET41HM-476	E CAPACITOR	47MF 20% 50V	
C 517	QETN2AM-106Z	E CAPACITOR	10MF 20% 100V	
C 521	QGS32HJ-470Z	C CAPACITOR	47PF 5% 500V	
C 522	QGS32HJ-470Z	C CAPACITOR	47PF 5% 500V	
C 543	QFLC1HJ-473Z	M CAPACITOR	.047MF 5% 50V	
C 544	QFLC1HJ-223Z	M CAPACITOR	.022MF 5% 50V	
C 571	QGS32HJ-470Z	C CAPACITOR	47PF 5% 500V	
C 572	QGS32HJ-470Z	C CAPACITOR	47PF 5% 500V	
C 581	QFLC1HJ-473Z	M CAPACITOR	.047MF 5% 50V	
C 582	QFLC1HJ-223Z	M CAPACITOR	.022MF 5% 50V	
C 751	QGS32HJ-470Z	C CAPACITOR	47PF 5% 500V	
C 752	QGS32HJ-470Z	C CAPACITOR	47PF 5% 500V	
C 753	QGS32HJ-470Z	C CAPACITOR	47PF 5% 500V	
C 754	QGS32HJ-470Z	C CAPACITOR	47PF 5% 500V	
C 771	QFLC1HJ-473Z	M CAPACITOR	.047MF 5% 50V	
C 772	QFLC1HJ-473Z	M CAPACITOR	.047MF 5% 50V	
C 773	QFLC1HJ-223Z	M CAPACITOR	.022MF 5% 50V	
C 774	QFLC1HJ-223Z	M CAPACITOR	.022MF 5% 50V	
C 800	QGV81E2-223Y	C CAPACITOR	.022MF 5% 50V	B,E,EN
C 801	QFN32AK-472Z	M CAPACITOR	4700PF 10% 100V	
C 802	QETM1JM-477	AL E. CAPACITOR	470MF 20% 63V	U,UY
C 802	QET41EM-477	C CAPACITOR	470MF 20% 25V	C-J,B,E,EN
C 803	QETN1AM-477Z	E CAPACITOR	470MF 20% 10V	U,UY
C 803	QET41CM-476	E CAPACITOR	47MF 20% 16V	C-J,B,E,EN
C 804	QEZ9019-472	C CAPACITOR	4700PF	
C 811	QETB1VM-228	E CAPACITOR	2200MF 20% 35V	U,UY
C 811	QETM1VM-228	E CAPACITOR	2200MF 20% 35V	C-J,B,E,EN
C 812	QFN32AJ-104Z	M CAPACITOR	.10MF 5% 100V	
C 813	QFN32AJ-104Z	M CAPACITOR	.10MF 5% 100V	
C 816	QCF31HJ-223Z	C CAPACITOR	.022MF +80:-20%	
C 817	QCF31HJ-223Z	C CAPACITOR	.022MF +80:-20%	
C 820	QDV81E2-223Y	C CAPACITOR	.022MF 5% 50V	B,E,EN
C 821	QET41HM-476	E CAPACITOR	47MF 20% 50V	
C 822	QET41HM-476	E CAPACITOR	47MF 20% 50V	
C 831	QET41EM-107	E CAPACITOR	100MF 20% 25V	
C 833	QFVJ1HJ-334Z	M CAPACITOR	.33MF 5% 50V	
C 833	QFV41HJ-104	TF CAPACITOR	.10MF 5% 50V	
C 840	QET41HM-476	E CAPACITOR	47MF 20% 50V	C-J,U,UY
C 840	QETM1VM-107Z	E CAPACITOR	100MF 20% 35V	B,E,EN
C 841	QETM1VM-107Z	E CAPACITOR	100MF 20% 35V	B,E,EN
C 841	QET41HM-476	E CAPACITOR	47MF 20% 50V	C-J,U,UY
C 845	QET41HM-476	E CAPACITOR	47MF 20% 50V	
C 853	QET41EM-107	E CAPACITOR	100MF 20% 25V	
C 854	QET41EM-107	E CAPACITOR	100MF 20% 25V	

BLOCK NO. 02

A REF.	PARTS NO.	PARTS NAME	REMARKS	SUFFIX
C 861	QEZ0341-688	E CAPACITOR	6800MF	
C 862	QEZ0341-688	E CAPACITOR	6800MF	
C 863	QEN82CK-104	M CAPACITOR	.10MF 10% 160V	B,E,EN,U,UY
C 863	QEE22HP-103	C CAPACITOR	.010MF +100:-0%	C,J
C 864	QEE22HP-103	C CAPACITOR	.010MF +100:-0%	C,J
C 864	QEN82CK-104	M CAPACITOR	.10MF 10% 160V	B,E,EN,U,UY
C 865	QEN82CK-104	M CAPACITOR	.10MF 10% 160V	
C 885	QET41HM-105	E CAPACITOR	1.0MF 20% 50V	
C 896	QET41EM-107	E CAPACITOR	100MF 20% 25V	
C 897	QET41EM-107	E CAPACITOR	100MF 20% 25V	
C 903	QET41CM-476	E CAPACITOR	47MF 20% 16V	
C 904	QET41EM-106	E CAPACITOR	1.0MF 20% 25V	
C 931	QFLC1HJ-223Z	M CAPACITOR	.022MF 5% 50V	B,E,EN
C 932	QFLC1HJ-223Z	M CAPACITOR	.022MF 5% 50V	B,E,EN
C 933	QFLC1HJ-223Z	M CAPACITOR	.022MF 5% 50V	B,E,EN
C 934	QFLC1HJ-223Z	M CAPACITOR	.022MF 5% 50V	B,E,EN
C 935	QGS31HJ-221Z	C CAPACITOR	220PF 5% 50V	B,E,EN
C 936	QGS31HJ-221Z	C CAPACITOR	220PF 5% 50V	B,E,EN
C 937	QGS31HJ-221Z	C CAPACITOR	220PF 5% 50V	B,E,EN
C 938	QGS31HJ-221Z	C CAPACITOR	220PF 5% 50V	B,E,EN
C 941	QGS31HJ-221Z	C CAPACITOR	220PF 5% 50V	B,E,EN,U,UY
C 942	QGS31HJ-221Z	C CAPACITOR	220PF 5% 50V	B,E,EN,U,UY
C 943	QGS31HJ-221Z	C CAPACITOR	220PF 5% 50V	B,E,EN,U,UY
C 944	QGS31HJ-221Z	C CAPACITOR	220PF 5% 50V	B,E,EN,U,UY
C 945	QGS31HJ-221Z	C CAPACITOR	220PF 5% 50V	B,E,EN,U,UY
C 946	QGS31HJ-221Z	C CAPACITOR	220PF 5% 50V	B,E,EN,U,UY
C 961	QGBB1HK-331Y	C CAPACITOR	330PF 10% 50V	
C 962	QGBB1HK-331Y	C CAPACITOR	330PF 10% 50V	
C 971	QFLC1HJ-223Z	M CAPACITOR	.022MF 5% 50V	B,E,EN
C 972	QGS31HJ-221Z	C CAPACITOR	220PF 5% 50V	B,E,EN
C 973	QGS31HJ-221Z	C CAPACITOR	220PF 5% 50V	B,E,EN
C 974	QGS31HJ-221Z	C CAPACITOR	220PF 5% 50V	B,E,EN
C 981	QFLC1HJ-223Z	C CAPACITOR	.022MF 5% 50V	B,E,EN
C 982	QFLC1HJ-223Z	C CAPACITOR	.022MF 5% 50V	B,E,EN
C 983	QGS31HJ-221Z	C CAPACITOR	220PF 5% 50V	B,E,EN,U,UY
C 984	QGS31HJ-221Z	C CAPACITOR	220PF 5% 50V	B,E,EN,U,UY
C 985	QGS31HJ-471Z	C CAPACITOR	470PF 5% 50V	B,E,EN
C 986	QGS31HJ-471Z	C CAPACITOR	470PF 5% 50V	B,E,EN
C 987	QGS31HJ-471Z	C CAPACITOR	470PF 5% 50V	B,E,EN
C 988	QGS31HJ-471Z	C CAPACITOR	470PF 5% 50V	B,E,EN
CN511	QGA2001C1-09	9P PLUG ASSY		
CN711	QGB2510J1-10	CONNECTOR		
CN713	QGB2510J1-05	CONNECTOR		
CN802	WJK0035-001A	CONN.WIRE ASSY		
CN811	QGF1205C1-13	CONNECTOR		
CN831	QGD2501C1-03Z	SOCKET ASSY		
CN851	QGB2510J1-06	CONNECTOR		
D 503	1S5133-T2	DIODE		
D 511	1S5133-T2	DIODE		
D 512	1S5133-T2	DIODE		
D 531	1S5133-T2	DIODE		
D 585	1S5133-T2	DIODE		
D 586	1S5133-T2	DIODE		
D 591	1S5133-T2	DIODE		
D 781	1S5133-T2	DIODE		



BLOCK NO. 02

REF.	PARTS NO.	PARTS NAME	REMARKS	SUFFIX
FW961	QUM133-10Z4Z4	FLAT WIRE		
HS805	E70945-H40B	HEAT SINK		U,U,Y
HS841	E70306-001	HEAT SINK		
HS851	E70945-H40B	HEAT SINK		
HS891	E70306-001	HEAT SINK		
I6831	NJM78M05FA	IC		
J 961	QNS0023-001	JACK		
L 501	QQLZ005-R45	INDUCTOR		
L 581	QQLZ005-R45	INDUCTOR		
L 771	QQLZ005-R45	INDUCTOR		
L 772	QQLZ005-R45	INDUCTOR		
L 931	QQLZ005-R45	INDUCTOR		B,E,EN
L 932	QQLZ005-R45	INDUCTOR		B,E,EN
L 971	QQLZ005-R45	INDUCTOR		B,E,EN
L 981	QQLZ005-R45	INDUCTOR		B,E,EN
L 982	QQLZ005-R45	INDUCTOR		B,E,EN
Q 501	2SC2240/L/-T	TRANSISTOR		
Q 502	2SC2240/L/-T	TRANSISTOR		
Q 503	2SA1038S/SE/-T	TRANSISTOR		
Q 509	2SA1038S/SE/-T	TRANSISTOR		
Q 511	2SC2389S/SE/-T	TRANSISTOR		
Q 512	2SA1038S/SE/-T	TRANSISTOR		
Q 540	2SD637/QR/	TRANSISTOR		
Q 568	2SD637/QR/	TRANSISTOR		
Q 585	2SC2389S/SE/-T	TRANSISTOR		
Q 586	2SA1038S/SE/-T	TRANSISTOR		
Q 591	2SA1038S/SE/-T	TRANSISTOR		
Q 741	2SD637/QR/	TRANSISTOR		
Q 742	2SD637/QR/	TRANSISTOR		
Q 781	2SC2389S/SE/-T	TRANSISTOR		
Q 782	2SC2389S/SE/-T	TRANSISTOR		
Q 783	2SA1038S/SE/-T	TRANSISTOR		
Q 784	2SA1038S/SE/-T	TRANSISTOR		
Q 802	2SC2235/0Y/-T	TRANSISTOR		
Q 803	DTC123YSA-T	D-TRANSISTOR		
Q 805	2SD12667Q/	TRANSISTOR		U,U,Y
Q 821	2SB1187/EF/	TRANSISTOR		
Q 841	2SB1187/EF/	TRANSISTOR		
Q 851	2SD2061/EF/	TRANSISTOR		
Q 860	DTC123YSA-T	D-TRANSISTOR		B,E,EN,U,U,Y
Q 885	2SC2240/6L/-T	TRANSISTOR		
Q 891	2SD2061/EF/	TRANSISTOR		
Q 901	2SA1038S/SE/-T	TRANSISTOR		
Q 902	2SA1038S/SE/-T	TRANSISTOR		
Q 903	DTC123YSA-T	D-TRANSISTOR		
Q 904	2SC1740S/RS/-T	TRANSISTOR		
Q 905	2SC2389S/SE/-T	TRANSISTOR		
Q 906	2SA1038S/SE/-T	TRANSISTOR		
Q 951	DTC123YSA-T	D-TRANSISTOR		
Q 952	DTC123YSA-T	D-TRANSISTOR		
R 1	QRE141J-103Y	CARBON RESISTOR	10K 5% 1/4W	U,U,Y
R 2	QRE141J-103Y	CARBON RESISTOR	10K 5% 1/4W	U,U,Y
R 3	QRE141J-103Y	CARBON RESISTOR	10K 5% 1/4W	U,U,Y
R 501	QRE141J-222Y	C RESISTOR	2.2K 5% 1/4W	
R 502	QRE141J-563Y	C RESISTOR	56K 5% 1/4W	

BLOCK NO. 02

REF.	PARTS NO.	PARTS NAME	REMARKS	SUFFIX
D 782	1SS133-T2	DIODE		
D 783	1SS133-T2	DIODE		
D 784	1SS133-T2	DIODE		
D 801	1SR139-200-T4	DIODE		
D 802	1SR139-200-T4	DIODE		
D 803	1SR139-200-T4	DIODE		
D 804	1SR139-200-T4	DIODE		
D 805	MTZJ120-T2	ZENER DIODE		U,U,Y
D 806	1SS133-T2	DIODE		
D 807	MTZJ6.8C-T2	ZENER DIODE		
D 808	1SS133-T2	DIODE		
D 811	10E2-FD	DIODE		
D 812	10E2-FD	DIODE		
D 822	MTZJ136-T2	ZENER DIODE		
D 831	MTZJ7.5C-T2	ZENER DIODE		
D 832	MTZJ3.3B-T2	ZENER DIODE		
D 840	MTZJ10C-T2	ZENER DIODE		
D 841	MTZJ16C-T2	ZENER DIODE		
D 851	MTZJ13C-T2	ZENER DIODE		
D 860	1SS133-T2	DIODE		B,E,EN,U,U,Y
D 861	30DF2-FC	DIODE		B,E,EN,U,U,Y
D 861	6A20G-E4	DIODE		C,J
D 862	6A20G-E4	DIODE		C,J
D 862	30DF2-FC	DIODE		B,E,EN,U,U,Y
D 863	30DF2-FC	DIODE		B,E,EN,U,U,Y
D 863	6A20G-E4	DIODE		C,J
D 864	6A20G-E4	DIODE		C,J
D 864	30DF2-FC	DIODE		B,E,EN,U,U,Y
D 885	MTZJ6.2C-T2	ZENER DIODE		
D 891	MTZJ6.2C-T2	ZENER DIODE		
D 901	1SS133-T2	DIODE		
D 902	1SS133-T2	DIODE		
D 921	1SS133-T2	DIODE		
D 925	1SS133-T2	DIODE		
D 931	1SS133-T2	DIODE		
D 932	1SS133-T2	DIODE		
EP110	QNZ0136-001Z	EARTH PLATE		
EP500	QNZ0136-001Z	EARTH PLATE		
EP800	E409182-001SM	GRAND TERMINAL		
EP901	E409182-001SM	EARTH TERMINAL		B,E,EN,U,U,Y
FC801	QNG0020-001Z	FUSE CLIP		
FC802	QNG0020-001Z	FUSE CLIP		
FC803	QNG0020-001Z	FUSE CLIP		B,E,EN,U,U,Y
FC804	QNG0020-001Z	FUSE CLIP		B,E,EN,U,U,Y
FC805	QNG0020-001Z	FUSE CLIP		U,U,Y
FC806	QNG0020-001Z	FUSE CLIP		U,U,Y
FC810	QNG0020-001Z	FUSE CLIP		
FC811	QNG0020-001Z	FUSE CLIP		
FC812	QNG0020-001Z	FUSE CLIP		
FC813	QNG0020-001Z	FUSE CLIP		
FW801	QUM13A-13Z4Z4	F.WIRE ASSY		
FW831	QUM133-10D6Z4	FLAT WIRE		
FW901	QUM136-40Z4Z4	FLAT WIRE		
FW902	QUM135-20Z4Z4	FLAT WIRE		

BLOCK NO. 02

BLOCK NO. 02

REF.	PARTS NO.	PARTS NAME	REMARKS	SUFFIX
A R 753	QRJ146J-100X	C RESISTOR	10 5% 1/4W	
A R 754	QRJ146J-100X	C RESISTOR	10 5% 1/4W	
A R 771	QRZ0196-R22	NET. RESISTOR	1/1W	
A R 772	QRZ0196-R22	NET. RESISTOR	1/1W	
A R 773	QRJ125J-330	C RESISTOR	33 5% 1/2W	
A R 774	QRJ125J-330	C RESISTOR	33 5% 1/2W	
A R 775	QRL022J-100	UNF. OMF. RES.	10 5% 1/2W	
A R 776	QRL022J-100	UNF. OMF. RES.	10 5% 1/2W	
A R 777	QRJ146J-181Y	C RESISTOR	180 5% 1/4W	
A R 782	QRJ146J-181Y	C RESISTOR	180 5% 1/4W	
A R 783	QRJ146J-181Y	C RESISTOR	180 5% 1/4W	
A R 784	QRJ146J-181Y	C RESISTOR	180 5% 1/4W	
A R 785	QRJ146J-181Y	C RESISTOR	180 5% 1/4W	
A R 786	QRJ146J-181Y	C RESISTOR	180 5% 1/4W	
A R 787	QRJ146J-181Y	C RESISTOR	180 5% 1/4W	
A R 788	QRJ146J-181Y	C RESISTOR	180 5% 1/4W	
A R 800	QRZ9044-335	COMP. RESISTOR	3.3M 1/0W	C,J
A R 801	QRJ146J-3K3X	C RESISTOR	3.3 5% 1/4W	U,U,Y
A R 801	QRJ146J-3K3X	C RESISTOR	3.3 5% 1/4W	C,J,B,E,EN
A R 801	QRJ146J-100X	C RESISTOR	10 5% 1/4W	
A R 803	QRJ146J-821X	C RESISTOR	820 5% 1/4W	
A R 805	QRJ146J-100X	C RESISTOR	10 5% 1/4W	C,J,B,E,EN
A R 806	QRJ146J-153X	C RESISTOR	15K 5% 1/4W	U,U,Y
A R 807	QRL012J-332	C RESISTOR	3.3K 5% 1/1W	U,U,Y
A R 808	QRJ146J-100X	C RESISTOR	10 5% 1/4W	B,E,EN
A R 808	QRJ146J-8R2X	C RESISTOR	8.2 5% 1/4W	U,U,Y
A R 808	QRJ146J-2R7X	C RESISTOR	2.7 5% 1/4W	C,J
A R 821	QRJ146J-100X	C RESISTOR	10 5% 1/4W	
A R 822	QRJ146J-182X	C RESISTOR	1.8K 5% 1/4W	
A R 830	QRZ9006-4R7X	F RESISTOR	4.7 1/0W	
A R 831	QRZ9006-4R7X	F RESISTOR	4.7 1/0W	
A R 832	QRJ146J-272X	C RESISTOR	2.7K 5% 1/4W	
A R 840	QRJ146J-220X	C RESISTOR	22 5% 1/4W	
A R 841	QRJ146J-100X	C RESISTOR	10 5% 1/4W	J
A R 841	QRJ146J-2R2X	F RESISTOR	2.2 5% 1/4W	B,E,EN
A R 841	QRZ9005-100X	F RESISTOR	10 1/0W	C,U,U,Y
A R 842	QRJ146J-472X	C RESISTOR	4.7K 5% 1/4W	
A R 843	QRJ146J-100X	C RESISTOR	10 5% 1/4W	C,J,U,U,Y
A R 845	QRJ146J-102X	C RESISTOR	1.0K 5% 1/4W	
A R 853	QRZ9006-4R7X	F RESISTOR	4.7 1/0W	B,E,EN
A R 853	QRZ9006-4R7X	F RESISTOR	4.7 1/0W	C,U,U,Y
A R 853	QRJ146J-4R7X	C RESISTOR	4.7 5% 1/4W	J
A R 854	QRK126J-562X	C RESISTOR	5.6K 5% 1/2W	
A R 860	QRJ146J-220X	C RESISTOR	22 5% 1/4W	B,E,EN,U,U,Y
A R 861	QRJ146J-104Y	C RESISTOR	100K 5% 1/4W	
A R 862	QRJ146J-104Y	C RESISTOR	100K 5% 1/4W	
A R 885	QRJ146J-104Y	C RESISTOR	100K 5% 1/4W	
A R 891	QRZ9005-100X	F RESISTOR	10 1/0W	B,E,EN
A R 891	QRZ9005-100X	F RESISTOR	10 1/0W	C,U,U,Y
A R 891	QRJ146J-120X	C RESISTOR	12 5% 1/4W	J
A R 892	QRJ146J-272X	C RESISTOR	2.7K 5% 1/4W	
A R 901	QRJ146J-102Y	C RESISTOR	1.0K 5% 1/4W	
A R 902	QRJ146J-102Y	C RESISTOR	1.0K 5% 1/4W	
A R 903	QRJ146J-153Y	C RESISTOR	15K 5% 1/4W	
A R 904	QRJ146J-153Y	C RESISTOR	15K 5% 1/4W	
A R 905	QRJ146J-473Y	C RESISTOR	47K 5% 1/4W	

REF.	PARTS NO.	PARTS NAME	REMARKS	SUFFIX
A R 503	QRJ146J-302Y	C RESISTOR	3.0K 5% 1/4W	
A R 504	QRJ146J-101Y	C RESISTOR	100 5% 1/4W	
A R 505	QRJ146J-183Y	C RESISTOR	18K 5% 1/4W	
A R 507	QRJ146J-563Y	C RESISTOR	56K 5% 1/4W	
A R 508	QRJ146J-391Y	C RESISTOR	390 5% 1/4W	
A R 511	QRJ146J-331X	C RESISTOR	330 5% 1/4W	
A R 512	QRJ146J-332Y	C RESISTOR	3.3K 5% 1/4W	
A R 513	QRJ146J-332Y	C RESISTOR	3.3K 5% 1/4W	
A R 514	QRJ146J-332Y	C RESISTOR	3.3K 5% 1/4W	
A R 515	QRJ146J-332Y	C RESISTOR	3.3K 5% 1/4W	
A R 517	QRJ146J-100X	C RESISTOR	10 5% 1/4W	
A R 518	QRJ146J-100X	C RESISTOR	10 5% 1/4W	
A R 523	QRJ146J-100X	C RESISTOR	10 5% 1/4W	
A R 524	QRJ146J-100X	C RESISTOR	10 5% 1/4W	
A R 527	QRZ0196-R22	NET. RESISTOR	1/1W	
A R 528	QRJ125J-330	C RESISTOR	33 5% 1/2W	
A R 531	QRJ146J-102Y	C RESISTOR	1.0K 5% 1/4W	
A R 532	QRJ146J-183Y	C RESISTOR	18K 5% 1/4W	
A R 533	QRJ146J-123Y	C RESISTOR	12K 5% 1/4W	
A R 541	QRJ146J-471Y	C RESISTOR	470 5% 1/4W	
A R 542	QRJ146J-361Y	C RESISTOR	360 5% 1/4W	
A R 543	QRJ146J-181Y	C RESISTOR	180 5% 1/4W	
A R 544	QRJ146J-181Y	C RESISTOR	180 5% 1/4W	
A R 545	QRJ146J-181Y	C RESISTOR	180 5% 1/4W	
A R 546	QRJ146J-181Y	C RESISTOR	180 5% 1/4W	
A R 547	QRL022J-100	UNF. OMF. RES	10 5% 1/2W	
A R 548	QRJ146J-104Y	C RESISTOR	100K 5% 1/4W	
A R 549	QRJ146J-102Y	C RESISTOR	1.0K 5% 1/4W	B,E,EN
A R 549	QRJ146J-501Y	C RESISTOR	300 5% 1/4W	C,J,U,U,Y
A R 550	QRJ146J-104Y	C RESISTOR	100K 5% 1/4W	
A R 562	QRJ146J-471Y	C RESISTOR	470 5% 1/4W	
A R 567	QRJ146J-361Y	C RESISTOR	360 5% 1/4W	
A R 571	QRJ146J-100X	C RESISTOR	10 5% 1/4W	
A R 572	QRJ146J-100X	C RESISTOR	10 5% 1/4W	
A R 576	QRJ146J-102Y	C RESISTOR	1.0K 5% 1/4W	B,E,EN
A R 576	QRJ146J-501Y	C RESISTOR	300 5% 1/4W	C,J,U,U,Y
A R 577	QRZ0196-R22	C RESISTOR	1/1W	
A R 581	QRJ125J-330	C RESISTOR	33 5% 1/2W	
A R 582	QRL022J-100	C RESISTOR	10 5% 1/2W	
A R 585	QRJ146J-181Y	C RESISTOR	180 5% 1/4W	
A R 586	QRJ146J-181Y	C RESISTOR	180 5% 1/4W	
A R 587	QRJ146J-181Y	C RESISTOR	180 5% 1/4W	
A R 588	QRJ146J-181Y	C RESISTOR	180 5% 1/4W	
A R 591	QRJ146J-102Y	C RESISTOR	1.0K 5% 1/4W	
A R 592	QRJ146J-183Y	C RESISTOR	18K 5% 1/4W	
A R 593	QRJ146J-473Y	C RESISTOR	47K 5% 1/4W	
A R 594	QRJ146J-104Y	C RESISTOR	100K 5% 1/4W	
A R 743	QRJ146J-471Y	C RESISTOR	470 5% 1/4W	
A R 744	QRJ146J-471Y	C RESISTOR	470 5% 1/4W	
A R 745	QRJ146J-361Y	C RESISTOR	360 5% 1/4W	
A R 746	QRJ146J-361Y	C RESISTOR	360 5% 1/4W	
A R 747	QRJ146J-471Y	C RESISTOR	470 5% 1/4W	
A R 748	QRJ146J-471Y	C RESISTOR	470 5% 1/4W	
A R 751	QRJ146J-100X	C RESISTOR	10 5% 1/4W	
A R 752	QRJ146J-100X	C RESISTOR	10 5% 1/4W	

■ Audio/Video Input P.C.B

BLOCK NO. 03

REF.	PARTS NO.	PARTS NAME	REMARKS	SUFFIX
C 181	QFLC1HJ-562Z	M CAPACITOR	5600PF 5% 50V	
C 182	QFLC1HJ-562Z	M CAPACITOR	5600PF 5% 50V	
C 201	QCBB1HK-331Y	C CAPACITOR	330PF 10% 50V	
C 202	QCBB1HK-331Y	C CAPACITOR	330PF 10% 50V	
C 203	QCBB1HK-331Y	C CAPACITOR	330PF 10% 50V	
C 204	QCBB1HK-331Y	C CAPACITOR	330PF 10% 50V	
C 205	QCBB1HK-331Y	C CAPACITOR	330PF 10% 50V	
C 206	QCBB1HK-331Y	C CAPACITOR	330PF 10% 50V	
C 211	QETNOJM-108Z	E CAPACITOR	1000MF 20% 6.3V	C,J,U,UY
C 212	QET41HM-475	E CAPACITOR	4.7MF 20% 50V	C,J,U,UY
C 213	QET41HM-475	E CAPACITOR	4.7MF 20% 50V	C,J,U,UY
C 214	QETNOJM-108Z	E CAPACITOR	1000MF 20% 6.3V	C,J,U,UY
C 215	QVVB1EZ-223Y	E CAPACITOR	22MF 20% 25V	C,J,U,UY
C 216	QETNICM-108Z	E CAPACITOR	1000MF 20% 16V	C,J,U,UY
C 217	QCS11HJ-470	C CAPACITOR	47PF 5% 50V	C,J,U,UY
C 218	QCS11HJ-470	C CAPACITOR	47PF 5% 50V	C,J,U,UY
C 219	QETN1HM-104Z	E CAPACITOR	10MF 20% 50V	C,J,U,UY
C 261	QET41EM-476	E CAPACITOR	4.7MF 20% 25V	C,J,U,UY
C 300	QDVB1EZ-223Y	E CAPACITOR	22MF 20% 50V	C,J,U,UY
C 301	QET41HM-475	E CAPACITOR	4.7MF 20% 50V	C,J,U,UY
C 302	QET41HM-475	E CAPACITOR	4.7MF 20% 50V	C,J,U,UY
C 303	QCBB1HK-101Y	C CAPACITOR	100PF 10% 50V	
C 304	QCBB1HK-101Y	C CAPACITOR	100PF 10% 50V	
C 305	QFN41HJ-182	M CAPACITOR	1800PF 5% 50V	
C 306	QFN41HJ-182	M CAPACITOR	1800PF 5% 50V	
C 307	QFN41HJ-68Z	M CAPACITOR	6800PF 5% 50V	
C 308	QFN41HJ-68Z	M CAPACITOR	6800PF 5% 50V	
C 309	QCS11HJ-101	C CAPACITOR	100PF 5% 50V	
C 310	QCS11HJ-101	C CAPACITOR	100PF 5% 50V	
C 311	QET41HM-475	E CAPACITOR	4.7MF 20% 50V	
C 312	QET41HM-475	E CAPACITOR	4.7MF 20% 50V	
C 313	QET41AM-107	E CAPACITOR	100MF 20% 10V	
C 314	QET41AM-107	E CAPACITOR	100MF 20% 10V	
C 315	QET41CM-476	E CAPACITOR	47MF 20% 16V	
C 316	QET41CM-476	E CAPACITOR	47MF 20% 16V	
C 321	QDVB1EZ-223Y	C CAPACITOR	220PF 10% 50V	
C 322	QDVB1EZ-223Y	C CAPACITOR	220PF 10% 50V	
C 323	QCBB1HK-331Y	C CAPACITOR	330PF 10% 50V	
C 324	QCBB1HK-331Y	C CAPACITOR	330PF 10% 50V	
C 325	QCBB1HK-331Y	C CAPACITOR	330PF 10% 50V	
C 326	QCBB1HK-331Y	C CAPACITOR	330PF 10% 50V	
C 327	QCBB1HK-331Y	C CAPACITOR	330PF 10% 50V	
C 328	QCBB1HK-331Y	C CAPACITOR	330PF 10% 50V	
C 329	QCBB1HK-331Y	C CAPACITOR	330PF 10% 50V	
C 330	QCBB1HK-331Y	C CAPACITOR	330PF 10% 50V	
C 331	QCBB1HK-331Y	C CAPACITOR	330PF 10% 50V	
C 332	QCBB1HK-331Y	C CAPACITOR	330PF 10% 50V	
C 333	QCBB1HK-331Y	C CAPACITOR	330PF 10% 50V	
C 334	QCBB1HK-331Y	C CAPACITOR	330PF 10% 50V	
C 335	QCBB1HK-331Y	C CAPACITOR	330PF 10% 50V	
C 336	QCBB1HK-331Y	C CAPACITOR	330PF 10% 50V	
C 337	QCBB1HK-331Y	C CAPACITOR	330PF 10% 50V	
C 338	QCBB1HK-331Y	C CAPACITOR	330PF 10% 50V	
C 339	QCBB1HK-221Y	C CAPACITOR	220PF 10% 50V	
C 340	QCBB1HK-221Y	C CAPACITOR	220PF 10% 50V	
C 341	QET41HM-475	E CAPACITOR	4.7MF 20% 50V	

BLOCK NO. 02

REF.	PARTS NO.	PARTS NAME	REMARKS	SUFFIX
R 906	GRE141J-475Y	C RESISTOR	47K 5% 1/4W	
R 909	GRE141J-104Y	C RESISTOR	100K 5% 1/4W	
R 910	GRE141J-823Y	C RESISTOR	82K 5% 1/4W	
R 911	GRE141J-103Y	C RESISTOR	10K 5% 1/4W	
R 915	GRE141J-103Y	C RESISTOR	10K 5% 1/4W	
R 916	GRE141J-104Y	C RESISTOR	10K 5% 1/4W	
R 917	GRE141J-103Y	C RESISTOR	10K 5% 1/4W	
R 918	GRE141J-104Y	C RESISTOR	100K 5% 1/4W	
R 921	GRJ146J-101X	C RESISTOR	100 5% 1/4W	J
R 921	GRJ146J-220X	C RESISTOR	22 5% 1/4W	C,U,UY
R 921	GRJ146J-220X	C RESISTOR	22 5% 1/4W	B,E,EN
R 931	GRZ9006-4R7X	M CAPACITOR	4.7 1/0W	B,E,EN
R 932	GRZ9006-4R7X	M CAPACITOR	4.7 1/0W	B,E,EN
R 933	GRZ9006-4R7X	M CAPACITOR	4.7 1/0W	B,E,EN
R 934	GRZ9006-4R7X	M CAPACITOR	4.7 1/0W	B,E,EN
R 951	GRJ146J-220X	C RESISTOR	22 5% 1/4W	C,U,UY
R 951	GRJ146J-220X	C RESISTOR	22 5% 1/4W	B,E,EN
R 951	GRJ146J-101X	C RESISTOR	100 5% 1/4W	J
R 952	GRJ146J-101X	C RESISTOR	100 5% 1/4W	J
R 952	GRJ146J-220X	C RESISTOR	22 5% 1/4W	B,E,EN
R 952	GRJ146J-220X	C RESISTOR	22 5% 1/4W	C,U,UY
R 961	ORL022J-471	UNF OMF.RES.	470 5% 1/2W	
R 962	ORL022J-471	UNF OMF.RES.	470 5% 1/2W	
R 971	GRZ9006-4R7X	F RESISTOR	4.7 1/0W	B,E,EN
R 981	GRZ9006-4R7X	F RESISTOR	4.7 1/0W	B,E,EN
R 982	GRZ9006-4R7X	F RESISTOR	4.7 1/0W	B,E,EN
RY801	OSK0035-001	RELAY		B,E,EN,U,UY
RY860	OSK0082-001	RELAY		B,E,EN
RY921	OSK0037-001	RELAY		C,U,UY
RY921	OSK0037-001	RELAY		C,U,UY
RY951	OSK0095-001	RELAY		J
RY951	OSK0095-001	RELAY		J
RY951	OSK0037-001	RELAY		B,E,EN
RY951	OSK0037-001	RELAY		C,U,UY
RY952	OSK0037-001	RELAY		B,E,EN
RY952	OSK0037-001	RELAY		C,U,UY
S 901	OSW0653-001	PUSH SWITCH		J
ST901	ANB0007-001	SPK TERMINAL		
ST951	ANB0016-001	SPK TERMINAL		
T 801	ETP1000-41EA	POWER TRANSF.		B,E,EN
T 801	ETP1000-41ZB	POWER TRANSF.		C,U,UY
T 801	ETP1000-41JA	POWER TRANSF.		C,J
TA801	GNZ0079-001Z	TAB I.M		
TA802	GNZ0079-001Z	TAB I.M		
TH340	GAD0012-20Z	THERMISTOR		
TH568	GAD0012-20Z	THERMISTOR		
TH749	GAD0012-20Z	THERMISTOR		
TH750	GAD0012-20Z	THERMISTOR		
TP001	GMV5005-004K	4P PLUG ASSY		
VR741	QVP0004-102Z	V.RES. I.M		
VR742	QVP0004-102Z	V.RES. I.M		
VS801	OSW0524-001	LEVER SWITCH		U,UY

BLOCK NO. 03

Δ REF.	PARTS NO.	PARTS NAME	REMARKS	SUFFIX
CN603	QGB2510K1-07	CONNECTOR		
CN604	QGB2510K1-07	CONNECTOR		
CN608	QGB2510K1-04	CONNECTOR		
CN609	QJF001-03360H	SKT WIRE		
CN611	QGB2510J1-08	CONNECTOR		
CN612	QGB2510J1-09	CONNECTOR		
CN613	QGB2510J1-07	CONNECTOR		
CN614	QGB2510J1-07	CONNECTOR		
CN615	QGB2510J1-06	CONNECTOR		
CN616	QGB2510J1-04	CONNECTOR		
CN618	QGB2510J1-04	CONNECTOR		
CN619	QGA2001C1-03	3P PLUG ASSY		
CN702	QJF002-06360H	SOCKET WIRE ASS		
C1001	QET41HM-475	E CAPACITOR	4.7MF 20% 50V	
C1002	QET41HM-475	E CAPACITOR	4.7MF 20% 50V	
C1003	QET41HM-475	E CAPACITOR	4.7MF 20% 50V	
C1004	QET41HM-475	E CAPACITOR	4.7MF 20% 50V	
C1005	QFVJ1HJ-684Z	M.M.CAPACITOR	.68MF 5% 50V	
C1006	QFVJ1HJ-684Z	M.M.CAPACITOR	.68MF 5% 50V	
C1007	QFLC1HJ-223Z	M CAPACITOR	.022MF 5% 50V	
C1008	QFLC1HJ-223Z	M CAPACITOR	.022MF 5% 50V	
C1011	QDVB1EZ-223Y	C CAPACITOR		
C1012	QDVB1EZ-223Y	C CAPACITOR		
C1013	QGBB1HK-101Y	C CAPACITOR	100PF 10% 50V	
C1014	QGBB1HK-101Y	C CAPACITOR	100PF 10% 50V	
C1031	QET41HM-475	E CAPACITOR	4.7MF 20% 50V	
C1032	QET41HM-475	E CAPACITOR	4.7MF 20% 50V	
C1033	QET41HM-475	E CAPACITOR	4.7MF 20% 50V	
C1034	QET41HM-475	E CAPACITOR	4.7MF 20% 50V	
C1035	QET41HM-475	E CAPACITOR	4.7MF 20% 50V	
C1036	QET41HM-475	E CAPACITOR	4.7MF 20% 50V	
C1038	QET41HM-475	E CAPACITOR	4.7MF 20% 50V	
C1031	QET41HM-475	E CAPACITOR	4.7MF 20% 50V	
C1032	QET41HM-475	E CAPACITOR	4.7MF 20% 50V	
C1033	QET41HM-475	E CAPACITOR	4.7MF 20% 50V	
C1034	QET41HM-475	E CAPACITOR	4.7MF 20% 50V	
C1035	QET41HM-475	E CAPACITOR	4.7MF 20% 50V	
C1036	QET41HM-475	E CAPACITOR	4.7MF 20% 50V	
C1055	QET41HM-475	E CAPACITOR	4.7MF 20% 50V	
C1056	QET41HM-475	E CAPACITOR	4.7MF 20% 50V	
C1057	QET41AM-107	E CAPACITOR	100MF 20% 10V	B,E,EN
C1500	QDVB1EZ-223Y	C CAPACITOR		C,J,U,UY
C1501	QGBB1HK-471Y	C CAPACITOR	470PF 10% 50V	
C1502	QCS11HJ-271	C CAPACITOR	10MF 20% 50V	
C1503	QCS31HJ-331Z	C CAPACITOR	270PF 5% 50V	
C1503	QCS11HJ-101	C CAPACITOR	330PF 5% 50V	B,E,EN
C1504	QGB31HK-132Z	C CAPACITOR	100PF 5% 50V	C,J,U,UY
C1507	QCS31HJ-220Z	C CAPACITOR	1500PF 10% 50V	
C1507	QCS31HJ-100Z	C CAPACITOR	22PF 5% 50V	
C1508	QHR1VM-476Z	E CAPACITOR	10PF 5% 50V	B,E,EN
C1511	QHR1VM-225Z	E CAPACITOR	47MF 20% 35V	
C1512	QFN41HJ-103	M CAPACITOR	2.2MF 20% 50V	
C1513	QCS32HJ-330Z	C CAPACITOR	.010MF 5% 50V	
C1514	QHR1VM-476Z	E CAPACITOR	33PF 5% 500V	
C1517	QHR2AM-106Z	E CAPACITOR	47MF 20% 50V	
C1521	QCS32HJ-470Z	C CAPACITOR	10MF 20% 100V	
C1521	QCS32HJ-470Z	C CAPACITOR	47PF 5% 500V	

BLOCK NO. 03

Δ REF.	PARTS NO.	PARTS NAME	REMARKS	SUFFIX
C 342	QET41HM-475	E CAPACITOR	4.7MF 20% 50V	
C 343	QET41HM-475	E CAPACITOR	4.7MF 20% 50V	
C 344	QET41HM-475	E CAPACITOR	4.7MF 20% 50V	
C 345	QDVB1EZ-223Y	C CAPACITOR		
C 346	QDVB1EZ-223Y	C CAPACITOR		
C 347	QGBB1HK-221Y	C CAPACITOR	220PF 10% 50V	
C 348	QGBB1HK-221Y	C CAPACITOR	220PF 10% 50V	
C 351	QET41HM-105	E CAPACITOR	1.0MF 20% 50V	
C 352	QET41HM-105	E CAPACITOR	1.0MF 20% 50V	
C 353	QDVB1EZ-223Y	C CAPACITOR		
C 354	QDVB1EZ-223Y	C CAPACITOR		
C 355	QET41HM-105	E CAPACITOR	1.0MF 20% 50V	
C 356	QET41HM-105	E CAPACITOR	1.0MF 20% 50V	
C 357	QDVB1EZ-223Y	C CAPACITOR		
C 358	QDVB1EZ-223Y	C CAPACITOR		
C 359	QDVB1EZ-223Y	C CAPACITOR		
C 360	QDVB1EZ-223Y	C CAPACITOR		
C 361	QET41HM-475	E CAPACITOR	4.7MF 20% 50V	
C 362	QETN1EM-226Z	E CAPACITOR	22MF 20% 25V	
C 363	QETN1EM-226Z	E CAPACITOR	22MF 20% 25V	
C 364	QET41HM-475	E CAPACITOR	4.7MF 20% 50V	
C 365	QETN1HM-225Z	E CAPACITOR	2.2MF 20% 50V	
C 366	QETN1HM-225Z	E CAPACITOR	2.2MF 20% 50V	
C 367	QGBB1HK-221Y	C CAPACITOR	220PF 10% 50V	
C 371	QGB31HK-822Z	C CAPACITOR	8200PF 10% 50V	
C 372	QGB31HK-822Z	C CAPACITOR	8200PF 10% 50V	
C 373	QFLC1HJ-153Z	M CAPACITOR	.015MF 5% 50V	
C 374	QFLC1HJ-153Z	M CAPACITOR	.015MF 5% 50V	
C 375	QFV1HJ-334Z	TF CAPACITOR	.33MF 5% 50V	
C 376	QFV1HJ-334Z	TF CAPACITOR	.33MF 5% 50V	
C 377	QDVB1EZ-223Y	C CAPACITOR		
C 378	QDVB1EZ-223Y	C CAPACITOR		
C 379	QET41HM-475	E CAPACITOR	4.7MF 20% 50V	
C 380	QET41HM-475	E CAPACITOR	4.7MF 20% 50V	
C 381	QET41EM-476	E CAPACITOR	47MF 20% 25V	
C 382	QET41EM-476	E CAPACITOR	47MF 20% 25V	
C 383	QCF31HZ-223Z	C CAPACITOR	.022MF +80--20%	
C 384	QET41EM-107	E CAPACITOR	100MF 20% 25V	
C 385	QDVB1EZ-223Y	C CAPACITOR		
C 387	QDVB1EZ-223Y	C CAPACITOR		
C 388	QDVB1EZ-223Y	C CAPACITOR		
C 389	QDVB1EZ-223Y	C CAPACITOR		
C 390	QDVB1EZ-223Y	C CAPACITOR		
C 391	QGBB1HK-471Y	C CAPACITOR	470PF 10% 50V	
C 392	QFV41HJ-104	TF CAPACITOR	.10MF 5% 50V	
C 393	QETN0JM-477Z	E CAPACITOR	470MF 20% 6.3V	
CN121	QGB2501J1-12	CONNECTOR		
CN122	QGB2501J1-04	CONN. TERMINAL		B,E,EN
CN301	QGB2510K1-15	CONNECTOR		
CN311	QGB2510J1-15	CONNECTOR		
CN314	QGF1205C1-29	CONNECTOR		
CN414	QGA2001C1-04	4P PULG ASS'Y		B,E,EN
CN501	QJF001-091304	WIRE ASSY		
CN502	QJF001-03400H	SKT WIRE ASSY		
CN512	QGA2001C1-03	3P PLUG ASSY		

BLOCK NO. 03

REF.	PARTS NO.	PARTS NAME	REMARKS	SUFFIX
Q 363	2SK3017QR/-T	FEY		
Q 364	2SK3017QR/-T	FEY		
Q 365	2SD2144S/VW/-T	TRANSISTOR		
Q 366	2SD2144S/VW/-T	TRANSISTOR		
Q 367	2SD2144S/VW/-T	TRANSISTOR		
Q 368	2SD2144S/VW/-T	TRANSISTOR		
Q 369	2SD2144S/VW/-T	TRANSISTOR		
Q 370	2SD2144S/VW/-T	TRANSISTOR		
Q 371	DTA144ESA-T	D-TRANSISTOR		
Q 372	DTA144ESA-T	D-TRANSISTOR		
Q 373	DTA144ESA-T	D-TRANSISTOR		
Q 374	DTA144ESA-T	D-TRANSISTOR		
Q 376	2SD2144S/VW/-T	TRANSISTOR		
Q 381	2SA9650Y/-T	TRANSISTOR		
Q 382	2SC2060/QR/-T	TRANSISTOR		
Q 383	2SC2060/QR/-T	TRANSISTOR		
Q1501	2SC2240/L/-T	TRANSISTOR		
Q1502	2SC2240/L/-T	TRANSISTOR		
Q1503	2SA10388/SE/-T	TRANSISTOR		
Q1509	2SA10388/SE/-T	TRANSISTOR		
Q1511	2SC2389S/SE/-T	TRANSISTOR		
Q1512	2SA10388/SE/-T	TRANSISTOR		
Q1540	2SD637/QR/	TRANSISTOR		
R 163	QR141J-472Y	C RESISTOR	4.7K 5% 1/4W	
R 164	QR141J-472Y	C RESISTOR	4.7K 5% 1/4W	
R 201	QR141J-471Y	C RESISTOR	470 5% 1/4W	
R 202	QR141J-471Y	C RESISTOR	470 5% 1/4W	
R 203	QR141J-471Y	C RESISTOR	470 5% 1/4W	
R 204	QR141J-471Y	C RESISTOR	470 5% 1/4W	
R 205	QR141J-471Y	C RESISTOR	470 5% 1/4W	
R 206	QR141J-471Y	C RESISTOR	470 5% 1/4W	
R 211	QR141J-750Y	C RESISTOR	75 5% 1/4W	C/J/U/UY
R 212	QR141J-473Y	C RESISTOR	47K 5% 1/4W	C/J/U/UY
R 213	QR141J-331Y	C RESISTOR	330 5% 1/4W	C/J/U/UY
R 214	QR141J-750Y	C RESISTOR	75 5% 1/4W	C/J/U/UY
R 215	QR141J-331Y	C RESISTOR	330 5% 1/4W	C/J/U/UY
R 216	QR141J-750Y	C RESISTOR	75 5% 1/4W	C/J/U/UY
R 217	QR141J-750Y	C RESISTOR	75 5% 1/4W	C/J/U/UY
R 218	QR141J-473Y	C RESISTOR	47K 5% 1/4W	C/J/U/UY
R 221	QR141J-151Y	C RESISTOR	150 5% 1/4W	C/J/U/UY
R 222	QR141J-151Y	C RESISTOR	150 5% 1/4W	C/J/U/UY
R 223	QR141J-151Y	C RESISTOR	150 5% 1/4W	C/J/U/UY
R 224	QR141J-152Y	C RESISTOR	1.5K 5% 1/4W	C/J/U/UY
R 225	QR141J-151Y	C RESISTOR	150 5% 1/4W	C/J/U/UY
R 227	QR141J-152Y	C RESISTOR	1.5K 5% 1/4W	C/J/U/UY
R 271	QR146J-688X	UNF C RESISTOR	6.8 5% 1/4W	C/J/U/UY
R 301	QR141J-222Y	C RESISTOR	2.2K 5% 1/4W	
R 302	QR141J-222Y	C RESISTOR	2.2K 5% 1/4W	
R 303	QR141J-473Y	C RESISTOR	47K 5% 1/4W	
R 304	QR141J-473Y	C RESISTOR	47K 5% 1/4W	
R 305	QR141J-561Y	C RESISTOR	560 5% 1/4W	
R 306	QR141J-561Y	C RESISTOR	560 5% 1/4W	
R 307	QR141J-393Y	C RESISTOR	39K 5% 1/4W	
R 308	QR141J-393Y	C RESISTOR	39K 5% 1/4W	
R 309	QR141J-474Y	C RESISTOR	470K 5% 1/4W	

BLOCK NO. 03

REF.	PARTS NO.	PARTS NAME	REMARKS	SUFFIX
C1522	QC332HJ-470Z	C CAPACITOR	47PF 5% 500V	
C1543	QFN41HJ-473	M CAPACITOR	.047MF 5% 50V	
C1544	QFN41HJ-473	M CAPACITOR	.047MF 5% 50V	
D 301	MTJ7.5C-T2	ZENER DIODE		
D 302	MTJ7.5C-T2	ZENER DIODE		
D 303	MTJ10C-T2	ZENER DIODE		
D 304	1SS133-T2	DIODE		
D 305	1SS133-T2	DIODE		
D1503	1SS133-T2	DIODE		
D1511	1SS133-T2	DIODE		
D1512	1SS133-T2	DIODE		
D1531	1SS133-T2	DIODE		
EP201	E409182-001SM	GRAND TERMINAL		C/J/U/UY
FL141	QR0590-001	FILTER		
FL142	QR0590-001	FILTER		
HL341	VYH7237-003	IC HOLDER		
IC201	NJM2246D	IC		C/J/U/UY
IC301	NJM4580DD	IC		
IC311	BA15218N	IC		
IC312	BA15218N	IC		
IC313	BA15218N	IC		
IC321	TC9164AN	IC		
IC322	TC9162AN	IC		
IC323	BU4066BC	IC		
IC331	BA15218	IC		
IC332	BA15218	IC		
IC333	BA15218	IC		
IC341	M62446FP	IC		
IC351	BA15218N	IC		
IC352	BA15218N	IC		
J 211	QNN0180-001	PIN JACK		
J 212	QNN0059-001	PIN JACK	(VCR REC)	C/J/U/UY
J 213	QNN0059-001	PIN JACK	(VCR PLAY)	C/J/U/UY
J 214	QNN0059-001	PIN JACK	(DVD)	C/J/U/UY
J 215	QNN0059-001	PIN JACK	(M.OUT)	C/J/U/UY
J 301	QNN0163-001	PIN JACK		
J 302	QNN0163-001	PIN JACK		
J 303	QNN0163-001	PIN JACK		
J 311	QNN0017-001	PIN JACK		
K1004	QR0601-001Z	F. BEADS I.M		C/J/U/UY
K1002	QR0601-001Z	F. BEADS I.M		C/J/U/UY
L1501	QBL27005-R45	INDUCTOR		
Q 201	2SC458/CD/-T	TRANSISTOR		C/J/U/UY
Q 203	DTC143ESA-T	TRANSISTOR		C/J/U/UY
Q 216	2SC458/CD/-T	TRANSISTOR		C/J/U/UY
Q 217	2SA933S/RS/-T	TRANSISTOR		C/J/U/UY
Q 218	2SA933S/RS/-T	TRANSISTOR		C/J/U/UY
Q 341	2SD2144S/VW/-T	TRANSISTOR		
Q 342	2SD2144S/VW/-T	TRANSISTOR		
Q 331	DTA144ESA-T	D-TRANSISTOR		
Q 332	DTA144ESA-T	D-TRANSISTOR		
Q 333	DTA144ESA-T	D-TRANSISTOR		
Q 334	DTA144ESA-T	D-TRANSISTOR		
Q 361	2SK3017QR/-T	FEY		
Q 362	2SK3017QR/-T	FEY		

BLOCK NO. 03

REF.	PARTS NO.	PARTS NAME	REMARKS	SUFFIX
R 382	GRE141J-363Y	C RESISTOR	36K 5% 1/4W	
R 383	GRE141J-103Y	C RESISTOR	10K 5% 1/4W	
R 384	GRE141J-103Y	C RESISTOR	10K 5% 1/4W	
R 385	GRE141J-104Y	C RESISTOR	100K 5% 1/4W	
R 386	GRE141J-104Y	C RESISTOR	100K 5% 1/4W	
R 391	GRJ146J-220X	C RESISTOR	22 5% 1/4W	
R 392	GRE141J-102Y	C RESISTOR	1.0K 5% 1/4W	
R 393	GRE141J-472Y	C RESISTOR	4.7K 5% 1/4W	
R 394	GRE141J-472Y	C RESISTOR	4.7K 5% 1/4W	
R 395	GRJ146J-8R2X	UF RESISTOR	8.2 5% 1/4W	
R1001	GRE141J-103Y	C RESISTOR	10K 5% 1/4W	
R1002	GRE141J-103Y	C RESISTOR	10K 5% 1/4W	
R1003	GRE141J-154Y	C RESISTOR	150K 5% 1/4W	
R1004	GRE141J-154Y	C RESISTOR	150K 5% 1/4W	
R1005	GRE141J-102Y	C RESISTOR	1.0K 5% 1/4W	
R1006	GRE141J-102Y	C RESISTOR	1.0K 5% 1/4W	
R1007	GRE141J-103Y	C RESISTOR	10K 5% 1/4W	
R1008	GRE141J-103Y	C RESISTOR	10K 5% 1/4W	
R1009	GRE141J-103Y	C RESISTOR	10K 5% 1/4W	
R1010	GRE141J-103Y	C RESISTOR	10K 5% 1/4W	
R1011	GRE141J-103Y	C RESISTOR	10K 5% 1/4W	
R1012	GRE141J-103Y	C RESISTOR	10K 5% 1/4W	
R1013	GRE141J-103Y	C RESISTOR	10K 5% 1/4W	
R1014	GRE141J-103Y	C RESISTOR	10K 5% 1/4W	
R1015	GRE141J-272Y	C RESISTOR	2.7K 5% 1/4W	
R1016	GRE141J-272Y	C RESISTOR	2.7K 5% 1/4W	
R1017	GRE141J-472Y	C RESISTOR	4.7K 5% 1/4W	
R1018	GRE141J-472Y	C RESISTOR	4.7K 5% 1/4W	
R1019	GRE141J-513Y	C RESISTOR	51K 5% 1/4W	
R1020	GRE141J-513Y	C RESISTOR	51K 5% 1/4W	
A R1021	GRZ9005-680X	F RESISTOR	68 1/0W	
A R1022	GRZ9005-680X	F RESISTOR	68 1/0W	
R1023	GRE141J-102Y	C RESISTOR	1.0K 5% 1/4W	
R1024	GRE141J-103Y	C RESISTOR	10K 5% 1/4W	
R1025	GRE141J-103Y	C RESISTOR	10K 5% 1/4W	
R1031	GRE141J-104Y	C RESISTOR	100K 5% 1/4W	
R1032	GRE141J-104Y	C RESISTOR	100K 5% 1/4W	
R1033	GRE141J-104Y	C RESISTOR	100K 5% 1/4W	
R1034	GRE141J-104Y	C RESISTOR	100K 5% 1/4W	
R1035	GRE141J-104Y	C RESISTOR	100K 5% 1/4W	
R1036	GRE141J-104Y	C RESISTOR	100K 5% 1/4W	
R1037	GRE141J-102Y	C RESISTOR	1.0K 5% 1/4W	
R1038	GRE141J-102Y	C RESISTOR	1.0K 5% 1/4W	
R1039	GRE141J-103Y	C RESISTOR	10K 5% 1/4W	
R1040	GRE141J-103Y	C RESISTOR	10K 5% 1/4W	
R1041	GRE141J-103Y	C RESISTOR	10K 5% 1/4W	
R1042	GRE141J-272Y	C RESISTOR	27K 5% 1/4W	
R1044	GRE141J-102Y	C RESISTOR	1.0K 5% 1/4W	
R1045	GRE141J-102Y	C RESISTOR	1.0K 5% 1/4W	
R1046	GRE141J-104Y	C RESISTOR	100K 5% 1/4W	
A R1049	GRZ9005-680X	F RESISTOR	68 1/0W	
A R1050	GRZ9005-680X	F RESISTOR	68 1/0W	
R1051	GRE141J-104Y	C RESISTOR	100K 5% 1/4W	
R1052	GRE141J-104Y	C RESISTOR	100K 5% 1/4W	
R1053	GRE141J-104Y	C RESISTOR	100K 5% 1/4W	

BLOCK NO. 03

REF.	PARTS NO.	PARTS NAME	REMARKS	SUFFIX
R 310	GRE141J-474Y	C RESISTOR	470K 5% 1/4W	
R 311	GRE141J-104Y	C RESISTOR	100K 5% 1/4W	
R 312	GRE141J-104Y	C RESISTOR	100K 5% 1/4W	
R 313	GRJ146J-391X	C RESISTOR	390 5% 1/4W	
A R 314	GRJ146J-391X	C RESISTOR	390 5% 1/4W	
R 321	GRE141J-271Y	C RESISTOR	270 5% 1/4W	
R 322	GRE141J-271Y	C RESISTOR	270 5% 1/4W	
R 323	GRE141J-102Y	C RESISTOR	1.0K 5% 1/4W	
R 325	GRE141J-471Y	C RESISTOR	470 5% 1/4W	
R 326	GRE141J-471Y	C RESISTOR	470 5% 1/4W	
R 327	GRE141J-471Y	C RESISTOR	470 5% 1/4W	
R 328	GRE141J-471Y	C RESISTOR	470 5% 1/4W	
R 329	GRE141J-471Y	C RESISTOR	470 5% 1/4W	
R 330	GRE141J-471Y	C RESISTOR	470 5% 1/4W	
R 331	GRE141J-471Y	C RESISTOR	470 5% 1/4W	
R 332	GRE141J-471Y	C RESISTOR	470 5% 1/4W	
R 333	GRE141J-471Y	C RESISTOR	470 5% 1/4W	
R 334	GRE141J-471Y	C RESISTOR	470 5% 1/4W	
R 335	GRE141J-471Y	C RESISTOR	470 5% 1/4W	
R 336	GRE141J-471Y	C RESISTOR	470 5% 1/4W	
R 337	GRE141J-102Y	C RESISTOR	1.0K 5% 1/4W	
R 341	GRE141J-104Y	C RESISTOR	100K 5% 1/4W	
R 342	GRE141J-104Y	C RESISTOR	100K 5% 1/4W	
R 343	GRE141J-104Y	C RESISTOR	100K 5% 1/4W	
R 344	GRE141J-104Y	C RESISTOR	100K 5% 1/4W	
R 345	GRE141J-511Y	C RESISTOR	510 5% 1/4W	
R 346	GRE141J-511Y	C RESISTOR	510 5% 1/4W	
R 347	GRE141J-221Y	C RESISTOR	220 5% 1/4W	
R 348	GRE141J-221Y	C RESISTOR	220 5% 1/4W	
R 349	GRE141J-103Y	C RESISTOR	10K 5% 1/4W	
R 350	GRE141J-103Y	C RESISTOR	10K 5% 1/4W	
A R 351	GRJ146J-271X	C RESISTOR	270 5% 1/4W	
A R 352	GRJ146J-271X	C RESISTOR	270 5% 1/4W	
R 353	GRE141J-153Y	C RESISTOR	15K 5% 1/4W	
R 354	GRE141J-153Y	C RESISTOR	15K 5% 1/4W	
R 355	GRE141J-103Y	C RESISTOR	10K 5% 1/4W	
R 356	GRE141J-103Y	C RESISTOR	10K 5% 1/4W	
R 357	GRE141J-102Y	C RESISTOR	1.0K 5% 1/4W	
A R 361	GRJ146J-271X	C RESISTOR	270 5% 1/4W	
A R 362	GRJ146J-271X	C RESISTOR	270 5% 1/4W	
R 363	GRE141J-432Y	C RESISTOR	4.3K 5% 1/4W	
R 364	GRE141J-562Y	C RESISTOR	5.6K 5% 1/4W	
R 365	GRE141J-102Y	C RESISTOR	1.0K 5% 1/4W	
R 366	GRE141J-102Y	C RESISTOR	1.0K 5% 1/4W	
R 367	GRE141J-104Y	C RESISTOR	100K 5% 1/4W	
R 368	GRE141J-104Y	C RESISTOR	100K 5% 1/4W	
R 371	GRE141J-102Y	C RESISTOR	1.0K 5% 1/4W	
R 372	GRE141J-103Y	C RESISTOR	10K 5% 1/4W	
R 373	GRE141J-103Y	C RESISTOR	10K 5% 1/4W	
R 375	GRE141J-104Y	C RESISTOR	100K 5% 1/4W	
R 376	GRE141J-104Y	C RESISTOR	100K 5% 1/4W	
R 377	GRE141J-333Y	C RESISTOR	33K 5% 1/4W	
R 378	GRE141J-333Y	C RESISTOR	33K 5% 1/4W	
R 379	GRE141J-333Y	C RESISTOR	33K 5% 1/4W	
R 381	GRE141J-363Y	C RESISTOR	36K 5% 1/4W	

■ Tuner P.C.B. (Ver. J/C/U/Y)

BLOCK NO. 04

REF.	PARTS NO.	PARTS NAME	REMARKS	SUFFIX
A1101	GNB0014-001	ANT TERMINAL		
BK 1	E308963-224SM	SHIELD BKT		
C 101	NCB21HK-103X	C CAPACITOR	.010MF 10% 50V	
C 102	NCB21HK-223X	C CAPACITOR	.022MF 10% 50V	
C 105	NCB21HK-223X	C CAPACITOR	.022MF 10% 50V	
C 107	QEK41CM-226	E CAPACITOR	22MF 20% 16V	
C 111	NCB21HK-473X	C CAPACITOR	.047MF 10% 50V	
C 112	NDC21HJ-120X	C CAPACITOR		
C 121	NDC21HJ-120X	C CAPACITOR		
C 122	NDC21HJ-120X	C CAPACITOR		
C 123	NCB21HK-473X	C CAPACITOR	.047MF 10% 50V	
C 126	NCB21HJ-101X	C CAPACITOR	100PF 5% 50V	
C 128	GEN41HM-674	N.P.E. CAPACITOR	.47MF 20% 50V	
C 129	NCB21HK-102X	C CAPACITOR	1000PF 10% 50V	
C 130	QEK41CM-1072	E CAPACITOR	100MF 20% 10V	
C 133	QEK41CM-226	E CAPACITOR	22MF 20% 16V	
C 134	NCB21HK-222X	C CAPACITOR	2200PF 10% 50V	
C 135	NCB21HK-223X	C CAPACITOR	.022MF 10% 50V	
C 136	QEK41HM-105	E CAPACITOR	1.0MF 20% 50V	
C 137	NCB21HK-331X	C CAPACITOR	330PF 10% 50V	
C 139	NCB21HK-333X	C CAPACITOR	.033MF 10% 50V	C,J
C 139	NCB21HK-223X	C CAPACITOR	.022MF 10% 50V	U,Y
C 140	NCB21HK-223X	C CAPACITOR	.022MF 10% 50V	U,Y
C 140	NCB21HK-333X	C CAPACITOR	.033MF 10% 50V	C,J
C 141	NCB21HK-473X	C CAPACITOR	.047MF 10% 50V	
C 143	NCB21HK-223X	C CAPACITOR	.022MF 10% 50V	
C 144	NCB21HK-473X	C CAPACITOR	.047MF 10% 50V	
C 146	QEK41HM-105	E CAPACITOR	1.0MF 20% 50V	
C 147	QEK41HM-105	E CAPACITOR	1.0MF 20% 50V	
C 148	QEK41HM-224	E CAPACITOR	.22MF 20% 50V	
C 149	QEK41HM-105	E CAPACITOR	1.0MF 20% 50V	
C 150	QEK41CM-226	E CAPACITOR	22MF 20% 16V	
C 156	QGB21HK-102Y	C CAPACITOR		
C 157	NCB21HK-473X	C CAPACITOR	.047MF 10% 50V	
C 158	QEK41CM-226	E CAPACITOR	22MF 20% 16V	
C 161	QEK41CM-106	E CAPACITOR	10MF 20% 16V	
C 162	QEK41CM-106	E CAPACITOR	10MF 20% 16V	
C 163	NCB21HK-223X	C CAPACITOR	.022MF 10% 50V	
C 164	NCB21HK-473X	C CAPACITOR	.047MF 10% 50V	
C 168	QEK41HM-105	E CAPACITOR	1.0MF 20% 50V	
C 184	QEK41CM-1072	E CAPACITOR	100MF 20% 16V	
C 185	QEK41CM-106	E CAPACITOR	10MF 20% 16V	
C 186	QEK41CM-106	E CAPACITOR	10MF 20% 16V	
CF101	QAX0419-001Z	C FILTER		
CF102	QAX0419-001Z	C FILTER		
CF103	QAX0519-001Z	C FILTER		
D 111	QGB2501K2-12	CONNECTOR		
D 121	1SS133-T2	DIODE		
D 123	1SS133-T2	DIODE		
D 129	1SS133-T2	DIODE		
IC102	LA1838	IC		
IC121	LC72136N	IC		
Q 102	2SC535/BC/-T	TRANSISTOR		
Q 103	2SC461/BC/-T	TRANSISTOR		
Q 121	DTA124ESA-T	D. TRANSISTOR	FM+B	

BLOCK NO. 05

REF.	PARTS NO.	PARTS NAME	REMARKS	SUFFIX
R1054	GRE141J-104Y	C RESISTOR	100K 5% 1/4W	
R1055	GRE141J-104Y	C RESISTOR	100K 5% 1/4W	
R1056	GRE141J-104Y	C RESISTOR	100K 5% 1/4W	
R1057	GRE141J-102Y	C RESISTOR	1.0K 5% 1/4W	
R1058	GRE141J-102Y	C RESISTOR	1.0K 5% 1/4W	
R1059	GRE141J-103Y	C RESISTOR	10K 5% 1/4W	
R1060	GRE141J-103Y	C RESISTOR	10K 5% 1/4W	
R1061	GRE141J-102Y	C RESISTOR	1.0K 5% 1/4W	
R1062	GRE141J-104Y	C RESISTOR	100K 5% 1/4W	
R1063	GRE141J-104Y	C RESISTOR	100K 5% 1/4W	
R1064	GRE141J-104Y	C RESISTOR	100K 5% 1/4W	
R1065	GRE141J-102Y	C RESISTOR	1.0K 5% 1/4W	
A R1071	QRZ9005-100X	F RESISTOR	10 1/0W	
A R1072	QRJ146J-222X	C RESISTOR	2.2K 5% 1/4W	
A R1073	QRZ9005-100X	F RESISTOR	10 1/0W	
A R1074	QRJ146J-222X	C RESISTOR	2.2K 5% 1/4W	
A R1075	QRZ9005-100X	F RESISTOR	10 1/0W	
A R1076	QRJ146J-102X	C RESISTOR	1.0K 5% 1/4W	
A R1501	GRE141J-222Y	C RESISTOR	2.2K 5% 1/4W	
A R1502	GRE141J-563Y	C RESISTOR	56K 5% 1/4W	
A R1503	GRE141J-302Y	C RESISTOR	3.0K 5% 1/4W	
A R1504	GRE141J-183Y	C RESISTOR	18K 5% 1/4W	
A R1505	GRE141J-183Y	C RESISTOR	18K 5% 1/4W	
A R1507	GRE141J-563Y	C RESISTOR	56K 5% 1/4W	
A R1508	GRE141J-391Y	C RESISTOR	390 5% 1/4W	
A R1511	QRJ146J-331X	C RESISTOR	330 5% 1/4W	
A R1512	GRE141J-332Y	C RESISTOR	3.3K 5% 1/4W	
A R1513	GRE141J-332Y	C RESISTOR	3.3K 5% 1/4W	
A R1514	GRE141J-332Y	C RESISTOR	3.3K 5% 1/4W	
A R1515	GRE141J-332Y	C RESISTOR	3.3K 5% 1/4W	
A R1517	QRJ146J-100X	C RESISTOR	10 5% 1/4W	
A R1518	QRJ146J-100X	C RESISTOR	10 5% 1/4W	
A R1523	QRJ146J-100X	C RESISTOR	10 5% 1/4W	
A R1524	QRJ146J-100X	C RESISTOR	10 5% 1/4W	
A R1527	QRZ0196-R22	NET. RESISTOR	1/1W	
A R1528	QRJ125J-330	C RESISTOR	33 5% 1/2W	
A R1531	GRE141J-102Y	C RESISTOR	1.0K 5% 1/4W	
A R1532	GRE141J-183Y	C RESISTOR	18K 5% 1/4W	
A R1533	GRE141J-123Y	C RESISTOR	12K 5% 1/4W	
A R1541	GRE141J-471Y	C RESISTOR	470 5% 1/4W	
A R1542	GRE141J-361Y	C RESISTOR	360 5% 1/4W	
A R1543	GRE141J-181Y	C RESISTOR	180 5% 1/4W	
A R1544	GRE141J-181Y	C RESISTOR	180 5% 1/4W	
A R1545	GRE141J-181Y	C RESISTOR	180 5% 1/4W	
A R1546	GRE141J-181Y	C RESISTOR	180 5% 1/4W	
A R1547	GRLO22J-100	UNF.OMF. RES.	10 5% 1/2W	
A R1549	GRE141J-102Y	C RESISTOR	1.0K 5% 1/4W	B,E,EN
A R1549	GRE141J-301Y	C RESISTOR	300 5% 1/4W	C,J,U,Y
A TH541	QAD0012-202	THERMISTOR		

■ Tuner P.C.B. (Ver. B/E/EN)

BLOCK NO. 05

BLOCK NO. 04

▲ REF.	PARTS NO.	PARTS NAME	REMARKS	SUFFIX
AT101	QNB0014-001	ANT TERMINAL		
BK 1	E308983-224SM	SHIELD BKT		
C 101	NCB21HK-103X	C CAPACITOR	.010MF 10% 50V	
C 103	NCB21HK-223X	C CAPACITOR	.022MF 10% 50V	
C 105	NCB21HK-223X	C CAPACITOR	.022MF 10% 50V	
C 107	QEK41CM-226	E CAPACITOR	22MF 20% 16V	
C 111	NCB21HK-473X	C CAPACITOR	.047MF 10% 50V	
C 112	NDC21HJ-120X	C CAPACITOR		
C 117	NCB21HK-6ROX	C CAPACITOR	6.0PF 5% 50V	
C 118	NCB21HJ-150X	C CAPACITOR	15PF 5% 50V	
C 121	NDC21HJ-120X	C CAPACITOR		
C 122	NDC21HJ-120X	C CAPACITOR		
C 123	NCB21HK-473X	C CAPACITOR	.047MF 10% 50V	
C 126	NCB21HJ-101X	C CAPACITOR	100PF 5% 50V	
C 128	QEN41HM-474	N.P.E. CAPACITOR	.47MF 20% 50V	
C 130	NCB21HK-102X	C CAPACITOR	1000PF 10% 50V	
C 130	QK41CM-107Z	E CAPACITOR	100MF 20% 16V	
C 133	QEK41CM-226	E CAPACITOR	22MF 20% 16V	
C 134	NCB21HK-222X	C CAPACITOR	2200PF 10% 50V	
C 135	NCB21HK-223X	C CAPACITOR	.022MF 10% 50V	
C 136	QEK41HM-105	E CAPACITOR	1.0MF 20% 50V	
C 137	NCB21HJ-680X	C CAPACITOR	68PF 5% 50V	
C 139	NCB21HK-393X	C CAPACITOR	.039MF 10% 50V	
C 140	NCB21HK-393X	C CAPACITOR	.039MF 10% 50V	
C 141	NCB21HK-473X	C CAPACITOR	.047MF 10% 50V	
C 143	NCB21HK-223X	C CAPACITOR	.022MF 10% 50V	
C 144	NCB21HK-473X	C CAPACITOR	.047MF 10% 50V	
C 146	QEK41HM-105	E CAPACITOR	1.0MF 20% 50V	
C 147	QEK41HM-105	E CAPACITOR	1.0MF 20% 50V	
C 148	QEK41HM-224	E CAPACITOR	.22MF 20% 50V	
C 149	QEK41HM-105	E CAPACITOR	1.0MF 20% 50V	
C 150	QEK41CM-226	E CAPACITOR	22MF 20% 16V	
C 156	QGB1HK-102Y	C CAPACITOR		
C 157	NCB21HK-473X	C CAPACITOR	.047MF 10% 50V	
C 158	QEK41CM-226	E CAPACITOR	22MF 20% 16V	
C 161	QEK41CM-106	E CAPACITOR	10MF 20% 16V	
C 162	QEK41CM-106	E CAPACITOR	10MF 20% 16V	
C 163	NCB21HK-223X	C CAPACITOR	.022MF 10% 50V	
C 164	NCB21HK-473X	C CAPACITOR	.047MF 10% 50V	
C 168	QEK41HM-105	E CAPACITOR	1.0MF 20% 50V	
C 184	QEK41CM-107Z	E CAPACITOR	100MF 20% 16V	
C 185	QEK41CM-106	E CAPACITOR	10MF 20% 16V	
C 186	QEK41CM-106	E CAPACITOR	10MF 20% 16V	
C 191	NCB21HJ-820X	C CAPACITOR	82PF 5% 50V	
C 192	NCB21HJ-470X	C CAPACITOR	47PF 5% 50V	
C 193	NCB21HK-561X	C CAPACITOR	560PF 10% 50V	
C 194	NCB21HK-104X	C CAPACITOR	.10MF 10% 50V	
C 195	NCB21HK-331X	C CAPACITOR	330PF 10% 50V	
C 196	QEK41HM-225	E CAPACITOR	2.2MF 20% 50V	
C 197	NCB21HK-473X	C CAPACITOR	.047MF 10% 50V	
C 199	QEK41CM-106	E CAPACITOR	10MF 20% 16V	
CF101	QAX0285-001Z	C.FILTER		
CF102	QAX0285-001Z	C.FILTER		
CF103	QAX0519-001Z	C.FILTER		
CN111	QGB2501K2-12	CONNECTOR		

▲ REF.	PARTS NO.	PARTS NAME	REMARKS	SUFFIX
R 103	NRSA02J-101X	MG RESISTOR	100 5% 1/10W	
R 104	NRSA02J-272X	MG RESISTOR	2.7K 5% 1/10W	
R 105	NRSA02J-391X	MG RESISTOR	390 5% 1/10W	
R 106	NRSA02J-102X	MG RESISTOR	1.0K 5% 1/10W	
R 107	NRSA02J-561X	MG RESISTOR	560 5% 1/10W	
R 108	NRSA02J-332X	MG RESISTOR	3.3K 5% 1/10W	
R 109	NRSA02J-221X	MG RESISTOR	220 5% 1/10W	
R 115	NRSA02J-104X	MG RESISTOR	100K 5% 1/10W	
R 119	NRSA02J-103X	MG RESISTOR	10K 5% 1/10W	
R 122	NRSA02J-472X	MG RESISTOR	4.7K 5% 1/10W	
R 124	NRSA02J-222X	MG RESISTOR	2.2K 5% 1/10W	
R 126	NRSA02J-562X	MG RESISTOR	5.6K 5% 1/10W	
R 127	NRSA02J-822X	MG RESISTOR	8.2K 5% 1/10W	
R 128	NRSA02J-472X	MG RESISTOR	4.7K 5% 1/10W	
R 129	NRSA02J-222X	MG RESISTOR	2.2K 5% 1/10W	
R 130	QR29005-680X	F RESISTOR	68 1/10W	
R 132	NRSA02J-392X	MG RESISTOR	39K 5% 1/10W	
R 133	NRSA02J-392X	MG RESISTOR	3.9K 5% 1/10W	
R 134	NRSA02J-102X	MG RESISTOR	1.0K 5% 1/10W	
R 140	NRSA02J-183X	MG RESISTOR	18K 5% 1/10W	
R 141	NRSA02J-102X	MG RESISTOR	1.0K 5% 1/10W	
R 142	NRSA02J-470X	MG RESISTOR	47 5% 1/10W	
R 143	NRSA02J-562X	MG RESISTOR	5.6K 5% 1/10W	
R 144	NRSA02J-332X	MG RESISTOR	3.3K 5% 1/10W	
R 145	NRSA02J-103X	MG RESISTOR	10K 5% 1/10W	
R 146	NRSA02J-472X	MG RESISTOR	4.7K 5% 1/10W	
R 147	NRSA02J-332X	MG RESISTOR	3.3K 5% 1/10W	
R 150	NRSA02J-331X	MG RESISTOR	330 5% 1/10W	
R 157	NRSA02J-682X	MG RESISTOR	6.8K 5% 1/10W	
R 158	NRSA02J-682X	MG RESISTOR	6.8K 5% 1/10W	
R 161	NRSA02J-102X	MG RESISTOR	1.0K 5% 1/10W	
R 162	NRSA02J-102X	MG RESISTOR	1.0K 5% 1/10W	
R 182	NRSA02J-103X	MG RESISTOR	10K 5% 1/10W	
R 183	NRSA02J-103X	MG RESISTOR	10K 5% 1/10W	
R 184	NRSA02J-103X	MG RESISTOR	10K 5% 1/10W	
RF101	QAU0124-001	FRONT END		
T 111	QGR0796-001	COIL BLOCK		
T 142	QGR0973-001	IFT		
X 121	QAX0402-001	CRYSTAL		



BLOCK NO. 05

A REF.	PARTS NO.	PARTS NAME	REMARKS	SUFFIX
R 193	NRSA02J-103X	MG RESISTOR	10K 5% 1/10W	
R 194	NRSA02J-103X	MG RESISTOR	10K 5% 1/10W	
RF101	QAU0119-001	FRONT END	FOR FTZ	
T 111	QGR0871-001	COIL BLOCK		
T 142	QGR0973-001	IFT		
X 121	QAX0402-001	CRYSTAL		
X 191	QAX0263-001Z	CRYSTAL		

BLOCK NO. 05

A REF.	PARTS NO.	PARTS NAME	REMARKS	SUFFIX
CN112	QGB2501K1-04	CONNECTOR		
D 121	1S5133-T2	DIODE		
D 123	1S5133-T2	DIODE		
D 129	1S5133-T2	DIODE		
D 131	1S5133-T2	DIODE		
IC102	LA1838	IC		
IC121	LC72156N	IC		
IC191	SA6588	IC(CRDS)		
L 111	QQL231K-150Y	INDUCTOR		
Q 102	2SC535/BC/-T	TRANSISTOR		
Q 103	2SC461/BC7/-T	TRANSISTOR		
Q 111	KTC3199/GL/-T	TRANSISTOR		
Q 112	KTC3199/GL/-T	TRANSISTOR		
Q 113	DA114YKA-X	TRANSISTOR		
Q 121	DA124ESA-T	D. TRANSISTOR		
R 103	NRSA02J-101X	MG RESISTOR	100 5% 1/10W	
R 104	NRSA02J-272X	MG RESISTOR	2.7K 5% 1/10W	
R 105	NRSA02J-391X	MG RESISTOR	390 5% 1/10W	
R 106	NRSA02J-102X	MG RESISTOR	1.0K 5% 1/10W	
R 107	NRSA02J-561X	MG RESISTOR	560 5% 1/10W	
R 108	NRSA02J-332X	MG RESISTOR	3.3K 5% 1/10W	
R 109	NRSA02J-221X	MG RESISTOR	220 5% 1/10W	
R 111	NRSA02J-472X	MG RESISTOR	4.7K 5% 1/10W	
R 112	QRE141J-472Y	C RESISTOR	4.7K 5% 1/4W	
R 114	NRSA02J-122X	MG RESISTOR	1.2K 5% 1/10W	
R 115	NRSA02J-104X	MG RESISTOR	100K 5% 1/10W	
R 119	NRSA02J-103X	MG RESISTOR	10K 5% 1/10W	
R 122	NRSA02J-472X	MG RESISTOR	4.7K 5% 1/10W	
R 124	NRSA02J-222X	MG RESISTOR	2.2K 5% 1/10W	
R 126	NRSA02J-562X	MG RESISTOR	5.6K 5% 1/10W	
R 127	NRSA02J-822X	MG RESISTOR	8.2K 5% 1/10W	
R 128	NRSA02J-472X	MG RESISTOR	4.7K 5% 1/10W	
R 129	NRSA02J-222X	MG RESISTOR	2.2K 5% 1/10W	
R 130	QRZ9005-680X	F RESISTOR	68 1/0W	
R 132	NRSA02J-393X	MG RESISTOR	39K 5% 1/10W	
R 133	NRSA02J-392X	MG RESISTOR	3.9K 5% 1/10W	
R 134	NRSA02J-102X	MG RESISTOR	1.0K 5% 1/10W	
R 140	NRSA02J-563X	MG RESISTOR	56K 5% 1/10W	
R 141	NRSA02J-102X	MG RESISTOR	1.0K 5% 1/10W	
R 142	NRSA02J-470X	MG RESISTOR	47 5% 1/10W	
R 143	NRSA02J-562X	MG RESISTOR	5.6K 5% 1/10W	
R 144	NRSA02J-332X	MG RESISTOR	3.3K 5% 1/10W	
R 145	NRSA02J-103X	MG RESISTOR	10K 5% 1/10W	
R 146	NRSA02J-472X	MG RESISTOR	4.7K 5% 1/10W	
R 147	NRSA02J-332X	MG RESISTOR	3.3K 5% 1/10W	
R 150	NRSA02J-331X	MG RESISTOR	330 5% 1/10W	
R 157	NRSA02J-272X	MG RESISTOR	2.7K 5% 1/10W	
R 158	NRSA02J-272X	MG RESISTOR	2.7K 5% 1/10W	
R 161	NRSA02J-102X	MG RESISTOR	1.0K 5% 1/10W	
R 162	NRSA02J-102X	MG RESISTOR	1.0K 5% 1/10W	
R 182	NRSA02J-103X	MG RESISTOR	10K 5% 1/10W	
R 183	NRSA02J-103X	MG RESISTOR	10K 5% 1/10W	
R 184	NRSA02J-103X	MG RESISTOR	10K 5% 1/10W	
R 191	NRSA02J-102X	MG RESISTOR	1.0K 5% 1/10W	
R 192	NRSA02J-474X	MG RESISTOR	470K 5% 1/10W	

# Packing Materials and Accessories Parts List

Block No. 

M	2	M	M
---	---	---	---

Block No. 

M	3	M	M
---	---	---	---

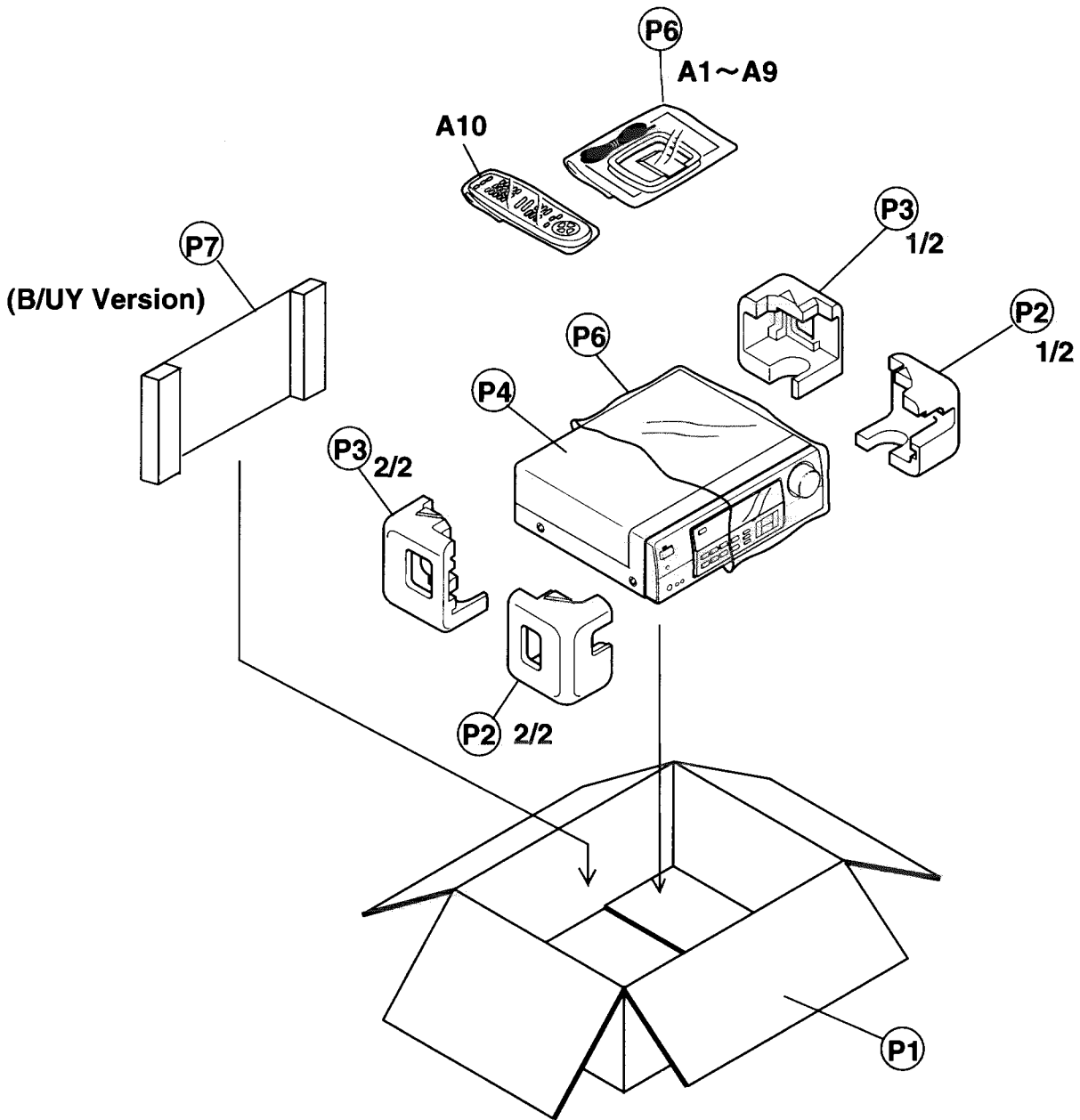

■ Packing Parts List

BLOCK NO. M2MM

△	REF.	PARTS NO.	PARTS NAME	REMARKS	QTY	SUFFIX	CLR
	P 1	LV30044-069A	PACKING CASE	RX-558VBK	1	C, J	
		LV30044-070A	PACKING CASE	RX-558VBK	1	U	
		LV30044-071A	PACKING CASE	RX-558RBK	1	E, EN	
		LV30044-088A	PACKING CASE	RX-558VBK	1	UY	
		LV30044-072A	PACKING CASE	RX-558RBK	1	B	
	P 2	LV20231-001A	PACKING PAD(F)		1		
	P 3	LV20232-001A	PACKING PAD(R)		1		
	P 4	E73660-006	SHEET		1		
	P 5	LV40363-001A	POLY BAG		1		
	P 6	QPA02503505P	POLY BAG		1		
	P 7	LV30386-001A	PACKING SHEET	RX-558VBK	1	UY	
		LV30385-002A	PACKING SHEET	RX-558RBK	1	B	

■ Accessories Parts List

BLOCK NO. M3MM

△	REF.	PARTS NO.	PARTS NAME	REMARKS	QTY	SUFFIX	CLR
	A 1	LVT0141-001A	INST/RX-558VBK	ENG	1	J	
		LVT0141-005A	INST/RX-558RBK	SWE, FIN, DAN	1	EN	
		LVT0141-006A	INST/RX-558VBK	ARA, POL	1	U, UY	
		LVT0141-005A	INST/RX-558RBK	GER, FRE, DUT	1	EN	
		LVT0141-006A	INST/RX-558VBK	ENG, SPA, CHI	1	U, UY	
		LVT0141-004A	INST/RX-558RBK	ENG, GER, FRE	1	E	
		LVT0141-004A	INST/RX-558RBK	DUT, SPA, ITA	1	E	
		LVT0141-002A	INST/RX-558VBK	ENG, FRE	1	C	
		LVT0141-003A	INST/RX-558RBK	ENG	1	B	
	A 2	BT-51020-1	SERVICE NETWORK		1	J	
		BT-20071B	SERVICE NETWORK		1	C	
	A 3	BT-20044G	SAFETY SHEET		1	J	
		E43486-340A	SAFETY SHEET		1	B	
	A 4	BT-52002-1	WARRANTY CARD		1	C	
		BT-54008-2	WARRANTY CARD		1	B, E, EN	
	A 5	VNA3000-202	REGISTER CARD		1	B	
	A 6	EWP503-001	ANT.WIRE		1		
	A 7	QAL0014-001	AM LOOP ANT		1		
	A 8	QAM0054-001	CONVERSION PLUG		1	U	
	A 9	-----	BATTERY		1		
	A 10	RM-SR558RU	REMOCON	RX-558RBK	1	B, E, EN	
		RM-SR558U	REMOCON	RX-558VBK	1	C, J	
		RM-SR558XU	REMOCON	RX-558VBK	1	U, UY	

**RX-558VBK**  
**RX-558RBK**

**JVC**

**VICTOR COMPANY OF JAPAN, LIMITED**

AUDIO DIVISION, 10-1, 1Chome, Ohwatari-machi, maebashi-city, 371-8543, Japan