

RX-774PBK  
RX-774PGD  
RX-774VBK

# JVC

## SERVICE MANUAL

### AUDIO/VIDEO CONTROL RECEIVER

# RX-774PBK RX-774PGD RX-774VBK

#### Area Suffix

UF(PBK/PGD) ..... China  
UT(PBK/VBK) ..... Taiwan  
US(PBK) ..... Singapore  
U (PBK/VBK) ..... Universal

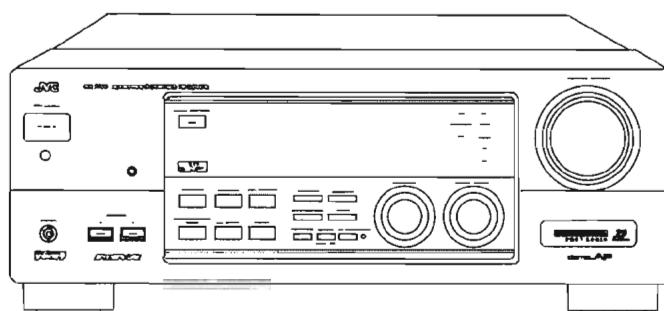

**TEXT**  
**COMPU LINK**

**COMPU LINK**  
**/// Remote ///**

**3D**  
**3D-PHONIC**

**DIGITAL AP**

**DOLBY SURROUND**  
**PRO-LOGIC**

### Contents

Safety Precautions .....	1-2	Adjustment Procedures .....	2-21
Instruction Book .....	1-3~42	Block Diagrams .....	3-1
Description of Major ICs .....	2-1	Schematic Diagrams .....	3-4
Internal Connection of Display .....	2-16	Printed Circuit Boards .....	3-13~17
Disassembly Procedures .....	2-18	Parts List .....	4-1~17

# RX-774PBK/RX-774PGD/RX-774VBK

## Safety Precautions

1. This design of this product contains special hardware and many circuits and components specially for safety purposes. For continued protection, no changes should be made to the original design unless authorized in writing by the manufacturer. Replacement parts must be identical to those used in the original circuits. Services should be performed by qualified personnel only.
2. Alterations of the design or circuitry of the product should not be made. Any design alterations of the product should not be made. Any design alterations or additions will void the manufacturer's warranty and will further relieve the manufacture of responsibility for personal injury or property damage resulting therefrom.
3. Many electrical and mechanical parts in the products have special safety-related characteristics. These characteristics are often not evident from visual inspection nor can the protection afforded by them necessarily be obtained by using replacement components rated for higher voltage, wattage, etc. Replacement parts which have these special safety characteristics are identified in the Parts List of Service Manual. Electrical components having such features are identified by shading on the schematics and by ( $\Delta$ ) on the Parts List in the Service Manual. The use of a substitute replacement which does not have the same safety characteristics as the recommended replacement parts shown in the Parts List of Service Manual may create shock, fire, or other hazards.
4. The leads in the products are routed and dressed with ties, clamps, tubings, barriers and the like to be separated from live parts, high temperature parts, moving parts and/or sharp edges for the prevention of electric shock and fire hazard. When service is required, the original lead routing and dress should be observed, and it should be confirmed that they have been returned to normal, after re-assembling.

### 5. Leakage current check (Electrical shock hazard testing)

After re-assembling the product, always perform an isolation check on the exposed metal parts of the product (antenna terminals, knobs, metal cabinet, screw heads, headphone jack, control shafts, etc.) to be sure the product is safe to operate without danger of electrical shock.

Do not use a line isolation transformer during this check.

- Plug the AC line cord directly into the AC outlet. Using a "Leakage Current Tester", measure the leakage current from each exposed metal parts of the cabinet, particularly any exposed metal part having a return path to the chassis, to a known good earth ground. Any leakage current must not exceed 0.5mA AC (r.m.s.)

#### ● Alternate check method

Plug the AC line cord directly into the AC outlet. Use an AC voltmeter having, 1,000 ohms per volt or more sensitivity in the following manner. Connect a 1,500 10W resistor paralleled by a 0.15 F AC-type capacitor between an exposed metal part and a known good earth ground.

Measure the AC voltage across the resistor with the AC voltmeter.

Move the resistor connection to each exposed metal part, particularly any exposed metal part having a return path to the chassis, and measure the AC voltage across the resistor. Now, reverse the plug in the AC outlet and repeat each measurement. voltage measured Any must not exceed 0.75 V AC (r.m.s.).

Use an AC voltmeter having, 1,000 ohms  $\Omega$

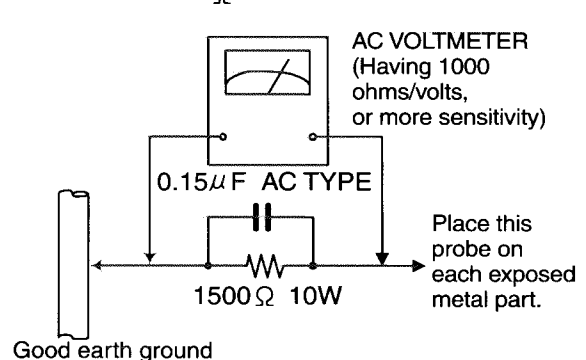

## Warning

1. This equipment has been designed and manufactured to meet international safety standards.
2. It is the legal responsibility of the repairer to ensure that these safety standards are maintained.
3. Repairs must be made in accordance with the relevant safety standards.
4. It is essential that safety critical components are replaced by approved parts.
5. If mains voltage selector is provided, check setting for local voltage.

**CAUTION** Burrs formed during molding may be left over on some parts of the chassis. Therefore, pay attention to such burrs in the case of preforming repair of this system.

# Instruction Book



# JVC

Mains (AC) Line Instruction (not applicable for Europe, U.S.A., Canada, Australia and U.K.)

Instrucción sobre la línea de la red (CA) (no aplicable para Europa, EE.UU., Canadá, Australia, ni el Reino Unido)

Instrução sobre a tensão da rede elétrica (CA) (não aplicável para a Europa, os E.U.A., o Canadá, a Austrália e o Reino Unido)

主 (AC) 電源線路說明 (不適用於歐洲、美國、加拿大、澳洲及英國型號)

تعليمات التيار الرئيسي (التردد) (لا ينطبق لأوروبا وأمريكا وكندا والمملكة المتحدة)

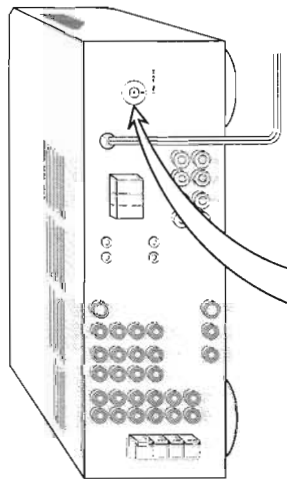

**IMPORTANT for mains (AC) line**  
BEFORE PLUGGING IN, do check that your mains (AC) line voltage corresponds with the position of the voltage selector switch provided on the outside of this equipment and, if different, reset the voltage selector switch, to prevent from a damage or risk of fire/electric shock.

**IMPORTANT: para la línea de la red (CA)**  
ANTES DE ENCHUFAR EL EQUIPO, compruebe si la tensión de la línea de la red (CA) corresponde con la posición del selector de tensión situado en la parte exterior del equipo, y si es diferente, reajuste el selector de tensión para evitar el riesgo de incendios/descargas eléctricas.

**IMPORTANTE para a ligação à tensão da rede (CA)**  
ANTES DE LIGAR O APARELHO A UMA TOMADA DA REDE, verifique se a tensão da rede CA corresponde à posição do selector de voltagem localizado na parte externa deste equipamento. Caso não corresponda, reajuste o selector de voltagem a fim de evitar avarias ou riscos de incêndio e choque eléctrico.

**有關主 (AC) 電源線路的重要事項**  
接插電源線以前，務請檢查當地的主 (AC) 電源線路電壓是否在位於本機外面的電壓選擇開關所指示的位置一致。如果不一致，即重新設定電壓選擇開關為符合當地電壓，以免損壞機器或引起火災/觸電的危險。

**هام من أجل خط التيار المتردد (AC) الرئيسي**  
قبل اربط الجهاز الكهربائي، تأكد من ان موصل خط التيار المتردد (AC) الرئيسي لديك متوافقة مع موضع مفتاح اختيار التردد الخارج هذه المعدات. و إذا اختلفت، فقم بإعادة ضبط مفتاح اختيار التردد. لتجنب التلف أو الصدمة الكهربائية وحظر الحريق.

## AUDIO/VIDEO CONTROL RECEIVER

RECEPTOR DE CONTROL DE AUDIO/VIDEO  
RECEPTOR DE COMANDO AUDIO/VIDEO  
聲/視頻控制接收機

## RX-774PBK

TEXT  
COMPU LINK

COMPU LINK  
Remote III

3D-SONIC

DIGITAL AP

DOLBY SURROUND  
PRO-LOGIC

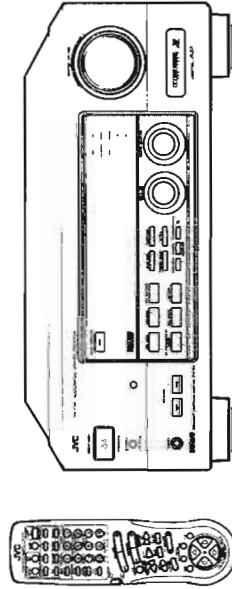

## INSTRUCTIONS

MANUAL DE INSTRUCCIONES  
INSTRUÇÕES  
使用說明書

**For Customer Use:**  
Enter below the Model No. and Serial No. which are located either on the rear, bottom or side of the cabinet. Retain this information for future reference.  
Model No.  
Serial No.

LVT0014-001A  
(U. US)

03980FMMD

# JVC

VICTOR COMPANY OF JAPAN LIMITED

EN, SP, PR, CH



# Table of Contents

English

English

<b>Parts Identification</b> .....	<b>3</b>	<b>Using the DSP Modes</b> .....	<b>33</b>
<b>Easy Set Up &amp; Operations</b> .....	<b>5</b>	Using the 3D-PHONIC Modes.....	34
<b>Getting Started</b> .....	<b>9</b>	Using the DAP Modes.....	36
Before Installation.....	9	Preparing for Surround Modes.....	39
Checking the Supplied Accessories.....	9	Using Surround Modes.....	43
Setting the Voltage Selector Switch.....	9	<b>Using the DVD MULTI Playback Mode</b> .....	<b>44</b>
Connecting the FM and AM Antennas.....	10	Speaker Arrangements for DVD MULTI Playback.....	44
Connecting the Speakers.....	11	Activating the DVD MULTI Playback.....	44
Connecting Audio/Video Components.....	14	<b>Using the On-Screen Menus</b> .....	<b>47</b>
Connecting the Power Cord.....	19	Selecting the Source to Play.....	47
Putting Batteries in the Remote Control.....	19	Selecting the Different Sources for Picture and Sound.....	47
<b>Basic Operations</b> .....	<b>20</b>	Using the DSP Modes.....	47
Turning the Power On and Off (Standby).....	20	Adjusting the Front Speaker Output Balance.....	48
Selecting the Source to Play.....	20	Listening at Low Volume (Loudness).....	48
Adjusting the Volume.....	21	Adjusting the DSP Modes.....	48
Selecting the Front Speakers.....	22	Selecting Your Favorite SEA Mode.....	49
Muting the Sound.....	22	Creating Your Own SEA Mode.....	50
Recording a Source.....	22	Setting the Center-Speaker Size.....	50
<b>Basic Settings</b> .....	<b>23</b>	Setting the Rear Speaker.....	51
Changing the Source Name.....	23	Setting the Delay Time.....	51
Adjusting the Front Speaker Output Balance.....	23	Operating the Tuner.....	51
Listening at Low Volume (Loudness).....	23	Storing the Preset Stations.....	52
Using the Sleep Timer.....	24	Assigning Names to the Preset Stations.....	52
Setting Center and Rear Speakers for DSP Modes.....	24	<b>COMPU LINK Remote Control System</b> .....	<b>54</b>
<b>One Touch Operation</b> .....	<b>26</b>	<b>TEXT COMPU LINK Remote Control System</b> .....	<b>55</b>
About the One Touch Operation.....	26	Showing the Disc Information on the TV Screen.....	56
Using the One Touch Operation.....	26	Searching a Disc (Only for the CD player).....	57
<b>Receiving Radio Broadcasts</b> .....	<b>27</b>	Using the User File (Only for the CD Player with the User File Function).....	59
Setting the AM Tuner Interval Spacing.....	27	Entering the Disc Information.....	60
Tuning in Stations Manually.....	27	<b>Operating JVC's Audio/Video Components</b> .....	<b>62</b>
Using Preset Tuning.....	28	<b>Operating Other Manufacturers' Components</b> .....	<b>65</b>
Selecting the FM Reception Mode.....	29	<b>Troubleshooting</b> .....	<b>70</b>
Assigning Names to Preset Stations.....	30	<b>Specifications</b> .....	<b>71</b>
<b>Using the SEA Modes</b> .....	<b>31</b>		
Selecting Your Favorite SEA Mode.....	31		
Creating Your Own SEA Mode.....	32		

# Parts Identification

Become familiar with the buttons and controls on the receiver before use.

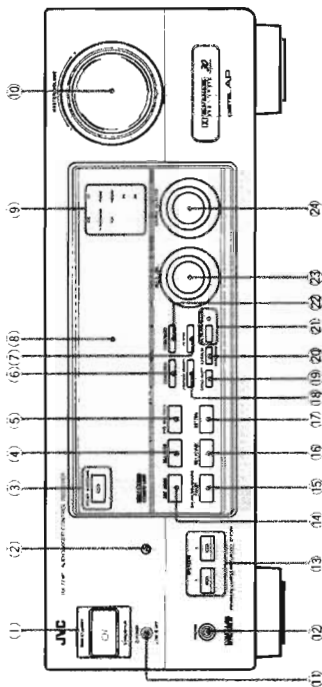

Refer to the pages in parentheses for details.

## Front Panel

- (1) STANDBY/ON  $\odot/\nabla$  button and STANDBY lamp (20)
- (2) Remote sensor (19)
- (3) DOLBY SURROUND button and lamp (41)
- (4) SEA MODE button (31) \*
- (5) DVD MULTIZUCH button (20)
- (6) FM/AM TUNING button (27) \*
- (7) FM MODE button (27, 29)
- (8) Display (20)
- (9) Source lamps (20)
- (10) MASTER VOLUME control (21)
- (11)  $\odot$  POWER switch (19)
- (12) PHONES jack (22)
- (13) SPEAKERS 1/2 buttons and lamps (22)
- (14) DSP MODE button (34) \*
- (15) BALANCE/SURROUND ADJUST button (23, 34) \*
- (16) SEA ADJUST button (32) \*
- (17) SETTING button (24) \*
- (18) TUNER/SEA MEMORY button (28, 32)
- (19) SOUND SELECT button (21)
- (20) LOUDNESS/SOURCE NAME button (23)
- (21) ONE TOUCH OPERATION button and lamp (26)
- (22) TUNER PRESET button (27, 28) \*
- (23) MULTI JOG control (23)
- (24) SOURCE SELECTOR control (20)

### IMPORTANT:

To use the MULTI JOG control (23) on the front panel: What this control actually does depends on which function you are trying to adjust. Before using this control, select the function by pressing one of the buttons marked with \*.

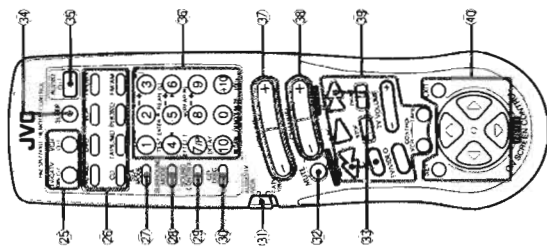

Refer to the pages in parentheses for details.

## Remote Control

- (25) TV/CATV/DBS  $\odot/\nabla$  and VCR  $\odot/\nabla$  buttons (65, 67)
  - (26) Source selecting buttons (21)
  - (27) SEA MODE button (31)
  - (28) SURROUND MODE button (35)
  - (29) SOUND CONTROL button (35, 38, 39, 46)
  - (30) CD DISC button (63)
  - (31) Remote control mode selector (AUDIO/TV/VCR, CATV/DBS) (20)
  - (32) MUTE button (22)
  - (33) TUNING UP/TUNING DOWN buttons (27)
- Before using this control, make sure that you have pressed FM/AM button on the remote control.
- (34) SLEEP button (24)
  - (35) AUDIO  $\odot/\nabla$  button (20)
  - (36) 10 keys for selecting preset channel (28)
  - (37) 10 keys for adjusting sound (35, 38, 39, 46)
  - (38) VOLUME buttons (+/-) (21)
  - (39) CHANNEL buttons (+/-) (64)
  - (40) Operating buttons for audio/video components (62, 65)
  - (41) MENU operation buttons (SET, EXIT,  $\Delta$ ,  $\nabla$ ,  $\leftarrow$ ,  $\rightarrow$ ) (47)

### IMPORTANT:

When using the remote control: Check to see if its remote control mode selector (31) is set to the correct position. To operate an audio system, TV, and VCR, set it to "AUDIO/TV/VCR." To operate a CATV converter and DBS (Direct Broadcasting Satellite) tuner, set it to "CATV/DBS."

# Easy Set Up & Operations

If you are already familiar with audio components, following four pages just you opened give you enough information to operate your RX-774PBK for enjoyment of surround sound in your listening room.

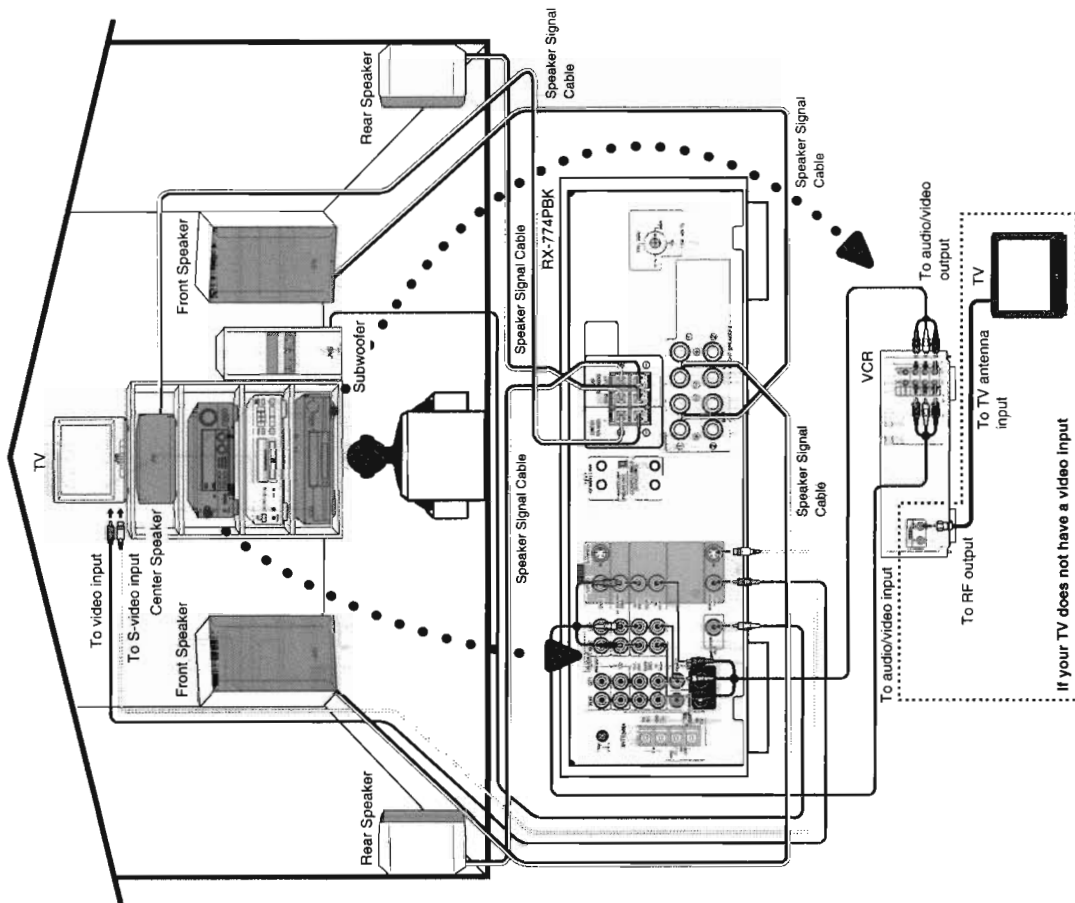

If your TV does not have a video input

1. Turn on the power.
2. Select the source.
3. Adjust the volume.
4. Select an appropriate DSP mode.
5. DSP mode settings are preset at the factory. However, if you need to make further adjustments, see pages 34 to 42.

# Easy Set Up & Operations

For Reproducing DVD MULTI playback with your DVD player

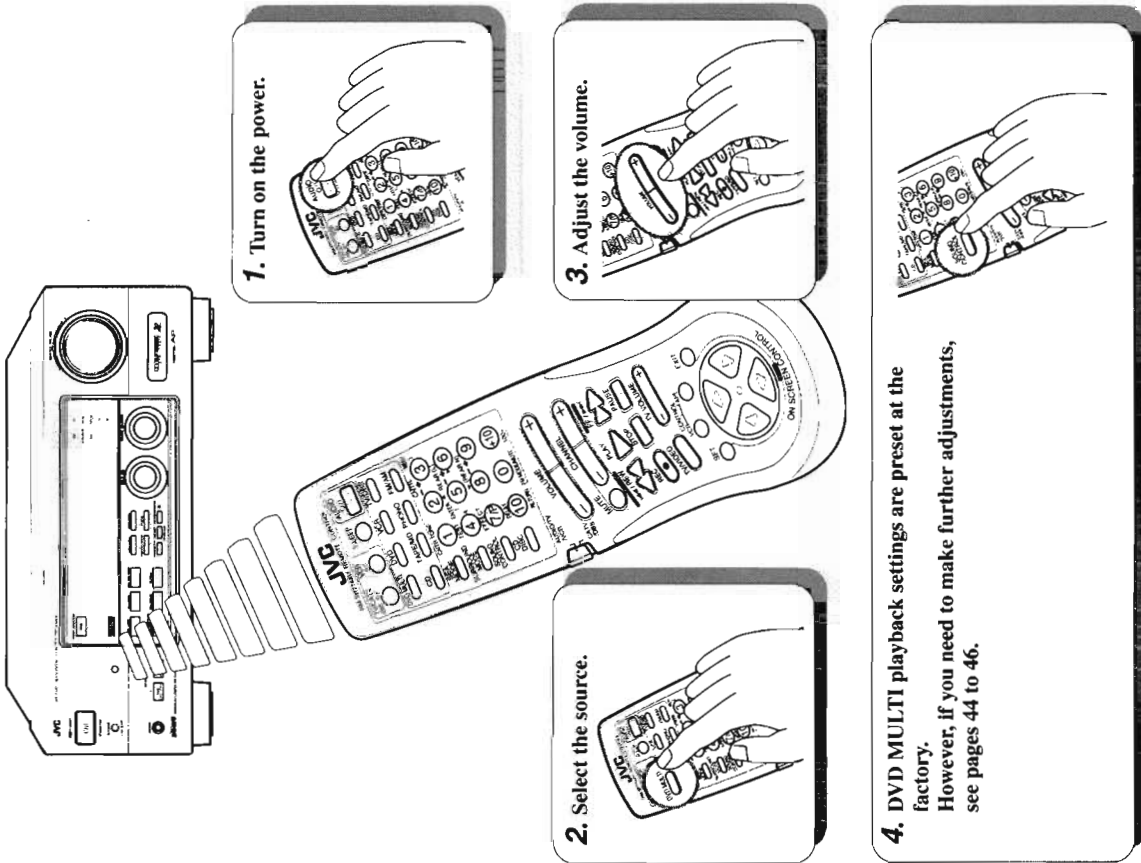
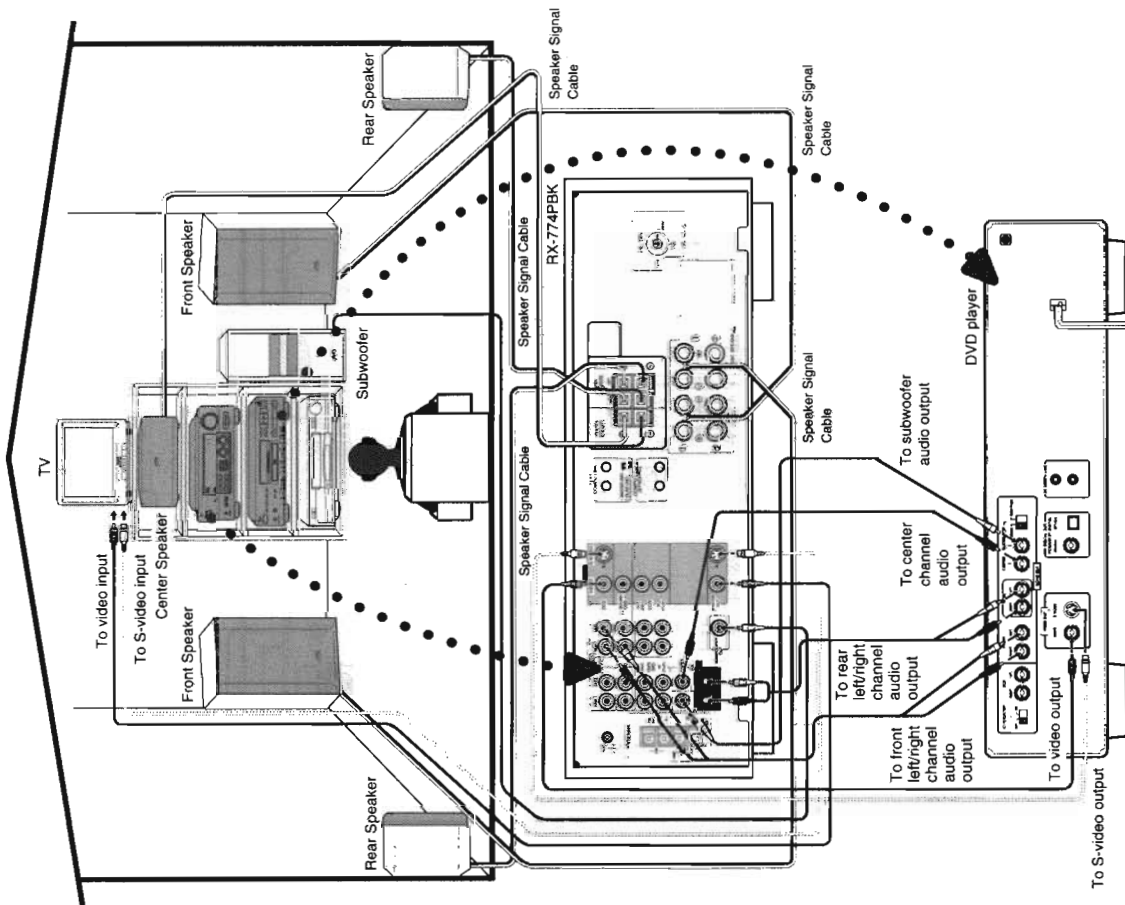



# Getting Started

This section explains how to connect audio/video components and speakers to the receiver, and how to connect the power supply.

English

## Before Installation

### General

- Be sure your hands are dry.
- Turn the power off to all components.
- Read the manuals supplied with the components you are going to connect.

### Locations

- Install the receiver in a location that is level and protected from moisture.
- The temperature around the receiver must be between -5° and 35° C (23° and 95° F).
- Make sure there is good ventilation around the receiver. Poor ventilation could cause overheating and damage the receiver.

### Handling the receiver

- Do not insert any metal object into the receiver.
- Do not disassemble the receiver or remove screws, covers, or cabinet.
- Do not expose the receiver to rain or moisture.

## Checking the Supplied Accessories

Check to be sure you have all of the following items, which are supplied with the receiver.

- Remote Control (1)
- Batteries (2)
- AM Loop Antenna (1)
- FM Antenna (1)
- Audio Signal Attenuating Cord (1)
- AC Plug Adaptor (1) (except for Peoples's Republic of China)

If anything is missing, contact your dealer immediately.

## Setting the Voltage Selector Switch

Before connections, always do the following first if necessary.

### How to set the voltage selector:

Set the correct voltage for your area with the voltage selector switch on the rear panel. Use a screw driver to rotate the switch so the number the arrow is pointing at is the same as the voltage where you are plugging in the receiver.

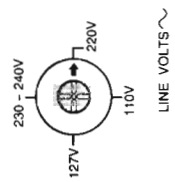

## Connecting the FM and AM Antennas

### FM Antenna Connections

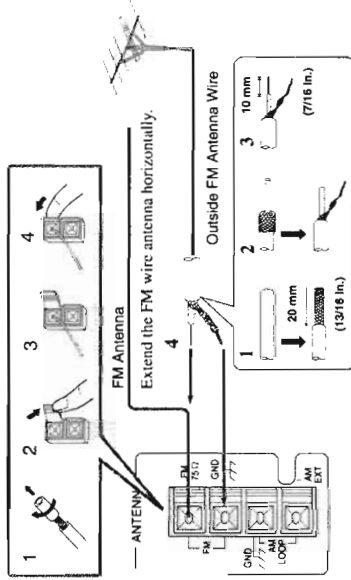

### Note:

If reception is poor, connect the outside antenna. Before attaching a 75Ω coaxial cable (the kind with a round wire going to an outside antenna), disconnect the supplied FM wire antenna.

### How to strip the 75Ω coaxial cable and connect it to the FM terminals

1. Strip back the outside covering of the 75Ω coaxial cable to expose the braided metallic mesh about 20 mm (3/16 inches).
2. Pull the mesh back and twist it into a single connector as shown in the illustration above.
3. Strip the insulation about 10 mm (7/16 inches) back from the central wire.
4. Insert the twisted mesh and the central wire to the FM terminals, as shown in the illustration above.

### AM Antenna Connections

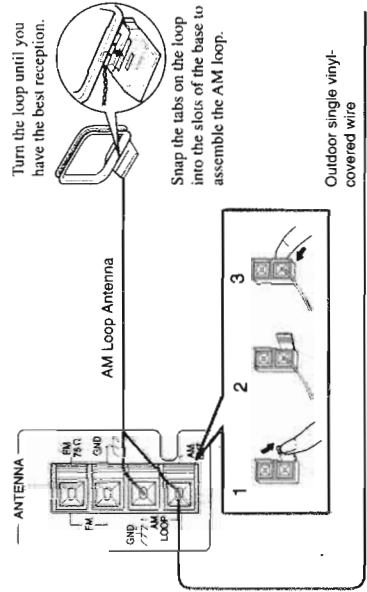

### Notes:

- Make sure the antenna conductors do not touch any other terminals, connecting cords and power cord. This could cause poor reception.
- If reception is poor, connect an outdoor single vinyl-covered wire to the AM EXT terminal. (Keep the AM loop antenna connected.)

English

# Getting Started

## Connecting the Speakers

You can connect the following speakers:

- Two pairs of front speakers to produce normal stereo sound.
- One pair of rear speakers to enjoy the surround effect.
- One center speaker to produce more effective surround effect (to emphasize human voices).
- One subwoofer to enhance the bass.

**IMPORTANT:**

After connecting the speakers listed above, set the speaker setting information properly to obtain the best possible surround effect. For details, see page 24.

For each speaker (except for subwoofer), connect the (-) and (+) terminals on the rear panel to the (-) and (+) terminals marked on the speakers. For connecting a subwoofer, see page 12.

### Connecting the front speakers

Cut, twist and remove the insulation at the end of each speaker signal cable first, and then, connect the front speakers to the FRONT SPEAKERS terminals by using the cables. You can connect two pairs of front speakers (one pair to the FRONT SPEAKERS ① terminals, and another pair to the FRONT SPEAKERS ② terminals).

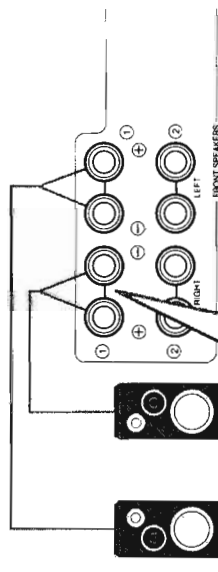

- 1 Turn the knob counterclockwise.
- 2 Insert the speaker signal cable.
- 3 Turn the knob clockwise.

### Connecting the rear and center speakers

Cut, twist and remove the insulation at the end of each speaker signal cable first, and then, connect rear speakers to the REAR SPEAKERS terminals and a center speaker to the CENTER SPEAKER terminals by using the cables.



- 1 Open the terminal and then insert the speaker signal cable.
- 2 Close the terminal.

**CAUTION:**

Use speakers with the SPEAKER IMPEDANCE indicated by the speaker terminals.

### Connecting the subwoofer speaker

You can enhance the bass by connecting a subwoofer. Connect the input jack of a powered subwoofer to the SUBWOOFER OUT jack on the rear panel, using a cable with RCA pin plugs.

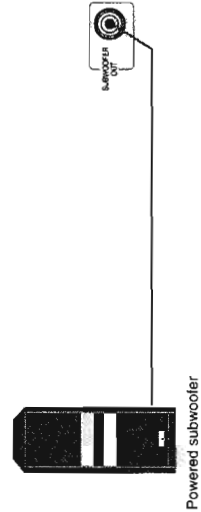

**About the speaker impedance**

**CASE 1** When you connect only one set of front speakers

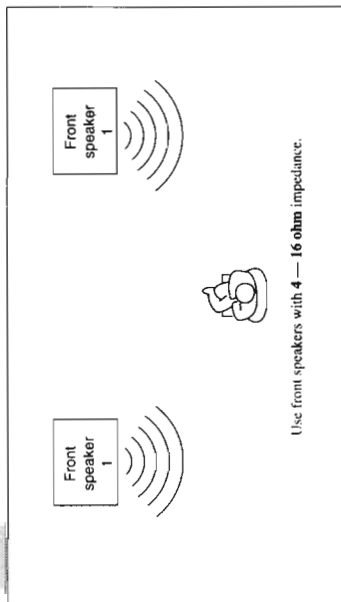

**CASE 2** When you connect two sets of front speakers

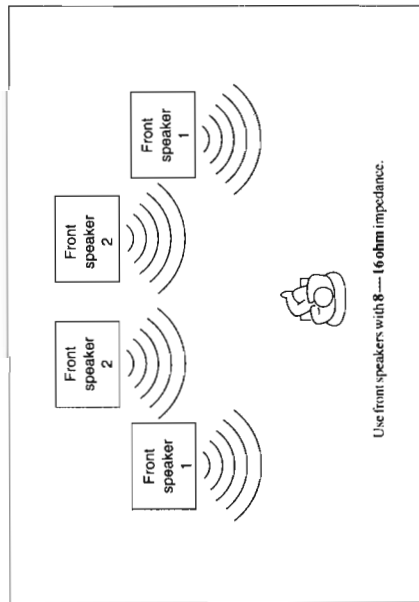

**CAUTION:**

When connecting speakers, use speakers with the same **SPEAKER IMPEDANCE** terminals. indicated by the speaker terminals.

**Note:**

The required speaker impedance of the front speakers does differ depending on whether both the **FRONT SPEAKERS (1)** and **FRONT SPEAKERS (2)** terminals are used or only one of them is used.

**Connecting Audio/Video Components**

You can connect the following audio/video components to this receiver using cables with RCA pin plugs (not supplied). Refer also to the manuals supplied with your components. If you want to connect a component not listed in the table below, refer to the manual supplied with it.

Audio Components	Video Components
• Turntable	• DVD (Digital Video Disc) player
• CD player	• TV
• Cassette deck (or MD recorder)	• DBS (Direct Broadcasting Satellite) tuner
	• VCR

**Audio component connections**

Use the cables with RCA pin plugs (not supplied). Connect the white plug to the audio left jack, and the red plug to the audio right jack.

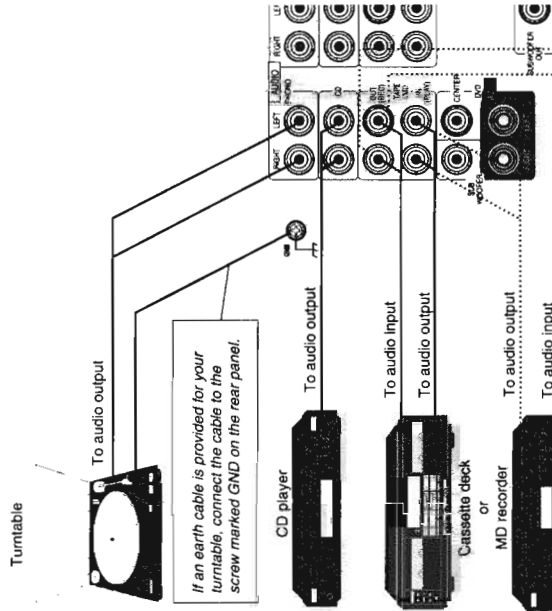

**If your audio components have a COMPU LINK-3 or TEXT COMPU LINK terminal**

- See also page 54 for detailed information about the connection and the COMPU LINK-3 remote control system.
- See also page 55 for detailed information about the connection and the TEXT COMPU LINK remote control system.

**CAUTION:**

If you connect a sound-enhancing device such as a graphic equalizer between the source components and this receiver, the sound output through this receiver may be distorted.

**Notes:**

- Any turntables incorporating a small-output cartridge such as an MC (moving-coil type) must be connected to this receiver through a commercial head amplifier or step-up transformer. Direct connection may result in insufficient volume.
- You can connect either a cassette deck or an MD recorder to the TAPE/MD jacks. When connecting an MD recorder to the TAPE/MD jacks, change the source name, which will be shown on the display when selected as the source, to "MD." See page 23 for details.
- When connecting an audio/video component (ex.: Video CD player) with "karaoke" — singing along — function, use the audio signal attenuating cord supplied with this receiver. If not, sound may be distorted.

Getting Started

Video component connections

Use the cables with RCA pin plugs (not supplied). Connect the white plug to the audio left jack, the red plug to the audio right jack, and the yellow plug to the video jack.

If DVD player and TV have S-video (Y/C-separation) terminals, connect them using S-video cables (not supplied). Connecting these video components through the S-video input/output terminals will give you better picture playback quality.

**IMPORTANT:**

This receiver is equipped with both the composite video and S-video input terminals for the DVD player connection. You do not have to connect both the composite video and S-video terminals. However, **remember that the video signals from the composite video input terminal are output only through the composite video output terminals, while the ones from the S-video input terminal are output only through the S-video output terminal.**

Therefore, if your DVD player is connected to the receiver only through the S-video input terminal, you cannot record the picture from the DVD player on the VCR.

In addition, if the TV and the DVD player are connected to the receiver through the different video terminals, you cannot view the playback picture from the DVD player on the TV.

TV connection (as the monitor)

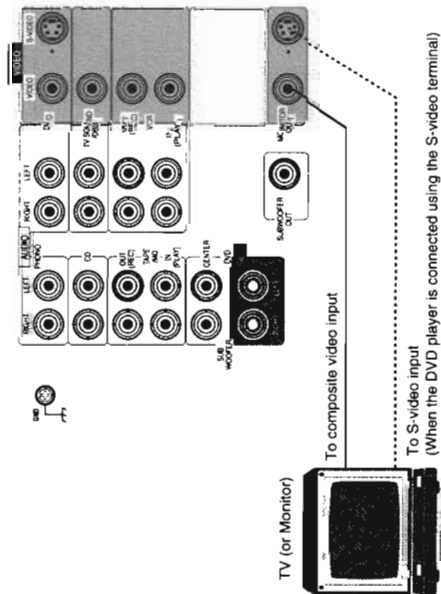

**Note:**

When connecting an audio/video component (ex.: video CD player) with "karaoke" — singing along — function, use the audio signal attenuating cord supplied with this receiver. If not, sound may be distorted.

**Note:**

Use the video components of the PAL color system.

DVD player connection

- When you connect the DVD player with stereo output jacks:

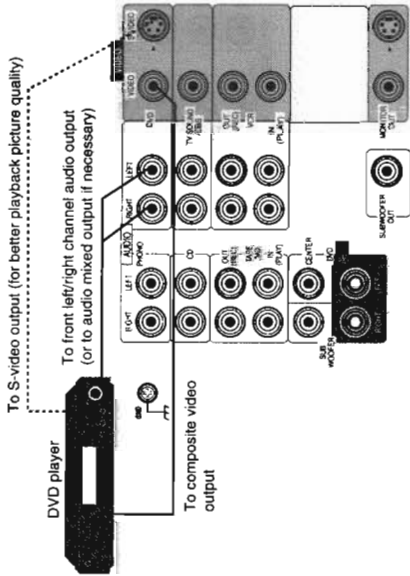

- When you connect the DVD player with its analog discrete output (5.1 CH reproduction) jacks:

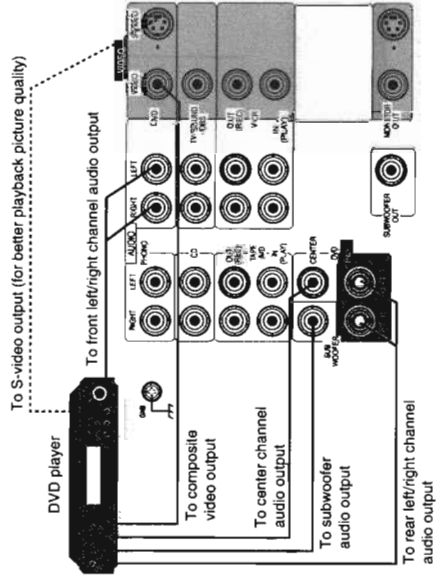

# Getting Started

## TV (as the sound source) or DBS tuner connection

You can connect either the TV or DBS tuner to the TV SOUND/DBS jacks.

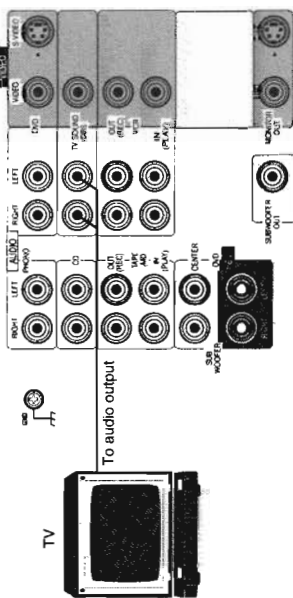

**Note:**  
When connecting the TV to the TV SOUND/DBS jacks, DO NOT connect the TV's video output to the video input terminal of the TV SOUND/DBS jacks.

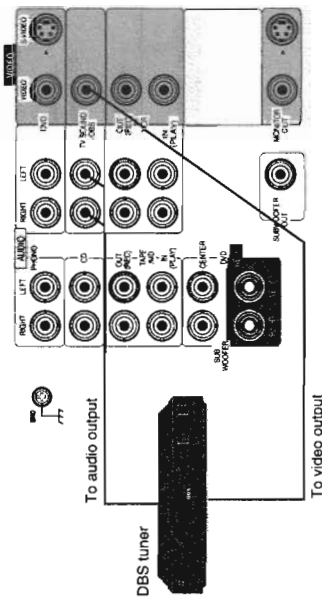

**Note:**  
When connecting the DBS tuner to the TV SOUND/DBS jacks, change the source name, which will be shown on the display when selected as the source, to "DBS." See page 23 for details.

## VCR connection

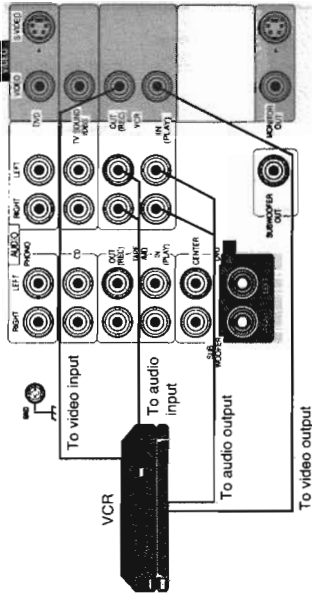

## Getting Started

### Connecting the Power Cord

Before plugging the receiver into an AC outlet, make sure that all connections have been made.

1. Plug the power cord into an AC outlet.
2. Press **⓪ POWER** to set it in the **-ON** position. The STANDBY lamp lights up. A small amount of power is always consumed.



### To shut off the power completely

Press **⓪ POWER** to set it in the **-OFF** position.

Keep the power cord away from the connecting cables and the antenna. The power cord may cause noise or screen interference. We recommend that you use a coaxial cable to connect the antenna, since it is well-shielded against interference.

### The difference between the **⓪ POWER switch** and the **STANDBY/ON ⓪/1 button**

- The **⓪ POWER** switch is the mains supply switch, allowing the receiver to connect to the mains supply. To shut off the power completely, press the **⓪ POWER** switch to set it in the **-OFF** position.
- The **STANDBY/ON ⓪/1** button is a functional on/off (standby) switch, and does not disconnect the receiver from the mains supply. A small amount of power is consumed even in standby mode for the receiver to accept signals from the remote control.

### Putting Batteries in the Remote Control

Before using the remote control, put two supplied batteries first. When using the remote control, aim the remote control directly at the remote sensor on the receiver.

1. On the back of the remote control, remove the battery cover as illustrated.
2. Insert batteries. Make sure to observe the proper polarity: (+) to (+) and (-) to (-).
3. Replace the cover.

R03 (UM-4)/AAA (24F)

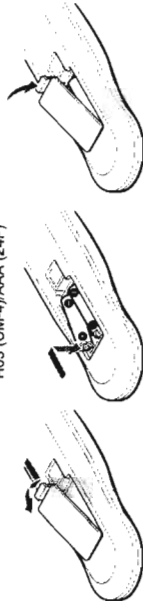

If the range or effectiveness of the remote control decreases, replace the batteries. Use two R03 (UM-4)/AAA (24F) type dry-cell batteries.

## Basic Operations

The following operations are commonly used when you play any sound source.

### IMPORTANT:

When using the Remote Control, check to see if its remote control mode selector is set to the correct position:  
To operate an audio system, TV, and VCR, set it to "AUDIO/TV/VCR."  
To operate a CATV converter and DBS tuner, set it to "CATV/DBS."



### Turning the Power On and Off (Standby)

#### On the front panel:

To turn on the power, press **STANDBY/ON ⓪/1**. The STANDBY lamp goes off. The name of the current source (or station frequency) appears on the display.

Current source name appears

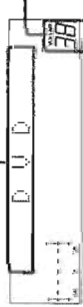

Current volume level is shown here

To turn off the power (into standby mode), press **STANDBY/ON ⓪/1** again. The STANDBY lamp lights up.

#### From the remote control:

To turn on the power, press **AUDIO ⓪/1**. The STANDBY lamp goes off. The name of the current source (or station frequency) appears on the display.

To turn off the power (into standby mode), press **AUDIO ⓪/1** again. The STANDBY lamp lights up.

### Selecting the Source to Play

#### On the front panel:

Turn **SOURCE SELECTOR** until the source name you want appears on the display. As you turn the selector, the source changes as follows:

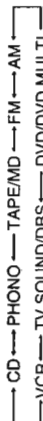

The selected source lamp also lights up.



Source lamps on the front panel

#### For selecting DVD MULTI playback mode as the source:

- Press **DVD MULTI/2CH** so that "DVD MULTI" appears on the display. Each time you press the button, the DVD MULTI playback mode turns on and off, and the "DVD" and "DVD MULTI" alternately appears on the display.
- Select "DVD" when you play back a disc in stereo or the audio output setting of the DVD player is mixed to two front channels.
  - Select "DVD MULTI" when you play back a disc on the DVD player with its analog discrete output mode (5.1 CH reproduction) selected. To enjoy the DVD MULTI playback mode, see page 44.

### Note:

- Pressing the **STANDBY/ON ⓪/1** button again turns off the power (into standby mode) and lights the STANDBY lamp. A small amount of power is consumed in standby mode. To turn the power off completely, press the **⓪ POWER** switch to set it in the **-OFF** position on the front panel.

### Note:

- When connecting an MD recorder (to the TAPE/MD jacks) and a DBS tuner (to the TV SOUND/DBS jacks), change the source name appears on the display. See page 23 for details.

## Basic Operations

### From the remote control:

Press one of the source selecting buttons directly.

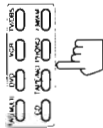

#### DVD MULTI

Select the DVD player for viewing the digital video disc using the analog discrete output mode (S-1CH reproduction) on the DVD player. Each time you press the button, the source alternates between "DVD" and "DVD MULTI."

DVD Select the DVD player for viewing the stereo digital video disc player. ("DVD MULTI" will be selected when the last mode for the DVD playback has been the DVD MULTI playback mode.)

VCR Select the video component connected to the VCR jacks.

- Select the TV sound when the remote control selector is set to "AUDIO/TV/VCR."
- Select the DBS tuner when the remote control selector is set to "CATV/DBS."

#### CD\*

TAPE/MD\* Select the cassette deck (or the MD recorder).  
PHONO\* Select the turntable.  
FM/AM\* Select an FM or AM broadcast.  
Each time you press the button, the band alternates between FM and AM.

### Selecting different sources for picture and sound

You can watch picture from a video component while listening to sound from another component.

#### On the front panel:

1. Press SOUND SELECT briefly while viewing the picture from a video component such as the VCR or DVD player, etc. "SOUND SELECT" appears on the display.
2. Turn SOURCE SELECTOR to select the sounds (except the TV sound), while the indication of the above step is still on the display.

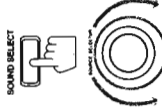

### From the remote control:

Press one of the audio source selecting buttons (CD, TAPE/MD, PHONO, FM/AM), while viewing the picture from a video component such as the VCR or DVD player, etc.

### Adjusting the Volume

#### On the front panel:

To increase the volume, turn MASTER VOLUME clockwise.  
To decrease the volume, turn it counterclockwise.

When you turn MASTER VOLUME rapidly, the volume level also changes rapidly.  
When you turn MASTER VOLUME slowly, the volume level also changes slowly.



### From the remote control:

To increase the volume, press VOLUME +.  
To decrease the volume, press VOLUME -.

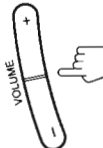

### Selecting the Front Speakers

#### On the front panel only:

When you have connected two pairs of the front speakers, you can select which to use.



Press SPEAKERS 1 or SPEAKERS 2 to select the speaker to use. Each time you press the button, the lamp on the respective button turns on and off. When the lamp on either button lights up, the respective speakers are activated.

#### IMPORTANT:

You can activate two pairs of the front speakers at the same time only when no signals are sent to the center and rear speakers. Otherwise, activating one pair of the speakers deactivates the other.

### Listening only with headphones

1. Connect a pair of headphones to the PHONES jack on the front panel.
2. Press SPEAKERS 1 and/or 2 so that no lamps on the buttons are turned on.

### Muting the Sound

#### From the remote control only:

Press MUTE to mute the sound through all speakers and headphones connected.

"MUTE" appears on the display and the volume turns off (the volume level indicator goes off).



To restore the sound, press MUTE again so that "OFF" appears on the display. Turning MASTER VOLUME or pressing VOLUME +/- also restores the sound at the previous volume level.

### Recording a Source

You can record any source playing through the receiver to a cassette deck (or a MD recorder) connected to the TAPE/MD jacks and the VCR connected to the VCR jacks at the same time.

While recording, you can listen to the selected sound source at whatever sound level you like, without affecting the sound levels of the recording.

#### Note:

If you use any of the DSP modes other than the 3D-PHONIC modes and "HEADPHONE" with both front speakers activated, the speakers connected to the FRONT SPEAKERS terminals are deactivated.

#### CAUTION:

Be sure to turn down the volume before connecting or putting on headphones, as high volume can damage both the headphones and your hearing.

#### Note:

You cannot shut off the sound through the subwoofer using the SPEAKERS 1 and 2 buttons.

#### Note:

The output volume level, SEA and DSP modes cannot affect the recording.

#### IMPORTANT:

Before recording, turn off the DVD MULTI playback mode.

# Basic Settings

Some of the following settings are required after connecting and positioning your speakers in your listening room, while others will make operations easier.

## IMPORTANT:

When using the Remote Control, check to see if its remote control mode selector is set to the correct position:  
To operate this receiver, set it to "AUDIO/TV/VCR" (except when selecting the DBS tuner as the source)."

## Changing the Source Name

When you have connected an MD recorder to the TAPE/MD jacks or the DBS tuner to the TV SOUND/DBS jacks on the rear panel, change the source name shown on the display when you select the MD recorder or DBS tuner as the source.

### On the front panel only:

1. When changing the source name from "TAPE" to "MD":
  - Turn SOURCE SELECTOR until "TAPE" appears.
  - When changing the source name from "TV SOUND" to "DBS":
  - Turn SOURCE SELECTOR until "TV SOUND" appears.
2. Press and hold LOUDNESS/SOURCE NAME until "ASSGN. MD" or "ASSGN. DBS" appears on the display.



To change the source names to "TAPE" or "TV SOUND," repeat the same procedure above (in step 1, select "MD" or "DBS" then press and hold SOURCE NAME).

## Adjusting the Front Speaker Output Balance

If the sounds you hear from the front right and left speakers are unequal, you can adjust the speaker output balance.

### On the front panel only:

1. Press BALANCE/SURROUND ADJUST repeatedly until "L/R BALANCE" appears on the display. The display changes to show the current setting.
2. Turn MULTI JOG to adjust the balance, while the indication of the previous step is still on the display.
  - Turning it clockwise decreases the left channel output.
  - Turning it counterclockwise decreases the right channel output.



## Listening at Low Volume (Loudness)

Human ears are not sensitive to bass at low volume. To compensate for this, the loudness function automatically boosts the bass level as you lower the volume.

### On the front panel only:

- Press LOUDNESS/SOURCE NAME briefly to select the loudness function.
- Each time you press the button, the loudness function alternates between "LOUDNESS ON" and "LOUDNESS OFF."
- Select "LOUDNESS ON" to activate the loudness function. The LOUDNESS indicator lights up on the display.
  - Select "LOUDNESS OFF" to cancel it. The indicator goes off.



## Using the Sleep Timer

Using the Sleep Timer, you can fall asleep to music and know the receiver will turn off by itself rather than play all night.

### From the remote control only:

Press SLEEP repeatedly. The shut-off time on the display changes as follows, and the SLEEP indicator lights up on the display.

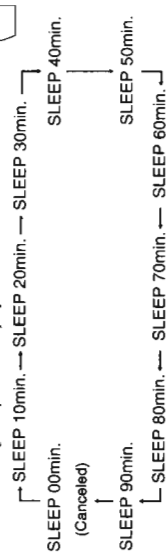

### When the shut-off time comes

The receiver turns off automatically.

### To check or change the time remaining until the shut-off time

Press SLEEP once. The remaining time until the shut-off time appears in minutes.
 

- To change the shut-off time, press SLEEP repeatedly.

### To cancel the Sleep Timer

Press SLEEP repeatedly until "SLEEP 00min." appears on the display. (The SLEEP indicator goes off.) Turning off the power also cancels the Sleep Timer.

## Setting Center and Rear Speakers for DSP Modes

To obtain the best possible surround sound of the DSP modes, you have to register the information about the speakers arrangement after all connections are completed.

### Center Speaker Setting

Register the center speaker size.

### On the front panel only:

1. Press SETTING repeatedly until "CENTER SPK" (Center Speaker Size) appears on the display. The display changes to show the current setting.



### Turn MULTI JOG to select the appropriate item about your center speaker, while the indication of the previous step is still on the display.

As you turn it, the display changes to show the following:
 

- LARGE → SMALL → NONE



<b>LARGE:</b>	Select this mode when the size of the center speaker is the same as that of the front speakers.
<b>SMALL:</b>	Select this mode when the size of the center speaker is smaller than that of the front speakers.
<b>NONE:</b>	Select this mode when you do not use a center speaker.

### Note:

When you change your speakers, you need to register the information about the speakers again.



## Basic Settings

### Rear Speaker Setting

Register whether you have connected the rear speakers or not.

#### On the front panel only:

1. Press **SETTING** repeatedly until "REAR SPK" (Rear Speaker) appears on the display. The display changes to show the current setting.
2. Turn **MULTI JOG** to register whether you have connected the rear speaker or not, while the indication of the previous step is still on the display. As you turn it, the rear speaker setting alternates between "YES" and "NO."



<b>YES:</b>	Select this mode when you use rear speakers.
<b>NO:</b>	Select this mode when you do not use rear speakers.

### Delay Time Setting

Register the delay time of the sound from the rear speakers, comparing the sound from the front speakers.

#### On the front panel:

1. Press **SETTING** repeatedly until "DELAY TIME" appears on the display. The display changes to show the current setting.
2. Turn **MULTI JOG** to select the delay time of the rear speaker output, while the indication of the previous step is still on the display. As you turn it, the delay time changes as follows:

DELAY 15msec — DELAY 20msec — DELAY 30msec

As the distance from you to your rear speakers decreases, you will get the better surround sound by using smaller delay time.

#### From the remote control:

1. Press **SOUND CONTROL**.
2. Press **DELAY** repeatedly until an appropriate delay time appears on the display. Each time you press the button, the delay time changes as follows:

DELAY 15msec — DELAY 20msec — DELAY 30msec



## One Touch Operation

This receiver can memorize the optimum sound settings for each playing source.

### About the One Touch Operation

JVC's One Touch Operation function is used to assign and store different sound settings for each different playing source. By using this function, you don't have to change the settings every time you change the source. The stored settings for the newly selected source are automatically recalled.

The following can be stored for each source:

- Volume level (see page 21)
- Balance (see page 23)
- Loudness (see page 23)
- SEA modes (see page 31)
- DSP modes
  - 3D-PHONIC mode settings (see page 34)
  - DAP mode settings (see page 36)
  - Surround mode settings (see page 39)
- DVD MULTI playback mode settings (see page 44)

#### Notes:

- If the source is FM or AM, you can assign a different setting for each band.
- The DSP modes and DVD MULTI playback mode cannot be used at the same time.

### Using the One Touch Operation

#### On the front panel only:

##### To store the sound settings

1. Press **ONE TOUCH OPERATION**. The **ONE TOUCH OPERATION** lamp lights up, then the previously memorized settings are recalled.
2. Adjust the sound using the functions listed above. The newly adjusted settings are memorized.



##### To recall the sound settings

With the **ONE TOUCH OPERATION** lamp lit, the settings for the currently selected source is recalled, when the source is selected.



##### To cancel the One Touch Operation function

Press **ONE TOUCH OPERATION** so that the lamp goes off. (Even though the One Touch Operation function is canceled, the recalled sound effects remain active.)

# Receiving Radio Broadcasts

You can browse through all the stations or use the preset function to go immediately to a particular station.

## IMPORTANT:

When using the Remote Control, check to see if its remote control mode selector is set to the correct position:  
**To operate this receiver, set it to "AUDIO/TV/VCR" (except when selecting the DBS tuner as the source)."**

## Setting the AM Tuner Interval Spacing

Some countries space AM stations 9 kHz apart, and other countries use 10 kHz spacing. When shipped, the spacing is set to 9 kHz.

### On the front panel only:

#### To select the 10 kHz interval:

Be sure the receiver is turned off, but is plugged into an AC outlet and **POWER** is pressed to set it in the **FM** position. Hold down **TUNER PRESET** and press **STANDBY/ON**  $\odot$ /I. "10K STEP" appears on the display for about three seconds. Now the 10 kHz interval is selected.

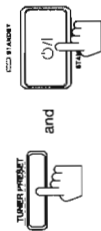

#### To change back to the 9 kHz interval:

Be sure the receiver is turned off, but is plugged into an AC outlet and **POWER** is pressed to set it in the **FM** position. Hold down **FM MODE** and press **STANDBY/ON**  $\odot$ /I. "9K STEP" appears on the display for about three seconds. Now the 9 kHz interval is selected.

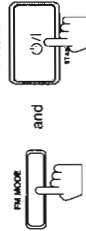

## Tuning in Stations Manually

### On the front panel:

1. Press **FM/AM TUNING** to select the band. Each time you press the button, the band alternates between FM and AM.
2. Turn **MULTI JOG** until you find the frequency you want.
  - Turning it clockwise increases the frequency.
  - Turning it counterclockwise decreases the frequency.



### From the remote control:

1. Press **FM/AM** to select the band. Each time you press the button, the band alternates between FM and AM.
2. Press **TUNING DOWN** or **TUNING UP** repeatedly until you find the frequency you want.



## Using Preset Tuning

Once a station is assigned to a channel number, the station can be quickly tuned. You can preset up to 40 stations at random.

### To store the preset stations

#### On the front panel only:

1. Tune in the station you want to preset (see page 27). If you want to store the FM reception mode for this station, select the FM reception mode you want. See page 29 for details.
2. Press **TUNER/SEA MEMORY**. "CH1" appears and the channel number position starts flashing on the display for about 5 seconds.
3. Turn **MULTI JOG** to select a channel number while the channel number position is flashing.
4. Press **TUNER/SEA MEMORY** again while the selected channel number is flashing on the display. The selected channel number stops flashing. The station is assigned to the selected channel number.
5. Repeat steps 1 to 4 until you store all the stations you want.



**To erase a stored preset station**  
 Storing a new station on a used number erases the previously stored one.

### To tune in a preset station

- #### On the front panel:
1. Press **TUNER PRESET**.
  2. Turn **MULTI JOG** to select a preset channel.

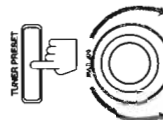

### From the remote control:

1. Press **FM/AM**. Each time you press the button, the band alternates between FM and AM.
2. Press 10 keys to select a preset channel number.
  - For channel number 5, press 5.
  - For channel number 15, press +10 then 5.
  - For channel number 20, press +10 then 10.
  - For channel number 30, press +10, +10, then 10.

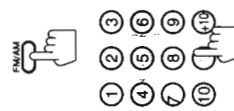

### Note:

You can use the 10 keys on the remote control to select the preset number. When using the 10 keys, be sure that they are activated for tuner, not for the CD and others. (See page 62.)

### Note:

When you use the 10 keys on the remote control, be sure that they are activated for tuner, not for the CD and others. (See page 62.)

## Selecting the FM Reception Mode

### On the front panel:

When an FM stereo broadcast is hard to receive or noisy, set the FM reception mode to MONO. (When shipped from the factory, this mode has been set to AUTO.) You can change the FM reception mode while receiving an FM broadcast.

Press **FM MODE** to select the FM reception mode. Each time you press the button, the FM reception mode alternates between AUTO and MONO.



<b>AUTO:</b>	When a program is broadcasted in stereo, you will hear stereo sound; when in monaural, you will hear monaural sounds. This mode is also useful to suppress static noise between stations. The MUTE AUTO indicator lights up on the display.
<b>MONO:</b>	Reception will be improved although you will lose the stereo effect. In this mode, you will hear noise while tuning into the stations. The MUTE AUTO indicator goes off on the display.

### From the remote control:

Press **FM MODE/MUTE** to select the FM reception mode. Each time you press the button, the FM reception mode alternates between AUTO and MONO.



### Note:

You can store the FM reception mode for each preset station.

## Assigning Names to Preset Stations

You can assign a name of up to four characters to each preset station. When a preset station is tuned in, its assigned name will appear on the display.

### On the front panel only:

- Tune in a preset station.**  
See page 28 for details.
- Press TUNER/SEA MEMORY.**  
The preset channel number starts flashing for about 5 seconds.
- Press TUNER PRESET, while the preset channel number is flashing.**  
The first character position starts flashing.

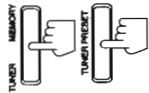

- Turn MULTI JOG to select a character, while the first character position is flashing.**  
You can use characters listed below.



- Press TUNER PRESET, while a character you want is flashing.**  
The next (or previous) character position starts flashing.

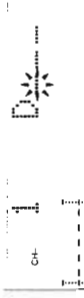

- Repeat steps 4 and 5 to enter up to four characters.
- Press TUNER/SEA MEMORY while the last selected character is flashing after you have assigned a name.**



### To erase the input characters

Insert spaces using the same procedure described above.

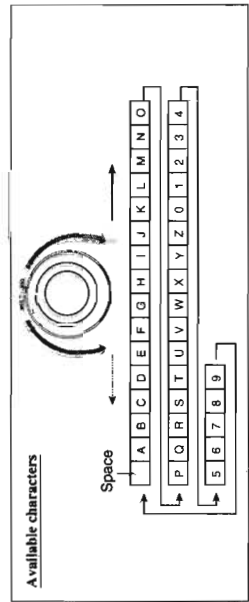

### Note:

If you turn MULTI JOG while the preset channel number is flashing, you can change the preset channel number.

### Note on step 3 to 7:

You cannot select any entry after the indication on the display stops flashing. In this case, repeat the procedure from step 2 again.

# Using the SEA Modes

The SEA (Sound Effect Amplifier) modes give you control of the way your music sounds.

### IMPORTANT:

When using the Remote Control, check to see if its remote control mode selector is set to the correct position: To operate this receiver, set it to "AUDIO/TV/VCR" (except when selecting the DBS tuner as the source)."

### Selecting Your Favorite SEA Mode

#### On the front panel:

1. Press SEA MODE. The display changes to show the current setting.
2. Turn MULTI JOG until the mode you want appears on the display, while the indication of the previous step is still on the display. As you turn it, the SEA mode changes as follows:

SEA ROCK → SEA MUSICAL → SEA MOVIE → SEA COUNTRY → SEA OFF → SEA USERMODE → SEA JAZZ

<b>SEA ROCK:</b>	Gives a heavy sound. Both high and low frequencies are boosted.
<b>SEA MUSICAL:</b>	Enhance the mid-frequency range, which the human voice is mostly made up of.
<b>SEA MOVIE:</b>	Adds breadth to sounds so you feel like you are in a movie theater.
<b>SEA COUNTRY:</b>	Enhances the high-frequency range so that instruments such as the violin and bongo are emphasized.
<b>SEA JAZZ:</b>	Gives a feeling of a live atmosphere. Good for acoustic music.
<b>SEA USERMODE:</b>	Your original SEA adjustment (see page 32).
<b>SEA OFF:</b>	No SEA mode is applied (see below).

#### To cancel the SEA mode

Turn MULTI JOG until "SEA OFF" appears in step 2 above. The SEA indicator goes off from the display.

#### From the remote control:

Press SEA MODE repeatedly until the SEA mode you want appears on the display. Each time you press the button, the SEA mode changes as follows:

SEA ROCK → SEA MUSICAL → SEA MOVIE → SEA COUNTRY → SEA OFF → SEA USERMODE → SEA JAZZ

#### To cancel the SEA mode

Press SEA MODE repeatedly until "SEA OFF" appears. The SEA indicator goes off from the display.

### Creating Your Own SEA Mode

You can adjust and store your own SEA adjustment into memory (SEA USERMODE).

#### On the front panel only:

If you do not want to store your adjustment, but rather want to adjust the SEA temporarily, skip step 4 below.

1. Press SEA ADJUST repeatedly until the frequency range (100Hz, 1kHz or 10kHz) you want appears on the display.

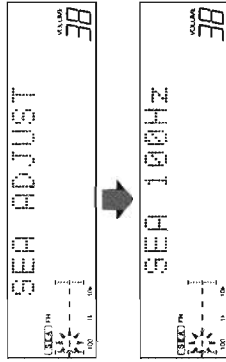

2. Turn MULTI JOG to adjust the SEA level of the selected frequency range, while the indication of the previous step is still on the display.
  - Turning it clockwise increases the level.
  - Turning it counterclockwise decreases the level.

This FR means this adjustment can be applied to the Front speakers only.



3. Repeat step 1 and 2 to adjust other frequency ranges if necessary.

4. Press TUNER/SEA MEMORY, while the indication of the previous step is still on the display. Your adjustment is stored into SEA USERMODE.

#### To recall your own SEA adjustment

See page 31.

#### To erase a stored adjustment

Storing a new adjustment into SEA USERMODE erases the previously stored one.

# Using the DSP Modes

The built-in Surround Processor provides three types of the DSP (Digital Signal Processor) mode — 3D-PHONIC mode, DAP (Digital Acoustic Processor) mode and Surround mode (Dolby Pro Logic and Theater Surround.)

## On 3D-PHONIC mode

The 3D-PHONIC mode gives you such a nearly surround effect as it is reproduced through the Dolby Surround decoder, which is widely used to reproduce sounds with a feeling of movement like those experienced in movie theaters. The 3D-PHONIC mode is the result of research on sound localization technology carried out at JVC for many years and makes it possible to reproduce the surround sound with only two front speakers.

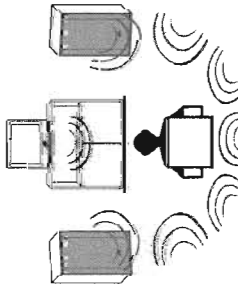

## On the DAP mode

The sound heard in a concert hall or club consists of direct sound and indirect sound — early reflections and reflections from behind. Direct sounds reach the listener directly without any reflection. On the other hand, indirect sounds are delayed by the distances of the ceiling and walls. These direct sounds and indirect sounds are the most important elements of the acoustic surround effects. The DAP mode can create these important elements, and gives you a real "being there" feeling.

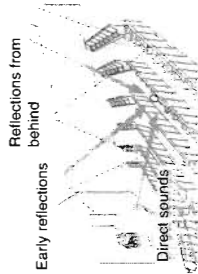

## On Surround mode

With this receiver, you can use two types of the surround mode.

### Dolby Pro Logic

Dolby Pro Logic has been developed to reproduce the important elements of the acoustic surround at home. To watch the soundtracks of video software bearing the mark which includes the same encoded surround information as found in Dolby Stereo films, the receiver can provide you with Dolby Pro Logic.

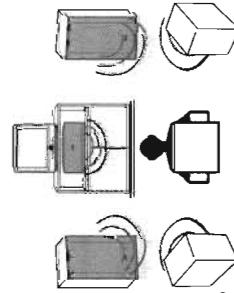

### JVC's Theater Surround

In order to reproduce a more realistic sound field in your listening room while playing soundtracks of video software bearing the mark , JVC's Theater Surround has been designed to give you clearer vocals and to create a real "being there" feeling.

## IMPORTANT:

When using the Remote Control, check to see if its remote control mode selector is set to the correct position. To operate this receiver, set it to "AUDIO/TV/VCR (except when selecting the DBS tuner as the source)".

## Using the 3D-PHONIC Modes

When using JVC's 3D-PHONIC modes, you need only two front speakers to reproduce the soundtracks of video software bearing the mark . The 3D-PHONIC modes give you a very realistic surround effect as if the sound is reproduced through the Dolby Pro Logic decoder.

### On the front panel:

1. Press DSP MODE.  
The current DSP mode appears on the display.
2. Turn MULTI JOG until the mode (3D ACTION, 3D DRAMA, or 3D THEATER) you want appears on the display, while the indication of the previous step is still on the display.  
The 3D-PHONIC, DSP and PRO LOGIC indicators also light up on the display.  
As you turn it, the DSP modes change as follows (the indicator of the DSP mode also lights up on the display):  
THEATER → LIVE CLUB → DANCE CLUB → HALL → PAVILION → DSP OFF

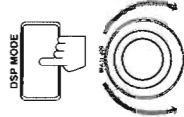

<b>3D ACTION:</b>	Best for action and war movies — where the action is fast and explosive.
<b>3D DRAMA:</b>	Best for dramas and romantic movies — where the action is slow and soft.
<b>3D THEATER:</b>	Reproduces the sound field of a large theater.
<b>DSP OFF:</b>	No DSP mode is applied.

For the other modes, see pages 36 and 39.

If you need to make any adjustment, go to the following steps.

3. Press BALANCE/SURROUND ADJUST repeatedly until "DSP EFFECT" appears on the display.  
The display changes to show the current setting.
4. Turn MULTI JOG to select the effect level, while the indication of the previous step is still on the display.  
As you turn it, the effect level changes as follows:  
DSP EFFECT 1 → DSP EFFECT 2 → DSP EFFECT 3 → DSP EFFECT 4 → DSP EFFECT 5

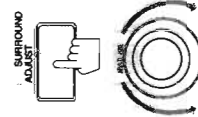

As the number increases, the selected 3D-PHONIC mode becomes stronger.

## Using the DSP Modes

5. Select and play a sound source which was processed with Dolby Surround and is labeled with  mark.

### To cancel the 3D-PHONIC mode

Turn MULTI JOG until "DSP OFF" appears in step 2. The 3D-PHONIC, DSP and PRO LOGIC indicators go off from the display.

### From the remote control:

1. Press SURROUND MODE repeatedly until the mode (3D ACTION, 3D DRAMA, or 3D THEATER) you want appears on the display. The 3D-PHONIC, DSP and PRO LOGIC indicators also light up on the display. Each time you press the button, the DSP modes change as follows (the indicator of the DSP mode also lights up on the display):



2. Press SOUND CONTROL. 10 keys are activated for sound adjustments.

3. Press EFFECT to select the effect level. Each time you press the button, the effect level changes as follows:



As the number increases, the selected 3D-PHONIC mode becomes stronger.

4. Select and play a sound source which was processed with Dolby Surround and is labeled with  mark.

### To cancel the 3D-PHONIC mode

Press SURROUND MODE repeatedly until "OFF" appears. The 3D-PHONIC, DSP and PRO LOGIC indicators go off from the display.

### Note:

Once you have adjusted the effect level, it is memorized for each 3D-PHONIC mode.

### Notes:

- When you select "DVD MULTI" as the source to play, you cannot select the 3D-PHONIC modes.
- The 3D-PHONIC mode is not used with the other DSP modes such as the Dolby Pro Logic and the DAP mode. When the 3D-PHONIC mode is turned on, the other DSP mode, if used, will be turned off.

## Using the DAP Modes

You can use five DAP modes — "Live Club, Dance Club, Hall, Pavilion, and Headphones."

Among the DAP modes, "Headphones" is very special. It can create the same stereo sound as you listen through the speakers off air while listening to a source using headphones. So, you can feel as if you were not using the headphones and listening to music in a room.

### On the front panel:

1. Press DSP MODE. The current DSP mode appears on the display.
2. Turn MULTI JOG until the mode (LIVE CLUB, DANCE CLUB, HALL, PAVILION, or HEADPHONE) you want appears on the display, while the indication of the previous step is still on the display. The DSP indicator also lights up on the display. As you turn it, the DSP modes change as follows (the indicator of the selected DSP mode also lights up on the display):



<b>LIVE CLUB:</b>	Gives the feeling of a live music club with a low ceiling.
<b>DANCE CLUB:</b>	Gives a throbbing bass beat.
<b>HALL:</b>	Gives clear vocal and the feeling of a concert hall.
<b>PAVILION:</b>	Gives the spacious feeling of a pavilion with a high ceiling.
<b>HEADPHONE:</b>	Gives a spacious stereo effect when listening with headphones.
<b>DSP OFF:</b>	No DSP mode is applied.

For the other modes, see pages 34 and 39.

If you need to make any adjustment, go to the following steps.

3. Press BALANCE/SURROUND ADJUST repeatedly until "REAR LEVEL" appears on the display. The display changes to show the current setting.
4. Turn MULTI JOG to adjust the rear speaker output level (from -10 dB to +10 dB), while the indication of the previous step is still on the display.

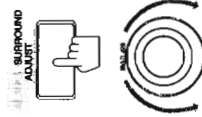

Continued to the next page.

### Notes:

- When you select "DVD MULTI" as the source to play, you cannot select the DAP modes.
- The DAP mode is not used with the other DSP modes such as the Dolby Pro Logic and 3D-PHONIC mode. When the DAP mode is turned on, the other DSP mode, if used, will be turned off.

### Note:

When you select "HEADPHONE" (the HEADPHONE indicator lights up), you cannot go to the following steps. No adjustments can be made for "HEADPHONE."

### Notes:

- You cannot adjust the left and right rear speaker output level separately.
- You cannot adjust the rear speaker level when "REAR SPK" is set to "NO" (see page 25).

5. Press **BALANCE/SURROUND ADJUST** repeatedly until "DSP EFFECT" appears on the display. The display changes to show the current setting.

6. Turn **MULTI JOG** to select the effect level, while the indication of the previous step is still on the display. As you turn it, the effect level changes as follows:

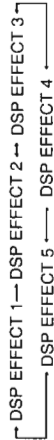

As the number increases, the selected DAP mode becomes stronger.

**To cancel the DAP mode**

Turn **MULTI JOG** until "DSP OFF" appears in step 2. The DSP indicator goes off from the display.

**SURROUND ADJUST**



**From the remote control:**

1. Press **SURROUND MODE** repeatedly. The DSP indicator also lights up.

Each time you press the button, the indicator lights up on the display as follows (the indicator lights up also):



After any adjustment, go to the following steps.

**SOUND CONTROL**

Buttons are activated for sound adjustments.



• Press **REAR\*(L) +/-** to adjust the rear speaker output level.

- Pressing **REAR\*(L) -** decreases the output level up to -10 dB.
- Pressing **REAR\*(L) +** increases the output level up to +10 dB.

4. Press **EFFECT** to select the effect level.

Each time you press the button, the effect level changes as follows:



As the number increases, the selected DAP mode becomes stronger.

**To cancel the DAP mode**

Press **SURROUND MODE** repeatedly until "OFF" appears. The DSP indicator goes off from the display.

**Notes:**

- When you select "DVD MULTI" as the source to play, you cannot select the DAP modes.
- The DAP mode is not used with the other DSP modes such as the Dolby Pro Logic and 3D-PHONIC mode. When the DAP mode is turned on, the other DSP mode, if used, will be turned off.

**Note:**

When you select "HEADPHONE" (the HEADPHONE indicator lights up), you cannot go to the following steps. No adjustments can be made for "HEADPHONE."

**Notes:**

- You cannot adjust the left and right rear speaker output level separately.
- You cannot adjust the rear speaker level when "REAR SPK" is set to "NO" (see page 25).

**Note:**

Once you have adjusted the DAP modes, the adjustment is memorized for each DAP mode.

# Using the DSP Modes

## Preparing for Surround Modes

The receiver memorizes two types of Surround modes adjustments: one for Dolby Pro Logic and the other for Theater Surround. To do the adjustment procedure, use the remote control.

### From the remote control:

1. Press **SURROUND MODE** until "PRO LOGIC" or "THEATER" appears on the display. When "PRO LOGIC" is selected, the PRO LOGIC indicator also lights up on the display. When "THEATER" is selected, the PRO LOGIC, DSP and THEATER indicators also light up on the display. Each time you press the button, the DSP modes change as follows:

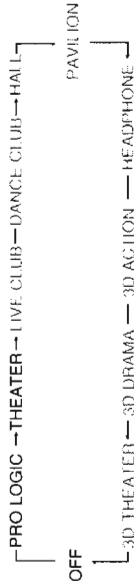

<b>PRO LOGIC:</b>	Select this mode to watch a video source with Dolby Surround.
<b>THEATER:</b>	Select this mode to watch a video source with Dolby Surround. This is JVC original surround mode and gives you the feeling of a movie theater. No DSP mode is applied.
<b>OFF:</b>	No DSP mode is applied.

For the other modes, see pages 34 and 36.

If you need to make any adjustment, go to the following steps.

2. Press **SOUND CONTROL**. 10 keys are activated for sound adjustments.
3. Press **TEST** to start checking the speaker output balance.

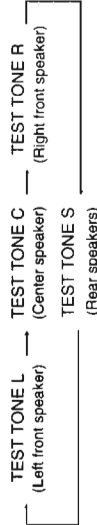
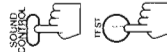

The speaker indicators also light on the display while the test tone comes out of the speakers.

- L: Lights when the test tone comes out of the left front speaker.
- C: Lights when the test tone comes out of the center speaker.
- R: Lights when the test tone comes out of the right front speaker.
- S: Lights when the test tone comes out of the rear speakers.

### Notes:

- When you select "DVD MULTI" as the source to play, you cannot select the Surround modes.
- The Surround mode is not used with the other DSP modes such as the DAP mode and 3D-PHONIC mode. When the Surround mode is turned on, the other DSP mode, if used, will be turned off.

### Notes:

- No test tone comes out of the center speaker when "CENTER SPK" is set to "NONE" (see page 24).
- No test tone comes out of the rear speakers when "REAR SPK" is set to "NO" (see page 25).

4. If necessary, adjust the speaker output level as follows:
  - To adjust the center speaker output level, press **CNTR** +/-.
  - To adjust the rear speaker output level, press **REAR**(1) +/-.

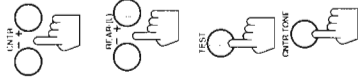

Pressing - decreases the output level up to -10 dB. Pressing + increases the output level up to +10 dB.

5. Press **TEST** again to stop the test tone.

6. Press **CNTR TONE** to select the center tone level you want.

The center tone adjustment affects the mid-frequency range, which the human voice is mostly made up of. Each time you press the button, the display changes as follows:

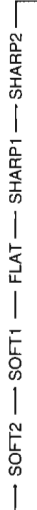

Adjusted level are also shown on the equalizer display.

This CNTR means this adjustment can be applied to the center speaker only.

(Example: When "FLAT" is selected)

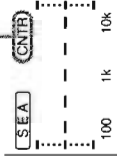

To make the dialogue clearer, select "SHARP1" (little) or "SHARP2" (much). To make the dialogue softer, select "SOFT1" (little) or "SOFT2" (much). When "FLAT" is selected, no adjustment is applied.

If you have selected Theater Surround, go to the following steps.

7. Press **EFFECT** to select the effect level. Each time you press the button, the effect level changes as follows:



As the number increases, the surround effect becomes stronger.

### Notes:

- You can adjust the speaker output levels and center tone without outputting the test tone.
- You cannot adjust the left and right rear speaker output level separately.
- You cannot adjust the center speaker level when "CENTER SPK" is set to "NONE" (see page 24).
- You cannot adjust the rear speaker level when "REAR SPK" is set to "NO" (see page 25).

### Note:

The center tone cannot be adjusted when "CENTER SPK" is set to "NONE" (see page 24).

### Note:

When you have selected Dolby Pro Logic, you cannot select the effect level.

### Note:

Once you have adjusted the Surround modes, the adjustment is memorized for each Surround mode.



## Using the DSP Modes

### On the front panel:

You can also use the buttons on the front panel to adjust the Surround modes. However, no test tone is available when using the buttons on the front panel. So, make adjustments while listening to the sound of the source played back.

#### 1. For Dolby Pro Logic:

Press **DOLBY SURROUND** so that the lamp on the button lights up and "PRO LOGIC" appears on the display.

The PRO LOGIC indicator also lights up. Each time you press the button, the Dolby Pro Logic mode turns on and off.

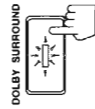

#### For Theater Surround:

##### 1. Press DSP MODE.

The current DSP mode appears on the display.

##### 2. Turn MULTI JOG until "THEATER" appears on the display, while the indication of the previous step is still on the display.

The PRO LOGIC, DSP and THEATER indicators also light up on the display.

As you turn it, the DSP modes change as follows:

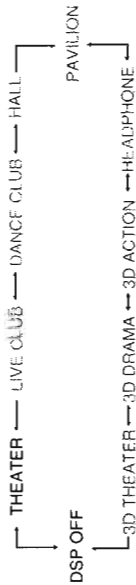

### Notes:

- When you select "DVD MULTI" as the source to play, you cannot select the Surround modes.
- The Surround mode is not used with the other DSP modes such as the DAP mode and 3D-PHONIC mode. When the Surround mode is turned on, the other DSP mode, if used, will be turned off.

#### 4. Press BALANCE/SURROUND ADJUST repeatedly until "CENTER TONE" appears on the display.

The display changes to show the current setting.

#### 5. Turn MULTI JOG to select the center tone level you want, while the indication of the previous step is still on the display.

As you turn it, the display changes to show the following:

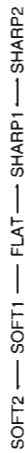

**SURROUND ADJUST**



### Note:

The center tone cannot be adjusted when "CENTER SPK" is set to "NONE" (see page 24).

If you have selected Theater Surround, go to the following steps.

#### 6. Press BALANCE/SURROUND ADJUST repeatedly until "DSP EFFECT" appears on the display.

The display changes to show the current setting.

#### 7. Turn MULTI JOG to select the effect level, while the indication of the previous step is still on the display.

As you turn it, the effect level changes as follows:



**SURROUND ADJUST**



### Note:

When you have selected Dolby Pro Logic, you cannot select the effect level.

As the number increases, the surround effect becomes stronger.

### Note:

Once you have adjusted the Surround modes, the adjustment is memorized for each Surround mode.

### Note:

You cannot adjust the center speaker level when "CENTER SPK" is set to "NONE" (see page 24).

### Notes:

- You cannot adjust the left and right rear speaker output level separately.
- You cannot adjust the rear speaker level when "REAR SPK" is set to "NO" (see page 25).



If you need to make any adjustment, go to the following steps.

#### 2. If necessary, adjust the center speaker output level as follows.

- Press BALANCE/SURROUND ADJUST repeatedly until "CENTER LEVEL" appears on the display. The display changes to show the current setting.
- Turn MULTI JOG to adjust the center speaker output level (from -10 dB to +10 dB), while the indication of the previous step is still on the display.

#### 3. If necessary, adjust the rear speaker output level as follows.

- Press BALANCE/SURROUND ADJUST repeatedly until "REAR LEVEL" appears on the display. The display changes to show the current setting.
- Turn MULTI JOG to adjust the rear speaker output level (from -10 dB to +10 dB), while the indication of the previous step is still on the display.

## Using the DSP Modes

English

### Using Surround Modes

Once you have finished adjustments for Dolby Pro Logic and Theater Surround, you can use the same adjustments every time you want to use these modes.

#### On the front panel:

- For Dolby Pro Logic:**  
Press **DOLBY SURROUND** so that the lamp on the button lights up and "PRO LOGIC" appears on the display.  
The PRO LOGIC indicator also lights up.  
Each time you press the button, the Dolby Pro Logic mode turns on and off.

**For Theater Surround:**  
1) Press **DSP MODE**.  
The current DSP mode appears on the display.
- 2) Turn **MULTI JOG** until "THEATER" appears on the display, while the indication of the previous step is still on the display.  
The PRO LOGIC, DSP and THEATER indicators also light up on the display.

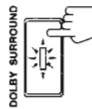

2. Select and play a sound source which was processed with Dolby Surround and is labeled with  mark.

#### To cancel the Surround mode

**For Dolby Pro Logic:** Press **DOLBY SURROUND** again so that "SURROUND OFF" appears on the display.

**For Theater Surround:** Press **DSP MODE**, then turn **MULTI JOG** until "DSP OFF" appears on the display.



#### From the remote control:

1. Press **SURROUND MODE** repeatedly until "PRO LOGIC" or "THEATER" appears on the display.  
When "PRO LOGIC" is selected, the PRO LOGIC indicator also lights up on the display.  
When "THEATER" is selected, the PRO LOGIC, DSP and THEATER indicators also light up on the display.
2. Select and play a sound source which was processed with Dolby Surround and is labeled with  mark.

#### To cancel the surround mode

Press **SURROUND MODE** repeatedly until "OFF" appears.

## Using the DVD MULTI Playback Mode

English

This receiver provides the DVD MULTI playback mode for reproducing the analog discrete output mode of the DVD player.  
Before playing back a DVD, refer also to the manual supplied with the DVD player.

### Speaker Arrangements for DVD MULTI Playback

The following illustrations show how to obtain the optimum sound environment for the DVD MULTI playback mode. Try to find the speaker direction and location to create the optimum sound field.

When you play back a disc on the DVD player with its analog discrete output mode selected:

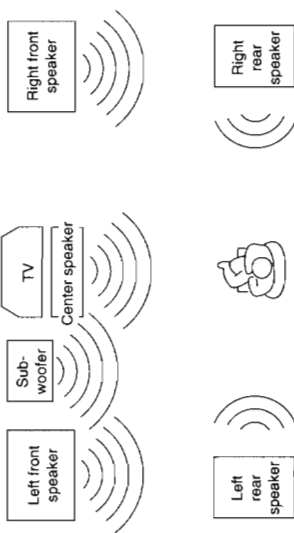

**Note:**  
You can place the subwoofer anywhere around you.

### Activating the DVD MULTI Playback

You can adjust the DVD MULTI playback mode while playing back a DVD using the analog discrete output mode on the DVD player.  
Once you made adjustments, the receiver memorizes the adjustments until you change them. You also need to set the DVD player to the analog discrete output mode.

#### On the front panel:

1. Press **DVD MULTI/2CH** so that "DVD MULTI" appears on the display. 
2. Select the analog discrete output mode on the DVD player, and start playing a DVD.
  - Refer to the manual supplied with the DVD player.

If you need to make any adjustment, go to the following steps.

3. Press **BALANCE/SURROUND ADJUST** repeatedly until "CENTER LEVEL" appears on the display. The display changes to show the current setting. 

**Note:**  
When you select "DVD MULTI" as the source to play, the DSP modes are canceled temporarily.

**Note:**  
You cannot adjust the center speaker level when "CENTER SPK" is set to "NONE" (see page 24).

Continued to the next page.

4. Turn MULTI JOG to adjust the center speaker output level (from -10 dB to +10 dB), while the indication of the previous step is still on the display.

5. Press BALANCE/SURROUND ADJUST repeatedly until "REAR L LEVEL" appears on the display. The display changes to show the current setting.

6. Turn MULTI JOG to adjust the left rear speaker output level (from -10 dB to +10 dB), while the indication of the previous step is still on the display.

7. Press BALANCE/SURROUND ADJUST repeatedly until "REAR R LEVEL" appears on the display. The display changes to show the current setting.

8. Turn MULTI JOG to adjust the right rear speaker output level (from -10 dB to +10 dB), while the indication of the previous step is still on the display.

9. Press BALANCE/SURROUND ADJUST repeatedly until "CENTER TONE" appears on the display. The display changes to show the current setting.

10. Turn MULTI JOG to select the center tone level, while the indication of the previous step is still on the display. The center tone level affects the mid-frequency range, which the human voice is mostly made up of. As you turn it, the display changes to show the following:

SOFT2 — SOFT1 — FLAT — SHARP1 — SHARP2

To make the dialogue clearer, select "SHARP1" (little) or "SHARP2" (much).  
To make the dialogue softer, select "SOFT1" (little) or "SOFT2" (much).  
When "FLAT" is selected, no adjustment is applied.

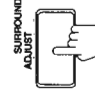
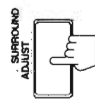

**IMPORTANT:**

When using the Remote Control, check to see if its remote control mode selector is set to the correct position. To operate this receiver, set it to "AUDIO/TV/VCR (except when selecting the DBS tuner as the source)."

**From the remote control:**

1. Press DVD MULTI so that "DVD MULTI" appears on the display. Each time you press the button, the source alternates between "DVD" and "DVD MULTI."



2. Select the analog discrete output mode on the DVD player, and start playing a DVD. Refer to the manual supplied with the DVD player.

If you need to make any adjustment, go to the following steps.

3. Press SOUND CONTROL. 10 keys are activated for adjusting the sound.



4. Press CNTR +/- to adjust the center speaker output level.

- Pressing CNTR - decreases the output level up to -10 dB.
- Pressing CNTR + increases the output level up to +10 dB.



5. Press REAR\*(L) +/- to adjust the left rear speaker output level.

- Pressing REAR\*(L) - decreases the output level up to -10 dB.
- Pressing REAR\*(L) + increases the output level up to +10 dB.



6. Press (REAR\*R) +/- to adjust the right rear speaker output level.

- Pressing (REAR\*R) - decreases the output level up to -10 dB.
- Pressing (REAR\*R) + increases the output level up to +10 dB.



7. Press CENTER TONE to select the center tone level. Each time you press the button, the display changes to show the following:



SOFT2 — SOFT1 — FLAT — SHARP1 — SHARP2

To make the dialogue clearer, select "SHARP1" (little) or "SHARP2" (much).  
To make the dialogue softer, select "SOFT1" (little) or "SOFT2" (much).  
When "FLAT" is selected, no adjustment is applied.

**Note:**  
You cannot adjust the center speaker level when "CENTER SPK" is set to "NONE" (see page 24).

**Note:**  
You cannot adjust the left rear speaker level when "REAR SPK" is set to "NO" (see page 25).

**Note:**  
You cannot adjust the right rear speaker level when "REAR SPK" is set to "NO" (see page 25).

**Note:**  
The center tone cannot be adjusted when "CENTER SPK" is set to "NONE" (see page 24).

## Using the On-Screen Menus

You can use the Menus on the TV screen to control the receiver. To use this function, you need to connect the TV to the MONITOR OUT jack on the rear panel (see page 15), and set the TV's input mode to the proper position to which the receiver is connected.

### ■ Selecting the Source to Play (Also see page 20)

1. Press any button of ON SCREEN CONTROL  $\Delta / \nabla / \triangleleft / \triangleright$  once. The MAIN MENU appears on the TV.

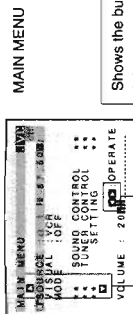

Shows the buttons you can use on the current menu. In this case, use  $\Delta / \nabla$  to move  $\square$  up and down, and  $\triangleleft / \triangleright$  to select, adjust or set the item.

2. Press ON SCREEN CONTROL  $\Delta / \nabla$  to move  $\square$  to "SOURCE."
3. Press ON SCREEN CONTROL  $\triangleleft / \triangleright$  to select the source.
4. When you finish, press EXIT. The menu disappears from the TV.

### ■ Selecting the Different Sources for Picture and Sound

You can view the pictures played back on a video component while listening to any source.

1. Press any button of ON SCREEN CONTROL  $\Delta / \nabla / \triangleleft / \triangleright$  once. The MAIN MENU appears on the TV.
2. Press ON SCREEN CONTROL  $\Delta / \nabla$  to move  $\square$  to "VISUAL."
3. Press ON SCREEN CONTROL  $\triangleleft / \triangleright$  to select a different video source.
  - When you select "OSD," see page 56.
4. When you finish, press EXIT. The menu disappears from the TV.

### ■ Using the DSP Modes (Also see pages 34, 36, and 39)

1. Press any button of ON SCREEN CONTROL  $\Delta / \nabla / \triangleleft / \triangleright$  once. The MAIN MENU appears on the TV.
2. Press ON SCREEN CONTROL  $\Delta / \nabla$  to move  $\square$  to "MODE."
3. Press ON SCREEN CONTROL  $\triangleleft / \triangleright$  to select the DSP mode you want to use.
4. When you finish, press EXIT. The menu disappears from the TV.

#### Notes:

- If your TV is not of the PAL color system, the TV screen will be distorted.
- The on-screen display will disappear if no operation is done for about 1 minute.

### ■ Adjusting the Front Speaker Output Balance (Also see page 23)

1. Press any button of ON SCREEN CONTROL  $\Delta / \nabla / \triangleleft / \triangleright$  once. The MAIN MENU appears on the TV.
2. Press ON SCREEN CONTROL  $\Delta / \nabla$  to move  $\square$  to "SOUND CONTROL," then press  $\triangleleft / \triangleright$ . The SOUND CONTROL menu appears on the TV.
3. Press ON SCREEN CONTROL  $\Delta / \nabla$  to move  $\square$  to "BAL." (Balance).
4. Press ON SCREEN CONTROL  $\triangleleft / \triangleright$  to adjust the balance.
5. When you finish, press EXIT repeatedly until the menu disappears from the TV.

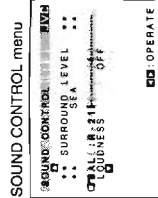
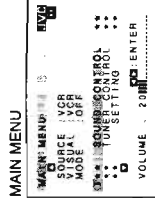

### ■ Listening at Low Volume (Loudness) (Also see page 23)

1. Press any button of ON SCREEN CONTROL  $\Delta / \nabla / \triangleleft / \triangleright$  once. The MAIN MENU appears on the TV.
2. Press ON SCREEN CONTROL  $\Delta / \nabla$  to move  $\square$  to "SOUND CONTROL," then press  $\triangleleft / \triangleright$ . The SOUND CONTROL menu appears on the TV.
3. Press ON SCREEN CONTROL  $\Delta / \nabla$  to move  $\square$  to "LOUDNESS."
4. Press ON SCREEN CONTROL  $\triangleleft / \triangleright$  to turn the loudness "ON" or "OFF."
5. When you finish, press EXIT repeatedly until the menu disappears from the TV.

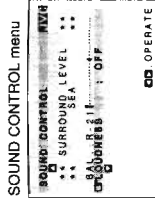

### ■ Adjusting the DSP Modes (Also see pages 34, 36, and 39)

1. Press any button of ON SCREEN CONTROL  $\Delta / \nabla / \triangleleft / \triangleright$  once. The MAIN MENU appears on the TV.
2. Press ON SCREEN CONTROL  $\Delta / \nabla$  to move  $\square$  to "MODE."
3. Press ON SCREEN CONTROL  $\triangleleft / \triangleright$  to select the DSP mode you want to adjust.
4. Press ON SCREEN CONTROL  $\Delta / \nabla$  to move  $\square$  to "SOUND CONTROL," then press  $\triangleleft / \triangleright$ . The SOUND CONTROL menu appears.
5. Press ON SCREEN CONTROL  $\Delta / \nabla$  to move  $\square$  to "SURROUND LEVEL," then press  $\triangleleft / \triangleright$ . The SURROUND LEVEL menu appears.

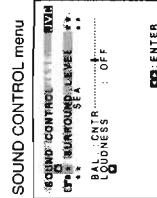

#### Note:

If you select "HEADPHONE" in step 3, the SURROUND LEVEL menu will not appear.

Continued to the next page.

6. Press ON SCREEN CONTROL  $\Delta/\nabla$  to move  $\overline{\text{C}}$  to the item you want to set or adjust, then press ON SCREEN CONTROL  $\triangleleft/\triangleright$ .  
On these adjustment menus, you can do the following:

**For 3D-Phonic modes:**

- "DSP EFFECT": Select the effect level.
- For DAP modes (LIVE CLUB, DANCE CLUB, HALL, PAVILION):**
- "REAR LEVEL": Adjust the rear speaker output level. \*
- "DSP EFFECT": Select the effect level.

**For Dolby Pro Logic surround mode:**

- "TEST TONE": Output a test tone.
- "CENTER LEVEL": Adjust the center speaker output level. \*\*
- "REAR LEVEL": Adjust the rear speaker output level. \*
- "CENTER TONE": Select the center tone level. \*\*

**For Theater surround mode:**

- "TEST TONE": Output a test tone.
- "CENTER LEVEL": Adjust the center speaker output level. \*\*
- "REAR LEVEL": Adjust the rear speaker output level. \*
- "CENTER TONE": Select the center tone level. \*\*
- "DSP EFFECT": Select the effect level. \*

**For DVD MULTI playback mode:**

- "CENTER LEVEL": Adjust the center speaker output level.
- "REAR L LEVEL": Adjust the left rear speaker output level.
- "REAR R LEVEL": Adjust the right rear speaker output level.
- "CENTER TONE": Select the center tone level.

7. When you finish, press EXIT repeatedly until the menu disappears from the TV.

**■ Selecting Your Favorite SEA Mode** (Also see page 31)

1. Press any button of ON SCREEN CONTROL  $\Delta/\nabla/\triangleleft/\triangleright$  once.  
The MAIN MENU appears on the TV.
2. Press ON SCREEN CONTROL  $\Delta/\nabla$  to move  $\overline{\text{C}}$  to "SOUND CONTROL," then press  $\triangleleft/\triangleright$ .  
The SOUND CONTROL menu appears.
3. Press ON SCREEN CONTROL  $\Delta/\nabla$  to move  $\overline{\text{C}}$  to "SEA," then press  $\triangleleft/\triangleright$ .  
The SEA menu appears.
4. Press ON SCREEN CONTROL  $\Delta/\nabla$  to move  $\overline{\text{C}}$  to "SEA MODE,"
5. Press ON SCREEN CONTROL  $\triangleleft/\triangleright$  to select the SEA mode you want.
6. When you finish, press EXIT repeatedly until the menu disappears from the TV.

Example:  
SURROUND LEVEL menu  
for Theater surround

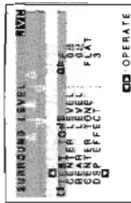

**Notes:**

- \* Not displayed when "REAR SPK" is set to "NO" (see page 25).
- \*\* Not displayed when "CENTER SPK" is set to "NONE" (see page 24).

1. Press any button of ON SCREEN CONTROL  $\Delta/\nabla/\triangleleft/\triangleright$  once.  
The MAIN MENU appears on the TV.
2. Press ON SCREEN CONTROL  $\Delta/\nabla$  to move  $\overline{\text{C}}$  to "SOUND CONTROL," then press  $\triangleleft/\triangleright$ .  
The SOUND CONTROL menu appears.
3. Press ON SCREEN CONTROL  $\Delta/\nabla$  to move  $\overline{\text{C}}$  to "SEA," then press  $\triangleleft/\triangleright$ .  
The SEA menu appears.
4. Press ON SCREEN CONTROL  $\Delta/\nabla$  to move  $\overline{\text{C}}$  to "SEA ADJUST," then press  $\triangleleft/\triangleright$ .  
The SEA ADJUST menu appears.
5. Press ON SCREEN CONTROL  $\Delta/\nabla/\triangleleft/\triangleright$  to adjust the SEA mode as you want.  
 $\triangleleft/\triangleright$ : Select the frequency ranges.  
 $\Delta/\nabla$ : Adjust the frequency levels.
6. Press SET to store the setting into the SEA USERMODE.  
\* If you press EXIT, without pressing SET in this step, you can return to the SEA menu. (The adjustment you have made is active but not stored.)
7. When you finish, press EXIT repeatedly until the menu disappears from the TV.

**■ Setting the Center Speaker Size** (Also see page 24)

1. Press any button of ON SCREEN CONTROL  $\Delta/\nabla/\triangleleft/\triangleright$  once.  
The MAIN MENU appears on the TV.
2. Press ON SCREEN CONTROL  $\Delta/\nabla$  to move  $\overline{\text{C}}$  to "SETTING," then press  $\triangleleft/\triangleright$ .  
The SETTING menu appears.
3. Press ON SCREEN CONTROL  $\Delta/\nabla$  to move  $\overline{\text{C}}$  to "CENTER SPK" (Center Speaker Size).
4. Press ON SCREEN CONTROL  $\triangleleft/\triangleright$  repeatedly until the appropriate center speaker size is selected.
5. When you finish, press EXIT repeatedly until the menu disappears from the TV.

MAIN MENU



SOUND CONTROL menu

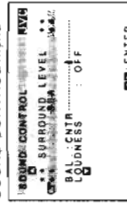

SEA menu



SEA ADJUST menu



SETTING menu



**■ Setting the Rear Speaker** (Also see page 25)

1. Press any button of ON SCREEN CONTROL  $\Delta/\nabla/\triangleleft/\triangleright$  once. The MAIN MENU appears on the TV.
  2. Press ON SCREEN CONTROL  $\Delta/\nabla$  to move  $\triangleleft$  to "SETTING," then press  $\triangleleft/\triangleright$ . The SETTING menu appears.
  3. Press ON SCREEN CONTROL  $\Delta/\nabla$  to move  $\triangleleft$  to "REAR SPK" (Rear Speaker).
  4. Press ON SCREEN CONTROL  $\triangleleft/\triangleright$  to set your rear speakers.
  5. When you finish, press EXIT repeatedly until the menu disappears from the TV.
- Setting the Delay Time** (Also see page 25)
1. Press any button of ON SCREEN CONTROL  $\Delta/\nabla/\triangleleft/\triangleright$  once. The MAIN MENU appears on the TV.
  2. Press ON SCREEN CONTROL  $\Delta/\nabla$  to move  $\triangleleft$  to "SETTING," then press  $\triangleleft/\triangleright$ . The SETTING menu appears.
  3. Press ON SCREEN CONTROL  $\Delta/\nabla$  to move  $\triangleleft$  to "DELAY TIME."
  4. Press ON SCREEN CONTROL  $\triangleleft/\triangleright$  to set the delay time of the rear speaker sound.
  5. When you finish, press EXIT repeatedly until the menu disappears from the TV.



SETTING menu

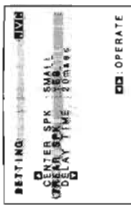

SETTING menu

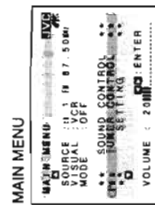

TUNER CONTROL menu



Note:

• Not displayed when an AM station is selected.

**■ Storing the Preset Stations** (Also see page 28)

1. Press any button of ON SCREEN CONTROL  $\Delta/\nabla/\triangleleft/\triangleright$  once. The MAIN MENU appears on the TV.
2. Press ON SCREEN CONTROL  $\Delta/\nabla$  to move  $\triangleleft$  to "TUNER CONTROL," then press  $\triangleleft/\triangleright$ . The TUNER CONTROL menu appears.
3. Tune into a station on the TUNER CONTROL menu, referring to "Operating the Tuner".
4. Press ON SCREEN CONTROL  $\Delta/\nabla$  to move  $\triangleleft$  to "PRESET MEMORY," then press  $\triangleleft/\triangleright$ . The PRESET MEMORY menu appears.
5. Press ON SCREEN CONTROL  $\Delta/\nabla$  to move  $\triangleleft$  to "PRESET CH."
6. Press ON SCREEN CONTROL  $\triangleleft/\triangleright$  to select a preset station number you want.
7. Press SET to store the setting.
8. When you finish, press EXIT repeatedly until the menu disappears from the TV.



TUNER CONTROL menu



PRESET MEMORY menu



**■ Assigning Names to the Preset Stations** (Also see page 30)

1. Press any button of ON SCREEN CONTROL  $\Delta/\nabla/\triangleleft/\triangleright$  once. The MAIN MENU appears on the TV.
2. Press ON SCREEN CONTROL  $\Delta/\nabla$  to move  $\triangleleft$  to "TUNER CONTROL," then press  $\triangleleft/\triangleright$ . The TUNER CONTROL menu appears.
3. Press ON SCREEN CONTROL  $\Delta/\nabla$  to move  $\triangleleft$  to "PRESET CH."
4. Press ON SCREEN CONTROL  $\triangleleft/\triangleright$  to select a preset station.
5. Press ON SCREEN CONTROL  $\Delta/\nabla$  to move  $\triangleleft$  to "PRESET MEMORY," then press  $\triangleleft/\triangleright$ . The PRESET MEMORY menu appears.
6. Press ON SCREEN CONTROL  $\Delta/\nabla$  to move  $\triangleleft$  to "PRESET NAME," then press SET. The character entry screen appears.

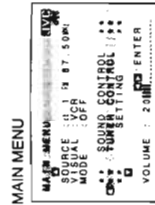

TUNER CONTROL menu



PRESET MEMORY menu



Continued to the next page.



## TEXT COMPU LINK Remote Control System

The TEXT COMPU LINK remote control system has been newly developed to deal with the disc information recorded in the CD Text\* and MDs. Using these information in the discs, you can operate the CD player or MD recorder equipped with the TEXT COMPU LINK remote control system through the receiver.

### CONNECTIONS:

To use this remote control system, you need to connect the CD player and/or MD recorder you want to operate, following the procedures below.

- If you have already plugged your CD player, MD recorder, and this receiver into the AC outlets, unplug their AC power cords first.
- Connect your CD player, MD recorder, and this receiver as follows, through the COMPU LINK-3 (SYNCHRO) jacks and TEXT COMPU LINK jacks.

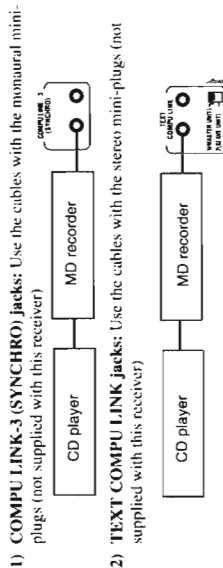

### IMPORTANT:

Set the Master/Slave Selector on the rear to "1(MASTER UNIT)," "2(SLAVE UNIT)" is just for the serviceman's use. The TEXT COMPU LINK remote control system does not function with the selector set to "2(SLAVE UNIT)."

- Connect your CD player, MD recorder and this receiver, using the cables with RCA pin plugs (see page 14).

- Plug the AC power cords of these components above into the AC outlets.

- When turning on these components for the first time, turn on the connected components first, then turn on this receiver.

### FUNCTIONS:

This remote control system allows you to use the functions listed below.

#### Displaying the Disc Information on the TV screen

Disc information such as its performer and disc title (and track titles, only when a CD Text is selected) is shown on the TV screen.

#### Disc Search: Only for CD Player

This remote control system can allow you to search discs by the performer, disc title, and music genre. With this disc search, you can easily find the disc you want to play.

#### Additional Functions:

- If your CD player has the User File function, you can select a disc from the groups.
- \* A "user file" is a group of the discs you make as you like on the CD player.
- If your CD player has the disc memory function, you can input the performer, disc title, and music genre about these normal audio CDs on the TV screen.

### OPERATIONS

To use this remote control system, you need to connect the TV to the MONITOR OUT jack on the rear panel (see page 15), and set the TV's input mode to the proper position to which the receiver is connected. **Make sure you have connected the CD player or MD recorder equipped with the TEXT COMPU LINK remote control system. If not, you cannot use the following functions.**

#### Showing the Disc Information on the TV Screen

- Press any button of ON SCREEN CONTROL  $\Delta$  /  $\nabla$  /  $\triangleleft$  /  $\triangleright$  once. The MAIN MENU appears on the TV.
- Press ON SCREEN CONTROL  $\Delta$  /  $\nabla$  to move (  $\uparrow$  to "SOURCE.")
- Press ON SCREEN CONTROL  $\triangleleft$  /  $\triangleright$  to select "CD" or "MD."
- Press ON SCREEN CONTROL  $\Delta$  /  $\nabla$  to move (  $\uparrow$  to "VISUAL.")
- Press ON SCREEN CONTROL  $\triangleleft$  /  $\triangleright$  to select "OSD," then press EXIT. The Disc Information screen appears on the TV.

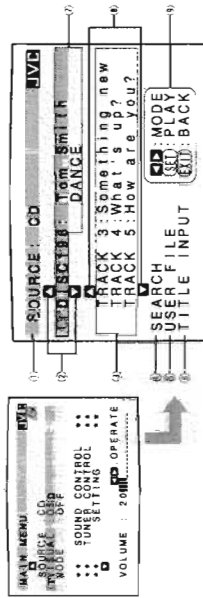

① Source name: CD or MD

② Select  $\Delta$  or  $\nabla$  then press SET to change the disc.

③ Track numbers and track titles.

- The current playing (selected) track is indicated in yellow.
- When you move (  $\uparrow$  ) to a track number, you can change the track information by pressing  $\triangleleft$  /  $\triangleright$ . Each time you press the button, track information alternates between its track title and its performer. (You can also start playing the track by pressing SET)

- Select this (move  $\uparrow$  in front), then press SET to go to the DISK SEARCH screen (see page 57).
- Select this (move  $\uparrow$  in front), then press SET to go to the USER FILE screen (see page 59).
- Select this (move  $\uparrow$  in front), then press SET to go to the TITLE INPUT screen (see page 60).

(7) Disc information such as the disc title, performer, and music genre. When this is selected (  $\uparrow$  in front ), you can change the disc information by pressing  $\triangleleft$  /  $\triangleright$ . Each time you press the button, disc information (see the note) changes.

(8) Select  $\Delta$  or  $\nabla$  then press SET to change the track.

(9) Usable buttons and their functions for the current selection.

Indication here will be changed what is currently selected (  $\uparrow$  in front) on the screen.

- When you finish, press EXIT repeatedly until the MAIN MENU appears on the TV.

#### To exit from the MAIN MENU:

- Press ON SCREEN CONTROL  $\Delta$  /  $\nabla$  to move (  $\uparrow$  to "VISUAL.")
- Press ON SCREEN CONTROL  $\triangleleft$  /  $\triangleright$  to select any one other than "OSD," then press EXIT.

### Notes:

- The on-screen display will not appear about one minute after the power is turned on.
- The on-screen display will disappear in the following case:
  - If no operation is done for about 10 minutes.
  - If you do any operation other than explained in this section.
- To control the MD recorder using the TEXT COMPU LINK remote control system, you have to change the source name shown on the display from "TAPE" to "MD." (See page 23.)
- The number of characters to show the disc information such as the disc title or track title is limited to 32. So if the disc title, for example, is longer than 32 characters only the first 32 characters are shown.
- Some special characters such as accented letters cannot be displayed correctly.

### Note on (7):

The following information will appear on the display:

- Disc title
- Performer
- Genre
- Song writer
- Composer
- Arranger
- Message

Only recorded information will be shown. If there is no data, "NO DATA" will appear.

### Note on (9):

For example, the SET button will be used to start play (PLAY), to go to the next screen (ENTER), and to determine the selection (ENTER).



**■ Searching a Disc (Only for the CD player)**

**Search a disc by its performer:**

1. Display the disc information screen by following the procedure on page 56.
2. Press ON SCREEN CONTROL  $\Delta/\nabla$  to move  $\underline{\text{C}}$  to "SEARCH," then press SET.  
The DISC SEARCH screen appears on the TV.
3. Press ON SCREEN CONTROL  $\Delta/\nabla$  to move  $\underline{\text{C}}$  to "PERFORMER", then press SET.  
The PERFORMER SEARCH screen appears.
4. Press ON SCREEN CONTROL  $\Delta/\nabla/\leftarrow/\rightarrow$  to move  $\underline{\text{C}}$  in front of the first character of the performer you want to search, then press SET.  
To correct the incorrect entry, press ON SCREEN CONTROL  $\Delta/\nabla$  to move  $\underline{\text{C}}$  in front of the correct character, then press SET.  
To erase the incorrect entry, press ON SCREEN CONTROL  $\Delta/\nabla$  to move  $\underline{\text{C}}$  to CANCEL, then press SET.

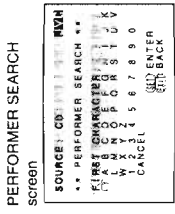
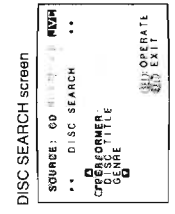

5. Press SET again.  
Disc search starts, then the SEARCH RESULT screen, showing the performers, appears.
6. On the SEARCH RESULT screen, you can do the following:
  - Changing the indication of the disc information: Press ON SCREEN CONTROL  $\Delta/\nabla$  to move  $\underline{\text{C}}$  to a searched disc, then press  $\leftarrow/\rightarrow$ . Each time you press  $\leftarrow/\rightarrow$ , the disc information alternates between its disc title.
  - Going to the Disc Information screen (see page 56): Press ON SCREEN CONTROL  $\Delta/\nabla$  to move  $\underline{\text{C}}$  to a searched disc, then press SET.
  - Showing unseen disc information (if more than 5 discs are listed as a result of the search): Press ON SCREEN CONTROL  $\Delta/\nabla$  to move  $\underline{\text{C}}$  to  $\square$  (or  $\square$ ), then press SET.
  - Going back to the PERFORMER SEARCH screen: Press EXIT.

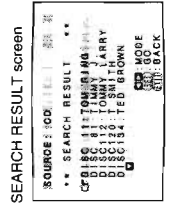

**Note:**  
Symbols such as @, # or \$ cannot be available for search.

**Search a disc by its disc title:**

1. Display the disc information screen by following the procedure on page 56.
2. Press ON SCREEN CONTROL  $\Delta/\nabla$  to move  $\underline{\text{C}}$  to "SEARCH," then press SET.  
The DISC SEARCH screen appears on the TV.
3. Press ON SCREEN CONTROL  $\Delta/\nabla$  to move  $\underline{\text{C}}$  to "DISC TITLE", then press SET.  
The DISC TITLE SEARCH screen appears.
4. Press ON SCREEN CONTROL  $\Delta/\nabla/\leftarrow/\rightarrow$  to move  $\underline{\text{C}}$  in front of the first character of the disc title you want to search, then press SET.  
To correct the incorrect entry, press ON SCREEN CONTROL  $\Delta/\nabla$  to move  $\underline{\text{C}}$  in front of the correct character, then press SET.  
To erase the incorrect entry, press ON SCREEN CONTROL  $\Delta/\nabla$  to move  $\underline{\text{C}}$  to CANCEL, then press SET.

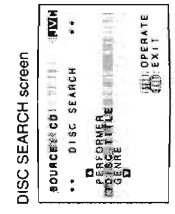

5. Press SET again.  
Disc search starts, then the SEARCH RESULT screen, showing the disc titles, appears.
6. On the SEARCH RESULT screen, you can do the following:
  - Changing the indication of the disc information: Press ON SCREEN CONTROL  $\Delta/\nabla$  to move  $\underline{\text{C}}$  to a searched disc, then press  $\leftarrow/\rightarrow$ . Each time you press  $\leftarrow/\rightarrow$ , the disc information alternates between its disc title and its performer.
  - Going to the Disc Information screen (see page 56): Press ON SCREEN CONTROL  $\Delta/\nabla$  to move  $\underline{\text{C}}$  to a searched disc, then press SET.
  - Showing unseen disc information (if more than 5 discs are listed as a result of the search): Press ON SCREEN CONTROL  $\Delta/\nabla$  to move  $\underline{\text{C}}$  to  $\square$  (or  $\square$ ), then press SET.
  - Going back to the DISC TITLE SEARCH screen: Press EXIT.

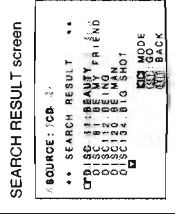

**Note:**  
Symbols such as @, # or \$ cannot be available for search.

**Search a disc by its genre:**

1. Display the disc information screen by following the procedure on page 56.
2. Press ON SCREEN CONTROL  $\Delta/\nabla$  to move  $\underline{\text{C}}$  to "SEARCH," then press SET.  
The DISC SEARCH screen appears on the TV.
3. Press ON SCREEN CONTROL  $\Delta/\nabla$  to move  $\underline{\text{C}}$  to "GENRE", then press SET.  
The GENRE SEARCH screen appears.
4. Press ON SCREEN CONTROL  $\Delta/\nabla$  to move  $\underline{\text{C}}$  to the genre you want to search, then press SET.  
To show the unseen genres, press ON SCREEN CONTROL  $\Delta/\nabla$  until they appear.  
Disc search starts, then the SEARCH RESULT screen, showing the disc titles, appears.



**On the SEARCH RESULT screen, you can do the following:**

- Changing the indication of the disc information: Press ON SCREEN CONTROL  $\Delta/\nabla$  to move  $\underline{\text{C}}$  to a searched disc, then press  $\leftarrow/\rightarrow$ . Each time you press  $\leftarrow/\rightarrow$ , the disc information alternates between its disc title and its performer.
- Going to the Disc Information screen (see page 56): Press ON SCREEN CONTROL  $\Delta/\nabla$  to move  $\underline{\text{C}}$  to a searched disc, then press SET.
- Showing unseen disc information (if more than 5 discs are listed as a result of the search): Press ON SCREEN CONTROL  $\Delta/\nabla$  to move  $\underline{\text{C}}$  to  $\square$  (or  $\square$ ), then press SET.
- Going back to the GENRE SEARCH screen: Press EXIT.



## TEXT COMPU LINK Remote Control System

- Press ON SCREEN CONTROL  $\Delta$  /  $\nabla$  /  $\leftarrow$  /  $\rightarrow$  to move  $\square$  to "DISC1: MY FAVORITE (in this example)," then press SET. The TITLE INPUT: DISC 1 GENRE screen appears.
- Press ON SCREEN CONTROL  $\Delta$  /  $\nabla$  to move  $\square$  to the genre you want, then press SET. The Disc Information screen appears again.
- To show the unseen genres, press ON SCREEN CONTROL  $\Delta$  /  $\nabla$  until they appear.

### For the MD recorder:

- You can write the disc information (disc title and song titles) into the disc. You can only write the song title for the song currently selected.
- If you have the CD-MD combination deck, you can also enter the disc information (its performer, disc title, and its music genre) of normal audio CDs into the memory built in the CD-MD combination deck. (To do this, follow the procedure on page 60.)
- Display the disc information screen by following the procedure on page 56.
  - Press ON SCREEN CONTROL  $\Delta$  /  $\nabla$  to move  $\square$  to "TITLE INPUT," then press SET. The DISC TITLE INPUT screen appears on the TV.
  - Enter the title, referring to steps 3 and 4 on page 60.
    - You can enter up to 32 character for the disc title.
  - Press ON SCREEN CONTROL  $\Delta$  /  $\nabla$  /  $\leftarrow$  /  $\rightarrow$  to move  $\square$  to the disc title you have just entered, then press SET. The disc title is stored into the memory, and the SONG TITLE: INPUT screen for the currently selected song appears.
    - You can enter a song title for the song currently selected (indicated in yellow on the TV screen).
  - Enter the song title, referring to steps 3 and 4 on page 60.
    - You can enter up to 32 character for the song title.
  - Press ON SCREEN CONTROL  $\Delta$  /  $\nabla$  /  $\leftarrow$  /  $\rightarrow$  to move  $\square$  to the song title you have just entered, then press SET. The song title is stored into the memory, and the Disc Information screen appears again.

## Operating JVC's Audio/Video Components

You can operate JVC's audio and video components with this receiver's remote control, since control signals for JVC components are preset in the remote control.

### IMPORTANT:

- To operate JVC's audio components using this remote control:
- You need to connect JVC audio components through the COMPU LINK-3 (SYNCHRO) jacks (see page 54) in addition to the connections using cables with RCA pin plugs (see page 14).
  - Aim the remote control directly at the remote sensor on the receiver.

### Tuner

After pressing FM/AM (with the remote control mode selector set to "AUDIO/TV/VCR"), you can perform the following operations:

- FM/AM:** Alternates between FM and AM.  
**I — 10, +10:** Selects a preset channel number directly. For channel number 5, press 5. For channel number 15, press +10, then 5. For channel number 20, press +10, then 10.

### TUNING UP/TUNING DOWN:

Tunes into stations.  
**FM MODE/MUTE:** Changes the FM reception mode.

### Sound control section (Amplifier)

You can always perform the following operations (with the remote control mode selector set to "AUDIO/TV/VCR"):

**SEA MODE:** Changes the SEA modes.  
**SURROUND MODE:** Changes the DSP modes.

After pressing SOUND CONTROL (with the remote control mode selector set to "AUDIO/TV/VCR"), you can perform the following operations:

- CNTR +/-:** Adjusts the center speaker output level for the Surround/DVD MULTI playback modes.  
**REAR-(L) +/-:** Adjusts the left rear speaker output level for the DVD MULTI playback mode.  
**(REAR-R) +/-:** Adjusts the right rear speaker output level for the DVD MULTI playback mode.  
**DELAY:** Selects the delay time of the rear speaker sound.  
**EFFECT:** Selects the effect level for the DSP modes.  
**TEST:** Turns on or off the test tone output for the Surround mode.  
**CNTR TONE:** Selects the center tone level for the Surround/DVD MULTI playback modes.

### CD player

After pressing CD (with the remote control mode selector set to "AUDIO/TV/VCR"), you can perform the following operations on a CD player:

- PLAY:** Starts playing.  
 $\leftarrow$  **RECALL:** Returns to the beginning of the current (or previous) track.  
 $\rightarrow$  **SKIP:** Skips to the beginning of the next track.  
**STOP:** Stops playing.  
**PAUSE:** Pauses playing. To release it, press PLAY.  
**I — 10, +10:** Selects a track number directly. For track number 5, press 5. For track number 15, press +10, then 5. For track number 20, press +10, then 10. For track number 30, press +10, +10, then 10.

### Notes:

- If you use the buttons on the front panel or the menu function to choose a source, the remote control will not operate that source. To operate a source with the remote control, the source must be selected using buttons on the remote control.
- Check to see if its remote control mode selector is set to the correct position. To operate audio system, TV's, and VCR's, set it to "AUDIO/TV/VCR."
- Refer also to the manuals supplied with your components.

### Note:

After adjusting sounds, press the corresponding source selecting button or CD DISC to operate your target source by using 10 keys; otherwise, 10 keys cannot be used for operating your target source.

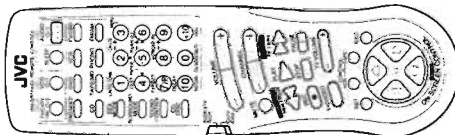

# Operating JVC's Audio/Video Components

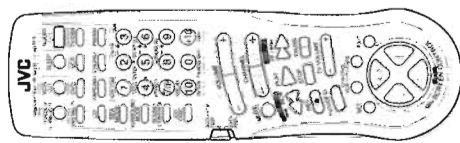

**CD player-changer**  
After pressing CD DISC (with the remote control mode selector set to "AUDIO/TV/VCR"), you can perform the following operations on a CD player-changer:

- ▶▶▶: Starts playing.
- ◀◀◀: Returns to the beginning of the current (or previous) track.
- ▶▶▶: Skips to the beginning of the next track.
- STOP:** Stops playing.
- PAUSE:** Pauses playing. To release it, press the PLAY button.
- 1 — 6, 7/P:** Select the number of a disc installed in a CD player-changer.

After pressing PHONO (with the remote control mode selector set to "AUDIO/TV/VCR"), you can perform the following operations on a turntable:

- 1 — 10, +10:** Selects a track number directly.  
For track number 5, press 5. For track number 15, press +10, then 5. For track number 20, press +10, then 10. For track number 30, press +10, +10, then 10.

**Turntable**

After pressing PHONO (with the remote control mode selector set to "AUDIO/TV/VCR"), you can perform the following operations on a turntable:

- PLAY:** Starts playing.
- STOP:** Stops playing.

**Cassette deck**

After pressing TAPE/MD or TAPE CONTROL (with the remote control mode selector set to "AUDIO/TV/VCR"), you can perform the following operations on a cassette deck:

- PLAY:** Starts playing.
- REW:** Fast winds the tape from right to left.
- FF:** Fast winds the tape from left to right.
- STOP:** Stops operations.
- PAUSE:** Pauses playing or recording temporarily. To release it, press the PLAY button. Press this button with the PLAY button to start recording.
- REC ●:** Press this button with the PAUSE button to enter recording pause.

**MD recorder**

After pressing TAPE/MD or TAPE CONTROL (with the remote control mode selector set to the "AUDIO/TV/VCR" position), you can perform the following operations on the MD recorder:

- PLAY:** Starts playing.
- ◀◀◀: Returns to the beginning of the current (or previous) track.
- ▶▶▶: Skips to the beginning of the next track.
- STOP:** Stops playing.
- PAUSE:** Pauses playing. To release it, press the PLAY button.
- REC ●:** Press this button with the PLAY button to start recording. Press this button with the PAUSE button to enter recording pause.

**IMPORTANT:**  
To operate JVC's video components using this remote control:

- Aim the remote control directly at the remote sensor on the VCR, DVD player or TV, not on the receiver.
- Some JVC VCRs can accept two types of the control signals — remote code "A" and "B." Before using this remote control, make sure that the remote control code of the VCR connected to the VCR jacks is set to code "A."

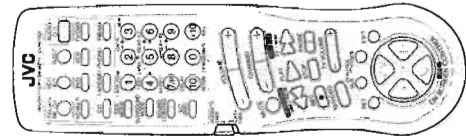

**VCR**  
You can always perform the following operations (with the remote control mode selector set to "AUDIO/TV/VCR");

- VCR 0/1:** Turns on or off the VCR.

After pressing VCR or VCR CONTROL (with the remote control mode selector set to "AUDIO/TV/VCR"), you can perform the following operations on the VCR:

- PLAY:** Starts playing.
- REW:** Rewinds a tape.
- FF:** Fast winds a tape.
- STOP:** Stops operations.
- PAUSE:** Pauses playing or recording temporarily. To release it, press the PLAY button.
- REC ●:** Press this button with the PAUSE button to start recording.

Press this button with the PAUSE button to enter recording pause.

- CHANNEL +/-:** Changes the channels on the VCR.
- 1 — 9, 0:** Selects the channels on the VCR.  
For channel 5, press 5.  
For channel 10, press 1, then 0.

**DVD player**

After pressing DVD or DVD MULTI (with the remote control mode selector set to "AUDIO/TV/VCR"), you can perform the following operations on a DVD player:

- PLAY:** Starts playing.
- ◀◀◀: Returns to the beginning of the current (or previous) track.
- ▶▶▶: Skips to the beginning of the next track.
- STOP:** Stops playing.
- PAUSE:** Stops playing temporarily. To release it, press the PLAY button.

**TV**

You can always perform the following operations (with the remote control mode selector set to "AUDIO/TV/VCR");

- TV/CAT/TV/DBS 0/1:** Turns on or off the TV.
- TV VOLUME +/-:** Adjusts the volume.
- TV/VIDEO:** Sets the input mode (either TV or VIDEO).

After pressing TV/DBS (with the remote control mode selector set to "AUDIO/TV/VCR"), you can perform the following operations on a TV:

- CHANNEL +/-:** Changes the channels.
- 1 — 9, 0, 100+:** Selects the channels.
- RETURN:** Alternates between the previously selected channel and the current channel.

**Note:**  
You can use either the VCR button or the VCR CONTROL button to activate the buttons listed to the left. If you press VCR, the playing source also changes. On the other hand, if you press VCR CONTROL, the playing source does not change.

After pressing DVD or DVD MULTI (with the remote control mode selector set to the "AUDIO/TV/VCR" position), these buttons can be used for the DVD menu operations.



**Note:**  
For detailed menu operations, refer to the instructions supplied with the discs or the DVD player.

## Operating Other Manufactures' Components

This remote control supplied with the receiver can transmit control signals for other manufacturers' VCRs, TVs, CATV converters and DBS tuners. By changing the transmittable signals from preset ones to the other manufacturers', you can operate the other manufacturer's components using this remote control.

When operating the other manufacturers' components, refer also to the manuals supplied with them.

To operate these components with the remote control, first you need to set the manufacturer's code each for the VCR, TV, CATV converter, and DBS tuner.

### IMPORTANT:

When using the Remote Control, check to see if its remote control mode selector is set to the correct position:

To operate an audio system, TV, and VCR, set it to "AUDIO/TV/VCR."

To operate a CATV converter and DBS tuner, set it to "CATV/DBS."



### To change the transmittable signals for operating another manufacturer's TV

1. Set the remote control mode selector to "AUDIO/TV/VCR."

2. Press and hold TV/CATV/DBS  $\odot$ /I.

3. Press TV/DBS.

4. Enter the manufacturer's code (three digits) using buttons 1 - 9, and 0.  
See the lists on page 68 to find the code.

5. Release TV/CATV/DBS  $\odot$ /I.

The following buttons can be used for operating the TV (with the remote control mode selector set to "AUDIO/TV/VCR"):

TV/CATV/DBS  $\odot$ /I: Turns on and off TV.  
TV VOLUME +/-: Adjusts the volume.  
TV/VIDEO: Sets the input mode (either TV or VIDEO).

After pressing TV/DBS (with the remote control mode selector set to "AUDIO/TV/VCR"), you can perform the following operations on the TV:

CHANNEL +/-: Changes the channels.  
1 - 10, 0, 100+ (+10): Selects the TV channels.  
100+ (+10) button will function as the ENTER button if your TV requires pressing ENTER after selecting a channel number.

6. Try to operate your TV by pressing TV/CATV/DBS  $\odot$ /I.  
When your TV turns on or off, you have entered the correct code.

7. If there are more than one code listed for your brand of TV, try each one until the correct one is entered.

### To change the transmittable signals for operating a CATV converter or DBS tuner

1. Set the remote control mode selector to "CATV/DBS."

2. Press and hold TV/CATV/DBS  $\odot$ /I.

3. Press TV/DBS.

4. Enter the manufacturer's code (three digits) using buttons 1 - 9, and 0.  
See the lists on page 68 to find the code.

5. Release TV/CATV/DBS  $\odot$ /I.

After setting the remote control mode selector to "CATV/DBS," you can perform the following operations on the CATV converter or on the DBS tuner:

TV/CATV/DBS  $\odot$ /I: Turns on and off the CATV converter or DBS tuner.

CHANNEL +/-: Changes the channels.

1 - 10, 0, 100+ (+10): Selects the channels.

100+ (+10) button will function as the ENTER button if your CATV converter or DBS tuner requires pressing ENTER after selecting a channel number.

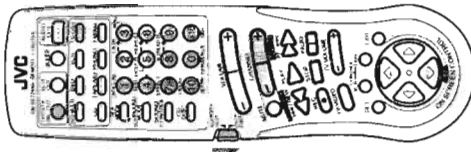

### Note:

Refer also to the manual supplied with your CATV converter or DBS tuner.

6. Try to operate your CATV converter or DBS tuner by pressing TV/CATV/DBS  $\odot$ /I.

When your CATV converter or DBS tuner turns on or off, you have entered the correct code.

7. If there are more than one code listed for your brand of CATV converter or DBS tuner, try each one until the correct one is entered.

### Note:

Refer also to the manual supplied with your TV.

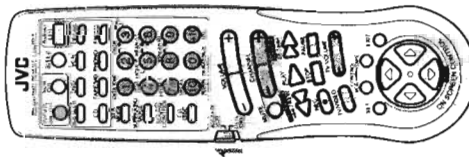

# Operating Other Manufactures' Components

## To change the transmittable signals for operating another manufacturer's VCR

1. Set the remote control mode selector to "AUDIO/TV/VCR."
2. Press and hold VCR  $\Phi$ 1.
3. Press VCR.
4. Enter the manufacturer's code (three digits) using buttons 1 - 9, and 0.  
See the lists on page 69 to find the code.

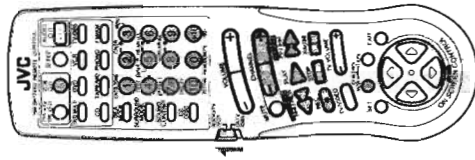

### 5. Release VCR $\Phi$ 1.

The following buttons can be used for operating the VCR (with the remote control mode selector set to "AUDIO/TV/VCR"):

**VCR  $\Phi$ 1**: Turns on and off VCR.

After pressing VCR or VCR CONTROL, (with the remote control mode selector set to "AUDIO/TV/VCR"), you can perform the following operations on the VCR:

**CHANNEL +/-**: Changes the channels on the VCR.  
**1 - 10, 0, 100+ (+10)**: Selects the channels on the VCR. 100+ (+10) button will function as the ENTER button if your VCR requires pressing ENTER after selecting a channel number.

- PLAY**: Starts playback.
- STOP**: Stops operations.
- PAUSE**: Pauses.
- REW**: Rewinds a tape.
- FF**: Fast winds a tape.
- REC** ●: Starts recording or enters recording pause.

### 6. Try to operate your VCR by pressing VCR $\Phi$ 1.

When your VCR turns on or off, you have entered the correct code.

### 7. If there are more than one code listed for your brand of VCR, try each one until the correct one is entered.

## Manufacturers' codes for CATV converters

Daeryung	008
GoldStar	838
LG Alps	779
Now	776
Samsung	702
Seawoo	780
Tongkok	777, 840
Zenith	000

## Manufacturers' codes for TV

Anam	003, 004, 009, 068, 161, 425, 426
Anam National	161, 250, 425
Blaupunkt	554
Daewoo	066, 092, 154, 391, 402, 451
ECE	037
Etron	009, 283
Fortress	093
Funai	264, 342
General	186
GoldStar	002, 037, 039, 178, 283, 457, 467
Grundig	535
Hitachi	145
JVC	036, 053, 069, 094, 160
Marantz	054
Matsushita	250
Mitsubishi	150, 241
National	226
NEC	030, 170
Nicamagic	216
Panasonic	161, 250
Philips	037
Pioneer	166
Samsung	060, 090, 427
Sanyo	208, 376, 424
Sharp	093, 256
Sony	000
Telefunken	252
Thomson	560
Toshiba	156, 502
Victor	036, 053, 160, 250, 376

### Notes:

- You can use either the VCR button or the VCR CONTROL button to activate the buttons listed to the left. If you press VCR, the playing source also changes. On the other hand, if you press VCR CONTROL, the playing source does not change.
- Refer also to the manual supplied with your VCR.

## Manufacturers' codes for DBS tuner

Dae Young	735
DX Antenna	752
Marantz	200
Panasonic	739
Pantech	747
Samsung	773
Sony	661
Toshiba	486

## Operating Other Manufacturers' Components

### Manufacturers' codes for VCR

Akai	281, 288
Anam	037, 162, 226, 240, 278
Anam National	162, 226
Blaupunkt	226
Daewoo	020, 046, 278, 368, 552
Funai	000
General	052
GoldStar	037, 225, 471
Grundig	195
Hitachi	042, 166, 235
JVC	008, 041, 067, 384
Marantz	081
Matsushita	227
Mitsubishi	043, 061, 196
National	226
NEC	038, 040, 370
Panasonic	162, 226, 227, 367
Philips	062, 081
Pioneer	058
Samsung	240, 426, 432
Sanyo	046, 104, 368, 369
Sharp	048, 062, 363
Shintom	072
Sony	032, 033, 034
Telefunken	187
Thomson	320
Toshiba	045, 366
Victor	008, 041, 067, 384

Manufacturers' codes listed on pages 68 and 69 are subject to change without notice. If they are changed, this remote **cannot** operate the equipment.

## Troubleshooting

Use this chart to help you solve daily operational problems. If there is any problem you cannot solve, contact your JVC service center.

PROBLEM	POSSIBLE CAUSE	SOLUTION
The display does not light up.	The power cord is not plugged in or the <b>POWER</b> switch pressed to set it in the <b>OFF</b> position.	Plug the power cord into an AC outlet and/or press <b>POWER</b> to set it in the <b>ON</b> position.
No sound from speakers.	Speaker signal cables are not connected. The <b>SPEAKERS 1</b> and <b>2</b> buttons are not set correctly. An incorrect source is selected. Muting is activated.	Check speaker wiring and reconnect if necessary. Press <b>SPEAKERS 1</b> and <b>2</b> correctly. Select the correct source. Press <b>MUTE</b> to cancel the mute.
Sound from one speaker only.	Speaker signal cables are not connected properly.	Check speaker wiring and reconnect if necessary.
Continuous hiss or buzzing during FM reception.	The balance is set to one extreme. Incoming signal is too weak. The station is too far away. An incorrect antenna is used. Antennas are not connected properly.	Adjust the balance properly (see page 23). Connect an outside FM antenna or contact your dealer. Select a new station. Check with your dealer to be sure you have the correct antenna. Check connections.
Occasional crackling noise during FM reception.	Ignition noise from automobiles.	Move the antenna farther from automobile traffic.
No colors on the on-screen display.	The color system of the connected TV is not PAL.	Connect a PAL TV.
Howling during record playing.	Your turntable is too close to speakers. Speakers are overloaded because of high volume.	Move speakers away from the turntable. Rotate the <b>MASTER VOLUME</b> control counterclockwise three or four times, then press <b>STANDBY/ON</b> on the front panel. If "OVERLOAD" does not disappear, unplug the AC power cord, then plug it back again.
"OVERLOAD" starts flashing on the display.	Speakers are overloaded because of short circuit of speaker terminals.	Press <b>STANDBY/ON</b> on the front panel, then check the speaker wiring. If "OVERLOAD" does not disappear, unplug the AC power cord, then plug it back again. If speaker wiring is not short-circuited, contact your dealer.
Remote control does not work.	The remote control mode selector is not set correctly. There is an obstruction in front of the remote sensor on the receiver. Batteries are weak.	Set the selector correctly either to "AUDIO/TV/VCR" or to "CATV/DBS." Remove the obstruction. Replace batteries.

# Specifications

<b>Amplifier</b>			
Output Power	At Stereo operation	100 watts per channel, min. RMS, driven into 4 ohms, at 1 kHz with no more than 0.7 % total harmonic distortion. (IEC268-3/DIN)	
	At Surround operation	50 watts per channel, min. RMS, driven into 8 ohms, at 1 kHz with no more than 0.7 % total harmonic distortion. (IEC268-3/DIN)	
	At Surround operation	70 watts per channel, min. RMS, driven into 4 ohms, at 1 kHz with no more than 0.8 % total harmonic distortion.	
	Center channel	70 watts, min. RMS, driven into 4 ohms, at 1 kHz, with no more than 0.8 % total harmonic distortion.	
	Rear channels	70 watts per channel, min. RMS, driven into 4 ohms, at 1 kHz, with no more than 0.8 % total harmonic distortion.	
	Total Harmonic Distortion (8 ohms, 1 kHz)	0.02 %* at 50 watts output (* Measured by JVC Audio Analysis System)	
	Audio Input Sensitivity/Impedance (1 kHz)	PHONO (MM)..... 2.5 mV/47 k ohms (C1), TAPE/MD, TV SOUND/DDBS, VCR, DVD..... 200 mV/47 k ohms	
	Audio Output Level	TAPE/MD, VCR..... 200 mV	
	Signal-to-Noise Ratio (*66 IHF/DIN)	PHONO..... 70 dB/66 dB (C1), TAPE/MD, TV SOUND/DDBS, VCR, DVD..... 87 dB/67 dB	
	Frequency Response (8 ohms)	PHONO..... 20 Hz to 20 kHz (±1 dB) (C1), TAPE/MD, TV SOUND/DDBS, VCR, DVD..... 20 Hz to 20 kHz (±1 dB)	
	R/AA Phono Equalization	±0.5 dB (20 Hz to 20 kHz)	
	Loudness Control (Volume Control at -30 dB)	+6 ±1 dB at 100 Hz +4 ±1 dB at 10 kHz	
	S.E.A.	Center Frequencies..... 100 Hz, 1 kHz, 10 kHz Control Range..... ±10 dB ±2 dB	
<b>Video</b>			
Video Input Sensitivity/Impedance	Composite video: TV SOUND/DDBS, VCR, DVD	1 Vp-p/75 ohms	
	S-video: DVD	1 Vp-p/75 ohms	
	(Y: luminance)	0.286 Vp-p/75 ohms	
	(C: chrominance, burst)	0.286 Vp-p/75 ohms	
Video Output Level	Composite video: VCR, MONITOR OUT	1 Vp-p/75 ohms	
	S-video: MONITOR OUT	1 Vp-p/75 ohms	
	(Y: luminance)	1 Vp-p/75 ohms	
	(C: chrominance, burst)	0.286 Vp-p/75 ohms	
Synchronization		Negative	
Signal-to-Noise Ratio		-45 dB	
On-Screen Color System		PAL	
<b>F/M tuner (IHF)</b>			
Tuning Range		87.5 MHz to 108.0 MHz	
Usable Sensitivity	Monaural	12.7 dBf (1.2 µV/75 ohms)	
50 dB Quieting Sensitivity	Monaural	16.3 dBf (1.8 µV/75 ohms)	
	Stereo	38.3 dBf (22.5 µV/75 ohms)	
Signal-to-Noise Ratio (IHF-A weighted)	Monaural	80 dB at 85 dBf	
	Stereo	73 dB at 85 dBf	
Total Harmonic Distortion	Monaural	0.15 % at 1 kHz	
	Stereo	0.2 % at 1 kHz	
Stereo Separation at REC OUT		40 dB at 1 kHz	
Capture Ratio		1.5 dB at 85 dBf	
Alternate Channel Selectivity		60 dB (±400 kHz)	
Frequency Response		30 Hz to 15 kHz; (+0.5 dB, -3 dB)	
<b>AM tuner</b>			
Tuning Range		531 kHz to 1,602 kHz (at 9 kHz interval)	
		530 kHz to 1,600 kHz (at 10 kHz interval)	
Usable Sensitivity	Loop antenna	300 µV/m	
Signal-to-Noise Ratio		50 dB (100 mV/m)	
<b>General</b>			
Power Requirements		AC 110/127/220/230-240V~, adjustable with the voltage-selector, 50/60 Hz	
Power Consumption		280 watts 2 watts (in standby mode)	
Dimensions (W x H x D)		435 x 157 x 412.5 mm (17 1/8 x 6 1/8 x 16 1/4 inches)	
Mass		11.3 kg (25.0 lbs)	

Designs & specifications are subject to change without notice.



## Description of Major ICs

### ■ MN101C15FAE (IC401) : System Control Micon

#### 1. Terminal Layout

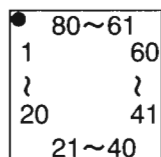

#### 2. Pin Function

Pin No	Symbol	Functions	Pin No	Symbol	Functions
1	GND	Ground	41	VIDEO3	VIDEO 3 signal terminal
2	DVD-S/C	DVD S/C signal select terminal	42	VIDEO4	VIDEO 4 signal terminal
3	VCR1-S/C	VCR1 S/C signal select terminal	43	S.MUTE	Source mute control terminal
4	VIDEO-S/C	VIDEO S/C signal select terminal	44	DSP-ERR	DSP control signal terminal
5	TV-S/C	TV S/C select terminal	45	DSP-ACK	DSP control signal terminal
6	4/8-IN	4 ohm / 8 ohm select signal terminal	46	DSP-INT	DSP control signal terminal
7	TV-SOUND	TV sound signal terminal	47	RDS-STATUS	RDS control signal terminal
8	GND	Ground	48	RDS-COMMON	RDS control signal terminal
9	PROTECT	Protect	49	INH-IN	Inhibit signal input terminal
10	GND	Ground	50	DSP-CS	DSP control signal terminal
11	VDD	Power supply	51	DSP-RESET	DSP reset signal terminal
12	OSC2	Oscillation terminal	52	M/CS	Control signal from IC400
13	OSC1	Oscillation terminal	53	M-RESET	Reset signal from IC400
14	Vss	Ground	54	STATUS	Status signal from IC400
15	XI	Ground	55	COMMAND	Command signal from IC400
16	XO	Ground	56	MCLK	Clock signal from IC400
17	GND	Ground	57	SEA-CLK	SEA clock signal from terminal
18	—————	Text signal input terminal	58	SEA-DATA	SEA data signal terminal
19	—————	Text signal output terminal	59	VL/VH	Connect to power supply board
20	—————	Master signal terminal	60	4/8 OUT	4 ohm / 8 ohm select signal terminal
21	DSP-COMMAND	DSP control signal terminal	61	SW-DADTA	Switch data signal terminal
22	DSP-STATUS	DSP control signal terminal	62	SW-CLK	Switch clock signal terminal
23	DSP-CK	DSP control signal terminal	63	VOL-STB	Volume strobo signal terminal
24	GND	Ground	64	VOL-DATA	Volume data signal terminal
25	RESET-IN	Reset signal input terminal	65	VOL-CLK	Volume clock signal terminal
26	TUNER-CE	Tuner chip enable	66	SW-STB	Switch strobo signal terminal
27	TUNER-CLK	Tuner clock signal terminal	67	DTO-LED	DTO LED signal terminal
28	TUNER-STATUS	Tuner control signal terminal	68	—————	No use
29	TUNER-COMMAND	Tuner control signal terminal	69	FR-RELAY1	Relay 1 signal terminal
30	TUNER-MUTE	Tuner mute signal terminal	70	FR-RELAY2	Relay 2 signal terminal
31	TUNER-IN	Tuner signal input terminal	71	CNTR-RELAY	Center speaker relay terminal
32	STEREO-IN	Stereo signal input terminal	72	SUR-RELAY	Surround speaker relay terminal
33	RDS-ST	No use	73	HP-RELAY	Head Phone relay terminal
34	M-BUSY	Busy signal from IC400	74	DOLBY	Dolby signal terminal
35	RDS-CLK	No use	75	C.TONE3	Center tone 3 signal terminal
36	OSD-DATA	OSD data signal input terminal	76	C.TONE2	Center tone 2 signal terminal
37	OSD-STB	OSD standby signal terminal	77	C.TONE1	Center tone 1 signal terminal
38	OSD-CLK	OSD clock signal terminal	78	LED-LCK	LED latch clock signal terminal
39	VIDEO1	VIDEO 1 signal terminal	79	LED-DATA	LED data signal terminal
40	VIDEO2	VIDEO 2 signal terminal	80	LED-CLK	LED clock signal terminal

## ■ MN172412JABZ (IC400) : FL Tube Drive Control Micon

### 1. Terminal Layout

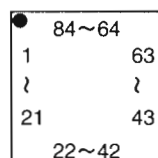

### 2. Pin Function

Pin No	Symbol	Functions	Pin No	Symbol	Functions
1	S22	Segment controlsignal output	43	JOG4	Connect to volume
2	S21	Segment controlsignal output	44	MBUSY	Busy signal to IC401
3	S20	Segment controlsignal output	45	MCLK	Clock signal to IC401
4	S19	Segment controlsignal output	46	COMMAND	Command signal to IC401
5	S18	Segment controlsignal output	47	STATUS	Status signal fot IC 401
6	S17	Segment controlsignal output	48	M/CS	Control signal to IC401
7	S16	Segment controlsignal output	49	RM	Remocon signal terminal
8	S15	Segment controlsignal output	50	VCRI	Compulink signal input
9	S14	Segment controlsignal output	51	DCSI	Compulink signal input
10	S13	Segment controlsignal output	52	DCSO	Compulink signal output
11	S12	Segment controlsignal output	53	VCRO	Compulink signal output
12	S11	Segment controlsignal output	54	TVO	Compulink output
13	S10	Segment controlsignal output	55	TVC	Compulink control output
14	S9	Segment controlsignal output	56	JOG5	Connect to mullti jog
15	S8	Segment controlsignal output	57	JOG6	Connect to mullti jog
16	S7	Segment controlsignal output	58	POWER	From power supply
17	S6	Segment controlsignal output	59	STANDBY	Standby signal terminal
18	S5	Segment controlsignal output	60	KI3	Key matrix input
19	S4	Segment controlsignal output	61	KI2	Key matrix input
20	S3	Segment controlsignal output	62	KI1	Key matrix input
21	S2	Segment controlsignal output	63	KI0	Key matrix input
22	S1	Segment controlsignal output	64	S36	Segment controlsignal output
23	VPP	Powe supply fot FL display	65	S35	Segment controlsignal output
24	G14	Grid control signal output	66	S34	Segment controlsignal output
25	G13	Grid controlsignal output	67	S33	Segment controlsignal output
26	G12	Grid controlsignal output	68	RST	Reset signal input
27	G11	Grid controlsignal output	69	X1	Connect to ground
28	G10	Grid controlsignal output	70	X2	No use
29	G9	Grid controlsignal output	71	VSS	Connect to ground
30	G8	Grid controlsignal output	72	OSC2	Oscillation terminal
31	G7	Grid controlsignal output	73	OSC1	Osillation terminal
32	G6	Grid controlsignal output	74	VDD	Power supply
33	G5	Grid controlsignal output	75	S32	Segment controlsignal output
34	G4	Grid controlsignal output	76	S31	Segment controlsignal output
35	G3	Grid controlsignal output	77	S30	Segment controlsignal output
36	G2	Grid controlsignal output	78	S29	Segment controlsignal output
37	————	Connect to Q408	79	S28	Segment controlsignal output
38	————	Connect to Q407	80	S27	Segment controlsignal output
39	G1	Grid controlsignal output	81	S26	Segment controlsignal output
40	JOG1	Connect to source selector	82	S25	Segment controlsignal output
41	JOG2	Connect to source selector	83	S24	Segment controlsignal output
42	JOG3	Connect to volume	84	S23	Segment controlsignal output

■ LA1837(IC102): FM AM IF AMP&detector, FM MPX Decoder

1. Block Diagram

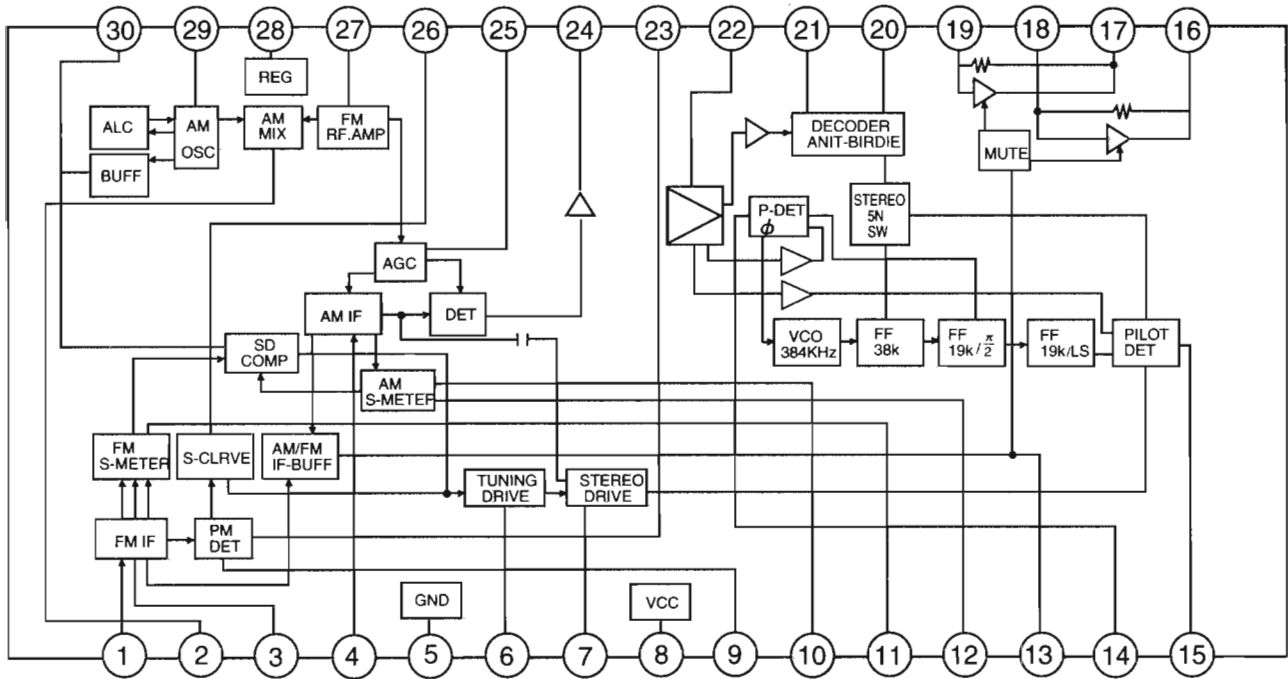

3. Pin Function

Pin No.	Symbol	I/O	Function	Pin No.	Symbol	I/O	Function
1	FM IN	I	This is an input terminal of FM IF signal.	16	L OUT	O	Left channel signal output.
2	AM MIX	O	This is an out put terminal for AM mixer.	17	R OUT	O	Right channel signal output.
3	FM IF	I	Bypass of FM IF	18	L IN	I	Input terminal of the Left channel post AMP.
4	AM IF	I	Input of AM IF Signal.	19	R IN	I	Input terminal of the Right channel post AMP.
5	GND	-	This is the device ground terminal.	20	RO	O	Mpx Right channel signal output.
6	TUNED	O	When the set is tuning,this terminal becomes "L".	21	LO	O	Mpx Left channel signal output.
7	STEREO	O	Stereo indicator output. Stereo "L", Mono: "H"	22	IF IN	I	Mpx input terminal
8	VCC	-	This is the power supply terminal.	23	FM OUT	O	FM detection output.
9	FM DET	-	FM detect transformer.	24	AM DET	O	AM detection output.
10	AM SD	-	This is a terminal of AM ceramic filter.	25	AM AGC	I	This is an AGC voltage input terminal for AM
11	FM VSM	O	Adjust FM SD sensitivity.	26	AFC	-	This is an output terminal of voltage for FM-AFC.
12	AM VSM	O	Adjust AM SD sensitivity.	27	AM RF	I	AM RF signal input.
13	MUTE	I/O	When the signal of IF REQ of IC121( LC72131) appear, the signal of FM/AM IF output. //Muting control input.	28	REG	O	Register value between pin 26 and pin28 desides the frequency width of the input signal.
14	FM/AM	I	Change over the FM/AM input. "H" :FM, "L" : AM	29	AM OSC	-	This is a terminal of AM Local oscillation circuit.
15	MONO/ST	O	Stereo : "H", Mono: "L"	30	OSC BUFFER	O	AM Local oscillation Signal output.

# RX-774P/RX-774V

## LC72131(IC121):PLL Synthesizer

### 1. Terminal Layout

XIN	1	22	XOUT
	2	21	VSS
PLLCE	3	20	LPF OUT
PLLDA	4	19	LPF IN
PLLCK	5	18	PD
IFDATA	6	17	VDD
FM	7	16	FM OSC
MW	8	15	AM OSC
LW	9	14	
AUTO/MONO	10	13	IF REQ
POWER	11	12	FM/AM IF

### 2. Block Diagram

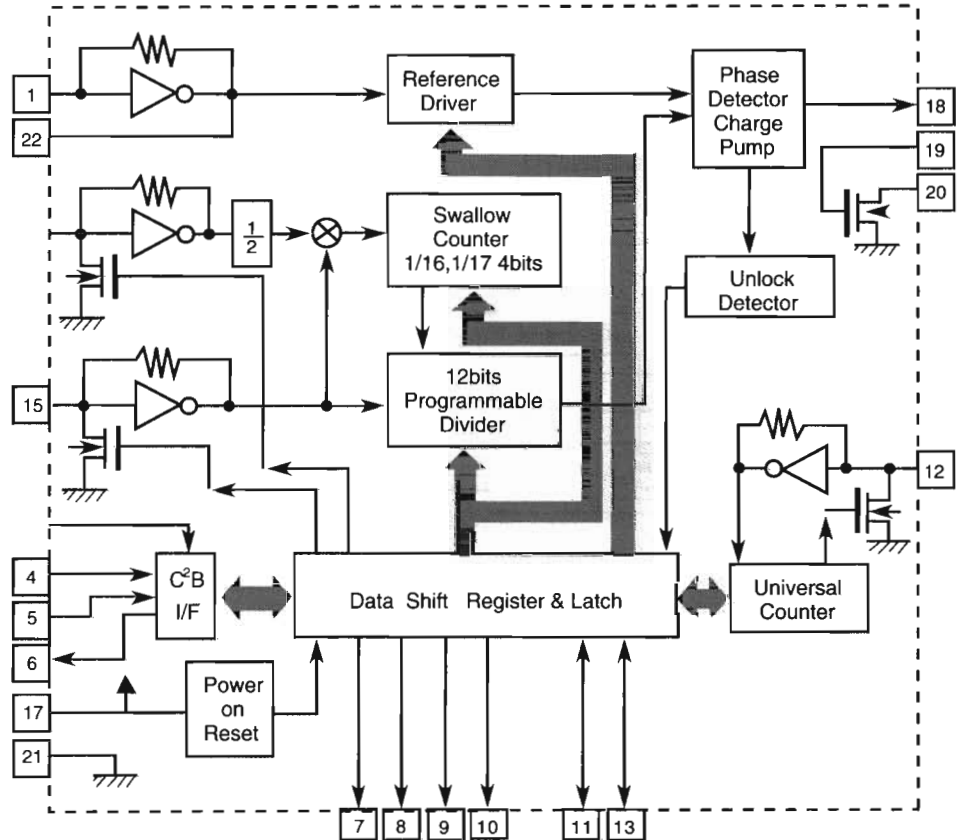

### 3. Pin Functions

Pin No.	Symbol	I/O	Functions	Pin No.	Symbol	I/O	Functions
1	Xin	I	Crystal oscillator (7.2MHz).	12	FM/AM IF	I	Universal counter input
2		--	Not nse	13	IF REQ	O	Output the "IF-signal request" to IC102
3	PLLCE	I	Fix the chip enable to "H" when inputting (DI) and outputting (DO) the serial data	14		I	Not use
4	PLLDA	I	Receive the control data from the controller (IC801).	15	AMOSC	I	Input the local oscillator signal of AM.
5	PLLCK	I	This clock is used to synchronize data when transmitting the data of DI and DO.	16	FM OSC	I	Input the local oscillator signal of FM.
6	IFDATA	O	Transmit the data from LC72131 to the controller which is synchronized with CK.	17	VDD	O	This is a terminal of power supply.
7	FM	O	It is "L" on FM mode.	18	PD	O	PLL charge pump output : When the local oscillator signal frequency is higher than the reference frequency high level signals will output. When it is lower than the reference frequency, low level signals will output. When it is same as reference frequency signals, it will be floating.
8	MW	O	It is "L" on MW mode.	19	LPF IN	I	Transistor used for the PLL active low-pass filter
9	LW	O	It is "L" on LW mode.	20	LPF OUT	O	Transistor used for the PLL active low-pass filter
10	AUTO/MONO	O	It is "L" on monaural, "L" on auto	21	VSS	--	Connected toGND
11	POWER	O	Regulator control signal P ON "H" , STANDBY "L"	22	X out	O	Crystal oscillator(7.2MHz).

■ BA7625(IC201) : Video Selector

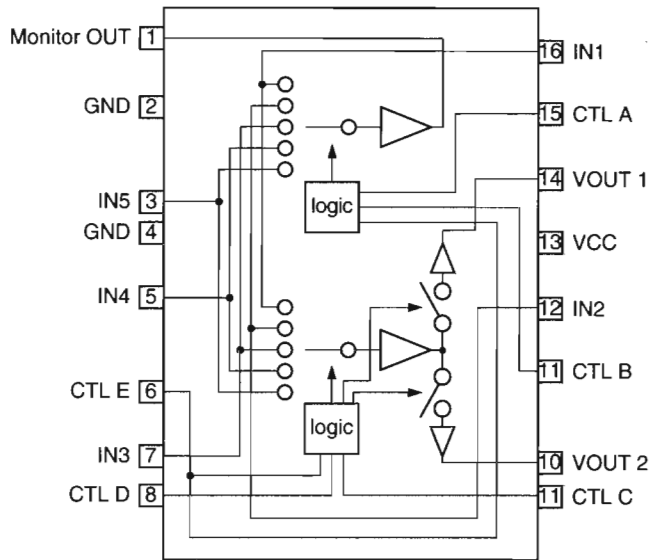

A	B	E	Monitor OUT
L	L	*	IN1
H	L	*	IN2
L	H	*	IN3
H	H	L	IN4
H	H	H	IN5

C	D	E	VOUT1
L	L	*	--
H	L	*	IN2
L	H	*	IN3
H	H	L	IN4
H	H	H	IN5

C	D	E	VOUT2
L	L	*	IN1
H	L	*	--
L	H	*	IN3
H	H	L	IN4
H	H	H	IN5

■ NJM2285D (IC202) : Video Switch

1. Terminal Layout & Block Diagram

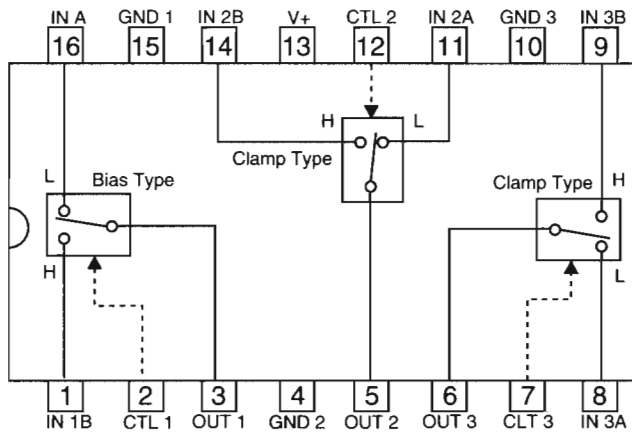

■ MB90089 (IC203) : On Screen Display Controller

1. Terminal Layout

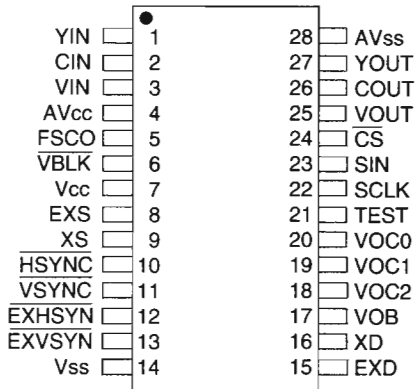

2. Block Diagram

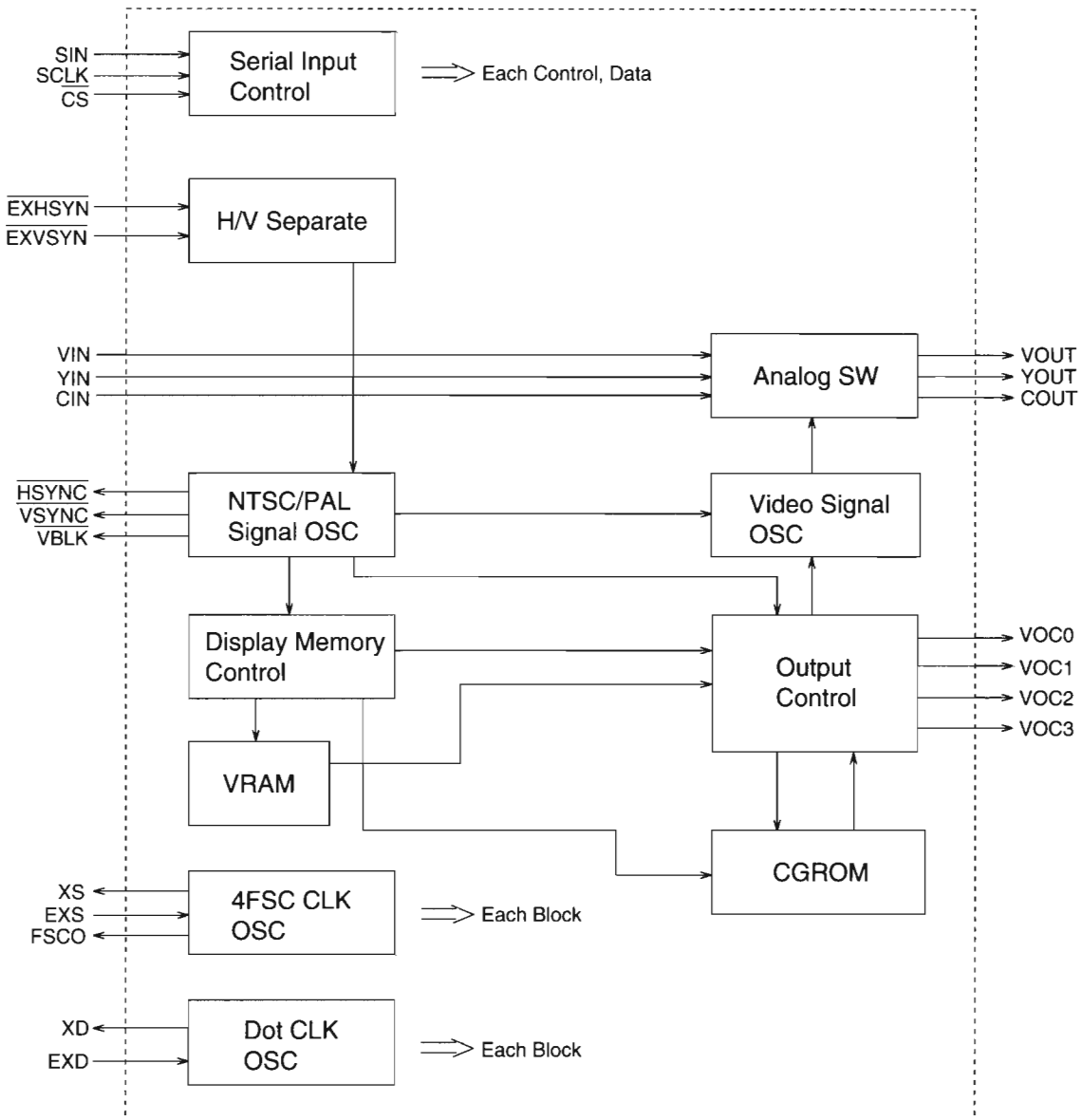

## 3.Functions

pin no	Symbol	I/O	Function
1	YIN	I	Lux signal Input terminal for Superinpause indication
2	CIN	I	Contrast signal input terminal for Superinpause indication
3	VIN	I	Composit video signal input terminal for Superinpause indication
4	AVcc	-	Analog power supply terminal
5	FSCO	O	Internal collar barst phase indication signal
6	VBLK	O	Vertical blanking signal output terminal
7	Vcc	-	Power supply terminal
8	EXS	I	Clock generater outside circuit terminal for collar barst
9	XS	O	
10	HSYNC	O	Horizontal signal output terminal
11	VSYN	O	Vertical signal output terminal
12	EXHSYN	I	EXT horizontal signal input terminal
13	EXVSYN	I	EXT vertical signal input terminal
14	Vss	-	GND
15	EXD	I	Dot clock generater outside circuit signal terminal for indication
16	XD	O	
17	VOB	O	Character & background signal output terminal
18	VOC2	O	Collar signal output terminal
19	VOC1		
20	VOC0		
21	TEST	I	Test signal input terminal
22	SCLK	I	Shift clock input terminal for serial transmission
23	SIN	I	Serial data input terminal
24	CS	I	Tip select terminal
25	VOUT	O	Composit video signal output terminal
26	COUT	O	Contrast signal output terminal
27	YOUT	O	Lux signal output terminal
28	AVss	-	Anarog GND terminal

RX-774P/RX-774V

■ NJM4580DD (IC301) : Dual Ope Amp.

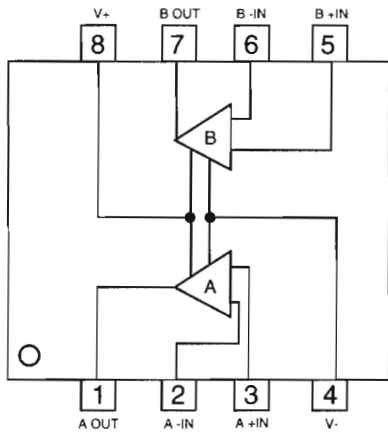

■ NJM4580D(IC305) : Dual operation

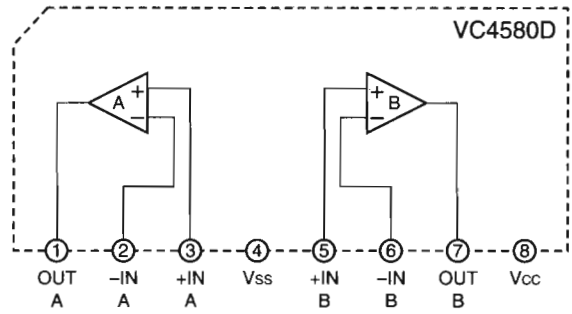

■ BA15218N (IC331,332,333) : Dual OpeAmp

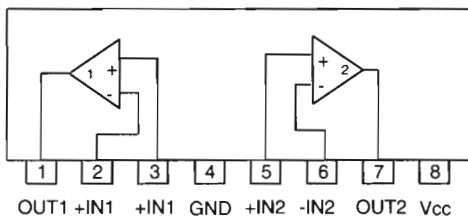

■ NJM4580L (IC361) : Dual Operation Amp.

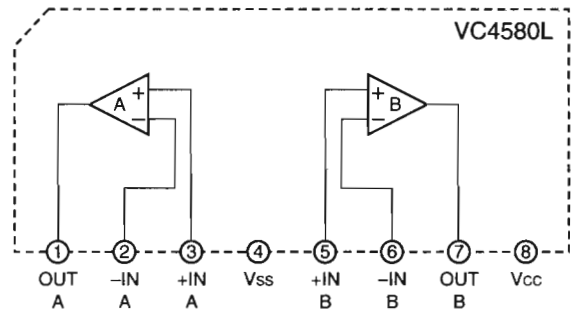

■ BU4051BC(IC341) : Dolby-B Noise Reduction

1.Terminal

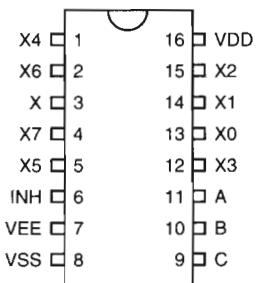

2.Brock Diagram

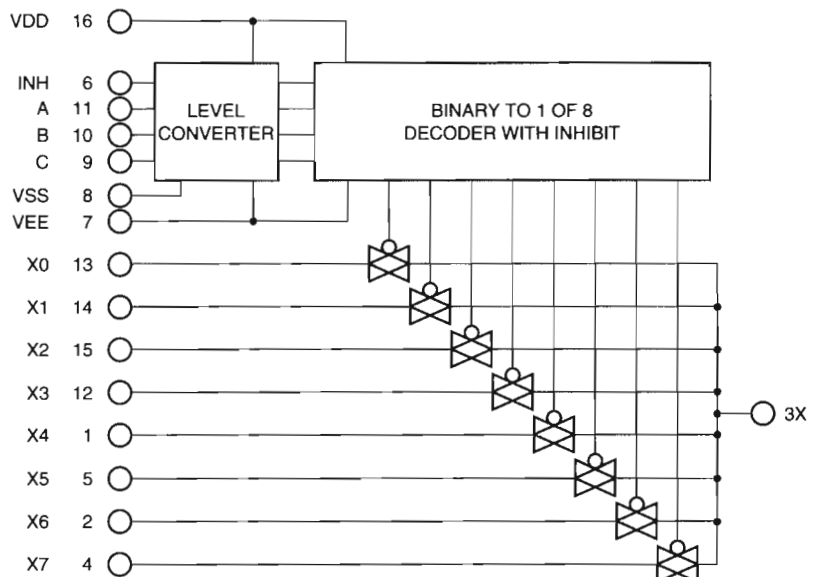



■ TC9162AN,TC9163AN, TC9164AN (IC321): Electrical

1.Function

Switch to On/Off of S1 to S8 by control of LSI.

2.Terminal Lay out & Block Diagram

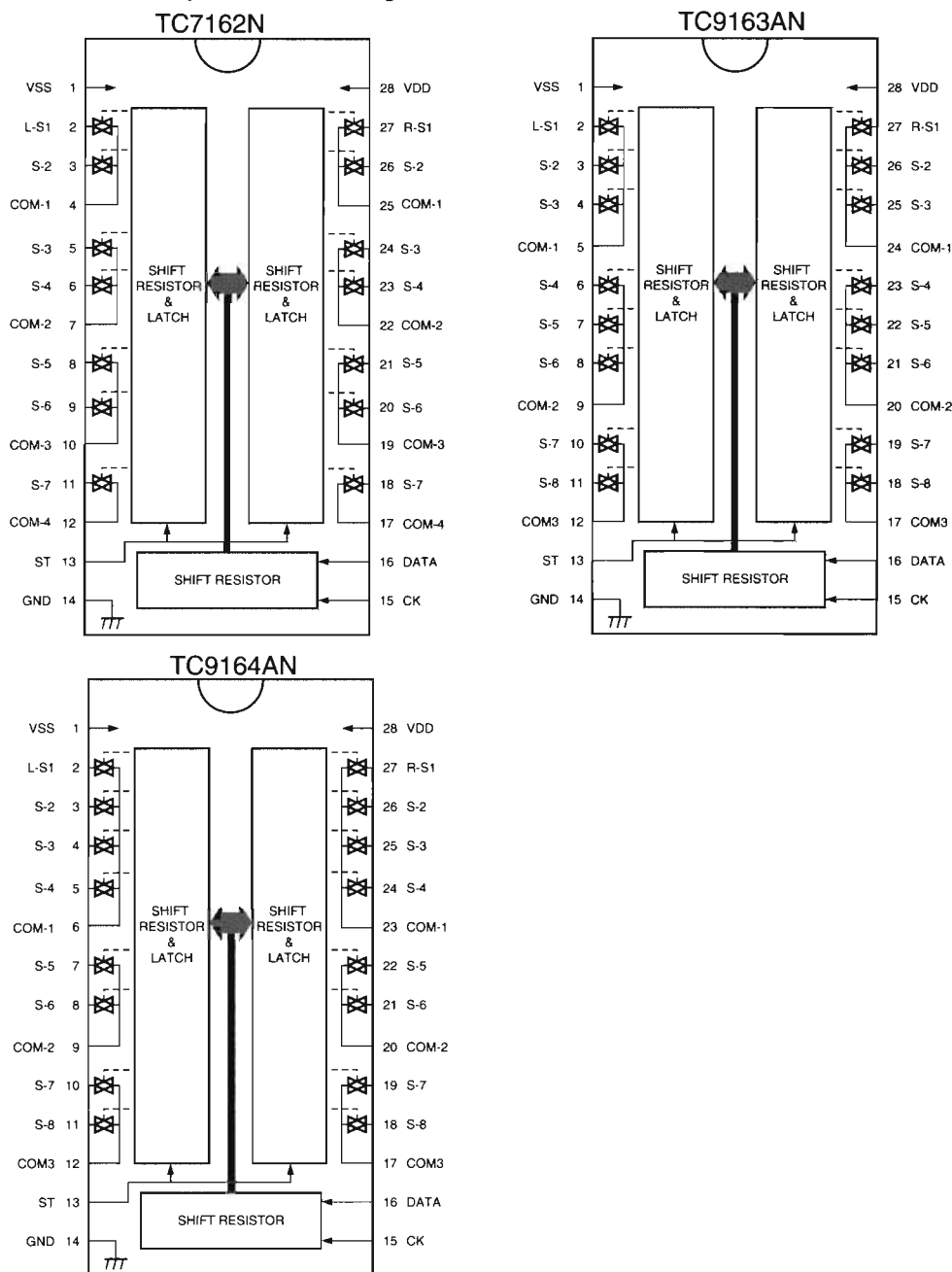

3.Corespondance of Switch & Data

S1~S8 are "1" position to ON by bit1~8 of Serial Data.

S9 is Right,S10 is Left Switch to ON/OFF. TC9162,TC9163 and TC9164 are select by bit11~14.

	Switch Select bit										Switch Select bit			
	S1	S2	S3	S4	S5	S6	S7	S8	S9	S10	S11	S12	S13	S14
TC9162N	S1~S8 are "0" position to ON by bit1~8 of Serial Data.										0	0	0	0
TC9163N	S1~S8 are "1" position to ON by bit1~8 of Serial Data.										1	0	0	0
TC9164N	S1~S8 are "1" position to ON by bit1~8 of Serial Data.										0	1	0	0

■BU2092(IC402) : PORT EXPANDER

1. Terminal Layout

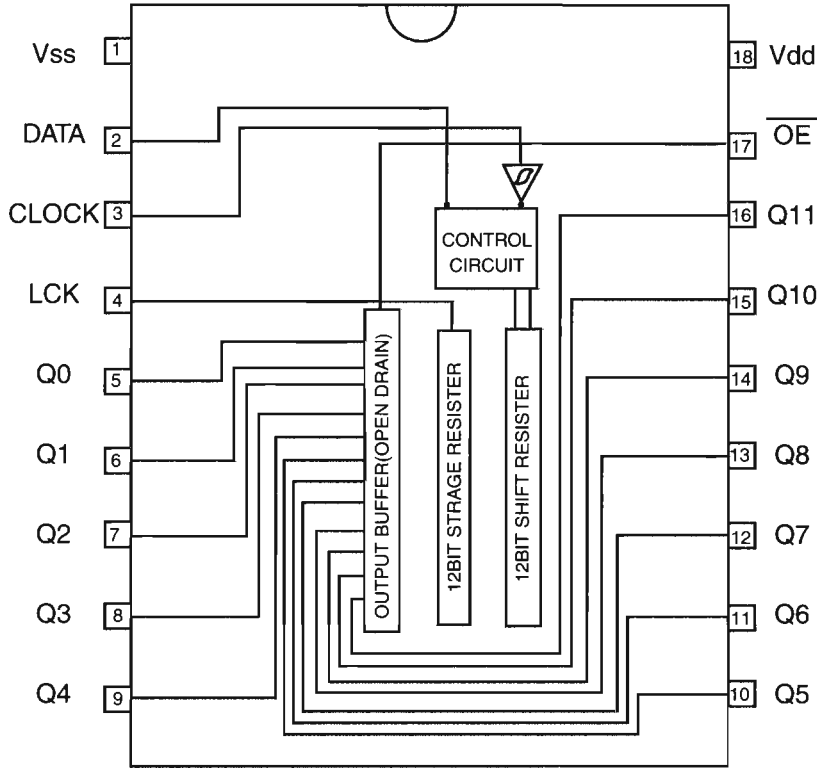

2.Pin Function

Pin No.	Symbol	I/O	Function						
1	Vss	-	Connect to GND						
2	DATA	I	Serial Data input						
3	CLOCK	I	Shift Clock of Data						
4	LCK	I	Latch Clock of Data						
5~16	Q0~Q11	O	Parallel Data Output <table border="1" style="margin-left: 20px;"> <tr> <td>Latch Data</td> <td>L</td> <td>H</td> </tr> <tr> <td>OUTPUT</td> <td>ON</td> <td>OFF</td> </tr> </table>	Latch Data	L	H	OUTPUT	ON	OFF
Latch Data	L	H							
OUTPUT	ON	OFF							
17	$\overline{\text{OE}}$	I	Output Enable						
18	Vdd	-	Power Supply						

■ TC9471F(IC481) : Dolby Prologic

1. Block Diagram

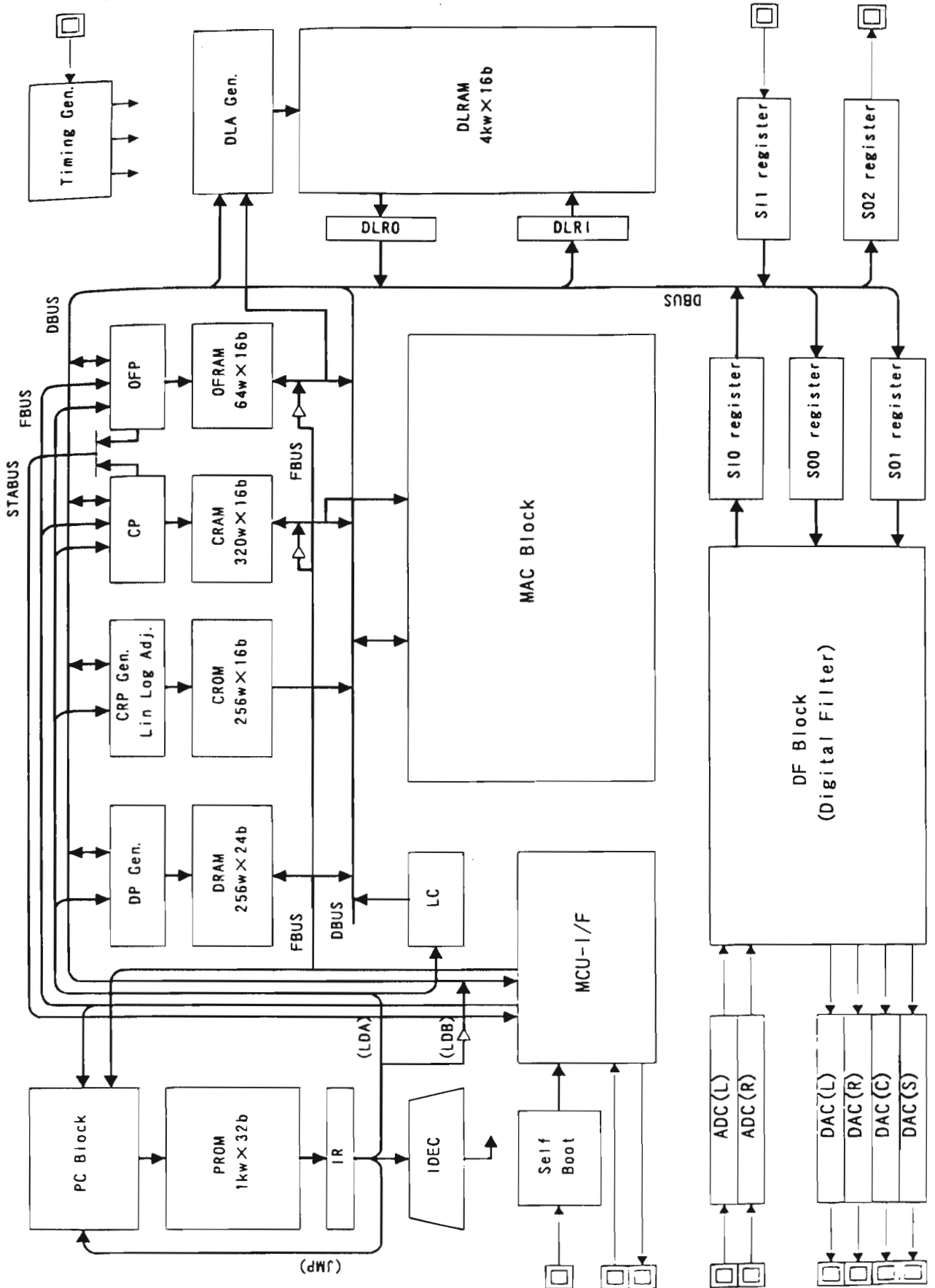

## 2-a.Pin Function

Pin No.	Symbol	I/O	Function
1	ECKO	O	Amplifier output terminal for external clock input.
2	ECKI	I	Amplifier input terminal for external clock input.
3	GNDX	-	Ground terminal.(For crystal oscillator circuit)
4	GNDAL	-	Ground terminal.(For DAC L channel)
5	AOL	O	DAC analog signal output terminal.(L channel)
6	VRL	-	Reference voltage terminal.(For DAC L channel)
7	VDAL	-	Power supply terminal.(For DAC L channel)
8	VDAR	-	Power supply terminal.(For DAC R channel)
9	VRR	-	Reference voltage terminal.(For DAC R channel)
10	AOR	O	DAC analog signal output terminal.(R channel)
11	GNDAR	-	Ground terminal.(For DAC R channel)
12	GNDAC	-	Ground terminal.(For DAC C channel)
13	AOC	O	DAC analog signal output terminal.(C channel)
14	AOCT	O	DAC analog signal output terminal with attenuator.(For C channel)
15	VRC	-	Reference voltage terminal.(For DAC C channel)
16	VDAC	-	Power supply terminal.(For DAC C channel)
17	VRO	O	Reference voltage terminal for attenuator.(Output buffer)
18	VRI	I	Reference voltage terminal for attenuator.(Input buffer)
19	VDAS	-	Power supply terminal.(For DAC S channel)
20	VRS	-	Reference voltage terminal.(For DAC S channel)
21	AOST	O	DAC analog signal output terminal with attenuator.(For S channel)
22	AOS	O	DAC analog signal output terminal.(S channel)
23	GNDAS	-	Ground terminal.(For DAC S channel)
24	GND	-	Ground terminal.
25~29	TP0~4	O	Test data output terminal, normally open.
30	VDD	-	Power supply terminal.
31	VDDR	-	Power supply terminal.(For DLRAM)
32	GNDR	-	Ground terminal.(For DLRAM)
33~40	TP5~12	O	Test data output terminal, normally open.
41	FS	O	Clock output terminal.(1fs)
42	CKO0	O	Clock output terminal 0.
43	CKO1	O	Clock output terminal 1.
44	GND	-	Ground terminal.
45	TP13	O	Test data output terminal, normally open.
46	MCK	O	Master clock output terminal.(256fs/512fs/(384/768fs))
47	VDD	-	Power supply terminal.
48~53	TP14~19	O	Test data output terminal, normally open.
54	CKS	I	Master clock select terminal.
55	STEP0	I	Operation step select terminal 0.
56	STEP1	I	Operation step select terminal 1.
57	RST	I	Reset signal input terminal.

## 2-b.Pin Function

Pin No.	Symbol	I/O	Function
58	VDD	-	Power supply terminal
59	SYNC	I	Synchronous signal input terminal.
60	ELRO	I	LR clock input terminal for serial data output.
61	ELRI	I	LR clock input terminal for serial data input.
62	EBCO	I	Bit clock input terminal for serial data output.
63	EBCI	I	Bit clock input terminal for serial data input.
64	DIN	I	Serial data input terminal.
65	DOUT	O	Serial data output terminal.
66	EM0	I	De-emphasis select terminal 0.
67	EM1	I	De-emphasis select terminal 1.
68	IFF0	I	Interface flag terminal 0.
69	IFF1	I	Interface flag terminal 1.
70	IFF2	I	Interface flag terminal 2.
71	GND	-	Ground terminal.
72	CS	I	Chip select signal input terminal.(MCU interface)
73	IFCK	I	Data sif clock input terminal.(MCU interface)
74	IFDI	I/O	Data input terminal.(MCU interface) At the IC bus mode,data input /output terminal.
75	IFDO	O	Data output terminal.(MCU interface) At the IC bus mode,normally open.
76	IFOK	O	Operation flag output terminal.(MCU interface)
77	ACK	O	Acknowledge signal output terminal.(MCU interface)
78	ERR	O	Error flag output terminal.(MCU interface)
79	I2CS	I	IC bus mode select terminal.
80	BOOT	I	Self-boot control terminal.
81	BA0	I	Boot address select terminal 0.
82	BA1	I	Boot address select terminal 1.
83	VDD	-	Power supply terminal.
84~87	TST0~3	I	Test data input terminal,normally fixed"L"level
88	GND	-	Ground terminal.
89	VSAL	-	Analog ground terminal.(For ADC L channel)
90	LIN	I	ADC analog signal input terminal.(L channel)
91	AVRL	-	Reference voltage terminal.(For ADC L channel)
92	VDL	-	Analog power supply terminal.(For ADC L channel)
93	VDR	-	Analog power supply terminal.(For ADC R channel)
94	AVRR	-	Reference voltage terminal.(For ADC R channel)
95	RIN	I	ADC analog signal input terminal.(R channel)
96	VSAR	-	Analog ground terminal.(For ADC R channel)
97	GNDX	-	Ground terminal.(For crystal oscillator circuit)
98	XI	I	Crystal oscillator connection terminal.(input)
99	XO	O	Crystal oscillator connection terminal.(output)
100	VDX	-	Power supply terminal.(For crystal oscillator circuit)

■ LC7522(IC451) : SEA Control Electrical

1.Terminal

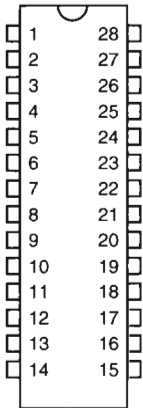

2.Brock Diagram

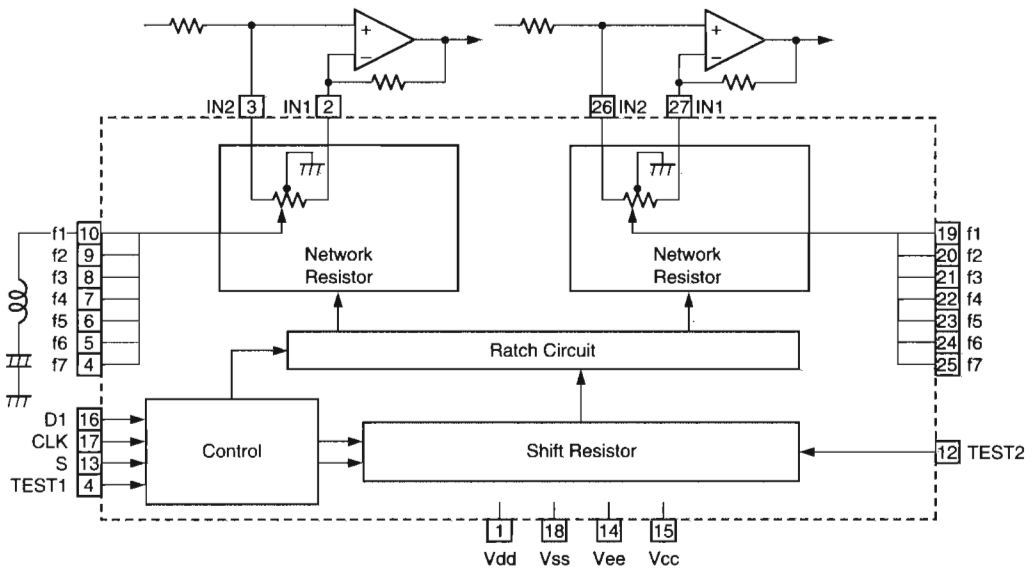

3.Function

Pin No.	Symbole	Function
1	V <sub>DD</sub>	Power Supply terminal for Audio signal +7V(typ)
18	V <sub>SS</sub>	Power Supply terminal 0V
14	V <sub>EE</sub>	Power Supply terminal for Audio signal. Single channel use, joint VSS.
15	V <sub>CC</sub>	Power Supply terminal +5V(typ)
2,27	IN 1	Audio signal Input terminal
3,26	IN 2	IN1 joint oposit input of Operation amp. IN2 joint unoposit input of Operation amp. It have Right and Left.
16	D1	Data input terminal from CPU Shumit inverter style
17	CLK	Clock input terminal from CPU Shumit inverter style
4~10 19~25	f1~f7	Joint terminal of B.P.F. f1~f7 × Right, Left Total 14 terminal
11	TEST1	Internal test terminal of IC
12	TEST2	It can use open condition
13	S	Select terminal for 2 tip use "1" input, key code 7C3→VDD joint "0" input, key code 7C2→VEE joint
28	NC	No use

■ PST600E (IC403) : Reset IC

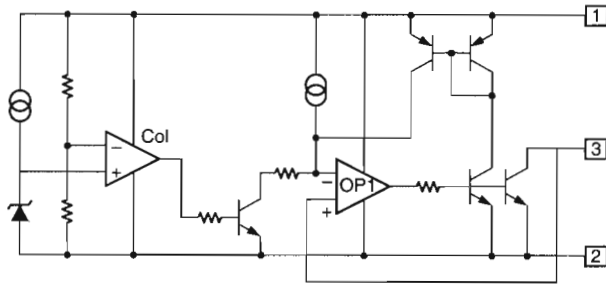

■ M5243P12 (IC452) : S.E.A. Graphic Equalizer

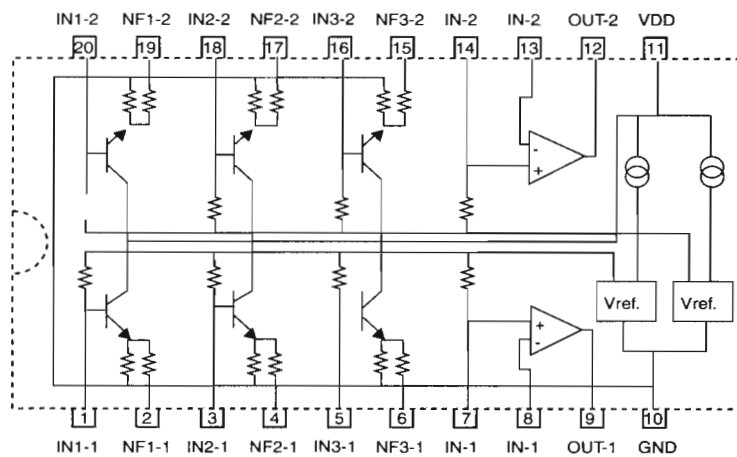

■ GP1U27151X (IC404) : Receiver for remote

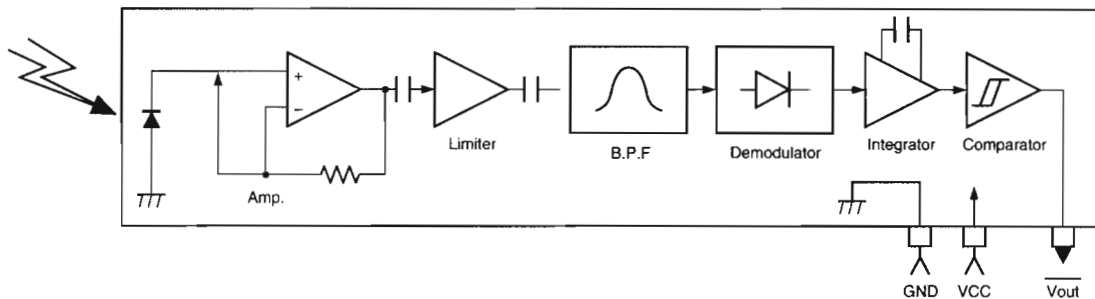

■ TA7317P (IC901) : Protector

1. Terminal Lay out

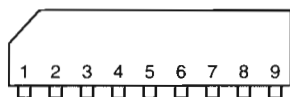

2. Block Diagram

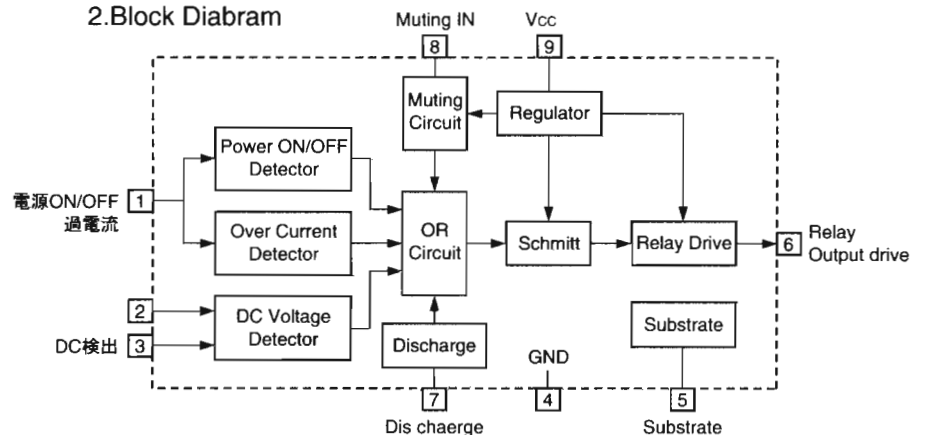

### INTERNAL CONNECTION OF FL DISPLAY TUBE

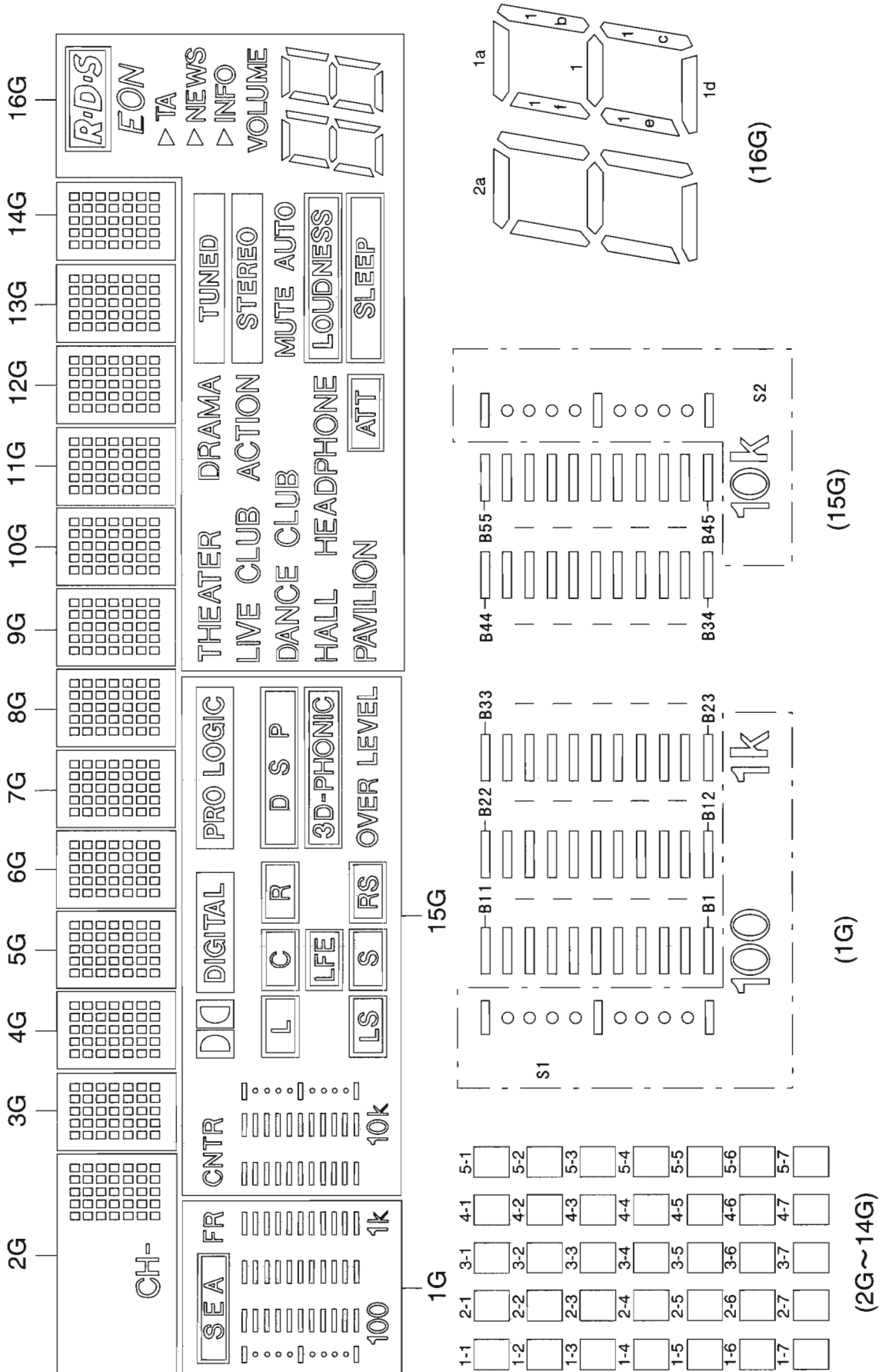



## ANODE CONNECTION

	1G	2G	3G~14G	15G	16G
P1	S1	1-1	1-1	S2	-
P2	B1	2-1	2-1	B34	-
P3	B12	3-1	3-1	B45	2d
P4	B23	4-1	4-1	B35	2e
P5	B2	5-1	5-1	B46	2c
P6	B13	1-2	1-2	B36	2g
P7	B24	2-2	2-2	B47	2f
P8	B3	3-2	3-2	B37	2b
P9	B14	4-2	4-2	B48	2a
P10	B25	5-2	5-2	B38	1d
P11	B4	1-3	1-3	B49	1e
P12	B15	2-3	2-3	B39	1c
P13	B26	3-3	3-3	B50	1g
P14	B5	4-3	4-3	B40	1f
P15	B16	5-3	5-3	B51	1b
P16	B27	1-4	1-4	B41	1a
P17	B6	2-4	2-4	B52	<b>R-D-S</b>
P18	B17	3-4	3-4	B42	<i>EON</i>
P19	B28	4-4	4-4	B53	VOLUME
P20	B7	5-4	5-4	B43	▷ INFO
P21	B18	1-5	1-5	B54	▷ NEWS
P22	B29	2-5	2-5	B44	▷ TA
P23	B8	3-5	3-5	B55	<b>ATT</b>
P24	B19	4-5	4-5	<b>LS</b>	<b>SLEEP</b>
P25	B30	5-5	5-5	<b>S</b>	<b>LOUDNESS</b>
P26	B9	1-6	1-6	<b>RS</b>	PAVILION
P27	B20	2-6	2-6	OVER LEVEL	HEADPHONE
P28	B31	3-6	3-6	<b>3D-PHONIC</b>	HALL
P29	B10	4-6	4-6	<b>LFE</b>	MUTE AUTO
P30	B21	5-6	5-6	CNTR	<b>STEREO</b>
P31	B32	1-7	1-7	<b>L</b>	<b>TUNED</b>
P32	B11	2-7	2-7	<b>C</b>	DANCE CLUB
P33	B22	3-7	3-7	<b>R</b>	ACTION
P34	B33	4-7	4-7	<b>D S P</b>	LIVE CLUB
P35	<b>SEA</b>	5-7	5-7	<b>DC</b> <b>DIGITAL</b>	DRAMA
P36	<b>FR</b>	CH-	-	<b>PRO LOGIC</b>	THEATER

## Disassembly Procedures

### ■ Removing the Top cover

(See Fig. 1)

1. From behind body, remove the four screws ① of the left and right side and three screws ② of the rear side on top cover.
2. Lift the back of the top cover spreading both sides to remove.

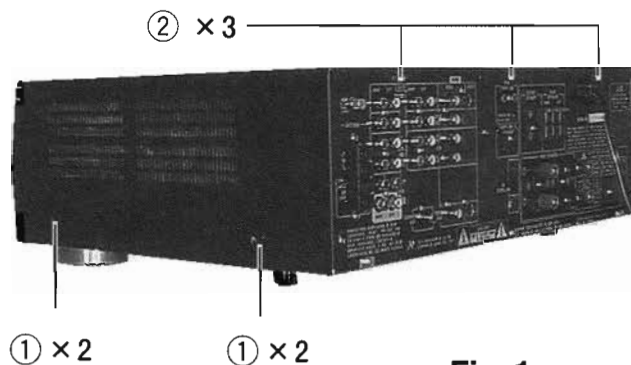

Fig. 1

### ■ Removing the Front panel

(See Fig. 2)

1. Remove the Top cover.
2. Disconnect the three connectors CN202, CN400, and CN402.
3. Remove the three screws ③ on top side of Front panel and five screws ④ on under the Front panel.
4. Remove the Front panel assembly.



Fig. 2

### ■ Removing the Rear panel

(See Fig. 3)

1. Remove the Top cover.
2. Pull out the Cord stopper ⑤.
3. Remove the 26pcs screws ⑥ on Rear panel.
4. Remove the Rear panel.

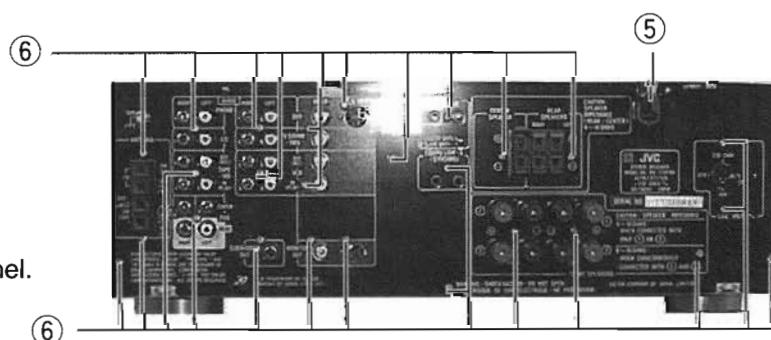

Fig. 3

## ■ Removing Front P.C. board

( See Figs. 4 and 5 )

1. Remove the Top cover.
2. Remove the Front panel.
3. Pull out the volume knob ⑦ , then turn off to counterclockwise the volume nut ⑧ .
4. Remove the six screws ⑨ and disconnect connector wire at CN422 ⑩ and CN430 ⑪ .
5. Remove the Front P.C. board.

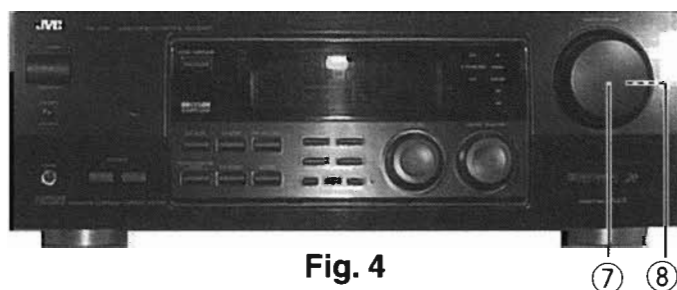

Fig. 4

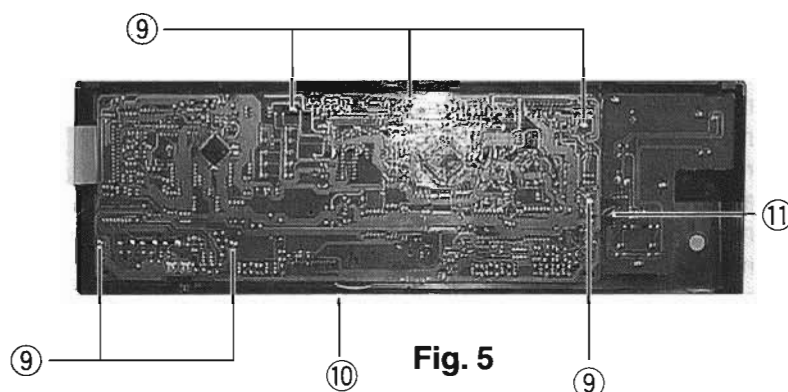

Fig. 5

## ■ Removing Switch P.C. board

( See Fig. 6 )

1. Remove the Top cover.
2. Remove the Front panel.
3. Remove the Front P.C. board.
4. Remove the six screws ⑫ and disconnect connector wire at CN422 ⑬ and CN430 ⑭ .
5. Remove the P.C. board cover from four engagements ⑮ at front panel.
6. Remove the Switch P.C. board.

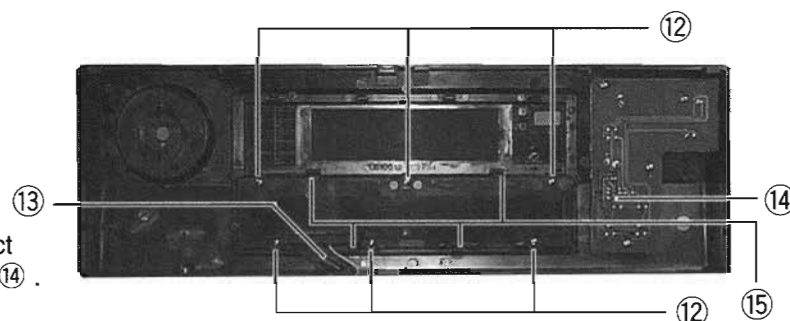

Fig. 6

## ■ Removing Remote P.C. board

( See Fig. 7 )

1. Remove the Top cover.
2. Remove the Front panel.
3. Remove four screws ⑯ .
4. Remove the Remote P.C. board.

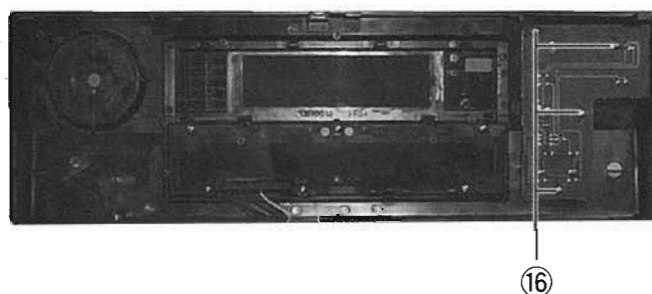
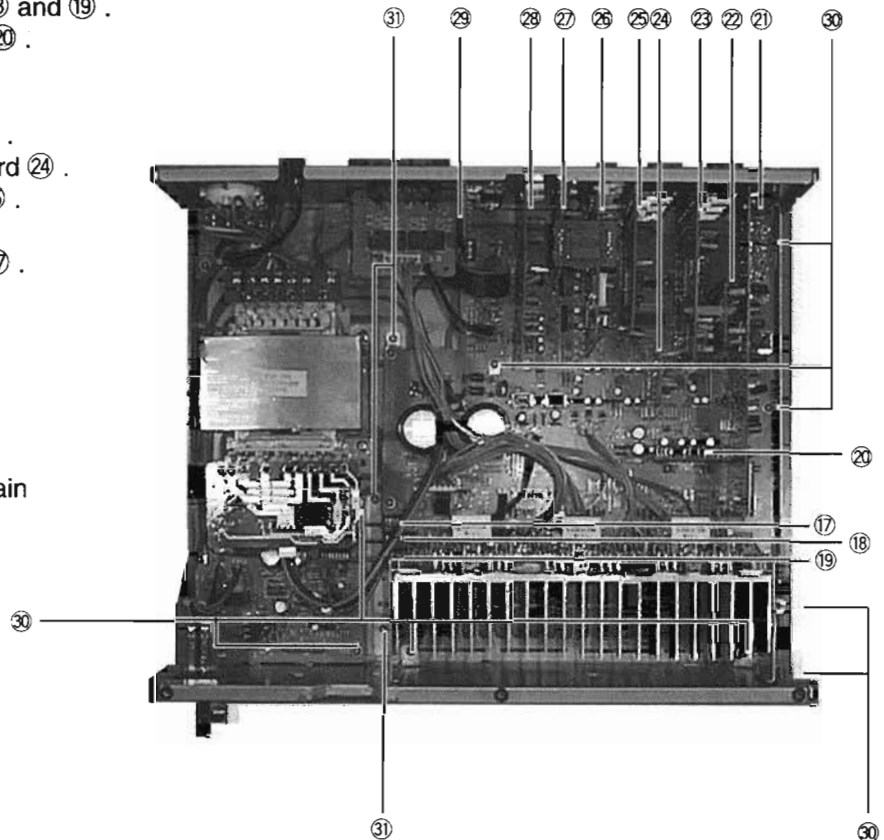

Fig. 7

■ **Removing the Main P.C. board**

( See Fig. 8 )

1. Remove the Top cover.
2. Remove the Front panel.
3. Remove the Rear panel.
4. Remove the Joint P.C.board ⑰ ,⑱ and ⑲ .
5. Remove the Pre amp P.C. board ⑳ .
6. Remove the Tuner P.C. board ㉑ .
7. Remove the SEA P.C. board ㉒ .
8. Remove the Analog P.C. board ㉓ .
9. Remove the Center tone P.C. board ㉔ .
10. Remove the V-Audio P.C. board ㉕ .
11. Remove the Video P.C. board ㉖ .
12. Remove the S-Video P.C. board ㉗ .
13. Remove the Dolby P.C. board ㉘ .
14. Remove the TXT Compulink P.C. board ㉙ .
15. Remove the nine screws ⑳ and remove the three screws ㉚ .
16. The Main P.C. board slide to right way and lift up right side of the Main P.C. board.

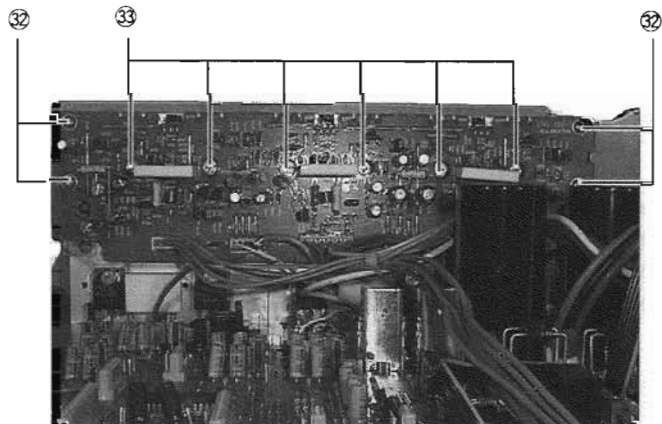

**Fig. 8**

■ **Removing the Amp P.C. board**

( See Fig. 9 )

1. Remove the Top cover.
2. Remove the Front panel.
3. Remove the Rear panel.
4. Remove the Joint P.C. board ⑰ ,⑱ and ⑲ .
5. Remove the Pre amp P.C. board ⑳ .
6. Remove the Tuner P.C. board ㉑ .
7. Remove the SEA P.C. board ㉒ .
8. Remove the Analog P.C. board ㉓ .
9. Remove the Center tone P.C. board ㉔ .
10. Remove the V-Audio P.C. board ㉕ .
11. Remove the Video P.C. board ㉖ .
12. Remove the S-Video P.C. board ㉗ .
13. Remove the Dolby P.C. board ㉘ .
14. Remove the TXT Compulink P.C. board ㉙ .
15. Remove the four screws ⑳ and six screws ㉚ .
16. Remove the Amp P.C. board.



**Fig. 9**



RX-774P/RX-774V

**-MEMO-**

# Block Diagrams

## CPU system

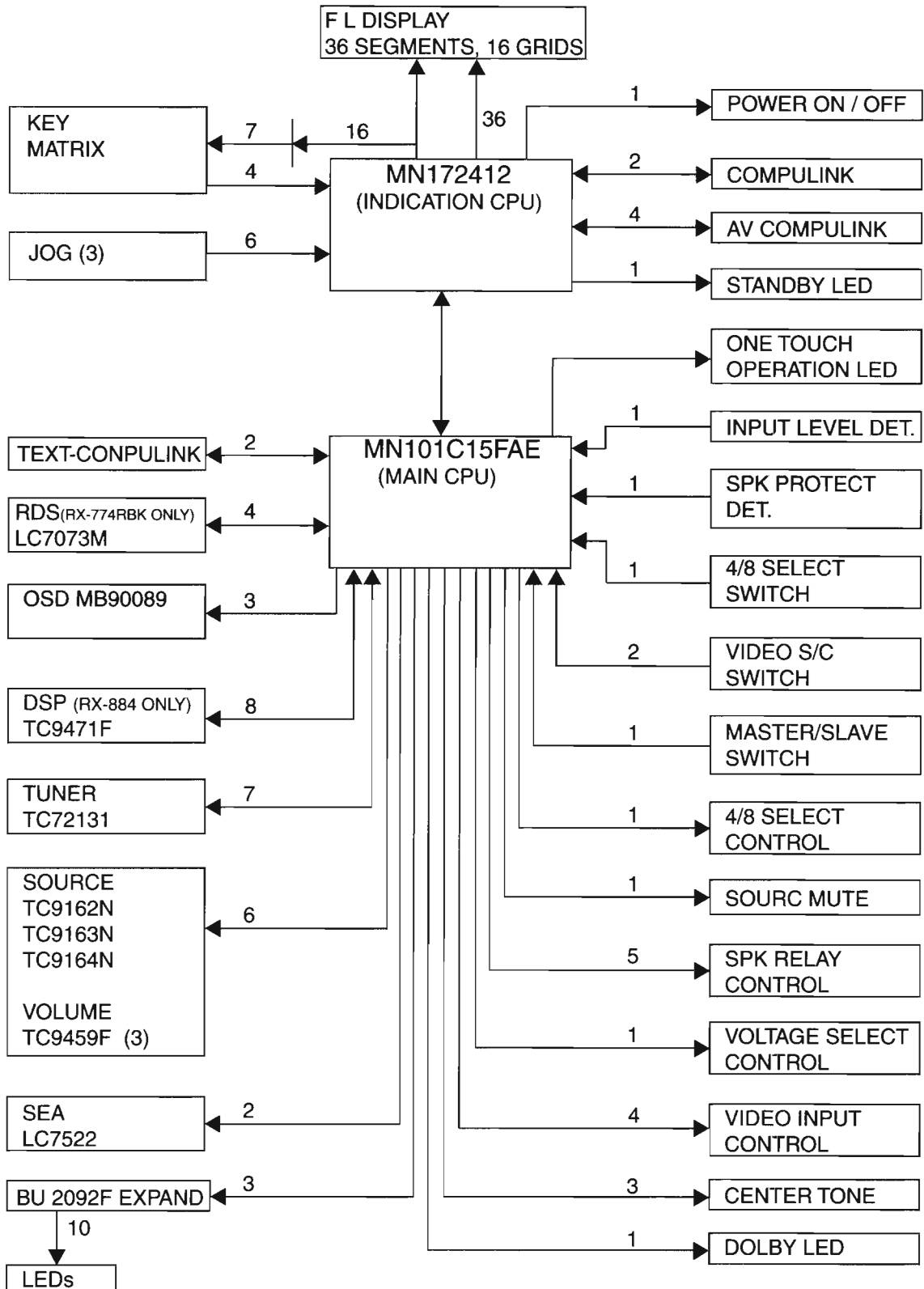

■ Tuner Section

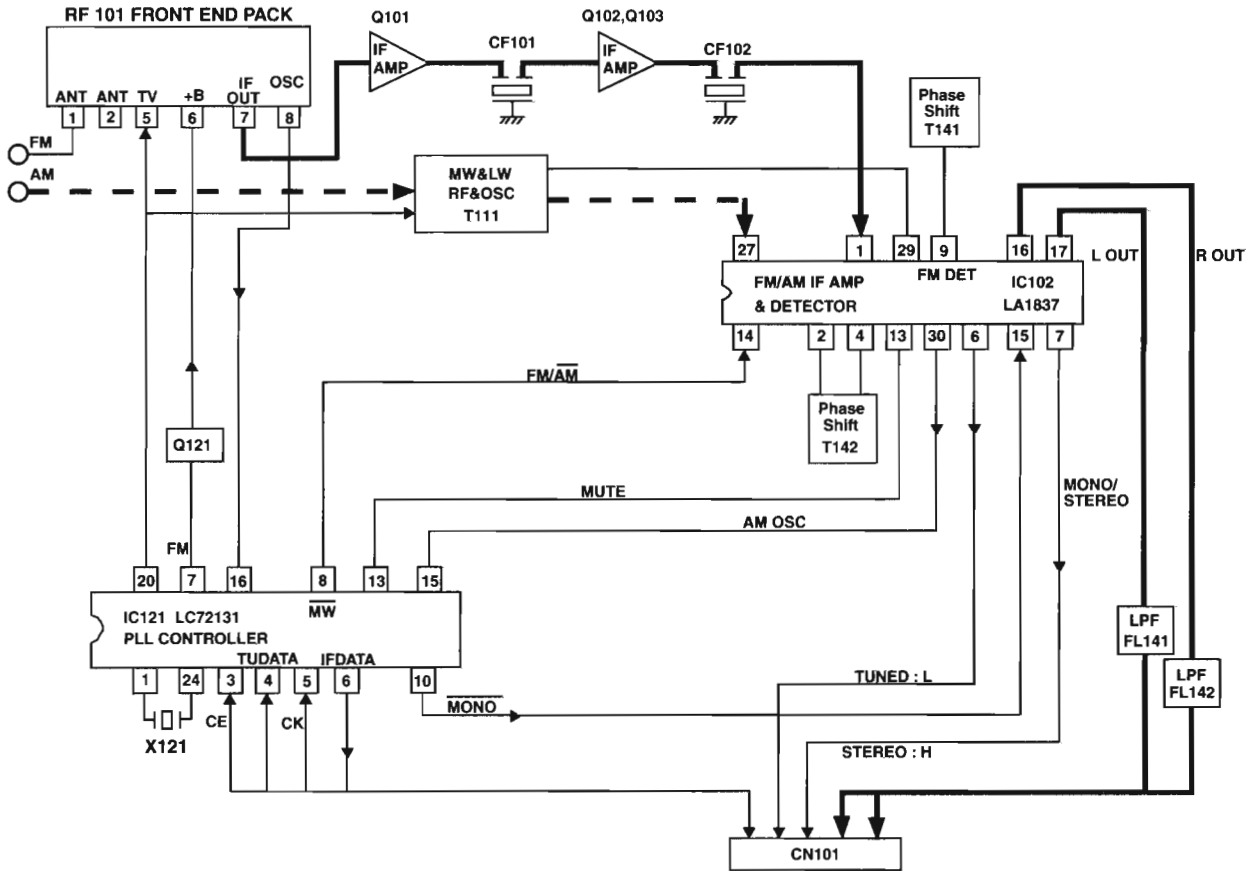





# Block diagram

For RX-774/884/1024

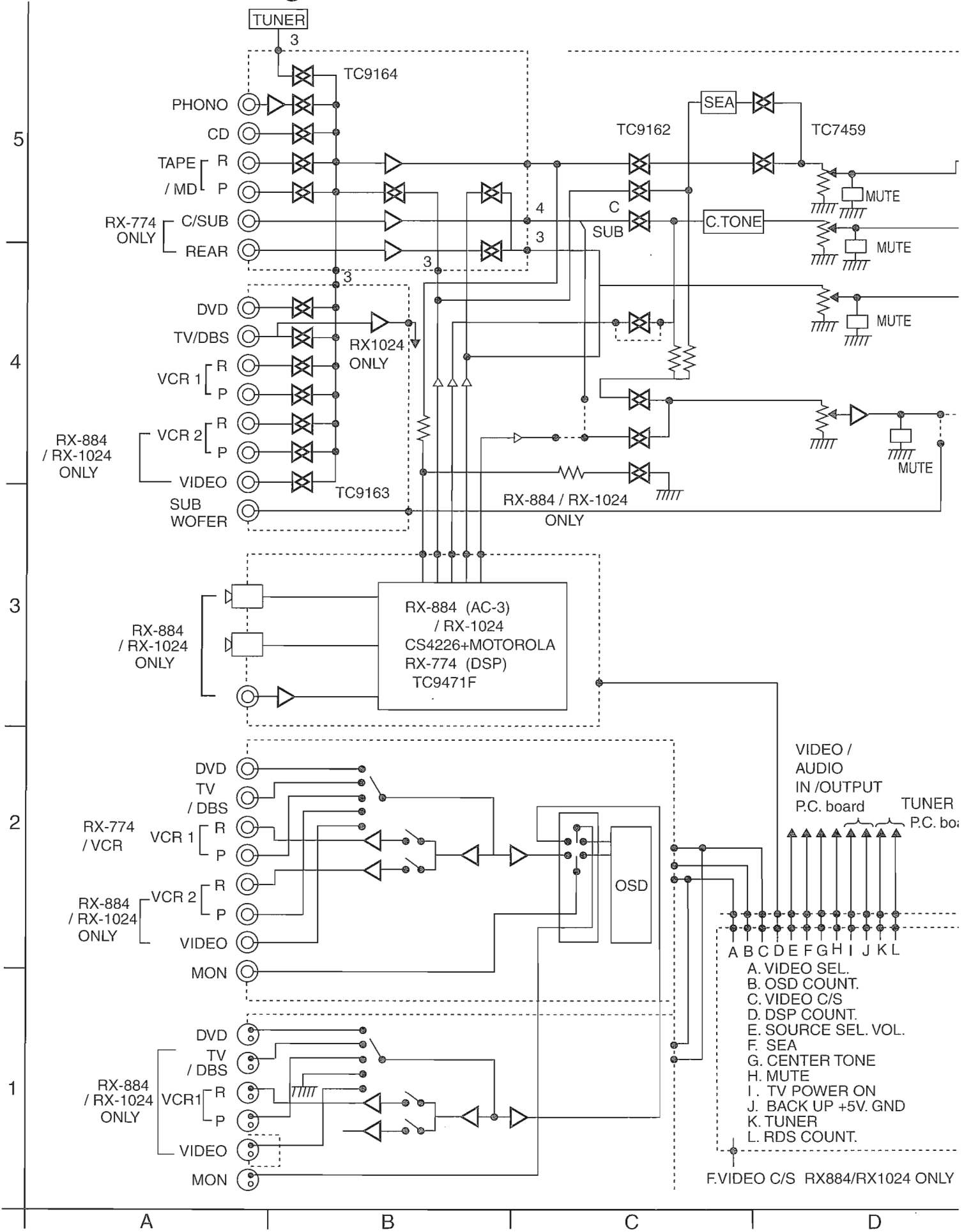

F.VIDEO C/S RX884/RX1024 ONLY

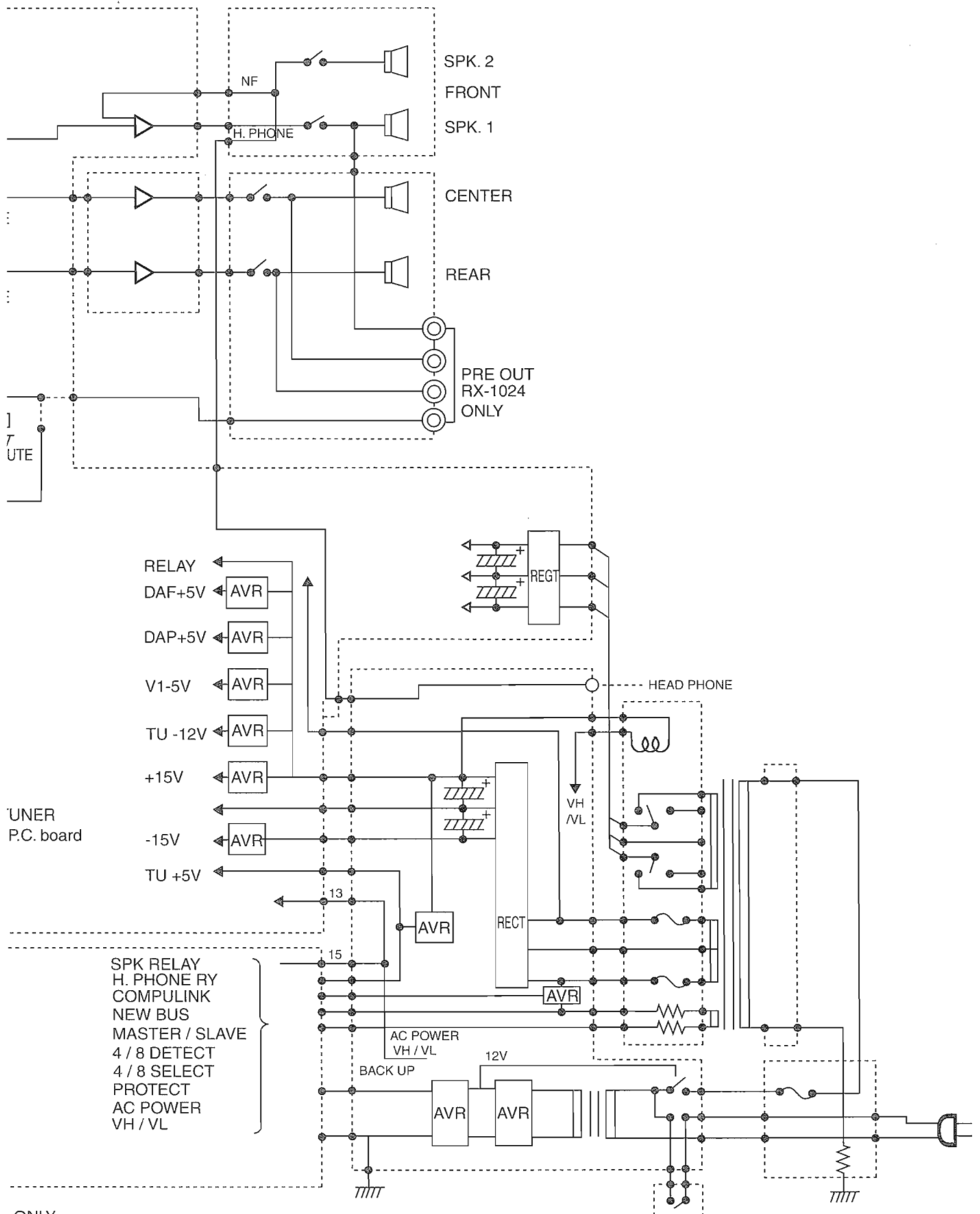

ONLY

# Schematic Diagrams

## POWER PRIMARY SECTION

5

4

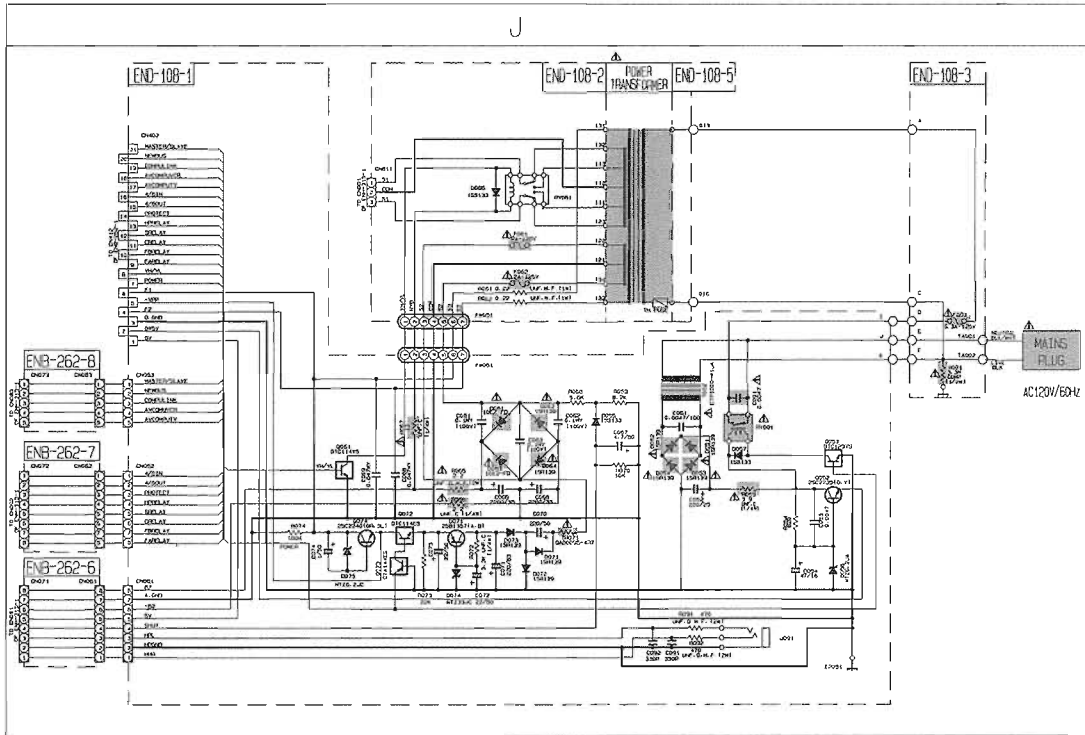

3

2

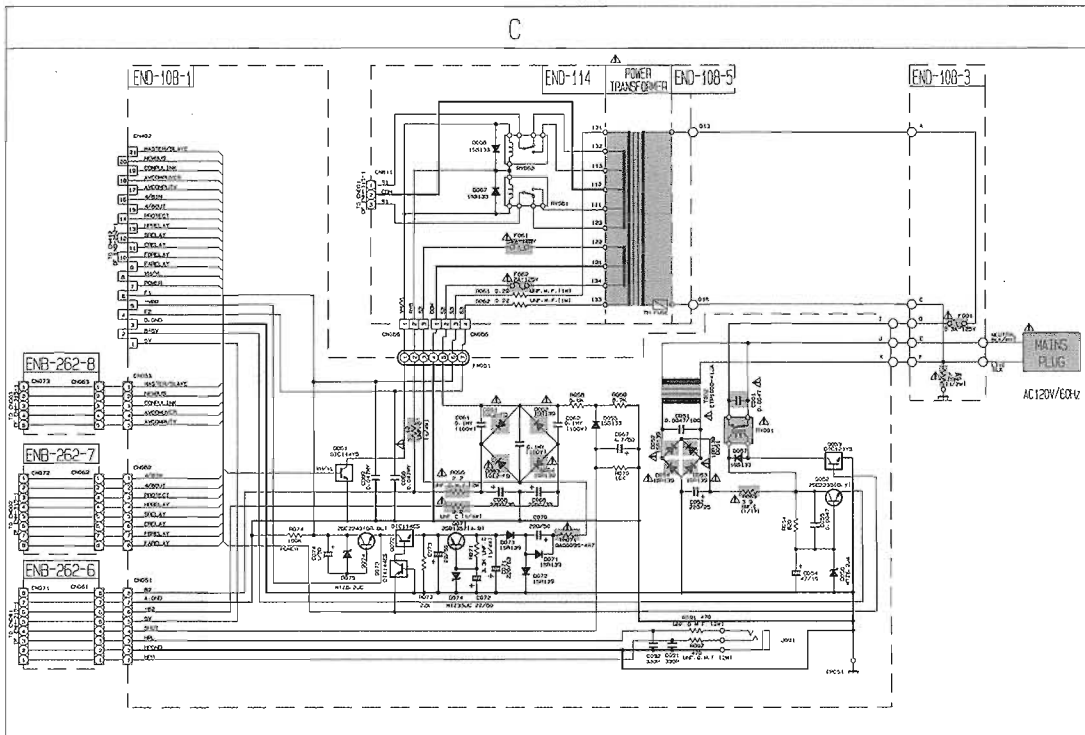

VERSION CODES

- EN: NORDIC COUNTRIES
- E: CONTINENTAL EUROPE
- B: U. K.
- C: CANADA
- J: U. S. A.
- US: SINGAPORE
- UT: TAIWAN
- UF: CHINA
- U: UNIVERSAL, EXCEPT ALL OF ABOVE

SHEET NUMBER	CIRCUIT DESCRIPTION
1/11	REMARK / RECTIFIER
2/11	VOLUME (FRONT/CENTER/REAR) ch. 1 / SEA / SOURCE SELECT IC
3/11	AUDIO AMP (FRONT ch. 1 / SPEAKER TERMINAL (FRONT ch. 1 / REGULATOR / RECTIFIER
4/11	AUDIO AMP (CENTER/REAR ch. 1 / SPEAKER TERMINAL (CENTER/REAR ch. 1
5/11	AUDIO SIGNAL INPUT TERMINAL / SOURCE SELECT IC / SYSTEMCONTROL SIGNAL TERMINAL
6/11	VIDEO SIGNAL INPUT TERMINAL / SOURCE SELECT IC
7/11	USER CONTROL KEYS / SYSTEMCONTROL LSI / FL DISPLAY
8/11	SUPERFREQ TC
9/11	TUNER (ONLY C/U)
10/11	TUNER (ONLY B/E/EN)
11/11	TUNER (ONLY U/AF/AS/UT)

NOTES:  
MARK (\*) IS TO SHOW DEVIATION IN VERSI  
DETAILS ARE EXPLAINED NEAR THE MARK.

EXPLANATION OF OVERALL  
RX-774BK/RX-774PK/RX-774VK

U / UF / US / UT

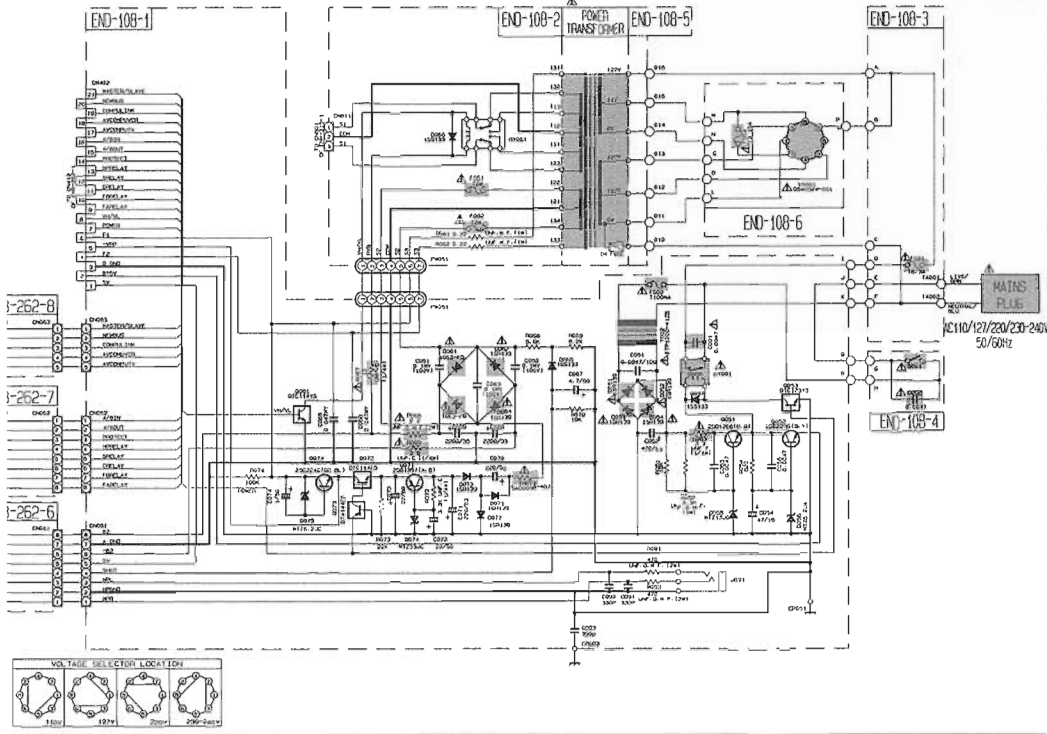

B / E / EN

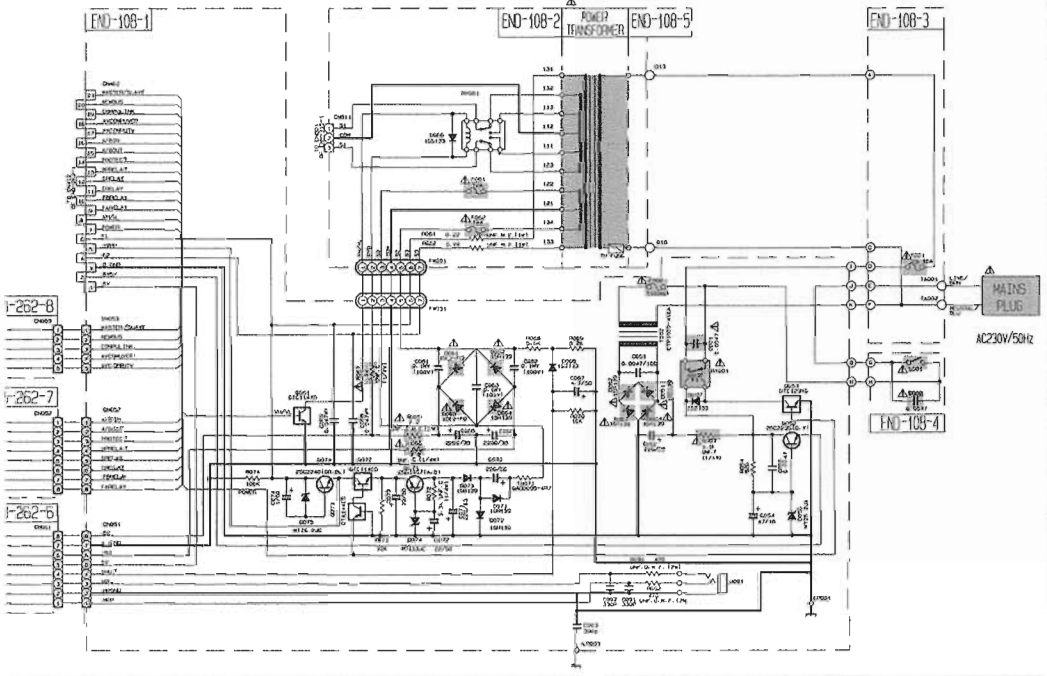

ON IN VERSIONS.  
THE MARK.  
VERALL OF SCHEMA.  
/RX-774PGK/RX-774PGD

⚠ Parts are safety assurance parts.  
When replacing those parts make  
sure to use the specified one.



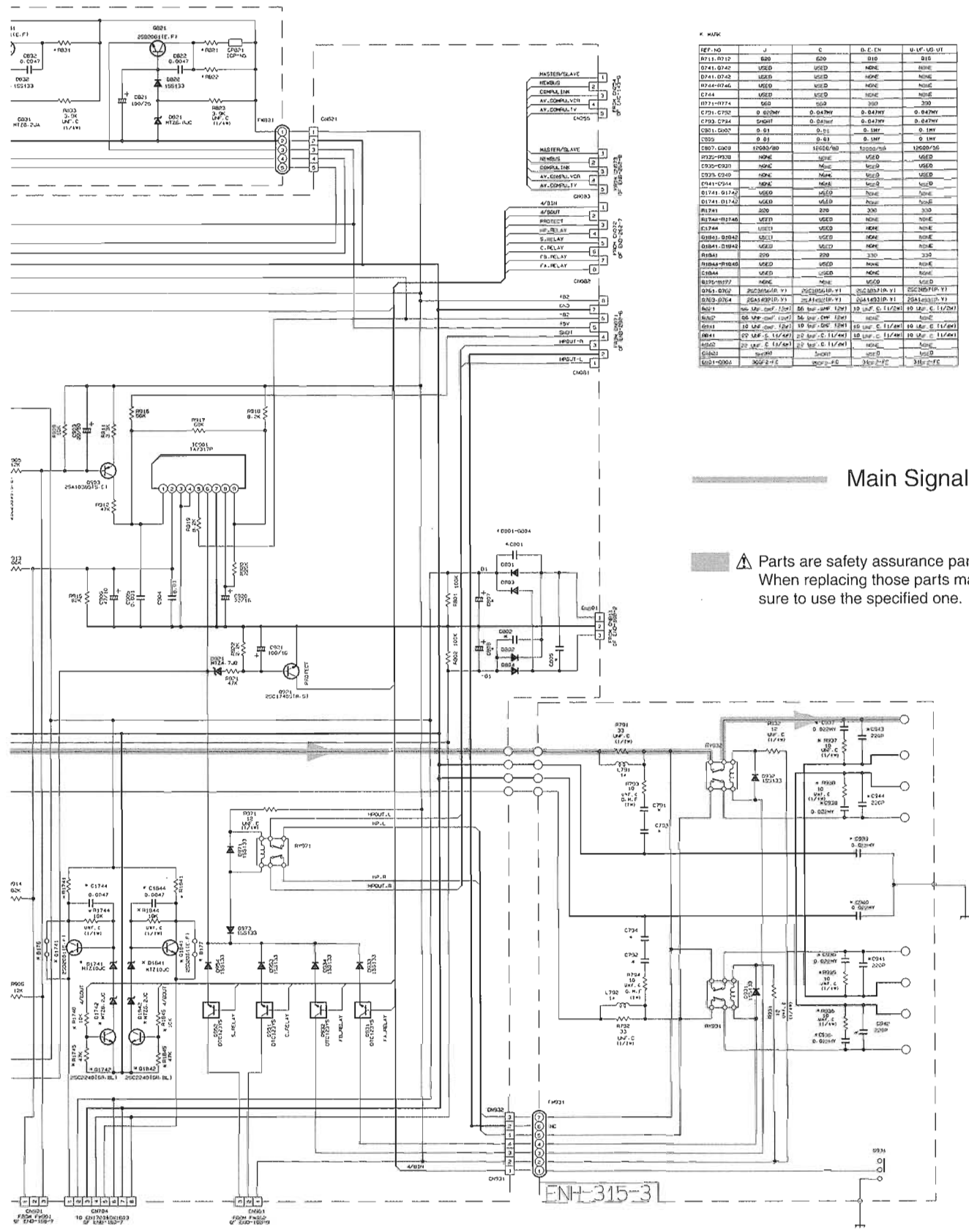

\* MARK

REF. NO	J	C	D. E. EN	U. LF. US. UT
R711-R712	620	620	010	010
D741-D742	USED	USED	NONE	NONE
D744-D746	USED	USED	NONE	NONE
C744	USED	USED	NONE	NONE
D771-D774	200	200	200	200
C731-C732	0.000V	0.047V	0.047V	0.047V
C733-C734	500V	0.047V	0.047V	0.047V
C801-C802	0.01	0.01	0.1M	0.1M
C803	0.01	0.01	0.1M	0.1M
C807-C808	10000/100	10000/100	10000/100	10000/100
R732-R733	NONE	NONE	USED	USED
C930-C931	NONE	NONE	USED	USED
C932-C933	NONE	NONE	USED	USED
D741-D744	NONE	NONE	USED	USED
D1741-D1742	USED	USED	NONE	NONE
D1741-D1742	USED	USED	NONE	NONE
R1741	200	200	200	200
D1744-D1746	USED	USED	NONE	NONE
C1744	USED	USED	NONE	NONE
D1841-D1842	USED	USED	NONE	NONE
D1841-D1842	USED	USED	NONE	NONE
R1841	200	200	200	200
R1844-R1846	USED	USED	NONE	NONE
C1844	USED	USED	NONE	NONE
R1771-R1777	NONE	NONE	USED	USED
D764-D765	200/200/100 V1	200/200/100 V1	200/200/100 V1	200/200/100 V1
D763-D764	200/200/100 V1	200/200/100 V1	200/200/100 V1	200/200/100 V1
R601	100 MVA 117/117	100 MVA 117/117	100 MVA 117/117	100 MVA 117/117
R602	100 MVA 117/117	100 MVA 117/117	100 MVA 117/117	100 MVA 117/117
R603	100 MVA 117/117	100 MVA 117/117	100 MVA 117/117	100 MVA 117/117
R604	100 MVA 117/117	100 MVA 117/117	100 MVA 117/117	100 MVA 117/117
R605	100 MVA 117/117	100 MVA 117/117	100 MVA 117/117	100 MVA 117/117
C601	100 MVA 117/117	100 MVA 117/117	100 MVA 117/117	100 MVA 117/117
C602	100 MVA 117/117	100 MVA 117/117	100 MVA 117/117	100 MVA 117/117

Main Signal

⚠ Parts are safety assurance parts. When replacing those parts make sure to use the specified one.

REAR / CENTER AMP. SECTION

END-108-7

5

4

3

2

1

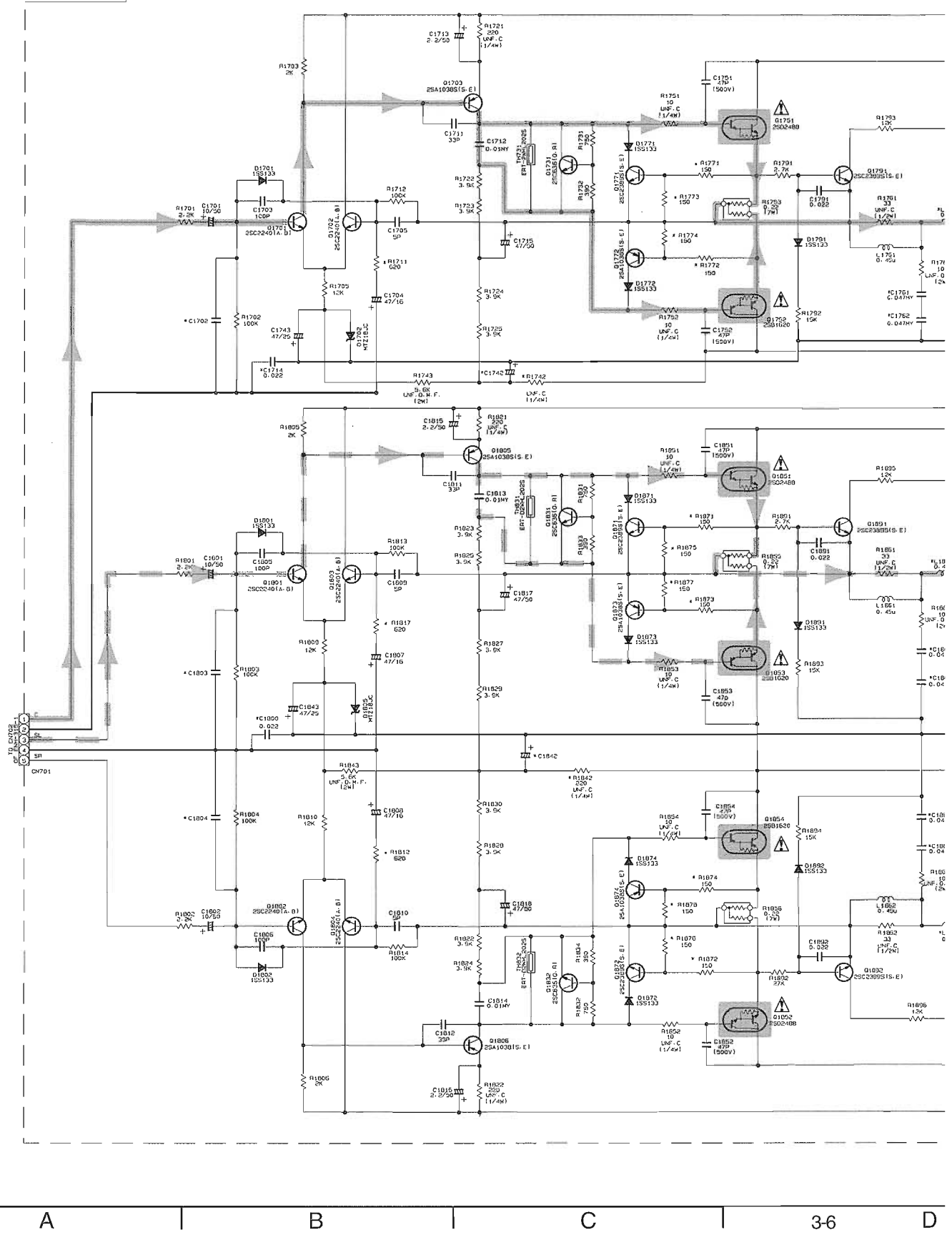

A | B | C | 3-6 | D





# AUDIO SELECTOR SECTION

5

4

3

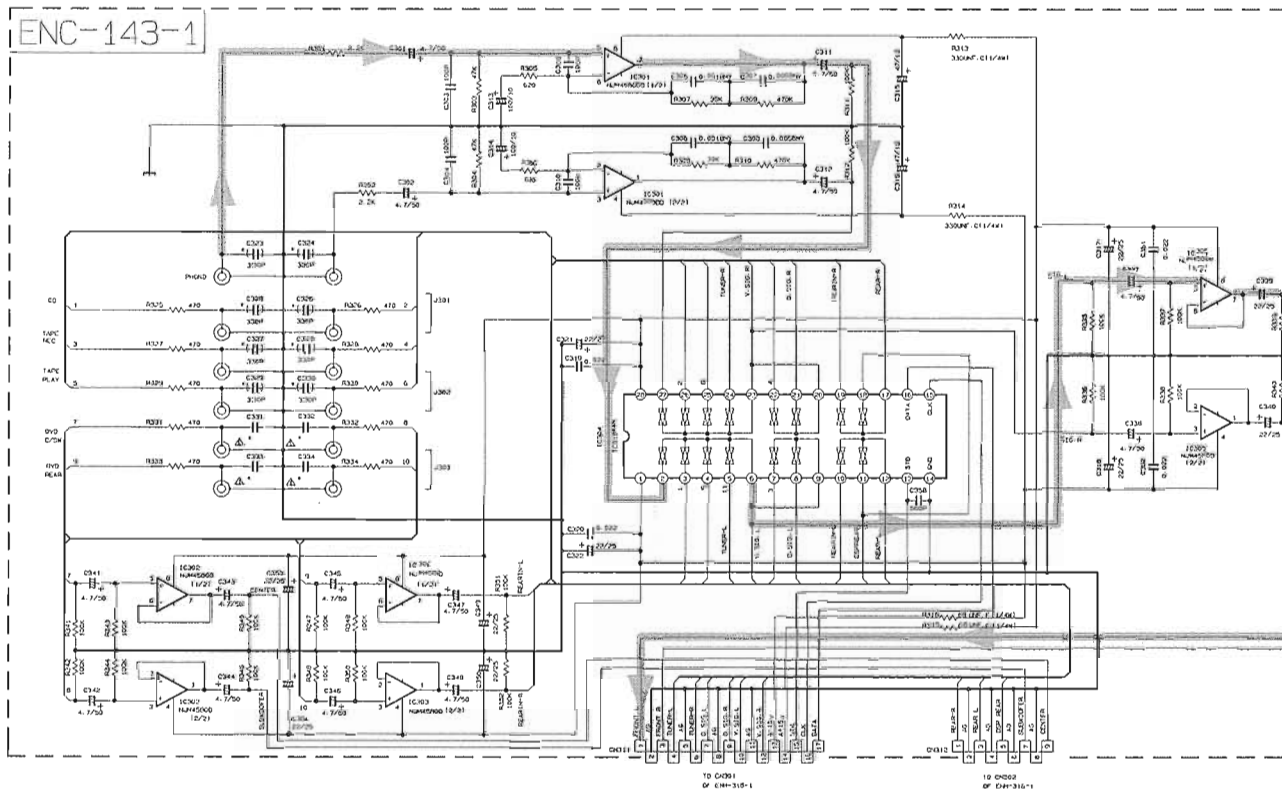

2

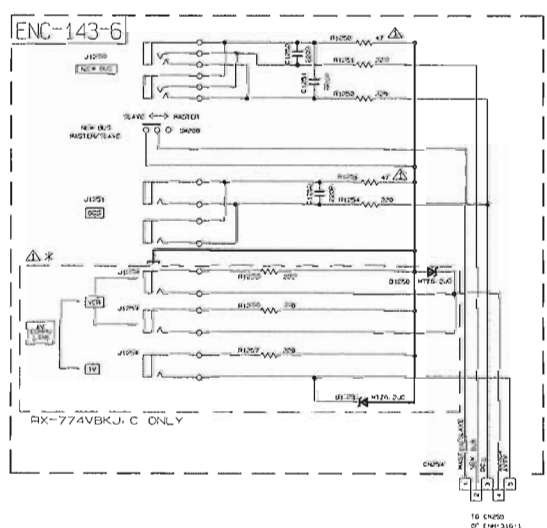

\*MARK LIST

	FX-774BKB B, E, EN	RX-774VBK J, C, U, UT	RX- U, UF
C323-C330	USED	NONE	
C377-C384	USED	NONE	
C331-C334	390P	330P	

--- RX-774VBKJ, C ONLY

1



VIDEO SECTION

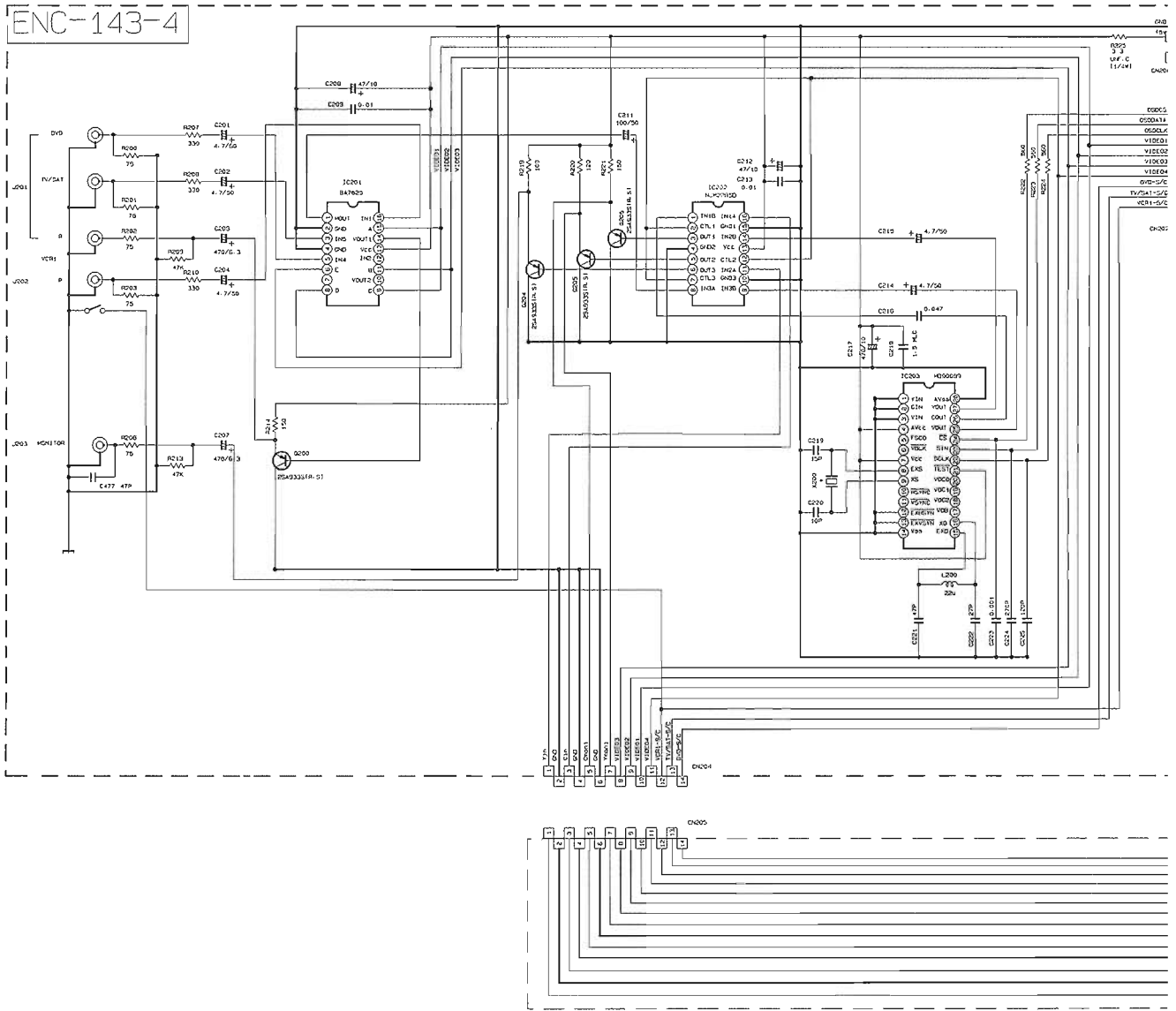

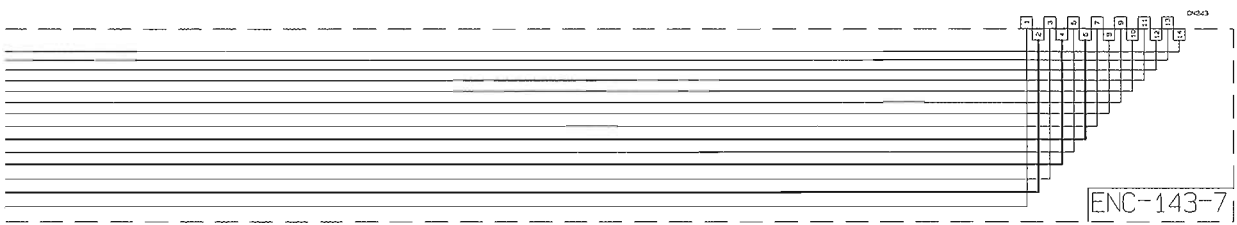
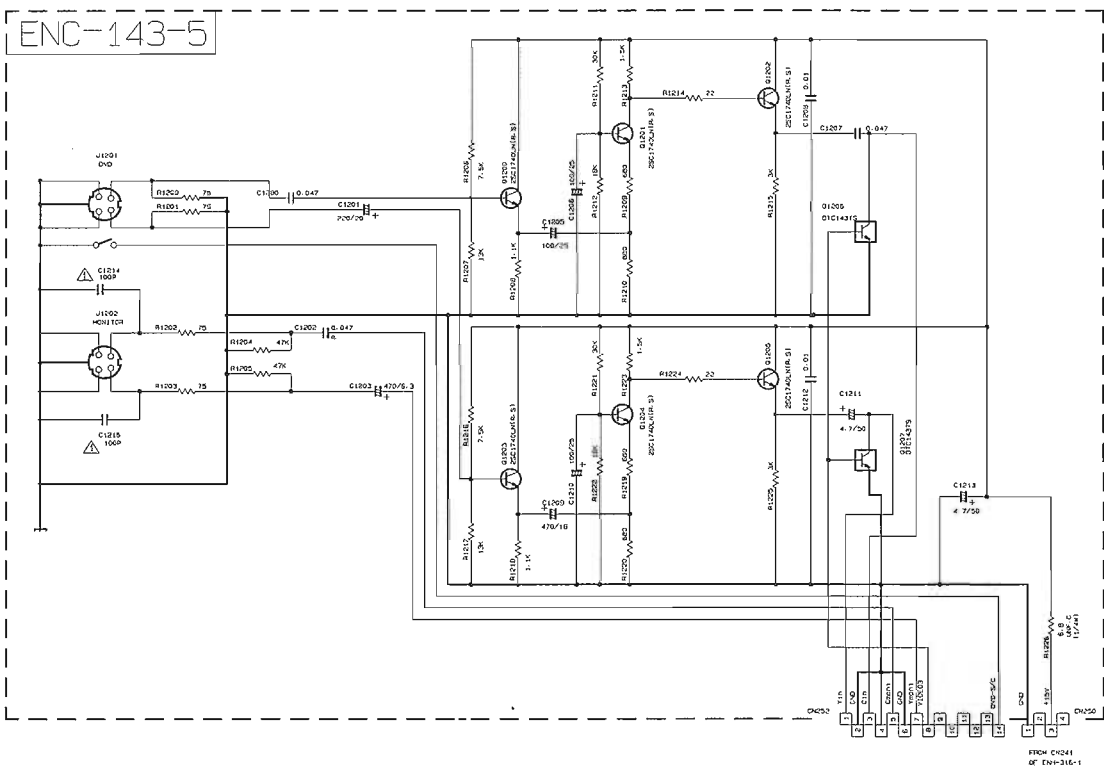
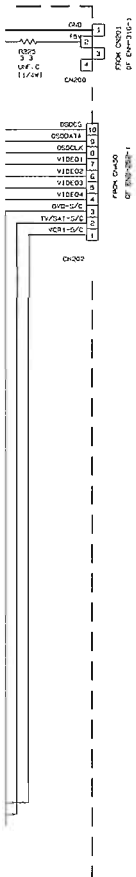





FL / SYSTEM CONTROL SECTION

ENB-262-1

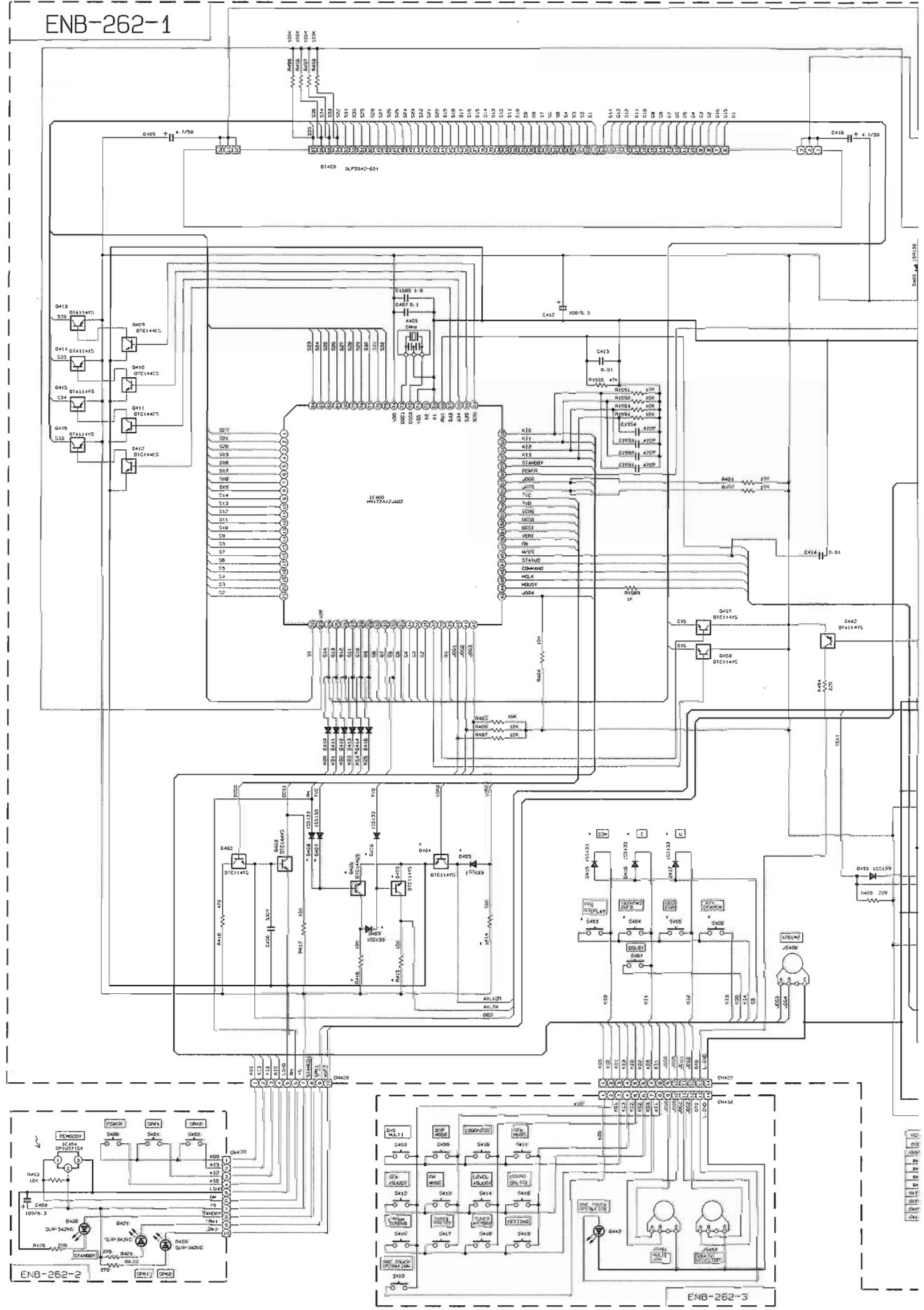

5

4

3

2

1

A

B

C

3-10

D



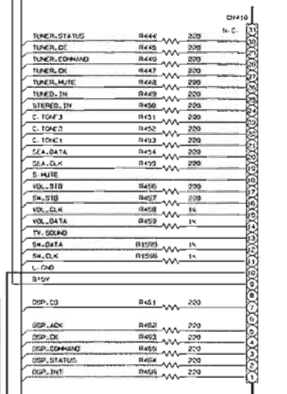
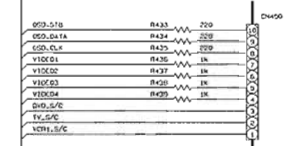
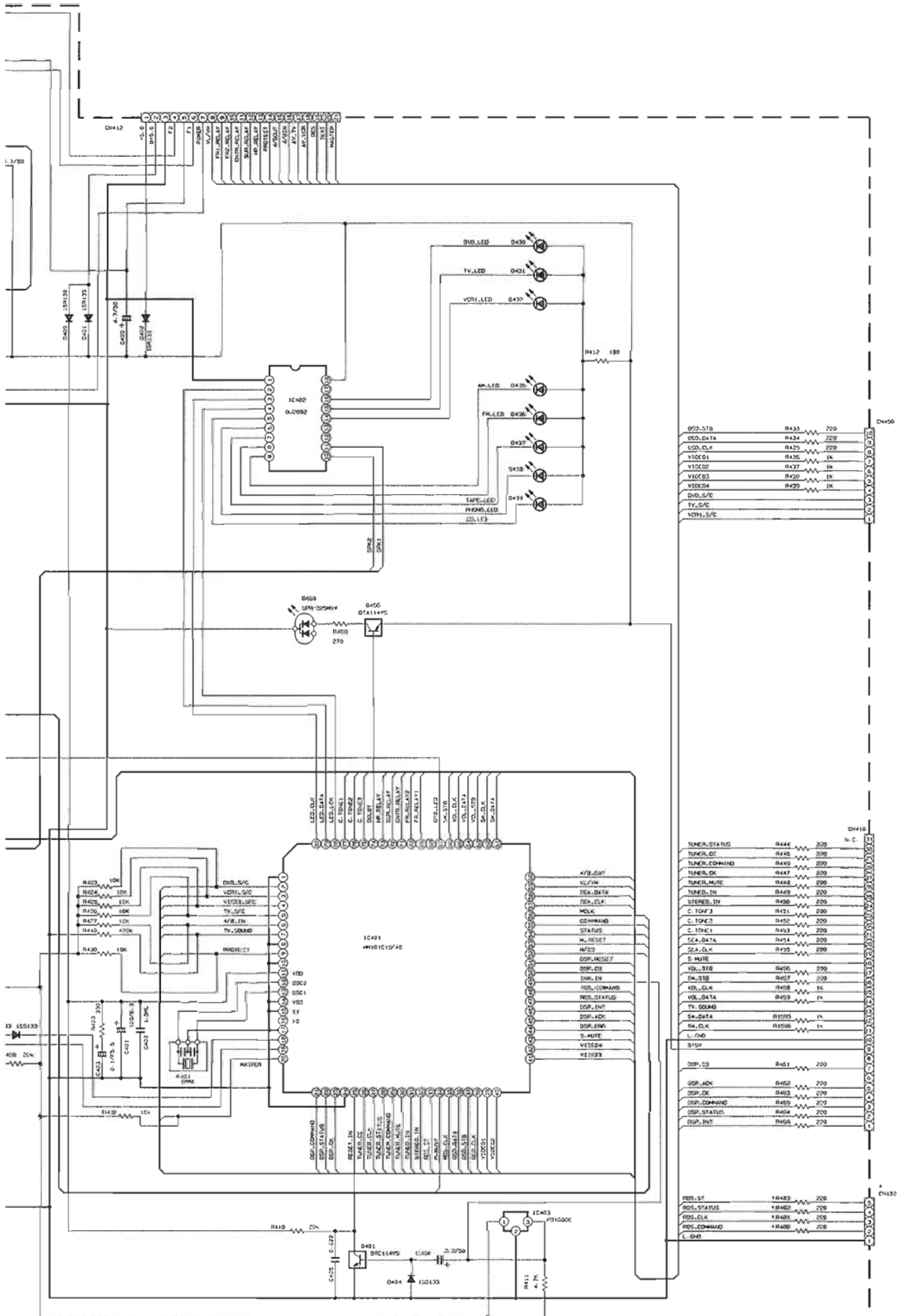

VERT.	OSM	1-10	11-20	21-30	31-40
D410P	NS	NS	NS	NS	NS
D410S	NS	NS	NS	NS	NS
D414	NS	NS	NS	NS	NS
D415	NS	NS	NS	NS	NS
D416	NS	NS	NS	NS	NS
D417	NS	NS	NS	NS	NS
D418	NS	NS	NS	NS	NS
D419	NS	NS	NS	NS	NS
D420	NS	NS	NS	NS	NS
D421	NS	NS	NS	NS	NS
D422	NS	NS	NS	NS	NS
D423	NS	NS	NS	NS	NS
D424	NS	NS	NS	NS	NS
D425	NS	NS	NS	NS	NS
D426	NS	NS	NS	NS	NS
D427	NS	NS	NS	NS	NS
D428	NS	NS	NS	NS	NS
D429	NS	NS	NS	NS	NS
D430	NS	NS	NS	NS	NS
D431	NS	NS	NS	NS	NS
D432	NS	NS	NS	NS	NS
D433	NS	NS	NS	NS	NS
D434	NS	NS	NS	NS	NS
D435	NS	NS	NS	NS	NS
D436	NS	NS	NS	NS	NS
D437	NS	NS	NS	NS	NS
D438	NS	NS	NS	NS	NS
D439	NS	NS	NS	NS	NS
D440	NS	NS	NS	NS	NS

■ DOLBY PROLOGIC SECTION

ENB-262-4

——— Main Signal  
 - - - Center Signal  
 - · - · Surround Signal

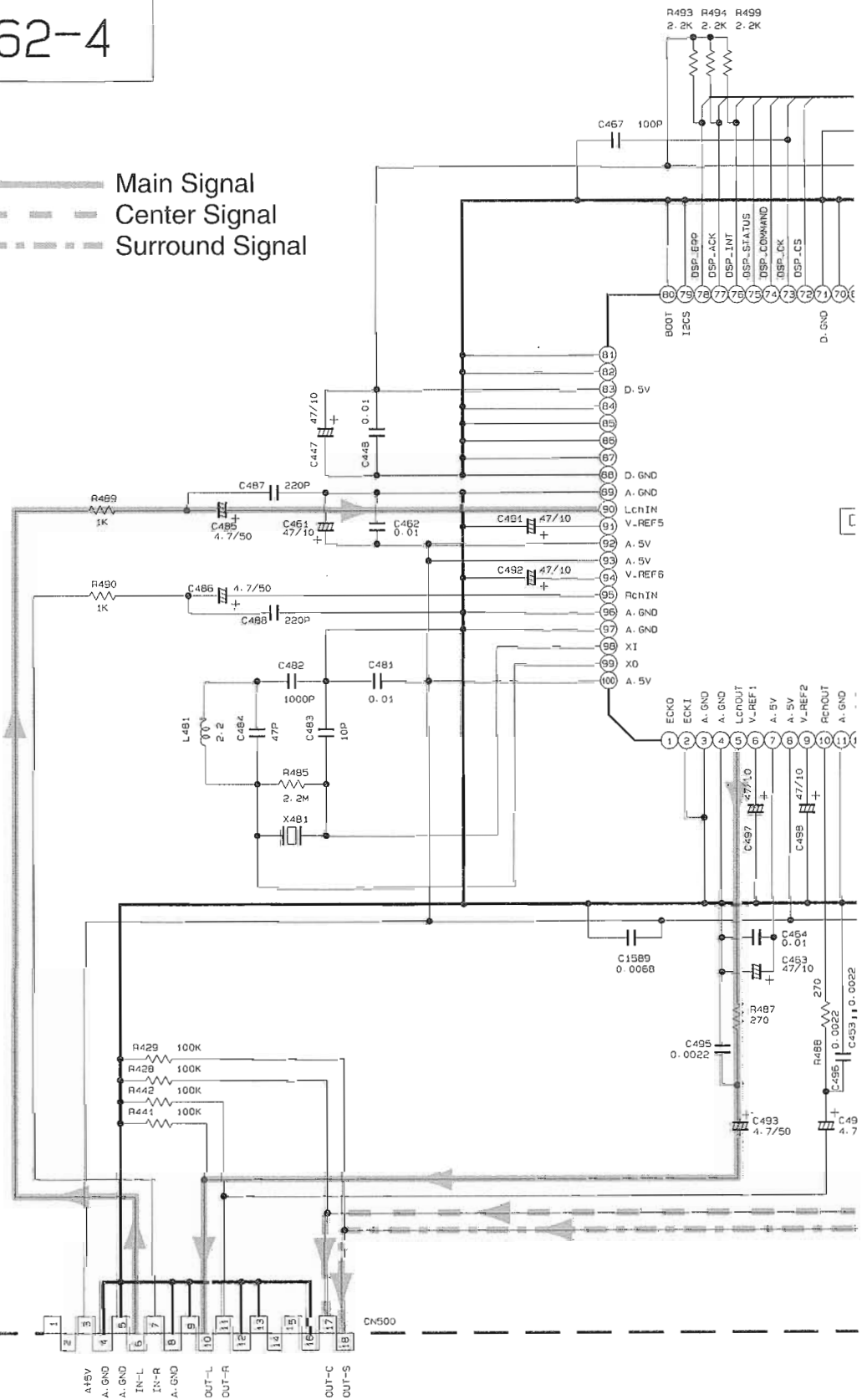

FROM CN500  
OF ENH-315-1

A B C D

5  
4  
3  
2  
1

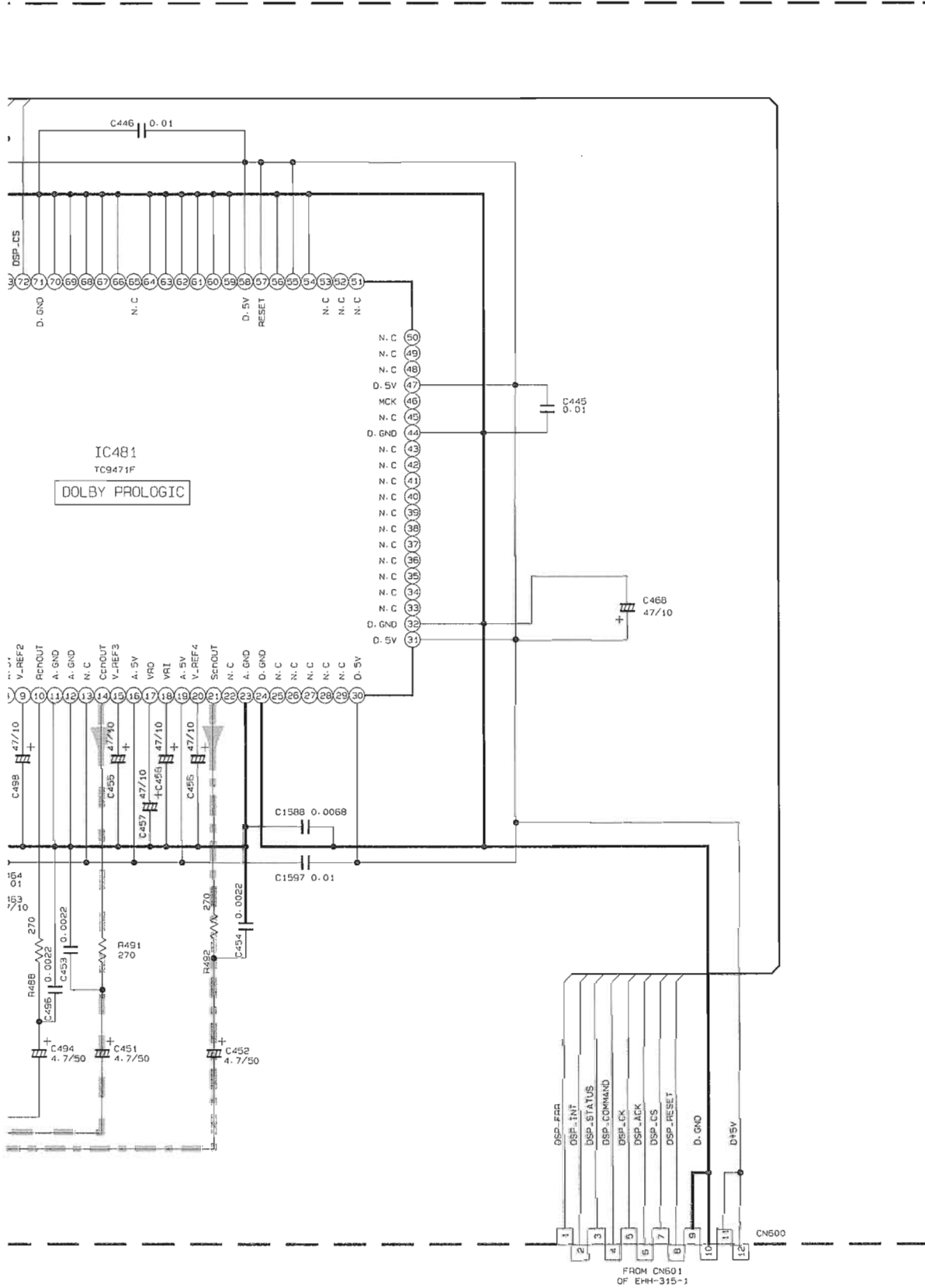

FROM CN501  
OF EHT-315-1



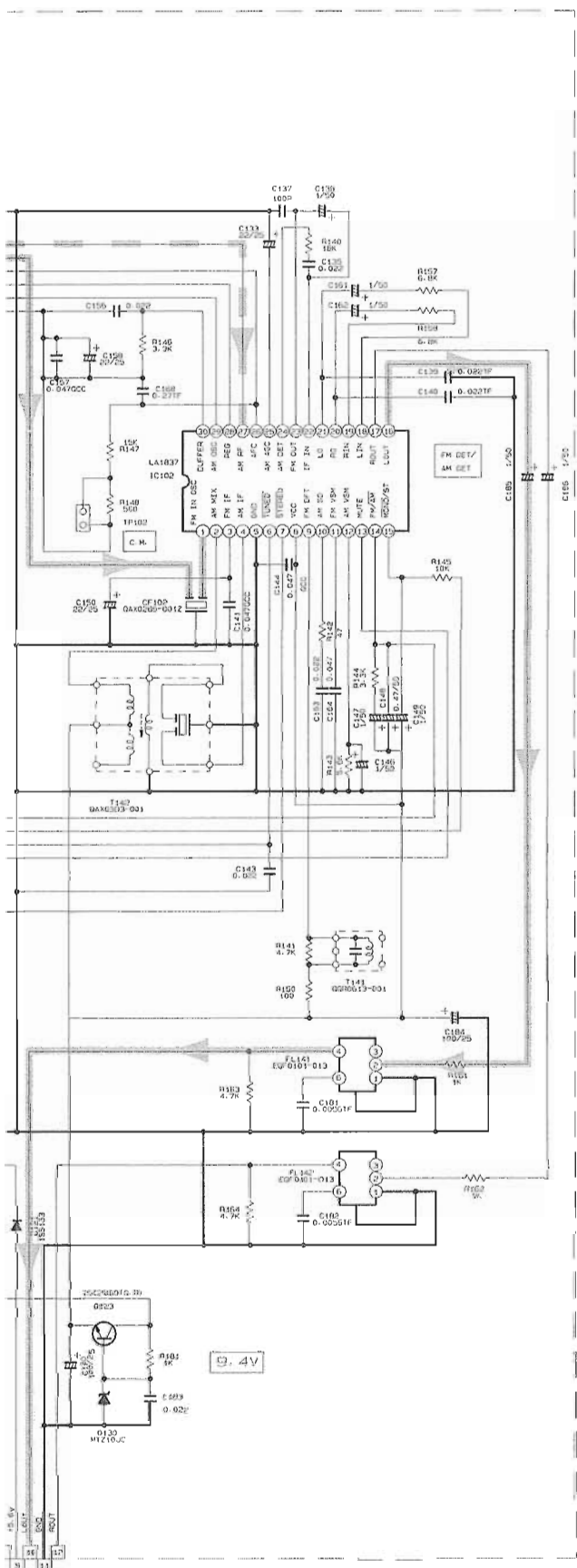

RF 101  
EAF2207-001

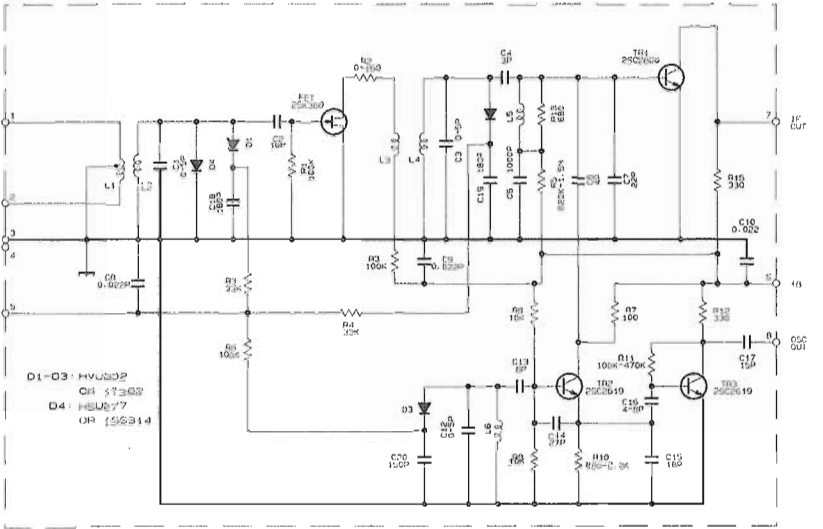

FM Signal  
AM Signal



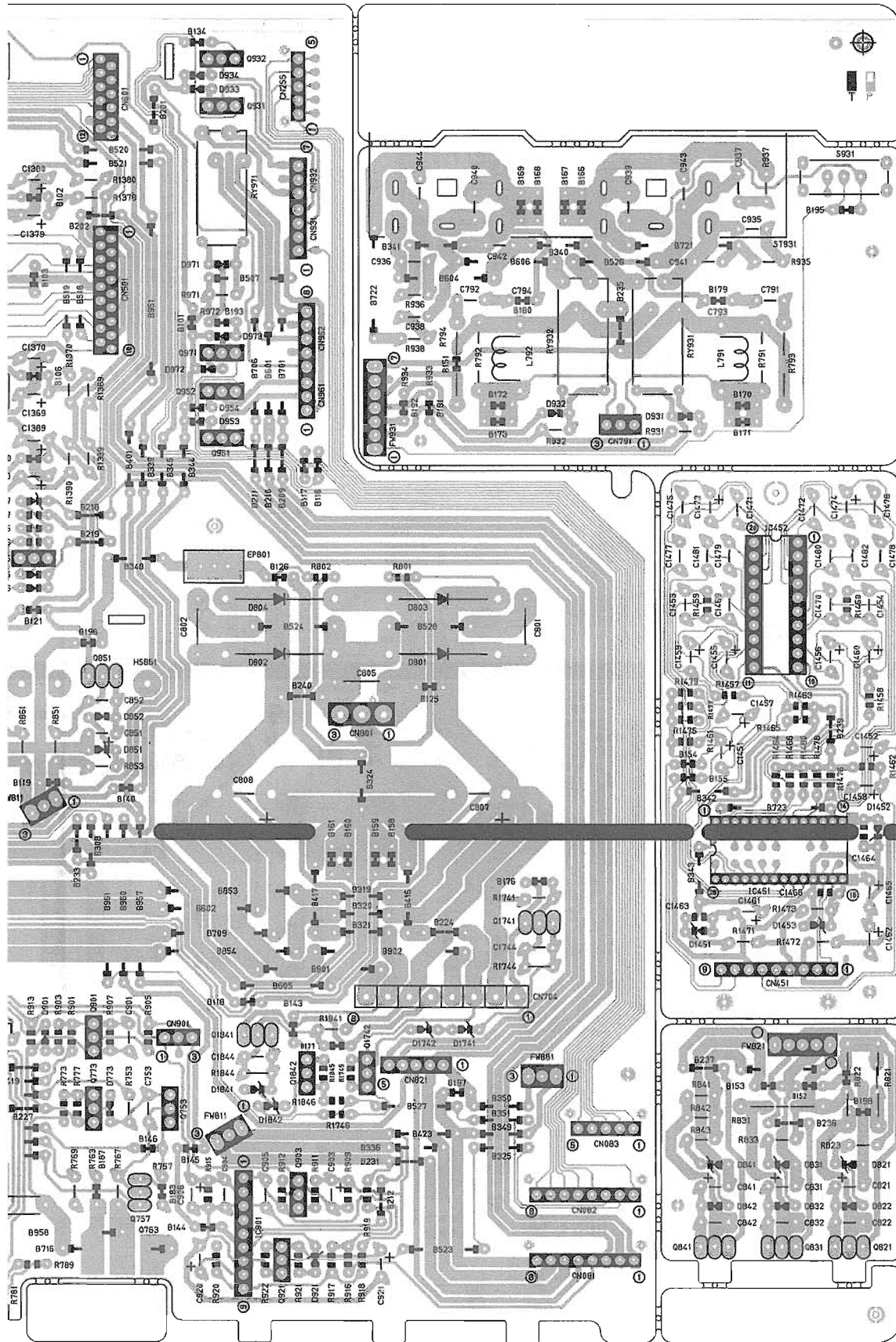

E

F

G

■ Front P.C. Board

5

4

3

2

1

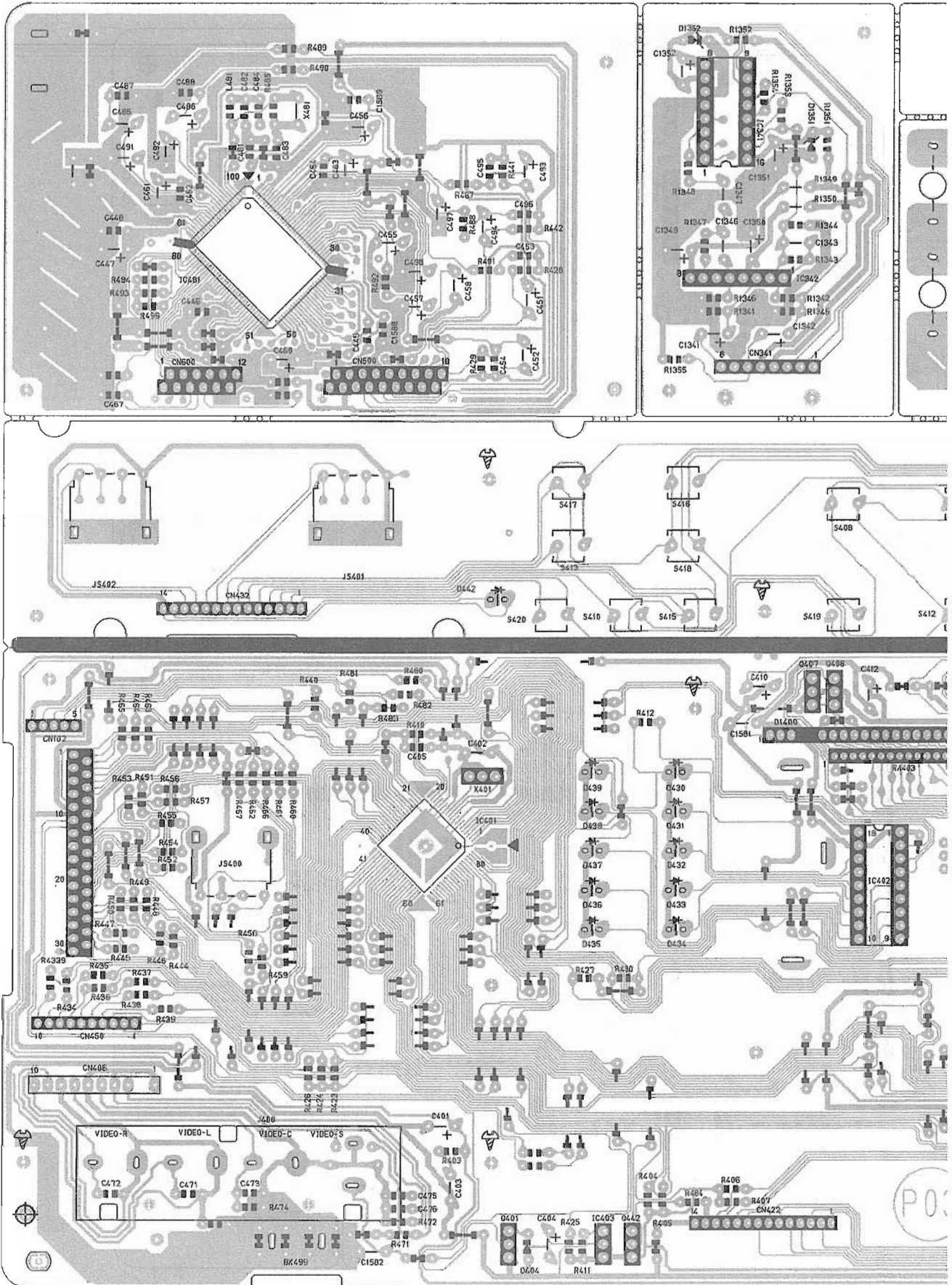

A

B

C

3-14

D



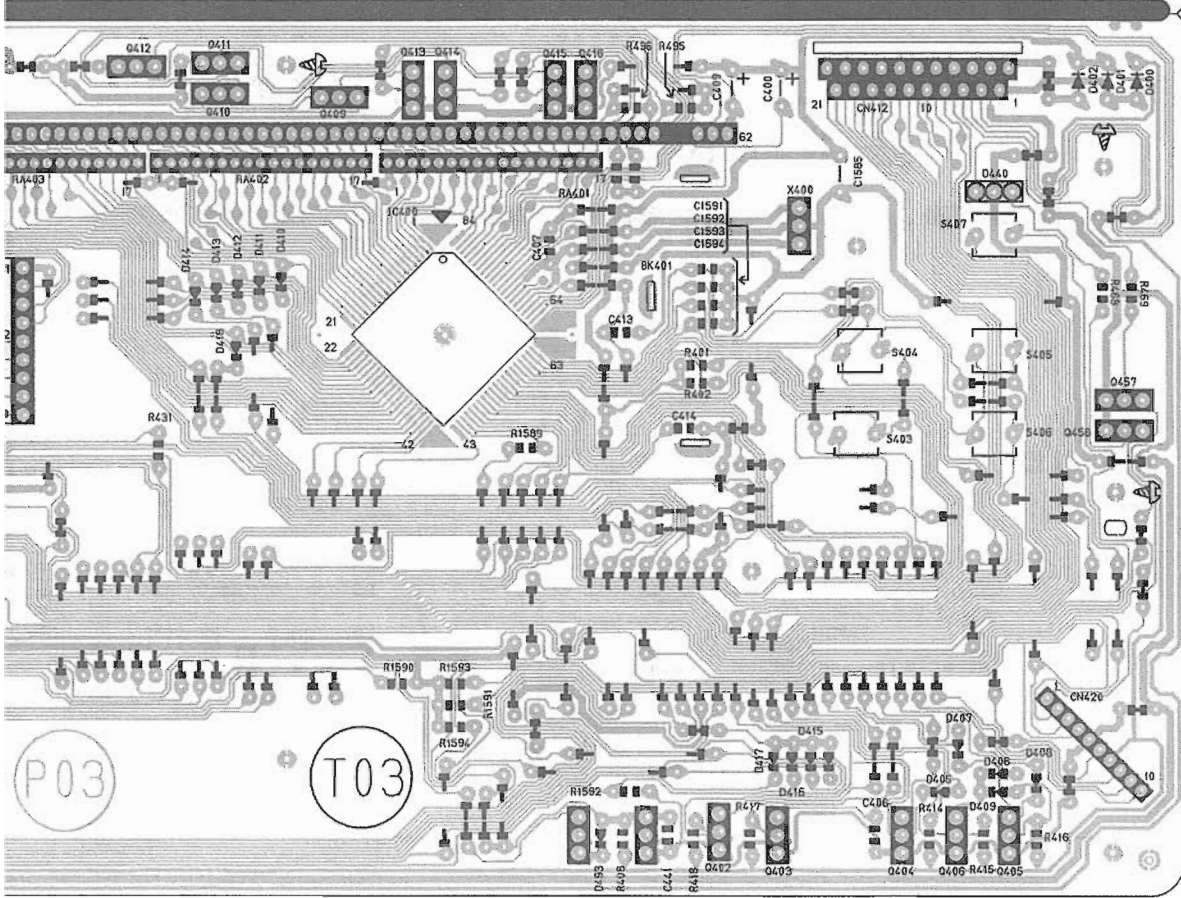
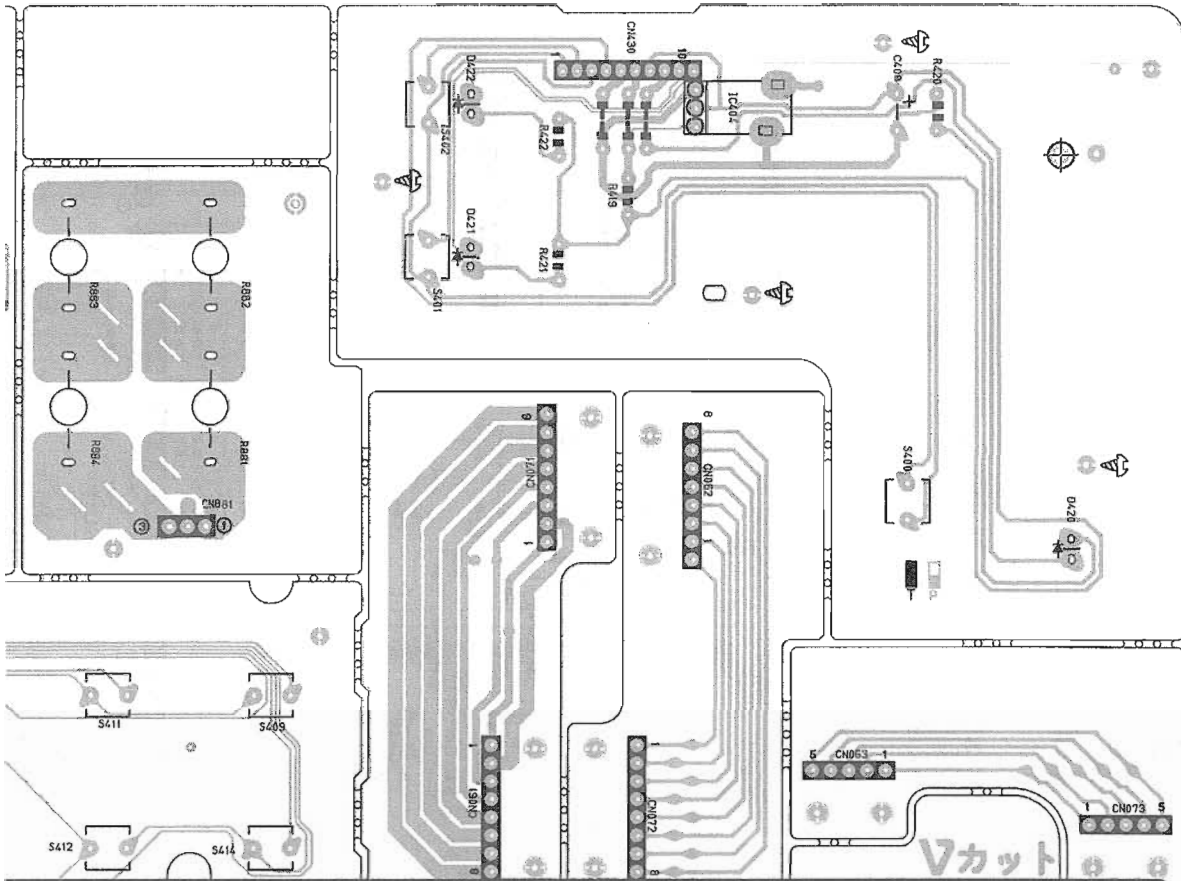

P03 T03

D | E | F | G | H

■ Control P.C. Board

5

4

3

2

1

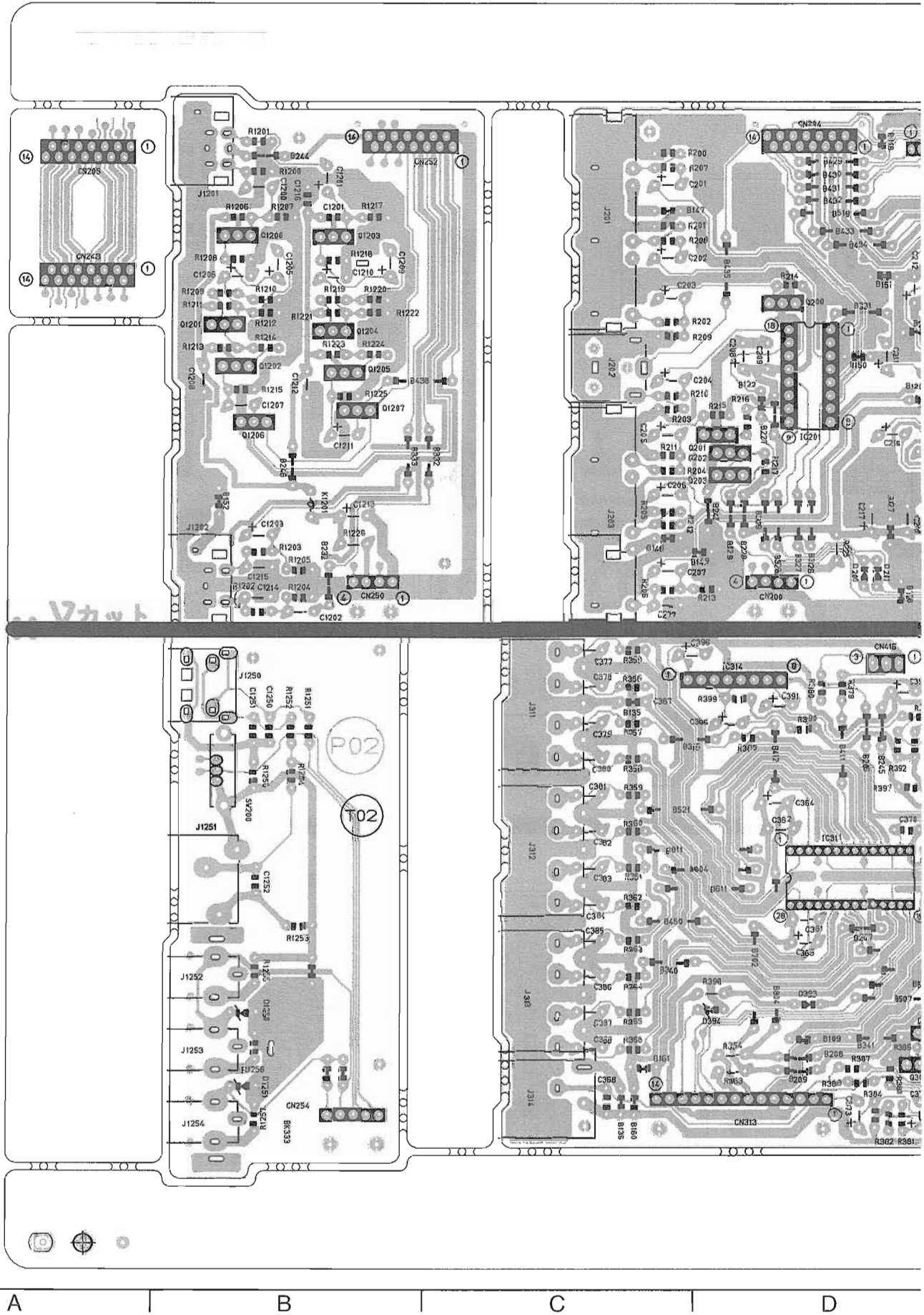

A

B

C

D



■ AC Supply P.C. Board

5  
4  
3  
2  
1

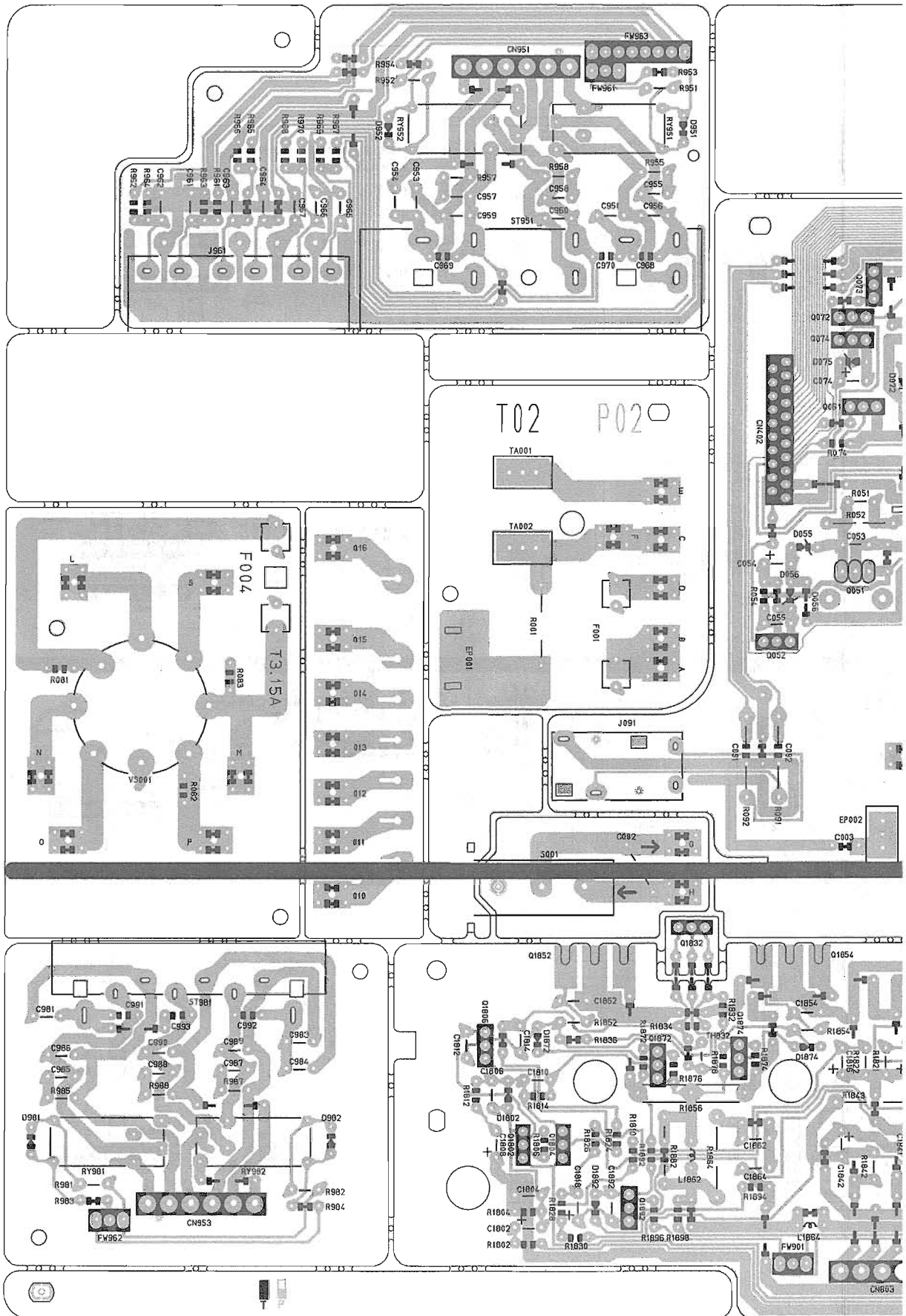

A B C 3-16 D

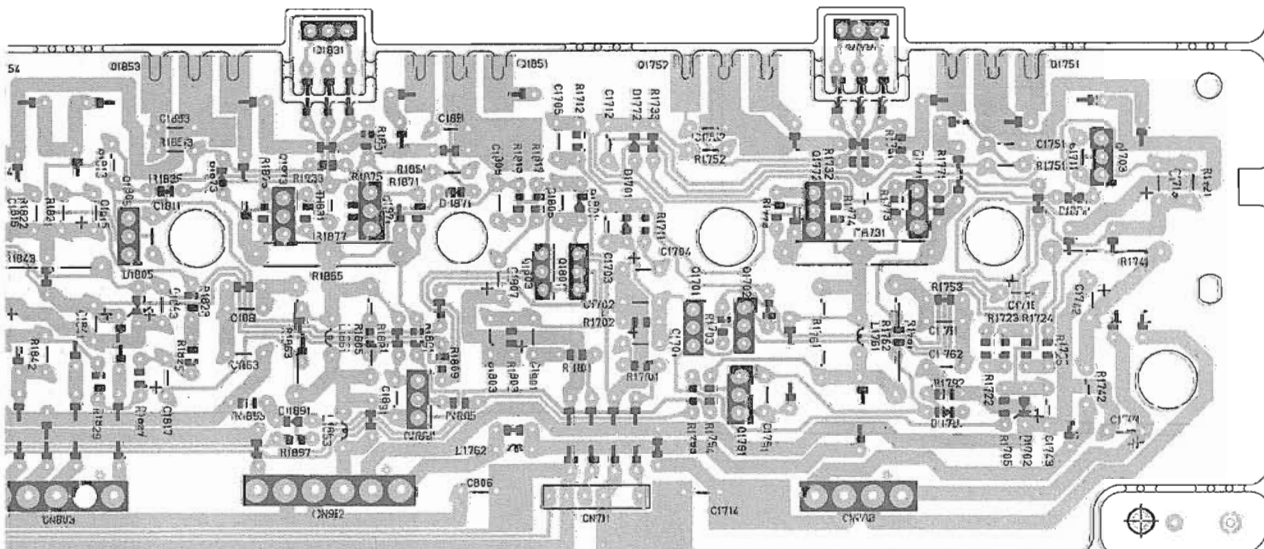
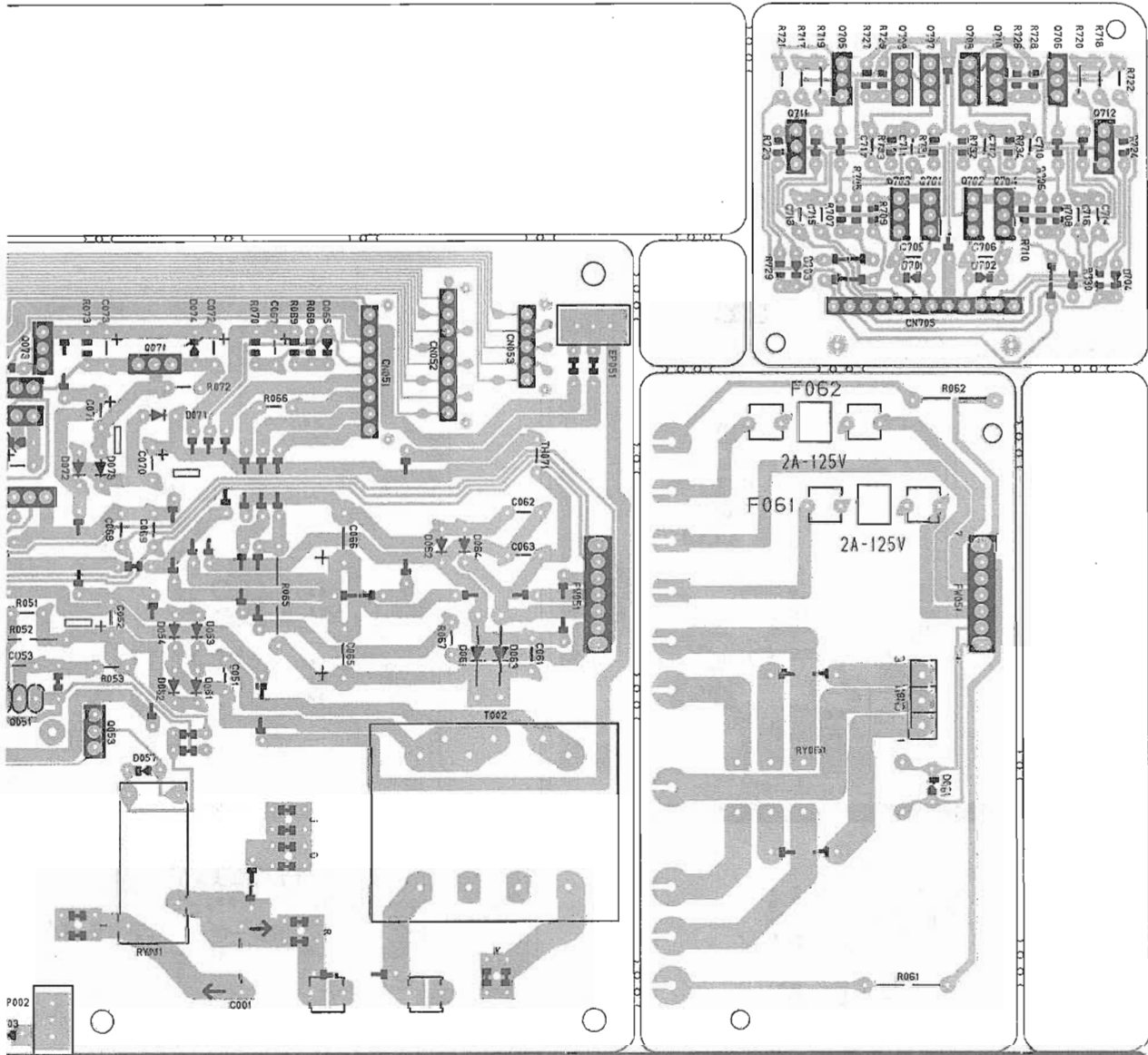

D | E | F | G | H





RX-774P/RX-774V

**-MEMO-**



# PARTS LIST

[ RX-774PBK/RX-774PGD/RX-774VBK ]

\* All printed circuit boards and its assemblies are not available as service parts.

## The Marks for Designated Areas

UF (PBK/PGD) ----- China  
 UT (PBK/VBK) ----- Taiwan  
 US (PBK) ----- Singapore  
 U (PBK/VBK) ----- Universal

## - Contents -

General Exploded View and Parts List .....	4-3
Electrical Parts List .....	4-5
Tuner P.C.B. ....	4-5
Main P.C.B. ....	4-6
Front P.C.B. ....	4-9
Control P.C.B. ....	4-11
AC Supply P.C.B. ....	4-13
Accessories List .....	4-16
Packing Materials and Parts Number .....	4-17

RX-774P/RX-774V

**-MEMO-**



# General Exploded View and Parts List

Block No. **M** **1** **M** **M**

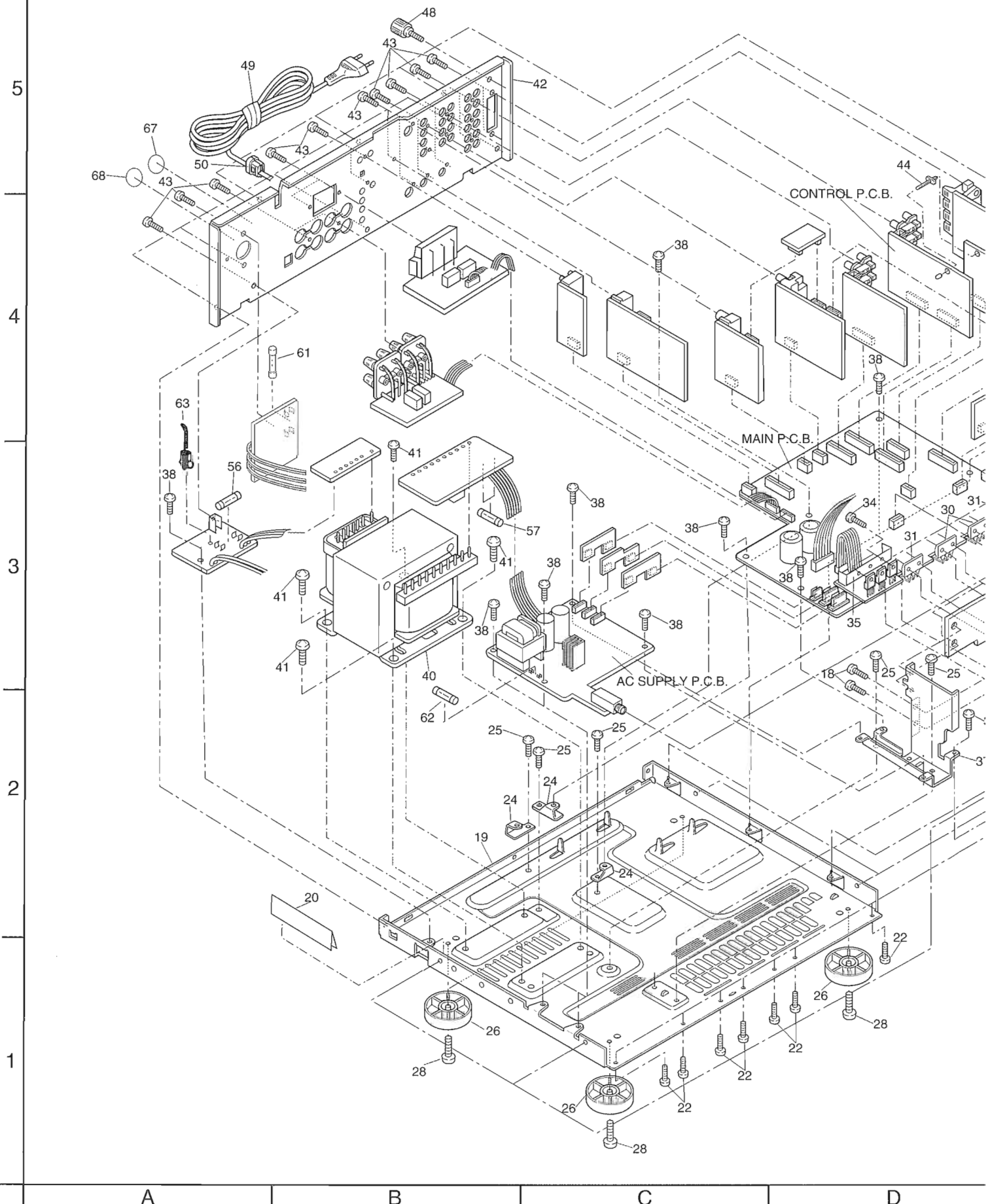

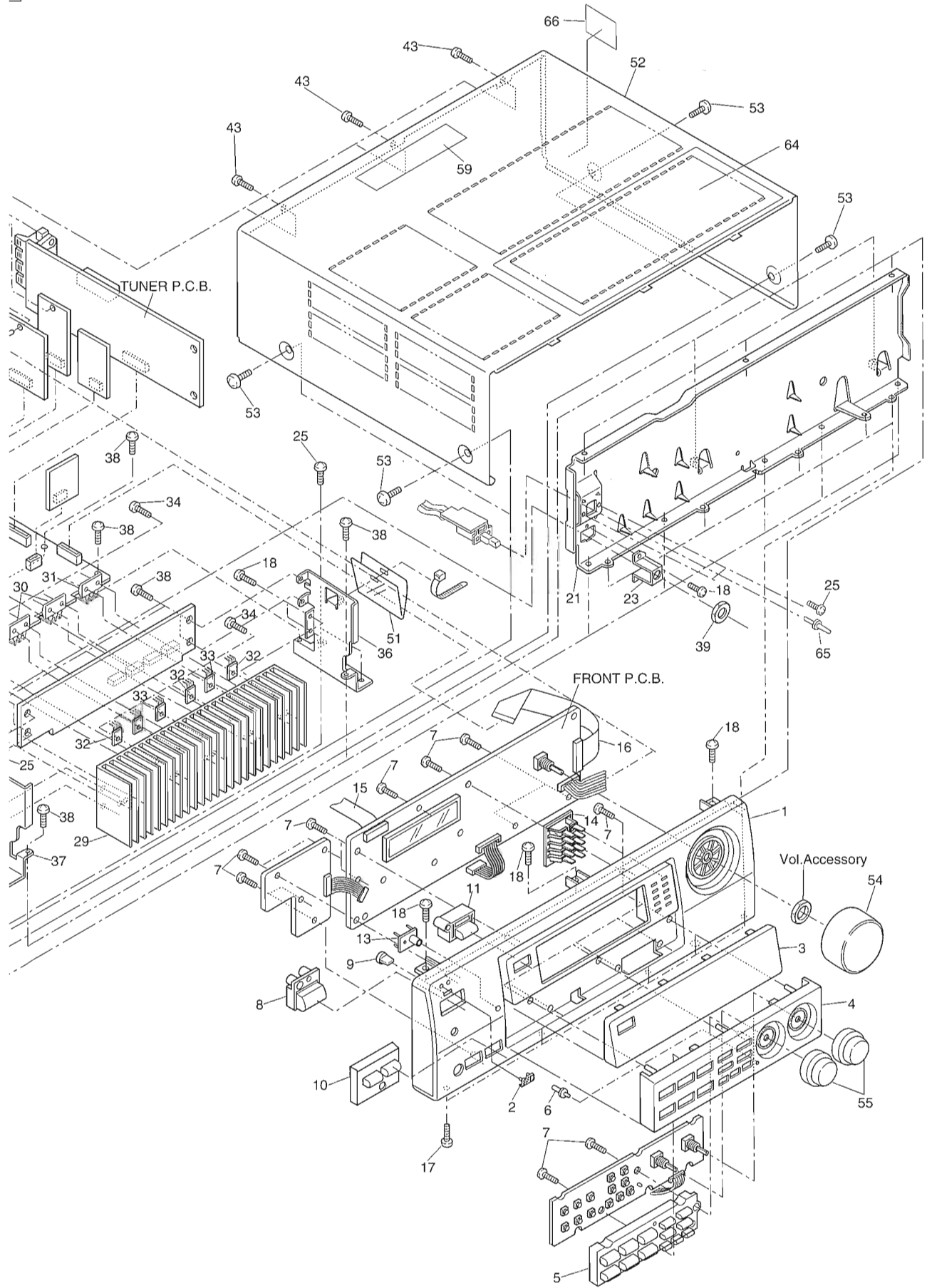

## Parts List

Block No. M1MM

△	Item	Parts Number	Parts Name	Q'ty	Description	Version & Area
	1	LV10018-007AKP	FRONT PANEL	1		PBK
		LV10018-012A	FRONT PANEL	1		PGD
		LV10018-014AKP	FRONT PANEL	1		VBK
	2	VJD5429-001	JVC MARK	1		
	3	LV20031-003AKP	LENS	1		PBK, VBK
		LV20031-006A	LENS	1		PGD
	4	LV20032-002AKP	FRONT ESC	1		PBK, VBK
		LV20032-004A	FRONT ESC	1		PGD
	5	LV20034-001AKP	PUSH BUTTON	1		PBK, VBK
		LV20034-002A	PUSH BUTTON	1		PGD
	6	LV40099-001AKP	INDICATOR	1		
	7	QYSDSF2608Z	SCREW	18		
	8	LV30068-002AKP	P. BUTTON (POWER)	1		PBK, VBK
		LV30068-003A	P. BUTTON (POWER)	1		PGD
	9	FSJD4001-002	INDICATOR LENS	1		
	10	LV30069-001AKP	P. BUTTON ASSY	1		PBK, VBK
		LV30069-002A	P. BUTTON ASSY	1		PGD
	11	LV30071-001AKP	P. BUTTON ASSY	1		
	13	E308744-002	REMOCON PLATE	1		PBK, VBK
		E308744-003	REMOCON PLATE	1		PGD
	14	LV30073-001AKP	SOURCE INDICATO	1		
	15	OUQ412-2120CJ	FLAT WIRE	1		PBK, PGD
		VWF1221-20TTB	FLAT WIRE	1		VBK
	16	OUQ412-3122CJ	FLAT WIRE	1		PBK, PGD
		VWF1231-22TTBW	FLAT WIRE	1		VBK
	17	QYSDSG3008M	SCREW	5		PBK, VBK
		QYSDSG3008N	SCREW	5		PGD
	18	QYSBSG3008E	T. SCREW	8		
	19	LV10019-002AKP	CHASSIS BASE	1		
	20	EX0150010H09S11	FELT SPACER	1		
	21	LV10020-001AKP	FRONT BRACKET	1		
	22	QYSDSG3008E	T. SCREW	7		
	23	LE40139-001A	HEADPHONE BRACKET	1		
	24	E68587-223SM	P. W. BOARD BRACKET	3		
	25	QYSBST3006E	TAP. SCREW	9		
	26	VJF4039-00P	FOOT ASSY	4		
	28	QYSBST3010Z	TH TAP SCREW	4		
△	29	LV30075-201A	HEAT SINK	1		PBK, PGD
△		LV30075-001AKP	HEAT SINK	1		VBK
△	30	2SC3857/PY/-F1	S.I. TRANSISTOR	2	3A	
△	31	2SA1493/PY/-F1	S.I. TRANSISTOR	2	3A	
△	32	2SD2488/OP/-F1	S.I. TRANSISTOR	3	3A	
△	33	2SB1620/OP/-F1	S.I. TRANSISTOR	3	3A	
	34	E73525-003	SCREW	16		
	35	LV40390-001AKP	LEAF SPRING	1		
	36	LV20035-001AKP	H. S BRACKET (R)	1		
	37	LV20036-001AKP	H. S BRACKET (L)	1		
	38	QYSBSGG3008E	T. SCREW	17		
	39	VKZ4150-001	NUT	1		
△	40	QQT0213-002KP	POWER TRANS.	1		
	41	QYSDSTL4008E	SPECIAL SCREW	4		
	42	LV10021-022AKP	REAR PANEL	1		PBK

■ Parts List

Block No. M1MM

△	Item	Parts Number	Parts Name	Q'ty	Description	Version & Area
	42	LV10021-024A	REAR PANEL	1		PGD
		LV10021-013AKP	REAR PANEL	1		VBKU
		LV10021-015AKP	REAR PANEL	1		VBKUT
	43	QYSBSGY3008E	SPECIAL SCREW	29		
	44	E302321-001	FASTENER	1		
	48	E409257-001	EARTH TERMINAL	1		
△	49	QMPR100-200-JC	POWER CORD	1		UF
△		QMP39E0-200	POWER CORD	1		U, US
△		QMP7520-200	POWER CORD	1		UT
△	50	QHS3771-108	CORD STOPPER	1		
	51	LV30076-001AKP	PROTECTOR	1		
	52	LV20038-002A (S)	METAL COVER	1		PBK, VBK
		LV20038-003A (S)	METAL COVER	1		PGD
	53	E406308-003	SPECIAL SCREW	4		PBK, VBK
		E406308-004	SPECIAL SCREW	4		PGD
	54	LV30480-001AKP	VOL KNOB ASS'Y	1		PBK, VBK
		LV30480-002A	VOL. KNOB ASSY	1		PGD
	55	LV30481-001AKP	JOG KNOB ASS'Y	2		PBK, VBK
		LV30481-002A	JOG KNOB ASS'Y	2		PGD
△	56	QMF51E2-6R3-J1	FUSE	1	F001	
△	57	QMF51E2-2R0-J1	FUSE	2	F061, F062	
	59	E409396-001	CAUTION LABEL	1		
△	61	QMF51E2-3R15-J1	FUSE	1	F004	
△	62	QMF51A2-R10-S	FUSE	1	F002	
	63	E307572-001	FASTENER	1		
	64	LV30077-001AKP	PROTECT SHEET	1		PBK, VBK
		LV30077-002A	PROTECT SHEET	1		PGD
	65	E407321-002SM	PUSH BUTTON	1		PBK, VBK
		E407321-005SMKP	PUSH BUTTON	1		PGD
	66	LV30092-029A	UF LABEL	1		UF
		LV30093-022A	UT LABEL	1		PBKUT
		LV30093-028A	UT LABEL	1		VBKUT
	67	E409372-001	CCEE LABEL	1		UF
	68	E409539-001	CCIB LABEL	1		UF





## Electrical Parts List (Tuner P.C.B)

△	Item	Parts Number	Description	Area
		I. C. S		
	IC102	LA1837	I. C (MONO-ANALOG)	
	IC121	LC72131	I. C (M)	
		DIODES		
	D121	1SS133-T2	SI. DIODE	
	D123	1SS133-T2	SI. DIODE	
	D129	1SS133-T2	SI. DIODE	
	D130	MTZJ100-T2	ZENER	
		TRANSISTORS		
	Q101	2SC461/BC/-T	SILICON	
	Q102	2SC535/BC/-T	SILICON	
	Q103	2SC461/BC/-T	SILICON	
	Q121	DTA124ES-T	SILICON	
	Q123	2SC2060/QR/-T	SILICON	
		CAPACITORS		
	C101	QDYB10M-103Y	0.01MF 16V C CAP.	
	C102	QETC1EM-107Z	100MF 25V AL E. CAP.	
	C103	QDVB1EZ-223Y	0.022MF 25V C CAP.	
	C104	QDVB1EZ-223Y	0.022MF 25V C CAP.	
	C105	QDVB1EZ-223Y	0.022MF 25V C CAP.	
	C107	QETC1EM-226ZM	22MF 25V E. CAP.	
	C109	QETC1EM-226ZM	22MF 25V E. CAP.	
	C111	QDVB1EZ-223Y	0.022MF 25V C CAP.	
	C112	QDCB1HJ-120Y	12PF 50V C CAP.	
	C117	QCSB1HK-5R6Y	5.6PF 50V CER. CAP.	
	C118	QCSB1HJ-150Y	15PF 50V CER. CAP.	
	C121	QDCB1HJ-180Y	18PF 50V C CAP.	
	C122	QDCB1HJ-180Y	18PF 50V C CAP.	
	C123	QDX31EM-473Z	0.047MF 25V C CAP.	
	C126	QCBB1HK-101Y	100PF 50V CER. CAP.	
	C128	QENB1HM-474	0.47MF 50V NP E. CAP.	
	C129	QCGB1HK-102	1000PF 50V CER. CAP.	
	C130	QETC1EM-107Z	100MF 25V AL E. CAP.	
	C133	QETC1EM-226ZM	22MF 25V E. CAP.	
	C134	QCBB1HK-331Y	330PF 50V CER. CAP.	
	C135	QDVB1EZ-223Y	0.022MF 25V C CAP.	
	C136	QETN1HM-105Z	1MF 50V AL E. CAP.	
	C137	QCBB1HK-101Y	100PF 50V CER. CAP.	
	C139	QFLB1HJ-223	0.022MF 50V MYLAR CAP.	
	C140	QFLB1HJ-223	0.022MF 50V MYLAR CAP.	
	C141	QDX31EM-473Z	0.047MF 25V C CAP.	
	C143	QDVB1EZ-223Y	0.022MF 25V C CAP.	
	C144	QDX31EM-473Z	0.047MF 25V C CAP.	
	C146	QETN1HM-105Z	1MF 50V AL E. CAP.	
	C147	QETN1HM-105Z	1MF 50V AL E. CAP.	
	C148	QETN1HM-474Z	0.47MF 50V AL E. CAP.	
	C149	QETN1HM-105Z	1MF 50V AL E. CAP.	
	C150	QETC1EM-226ZM	22MF 25V E. CAP.	
	C156	QDVB1EZ-223Y	0.022MF 25V C CAP.	
	C157	QDX31EM-473Z	0.047MF 25V C CAP.	
	C158	QETC1EM-226ZM	22MF 25V E. CAP.	
	C161	QETN1HM-105Z	1MF 50V AL E. CAP.	
	C162	QETN1HM-105Z	1MF 50V AL E. CAP.	
	C163	QDVB1EZ-223Y	0.022MF 25V C CAP.	
	C164	QDX31EM-473Z	0.047MF 25V C CAP.	
	C168	QFVJ1HJ-274Z	0.27MF 50V T. FILM	
	C180	QETC1EM-107Z	100MF 25V AL E. CAP.	
	C181	QFLB1HJ-562	5600PF 50V MYLAR CAP.	
	C182	QFLB1HJ-562	5600PF 50V MYLAR CAP.	
	C183	QDVB1EZ-223Y	0.022MF 25V C CAP.	
	C184	QETC1EM-107Z	100MF 25V AL E. CAP.	
	C185	QETN1HM-105Z	1MF 50V AL E. CAP.	
	C186	QETN1HM-105Z	1MF 50V AL E. CAP.	
		RESISTORS		
	R102	QRE141J-332Y	3.3K 1/4W R. NETWORK	
	R103	QRE141J-221Y	220 1/4W R. NETWORK	

△	Item	Parts Number	Description	Area
	R104	QRE141J-272Y	2.7K 1/4W R. NETWORK	
	R105	QRE141J-391Y	390 1/4W R. NETWORK	
	R106	QRE141J-102Y	1K 1/4W R. NETWORK	
	R107	QRE141J-561Y	560 1/4W R. NETWORK	
	R108	QRE141J-332Y	3.3K 1/4W R. NETWORK	
	R109	QRE141J-221Y	220 1/4W R. NETWORK	
	R115	QRE141J-104Y	100K 1/4W R. NETWORK	
	R119	QRE141J-103Y	10K 1/4W R. NETWORK	
	R121	QRE141J-473Y	47K 1/4W R. NETWORK	
	R122	QRE141J-472Y	4.7K 1/4W R. NETWORK	
	R124	QRE141J-222Y	2.2K 1/4W R. NETWORK	
	R126	QRE141J-562Y	5.6K 1/4W R. NETWORK	
	R127	QRE141J-822Y	8.2K 1/4W R. NETWORK	
	R128	QRE141J-472Y	4.7K 1/4W R. NETWORK	
	R129	QRE141J-222Y	2.2K 1/4W R. NETWORK	
	R130	QRZ9005-680X	68 FUSIBLE	
	R132	QRE141J-102Y	1K 1/4W R. NETWORK	
	R133	QRE141J-822Y	8.2K 1/4W R. NETWORK	
	R134	QRE141J-102Y	1K 1/4W R. NETWORK	
	R140	QRE141J-183Y	18K 1/4W CARBON RES.	
	R141	QRE141J-472Y	4.7K 1/4W R. NETWORK	
	R142	QRE141J-470Y	47 1/4W R. NETWORK	
	R143	QRE141J-562Y	5.6K 1/4W R. NETWORK	
	R144	QRE141J-332Y	3.3K 1/4W R. NETWORK	
	R145	QRE141J-103Y	10K 1/4W R. NETWORK	
	R146	QRE141J-332Y	3.3K 1/4W R. NETWORK	
	R147	QRE141J-273Y	27K 1/4W R. NETWORK	
	R148	QRE141J-561Y	560 1/4W R. NETWORK	
	R150	QRE141J-101Y	100 1/4W R. NETWORK	
	R157	QRE141J-682Y	6.8K 1/4W R. NETWORK	
	R158	QRE141J-682Y	6.8K 1/4W R. NETWORK	
	R161	QRE141J-102Y	1K 1/4W R. NETWORK	
	R162	QRE141J-102Y	1K 1/4W R. NETWORK	
	R163	QRE141J-472Y	4.7K 1/4W R. NETWORK	
	R164	QRE141J-472Y	4.7K 1/4W R. NETWORK	
	R181	QRE141J-102Y	1K 1/4W R. NETWORK	
	R182	QRE141J-103Y	10K 1/4W R. NETWORK	
	R183	QRE141J-103Y	10K 1/4W R. NETWORK	
	R184	QRE141J-103Y	10K 1/4W R. NETWORK	
		OTHERS		
	L111	QQL231K-150Y	INDUCTOR I. M	
	T111	QQR0592-001	RF COIL	
	T141	QQR0613-001	I. F. TRANSFORMER	
	T142	QAX0303-001	CERAMIC FILTER	
	X121	QAX0259-001Z	RESONATOR I. M	
	AT101	QNB0008-001	ANT TERMINAL	
	CF101	QAX0285-001Z	CERAMIC FILTER	
	CF102	QAX0285-001Z	CERAMIC FILTER	
	CN111	QGB2510K1-12	CONNECTOR	
	FL141	QQR0590-001	LOWPASS FILTER	
	FL142	QQR0590-001	LOWPASS FILTER	
	RF101	EAF2207-001	FRONT END	

### ■ Electrical Parts List (Main P.C.B)

△	Item	Parts Number	Description	Area
		I. C. S		
	IC321	TC9162AN	I. C (DIGI-OTHER)	
	IC331	TC9459F	I. C (M)	
	IC332	TC9459F	I. C (M)	
	IC333	TC9459F	I. C (M)	
	IC361	NJM4580L	I. C (MONO-ANALOG)	
	IC362	BA15218N	I. C (MONO-ANALOG)	
	IC451	LG7522	I. C (DIGI-MOS)	
	IC452	M5243AP12	I. C (M)	
	IC901	TA7317P	I. C (MONO-ANALOG)	
		DIODES		
	D743	MTZJ180-T2	ZENER	
	D771	1SS133-T2	SI. DIODE	
	D772	1SS133-T2	SI. DIODE	
	D773	1SS133-T2	SI. DIODE	
	D774	1SS133-T2	SI. DIODE	
△	D801	31DF2-FC	SILICON	
△	D802	31DF2-FC	SILICON	
△	D803	31DF2-FC	SILICON	
△	D804	31DF2-FC	SILICON	
	D821	MTZJ6. 80-T2	ZENER	
	D822	1SS133-T2	SI. DIODE	
	D831	MTZJ6. 2A-T2	ZENER	
	D832	1SS133-T2	SI. DIODE	
	D841	MTZJ6. 2A-T2	ZENER	
	D842	1SS133-T2	SI. DIODE	
	D851	MTZJ150-T2	ZENER	
	D852	1SS133-T2	SI. DIODE	
	D861	MTZJ150-T2	ZENER	
	D862	1SS133-T2	SI. DIODE	
	D871	MTZJ130-T2	ZENER	
	D872	1SS133-T2	SI. DIODE	
	D901	1SS133-T2	SI. DIODE	
	D902	1SS133-T2	SI. DIODE	
	D921	MTZJ4. 7B-T2	ZENER	
	D931	1SS133-T2	SI. DIODE	
	D932	1SS133-T2	SI. DIODE	
	D933	1SS133-T2	SI. DIODE	
	D934	1SS133-T2	SI. DIODE	
	D953	1SS133-T2	SI. DIODE	
	D954	1SS133-T2	SI. DIODE	
	D971	1SS133-T2	SI. DIODE	
	D973	1SS133-T2	SI. DIODE	
	D1435	1SS133-T2	SI. DIODE	
	D1436	1SS133-T2	SI. DIODE	
	D1437	MTZJ4. 7B-T2	ZENER	
	D1451	MTZJ6. 80-T2	ZENER	
	D1452	MTZJ6. 80-T2	ZENER	
	D1453	MTZJ5. 10-T2	ZENER	
		TRANSISTORS		
	Q751	2SC2389S/S/-T	SILICON	
	Q752	2SC2389S/S/-T	SILICON	
	Q753	2SA1038S/S/-T	SILICON	
	Q754	2SA1038S/S/-T	SILICON	
	Q755	2SD669A/BC/	SILICON	
	Q756	2SD669A/BC/	SILICON	
	Q757	2SB649A/BC/	SILICON	
	Q758	2SB649A/BC/	SILICON	
	Q771	2SC2389S/SE/-T	SI. TRANSISTOR	
	Q772	2SC2389S/SE/-T	SI. TRANSISTOR	
	Q773	2SA1038S/SE/-T	SILICON	
	Q774	2SA1038S/SE/-T	SILICON	
	Q781	2SD636/QR/	SILICON	
	Q782	2SD636/QR/	SILICON	
	Q821	2SD2061/EF/	SI. TRANSISTOR	
	Q831	2SD2061/EF/	SI. TRANSISTOR	
	Q841	2SD2061/EF/	SI. TRANSISTOR	
△	Q851	2SD2061/EF/	SI. TRANSISTOR	
△	Q861	2SB1187/EF/	SILICON	
	Q871	2SD2061/EF/	SI. TRANSISTOR	
	Q901	2SC2389S/SE/-T	SI. TRANSISTOR	
	Q902	2SC2389S/SE/-T	SI. TRANSISTOR	

△	Item	Parts Number	Description	Area
	Q903	2SA1038S/SE/-T	SILICON	
	Q921	2SC1740S/RS/-T	SILICON	
	Q931	DTC123YS-T	SILICON	
	Q932	DTC123YS-T	SILICON	
	Q951	DTC123YS-T	SILICON	
	Q952	DTC123YS-T	SILICON	
	Q1401	2SC2878/AB/-T	SILICON	
	Q1402	2SC2878/AB/-T	SILICON	
	Q1405	DTA144ES-T	SILICON	
	Q1411	2SC2878/AB/-T	SILICON	
	Q1421	2SC2878/AB/-T	SILICON	
	Q1422	2SC2878/AB/-T	SILICON	
	Q1435	2SA933S/RS/-T	SILICON	
		CAPACITORS		
	C701	QETB1HM-106	10MF 50V E. CAP.	
	C702	QETB1HM-106	10MF 50V E. CAP.	
	C703	QCS21HJ-101A	100PF 50V CER. CAP.	
	C704	QCS21HJ-101A	100PF 50V CER. CAP.	
	C707	QETB1CM-107	100MF 16V AL. E. CAP.	
	C708	QETB1CM-107	100MF 16V AL. E. CAP.	
	C709	QCS21HJ-100	10PF 50V CER. CAP.	
	C710	QCS21HJ-100	10PF 50V CER. CAP.	
	C719	QFLB1HJ-472	4700PF 50V MYLAR CAP.	
	C720	QFLB1HJ-472	4700PF 50V MYLAR CAP.	
	C721	QDVB1EZ-223Y	0.022MF 25V C. CAP.	
	C741	QETB2AM-476	47MF 100V AL. E. CAP.	
	C742	QETB2AM-476	47MF 100V AL. E. CAP.	
	C743	QETB1EM-476	47MF 25V AL. E. CAP.	
	C751	QCS22HJ-470A	47PF 500V CER. CAP.	
	C752	QCS22HJ-470A	47PF 500V CER. CAP.	
	C753	QCS22HJ-470A	47PF 500V CER. CAP.	
	C754	QCS22HJ-470A	47PF 500V CER. CAP.	
	C791	QFLB1HJ-473	0.047MF 50V MYLAR CAP.	
	C792	QFLB1HJ-473	0.047MF 50V MYLAR CAP.	
	C793	QFLB1HJ-473	0.047MF 50V MYLAR CAP.	
	C794	QFLB1HJ-473	0.047MF 50V MYLAR CAP.	
	C801	QFN82CK-104	0.1MF 160V METAL. MYLAR	
	C802	QFN82CK-104	0.1MF 160V METAL. MYLAR	
	C805	QFN82CK-104	0.1MF 160V METAL. MYLAR	
	C807	QEZ0427-129	12000MF NP. E. CAP.	
	C808	QEZ0427-129	12000MF NP. E. CAP.	
	C821	QEHCIEM-107	100MF 25V E. CAP.	
	C822	QCF31HZ-472Z	4700PF 50V CERAMIC	
	C831	QEHCIEM-227Z	220MF 25V ELECTRO	
	C832	QCF31HZ-472Z	4700PF 50V CERAMIC	
	C841	QEHCIEM-107	100MF 25V E. CAP.	
	C842	QCF31HZ-472Z	4700PF 50V CERAMIC	
	C851	QETB1EM-107	100MF 25V AL. E. CAP.	
	C852	QCF31HZ-472Z	4700PF 50V CERAMIC	
	C861	QETB1EM-107	100MF 25V AL. E. CAP.	
	C862	QCF31HZ-472Z	4700PF 50V CERAMIC	
	C871	QETB1EM-107	100MF 25V AL. E. CAP.	
	C872	QCF31HZ-472Z	4700PF 50V CERAMIC	
	C903	QER61HM-226	22MF 50V AL. E. CAP.	
	C904	QCF31HZ-103Z	0.01MF 50V CERAMIC	
	C905	QCB31HK-102Z	1000PF 50V CERAMIC	
	C906	QETCIAM-476ZM	47MF 10V E. CAP.	
	C920	QETB1CM-226	22MF 16V E. CAP.	
	C921	QER51CM-107	100MF 16V E. CAP.	
	C935	QFLB1HJ-223	0.022MF 50V MYLAR CAP.	
	C936	QFLB1HJ-223	0.022MF 50V MYLAR CAP.	
	C937	QFLB1HJ-223	0.022MF 50V MYLAR CAP.	
	C938	QFLB1HJ-223	0.022MF 50V MYLAR CAP.	
	C939	QFLB1HJ-223	0.022MF 50V MYLAR CAP.	
	C940	QFLB1HJ-223	0.022MF 50V MYLAR CAP.	
	C941	QCS21HJ-221	220PF 50V CER. CAP.	
	C942	QCS21HJ-221	220PF 50V CER. CAP.	
	C943	QCS21HJ-221	220PF 50V CER. CAP.	
	C944	QCS21HJ-221	220PF 50V CER. CAP.	
	C1301	QETB1EM-476	47MF 25V AL. E. CAP.	
	C1302	QETB1EM-476	47MF 25V AL. E. CAP.	
	C1303	QDVB1EZ-223Y	0.022MF 25V C. CAP.	

## ■ Electrical Parts List (Main P.C.B)

△	Item	Parts Number	Description	Area
	C1304	QDVB1EZ-223Y	0.022MF 25V C CAP.	
	C1307	QFLB1HJ-821	820PF 50V MYLAR CAP.	
	C1308	QFLB1HJ-821	820PF 50V MYLAR CAP.	
	C1309	QFVJ1HJ-224Z	0.22MF 50V T. FILM	
	C1310	QFVJ1HJ-224Z	0.22MF 50V T. FILM	
	C1311	QETB1HM-475E	4.7MF 50V E. CAP.	
	C1312	QETB1HM-475E	4.7MF 50V E. CAP.	
	C1313	QETB1HM-475E	4.7MF 50V E. CAP.	
	C1314	QETB1HM-475E	4.7MF 50V E. CAP.	
	C1315	QETB1EM-476	47MF 25V AL. E. CAP.	
	C1316	QETB1EM-476	47MF 25V AL. E. CAP.	
	C1317	QDVB1EZ-223Y	0.022MF 25V C CAP.	
	C1318	QDVB1EZ-223Y	0.022MF 25V C CAP.	
	C1319	QCB1HK-221Y	220PF 50V CER. CAP.	
	C1321	QETB1HM-475E	4.7MF 50V E. CAP.	
	C1322	QETB1HM-475E	4.7MF 50V E. CAP.	
	C1323	QETB1HM-475E	4.7MF 50V E. CAP.	
	C1324	QETB1HM-475E	4.7MF 50V E. CAP.	
	C1325	QETB1EM-476	47MF 25V AL. E. CAP.	
	C1326	QETB1EM-476	47MF 25V AL. E. CAP.	
	C1327	QDVB1EZ-223Y	0.022MF 25V C CAP.	
	C1328	QDVB1EZ-223Y	0.022MF 25V C CAP.	
	C1329	QCB1HK-221Y	220PF 50V CER. CAP.	
	C1331	QETB1HM-475E	4.7MF 50V E. CAP.	
	C1332	QETB1HM-475E	4.7MF 50V E. CAP.	
	C1333	QETB1HM-475E	4.7MF 50V E. CAP.	
	C1334	QETB1HM-475E	4.7MF 50V E. CAP.	
	C1335	QETB1EM-476	47MF 25V AL. E. CAP.	
	C1336	QETB1EM-476	47MF 25V AL. E. CAP.	
	C1337	QDVB1EZ-223Y	0.022MF 25V C CAP.	
	C1338	QDVB1EZ-223Y	0.022MF 25V C CAP.	
	C1339	QCB1HK-221Y	220PF 50V CER. CAP.	
	C1360	QCZ0202-155	1.5MF 25V CER. RES.	
	C1361	QETB1HM-105	1MF 50V AL. E. CAP.	
	C1362	QETB1HM-105	1MF 50V AL. E. CAP.	
	C1369	QETB1EM-476	47MF 25V AL. E. CAP.	
	C1370	QETB1EM-476	47MF 25V AL. E. CAP.	
	C1371	QETB1HM-105	1MF 50V AL. E. CAP.	
	C1372	QETB1HM-105	1MF 50V AL. E. CAP.	
	C1379	QETB1EM-476	47MF 25V AL. E. CAP.	
	C1380	QETB1EM-476	47MF 25V AL. E. CAP.	
	C1405	QETB0JM-107	100MF 6.3V AL. E. CAP.	
	C1451	QETB1HM-475E	4.7MF 50V E. CAP.	
	C1452	QETB1HM-475E	4.7MF 50V E. CAP.	
	C1453	QCS21HJ-101A	100PF 50V CER. CAP.	
	C1454	QCS21HJ-101A	100PF 50V CER. CAP.	
	C1455	QETB1HM-475E	4.7MF 50V E. CAP.	
	C1456	QETB1HM-475E	4.7MF 50V E. CAP.	
	C1457	QETB1HM-475E	4.7MF 50V E. CAP.	
	C1458	QETB1HM-475E	4.7MF 50V E. CAP.	
	C1459	QETB1HM-475E	4.7MF 50V E. CAP.	
	C1460	QETB1HM-475E	4.7MF 50V E. CAP.	
	C1461	QETB1CM-476	47MF 16V AL. E. CAP.	
	C1462	QETB1CM-476	47MF 16V AL. E. CAP.	
	C1463	QDVB1EZ-223Y	0.022MF 25V C CAP.	
	C1464	QDVB1EZ-223Y	0.022MF 25V C CAP.	
	C1465	QETB1CM-476	47MF 16V AL. E. CAP.	
	C1469	QCS21HJ-470	47PF 50V CER. CAP.	
	C1470	QCS21HJ-470	47PF 50V CER. CAP.	
	C1471	QFVJ1HJ-333Z	0.033MF 50V T. FILM	
	C1472	QFVJ1HJ-333Z	0.033MF 50V T. FILM	
	C1473	QETB1HM-105	1MF 50V AL. E. CAP.	
	C1474	QETB1HM-105	1MF 50V AL. E. CAP.	
	C1475	QFLB1HJ-332	3300PF 50V MYLAR CAP.	
	C1476	QFLB1HJ-332	3300PF 50V MYLAR CAP.	
	C1477	QFVJ1HJ-104Z	0.1MF 50V T. FILM	
	C1478	QFVJ1HJ-104Z	0.1MF 50V T. FILM	
	C1479	QCS31HJ-331Z	330PF 50V CER. CAP.	
	C1480	QCS31HJ-331Z	330PF 50V CER. CAP.	
	C1481	QFVJ1HJ-103Z	0.01MF 50V T. FILM	
	C1482	QFVJ1HJ-103Z	0.01MF 50V T. FILM	
		RESISTORS		

△	Item	Parts Number	Description	Area
	R701	QRE141J-222Y	2.2K 1/4W R. NETWORK	
	R702	QRE141J-222Y	2.2K 1/4W R. NETWORK	
	R703	QRE141J-104Y	100K 1/4W R. NETWORK	
	R704	QRE141J-104Y	100K 1/4W R. NETWORK	
	R711	QRE141J-911Y	910 1/4W R. NETWORK	
	R712	QRE141J-911Y	910 1/4W R. NETWORK	
	R713	QRE141J-183Y	18K 1/4W CARBON RES.	
	R714	QRE141J-183Y	18K 1/4W CARBON RES.	
	R715	QRE141J-823Y	82K 1/4W R. NETWORK	
	R716	QRE141J-823Y	82K 1/4W R. NETWORK	
	R741	QRJ146J-100X	10 1/4W R. NETWORK	
	R742	QRJ146J-100X	10 1/4W R. NETWORK	
	R743	QRL022J-562	5.6K 2W R. NETWORK	
	R751	QRJ146J-100X	10 1/4W R. NETWORK	
	R752	QRJ146J-100X	10 1/4W R. NETWORK	
	R753	QRJ146J-100X	10 1/4W R. NETWORK	
	R754	QRJ146J-100X	10 1/4W R. NETWORK	
	R759	QRJ146J-272X	2.7K 1/4W R. NETWORK	
	R760	QRJ146J-272X	2.7K 1/4W R. NETWORK	
	R765	QRJ146J-100X	10 1/4W R. NETWORK	
	R766	QRJ146J-100X	10 1/4W R. NETWORK	
	R767	QRJ146J-100X	10 1/4W R. NETWORK	
	R768	QRJ146J-100X	10 1/4W R. NETWORK	
	R769	QRJ146J-271X	270 1/4W R. NETWORK	
	R770	QRJ146J-271X	270 1/4W R. NETWORK	
	R771	QRE141J-391Y	390 1/4W R. NETWORK	
	R772	QRE141J-391Y	390 1/4W R. NETWORK	
	R773	QRE141J-391Y	390 1/4W R. NETWORK	
	R774	QRE141J-391Y	390 1/4W R. NETWORK	
	R775	QRE141J-201Y	200 1/4W R. NETWORK	
	R776	QRE141J-201Y	200 1/4W R. NETWORK	
	R777	QRE141J-201Y	200 1/4W R. NETWORK	
	R778	QRE141J-201Y	200 1/4W R. NETWORK	
	R779	QRZ0197-R22	0.22 1W NETWORK RES.	
	R780	QRZ0197-R22	0.22 1W NETWORK RES.	
	R781	QRE141J-391Y	390 1/4W R. NETWORK	
	R782	QRE141J-391Y	390 1/4W R. NETWORK	
	R783	QRE141J-471Y	470 1/4W R. NETWORK	
	R784	QRE141J-471Y	470 1/4W R. NETWORK	
	R785	QRE141J-102Y	1K 1/4W R. NETWORK	
	R786	QRE141J-102Y	1K 1/4W R. NETWORK	
	R789	QRE141J-102Y	1K 1/4W R. NETWORK	
	R790	QRE141J-102Y	1K 1/4W R. NETWORK	
	R791	QRJ125J-330	33 1/2W R. NETWORK	
	R792	QRJ125J-330	33 1/2W R. NETWORK	
	R793	QRL022J-100	10 2W R. NETWORK	
	R794	QRL022J-100	10 2W R. NETWORK	
	R801	QRE141J-104Y	100K 1/4W R. NETWORK	
	R802	QRE141J-104Y	100K 1/4W R. NETWORK	
	R821	QRK126J-100X	10 1/2W UNF. CARBON R	
	R822	QRK126J-220X	22 1/2W R. NETWORK	
	R823	QRJ146J-392X	3.9K 1/4W UNF. CARBON R	
	R831	QRJ146J-100X	10 1/4W R. NETWORK	
	R833	QRJ146J-392X	3.9K 1/4W UNF. CARBON R	
	R841	QRJ146J-100X	10 1/4W R. NETWORK	
	R842	QRJ146J-220X	22 1/4W R. NETWORK	
	R843	QRJ146J-392X	3.9K 1/4W UNF. CARBON R	
	R851	QRJ146J-120X	12 1/4W R. NETWORK	
	R853	QRJ146J-272X	2.7K 1/4W R. NETWORK	
	R861	QRJ146J-100X	10 1/4W R. NETWORK	
	R863	QRJ146J-272X	2.7K 1/4W R. NETWORK	
	R871	QRJ146J-120X	12 1/4W R. NETWORK	
	R873	QRJ146J-222X	2.2K 1/4W R. NETWORK	
	R901	QRE141J-272Y	2.7K 1/4W R. NETWORK	
	R902	QRE141J-272Y	2.7K 1/4W R. NETWORK	
	R903	QRE141J-153Y	15K 1/4W R. NETWORK	
	R904	QRE141J-153Y	15K 1/4W R. NETWORK	
	R905	QRE141J-123Y	12K 1/4W R. NETWORK	
	R906	QRE141J-123Y	12K 1/4W R. NETWORK	
	R909	QRE141J-103Y	10K 1/4W R. NETWORK	
	R911	QRE141J-332Y	3.3K 1/4W R. NETWORK	
	R912	QRE141J-473Y	47K 1/4W R. NETWORK	

### ■ Electrical Parts List (Main P.C.B)

△	Item	Parts Number	Description	Area
	R913	QRE141J-104Y	100K 1/4W R. NETWORK	
	R914	QRE141J-823Y	82K 1/4W R. NETWORK	
	R915	QRE141J-823Y	82K 1/4W R. NETWORK	
	R916	QRE141J-563Y	56K 1/4W R. NETWORK	
	R917	QRE141J-683Y	68K 1/4W R. NETWORK	
	R918	QRE141J-822Y	8. 2K 1/4W R. NETWORK	
	R919	QRE141J-822Y	8. 2K 1/4W R. NETWORK	
	R920	QRE141J-224Y	220K 1/4W R. NETWORK	
	R921	QRE141J-473Y	47K 1/4W R. NETWORK	
	R922	QRE141J-222Y	2. 2K 1/4W R. NETWORK	
	R931	QRJ146J-120X	12 1/4W R. NETWORK	
	R932	QRJ146J-120X	12 1/4W R. NETWORK	
	R935	QRZ9005-100X	10 FUSIBLE	
	R936	QRZ9005-100X	10 FUSIBLE	
	R937	QRZ9005-100X	10 FUSIBLE	
	R938	QRZ9005-100X	10 FUSIBLE	
	R971	QRJ146J-120X	12 1/4W R. NETWORK	
	R1300	QRE141J-333Y	33K 1/4W R. NETWORK	
	R1301	QRE141J-222Y	2. 2K 1/4W R. NETWORK	
	R1302	QRE141J-222Y	2. 2K 1/4W R. NETWORK	
	R1303	QRE141J-222Y	2. 2K 1/4W R. NETWORK	
	R1304	QRE141J-222Y	2. 2K 1/4W R. NETWORK	
	R1305	QRE141J-222Y	2. 2K 1/4W R. NETWORK	
	R1306	QRE141J-222Y	2. 2K 1/4W R. NETWORK	
	R1307	QRE141J-333Y	33K 1/4W R. NETWORK	
	R1308	QRE141J-333Y	33K 1/4W R. NETWORK	
	R1309	QRZ9005-680X	68 FUSIBLE	
	R1310	QRZ9005-680X	68 FUSIBLE	
	R1311	QRZ9005-680X	68 FUSIBLE	
	R1312	QRZ9005-680X	68 FUSIBLE	
	R1313	QRE141J-104Y	100K 1/4W R. NETWORK	
	R1314	QRE141J-104Y	100K 1/4W R. NETWORK	
	R1321	QRZ9005-680X	68 FUSIBLE	
	R1322	QRZ9005-680X	68 FUSIBLE	
	R1323	QRE141J-104Y	100K 1/4W R. NETWORK	
	R1324	QRE141J-104Y	100K 1/4W R. NETWORK	
	R1331	QRZ9005-680X	68 FUSIBLE	
	R1332	QRZ9005-680X	68 FUSIBLE	
	R1333	QRE141J-104Y	100K 1/4W R. NETWORK	
	R1334	QRE141J-104Y	100K 1/4W R. NETWORK	
	R1361	QRE141J-303Y	30K 1/4W R. NETWORK	
	R1362	QRE141J-303Y	30K 1/4W R. NETWORK	
	R1363	QRE141J-103Y	10K 1/4W R. NETWORK	
	R1364	QRE141J-103Y	10K 1/4W R. NETWORK	
	R1365	QRE141J-104Y	100K 1/4W R. NETWORK	
	R1366	QRE141J-104Y	100K 1/4W R. NETWORK	
	R1369	QRZ9005-680X	68 FUSIBLE	
	R1370	QRZ9005-680X	68 FUSIBLE	
	R1371	QRE141J-623Y	62K 1/4W R. NETWORK	
	R1372	QRE141J-623Y	62K 1/4W R. NETWORK	
	R1373	QRE141J-103Y	10K 1/4W R. NETWORK	
	R1374	QRE141J-103Y	10K 1/4W R. NETWORK	
	R1375	QRE141J-104Y	100K 1/4W R. NETWORK	
	R1376	QRE141J-104Y	100K 1/4W R. NETWORK	
	R1379	QRZ9005-680X	68 FUSIBLE	
	R1380	QRZ9005-680X	68 FUSIBLE	
	R1401	QRE141J-102Y	1K 1/4W R. NETWORK	
	R1402	QRE141J-102Y	1K 1/4W R. NETWORK	
	R1403	QRE141J-103Y	10K 1/4W R. NETWORK	
	R1404	QRE141J-103Y	10K 1/4W R. NETWORK	
	R1405	QRE141J-102Y	1K 1/4W R. NETWORK	
	R1406	QRE141J-474Y	470K 1/4W R. NETWORK	
	R1411	QRE141J-102Y	1K 1/4W R. NETWORK	
	R1412	QRE141J-103Y	10K 1/4W R. NETWORK	
	R1421	QRE141J-102Y	1K 1/4W R. NETWORK	
	R1422	QRE141J-102Y	1K 1/4W R. NETWORK	
	R1423	QRE141J-103Y	10K 1/4W R. NETWORK	
	R1424	QRE141J-103Y	10K 1/4W R. NETWORK	
	R1435	QRE141J-683Y	68K 1/4W R. NETWORK	
	R1436	QRE141J-104Y	100K 1/4W R. NETWORK	
	R1437	QRE141J-474Y	470K 1/4W R. NETWORK	
	R1457	QRE141J-103Y	10K 1/4W R. NETWORK	

△	Item	Parts Number	Description	Area
	R1458	QRE141J-103Y	10K 1/4W R. NETWORK	
	R1459	QRE141J-113Y	11K 1/4W R. NETWORK	
	R1460	QRE141J-113Y	11K 1/4W R. NETWORK	
	R1461	QRE141J-104Y	100K 1/4W R. NETWORK	
	R1462	QRE141J-104Y	100K 1/4W R. NETWORK	
	R1463	QRE141J-333Y	33K 1/4W R. NETWORK	
	R1464	QRE141J-333Y	33K 1/4W R. NETWORK	
	R1465	QRE141J-124Y	120K 1/4W R. NETWORK	
	R1466	QRE141J-124Y	120K 1/4W R. NETWORK	
	R1471	QRJ146J-561X	560 1/4W R. NETWORK	
	R1472	QRJ146J-561X	560 1/4W R. NETWORK	
	R1473	QRJ146J-681X	680 1/4W R. NETWORK	
	R1475	QRE141J-474Y	470K 1/4W R. NETWORK	
	R1476	QRE141J-474Y	470K 1/4W R. NETWORK	
	R1477	QRE141J-474Y	470K 1/4W R. NETWORK	
	R1478	QRE141J-474Y	470K 1/4W R. NETWORK	
	R1479	QRE141J-474Y	470K 1/4W R. NETWORK	
	R1480	QRE141J-474Y	470K 1/4W R. NETWORK	
	R1741	QRJ146J-331X	330 1/4W R. NETWORK	
	R1841	QRJ146J-331X	330 1/4W R. NETWORK	
	VR787	QVP0004-501Z	500 VARIABLE	
	VR788	QVP0004-501Z	500 VARIABLE	
		OTHERS		
		QUB220-09HPPH	SIN TWIST WIRE	
		QWE690-26RR	VINYL WIRE	
		QWE691-26RR	VINYL WIRE	
		QWE692-38RR	VINYL WIRE	
		QWE699-38RR	VINYL WIRE	
		QYSBSG3008E	T. SCREW	
	L791	QQL2003-1R0	INDUCTOR	
	L792	QQL2003-1R0	INDUCTOR	
	CN081	QGB2510J1-08	CONNECTOR	
	CN082	QGB2510J1-08	CONNECTOR	
	CN083	QGB2510J1-05	CONNECTOR	
	CN101	QGB2510J1-12	CONNECTOR	
	CN201	QGB2510J1-04	CONNECTOR	
	CN241	QGB2510J1-04	CONNECTOR	
	CN255	QGB2510J1-05	CONNECTOR	
	CN301	QGB2510J1-17	CONNECTOR	
	CN302	QGB2510J1-09	CONNECTOR	
	CN303	QGB2510J1-14	CONNECTOR	
	CN342	QGB2510J1-08	CONNECTOR	
	CN400	QGF1205C1-31	FFC SOCKET	
	CN451	QGB2510K1-09	CONNECTOR	
	CN452	QGB2510J1-09	CONNECTOR	
	CN501	QGB1214J3-18S	CONNECTOR	
	CN601	QGB1214J3-12S	CONNECTOR	
	CN702	QGA2501C1-05	CONNECTOR	
	CN704	QGA3901C1-08	CONNECTOR	
	CN706	QGB2510J1-12	CONNECTOR	
	CN801	EWS283-003	SOCKET WIRE ASSY	
	CN821	QGD2501C1-05Z	SOCKET I.M	
	CN901	QGD2501C1-03Z	SOCKET I.M	
	CN931	QGD2501C1-04Z	SOCKET I.M	
	CN932	QGD2501C1-03Z	SOCKET I.M	
	CN961	QGD2501C1-03Z	SOCKET I.M	
	CP821	ICP-N5-T	I.C. PROTECTOR	
	EP801	QNZ0136-001Z	1M EARTH PLATE	
	FW811	EWR33D-10SS	CORD	
	FW821	EWR35D-08LS	FLAT WIRE	
	FW931	EWR37D-16LS	FLAT WIRE	
	HS851	E70306-001	HEAT SINK	
	HS861	E70306-001	HEAT SINK	
	HS871	E70306-001	HEAT SINK	
	RY931	QSK0042-001	RELAY	
	RY932	QSK0042-001	RELAY	
	RY971	QSK0042-001	RELAY	
	ST931	QNB0024-001	SPK TERMINAL	
	TH783	QAD0012-202	THERMISTOR	
	TH784	QAD0012-202	THERMISTOR	
	TP781	QMV5005-004K	PLUG ASSY	

## ■ Electrical Parts List (Front P.C.B)

△	Item	Parts Number	Description	Area
		I. C. S		
	IC341	BU4051BC	I. C (DIGI-MOS)	
	IC342	BA15218N	I. C (MONO-ANALOG)	
	IC400	NN172412JABZ	I. C (M)	
	IC401	NN101015FAE1	I. C.	
	IC402	BU2092	I. C (M)	
	IC403	IC-PST600/E/-T	I. C.	
	IC404	GP1U271X	INFRARED DETECT UNIT	
	IC481	TC9471F	I. C (M)	
		DIODES		
	D400	1SR139-200-T4	SILICON	
	D401	1SR139-200-T4	SILICON	
	D402	1SR139-200-T4	SILICON	
	D404	1SS133-T2	SI. DIODE	
	D410	1SS133-T2	SI. DIODE	
	D411	1SS133-T2	SI. DIODE	
	D412	1SS133-T2	SI. DIODE	
	D413	1SS133-T2	SI. DIODE	
	D416	1SS133-T2	SI. DIODE	
	D417	1SS133-T2	SI. DIODE	
	D418	1SS133-T2	SI. DIODE	
	D420	SLR-342VC-T	L. E. D.	
	D421	SLR-342VC-T	L. E. D.	
	D422	SLR-342VC-T	L. E. D.	
	D430	SLR-342VC-T	L. E. D.	
	D431	SLR-342VC-T	L. E. D.	
	D432	SLR-342VC-T	L. E. D.	
	D435	SLR-342VC-T	L. E. D.	
	D436	SLR-342VC-T	L. E. D.	
	D437	SLR-342VC-T	L. E. D.	
	D438	SLR-342VC-T	L. E. D.	
	D439	SLR-342VC-T	L. E. D.	
	D440	SPR-325MVW/L/-T	L. E. D.	
	D442	SLR-342VC-T	L. E. D.	
	D493	1SS133-T2	SI. DIODE	
	D1351	MTZJ5. 1C-T2	ZENER	
	D1352	MTZJ5. 1C-T2	ZENER	
		TRANSISTORS		
	Q401	DTC114YS-T	SILICON	
	Q402	DTC114TSTP	DIGITAL TRANSISTOR	
	Q403	DTC144WS-T	SILICON	
	Q407	DTC114YS-T	SILICON	
	Q408	DTC114YS-T	SILICON	
	Q409	DTC144ES-T	SILICON	
	Q410	DTC144ES-T	SILICON	
	Q411	DTC144ES-T	SILICON	
	Q412	DTC144ES-T	SILICON	
	Q413	DTA114YS-T	SILICON	
	Q414	DTA114YS-T	SILICON	
	Q415	DTA114YS-T	SILICON	
	Q416	DTA114YS-T	SILICON	
	Q442	DTA114YS-T	SILICON	
	Q456	DTA114YS-T	SILICON	
		CAPACITORS		
	C400	QEKCHM-475Z	4. 7MF 50V ELECTRO	
	C401	QEKCOJM-107Z	100MF 6. 3V ELECTRO	
	C402	QCZ0202-155	1. 5MF 25V CER. CAP.	
	C403	QEZ0329-10AZ	ELECTRO	
	C404	QER81HM-225	2. 2MF 50V ELECTRO	
	C405	QDV81EZ-223Y	0. 022MF 25V C CAP.	
	C406	QCBB1HK-331Y	330PF 50V CER. CAP.	
	C407	QCFB1HZ-104Y	0. 1MF 50V CER. CAP.	
	C408	QEKCOJM-107Z	100MF 6. 3V ELECTRO	
	C409	QEKCHM-475Z	4. 7MF 50V ELECTRO	
	C410	QEKCHM-475Z	4. 7MF 50V ELECTRO	
	C412	QEKCOJM-107Z	100MF 6. 3V ELECTRO	
	C413	QDYB1CM-103Y	0. 01MF 16V C CAP.	
	C414	QDYB1CM-103Y	0. 01MF 16V C CAP.	
	C445	QDYB1CM-103Y	0. 01MF 16V C CAP.	

△	Item	Parts Number	Description	Area
	C446	QDYB1CM-103Y	0. 01MF 16V C CAP.	
	C447	QETC1AM-476ZM	47MF 10V E. CAP.	
	C448	QDYB1CM-103Y	0. 01MF 16V C CAP.	
	C451	QETB1HM-475E	4. 7MF 50V E. CAP.	
	C452	QETB1HM-475E	4. 7MF 50V E. CAP.	
	C453	QDXB1CM-222Y	2200PF 16V C CAP.	
	C454	QDXB1CM-222Y	2200PF 16V C CAP.	
	C455	QETC1AM-476ZM	47MF 10V E. CAP.	
	C456	QETC1AM-476ZM	47MF 10V E. CAP.	
	C457	QETC1AM-476ZM	47MF 10V E. CAP.	
	C458	QETC1AM-476ZM	47MF 10V E. CAP.	
	C461	QETC1AM-476ZM	47MF 10V E. CAP.	
	C462	QDYB1CM-103Y	0. 01MF 16V C CAP.	
	C463	QETC1AM-476ZM	47MF 10V E. CAP.	
	C464	QDYB1CM-103Y	0. 01MF 16V C CAP.	
	C467	QCBB1HK-101Y	100PF 50V CER. CAP.	
	C468	QETC1AM-476ZM	47MF 10V E. CAP.	
	C481	QDYB1CM-103Y	0. 01MF 16V C CAP.	
	C482	QCBB1HK-102	1000PF 50V CER. CAP.	
	C483	QCSB1HJ-100Y	10PF 50V CER. CAP.	
	C484	QCSB1HJ-220	22PF 50V CER. CAP.	
	C485	QETB1HM-475E	4. 7MF 50V E. CAP.	
	C486	QETB1HM-475E	4. 7MF 50V E. CAP.	
	C487	QCBB1HK-221Y	220PF 50V CER. CAP.	
	C488	QCBB1HK-221Y	220PF 50V CER. CAP.	
	C491	QETC1AM-476ZM	47MF 10V E. CAP.	
	C492	QETC1AM-476ZM	47MF 10V E. CAP.	
	C493	QETB1HM-475E	4. 7MF 50V E. CAP.	
	C494	QETB1HM-475E	4. 7MF 50V E. CAP.	
	C495	QDXB1CM-222Y	2200PF 16V C CAP.	
	C496	QDXB1CM-222Y	2200PF 16V C CAP.	
	C497	QETC1AM-476ZM	47MF 10V E. CAP.	
	C498	QETC1AM-476ZM	47MF 10V E. CAP.	
	C1341	QETB1HM-475E	4. 7MF 50V E. CAP.	
	C1342	QETB1HM-475E	4. 7MF 50V E. CAP.	
	C1343	QCS21HJ-101A	100PF 50V CER. CAP.	
	C1346	QFLB1HJ-103	0. 01MF 50V MYLAR CAP.	
	C1347	QFLB1HJ-123	0. 012MF 50V MYLAR CAP.	
	C1349	QETB1EM-476	47MF 25V AL. E. CAP.	
	C1350	QETB1EM-476	47MF 25V AL. E. CAP.	
	C1351	QETC1AM-476ZM	47MF 10V E. CAP.	
	C1352	QETC1AM-476ZM	47MF 10V E. CAP.	
	C1585	QCZ0202-155	1. 5MF 25V CER. CAP.	
	C1588	QDXB1CM-682Y	6800PF 16V C CAP.	
	C1589	QDXB1CM-682Y	6800PF 16V C CAP.	
	C1591	QCBB1HK-471Y	470PF 50V CER. CAP.	
	C1592	QCBB1HK-471Y	470PF 50V CER. CAP.	
	C1593	QCBB1HK-471Y	470PF 50V CER. CAP.	
	C1594	QCBB1HK-471Y	470PF 50V CER. CAP.	
	C1597	QDYB1CM-103Y	0. 01MF 16V C CAP.	
		RESISTORS		
	R401	QRE141J-103Y	10K 1/4W R. NETWORK	
	R402	QRE141J-103Y	10K 1/4W R. NETWORK	
	R403	QRE141J-331Y	330 1/4W R. NETWORK	
	R404	QRE141J-103Y	10K 1/4W R. NETWORK	
	R405	QRE141J-103Y	10K 1/4W R. NETWORK	
	R406	QRE141J-103Y	10K 1/4W R. NETWORK	
	R407	QRE141J-103Y	10K 1/4W R. NETWORK	
	R408	QRE141J-223Y	22K 1/4W R. NETWORK	
	R410	QRE141J-223Y	22K 1/4W R. NETWORK	
	R411	QRE141J-472Y	4. 7K 1/4W R. NETWORK	
	R412	QRE141J-181Y	180 1/4W R. NETWORK	
	R417	QRE141J-103Y	10K 1/4W R. NETWORK	
	R418	QRE141J-471Y	470 1/4W R. NETWORK	
	R419	QRE141J-103Y	10K 1/4W R. NETWORK	
	R420	QRE141J-221Y	220 1/4W R. NETWORK	
	R421	QRE141J-271Y	270 1/4W R. NETWORK	
	R422	QRE141J-271Y	270 1/4W R. NETWORK	
	R423	QRE141J-103Y	10K 1/4W R. NETWORK	

**■ Electrical Parts List (Front P.C.B)**

△	Item	Parts Number	Description	Area
	R424	QRE141J-103Y	10K 1/4W R. NETWORK	
	R425	QRE141J-103Y	10K 1/4W R. NETWORK	
	R426	QRE141J-103Y	10K 1/4W R. NETWORK	
	R427	QRE141J-103Y	10K 1/4W R. NETWORK	
	R428	QRE141J-104Y	100K 1/4W R. NETWORK	
	R429	QRE141J-104Y	100K 1/4W R. NETWORK	
	R430	QRE141J-103Y	10K 1/4W R. NETWORK	
	R431	QRE141J-103Y	10K 1/4W R. NETWORK	
	R433	QRE141J-221Y	220 1/4W R. NETWORK	
	R434	QRE141J-221Y	220 1/4W R. NETWORK	
	R435	QRE141J-221Y	220 1/4W R. NETWORK	
	R436	QRE141J-102Y	1K 1/4W R. NETWORK	
	R437	QRE141J-102Y	1K 1/4W R. NETWORK	
	R438	QRE141J-102Y	1K 1/4W R. NETWORK	
	R439	QRE141J-102Y	1K 1/4W R. NETWORK	
	R440	QRE141J-103Y	10K 1/4W R. NETWORK	
	R441	QRE141J-104Y	100K 1/4W R. NETWORK	
	R442	QRE141J-104Y	100K 1/4W R. NETWORK	
	R444	QRE141J-221Y	220 1/4W R. NETWORK	
	R445	QRE141J-221Y	220 1/4W R. NETWORK	
	R446	QRE141J-221Y	220 1/4W R. NETWORK	
	R447	QRE141J-221Y	220 1/4W R. NETWORK	
	R448	QRE141J-221Y	220 1/4W R. NETWORK	
	R449	QRE141J-221Y	220 1/4W R. NETWORK	
	R450	QRE141J-221Y	220 1/4W R. NETWORK	
	R451	QRE141J-221Y	220 1/4W R. NETWORK	
	R452	QRE141J-221Y	220 1/4W R. NETWORK	
	R453	QRE141J-221Y	220 1/4W R. NETWORK	
	R454	QRE141J-221Y	220 1/4W R. NETWORK	
	R455	QRE141J-221Y	220 1/4W R. NETWORK	
	R456	QRE141J-221Y	220 1/4W R. NETWORK	
	R457	QRE141J-221Y	220 1/4W R. NETWORK	
	R458	QRE141J-102Y	1K 1/4W R. NETWORK	
	R459	QRE141J-102Y	1K 1/4W R. NETWORK	
	R461	QRE141J-221Y	220 1/4W R. NETWORK	
	R462	QRE141J-221Y	220 1/4W R. NETWORK	
	R463	QRE141J-221Y	220 1/4W R. NETWORK	
	R464	QRE141J-221Y	220 1/4W R. NETWORK	
	R465	QRE141J-221Y	220 1/4W R. NETWORK	
	R466	QRE141J-221Y	220 1/4W R. NETWORK	
	R468	QRE141J-271Y	270 1/4W R. NETWORK	
	R484	QRE141J-271Y	270 1/4W R. NETWORK	
	R485	QRE141J-225Y	2. 2M 1/4W R. NETWORK	
	R487	QRE141J-271Y	270 1/4W R. NETWORK	
	R488	QRE141J-271Y	270 1/4W R. NETWORK	
	R489	QRE141J-271Y	270 1/4W R. NETWORK	
	R490	QRE141J-271Y	270 1/4W R. NETWORK	
	R491	QRE141J-271Y	270 1/4W R. NETWORK	
	R492	QRE141J-271Y	270 1/4W R. NETWORK	
	R493	QRE141J-222Y	2. 2K 1/4W R. NETWORK	
	R494	QRE141J-222Y	2. 2K 1/4W R. NETWORK	
	R495	QRE141J-104Y	100K 1/4W R. NETWORK	
	R496	QRE141J-104Y	100K 1/4W R. NETWORK	
	R497	QRE141J-104Y	100K 1/4W R. NETWORK	
	R498	QRE141J-104Y	100K 1/4W R. NETWORK	
	R499	QRE141J-222Y	2. 2K 1/4W R. NETWORK	
	R1341	QRE141J-104Y	100K 1/4W R. NETWORK	
	R1342	QRE141J-103Y	10K 1/4W R. NETWORK	
	R1343	QRE141J-203Y	20K 1/4W R. NETWORK	
	R1344	QRE141J-203Y	20K 1/4W R. NETWORK	
	R1345	QRE141J-273Y	27K 1/4W R. NETWORK	
	R1346	QRE141J-223Y	22K 1/4W R. NETWORK	
	R1347	QRE141J-132Y	1. 3K 1/4W R. NETWORK	
	R1348	QRE141J-182Y	1. 8K 1/4W R. NETWORK	
	R1349	QRZ9005-680X	68 FUSIBLE	
	R1350	QRZ9005-680X	68 FUSIBLE	
	R1351	QRE141J-222Y	2. 2K 1/4W R. NETWORK	
	R1352	QRE141J-222Y	2. 2K 1/4W R. NETWORK	
	R1353	QRE141J-682Y	6. 8K 1/4W R. NETWORK	

△	Item	Parts Number	Description	Area
	R1354	QRE141J-752Y	7. 5K 1/4W R. NETWORK	
	R1355	QRE141J-104Y	100K 1/4W R. NETWORK	
	R1589	QRE141J-102Y	1K 1/4W R. NETWORK	
	R1590	QRE141J-473Y	47K 1/4W R. NETWORK	
	R1591	QRE141J-103Y	10K 1/4W R. NETWORK	
	R1592	QRE141J-103Y	10K 1/4W R. NETWORK	
	R1593	QRE141J-103Y	10K 1/4W R. NETWORK	
	R1594	QRE141J-103Y	10K 1/4W R. NETWORK	
	R1595	QRE141J-102Y	1K 1/4W R. NETWORK	
	R1596	QRE141J-102Y	1K 1/4W R. NETWORK	
		OTHERS		
	L481	QGL231K-1R5Y	INDUCTOR	
	S400	QSW0683-001Z	PUSH SWITCH	
	S401	QSW0683-001Z	PUSH SWITCH	
	S402	QSW0683-001Z	PUSH SWITCH	
	S407	QSW0683-001Z	PUSH SWITCH	
	S408	QSW0683-001Z	PUSH SWITCH	
	S409	QSW0683-001Z	PUSH SWITCH	
	S410	QSW0683-001Z	PUSH SWITCH	
	S411	QSW0683-001Z	PUSH SWITCH	
	S412	QSW0683-001Z	PUSH SWITCH	
	S413	QSW0683-001Z	PUSH SWITCH	
	S414	QSW0683-001Z	PUSH SWITCH	
	S415	QSW0683-001Z	PUSH SWITCH	
	S416	QSW0683-001Z	PUSH SWITCH	
	S417	QSW0683-001Z	PUSH SWITCH	
	S418	QSW0683-001Z	PUSH SWITCH	
	S419	QSW0683-001Z	PUSH SWITCH	
	S420	QSW0683-001Z	PUSH SWITCH	
	X400	QAX0112-001Z	RESONATOR I. M	
	X401	QAX0246-001Z	RESONATOR I. M	
	X481	QAX0257-001Z	RESONATOR I. M	
	BK400	E308566-001	FL HOLDER	
	BK401	E308566-002	FL HOLDER	
	BK498	E409182-001SM	EARTH TERMINAL	
	BK499	E70225-002	EARTH PLATE	
	CN061	QGB2510K1-08	CONNECTOR	
	CN062	QGB2510K1-08	CONNECTOR	
	CN063	QGB2510K1-05	CONNECTOR	
	CN071	QGB2510K1-08	CONNECTOR	
	CN072	QGB2510K1-08	CONNECTOR	
	CN073	QGB2510K1-05	CONNECTOR	
	CN341	QGB2510K1-08	CONNECTOR	
	CN410	QGF1205F1-31	CONNECTOR	
	CN412	QGF1210G1-21	CONNECTOR	
	CN420	EWS26A-F908J	SOCKET WIRE ASSY	
	CN422	QGA2001F1-14	14P PLUG ASSY	
	CN430	QGA2001F1-10	10P PLUG ASSY	
	CN432	EWS26E-F908J	SOCKET WIRE ASSY	
	CN450	EWS26A-A940J	SOCKET WIRE ASSY	
	CN500	QGB1214K2-18S	CONNECTOR	
	CN600	QGB1214K2-12S	CONNECTOR	
	D1400	QLF0042-001	FLUORESCENT DISPLAY TUBE	
	FS400	E3400-444	FELT SPACER	
	FS401	E3400-444	FELT SPACER	
	FS489	E3400-431	FELT SPACER	
	JS400	QSW0502-001	SW	
	JS401	QSW0672-001	ROTARY SWITCH	
	JS402	QSW0672-001	ROTARY SWITCH	

## ■ Electrical Parts List (Control P.C.B)

△	Item	Parts Number	Description	Area
		I. C. S		
	IC201	BA7625	I. C (MONO-ANALOG)	
	IC202	NJM2285D	I. C (M)	
	IC203	MB90089PF-206	I. C (M)	
	IC301	NJM4580D-D	I. C.	
	IC302	NJM4580L	I. C (MONO-ANALOG)	
	IC303	NJM4580L	I. C (MONO-ANALOG)	
	IC304	TC9164AN	I. C (DIGI-MOS)	
	IC305	NJM4580L	I. C (MONO-ANALOG)	
	IC311	TC9163AN	I. C (DIGI-MOS)	
	IC391	BA15218N	I. C (MONO-ANALOG)	
		TRANSISTORS		
	Q200	2SA933S/RS/-T	SILICON	
	Q204	2SA933S/RS/-T	SILICON	
	Q205	2SA933S/RS/-T	SILICON	
	Q206	2SA933S/RS/-T	SILICON	
	Q301	2SC2878/AB/-T	SILICON	
	Q302	2SC2878/AB/-T	SILICON	
	Q1200	2SC1740LN/RS/-T	SILICON	
	Q1201	2SC1740LN/RS/-T	SILICON	
	Q1202	2SC1740LN/RS/-T	SILICON	
	Q1203	2SC1740LN/RS/-T	SILICON	
	Q1204	2SC1740LN/RS/-T	SILICON	
	Q1205	2SC1740LN/RS/-T	SILICON	
	Q1206	DTC143TS-T	SILICON	
	Q1207	DTC143TS-T	SILICON	
		CAPACITORS		
	C201	QETB1HM-475E	4.7MF 50V E. CAP.	
	C202	QETB1HM-475E	4.7MF 50V E. CAP.	
	C203	QETBOJM-477	470MF 6.3V AL E. CAP.	
	C204	QETB1HM-475E	4.7MF 50V E. CAP.	
	C207	QETBOJM-477	470MF 6.3V AL E. CAP.	
	C208	QETCIAM-476ZM	47MF 10V E. CAP.	
	C209	QCF31HZ-103Z	0.01MF 50V CERAMIC	
	C211	QETB1HM-107	100MF 50V E. CAP.	
	C212	QETCIAM-476ZM	47MF 10V E. CAP.	
	C213	QCF31HZ-103Z	0.01MF 50V CERAMIC	
	C214	QETB1HM-475E	4.7MF 50V E. CAP.	
	C215	QETB1HM-475E	4.7MF 50V E. CAP.	
	C216	QDX31EM-473Z	0.047MF 25V C. CAP.	
	C217	QETBIAM-477	470MF 10V E. CAP.	
	C218	QCZ0202-155	1.5MF 25V CER. CAP.	
	C219	QDC31HJ-150Z	15PF 50V C. CAP.	
	C220	QDC31HJ-100Z	10PF 50V C. CAPA. I. M	
	C221	QDC31HJ-470Z	47PF 50V C. CAPA. I. M	
	C222	QDC31HJ-270Z	27PF 50V ACCAPA. I. M	
	C223	QCBB1HK-102	1000PF 50V CER. CAP.	
	C224	QCBB1HK-271Y	270PF 50V CER. CAP.	
	C225	QCBB1HK-121Y	120PF 50V CER. CAP.	
	C277	QCS21HJ-470	47PF 50V CER. CAP.	
	C301	QETB1HM-475E	4.7MF 50V E. CAP.	
	C302	QETB1HM-475E	4.7MF 50V E. CAP.	
	C303	QCS21HJ-101A	100PF 50V CER. CAP.	
	C304	QCS21HJ-101A	100PF 50V CER. CAP.	
	C305	QFLB1HJ-182	1800PF 50V MYLAR CAP.	
	C306	QFLB1HJ-182	1800PF 50V MYLAR CAP.	
	C307	QFLB1HJ-682	6800PF 50V MYLAR CAP.	
	C308	QFLB1HJ-682	6800PF 50V MYLAR CAP.	
	C309	QCS21HJ-101A	100PF 50V CER. CAP.	
	C310	QCS21HJ-101A	100PF 50V CER. CAP.	
	C311	QETB1HM-475E	4.7MF 50V E. CAP.	
	C312	QETB1HM-475E	4.7MF 50V E. CAP.	
	C313	QETCIAM-107ZN	100MF 10V E. CAP.	
	C314	QETCIAM-107ZN	100MF 10V E. CAP.	
	C315	QETB1CM-476	47MF 16V AL E. CAP.	
	C316	QETB1CM-476	47MF 16V AL E. CAP.	
	C317	QETB1EM-226N	22MF 25V E. CAP.	
	C318	QETB1EM-226N	22MF 25V E. CAP.	
	C319	QCF31HZ-223Z	0.022MF 50V CERAMIC	

△	Item	Parts Number	Description	Area
	C320	QCF31HZ-223Z	0.022MF 50V CERAMIC	
	C321	QETB1EM-226N	22MF 25V E. CAP.	
	C322	QETB1EM-226N	22MF 25V E. CAP.	
	C331	QCS31HJ-391Z	390PF 50V CER. CAP.	
	C332	QCS31HJ-391Z	390PF 50V CER. CAP.	
	C333	QCS31HJ-391Z	390PF 50V CER. CAP.	
	C334	QCS31HJ-391Z	390PF 50V CER. CAP.	
	C337	QETB1HM-475E	4.7MF 50V E. CAP.	
	C338	QETB1HM-475E	4.7MF 50V E. CAP.	
	C339	QETB1EM-226N	22MF 25V E. CAP.	
	C340	QETB1EM-226N	22MF 25V E. CAP.	
	C341	QETB1HM-475E	4.7MF 50V E. CAP.	
	C342	QETB1HM-475E	4.7MF 50V E. CAP.	
	C343	QETB1HM-475E	4.7MF 50V E. CAP.	
	C344	QETB1HM-475E	4.7MF 50V E. CAP.	
	C345	QETB1HM-475E	4.7MF 50V E. CAP.	
	C346	QETB1HM-475E	4.7MF 50V E. CAP.	
	C347	QETB1HM-475E	4.7MF 50V E. CAP.	
	C348	QETB1HM-475E	4.7MF 50V E. CAP.	
	C349	QETB1EM-226N	22MF 25V E. CAP.	
	C350	QETB1EM-226N	22MF 25V E. CAP.	
	C351	QCF31HZ-223Z	0.022MF 50V CERAMIC	
	C352	QCF31HZ-223Z	0.022MF 50V CERAMIC	
	C353	QETB1EM-226N	22MF 25V E. CAP.	
	C354	QETB1EM-226N	22MF 25V E. CAP.	
	C358	QCBB1HK-561Y	560PF 50V CER. CAP.	
	C361	QCF31HZ-223Z	0.022MF 50V CERAMIC	
	C362	QCF31HZ-223Z	0.022MF 50V CERAMIC	
	C363	QETB1EM-226N	22MF 25V E. CAP.	
	C364	QETB1EM-226N	22MF 25V E. CAP.	
	C368	QCBB1HK-471Y	470PF 50V CER. CAP.	
	C369	QCBB1HK-331Y	330PF 50V CER. CAP.	
	C370	QCBB1HK-561Y	560PF 50V CER. CAP.	
	C371	QETB1EM-476	47MF 25V AL E. CAP.	
	C372	QETB1EM-476	47MF 25V AL E. CAP.	
	C373	QETB1HM-475E	4.7MF 50V E. CAP.	
	C374	QETB1HM-475E	4.7MF 50V E. CAP.	
	C1200	QDX31EM-473Z	0.047MF 25V C. CAP.	
	C1201	QETCIEM-227ZN	220MF 25V AL E. CAP.	
	C1202	QDX31EM-473Z	0.047MF 25V C. CAP.	
	C1203	QETBOJM-477	470MF 6.3V AL E. CAP.	
	C1205	QETB1EM-107	100MF 25V AL E. CAP.	
	C1206	QETB1EM-107	100MF 25V AL E. CAP.	
	C1207	QDX31EM-473Z	0.047MF 25V C. CAP.	
	C1208	QCF31HZ-103Z	0.01MF 50V CERAMIC	
	C1209	QETB1CM-477M	470MF 16V E. CAP.	
	C1210	QETB1EM-107	100MF 25V AL E. CAP.	
	C1211	QETB1HM-475E	4.7MF 50V E. CAP.	
	C1212	QCF31HZ-103Z	0.01MF 50V CERAMIC	
	C1213	QETB1HM-475E	4.7MF 50V E. CAP.	
	C1214	QCS21HJ-101A	100PF 50V CER. CAP.	
	C1215	QCS21HJ-101A	100PF 50V CER. CAP.	
	C1216	QCBB1HK-101Y	100PF 50V CER. CAP.	
	C1250	QCBB1HK-221Y	220PF 50V CER. CAP.	
	C1251	QCBB1HK-221Y	220PF 50V CER. CAP.	
	C1252	QCBB1HK-221Y	220PF 50V CER. CAP.	
		RESISTORS		
	R200	QRE141J-750Y	75 1/4W R. NETWORK	
	R201	QRE141J-750Y	75 1/4W R. NETWORK	
	R202	QRE141J-750Y	75 1/4W R. NETWORK	
	R203	QRE141J-750Y	75 1/4W R. NETWORK	
	R206	QRE141J-750Y	75 1/4W R. NETWORK	
	R207	QRE141J-331Y	330 1/4W R. NETWORK	
	R208	QRE141J-331Y	330 1/4W R. NETWORK	
	R209	QRE141J-473Y	47K 1/4W R. NETWORK	
	R210	QRE141J-331Y	330 1/4W R. NETWORK	
	R213	QRE141J-473Y	47K 1/4W R. NETWORK	
	R214	QRE141J-151Y	150 1/4W R. NETWORK	
	R219	QRE141J-101Y	100 1/4W R. NETWORK	

■ Electrical Parts List (Control P.C.B)

△	Item	Parts Number	Description	Area
	R220	QRE141J-121Y	120 1/4W R. NETWORK	
	R221	QRE141J-151Y	150 1/4W R. NETWORK	
	R222	QRE141J-561Y	560 1/4W R. NETWORK	
	R223	QRE141J-561Y	560 1/4W R. NETWORK	
	R224	QRE141J-561Y	560 1/4W R. NETWORK	
	R225	QRJ146J-3R3X	3. 3 1/4W R. NETWORK	
	R301	QRE141J-222Y	2. 2K 1/4W R. NETWORK	
	R302	QRE141J-222Y	2. 2K 1/4W R. NETWORK	
	R303	QRE141J-473Y	47K 1/4W R. NETWORK	
	R304	QRE141J-473Y	47K 1/4W R. NETWORK	
	R305	QRE141J-621Y	620 1/4W R. NETWORK	
	R306	QRE141J-621Y	620 1/4W R. NETWORK	
	R307	QRE141J-393Y	39K 1/4W R. NETWORK	
	R308	QRE141J-393Y	39K 1/4W R. NETWORK	
	R309	QRE141J-474Y	470K 1/4W R. NETWORK	
	R310	QRE141J-474Y	470K 1/4W R. NETWORK	
	R311	QRE141J-104Y	100K 1/4W R. NETWORK	
	R312	QRE141J-104Y	100K 1/4W R. NETWORK	
	R313	QRJ146J-331X	330 1/4W R. NETWORK	
	R314	QRJ146J-331X	330 1/4W R. NETWORK	
	R315	QRZ9005-680X	68 FUSIBLE	
	R316	QRZ9005-680X	68 FUSIBLE	
	R325	QRE141J-471Y	470 1/4W R. NETWORK	
	R326	QRE141J-471Y	470 1/4W R. NETWORK	
	R327	QRE141J-471Y	470 1/4W R. NETWORK	
	R328	QRE141J-471Y	470 1/4W R. NETWORK	
	R329	QRE141J-471Y	470 1/4W R. NETWORK	
	R330	QRE141J-471Y	470 1/4W R. NETWORK	
	R331	QRE141J-471Y	470 1/4W R. NETWORK	
	R332	QRE141J-471Y	470 1/4W R. NETWORK	
	R333	QRE141J-471Y	470 1/4W R. NETWORK	
	R334	QRE141J-471Y	470 1/4W R. NETWORK	
	R335	QRE141J-104Y	100K 1/4W R. NETWORK	
	R336	QRE141J-104Y	100K 1/4W R. NETWORK	
	R337	QRE141J-104Y	100K 1/4W R. NETWORK	
	R338	QRE141J-104Y	100K 1/4W R. NETWORK	
	R339	QRE141J-104Y	100K 1/4W R. NETWORK	
	R340	QRE141J-104Y	100K 1/4W R. NETWORK	
	R341	QRE141J-104Y	100K 1/4W R. NETWORK	
	R342	QRE141J-104Y	100K 1/4W R. NETWORK	
	R343	QRE141J-104Y	100K 1/4W R. NETWORK	
	R344	QRE141J-104Y	100K 1/4W R. NETWORK	
	R345	QRE141J-104Y	100K 1/4W R. NETWORK	
	R346	QRE141J-104Y	100K 1/4W R. NETWORK	
	R347	QRE141J-104Y	100K 1/4W R. NETWORK	
	R348	QRE141J-104Y	100K 1/4W R. NETWORK	
	R349	QRE141J-104Y	100K 1/4W R. NETWORK	
	R350	QRE141J-104Y	100K 1/4W R. NETWORK	
	R351	QRE141J-104Y	100K 1/4W R. NETWORK	
	R352	QRE141J-104Y	100K 1/4W R. NETWORK	
	R353	QRZ9005-680X	68 FUSIBLE	
	R354	QRZ9005-680X	68 FUSIBLE	
	R355	QRE141J-471Y	470 1/4W R. NETWORK	
	R356	QRE141J-471Y	470 1/4W R. NETWORK	
	R357	QRE141J-471Y	470 1/4W R. NETWORK	
	R358	QRE141J-471Y	470 1/4W R. NETWORK	
	R359	QRE141J-471Y	470 1/4W R. NETWORK	
	R360	QRE141J-471Y	470 1/4W R. NETWORK	
	R361	QRE141J-471Y	470 1/4W R. NETWORK	
	R362	QRE141J-471Y	470 1/4W R. NETWORK	
	R381	QRE141J-183Y	18K 1/4W CARBON RES.	
	R382	QRE141J-202Y	2K 1/4W R. NETWORK	
	R383	QRE141J-104Y	100K 1/4W R. NETWORK	
	R384	QRE141J-104Y	100K 1/4W R. NETWORK	
	R385	QRE141J-471Y	470 1/4W R. NETWORK	
	R386	QRE141J-471Y	470 1/4W R. NETWORK	
	R387	QRE141J-103Y	10K 1/4W R. NETWORK	
	R388	QRE141J-103Y	10K 1/4W R. NETWORK	
	R1200	QRE141J-750Y	75 1/4W R. NETWORK	

△	Item	Parts Number	Description	Area
	R1201	QRE141J-750Y	75 1/4W R. NETWORK	
	R1202	QRE141J-750Y	75 1/4W R. NETWORK	
	R1203	QRE141J-750Y	75 1/4W R. NETWORK	
	R1204	QRE141J-473Y	47K 1/4W R. NETWORK	
	R1205	QRE141J-473Y	47K 1/4W R. NETWORK	
	R1206	QRE141J-752Y	7. 5K 1/4W R. NETWORK	
	R1207	QRE141J-133Y	13K 1/4W R. NETWORK	
	R1208	QRE141J-112Y	1. 1K 1/4W R. NETWORK	
	R1209	QRE141J-681Y	680 1/4W R. NETWORK	
	R1210	QRE141J-681Y	680 1/4W R. NETWORK	
	R1211	QRE141J-303Y	30K 1/4W R. NETWORK	
	R1212	QRE141J-183Y	18K 1/4W CARBON RES.	
	R1213	QRE141J-152Y	1. 5K 1/4W R. NETWORK	
	R1214	QRE141J-220Y	22 1/4W R. NETWORK	
	R1215	QRE141J-302Y	3K 1/4W R. NETWORK	
	R1216	QRE141J-752Y	7. 5K 1/4W R. NETWORK	
	R1217	QRE141J-133Y	13K 1/4W R. NETWORK	
	R1218	QRE141J-112Y	1. 1K 1/4W R. NETWORK	
	R1219	QRE141J-681Y	680 1/4W R. NETWORK	
	R1220	QRE141J-681Y	680 1/4W R. NETWORK	
	R1221	QRE141J-303Y	30K 1/4W R. NETWORK	
	R1222	QRE141J-183Y	18K 1/4W CARBON RES.	
	R1223	QRE141J-152Y	1. 5K 1/4W R. NETWORK	
	R1224	QRE141J-220Y	22 1/4W R. NETWORK	
	R1225	QRE141J-302Y	3K 1/4W R. NETWORK	
	R1226	QRJ146J-6R8X	6. 8 1/4W R. NETWORK	
	R1250	QRE141J-470Y	47 1/4W R. NETWORK	
	R1251	QRE141J-221Y	220 1/4W R. NETWORK	
	R1252	QRE141J-221Y	220 1/4W R. NETWORK	
	R1253	QRE141J-470Y	47 1/4W R. NETWORK	
	R1254	QRE141J-221Y	220 1/4W R. NETWORK	
		OTHERS		
	J201	QNN0078-001	PIN JACK	
	J202	QNN0067-001	PIN JACK	
	J203	QNN0017-002	PIN JACK	
	J301	QNN0056-001	PIN JACK	
	J302	QNN0056-001	PIN JACK	
	J303	QNN0185-001	PIN JACK	
	J311	QNN0056-001	PIN JACK	
	J312	QNN0056-001	PIN JACK	
	J314	QNN0107-001	PIN JACK	
	L200	QQL231K-220Y	INDUCTOR	
	X200	QAX0261-001Z	CRYSTAL	
	CN200	QGB2510K1-04	CONNECTOR	
	CN202	QGA2001F1-10	10P PLUG ASSY	
	CN204	QGB1214K1-14S	CONNECT TERMINAL	
	CN205	QGB1214J1-14S	CONNECT TERMINAL	
	CN243	QGB1214J1-14S	CONNECT TERMINAL	
	CN250	QGB2510K1-04	CONNECTOR	
	CN252	QGB1214K1-14S	CONNECT TERMINAL	
	CN254	QGB2510K1-05	CONNECTOR	
	CN311	QGB2510K1-17	CONNECTOR	
	CN312	QGB2510K1-09	CONNECTOR	
	CN313	QGB2510K1-14	CONNECTOR	
	J1201	QND0025-001	PIN JACK	
	J1202	QND0024-001	PIN JACK	
	J1250	QNS0077-001	PIN JACK	
	J1251	QNS0083-001	PIN JACK	
	K1201	QOR0601-001Z	F. BEADS I. M	
	SW200	QSW0673-001	LEVER SWITCH	



## ■ Electrical Parts List (AC Supply P.C.B)

△	Item	Parts Number	Description	Area
		DIODES		
	D051	1SR139-200-T4	SILICON	
	D052	1SR139-200-T4	SILICON	
	D053	1SR139-200-T4	SILICON	
	D054	1SR139-200-T4	SILICON	
	D055	MTZJ12C-T2	ZENER	
	D056	MTZJ6. 2A-T2	ZENER	
	D057	1SS133-T2	SI. DIODE	
△	D061	10E2-FD	DIODE	
	D062	1SR139-200-T4	SILICON	
△	D063	10E2-FD	DIODE	
	D064	1SR139-200-T4	SILICON	
	D065	1SS133-T2	SI. DIODE	
	D066	1SS133-T2	SI. DIODE	
	D071	1SR139-200-T4	SILICON	
	D072	1SR139-200-T4	SILICON	
	D073	1SR139-200-T4	SILICON	
	D074	MTZJ33C-T2	ZENER	
	D075	MTZJ6. 2C-T2	ZENER	
	D701	1SS133-T2	SI. DIODE	
	D702	1SS133-T2	SI. DIODE	
	D703	1SS133-T2	SI. DIODE	
	D704	1SS133-T2	SI. DIODE	
	D981	1SS133-T2	SI. DIODE	
	D982	1SS133-T2	SI. DIODE	
	D1701	1SS133-T2	SI. DIODE	
	D1702	MTZJ18C-T2	ZENER	
	D1771	1SS133-T2	SI. DIODE	
	D1772	1SS133-T2	SI. DIODE	
	D1791	1SS133-T2	SI. DIODE	
	D1801	1SS133-T2	SI. DIODE	
	D1802	1SS133-T2	SI. DIODE	
	D1805	MTZJ18C-T2	ZENER	
	D1871	1SS133-T2	SI. DIODE	
	D1872	1SS133-T2	SI. DIODE	
	D1873	1SS133-T2	SI. DIODE	
	D1874	1SS133-T2	SI. DIODE	
	D1891	1SS133-T2	SI. DIODE	
	D1892	1SS133-T2	SI. DIODE	
		TRANSISTORS		
	Q051	2SD1266/QP/	SILICON	
	Q052	2SC2235/OY/-T	SILICON	
	Q053	DTC123YS-T	SILICON	
	Q061	DTC114YS-T	SILICON	
	Q071	2SB1357/EF/-T	SILICON	
	Q072	DTC114ES	DIGITAL TRANSISTOR	
	Q073	DTA144ES-T	SILICON	
	Q074	2SC2240/GL/-T	SILICON	
	Q701	2SC2240-BL/AB/	SI. TRANSISTOR	
	Q702	2SC2240-BL/AB/	SI. TRANSISTOR	
	Q703	2SC2240-BL/AB/	SI. TRANSISTOR	
	Q704	2SC2240-BL/AB/	SI. TRANSISTOR	
	Q705	2SA1038S/SE/-T	SILICON	
	Q706	2SA1038S/SE/-T	SILICON	
	Q707	2SA933LN/RS/-T	SILICON	
	Q708	2SA933LN/RS/-T	SILICON	
	Q709	2SA1038S/SE/-T	SILICON	
	Q710	2SA1038S/SE/-T	SILICON	
	Q711	2SC2389S/SE/-T	SI. TRANSISTOR	
	Q712	2SC2389S/SE/-T	SI. TRANSISTOR	
	Q1701	2SC2240-BL/AB/	SI. TRANSISTOR	
	Q1702	2SC2240-BL/AB/	SI. TRANSISTOR	
	Q1703	2SA1038S/S/-T	SILICON	
	Q1731	2SD636/QR/	SILICON	
	Q1771	2SC2389S/SE/-T	SI. TRANSISTOR	
	Q1772	2SA1038S/SE/-T	SILICON	

△	Item	Parts Number	Description	Area
	Q1791	2SC2389S/SE/-T	SI. TRANSISTOR	
	Q1801	2SC2240-BL/AB/	SI. TRANSISTOR	
	Q1802	2SC2240-BL/AB/	SI. TRANSISTOR	
	Q1803	2SC2240-BL/AB/	SI. TRANSISTOR	
	Q1804	2SC2240-BL/AB/	SI. TRANSISTOR	
	Q1805	2SA1038S/S/-T	SILICON	
	Q1806	2SA1038S/S/-T	SILICON	
	Q1831	2SD636/QR/	SILICON	
	Q1832	2SD636/QR/	SILICON	
	Q1871	2SC2389S/SE/-T	SI. TRANSISTOR	
	Q1872	2SC2389S/SE/-T	SI. TRANSISTOR	
	Q1873	2SA1038S/SE/-T	SILICON	
	Q1874	2SA1038S/SE/-T	SILICON	
	Q1891	2SC2389S/SE/-T	SI. TRANSISTOR	
	Q1892	2SC2389S/SE/-T	SI. TRANSISTOR	
		CAPACITORS		
△	C001	QCZ9019-472	4700PF C. CAP.	
△	C002	QCZ9019-472	4700PF C. CAP.	
	C003	QCBB1HK-391Y	390PF 50V CER. CAP.	
	C051	QFN82AK-472	4700PF 100V METAL. MYLAR	
	C052	QETC1EM-227ZM	220MF 25V AL. E. CAP.	
		QETM1JM-477	470MF 63V ELECTRO	
	C053	QCF31HZ-472Z	4700PF 50V CERAMIC	
	C054	QETB1CM-476	47MF 16V AL. E. CAP.	
	C055	QCF31HZ-472Z	4700PF 50V CERAMIC	
	C061	QFN82AJ-104	0.1MF 100V MYLAR CAP.	
	C062	QFN82AJ-104	0.1MF 100V MYLAR CAP.	
	C063	QFN82AJ-104	0.1MF 100V MYLAR CAP.	
	C065	QETB1VM-228N	2200MF 35V E. CAP.	
	C066	QETB1VM-228N	2200MF 35V E. CAP.	
	C067	QETB1HM-475E	4.7MF 50V E. CAP.	
	C068	QFLB1HJ-473	0.047MF 50V MYLAR CAP.	
	C069	QFLB1HJ-473	0.047MF 50V MYLAR CAP.	
	C070	QETB1HM-227	220MF 50V E. CAP.	
	C071	QETM1JM-227Z	220MF 63V ELECTRO	
	C072	QETB1HM-226E	22MF 50V E. CAP.	
	C073	QETB1HM-226E	22MF 50V E. CAP.	
	C074	QETB1HM-105	1MF 50V AL. E. CAP.	
	C091	QCBB1HK-331Y	330PF 50V CER. CAP.	
	C092	QCBB1HK-331Y	330PF 50V CER. CAP.	
	C705	QCS21HJ-101A	100PF 50V CER. CAP.	
	C706	QCS21HJ-101A	100PF 50V CER. CAP.	
	C710	QCS22HJ-220	22PF 500V CER. CAP.	
	C711	QFLB1HJ-152	1500PF 50V MYLAR CAP.	
	C712	QFLB1HJ-152	1500PF 50V MYLAR CAP.	
	C713	QCS21HJ-680A	68PF 50V CER. CAP.	
	C714	QCS21HJ-680A	68PF 50V CER. CAP.	
	C715	QCS21HJ-680A	68PF 50V CER. CAP.	
	C716	QCS21HJ-680A	68PF 50V CER. CAP.	
	C717	QCS22HJ-220	22PF 500V CER. CAP.	
	C1701	QETB1HM-106	10MF 50V E. CAP.	
	C1702	QCS21HJ-101A	100PF 50V CER. CAP.	
	C1703	QCS21HJ-101A	100PF 50V CER. CAP.	
	C1704	QETB1CM-476	47MF 16V AL. E. CAP.	
	C1705	QCS21HJ-5R0	5PF 50V CER. CAP.	
	C1711	QCS22HJ-330	33PF 500V CER. CAP.	
	C1712	QFLB1HJ-103	0.01MF 50V MYLAR CAP.	
	C1713	QETB1HM-225	2.2MF 50V AL. E. CAP.	
	C1714	QCF31HZ-223Z	0.022MF 50V CERAMIC	
	C1715	QETB1HM-476	47MF 50V E. CAP.	
	C1741	QETB1JM-476	47MF 63V AL. E. CAP.	
	C1742	QETB1JM-476	47MF 63V AL. E. CAP.	
	C1743	QETB1EM-476	47MF 25V AL. E. CAP.	
	C1751	QCS22HJ-470A	47PF 500V CER. CAP.	
	C1752	QCS22HJ-470A	47PF 500V CER. CAP.	
	C1761	QFLB1HJ-473	0.047MF 50V MYLAR CAP.	

■ Electrical Parts List (AC Supply P.C.B)

△	Item	Parts Number	Description	Area
	C1762	QFLB1HJ-473	0.047MF 50V MYLAR CAP.	
	C1791	QCF31HZ-223Z	0.022MF 50V CERAMIC	
	C1800	QCF31HZ-223Z	0.022MF 50V CERAMIC	
	C1801	QETB1HM-106	10MF 50V E. CAP.	
	C1802	QETB1HM-106	10MF 50V E. CAP.	
	C1803	QCS21HJ-101A	100PF 50V CER. CAP.	
	C1804	QCS21HJ-101A	100PF 50V CER. CAP.	
	C1805	QCS21HJ-101A	100PF 50V CER. CAP.	
	C1806	QCS21HJ-101A	100PF 50V CER. CAP.	
	C1807	QETB1CM-476	47MF 16V AL. E. CAP.	
	C1808	QETB1CM-476	47MF 16V AL. E. CAP.	
	C1809	QCS21HJ-5R0	5PF 50V CER. CAP.	
	C1810	QCS21HJ-5R0	5PF 50V CER. CAP.	
	C1811	QCS22HJ-330	33PF 500V CER. CAP.	
	C1812	QCS22HJ-330	33PF 500V CER. CAP.	
	C1813	QFLB1HJ-103	0.01MF 50V MYLAR CAP.	
	C1814	QFLB1HJ-103	0.01MF 50V MYLAR CAP.	
	C1815	QEK01HM-225Z	2.2MF 50V ELECTRO	
	C1816	QEK01HM-225Z	2.2MF 50V ELECTRO	
	C1817	QETB1HM-476	47MF 50V E. CAP.	
	C1818	QETB1HM-476	47MF 50V E. CAP.	
	C1841	QETB1JM-476	47MF 63V AL. E. CAP.	
	C1842	QETB1JM-476	47MF 63V AL. E. CAP.	
	C1843	QETB1EM-106	10MF 25V AL. E. CAP.	
	C1851	QCS22HJ-470A	47PF 500V CER. CAP.	
	C1852	QCS22HJ-470A	47PF 500V CER. CAP.	
	C1853	QCS22HJ-470A	47PF 500V CER. CAP.	
	C1854	QCS22HJ-470A	47PF 500V CER. CAP.	
	C1861	QFLB1HJ-473	0.047MF 50V MYLAR CAP.	
	C1862	QFLB1HJ-473	0.047MF 50V MYLAR CAP.	
	C1863	QFLB1HJ-473	0.047MF 50V MYLAR CAP.	
	C1864	QFLB1HJ-473	0.047MF 50V MYLAR CAP.	
	C1891	QCF31HZ-223Z	0.022MF 50V CERAMIC	
	C1892	QCF31HZ-223Z	0.022MF 50V CERAMIC	
		RESISTORS		
	R051	QRJ146J-153X	15K 1/4W R. NETWORK	
	R052	QRL012J-332	3.3K 1W R. NETWORK	
	R053	QRZ9015-3R3	3.3 COMPOSITION	
	R054	QRE141J-821Y	820 1/4W R. NETWORK	
	R061	QRT012J-R22	0.22 1W R. NETWORK	
	R062	QRT012J-R22	0.22 1W R. NETWORK	
	R065	QRT022J-2R2	2.2 2W R. NETWORK	
	R066	QRJ146J-2R2X	2.2 1/4W R. NETWORK	
	R067	QRJ146J-120X	12 1/4W R. NETWORK	
	R068	QRE141J-562Y	5.6K 1/4W R. NETWORK	
	R069	QRE141J-822Y	8.2K 1/4W R. NETWORK	
	R070	QRE141J-103Y	10K 1/4W R. NETWORK	
	R072	QRJ146J-332X	3.3K 1/4W R. NETWORK	
	R073	QRE141J-223Y	22K 1/4W R. NETWORK	
	R074	QRE141J-104Y	100K 1/4W R. NETWORK	
	R081	QRE141J-104Y	100K 1/4W R. NETWORK	
	R082	QRE141J-104Y	100K 1/4W R. NETWORK	
	R083	QRE141J-104Y	100K 1/4W R. NETWORK	
	R091	QRL022J-471	470 2W OXIDE METAL	
	R092	QRL022J-471	470 2W OXIDE METAL	
	R705	QRE141J-202Y	2K 1/4W R. NETWORK	
	R706	QRE141J-202Y	2K 1/4W R. NETWORK	
	R707	QRE141J-202Y	2K 1/4W R. NETWORK	
	R708	QRE141J-202Y	2K 1/4W R. NETWORK	
	R709	QRE141J-912Y	9.1K 1/4W R. NETWORK	
	R710	QRE141J-912Y	9.1K 1/4W R. NETWORK	
	R717	QRJ146J-562X	5.6K 1/4W R. NETWORK	
	R718	QRJ146J-562X	5.6K 1/4W R. NETWORK	
	R719	QRK126J-103X	10K 1/2W R. NETWORK	
	R720	QRK126J-103X	10K 1/2W R. NETWORK	
	R721	QRJ146J-151X	150 1/4W CARBON RES.	

△	Item	Parts Number	Description	Area
	R722	QRJ146J-151X	150 1/4W CARBON RES.	
	R723	QRE141J-391Y	390 1/4W R. NETWORK	
	R724	QRE141J-391Y	390 1/4W R. NETWORK	
	R725	QRE141J-152Y	1.5K 1/4W R. NETWORK	
	R726	QRE141J-152Y	1.5K 1/4W R. NETWORK	
	R727	QRE141J-333Y	33K 1/4W R. NETWORK	
	R728	QRE141J-333Y	33K 1/4W R. NETWORK	
	R729	QRE141J-391Y	390 1/4W R. NETWORK	
	R730	QRE141J-391Y	390 1/4W R. NETWORK	
	R731	QRE141J-391Y	390 1/4W R. NETWORK	
	R732	QRE141J-391Y	390 1/4W R. NETWORK	
	R733	QRE141J-101Y	100 1/4W R. NETWORK	
	R734	QRE141J-101Y	100 1/4W R. NETWORK	
	R981	QRJ146J-120X	12 1/4W R. NETWORK	
	R982	QRJ146J-120X	12 1/4W R. NETWORK	
	R1701	QRE141J-222Y	2.2K 1/4W R. NETWORK	
	R1702	QRE141J-104Y	100K 1/4W R. NETWORK	
	R1703	QRE141J-202Y	2K 1/4W R. NETWORK	
	R1705	QRE141J-123Y	12K 1/4W R. NETWORK	
	R1711	QRE141J-911Y	910 1/4W R. NETWORK	
	R1712	QRE141J-104Y	100K 1/4W R. NETWORK	
	R1721	QRJ146J-221X	220 1/4W R. NETWORK	
	R1722	QRE141J-392Y	3.9K 1/4W R. NETWORK	
	R1723	QRE141J-392Y	3.9K 1/4W R. NETWORK	
	R1724	QRE141J-392Y	3.9K 1/4W R. NETWORK	
	R1725	QRE141J-392Y	3.9K 1/4W R. NETWORK	
	R1731	QRE141J-751Y	750 1/4W R. NETWORK	
	R1732	QRE141J-391Y	390 1/4W R. NETWORK	
	R1742	QRJ146J-331X	330 1/4W R. NETWORK	
	R1743	QRL022J-562	5.6K 2W R. NETWORK	
	R1751	QRJ146J-100X	10 1/4W R. NETWORK	
	R1752	QRJ146J-100X	10 1/4W R. NETWORK	
	R1753	QRZ0197-R22	0.22 1W NETWORK RES.	
	R1761	QRJ125J-330	33 1/2W R. NETWORK	
	R1762	QRL022J-100	10 2W R. NETWORK	
	R1771	QRE141J-391Y	390 1/4W R. NETWORK	
	R1772	QRE141J-391Y	390 1/4W R. NETWORK	
	R1773	QRE141J-201Y	200 1/4W R. NETWORK	
	R1774	QRE141J-201Y	200 1/4W R. NETWORK	
	R1791	QRE141J-272Y	2.7K 1/4W R. NETWORK	
	R1792	QRE141J-153Y	15K 1/4W R. NETWORK	
	R1793	QRE141J-123Y	12K 1/4W R. NETWORK	
	R1794	QRE141J-104Y	100K 1/4W R. NETWORK	
	R1801	QRE141J-222Y	2.2K 1/4W R. NETWORK	
	R1802	QRE141J-222Y	2.2K 1/4W R. NETWORK	
	R1803	QRE141J-104Y	100K 1/4W R. NETWORK	
	R1804	QRE141J-104Y	100K 1/4W R. NETWORK	
	R1805	QRE141J-202Y	2K 1/4W R. NETWORK	
	R1806	QRE141J-202Y	2K 1/4W R. NETWORK	
	R1809	QRE141J-123Y	12K 1/4W R. NETWORK	
	R1810	QRE141J-123Y	12K 1/4W R. NETWORK	
	R1811	QRE141J-911Y	910 1/4W R. NETWORK	
	R1812	QRE141J-911Y	910 1/4W R. NETWORK	
	R1813	QRE141J-104Y	100K 1/4W R. NETWORK	
	R1814	QRE141J-104Y	100K 1/4W R. NETWORK	
	R1821	QRJ146J-221X	220 1/4W R. NETWORK	
	R1822	QRJ146J-221X	220 1/4W R. NETWORK	
	R1823	QRE141J-392Y	3.9K 1/4W R. NETWORK	
	R1824	QRE141J-392Y	3.9K 1/4W R. NETWORK	
	R1825	QRE141J-392Y	3.9K 1/4W R. NETWORK	
	R1826	QRE141J-392Y	3.9K 1/4W R. NETWORK	
	R1827	QRE141J-392Y	3.9K 1/4W R. NETWORK	
	R1828	QRE141J-392Y	3.9K 1/4W R. NETWORK	
	R1829	QRE141J-392Y	3.9K 1/4W R. NETWORK	
	R1830	QRE141J-392Y	3.9K 1/4W R. NETWORK	
	R1831	QRE141J-751Y	750 1/4W R. NETWORK	

## ■ Electrical Parts List (AC Supply P.C.B)

△	Item	Parts Number	Description	Area
	R1832	QRE141J-751Y	750 1/4W R. NETWORK	
	R1833	QRE141J-391Y	390 1/4W R. NETWORK	
	R1834	QRE141J-391Y	390 1/4W R. NETWORK	
	R1842	QRJ146J-331X	330 1/4W R. NETWORK	
	R1843	QRL022J-562	5.6K 2W R. NETWORK	
	R1851	QRJ146J-100X	10 1/4W R. NETWORK	
	R1852	QRJ146J-100X	10 1/4W R. NETWORK	
	R1853	QRJ146J-100X	10 1/4W R. NETWORK	
	R1854	QRJ146J-100X	10 1/4W R. NETWORK	
	R1855	QRZ0197-R22	0.22 1W NETWORK RES.	
	R1856	QRZ0197-R22	0.22 1W NETWORK RES.	
	R1861	QRJ125J-330	33 1/2W R. NETWORK	
	R1862	QRJ125J-330	33 1/2W R. NETWORK	
	R1863	QRL022J-100	10 2W R. NETWORK	
	R1864	QRL022J-100	10 2W R. NETWORK	
	R1871	QRE141J-391Y	390 1/4W R. NETWORK	
	R1872	QRE141J-391Y	390 1/4W R. NETWORK	
	R1873	QRE141J-391Y	390 1/4W R. NETWORK	
	R1874	QRE141J-391Y	390 1/4W R. NETWORK	
	R1875	QRE141J-201Y	200 1/4W R. NETWORK	
	R1876	QRE141J-201Y	200 1/4W R. NETWORK	
	R1877	QRE141J-201Y	200 1/4W R. NETWORK	
	R1878	QRE141J-201Y	200 1/4W R. NETWORK	
	R1891	QRE141J-272Y	2.7K 1/4W R. NETWORK	
	R1892	QRE141J-272Y	2.7K 1/4W R. NETWORK	
	R1893	QRE141J-153Y	15K 1/4W R. NETWORK	
	R1894	QRE141J-153Y	15K 1/4W R. NETWORK	
	R1895	QRE141J-123Y	12K 1/4W R. NETWORK	
	R1896	QRE141J-123Y	12K 1/4W R. NETWORK	
	R1897	QRE141J-104Y	100K 1/4W R. NETWORK	
	R1898	QRE141J-104Y	100K 1/4W R. NETWORK	
		OTHERS		
		QWE881-18RR	VINYL WIRE	
		QWE881-38RR	VINYL WIRE	
		QWE882-16RR	VINYL WIRE	
		QWE882-36RR	VINYL WIRE	
		QWE883-12RR	VINYL WIRE	
		QWE884-14RR	PIN WIRE	
		QWE884-20RR	VINYL WIRE	
		QWE886-12RR	VINYL WIRE	
		QWE886-16RR	PIN WIRE	
		QWE886-26RR	VINYL WIRE	
		QWE888-14RR	PIN WIRE	
		QYSBSG3008E	T. SCREW	
	G	QWE882-14RR	VINYL WIRE	
	H	QWE880-14RR	VINYL WIRE	
	10	QWE881-12RR	VINYL WIRE	
	J091	QNS0023-001	JACK	
△	S001	QSW0650-001	PUSH SWITCH	
△	T002	ETP1000-412B	POWER TRANSFORMER	
	CN051	QGB2510J1-08	CONNECTOR	
	CN052	QGB2510J1-08	CONNECTOR	
	CN053	QGB2510J1-05	CONNECTOR	
	CN402	QGF1205C1-21	CONNECTOR	
	CN701	EWS216-007	SOCKET WIRE ASSY	
	CN703	EWS288-001	VINYL WIRE	
	CN705	QGB2510K1-12	CONNECTOR	
	CN811	QGA3901F2-03	CONNECTOR	
	CN953	EWS356-003	SOCKET WIRE ASSY	
	EP001	E409182-001SM	EARTH TERMINAL	
	EP002	QNZ0136-001Z	1M EARTH PLATE	
	EP051	QNZ0136-001Z	1M EARTH PLATE	
	FC001	QNG0020-001Z	FUSE CLIP I.M	
	FC002	QNG0020-001Z	FUSE CLIP I.M	
	FC003	QNG0020-001Z	FUSE CLIP I.M	
	FC004	QNG0020-001Z	FUSE CLIP I.M	

△	Item	Parts Number	Description	Area
	FC005	QNG0020-001Z	FUSE CLIP I.M	
	FC006	QNG0020-001Z	FUSE CLIP I.M	
	FC061	QNG0020-001Z	FUSE CLIP I.M	
	FC062	QNG0020-001Z	FUSE CLIP I.M	
	FC063	QNG0020-001Z	FUSE CLIP I.M	
	FC064	QNG0020-001Z	FUSE CLIP I.M	
	FW051	EWR37D-10SS	FLAT WIRE	
	FW901	EWR33D-08LS	CORD	
	FW962	EWR33D-15LS	FLAT WIRE	
	HS051	E70945-H40B	HEAT SINK	
	L1761	QQLZ005-R45	INDUCTOR	
	L1861	QQLZ005-R45	INDUCTOR	
	L1862	QQLZ005-R45	INDUCTOR	
△	RY001	QSK0039-001	RELAY	
	RY061	QSK0082-001	RELAY	
	RY981	QSK0042-001	RELAY	
	RY982	QSK0042-001	RELAY	
	ST981	QNB0013-001	SPK TERMINAL	
	TA001	QNZ0079-001Z	TAB I.M	
	TA002	QNZ0079-001Z	TAB I.M	
	TH071	QAD0095-4R7Z	POSITIVE THERMISTOR	
	TH731	QAD0012-202	THERMISTOR	
	TH831	QAD0012-202	THERMISTOR	
	TH832	QAD0012-202	THERMISTOR	
	VS001	QSW0524-001	LEVER SWITCH	

## ■ Accessories List

Block No. M2MM

△	Item	Parts Number	Parts Name	Q'ty	Description	Version & Area
	1	LVT0014-001A	INSTRUCTION BOOK	1		PBK
		LVT0028-001A	INSTRUCTION BOOK	1		PGD
		LVT0068-001A	INSTRUCTION BOOK	1		VBKU
		LVT0068-002A	INSTRUCTION BOOK	1		VBKUT
	2	LV40383-001A	SIGNAL CORD	1		
	3	EWP201-011	ANTENNA WIRE	1		
	4	QAL0014-001	LOOP ANTENNA	1		
	5	QAM0055-001	CONVERSION PLUG	1		UF, UT
		QAM0112-001	AC PLUG ADAPTER	1		U, US
	6	RM-SR774XUKP	WIRE-LESS REMOTE CONTROL	1		PBK, PGD
		RM-SR774NU	WIRE-LESS REMOTE CONTROL	1		VBK
	7	R03BPA/2STS	BATTERY	1		
	8	QPA02503505P	POLY BAG	1		
	9	BT-59009-1	S. CENTER LIST	1		UF
	10	BT-59011-1	WARANTY CARD	1		UF

# Packing Materials and Parts Numbers

Block No. M 3 M M

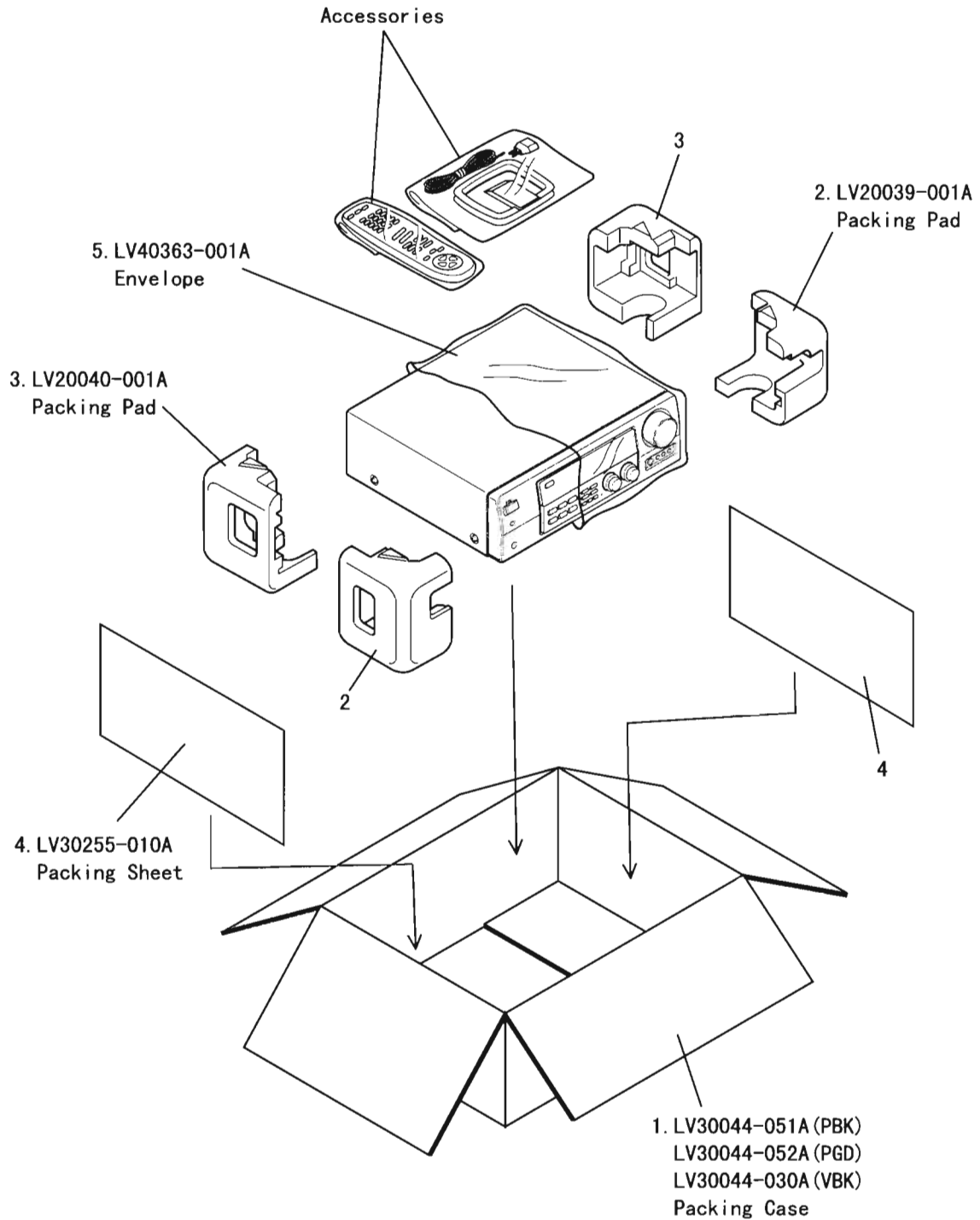

RX-774PBK  
RX-774PGD  
RX-774VBK

**JVC**

VICTOR COMPANY OF JAPAN, LIMITED

AUDIO DIVISION, 10-1, 1Chome, Ohwatari-machi, Maebashi-city. 371-8543, Japan

No.20692

 Printed in Japan  
9806(V)