

JVC

SERVICE MANUAL

AUDIO/VIDEO CONTROL RECEIVER

RX-882VBK RX-992VBK

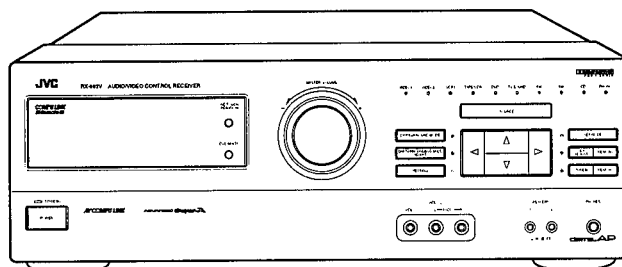
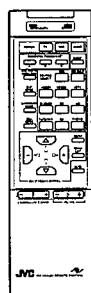
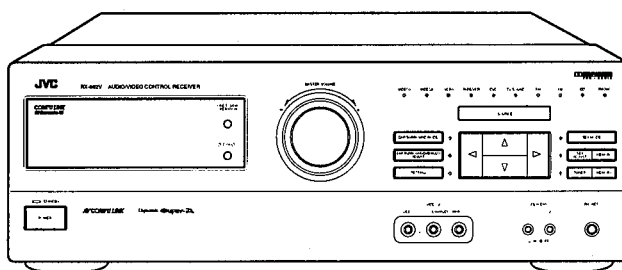
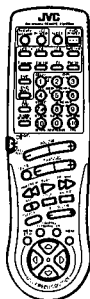

Area Suffix

C Canada
J the U.S.A.

COMPU LINK
Remote

AV COMPU LINK

Contents

<i>Safety Precautions</i>	1-2	<i>Adjustment Procedures</i>	2-28
<i>Instruction Book</i>	1-3	<i>Block Diagrams</i>	2-29
<i>Description of Major ICs</i>	2-1	<i>Schematic Diagrams</i>	2-34
<i>Internal Connection of Display</i>	2-21	<i>Printed Circuit Boards</i>	2-41
<i>Disassembly Procedures</i>	2-23	<i>Parts List</i>	3-1



Safety Precautions

1. The design of this product contains special hardware and many circuits and components specially for safety purposes. For continued protection, no changes should be made to the original design unless authorized in writing by the manufacturer. Replacement parts must be identical to those used in the original circuits. Services should be performed by qualified personnel only.
2. Alterations of the design or circuitry of the product should not be made. Any design alterations of the product should not be made. Any design alterations or additions will void the manufacturer's warranty and will further relieve the manufacture of responsibility for personal injury or property damage resulting therefrom.
3. Many electrical and mechanical parts in the products have special safety-related characteristics. These characteristics are often not evident from visual inspection nor can the protection afforded by them necessarily be obtained by using replacement components rated for higher voltage, wattage, etc. Replacement parts which have these special safety characteristics are identified in the Parts List of Service Manual. Electrical components having such features are identified by shading on the schematics and by (Δ) on the Parts List in the Service Manual. The use of a substitute replacement which does not have the same safety characteristics as the recommended replacement parts shown in the Parts List of Service Manual may create shock, fire, or other hazards.
4. The leads in the products are routed and dressed with ties, clamps, tubings, barriers and the like to be separated from live parts, high temperature parts, moving parts and/or sharp edges for the prevention of electric shock and fire hazard. When service is required, the original lead routing and dress should be observed, and it should be confirmed that they have been returned to normal, after re-assembling.

5. Leakage current check (Electrical shock hazard testing)

After re-assembling the product, always perform an isolation check on the exposed metal parts of the product (antenna terminals, knobs, metal cabinet, screw heads, headphone jack, control shafts, etc.) to be sure the product is safe to operate without danger of electrical shock.

Do not use a line isolation transformer during this check.

- Plug the AC line cord directly into the AC outlet. Using a "Leakage Current Tester", measure the leakage current from each exposed metal parts of the cabinet, particularly any exposed metal part having a return path to the chassis, to a known good earth ground. Any leakage current must not exceed 0.5mA AC (r.m.s.).

● Alternate check method

Plug the AC line cord directly into the AC outlet. Use an AC voltmeter having, 1,000 ohms per volt or more sensitivity in the following manner. Connect a 1,500 Ω 10 W resistor paralleled by a 0.15 μ F AC-type capacitor between an exposed metal part and a known good earth ground.

Measure the AC voltage across the resistor with the AC voltmeter.

Move the resistor connection to each exposed metal part, particularly any exposed metal part having a return path to the chassis, and measure the AC voltage across the resistor.

Now, reverse the plug in the AC outlet and repeat each measurement. Any voltage measured must not exceed 0.75 V AC (r.m.s.).

This corresponds to 0.5 mA AC (r.m.s.).

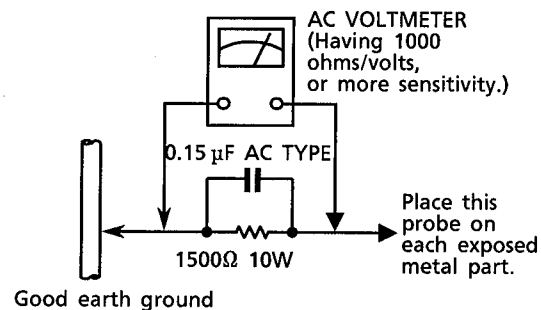

Warning

1. This equipment has been designed and manufactured to meet international safety standards.
2. It is the legal responsibility of the repairer to ensure that these safety standards are maintained.
3. Repairs must be made in accordance with the relevant safety standards.
4. It is essential that safety critical components are replaced by approved parts.
5. If mains voltage selector is provided, check setting for local voltage.

JVC



Warnings, Cautions and Others



CAUTION
RISK OF ELECTRIC SHOCK
DO NOT OPEN



CAUTION: TO REDUCE THE RISK OF ELECTRIC SHOCK, DO NOT REMOVE COVER (OR BACK). NO USER SERVICEABLE PARTS INSIDE. REFER SERVICING TO QUALIFIED SERVICE PERSONNEL.

The lightning flash with arrowhead symbol, within an equilateral triangle is intended to alert the user to the presence of uninsulated "dangerous voltage" within the product's enclosure that may be of sufficient magnitude to constitute a risk of electric shock to persons.

The exclamation point within an equilateral triangle is intended to alert the user to the presence of important operating and maintenance (servicing) instructions in the literature accompanying the appliance.



CAUTION

- To reduce the risk of electrical shocks, fire, etc.:
1. Do not remove screws, covers or cabinet.
 2. Do not expose this appliance to rain or moisture.

Caution — POWER switch!
Disconnect the mains plug to shut the power off completely. The POWER switch in any position does not disconnect the mains line. The power can be remote controlled.

Caution — SPEAKER LOAD SELECTOR switch!
Match the position of SPEAKER LOAD SELECTOR switch on the back panel to the impedance of the speaker connected, to protect from overheating.

WARNING: TO REDUCE THE RISK OF FIRE OR ELECTRIC SHOCK, DO NOT EXPOSE THIS APPLIANCE TO RAIN OR MOISTURE.

AUDIO/VIDEO CONTROL RECEIVER

RX-882VBK

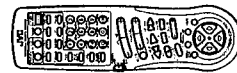

COMPU LINK
Remote III

AV COMPU LINK

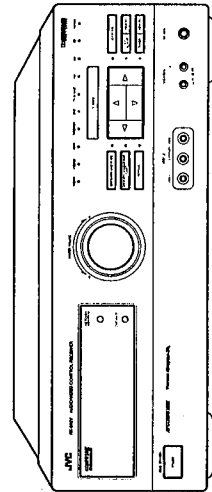

INSTRUCTIONS

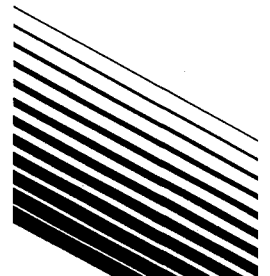

For Customer Use:
Enter below the Model No. and Serial No. which are located either on the rear, bottom or side of the cabinet. Retain this information for future reference.

Model No. _____
Serial No. _____

LET0024-001A (J)

G-1

Table of Contents

Getting Started	2
Before Installation	2
Checking the Supplied Accessories	2
Switches, Buttons and Controls	3
Connecting the FM and AM Antennas	5
Connecting the Speakers	6
Connecting Audio/Video Components	8
Connecting the Power Cord	11
Putting Batteries in the Remote Control	11
Basic Operations	12
Turning the Power On and Off	12
Selecting the Source to Play	12
Adjusting the Volume	13
Selecting the Front Speakers	13
Muting the Sound	14
Recording a Source	14
Basic Settings	15
Adjusting the Front Speaker Output Balance	15
Listening at Low Volume (Loudness)	15
Using the Sleep Timer	16
Selecting the Center Speaker Size	17
Using Visual Confirmation	18
One Touch Operation	19
About the One Touch Operation	19
Using the One Touch Operation	19
Receiving Radio Broadcasts	20
Tuning in Stations Manually	20
Using Preset Tuning	20
Selecting the FM Reception Mode	21
Assigning Names to Preset Stations	22
Using the SEA Modes	23
Selecting Your Favorite SEA Mode	23
Creating Your Own SEA Mode	24
Activating the Surround Sounds	25
Using the DAP Modes	26
Using the DVD MULTI Playback Mode	28
Using the Surround Modes	30
Using the On-Screen Display to Control the Receiver	36
COMPU LINK Remote Control System	40
AV COMPU LINK Remote Control System	41
Using the Remote Control for Operating JVC's Audio/Video Components	43
Operating Other Manufacturers' VCR, TV, CATV Converter, and Satellite Tuners	46
Troubleshooting	52
Specifications	53

 This mark indicates that you can also use the menu function to do the same operations. Actual operations using the menu function are explained on the pages indicated next to the marks.

Getting Started

This section explains how to connect audio/video components and speakers to the receiver, and how to connect the power supply.

Before Installation

General

- Be sure your hands are dry.
- Turn the power off to all components.
- Read the manuals supplied with the components you are going to connect.

Locations

- Install the receiver in a location that is level and protected from moisture.
- The temperature around the receiver must be between 23° and 95° F (-5° and 35° C).
- Make sure there is good ventilation around the receiver. Poor ventilation could cause overheating and damage the receiver.

Handling the receiver

- Do not insert any metal object into the receiver.
- Do not disassemble the receiver or remove screws, covers, or cabinet.
- Do not expose the receiver to rain or moisture.

Checking the Supplied Accessories

Check to be sure you have all of the following items, which are supplied with the receiver. The number in the parenthesis indicates the quantity of the pieces supplied.

- Remote Control (1)
- Batteries (2)
- AM Loop Antenna (1)
- FM Antenna (1)

If anything is missing, contact your dealer immediately.

Switches, Buttons and Controls

Become familiar with the main switches and controls on your receiver before use.

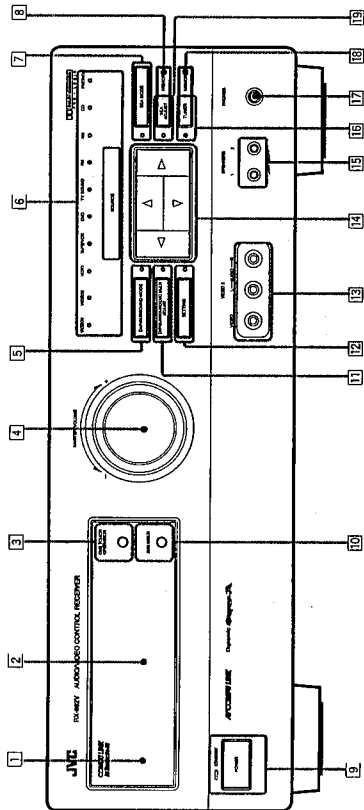

Refer to the pages in parentheses for details.

Front Panel

- 1 Remote sensor (11)
- 2 Display (12)
- 3 ONE TOUCH OPERATION button and lamp (19)
- 4 MASTER VOLUME control (13)
- 5 DAPSURROUND MODE button and lamp (26, 31)
- 6 SOURCE button and lamps (12)
- 7 SEA MODE button and lamp (23)
- 8 MEMORY button for SEA adjustments (24)
- 9 POWER button and STANDBY lamp (12)
- 10 DVD MULTI button and lamp (12)
- 11 DAPSURROUND/DVD MULTI ADJUST button and lamp (26, 28, 31)
- 12 SETTING button and lamp (15)
- 13 VIDEO 2 input jacks (10)
- 14 Control $\Delta / \nabla / \triangleleft / \triangleright$ buttons (15)
- 15 SPEAKERS 1/2 buttons (13)
- 16 TUNER button and lamp (20)
- 17 PHONES jack (14)
- 18 MEMORY button for presetting channels (20)
- 19 SEA ADJUST button and lamp (24)

IMPORTANT
To use Control $\Delta / \nabla / \triangleleft / \triangleright$ buttons (14) on the front panel:

What these buttons actually do depends on which function you are trying to adjust. Before using these buttons, select the function by pressing one of the function selecting buttons (5), (6), (7), (8), (9), (10), and being sure its lamp is lit.

However, pressing MENU (12) on the remote control overrides the selected function and causes Control $\Delta / \nabla / \triangleleft / \triangleright$ button to act like $\Delta / \nabla / \triangleleft / \triangleright$ buttons (14) of the ON SCREEN CONTROL section of the remote control (though a lamp for the selected function remains lit).
To return the Control $\Delta / \nabla / \triangleleft / \triangleright$ buttons to their usual behavior under the selected function, press the function button again.

Remote Control

Remote Control Unit

- 20 TV/CATV/SAT POWER and VCR POWER buttons (44, 45)
- 21 Source selecting buttons (13)
- 22 CD DISC button (44)
- 23 SOUND CONTROL button (23, 27, 29, 34)
- 24 Remote control mode selector (AUDIO/TV/VCR, CATV/SAT) (12)
- 25 MUTE button (14)
- 26 MENU EXIT button (36)
- 27 SLEEP button (16)
- 28 AUDIO POWER button (12)
- 29 10 keys for selecting preset channel (21)
- 30 10 keys for adjusting sound (23, 27, 29, 34)
- 31 Operating buttons for audio/video components (43, 46)
- 32 VOLUME buttons (+/-) (13)
- 33 CHANNEL buttons (+/-) (44, 45)
- 34 Operating buttons for audio/video components (43, 46)
- 35 MENU button (36)
- 36 $\Delta / \nabla / \triangleleft / \triangleright$ buttons of the ON SCREEN CONTROL section (36)

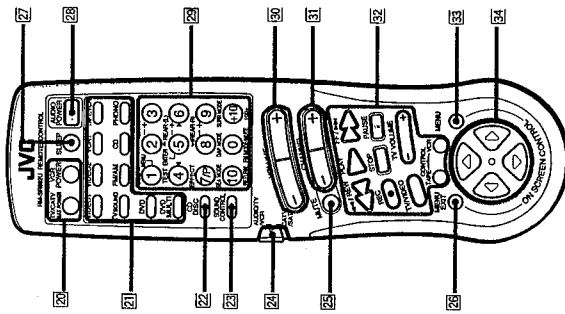

IMPORTANT

When using the remote control: Check to see if its remote control mode selector (24) is set to the correct position. To operate an audio system, TV, and VCR, set it to the "AUDIO/TV/VCR" position. To operate a CATV converter and satellite tuner, set it to the "CATV/SAT" position.
About $\Delta / \nabla / \triangleleft / \triangleright$ buttons (36) of the ON SCREEN CONTROL section on the remote control: if you press these buttons, the menu function starts operating. So, make sure you are showing the on-screen display on the TV before pressing these buttons.

Connecting the Speakers

You can connect the following speakers:

- Two pairs of front speakers to produce normal stereo sound.
- One pair of rear speakers to enjoy the surround effect.
- One center speaker to produce more effective surround effect (to emphasize human voices).
- One subwoofer to enhance the bass.

For each speaker (except for subwoofer), connect the black (-) and red (+) terminals on the rear panel to the black (-) and red (+) terminals marked on the speakers. For connecting a subwoofer, see page 7.

CAUTION:
Use speakers with the **SPEAKER IMPEDANCE** indicated by the speaker terminals.

Connecting the front speakers

Cut, twist and remove the insulation at the end of each speaker signal cable first, and then, connect the front speakers to the **FRONT SPEAKERS** terminals by using the cables. You can connect two pairs of front speakers (one pair to the **FRONT SPEAKERS ①** terminals, and another pair to the **FRONT SPEAKERS ②** terminals).

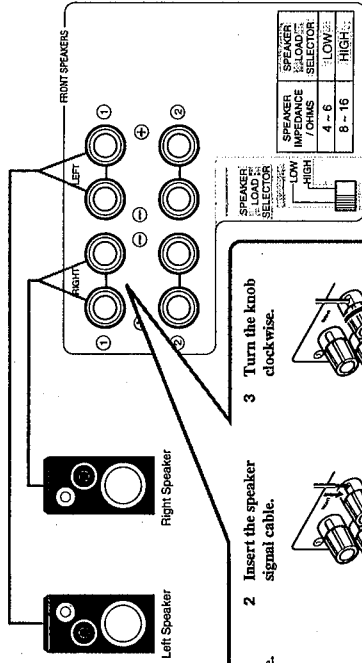
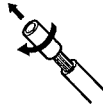

- 1 Turn the knob counterclockwise.
- 2 Insert the speaker signal cable.
- 3 Turn the knob clockwise.

Notes:

- To obtain the best possible output power from the receiver, and to prevent the receiver from being overheated, the receiver has the **SPEAKER LOAD SELECTOR** which should be set to match the impedance of the connected speakers. Set this selector according to the indications by the **FRONT SPEAKERS** terminals.
- When you connect two pairs of the speakers to the **FRONT SPEAKERS** terminals, use the speakers having the impedance within the same range.

Connecting the FM and AM Antennas

FM Antenna Connections

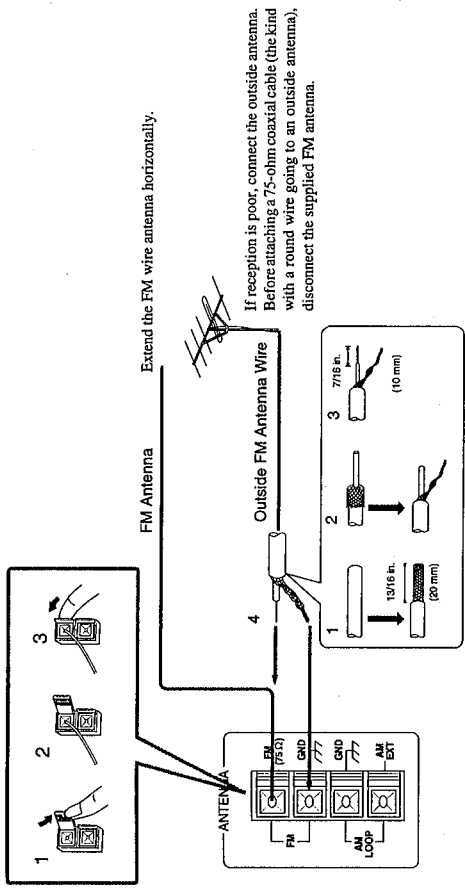

How to strip the 75-ohm coaxial cable and connect it to the FM terminals

1. Strip back the outside covering of the 75-ohm coaxial cable to expose the braided metallic mesh about 13/16 inches (20 mm).
2. Pull the mesh back and twist it into a single connector, as shown in the illustration above.
3. Strip the insulation about 7/16 inches (10 mm) back from the central wire.
4. Insert the twisted mesh and the central wire to the FM terminals, as shown in the illustration above.

AM Antenna Connections

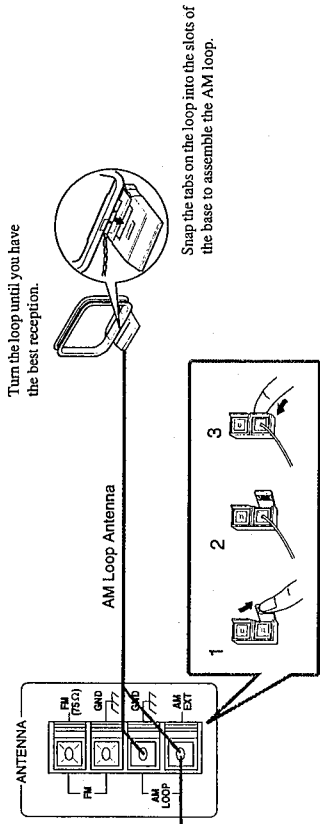

Outdoor Single Vinyl-covered Wire

If reception is poor, connect an outdoor single vinyl-covered wire to the **AM EXT** terminal. (Keep the AM loop antenna connected.)

Note:
Make sure the antenna conductors do not touch any other terminals, connecting cords and power cord. This could cause poor reception.

Connecting the rear and center speakers

Cut, twist and remove the insulation at the end of each speaker signal cable first, and then, connect rear speakers to the REAR SPEAKERS terminals and a center speaker to the CENTER SPEAKER terminals by using the cables.

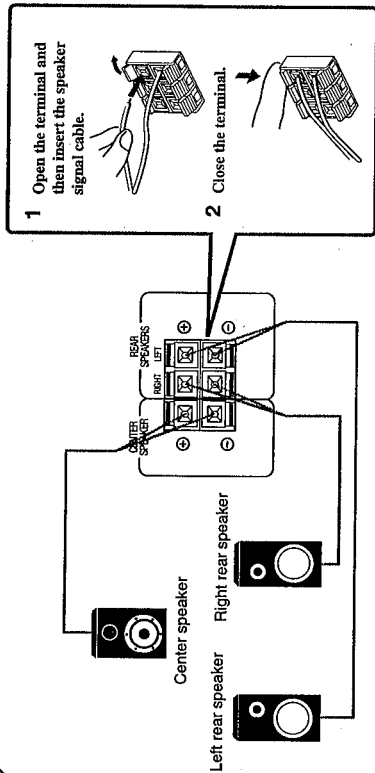

Note: You can register the center speaker size after you finish its connection. If you register it, you do not have to set the center speaker mode when setting the surround mode. (If you do not use a center speaker, register that information.) See page 17.

Connecting the subwoofer speaker

You can enhance the bass by connecting a subwoofer. Connect the input jack of a powered subwoofer to the SUBWOOFER OUT jack on the rear panel, using a cable with RCA pin plugs.

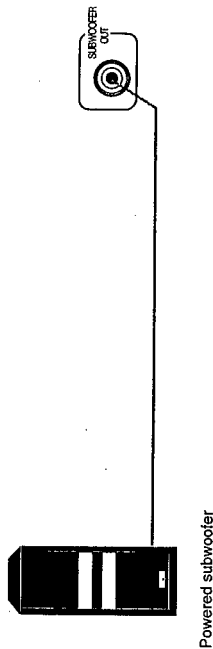

Connecting Audio/Video Components

You can connect the following audio/video components to this receiver using cables with RCA pin plugs (not supplied). Refer also to the manuals supplied with your components. If you want to connect a component not listed in the table below, refer to the manual supplied with it.

Audio Components	Video Components
• Turntable	• DVD (Digital Video Disc) player
• CD player	• TV
• Cassette deck	• VCR(s)
	• Video disc player
	• Video camera

- Notes:**
- If you connect a sound-enhancing device such as a graphic equalizer between the source components and this receiver, the sound output through this receiver may be distorted.
 - You can connect either a cassette deck or a VCR to the TAPE/VCR jacks, whichever you want.
 - Any turntables incorporating a small-output cartridge such as an MC (moving-coil type) must be connected to this receiver through a commercial head amplifier or step-up transformer. Direct connection may result in insufficient volume.

Audio component connections

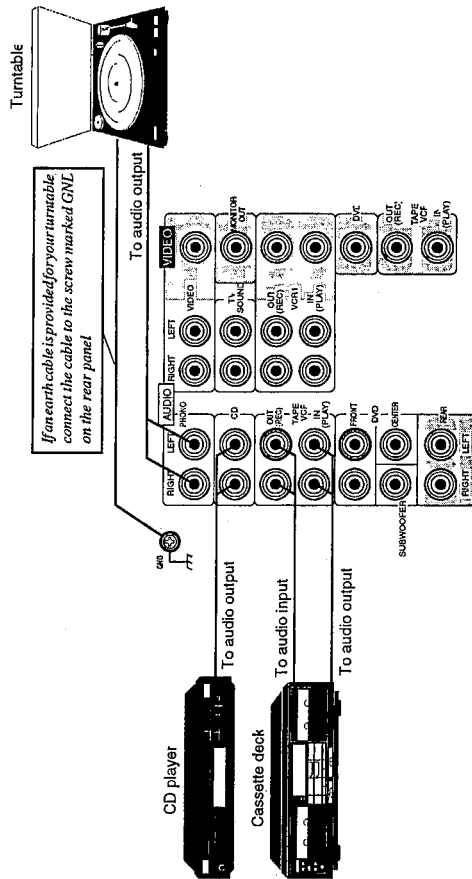

If your audio components have a COMPU LINK-3 terminal

The COMPU LINK remote control system allows you to control other JVC audio components from the receiver or vice versa. Connect your audio components and the receiver with the cable (monaural mini-plug supplied with those components) as well as the connection above. For detailed information about the connection and the COMPU LINK-3 remote control system, see page 40.

Notes:

- If you want to operate a cassette deck using the COMPU LINK remote control system, connect the cassette deck to the TAPE/VCR jacks, not to the VCR jacks.
- The COMPU LINK-3 remote control system is the upgraded version of the COMPU LINK-1 and COMPU LINK-2. Even if your component has the COMPU LINK-1 or COMPU LINK-2 jacks, you can still connect it in the COMPU LINK-3 remote control system, but some functions may not work correctly.

Video component connections

TV connection

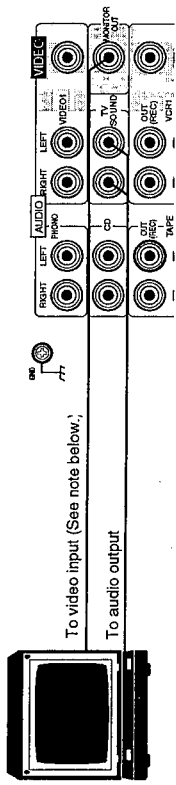

To video input (See note below.)

To audio output

- Note:**
- When connecting a JVC TV, connect the receiver to the Video Input 2 jack on the TV.
 - If you use the AV COMPU LINK remote control system to operate the TV, connect the receiver to the Video Input 1 jack on the TV.
 - If you do not use the AV COMPU LINK remote control system to operate TV, connect the receiver to the Video Input 1 jack on the TV.

DVD player connection

- When you play back a disc on the DVD player in stereo (or the audio output setting of the DVD player is mixed to two front channels):

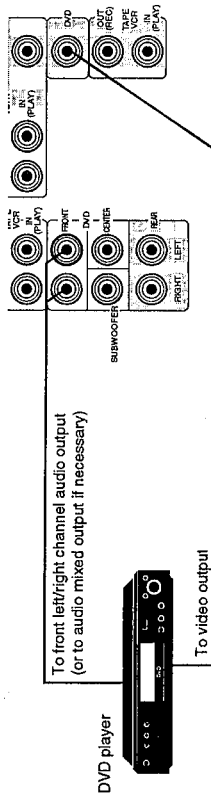

To front left/right channel audio output (or to audio mixed output if necessary)

To video output

- When you play back a disc on the DVD player with its analog discrete output mode (5.1 CH reproduction) selected:

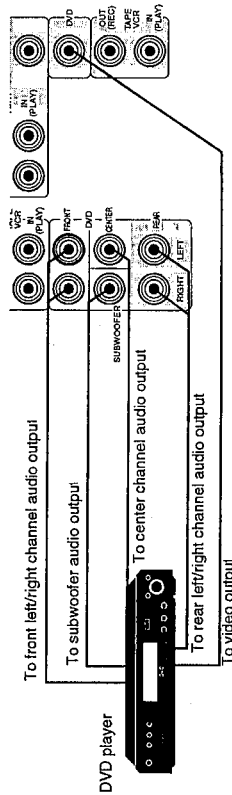

To front left/right channel audio output

To subwoofer audio output

To center channel audio output

To rear left/right channel audio output

To video output

VCR and video disc player connection

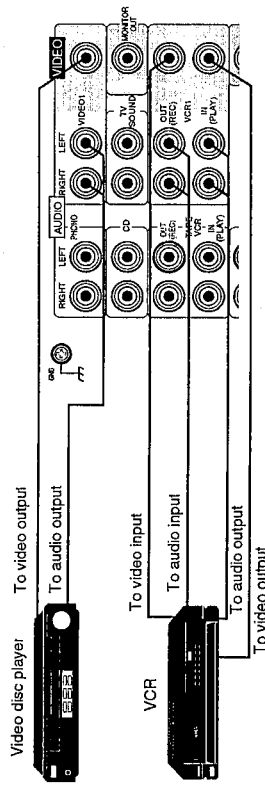

To video output

To audio output

To video input

To audio input

To video output

Another VCR connection

If you are not using a cassette deck, you can connect another VCR to the TAPE/VCR jacks.

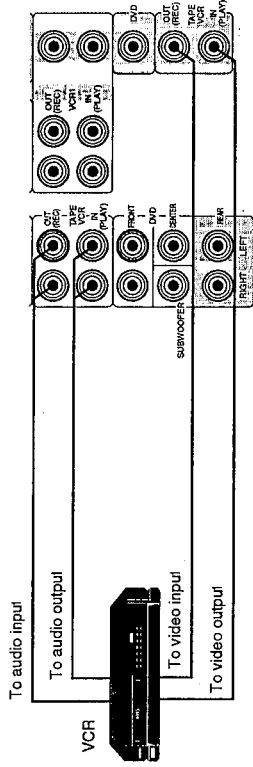

To audio input

To audio output

To video input

To video output

Video camera connection

You can use the VIDEO 2 input jacks on the front panel. These jacks are convenient for connecting and disconnecting the component frequently.

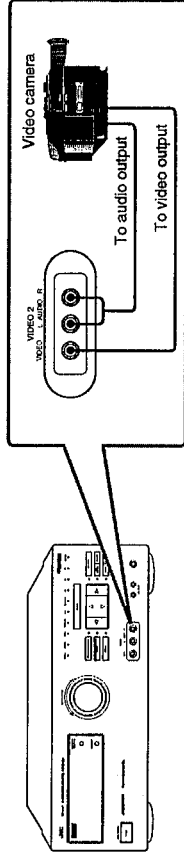

VIDEO 2

VIDEO 1

VIDEO 2

VIDEO 1

VIDEO 2

If your video components have an AV COMPU LINK terminal

The AV COMPU LINK remote control system allows you to control other IVC video components from the receiver or vice versa

For detailed information about the connection and the AV COMPU LINK remote control system, see page 41

Notes:

- The AV COMPU LINK remote control system cannot control the video components connected to the VIDEO 1, VIDEO 2, and TAPE/VCR jacks on the receiver, but can control only the VCR connected to the VCR1 jacks and the DVD player connected to the DVD jacks. You cannot connect two VCRs into the AV COMPU LINK remote control system.
- Some VCRs use the AV COMPU LINK jacks for the SWAP editing. However, you cannot use both the AV COMPU LINK remote control and the SWAP editing at the same time. For the SWAP editing, see the manual supplied with the VCR.

Basic Operations

The following operations are commonly used when you play any sound source

IMPORTANT

When using the Remote Control, check to see if its remote control mode selector is set to the correct position.
To operate an audio system, TV, and VCR, set it to the "AUDIO/TV/VCR" position.
To operate a CATV converter and satellite tuner, set it to the "CATV/SAT" position.



Turning the Power On and Off

On the front panel

To turn on the power, press POWER.

The STANDBY lamp goes off. The name of the current source appears on the display

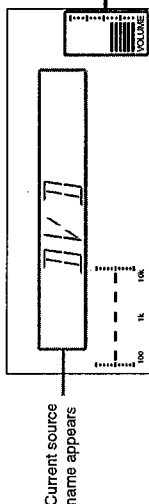

Current source name appears

Volume level is also shown here whenever the power is ON.

To turn off the power, press POWER again.

The STANDBY lamp lights up

From the remote control:

To turn on the power, press AUDIO POWER.

The STANDBY lamp goes off. The name of the current source appears on the display

To turn off the power, press AUDIO POWER again.

The STANDBY lamp lights up

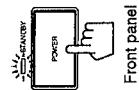
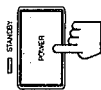

Front panel



Remote Control

Selecting the Source to Play

You need to select the source before you start playing any source

On the front panel

1. Press SOURCE so that the Control Δ / ∇ / \triangleleft / \triangleright buttons work for selecting the source.
2. Press Control Δ / ∇ until the source name you want appears on the display.
The selected source lamp also lights up.

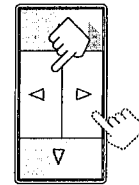
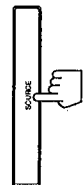

Front panel

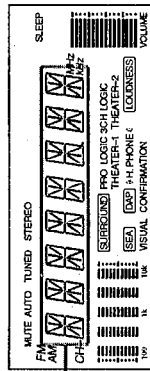

Selected source name appears

For selecting DVD MULTI playback mode as the source:

- Press DVD MULTI so that the lamp above the button lights up
Each time you press the button, the DVD MULTI playback mode turns on and off, and the "DVD" and "DVMULTI" alternately appears on the display.
- Select "DVD" when you play back a disc in stereo or the audio output setting of the DVD player is mixed to two front channels.
 - Select "DVMULTI" when you play back a disc on the DVD player with its analog discrete output mode (5.1 CH reproduction) selected. To enjoy "DVMULTI" mode, see page 28.

Notes:

- You can change the source to another even while the DVD MULTI lamp is lit.
- You can also select "DVMULTI" by pressing Control \triangleleft / \triangleright when "DVD" is selected.

Connecting the Power Cord

Before plugging the receiver into an AC outlet, make sure that all connections have been made. When the power cord is connected, the STANDBY lamp above the POWER button lights up.

Keep the power cord away from the connecting cables for the TV, VCR, and antenna. The power cord may cause noise or screen interference. We recommend that you use a coaxial cable to connect the antenna, since it is well-shielded against interference.

Notes:

- A small amount of power is always consumed even in standby mode. To switch off the power completely, unplug the power cord from the AC outlet.
- If the power cord is unplugged or a power failure occurs, preset settings will be erased in a few days.

CAUTIONS:

- Do not touch the power cord with wet hands
- Do not pull on the power cord to unplug the cord. When unplugging the cord, always grasp the plug so as not to damage the cord

Putting Batteries in the Remote Control

Before using the remote control, put two supplied batteries first. When using the remote control, aim the remote control directly at the remote sensor on the receiver.

1. On the back of the remote control, remove the cover as illustrated.
2. Insert batteries. Make sure to observe the proper polarity: (+) to (+) and (-) to (-).
3. Replace the cover in.

R03 (UM-4)/AAA (24F)

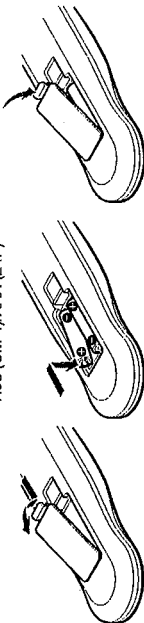

If the range or effectiveness of the remote control decreases, replace the batteries. Use two R03 (UM-4)/AAA (24F) type dry-cell batteries.

CAUTIONS:

- Follow these precautions to avoid leaking or cracking cells:
- Place batteries in the remote control so they match the polarity indicated: (+) to (+) and (-) to (-)
- Use the correct type of batteries. Batteries that look similar may differ in voltage.
- Always replace both batteries at the same time.
- Do not expose batteries to heat or flame.

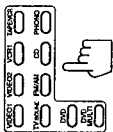

Remote Control

From the remote control:

Press one of the Source selecting buttons you want.

- DVD Play back a stereo digital video disc.
- DVD MULTI Play back a digital video disc using the analog discrete output mode (5.1 CH reproduction) on the DVD player.
- VIDEO1 Each time you press the button, the DVD MULTI playback mode turns on and off.
- VIDEO2 Play back a video source on the video component connected to the VIDEO1 jacks.
- VCR Play back a video source on the video component connected to the VIDEO2 jacks.
- TV SOUND Listen to TV sounds.
- FM* Listen to FM broadcasts.
- AM* Listen to AM broadcasts.
- TAPE/VCR* Listen to a cassette tape (or play back a video source) connected to the TAPE/VCR jacks.
- CD* Listen to a CD.
- PHONO* Listen to a record.

Note:
When you press one of the Source selecting buttons marked above with an asterisk (*), the receiver automatically turns on.

Adjusting the Volume

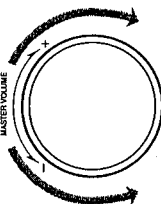

Master Volume



Volume

When you change the volume level, the volume level is shown on the display.

On the front panel:

- To increase the volume, turn MASTER VOLUME clockwise.
- To decrease the volume, turn MASTER VOLUME counterclockwise.

Note:
When you turn MASTER VOLUME rapidly, the volume level also changes rapidly.
When you turn MASTER VOLUME slowly, the volume level also changes slowly.

From the remote control:

- To increase the volume, press VOLUME +.
- To decrease the volume, press VOLUME -.

CAUTION:
Always set the volume level to the minimum before starting any source. If the volume level is left turned up, the sudden blast of sound energy can permanently damage your hearing and/or ruin your speakers.

Selecting the Front Speakers

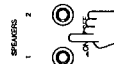

Front Panel

On the front panel only:

- When you have connected two pairs of the front speakers, you can select which to use. Pressing SPEAKERS 1 or SPEAKERS 2 to set it in the -ON position activates the respective pair of the speakers.
- To use the speakers connected to the FRONT SPEAKERS ① terminals, press SPEAKERS 1 to set it in the -ON position, and press SPEAKERS 2 to set it in the -OFF position.
- To use the speakers connected to the FRONT SPEAKERS ② terminals, press SPEAKERS 2 to set it in the -ON position, and press SPEAKERS 1 to set it in the -OFF position.
- To use both pairs of the speakers, press both SPEAKERS 1 and 2 to set them in the -ON position.
- To use neither pair of the speakers, press both SPEAKERS 1 and 2 to set them in the -OFF position.

Note:
When only one set of the speakers is connected to either the FRONT SPEAKERS ① or ② terminals, do not press both SPEAKERS 1 and 2 to set them in the -ON position. If you do, no sound comes out of the front speakers.

Listening with Headphones

A standard pair of headphones can be connected to the PHONES jack on the front panel.

To listen with only headphones, press both SPEAKERS 1 and 2 to set them in the -OFF position. No sound comes out of the front speakers.

CAUTION:

Be sure to turn down the volume before connecting or putting on headphones, as high volume can damage both the headphones and your hearing.

Muting the Sound



Remote Control

From the remote control only:

To mute the sound through all the speakers and headphones connected, press MUTE so that "MUTE" appears on the display and the volume turns off.

To cancel the mute, press MUTE again so that "OFF" appears on the display. Turning MASTER VOLUME or pressing VOLUME +/- also restores the sound at the previous volume level.

Recording a Source

You can record any source playing through the receiver to the cassette deck (or VCR) connected to the TAPE/VCR jacks and the VCR connected to the VCR1 jacks at the same time. While recording, you can listen to the selected sound source at whatever sound level you like, without affecting the sound levels of the recording.

Note:

The output volume level, SEA, DAP and surround adjustments cannot affect the recording.

Basic Settings

Some of the following settings are required after connecting and positioning your speakers in your listening room, while others will make operations easier.

Adjusting the Front Speaker Output Balance

If the sounds you hear from the front right and left speakers are unequal, you can adjust the speaker output balance.

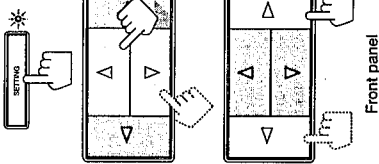

On the front panel only:

1. Press **SETTING** so that the Control $\Delta / \nabla / \triangleleft / \triangleright$ buttons work for adjusting the balance. The lamp next to the button lights up.
2. Press Control Δ / ∇ until "BALANCE" appears on the display.
3. Press Control $\triangleleft / \triangleright$ to adjust the balance.
 - Pressing Control \triangleleft decreases the right channel output.
 - Pressing Control \triangleright decreases the left channel output.

Front panel

See also page 36.

Listening at Low Volume (Loudness)

Human ears are not sensitive to bass at low volume. To compensate for this, the loudness function automatically boosts the bass level as you lower the volume.

Note:
The loudness function affects the front speaker sounds only.

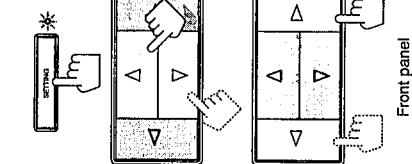

Front panel

See also page 37.

On the front panel only:

1. Press **SETTING** so that the Control $\Delta / \nabla / \triangleleft / \triangleright$ buttons work for setting the loudness function. The lamp next to the button lights up.
2. Press Control Δ / ∇ until "LOUDNESS" appears on the display.
3. Press Control $\triangleleft / \triangleright$ to set the loudness function to "ON" or "OFF."
 - Select "ON" to activate the loudness function.
 - The LOUDNESS indicator lights up on the display.
 - Select "OFF" to cancel it.
 - The indicator goes off.

Using the Sleep Timer

See also page 37.

Using the Sleep Timer, you can fall asleep to music and know the receiver will turn off by itself rather than play all night.

On the front panel:

1. Press **SETTING** so that the Control $\Delta / \nabla / \triangleleft / \triangleright$ buttons work for setting the Sleep Timer. The lamp next to the button lights up.
2. Press Control Δ / ∇ until "<SLEEP>" appears on the display.

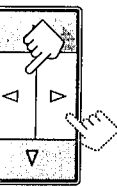

Each time you press the button, the shut-off time on the display changes as follows:

The SLEEP indicator lights up on the display.

→ 10 → 20 → 30 → 40 → 50 → 60 → 70 → 80 → 0 (Cancelled)

When the shut-off time comes
The receiver turns off automatically.

To check or change the time remaining until the shut-off time

1. Press **SETTING**, if necessary, so that the Control $\Delta / \nabla / \triangleleft / \triangleright$ buttons work for setting the Sleep Timer.
2. Press Control Δ / ∇ , if necessary, until "<SLEEP>" appears on the display.
3. Press Control $\triangleleft / \triangleright$ once. The remaining time until the shut-off time appears in minutes.
 - To change the shut-off time, press Control $\triangleleft / \triangleright$ repeatedly.

To cancel the Sleep Timer

Press Control $\triangleleft / \triangleright$ repeatedly in step 3 above until "0" appears on the display. (The SLEEP indicator goes off.) Turning off the power also cancels the Sleep Timer.

From the remote control:

Press **SLEEP** repeatedly. The SLEEP indicator lights up and the shut-off time appears on the display. Each time you press the button, the shut-off time on the display changes as follows:

→ 10 → 20 → 30 → 40 → 50 → 60 → 70 → 80 → 0 (Cancelled)

To check or change the time remaining until the shut-off time
Press **SLEEP** once. The remaining time until the shut-off time appears in minutes.

- To change the shut-off time, press **SLEEP** repeatedly.

To cancel the Sleep Timer

Press **SLEEP** repeatedly until "0" appears on the display. (The SLEEP indicator goes off.) Turning off the power also cancels the Sleep Timer.



Remote Control

See also
page 37.



Using Visual Confirmation

When you operate the receiver, you can see what you are doing by showing it on the TV screen. To use this function, you need to connect the TV to the MONITOR OUT jack on the rear panel (see page 9), and set the TV's input mode to the proper position to which the receiver is connected. When the TV's input mode is for TV, you cannot see the on-screen display.

On the front panel only:

1. Press SETTING so that the Control Δ / ∇ / \triangleleft / \triangleright buttons work for setting Visual Confirmation.
The lamp next to the button lights up.
2. Press Control Δ / ∇ until "VCONFIRM" appears on the display.
3. Press Control \triangleleft / \triangleright to set Visual Confirmation to "ON" or "OFF."
Select "ON" to activate Visual Confirmation.
The VISUAL CONFIRMATION indicator lights up on the display.
Select "OFF" to cancel it.
The indicator goes off.

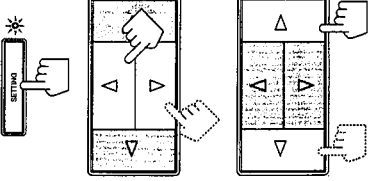

Front panel



The SOURCE menu appears on the TV screen.

EXAMPLES:
When changing the source:

When adjusting the front speaker output balance:

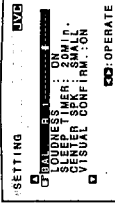

The SETTING menu appears on the TV screen.

When selecting your favorite SEA Mode:

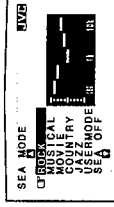

The SEA MODE menu appears on the TV screen.

See also
page 37.



Selecting the Center Speaker Size

You can register the information on the center speaker after all connections are completed. If you do this registration first, you do not have to adjust the center speaker mode when you want to activate the surround sound. However, to register the information, first you have to turn on the surround mode. (You cannot select the center speaker size when the surround mode is off.)

On the front panel only:

1. Press DAP/SURROUND MODE so that the Control Δ / ∇ / \triangleleft / \triangleright buttons work for selecting the DAP/surround mode.
The lamp next to the button lights up.
2. Press Control \triangleleft / \triangleright until the SURROUND indicator lights up on the display.
3. Press SETTING so that the Control Δ / ∇ / \triangleleft / \triangleright buttons work for selecting the center speaker size.
The lamp next to the button lights up.
4. Press Control Δ / ∇ until "CNTR SPK" (Center Speaker) appears on the display.
5. Press Control \triangleleft / \triangleright to select the appropriate item about your center speaker.
Each time you press the button, the display changes to show the following:



LARGE:	Select this mode when the size of the center speaker is the same as that of the front speakers.
SMALL:	Select this mode when the size of the center speaker is smaller than that of the front speakers.
NO:	Select this mode when you do not use a center speaker. (You cannot select this mode when "3CHLOGIC" is selected for the surround mode.)

Note:
This center speaker size setting is so related to the center mode setting for the surround mode that changing this setting affects and changes the center mode to a relevant mode, and vice versa.
For example:
• If you select "LARGE," the center mode is automatically set to "WIDE," and vice versa.
• If you select "SMALL," the center mode is automatically set to "NORMAL," and vice versa.
• If you select "NO," the center mode is automatically set to "PHANTOM" for Pro Logic and Theater Surround, and vice versa.

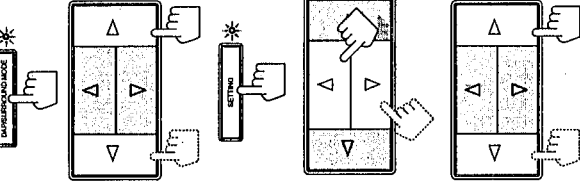

Front panel

One Touch Operation

This receiver can memorize the optimum sound settings for each playing source.

About the One Touch Operation

JVC's One Touch Operation function is used to assign and store different sound settings for each different playing source. By using this function, you don't have to change the settings every time you change the source. The stored settings for the newly selected source are automatically recalled.

The following can be stored for each source:

- Volume level (see page 13)
- Balance (see page 15)
- Loudness (see page 15)
- SEA modes (see page 23)
- DAP mode settings (see page 26)
- DVD MULTI playback mode settings (see page 28)
- Surround mode settings (see page 31)

Notes:

- If the source is FM or AM, the One Touch Operation function works only when the preset channels from 1 - 20 are tuned in. You can assign a different setting for each preset channel.
- The DAP mode, DVD MULTI playback mode, and surround mode cannot be used at the same time.

Using the One Touch Operation

On the front panel only:

To store the sound settings

1. Press ONE TOUCH OPERATION. The ONE TOUCH OPERATION lamp lights up, then the previously memorized settings are recalled and appear on the display in turn.

2. Adjust the sound using the functions listed above. The newly adjusted settings are memorized.

To recall the sound settings

With the ONE TOUCH OPERATION lamp lit, the settings for the currently selected source is recalled, and appears on the display when the source is selected.

To cancel the One Touch Operation function

Press ONE TOUCH OPERATION so that the lamp goes off. (Even though the One Touch Operation function is canceled, the recalled sound effects remain active.)



Front panel

Receiving Radio Broadcasts

You can browse through all the stations or use the preset function to go immediately to a particular station.

See also
page 38.



Tuning in Stations Manually

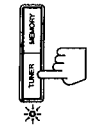

On the front panel only:

1. Press TUNER so that the Control Δ / ∇ / \triangleleft / \triangleright buttons work for tuner settings. The lamp next to the button lights up.
2. Press Control Δ / ∇ until "<FM AM>" appears on the display.
3. Press Control \triangleleft / \triangleright to select the band. Each time you press the button, the band alternates between FM and AM.
4. Press Control Δ / ∇ until "<TUNING>" appears on the display.
5. Press Control \triangleleft / \triangleright until you find the frequency you want.
 - Pressing Control \triangleleft decreases the frequency.
 - Pressing Control \triangleright increases the frequency.

Notes:

- When you hold down Control \triangleleft / \triangleright in step 5, the frequency keeps changing until you press the button again or a station is tuned in.
- When a station of sufficient signal strength is tuned in, the TUNED indicator lights up on the display. When an FM stereo program is received, the STEREO indicator also lights up.

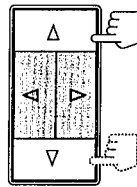
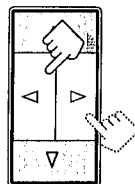

Front panel

Using Preset Tuning

Once a station is assigned to a channel number, the station can be quickly tuned. You can preset up to 40 stations at random.

To store the preset stations

On the front panel only:

1. Tune in the station you want to preset (see above). If you want to store the FM reception mode for this station, select the FM reception mode you want. See page 21 for details.

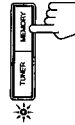
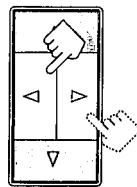
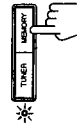

Front panel

2. Press MEMORY (next to the TUNER button). "CH." appears and the channel number position starts flashing on the display for about 5 seconds.

3. Press Control Δ / ∇ to select a channel number while the channel number position is flashing.
 - Pressing Control Δ increases the number.
 - Pressing Control ∇ decreases the number.

Note:

You can use the 10 keys on the remote control to select the preset number. When using the 10 keys, be sure that they are activated for tuner, not for the CD and others. (See page 43.)

4. Press MEMORY (next to the TUNER button) again while the selected channel number is flashing on the display. The selected channel number stops flashing. The station is assigned to the selected channel number.

5. Repeat steps 1 to 4 until you store all the stations you want.

To cancel a stored preset station

Storing a new station on a used number erases the previously stored one.

To be continued to the next page

See also
page 38.



Assigning Names to Preset Stations

You can assign a name of up to five characters to each preset station (from preset channel number 1 to 20). When a preset station is tuned in, its assigned name will appear on the display.

On the front panel only:

1. Tune in a preset station (preset channel number 1 to 20).
See page 21 for details.

2. Press **MEMORY** (next to the **TUNER** button).
The preset channel number starts flashing.

Note:
If you press **Control Δ / ▽** while the preset channel number is flashing, you can change the preset channel number.

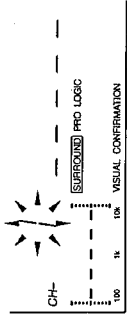

3. Press **Control ▷ (or ◁)** until the first character position starts flashing.

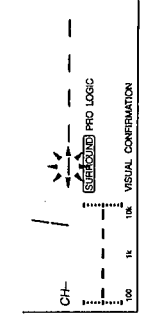

4. Press **Control Δ / ▽** to select a character.
You can use characters listed below.

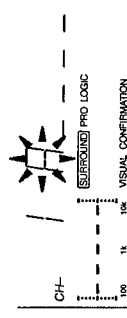

5. When a character you want appears, press **Control ▷ (or ◁)**.
The next (or previous) character position starts flashing.

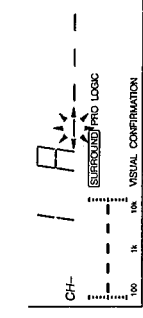

6. Repeat steps 4 and 5 to enter up to five characters.

7. Press **MEMORY** (next to the **TUNER** button) again while the last selected character is flashing after you have assigned a name.

To erase the input characters
Insert blanks using the same procedure described above.

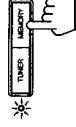
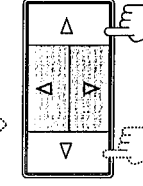
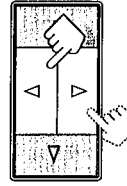
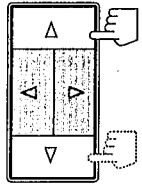
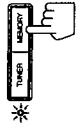
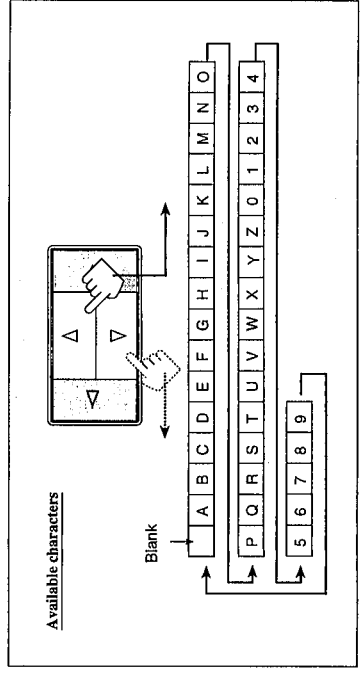

Front panel

CAUTION:
Preset stations may be erased when power is cut off to the receiver, as when it is unplugged from the AC outlet or a power failure occurs. If the preset stations are lost, simply set the stations again.

To tune in a preset station



1. Press **TUNER** so that the **Control Δ / ▽ / ◁ / ▷** buttons work for tuner settings.
The lamp next to the button lights up.

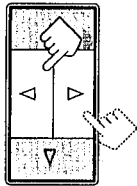

2. Press **Control Δ / ▽** until “-PRESET-” appears on the display.

3. Press **Control ◁ / ▷** to select a preset channel.

Each time you press the button, the preset channels change.

- Pressing **Control ◁** changes preset channels in decreasing order.
- Pressing **Control ▷** changes preset channels in increasing order.

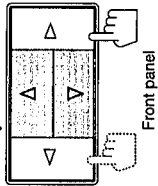

From the remote control:

1. Press **FM/AM**.
Each time you press the button, the band alternates between FM and AM.

2. Press 10 keys to select a preset channel number.

- For channel number 5, press 5.
- For channel number 15, press +10 then 5.
- For channel number 20, press +10 then 10.
- For channel number 30, press +10, +10, then 10.

Note:
When you use the 10 keys on the remote control, be sure that they are activated for tuner, not for the CD and others. (See page 43.)

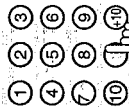

Remote Control

Selecting the FM Reception Mode

You can change the FM reception mode while listening an FM broadcast. You can also store the FM reception mode for each preset station. (See page 20.)

On the front panel:

1. Press **TUNER** so that the **Control Δ / ▽ / ◁ / ▷** buttons work for tuner settings.
The lamp next to the button lights up.
2. Press **Control Δ / ▽** until “FM MODE” appears on the display.
3. Press **Control ◁ / ▷** to select either “AUTO” or “MONO.”
 - Normally select “AUTO.”
 - When an FM stereo broadcast is hard to receive or noisy, select “MONO.”

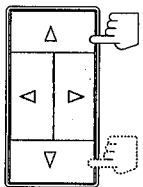
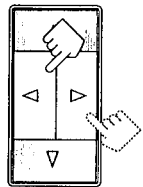
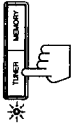

Front panel

From the remote control:

Press **FM MODE/MUTE**.

Each time you press the button, “AUTO” and “MONO” is alternately selected, and appears on the display.



Remote Control

Note:
When using the **FM MODE/MUTE** button, be sure that the 10 keys are activated for tuner, not for the CD and others. (See page 43.)

Using the SEA Modes

The SEA (Sound Effect Amplifier) modes give you control of the way your music sounds.

Note:
The SEA modes cannot be used for recording.



See also
page 38.

Selecting Your Favorite SEA Mode

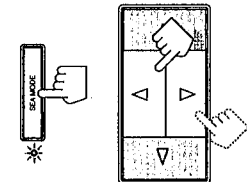

Front panel

1. Press SEA MODE so that the Control Δ / ∇ buttons work for selecting the SEA mode. The lamp next to the button lights up.
2. Press Control Δ / ∇ until the mode you want appears on the display. Each time you press the button, the SEA mode changes as follows:

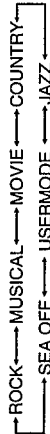

Note:
When the SEA mode is turned on, the SEA indicator lights up on the display.

ROCK:	Gives a heavy sound. Both high and low frequencies are boosted.
MUSICAL:	Enhance the mid-frequency range, which the human voice is mostly made up of.
MOVIE:	Adds breadth to sounds so you feel like you are in a movie theater.
COUNTRY:	Enhances the high-frequency range so that instruments such as the violin and banjo are emphasized.
JAZZ:	Gives a feeling of a live atmosphere. Good for acoustic music.
USERMODE:	Your original SEA adjustment (see page 24).
SEA OFF:	No SEA mode is applied (see below).

To cancel the SEA mode, press Control Δ / ∇ until "SEA OFF" appears in step 2 above. The SEA indicator goes off from the display.

From the remote control:

1. Press the SOUND CONTROL. Pressing this button activates the 10 keys for adjusting the sounds.
2. Press the SEA MODE button repeatedly until the SEA mode you want appears on the display. Each time you press the button, the SEA mode changes as follows:

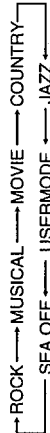

Note:
When the SEA mode is turned on, the SEA indicator lights up on the display.

To cancel the SEA mode, press SEA MODE until "SEA OFF" appears in step 2 above. The SEA indicator goes off from the display.



Remote Control

Creating Your Own SEA Mode

You can adjust and store your own SEA adjustment into memory (USERMODE).

On the front panel only:

If you do not want to store your adjustment, but rather want to adjust the SEA temporarily, skip step 3 below.

1. Press SEA ADJUST so that the Control Δ / ∇ / \leftarrow / \rightarrow buttons work for the SEA adjustment. The lamp next to the button lights up.
2. Adjust the SEA frequency and its level.
 - Press Control \leftarrow / \rightarrow to select the frequency range to adjust.
 - Press Control Δ / ∇ to adjust the level.

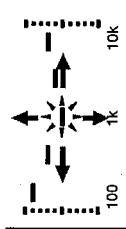

3. Press MEMORY (next to the SEA ADJUST button). Your adjustment is stored into USERMODE.

To recall your own SEA adjustment
See page 23.

To erase a stored adjustment

Storing a new adjustment into USERMODE erases the previously stored one.

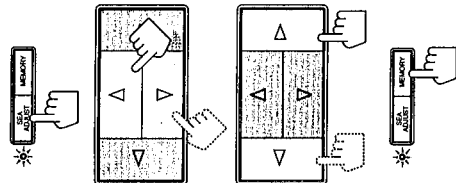

Front panel



Activating the Surround Sounds

The receiver can reproduce the sounds of the DVD player with its analog discrete output mode turned on. Moreover, the built-in digital surround processor provides two groups of programs — DAP (Digital Acoustic Processor) modes and surround modes (Dolby Surround and JVC Theater Surround).

You cannot use the DAP mode and surround mode at the same time. When you turn on the DAP mode, the surround mode is turned off (if it has been on), and vice versa.

- Notes:**
- The digital surround processor has no effect on monaural sources.
 - The digital surround processor cannot be used for recording.

On the DAP mode

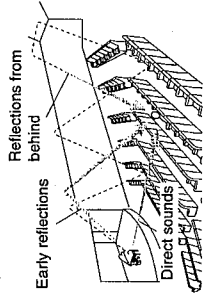

The sound heard in a concert hall or club consists of direct sound and indirect sound — early reflections and reflections from behind. Direct sounds reach the listener directly without any reflection. On the other hand, indirect sounds are delayed by the distances of the ceiling and walls. These direct sounds and indirect sounds are the most important elements of the acoustic surround effects. The DAP mode can create these important elements, and gives you a real "being there" feeling by using the front speakers and rear speakers.

On DVD multi playback mode

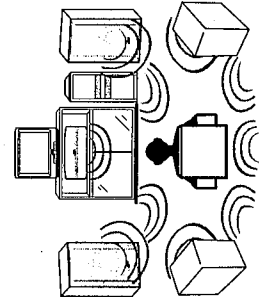

This receiver provides the DVD MULTI playback mode for reproducing the analog discrete output mode of the DVD player. The soundtracks of the movies are designed to sound best in movie theaters. This means they cannot be reproduced in a home environment as intended by movie-makers. With the introduction of the discrete multi-channel soundtracks of the DVD player, enables dynamic sound experiences of a movie theater in your home in the same way as intended by movie-makers.

To activate the DVD MULTI playback mode, you need to set the playing mode of the DVD player according to your speaker arrangement.

On surround mode

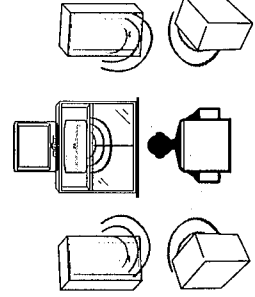

With this receiver, you can use two types of the surround mode.

Dolby Surround

Dolby Surround has been developed to reproduce the important elements of the acoustic surround at home.

To watch the soundtracks of video software bearing the mark * which includes the same encoded surround information as found in Dolby Stereo films, the receiver can provide you with 2 Dolby Surround modes (Dolby Pro Logic and Dolby 3ch Logic).

Dolby Pro Logic: Select this mode when optional center and rear speakers are connected.

Dolby 3ch Logic: Select this mode when a center speaker is connected without rear speakers.

JVC's Theater (1 and 2) Surround

In order to reproduce a more realistic sound field in your listening room while playing soundtracks of video software bearing the mark , JVC's Theater Surround has been designed to give you clearer vocals and to create a real "being there" feeling. The sound is reproduced through the front speakers, rear speakers, and center speaker.

* Manufactured under license from Dolby Laboratories Licensing Corporation. Additionally licensed under Canadian patent number 1,037,877. "Dolby", the double-D symbol, and "Pro Logic" are trademarks of Dolby Laboratories Licensing Corporation.

Using the DAP Modes

You can use five DAP modes — "Dance Club, Live Club, Hall, Pavilion, and Headphones". These modes (except "Headphones") require the front speakers and the rear speakers, but do not require a center speaker to enlarge the sound field.

Among the DAP modes, "Headphones" is very special. It can create the same stereo sound as you listen through the speakers off air while listening to a source using headphones. So, you can feel as if you were not using the headphones and listening to music in a room.

Note:
When you select "DVDMULTI" as the source to play, you cannot select the DAP mode.

On the front panel:

1. Press DAP/SURROUND MODE so that the Control Δ / ∇ / \triangleleft / \triangleright buttons work for selecting the DAP/surround modes.
The lamp next to the button lights up.
2. Press Control \triangleleft / \triangleright to select the DAP mode.
The DAP indicator lights up on the display.
Each time you press the button, the DAP and surround modes alternately comes into effect.
3. Press Control Δ / ∇ until the DAP mode you want appears on the display.
Each time you press the button, the DAP modes change as follows:



Dance CLUB	Gives a throbbing bass beat.
Live CLUB	Gives the feeling of a live music club with a low ceiling.
HALL	Gives clear vocal and the feeling of a concert hall.
PAVILION	Gives the spacious feeling of a pavilion with a high ceiling.
HeadPHONES*	Gives a spacious stereo effect when listening with headphones.
DAP OFF	No DAP mode is applied.

Note:
When you select "Headphones" (the #H-PHONE* indicator lights up), you cannot adjust the rear speaker output level in the following steps.

4. Press DAP/SURROUND/DVD MULTI ADJUST so that the Control Δ / ∇ / \triangleleft / \triangleright buttons work for adjusting the selected mode.
The lamp next to the button lights up.

5. Press Control Δ / ∇ until "REAR +" appears on the display.

6. Press Control \triangleleft / \triangleright to adjust the rear speaker output level.
 - Pressing Control \triangleleft decreases the output level up to -10 dB.
 - Pressing Control \triangleright increases the output level up to +10 dB.

Note:
You cannot adjust the left and right rear speaker output level separately.

7. Press Control Δ / ∇ until "EFFECT+" appears on the display.

8. Press Control \triangleleft / \triangleright to adjust the effect level.
Each time you press the button, the effect level changes as follows:

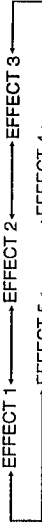

As the number increases, the selected DAP mode becomes stronger.

Note:
When you select "Headphones" (the #H-PHONE* indicator lights up), you cannot select "EFFECT 5."

To cancel the DAP mode, press Control Δ / ∇ until "DAP OFF" appears in step 3 above.
The DAP indicator goes off from the display.

See also
page 38.



Using the DVD MULTI Playback Mode

This receiver provides the DVD MULTI playback mode for reproducing the analog discrete output mode of the DVD player.
Before playing back a DVD, refer also to the manual supplied with the DVD player.

Speaker arrangements for DVD MULTI playback

The following illustrations show how to obtain the optimum sound environment for the DVD MULTI playback mode. Try to find the speaker direction and location to create the optimum sound field.

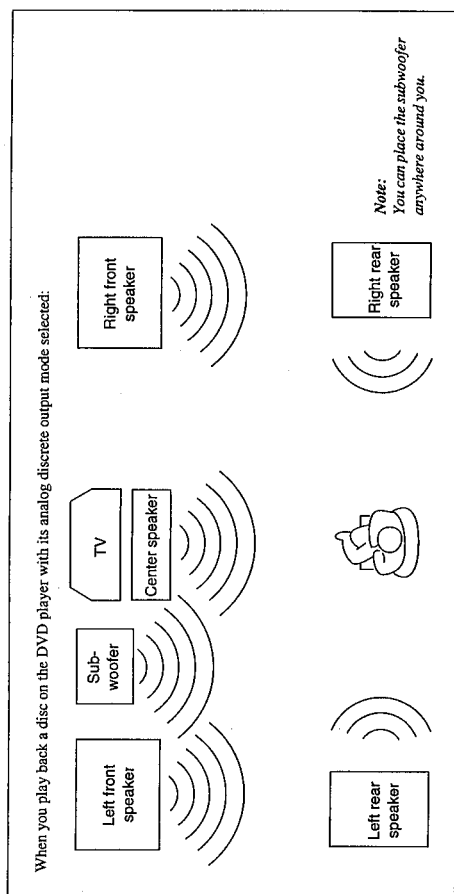

Activating the DVD MULTI playback

You can adjust the DVD MULTI playback mode while playing back a DVD using the analog discrete output mode on the DVD player.
Once you made adjustments, the receiver memorizes the adjustments until you change them. You also need to set the DVD player to the analog discrete output mode.

Note:
When you select "DVMULTI" as the source to play, the DAP and surround modes are canceled temporarily.

On the front panel:

1. Press DVD MULTI so that "DVMULTI" appears on the display.
The lamp above the button and the DVD lamp (of the source lamps) light up.
2. Select the analog discrete output mode on the DVD player, and start playing a DVD.
Refer to the manual supplied with the DVD player.

If you want to make any adjustment, go to the following steps.

3. Press DAP/SURROUND/DVD MULTI ADJUST so that the Control Δ / ▽ / ◀ / ▶ buttons work for adjusting the DVD MULTI playback mode.
The lamp next to the button lights up.
4. Press Control Δ / ▽ until "-CENTER+" appears on the display.

To be continued to the next page

From the remote control:

1. Press SOUND CONTROL.

The remote control is activated for sound adjustments.



2. Press DAP MODE until the DAP mode you want appears on the display.

The DAP indicator also lights up on the display.

Each time you press the button, the DAP modes change as follows:



Note:

When you select "Headphones" (the #PHONE* indicator lights up), you cannot adjust the rear speaker output level in the following steps.

3. Press REAR(L) +/- to adjust the rear speaker output level.

- Pressing REAR(L) - decreases the output level up to -10 dB.
- Pressing REAR(L) + increases the output level up to +10 dB.



Note:

You cannot adjust the left and right rear speaker output level separately.

4. Press EFFECT to adjust the effect level.

Each time you press the button, the effect level changes as follows:



Remote Control



Remote Control

Note:

When you select "Headphones" (the #PHONE* indicator lights up), you cannot select "EFFECT 5."

To cancel the DAP mode, press DAP MODE until "DAP OFF" appears in step 2 above.

The DAP indicator goes off from the display.

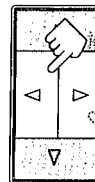
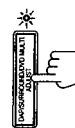

Front panel

See also
page 39.



Using the Surround Modes

With this receiver, you can use two types of the surround mode — Dolby Surround and JVC Theater Surround

Speaker arrangements for surround mode

The following illustrations show how to obtain the optimum sound environment for surround modes. Try to find the speaker direction and location to create the optimum sound field.

CASE 1 When you have added a center speaker and rear speakers

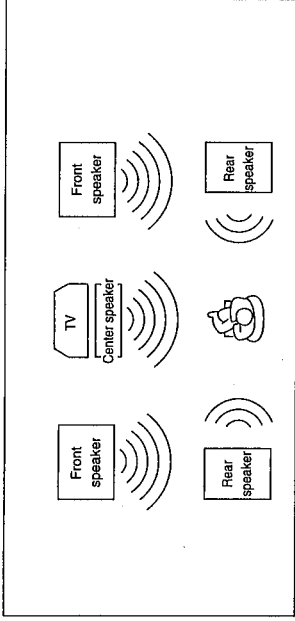

In this case:

1. Select "PROLOGIC," "THEATER1" or "THEATER2."
2. Select "NORMAL" or "WIDE" for center mode.

See pages 31 to 34 for more details.

CASE 2 When you have added rear speakers (without a center speaker)

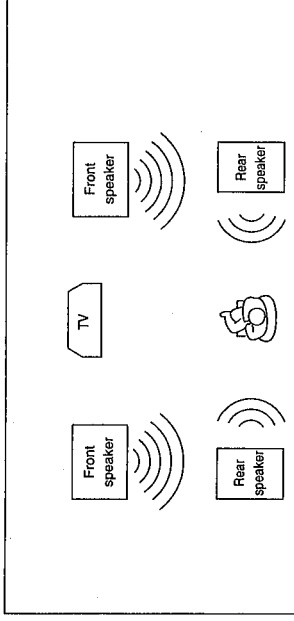

In this case:

1. Select "PROLOGIC," "THEATER1" or "THEATER2."
2. Select "PHANTOM" for center mode.

See pages 31 to 34 for more details.

CASE 3 When you have added a center speaker (without rear speakers)

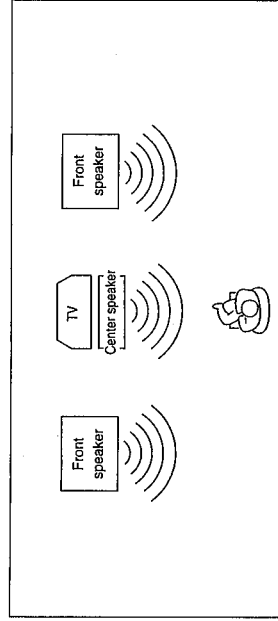

In this case:

1. Select "3CHLOGIC."
2. Select "NORMAL" or "WIDE" for center mode.

See pages 31 to 34 for more details.

5. Press Control \triangle/\triangleright to adjust the center speaker output level.
 - Pressing Control \triangle decreases the output level up to -10 dB.
 - Pressing Control \triangleright increases the output level up to +10 dB.
6. Press Control \triangle/∇ until "REAR L+" appears on the display.
7. Press Control \triangle/\triangleright to adjust the left rear speaker output level.
 - Pressing Control \triangle decreases the output level up to -10 dB.
 - Pressing Control \triangleright increases the output level up to +10 dB.
8. Press Control \triangle/∇ until "REAR R+" appears on the display.
9. Press Control \triangle/\triangleright to adjust the right rear speaker output level.
 - Pressing Control \triangle decreases the output level up to -10 dB.
 - Pressing Control \triangleright increases the output level up to +10 dB.

10. Press Control \triangle/∇ until "CNT TONE" (Center Tone) appears on the display.

11. Press Control \triangle/\triangleright to select the center tone you want.
The center tone adjustment affects the mid-frequency range, which the human voice is mostly made up of.

Each time you press the button, the display changes to show the following:

SOFT2 \longleftrightarrow SOFT1 \longleftrightarrow FLAT \longleftrightarrow SHARP1 \longleftrightarrow SHARP2

To make the dialogue clearer, select "SHARP1" (little) or "SHARP2" (much).
To make the dialogue softer, select "SOFT1" (little) or "SOFT2" (much).
When "FLAT" is selected, no adjustment is applied.

From the remote control:

Note:

If you want to use the remote control for adjusting the center tone, use the menu function (see page 38).

1. Press DVD MULTI so that "DYDMULTI" appears on the display.
The DVD MULTI lamp lights up and the DVD lamp (of the source lamps) lights up.
2. Select the analog discrete output mode on the DVD player, and start playing a DVD.
Refer to the manual supplied with the DVD player.

If you want to make any adjustment, go to the following steps.

3. Press SOUND CONTROL.
The remote control is activated for adjusting the sound.
4. Press CNTR +/- to adjust the center speaker output level.
 - Pressing CENTER - decreases the output level up to -10 dB.
 - Pressing CENTER + increases the output level up to +10 dB.
5. Press REAR-(L) +/- to adjust the left rear speaker output level.
 - Pressing REAR-(L) - decreases the output level up to -10 dB.
 - Pressing REAR-(L) + increases the output level up to +10 dB.
6. Press (REAR-R) +/- to adjust the right rear speaker output level.
 - Pressing (REAR-R) - decreases the output level up to -10 dB.
 - Pressing (REAR-R) + increases the output level up to +10 dB.

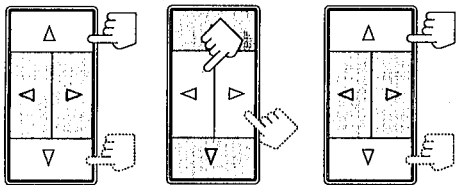

Front panel



Remote Control

Preparing for the surround mode

Once you have set the surround modes, you can use the same adjustment every time you want to activate the surround you want. The receiver memorizes surround adjustments for each mode.

Notes:

When you select "DVMULTI" as the source to play, you cannot select or adjust the surround mode.

On the front panel:

1. Press DAP/SURROUND MODE so that the Control Δ / ∇ / \triangleleft / \triangleright buttons work for selecting the DAP/surround modes. The lamp next to the button lights up.
2. Press Control \triangleleft / \triangleright to select the surround mode. Each time you press the button, the DAP and surround modes alternately come into effect.
3. Press Control Δ / ∇ until the surround mode you want appears on the display. Each time you press the button, the surround modes change as follows (the indicator of the selected surround mode also lights up on the display):

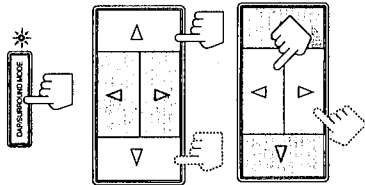

Front panel

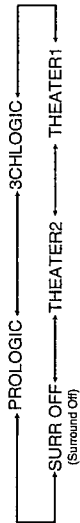

PROLOGIC	Select this mode to watch a video source with Dolby Surround when you have connected the rear speakers (and a center speaker).
3CHLOGIC	Select this mode to watch a video source with Dolby Surround when you have connected a center speaker and no rear speakers.
THEATER1	Select this mode to watch a video source with Dolby Surround when you have connected the rear speakers (and a center speaker). This mode gives you the feeling of a small movie theater with a seating capacity of 100.
THEATER2	Select this mode to watch a video source with Dolby Surround when you have connected the rear speakers (and a center speaker). This mode gives you the feeling of a large movie theater with a seating capacity of 1000.
SURR OFF	No surround mode is applied.

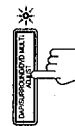

4. Press DAP/SURROUND/DVD MULTI ADJUST so that the Control Δ / ∇ / \triangleleft / \triangleright buttons work for adjusting the surround mode. The lamp next to the button lights up.

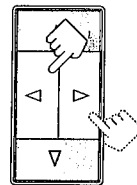
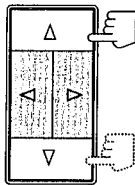
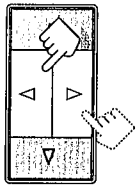
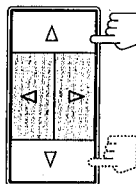
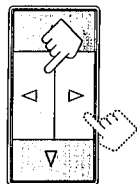

Front panel

5. Press Control Δ / ∇ until "CNT MODE" (Center Mode) appears on the display.

Press Control \triangleleft / \triangleright to select the center mode. Each time you press the button, the center modes change as follows:

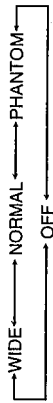

WIDE	Select this mode when the center speaker can reproduce the bass better than the front speakers. All signals of the center channel are output through the center speaker.
NORMAL	Select this mode when the center speaker cannot reproduce the bass better than the front speakers. The bass portions of the center channel signals are output through the front speakers.
PHANTOM	Select this mode when you do not use a center speaker. The center speaker channel signals are output through the front speakers.
OFF	Select this mode to turn off the center speaker channel.

Notes:

- If you have already set the "center speaker size" following the procedure described on page 17, you do not have to select the center mode in this procedure.
- When you have selected "3CHLOGIC," you cannot select "PHANTOM."

7. Press Control Δ / ∇ until "-DELAY +" appears on the display.
8. Press Control \triangleleft / \triangleright to adjust the delay time of the rear speaker output. Each time you press the button, the delay time changes as follows:



DELAY 1	Select this when the distance from you to your rear speakers is greater than that to the front speakers.
DELAY 2	Select this when the distance from you to your rear speakers is almost equal to that to the front speakers.
DELAY 3	Select this when the distance from you to your rear speakers is a little less than that to the front speakers.
DELAY 4	Select this when the distance from you to your rear speakers is much less than that to the front speakers.

Note: When you have selected "3CHLOGIC," you cannot adjust the delay time.

9. Press Control Δ / ∇ until "TEST" appears on the display, then press Control \triangleleft / \triangleright to start checking the speaker output balance. "TEST" starts flashing on the display, and a test tone comes out of the speakers in the following order:

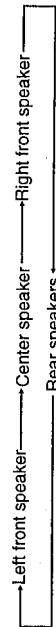

Notes:

- No test tone comes out of the rear speakers when you have selected "3CHLOGIC."
- No test tone comes out of the center speaker when you select "PHANTOM" or "OFF" for the center mode.

To be continued to the next page

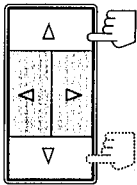
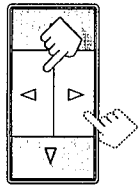

Front panel

10. If necessary, adjust the speaker output level as follows:
- To adjust the rear speaker output level, press Control Δ / ∇ until "- REAR +" appears on the display, then press Control $\triangleleft / \triangleright$.
 - To adjust the center speaker output level, press Control Δ / ∇ until "- CENTER +" appears on the display, then press Control $\triangleleft / \triangleright$.

Notes:

- You cannot adjust the left and right rear speaker output level separately.
- You cannot adjust the rear speaker output level when you have selected "3CHLOGIC."
- You cannot adjust the center speaker output level when you select "PHANTOM" or "OFF" for the center mode.

11. Press Control Δ / ∇ until "TEST" appears on the display, then press Control $\triangleleft / \triangleright$ to stop the test tone.

12. Press Control Δ / ∇ until "CNT TONE" (Center Tone) appears on the display.

13. Press Control $\triangleleft / \triangleright$ to select the center tone you want.
The center tone adjustment affects the mid-frequency range, which the human voice is mostly made up of.
Each time you press the button, the display changes to show the following:

SOFT2 \longleftrightarrow SOFT1 \longleftrightarrow FLAT \longleftrightarrow SHARP1 \longleftrightarrow SHARP2

To make the dialogue clearer, select "SHARP1" (little) or "SHARP2" (much).
To make the dialogue softer, select "SOFT1" (little) or "SOFT2" (much).
When "FLAT" is selected, no adjustment is applied.

Note:
The center tone cannot be adjusted when sounds do not come out of the center speaker.
If you have selected the JVC Theater Surround, go to the following steps.

14. Press Control Δ / ∇ until "-EFFECT+" appears on the display.

Each time you press the button, the effect level changes as follows:

EFFECT 1 \longleftrightarrow EFFECT 2 \longleftrightarrow EFFECT 3 \longleftrightarrow
EFFECT 4 \longleftrightarrow EFFECT 5

As the number increases, the surround mode becomes stronger.

Note:
When you have selected Dolby Surround, you cannot select the effect level.

From the remote control:

Note:
If you want to use the remote control for adjusting the center mode and the center tone, use the menu function (see page 39).

1. Press SOUND CONTROL.

The remote control is activated for adjusting the sound.

2. Press SURR MODE until the surround mode you want appears on the display.
The SURROUND indicator also lights up on the display.
Each time you press the button, the surround modes change as follows (the indicator of the selected surround mode also lights up on the display):

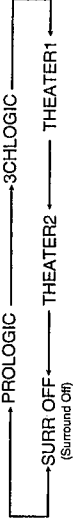

3. Press DELAY to adjust the delay time of the rear speaker output.
Each time you press the button, the delay time changes as follows:



Note:
When you have selected "3CHLOGIC," you cannot adjust the delay time.

4. Press TEST to start checking the speaker output balance.
"TEST" starts flashing on the display, and a test tone comes out of the speakers in the following order:



Notes:

- No test tone comes out of the rear speakers when you have selected "3CHLOGIC."
- No test tone comes out of the center speaker when you select "PHANTOM" or "OFF" for the center mode.

5. If necessary, adjust the speaker output level as follows:

- To adjust the rear speaker output level, press REAR(L) +/-.
- To adjust the center speaker output level, press CNTR +/-.

Pressing - decreases the output level up to -10 dB.
Pressing + increases the output level up to +10 dB.

Notes:

- You cannot adjust the left and right rear speaker output level separately.
- You cannot adjust the rear speaker output level when you have selected "3CHLOGIC."
- You cannot adjust the center speaker output level when you select "PHANTOM" or "OFF" for the center mode.

6. Press TEST again to stop the test tone.

If you have selected the JVC Theater Surround, go to the following steps.

7. Press EFFECT to adjust the effect level.

Each time you press the button, the effect level changes as follows:



As the number increases, the surround mode becomes stronger.

Note:
When you have selected Dolby Surround, you cannot select the effect level.

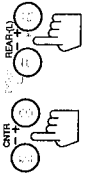

Remote Control

Activating the surround modes

Once you have set the surround modes, you can use the same adjustment every time you want to enjoy the surround you want. The receiver memorizes surround adjustments for each mode.

Note:
When you select "DYNAMIC" as the source to play, the surround mode is canceled temporarily.

On the front panel:

1. Press DAP/SURROUND MODE so that the Control Δ / ∇ / \triangleleft / \triangleright buttons work for selecting the DAP/surround modes.
The lamp next to the button lights up.
2. Press Control \triangleleft / \triangleright to select the surround mode.
The SURROUND indicator lights up on the display.
Each time you press the button, the DAP and surround modes alternately come into effect.
3. Press Control Δ / ∇ until the surround mode you want appears on the display.
Each time you press the button, the surround modes change as follows (the indicator of the selected surround mode also lights up on the display):
4. Select and play a sound source which was processed with Dolby Surround and is labeled with mark.

To cancel the surround mode, press Control Δ / ∇ until "SURR OFF" appears in step 3 above.
The SURROUND indicator and the indicator of the selected surround mode goes off from the display.

From the remote control:

1. Press SOUND CONTROL.
The remote control is activated for adjusting the sound.
2. Press SURR MODE until the surround mode you want appears on the display.
The SURROUND indicator also lights up on the display.
Each time you press the button, the surround modes change as follows (the indicator of the selected surround mode also lights up on the display):
3. Select and play a sound source which was processed with Dolby Surround and is labeled with mark.

To cancel the surround mode, press SURR MODE until "SURR OFF" appears in step 2 above.
The SURROUND indicator and the indicator of the selected surround mode goes off from the display.

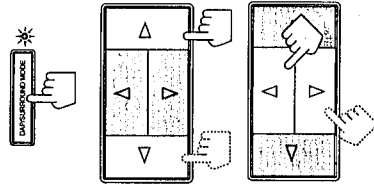

Front panel



Remote Control

Using the On-Screen Display to Control the Receiver

You can use the menu function on the TV screen to control the receiver.
To use this function, you need to connect the TV to the MONITOR OUT jack on the rear panel (see page 9), and set the TV's input mode to the appropriate position to which the receiver is connected.
When the TV's input mode is for TV, you cannot see the on-screen display.

IMPORTANT:

When you use the menu functions, make sure that you have connected a TV and operate the menu function while watching the on-screen displays on the TV.

Basic Procedures

From the remote control:

1. Press MENU.
The MAIN MENU appears on the TV screen.
If you press Δ / ∇ / \triangleleft / \triangleright , a sub-menu you can adjust at that time appears on the TV screen instead of the MAIN MENU.
2. Press Δ / ∇ to move \square to the sub-menu you want to set, then press \triangleleft / \triangleright .
The sub-menu you want appears.
3. If necessary, press Δ / ∇ / \triangleleft / \triangleright to set or adjust the item you want on the selected sub-menu.
When a item is selected, the item will be highlighted.

Note:

Moving \square to an item does not mean that you have selected it. If the item is not highlighted, press \triangleleft / \triangleright to highlight it.

4. When you finish, press MENU EXIT.
The menu disappears from the TV.

To go back to the MAIN MENU any time during the process Press MENU again.

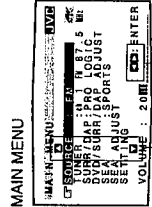
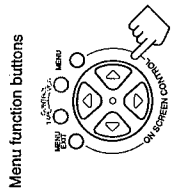

Shows the buttons you can use on the current menu. In this case, press Δ / ∇ to move \square up and down, and \triangleleft / \triangleright to select the item.

Selecting the Source to Play (Also see page 12)

1. Press MENU.
The MAIN MENU appears on the TV.
2. Press Δ / ∇ to move \square to "SOURCE," then press \triangleleft / \triangleright .
The SOURCE menu appears.
3. Press Δ / ∇ to move \square to the source you want to play.
To select the DVD MULTI playback mode, press \triangleleft / \triangleright while "DVD" is selected as the source.
4. When you finish, press MENU EXIT.
The menu disappears from the TV.

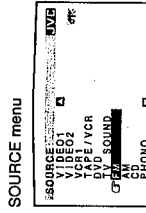

Adjusting the Front Speaker Output Balance (Also see page 15)

1. Press MENU.
The MAIN MENU appears on the TV.
2. Press Δ / ∇ to move \square to "SETTING," then press \triangleleft / \triangleright .
The SETTING menu appears.
3. Press Δ / ∇ to move \square to "BAL." (Balance).
4. Press \triangleleft / \triangleright repeatedly to adjust the balance.
5. When you finish, press MENU EXIT.
The menu disappears from the TV.

SETTING menu

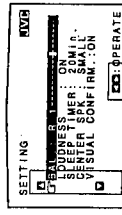

Shows the buttons you can use on the current menu.
In this case, press Δ / ∇ to move \square up and down, and \triangleleft / \triangleright to adjust or set the item.

Listening at Low Volume (Loudness) (Also see page 15)

1. Press MENU.
The MAIN MENU appears on the TV.
2. Press Δ/∇ to move \square to "SETTING," then press $\triangleleft/\triangleright$.
The SETTING menu appears.
3. Press Δ/∇ to move \square to "LOUDNESS."
4. Press $\triangleleft/\triangleright$ to set the loudness function to "ON" or "OFF."
5. When you finish, press MENU EXIT.
The menu disappears from the TV.

SETTING menu



Using the Sleep Timer (Also see page 16)

1. Press MENU.
The MAIN MENU appears on the TV.
2. Press Δ/∇ to move \square to "SETTING," then press $\triangleleft/\triangleright$.
The SETTING menu appears.
3. Press Δ/∇ to move \square to "SLEEP TIMER."
4. Press $\triangleleft/\triangleright$ to set the shut-off time.
5. When you finish, press MENU EXIT.
The menu disappears from the TV.

SETTING menu

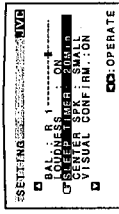

Selecting the Center Speaker Size (Also see page 17)

Note: When the surround mode is off, you cannot select the center speaker size.

1. Press MENU.
The MAIN MENU appears on the TV.
2. Press Δ/∇ to move \square to "SETTING," then press $\triangleleft/\triangleright$.
The SETTING menu appears.
3. Press Δ/∇ to move \square to "CENTER SPK" (Center Speaker).
4. Press $\triangleleft/\triangleright$ repeatedly until the appropriate center speaker size is selected.
5. When you finish, press MENU EXIT.
The menu disappears from the TV.

SETTING menu

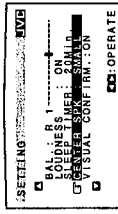

Using Visual Confirmation (Also see page 18)

1. Press MENU.
The MAIN MENU appears on the TV.
2. Press Δ/∇ to move \square to "SETTING," then press $\triangleleft/\triangleright$.
The SETTING menu appears.
3. Press Δ/∇ to move \square to "VISUAL CONFIRM." (Visual Confirmation).
4. Press $\triangleleft/\triangleright$ to set Visual Confirmation to "ON" or "OFF."
5. When you finish, press MENU EXIT.
The menu disappears from the TV.

SETTING menu

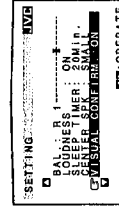

Operating the Tuner

1. Press MENU.
The MAIN MENU appears on the TV.
2. Press Δ/∇ to move \square to "TUNER," then press $\triangleleft/\triangleright$.
The TUNER menu appears.
3. Press Δ/∇ to move \square to the item you want to set or adjust, then press $\triangleleft/\triangleright$.
On the TUNER menu, you can do the following:
"CH.": Select a preset channel station. (See page 21)
If you want to assign a name to a preset channel, see page 22.
"BAND": Select the band. (See page 20)
"TUNING": Tune in a station manually. (See page 20)
"FM MODE": Select the FM reception mode. (See page 21)
4. When you finish, press MENU EXIT.
The menu disappears from the TV.

TUNER menu

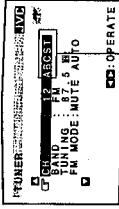

If you have assigned the name to this preset station, it appears here.

Selecting Your Favorite SEA Mode (Also see page 23)

1. Press MENU.
The MAIN MENU appears on the TV.
2. Press Δ/∇ to move \square to "SEA," then press $\triangleleft/\triangleright$.
The SEA MODE menu appears.
3. Press Δ/∇ to move \square to the SEA mode you want.
4. When you finish, press MENU EXIT.
The menu disappears from the TV.

SEA MODE menu



Creating Your Own SEA Mode (Also see page 24)

1. Press MENU.
The MAIN MENU appears on the TV.
2. Press Δ/∇ to move \square to "SEA ADJUST," then press $\triangleleft/\triangleright$.
The SEA ADJUST menu appears.
3. Press Δ/∇ or $\triangleleft/\triangleright$ to adjust the SEA mode as you want.
 $\triangleleft/\triangleright$: Select the frequency ranges.
 Δ/∇ : Adjust the frequency levels.
4. Press MEMORY (next to the SEA ADJUST button).
5. When you finish, press MENU EXIT.
The menu disappears from the TV.

SEA ADJUST menu

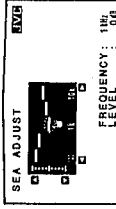

Adjusting the DVD MULTI Playback Mode (Also see page 28)

Before adjusting the DVD MULTI playback mode, you have to select "DYD/MULTI" as the source to play.

1. Press MENU.
The MAIN MENU appears on the TV.
2. Press Δ/∇ to move \square to "DYD/SURR/DAP ADJUST," then press $\triangleleft/\triangleright$.
The DVD MULTI menu appears.
3. Press Δ/∇ to move \square to the item you want to set or adjust, then press $\triangleleft/\triangleright$.
On the DVD MULTI adjustment menu, you can do the following:
"CENTER": Adjust the center speaker output level.
"REAR L": Adjust the left rear speaker output level.
"REAR R": Adjust the right rear speaker output level.
"CENTER TONE": Select the center tone.
4. When you finish, press MENU EXIT.
The menu disappears from the TV.

DVD MULTI adjustment menu

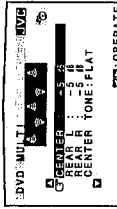

AV COMPU LINK Remote Control System

The AV COMPU LINK remote control system allows you to operate JVC video components (TV, VCR, and DVD player) through the receiver.

CONNECTIONS:

To use this remote control system, you need to connect the video components you want to operate, following the procedures below.

CAUTION:
The AV COMPU LINK remote control system cannot control the video components connected to the VIDEO1, VIDEO2, and TAPE/VCR jacks on the receiver. Use only VCR1 jacks for the VCR and the DVD jacks for the DVD player.

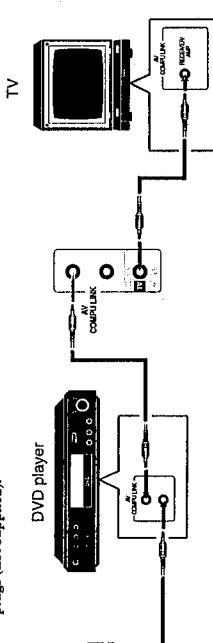
1. Connect your VCR, DVD player, and TV as follows, using the cables with the monaural mini-plugs (not supplied).
 
2. Connect the audio input/output jacks of the VCR, DVD player, and TV as follows using the cables with RCA pin plug. See page 9.
3. Connect the video input/output jack of the VCR, DVD player, and TV as follows.

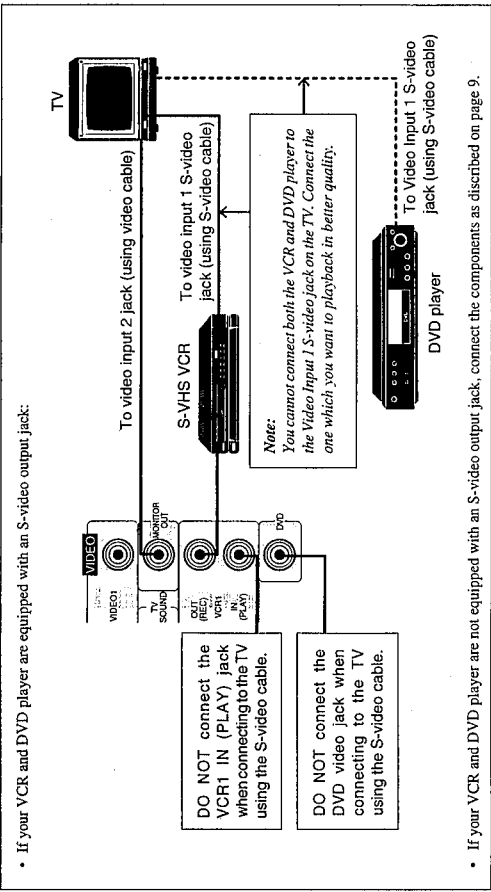

4. When turning on the TV for the first time after the AV COMPU LINK connection, turn the TV volume to the minimum using the TV volume control on the TV.

FUNCTIONS:

This remote control system allows you to use five functions listed below.

Note:
Refer also to the manuals supplied with your video components.

- **Remote Control of the TV through the Remote Sensor on the Receiver**
You can control the TV through the remote sensor on the receiver using this remote control. For details, see page 45.

Note:
Aim the remote control directly at the remote sensor on the receiver when operating the TV. (However, to operate the VCR or DVD player, always aim the remote control directly at the remote sensor on the VCR or on the DVD player.)

- **One-Touch Video Play**
Simply by inserting a video cassette without its safety tab into the VCR, you can enjoy the video playback without setting other switches manually.
The receiver automatically turns on and changes the source to the VCR.
The TV automatically turns on and changes the input mode to the position you can view the VCR playback.
When you insert a video cassette with its safety tab, press the play (▶) button on the VCR or on the remote control. So, you can get the same result.

Note:
When you connect an S-VHS VCR or the DVD player as described on page 41, you cannot see the on-screen displays (such as Visual Confirmation and Menus) since the AV COMPU LINK Remote Control System automatically changes the TV input mode to "Video input 1" when you operate the S-VHS VCR or the DVD player.
If you do not mind stopping watching the picture, you can then show the on-screen displays after changing the TV input mode to the position (Video input 2) the receiver is connected to.

- **One-Touch DVD Play**
Simply by starting playback on the DVD player, you can enjoy the DVD playback without setting other switches manually.
The receiver automatically turns on and changes the source to "DVD" or "DVMULTI" — DVD playback mode is automatically selected when a disc played in stereo or the audio output setting of the DVD player is mixed to two front channels, while DVD MULTI playback mode is automatically selected when a disc played back using the analog discrete output mode on the DVD player.
The TV automatically turns on and changes the input mode to the position so that you can view the playback picture.

- **Automatic Selection of TV's Input Mode**
 - When you select "TV SOUND" as the source to play on the receiver, the TV automatically changes the input mode to the TV tuner so that you can watch TV.
 - When you select "VIDEO1," "VIDEO2," or "TAPE/VCR" as the source to play on the receiver, the TV automatically changes the input mode to the Video Input 2 so that you can watch the playback picture.
 - When you select "DVD," "DVMULTI," or "VCR1" as the source to play on the receiver, the TV automatically changes the input mode to the correct position (either Video Input 1 or 2) so that you can watch the playback picture.

Note:
When you select "TV SOUND" as the source on the receiver, you cannot see the on-screen displays (such as Visual Confirmation and the menu function) since the AV COMPU LINK remote control system automatically changes the TV input mode to the TV tuner.
If you do not mind stopping listening to the TV sounds, you can then show the on-screen displays after changing the TV input mode to the position (Video input 2) the receiver is connected to.

- **Automatic Power On/Off**
The TV, VCR1 (the VCR connected to the VCR1 jacks), and DVD player turn on and off along with the receiver.
When you turn on the receiver:
 - If the previously selected source is "VCR1", the TV and VCR1 will turn on automatically.
 - If the previously selected source is "VIDEO1," "VIDEO2," or "TV SOUND," only the TV will turn on automatically.
 - If the previously selected source is "DVD" or "DVMULTI," the TV and DVD player will turn on automatically.
 When you turn off the receiver, the TV, VCR1 and DVD player will turn off.

Note:
If you turn off the receiver while recording on the VCR, the VCR will not turn off, but continue recording.

Using the Remote Control for Operating JVC's Audio/Video Components

You can operate JVC's audio and video components with this receiver's remote control, since control signals for VCR components are present in the remote control.

Notes:

- If you use the buttons on the front panel or the menu function to choose a source, the remote control will not operate that source. To operate a source with the remote control, the source must be selected using buttons on the remote control.
- Check to see if its remote control mode selector is set to the correct position. To operate audio system, TVs, and VCRs, set it to the "AUDIO/TV/VCR" position.
- Refer also to the manuals supplied with your components.

IMPORTANT:

- To operate JVC's audio components using this remote control:
- You need to connect JVC audio components through the COMPU LINK-3 (SYNCHRO) jacks (see page 40) in addition to the connections using cables with RCA pin plugs (see page 8).
 - Aim the remote control directly at the remote sensor on the receiver.

Tuner

After pressing FM/AM (with the remote control mode selector set to the "AUDIO/TV/VCR" position), you can perform the following operations:

- FM/AM:** Alternates between FM and AM.
1 — 10, +10: Selects a preset channel number directly.
 For channel number 5, press 5. For channel number 15, press +10, then 5. For channel number 20, press +10, then 10.
- FM MODE/MUTE:** Changes the FM reception mode.

Sound control section (Amplifier)

After pressing SOUND CONTROL (with the remote control mode selector set to the "AUDIO/TV/VCR" position), you can perform the following operations:

- SEA MODE:** Changes the SEA modes.
DAP MODE: Changes the DAP modes.
SURR MODE: Changes the surround modes.
CNTR +/-: Changes the center speaker output level for the DVD MULTI playback and surround modes.
REAR-(L) +/-: Changes the left/right rear speaker output level for DAP and surround modes.
(REAR-R) +/-: Changes the right rear speaker output level for the DVD MULTI playback mode.
EFFECT: Changes the effect level for DAP and surround modes.
DELAY: Changes the delay time for surround modes.
TEST: Checks the speaker output level for surround modes.

Note:

After adjusting sounds, press the corresponding source selecting button (FM/AM, CD, CD DISC, VCR1, DVD, DVD MULTI or TV SOUND) to operate your target source by using 10 keys; otherwise, 10 keys cannot be used for operating your target source.

CD player

After pressing CD (with the remote control mode selector set to the "AUDIO/TV/VCR" position), you can perform the following operations on a CD player:

- PLAY:** Starts playing.
◀▶: Returns to the beginning of the current (or previous) track.
▶▶: Skips to the beginning of the next track.
STOP: Stops playing.
PAUSE: Pauses playing. To release it, press PLAY.
1 — 10, +10: Selects a track number directly.
 To select track number 5, press 5. For track number 15, press +10, then 5. For track number 20, press +10, then 10. For track number 30, press +10, +10, then 10.

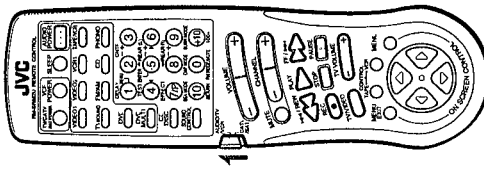

CD player-changer

After pressing CD DISC (with the remote control mode selector set to the "AUDIO/TV/VCR" position), you can perform the following operations on a CD player-changer:

- PLAY:** Starts playing.
◀▶: Returns to the beginning of the current (or previous) track.
▶▶: Skips to the beginning of the next track.
STOP: Stops playing.
PAUSE: Pauses playing. To release it, press the PLAY button.
1 — 6, 7/P: Select the number of a disc installed in a CD player-changer.

Turntable

After pressing PHONO (with the remote control mode selector set to the "AUDIO/TV/VCR" position), you can perform the following operations on a turntable:

- PLAY:** Starts playing.
STOP: Stops playing.

Cassette deck

After pressing TAPE/VCR or TAPE CONTROL (with the remote control mode selector set to the "AUDIO/TV/VCR" position), you can perform the following operations on a cassette deck:

- PLAY:** Starts playing.
REW: First rewinds the tape from right to left.
FF: First rewinds the tape from left to right.
STOP: Stops operations.
PAUSE: Pauses playing or recording temporarily. To release it, press the PLAY button.
REC ●: Press this button with the PLAY button to start recording.
 Press this button with the PAUSE button to enter recording pause (standby).

Notes:

You can use either the TAPE/VCR button or the TAPE CONTROL button to activate the buttons listed above. If you press TAPE/VCR, the playing source also changes to "TAPE/VCR." On the other hand, if you press TAPE CONTROL, the playing source does not change to "TAPE/VCR."

IMPORTANT:

- To operate JVC's video components using this remote control:
 - You need to connect JVC video components through the AV COMPU LINK jacks (see page 41) in addition to the connections using cables with RCA pin plugs (see pages 9 and 41).
 - When operating the VCR, aim the remote control directly at the remote sensor on the VCR.
 - When operating the DVD player, aim the remote control directly at the remote sensor on the DVD player.
 - When operating the TV, aim the remote control directly at the remote sensor on the receiver.

VCR

After pressing VCR1 or VCR CONTROL (with the remote control mode selector set to the "AUDIO/TV/VCR" position), you can perform the following operations on the VCR:

- PLAY:** Starts playing.
REW: Rewinds a tape.
FF: Fast winds a tape.
STOP: Stops operations.
PAUSE: Pauses playing or recording temporarily. To release it, press the PLAY button.
REC ●: Press this button with the PLAY button to start recording.
 Press this button with the PAUSE button to enter recording pause (standby).
 Changes the channels on the VCR.
CHANNEL +/-: Selects the channels on the VCR.

Notes:

- You can use either the VCR1 button or the VCR CONTROL button to activate the buttons listed above. If you press VCR1, the playing source also changes to "VCR1." On the other hand, if you press VCR CONTROL, the playing source does not change to "VCR1."
- You can also turn the VCR on and off by pressing VCR POWER on the remote control.

Operating Other Manufacturers' VCR, TV, CATV Converter, and Satellite Tuners

This remote control supplied with the receiver can transmit control signals for other manufacturers' VCRs, TVs and CATV converters. By changing the transmittable signals from preset ones to the other manufacturers', you can operate the other manufacturer's components using this remote control.

When operating the other manufacturers' components, refer also to the manuals supplied with them. To operate these components with the remote control, first you need to set the manufacturer's code each for VCR, TV, CATV converters, and satellite tuner.

IMPORTANT

When using the Remote Control, check to see if its remote control mode selector is set to the correct position:
To operate an audio system, TV, and VCR, set it to the "AUDIO/TV/VCR" position.
To operate a CATV converter and satellite tuner, set it to the "CATV/SAT" position.



To change the transmittable signals for operating another manufacturer's TV

1. Set the remote control mode selector to the "AUDIO/TV/VCR" position.
2. Press and hold TV/CATV/SAT POWER.
3. Press TV SOUND.
4. Enter the manufacturer's code (three digits) using buttons 1 - 9, and 0.
See the lists on page 48 to find the code.
5. Release TV/CATV/SAT POWER.
The following buttons can be used for operating the TV (with the remote control mode selector set to the "AUDIO/TV/VCR" position):
TV/CATV/SAT POWER: Turns on and off TV.
After pressing TV SOUND you can perform the following operations on the TV:
CHANNEL +/-: Changes the channels.
TV VOLUME +/-: Adjusts the volume.
1 - 10, 0, +10: Selects the TV channels.
+10 button will function as the ENTER button if your TV requires pressing ENTER after selecting a channel number.
TV/VIDEO: Sets the input mode (either TV or VIDEO).
Note:
Refer also to the manual supplied with your TV.
6. Try to operate your TV by pressing TV/CATV/SAT POWER.
When your TV turns on or off, you have entered the correct code.
7. If there are more than one code listed for your brand of TV, try each one until the correct one is entered.

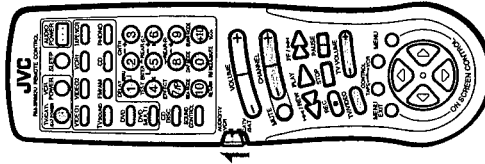

DVD player

After pressing DVD or DVD MULTI (with the remote control mode selector set to the "AUDIO/TV/VCR" position), you can perform the following operations on a DVD player:

- PLAY:** Starts playing.
Returns to the beginning of the current (or previous) track.
Skips to the beginning of the next track.
- STOP:** Stops playing.
Stops playing temporarily. To release it, press the PLAY button.

After pressing DVD or DVD MULTI (with the remote control mode selector set to the "AUDIO/TV/VCR" position), these buttons can be used for the DVD menu operations.



Note:
For detailed menu operations, refer to the instructions supplied with the discs or the DVD player.

TV

After pressing TV SOUND (with the remote control mode selector set to the "AUDIO/TV/VCR" position), you can perform the following operations on a TV:

- CHANNEL +/-: Changes the channels.
TV VOLUME +/-: Adjusts the volume.
1 - 9, 0, 100+: Selects the channels.
TV/VIDEO: Sets the input mode (either TV or VIDEO).
RETURN: Alternates between the previously selected channel and the current channel.

Note:
You can also turn the TV on and off by pressing TV/CATV/SAT POWER on the remote control.

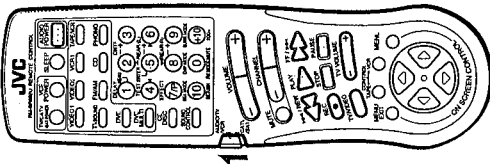

Manufacturers' codes for TV

Admiral	093	Majestic	016
Adventure	046	Marantz	030, 054
Aiko	092	Matsushita	250
Akai	030	Megaltron	145, 178
Alleron	179	Memorex	016, 056, 150, 154, 178
Ambassador	177	MGA	019, 030, 150, 178
Anam	180	Midland	017, 039, 047, 051, 135
Anam National	055	Minutz	021
AOC	019, 030	Mitsubishi	019, 093, 150, 178
Audiovox	180	Motorola	055, 093
Belcor	019	MTC	019, 030, 056, 060
Bell & Howell	016, 154	Multitech	180
Bradford	180	NAD	156, 166, 178
Brockwood	019	NEC	019, 030, 056
Candle	030, 046, 056	Nikko	030, 092, 178
Carnivale	030	NTC	018
Carver	054	Ohwa	092
Celebrity	000	Optimus	154, 166, 250
Citizen	030, 039, 046, 056, 060, 092, 280	Optonica	093, 165
Concerto	056	Orion	236
Contec	180	Panasonic	051, 055, 250
Craig	180	Penny	018, 019, 021, 030, 039, 047, 051, 060,
Crown	039, 180	Philco	135, 149, 156, 178
Curtis Mathes	030, 039, 060, 154	Philips	019, 020, 030, 054
CXC	180	Pilot	054
Daewoo	019, 039, 092, 451	Pioneer	019, 030, 039
Daytron	019	Portland	166
Dumont	017, 019	Prism	019, 039, 092
Electroband	000	Proscan	051
Emerson	019, 039, 154, 177, 178, 179, 180, 236,	Proton	047
	280, 282, 463	Pulsar	178
Envision	030	Quasar	017, 019
Fisher	154, 159	Radio Shack	051, 055, 165, 250
Fujitsu	179	RCA	019, 030, 039, 047, 056, 154, 165, 178,
Funai	171, 179, 180	Realistic	180
Futuretech	180	Runco	017, 030
GE	021, 047, 051, 055, 135, 178, 282, 451	Sampo	030, 039
Gibralter	017, 019, 030	Samsung	019, 030, 039, 056, 060, 178
GoldStar	019, 030, 039, 056, 178	Samsux	039
Grundy	179, 180	Sanyo	154, 159
Hallmark	178	Schmitzu	019
Harvard	180	Scotch	178
Hitachi	056, 145, 151	Scott	019, 178, 179, 180, 236
Infinity	054	Seats	047, 054, 056, 149, 154, 156, 159, 171,
Janel	046	Sharp	178, 179
Janel	054	Shogun	039, 093, 165
JBL	000	Signature	016
JCB	053, 069, 160, 169	Simpson	187
JVC	180	Sony	000
KEC	180	Soundsign	178, 179, 180
Kenwood	019, 030	Squareview	171
Kloss	046	SSS	019, 180
KTV	030, 039, 180, 280		
Logik	016		
Luxman	056		
LXI	047, 054, 154, 156, 178		
Magnavox	020, 030, 054, 187		

To change the transmittable signals for operating a CATV converter or satellite tuner

1. Set the remote control mode selector to the "CATV/SAT" position.
 2. Press and hold TV/CATV/SAT POWER.
 3. Press TV SOUND.
 4. Enter the manufacturer's code (three digits) using buttons 1 - 9, and 0. See the lists on page 49 to find the code.
 5. Release TV/CATV/SAT POWER.
After setting the remote control mode selector to the "CATV/SAT" position, you can perform the following operations on the CATV converter or on the satellite tuner:
TV/CATV/SAT POWER: Turns on and off the CATV converter or satellite tuner.
CHANNEL +/-: Changes the channels.
1 - 10, 0, +/-10: Selects the channels.
+10 button will function as the ENTER button if your CATV converter or satellite tuner requires pressing ENTER after selecting a channel number.
- Note:*
Refer also to the manual supplied with your CATV converter or satellite tuner.
6. Try to operate your CATV converter or satellite tuner by pressing TV/CATV/SAT POWER.
When your CATV converter or satellite tuner turns on or off, you have entered the correct code.
 7. If there are more than one code listed for your brand of CATV converter or satellite tuner, try each one until the correct one is entered.

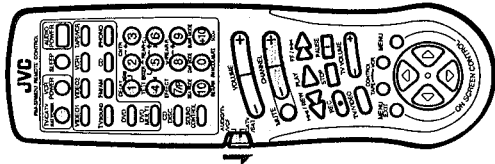

To change the transmittable signals for operating another manufacturer's VCR

1. Set the remote control mode selector to the "AUDIO/TV/VCR" position.
 2. Press and hold VCR POWER.
 3. Press VCRI.
 4. Enter the manufacturer's code (three digits) using buttons 1 - 9, and 0. See the lists on page 50 to find the code.
 5. Release VCR POWER.
The following buttons can be used for operating the VCR:
VCR POWER: Turns on and off VCR.
VCR CONTROL (with the remote control mode selector set to the "AUDIO/TV/VCR" position): you can perform the following operations on the VCR:
CHANNEL +/-: Changes the channels on the VCR.
1 - 10, 0, +/-10: Selects the channels on the VCR.
+10 button will function as the ENTER button if your VCR requires pressing ENTER after selecting a channel number.
- PLAY:** Starts playback.
STOP: Stops operations.
PAUSE: Pauses.
REW: Rewinds a tape.
FF: Fast winds a tape.
REC: Starts recording or enters recording pause.
- Notes:*
- You can use either the VCRI button or the VCR CONTROL button to activate the buttons listed above. If you press VCRI, the playing source also changes to "VCRI." On the other hand, if you press VCR CONTROL, the playing source does not change to "VCRI."
 - Refer also to the manual supplied with your VCR.
6. Try to operate your VCR by pressing VCR POWER.
When your VCR turns on or off, you have entered the correct code.
 7. If there are more than one code listed for your brand of VCR, try each one until the correct one is entered.

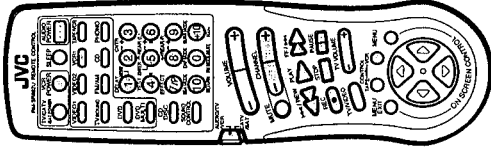

Manufacturers' codes for CATV converters

Starlite	180
Supre-Macy	046
Supreme	000
Sylvania	020, 030, 054
Symphonic	171
Tandy	093
Tatung	055
Technics	051, 250
Technol Ace	179
Techwood	051, 056
Teknika	016, 019, 039, 054, 056, 060, 092, 150, 179, 180
TMK	056, 177, 178
Toshiba	060, 149, 154, 156
Totevision	039
Vector Research	030
Victor	053
Vidikron	054
Vidtech	019, 178
Viking	046
Wards	016, 019, 020, 021, 030, 054, 056, 165, 178, 179
Yamaha	019, 030
Zenith	016, 017

Manufacturers' codes for satellite tuner

AlphaStar	772
EchoStar	775
General Instrument	361
HTS	775
Hughes Network Systems	749
Jerrod	361
Panasonic	701
Primestar	361
RCA	566
Sony	639

Manufacturers' codes for VCR

Admiral	048
Adventura	000
Aiko	278
Aiwa	000
Akai	041
American High	035
Asha	240
Audiovox	037
Beaumarck	240
Bell & Howell	104
Broksonic	121, 184, 211
Calix	037
Canon	035
Capehart	020
Carver	081
CCE	072, 278
Citizen	037, 278
Colt	072
Craig	037, 047, 072, 240
Curtis Mathes	035, 041, 060
Cybernet	240
Daewoo	020, 045, 278
Daytron	020
Dynatech	000
Electrohome	037
Electrophonic	032
Emerex	032
Emerson	000, 002, 037, 043, 121, 184, 211, 212, 278, 479
Fisher	047, 054, 104
Fuji	033, 035
Funai	000
Garrard	000
GE	035, 060
GoldStar	037, 038
Gradiente	000
Harley Davidson	000
Harman/Kardon	038
Harwood	072
Headquarter	046

Hi-Q	047
Hitachi	041, 042, 105
Jensen	041
JVC	008, 041, 067
KEC	037, 278
Kenwood	038, 041, 067
KLH	072
Kodak	035, 037
Lloyd	000
Logik	072
LXI	037
Magnavox	035, 039, 081, 149
Magnin	240
Marantz	035, 081
Marta	037
Matsushita	035, 162
MEI	035
Memorex	000, 035, 037, 038, 046, 047, 048, 104, 240
MGA	043
MGN Technology	240
Minolta	042, 105
Mitsubishi	043, 067
Motorola	035, 048
MTC	000, 240
Multitech	000, 072
NEC	038, 041, 067, 104
Nikko	037
Nikon	034
Noblex	240
Olympus	035
Optimus	037, 048, 104, 162
Optonica	062
Orion	479
Panasonic	035, 162, 225
Penney	035, 037, 038, 042, 054, 240
Pentax	042, 105
Philco	035
Philips	035, 062, 081
Pilot	037
Pioneer	067
Portland	020
Profronic	240
Protec	072
Pulsar	039
Quartz	046
Quasar	046
Radio Shack	035, 162
Radix	000, 037
Randex	037
FCA	042, 060, 105, 149
Realistic	000, 035, 037, 046, 047, 048, 062, 104
Ricoh	034
Runco	039
Samsung	045, 240

Troubleshooting

Use this chart to help you solve daily operational problems. If there is any problem you cannot solve, contact your JVC service center.

PROBLEM	POSSIBLE CAUSE	SOLUTION
The display does not light up.	The power cord is not plugged in.	Plug the power cord into an AC outlet.
No sound from speakers.	Speaker signal cables are not connected. The SPEAKERS 1 and 2 buttons are not set correctly. An incorrect source is selected. Mute is activated.	Check speaker wiring and reconnect if necessary. Press SPEAKERS 1 and 2 correctly. Select the correct source. Press MUTE to cancel the mute.
Sound from one speaker only.	Speaker signal cables are not connected properly.	Check speaker wiring and reconnect if necessary.
Continuous hiss or buzzing during FM reception.	The balance is set to one extreme. Incoming signal is too weak.	Adjust the balance properly. Connect an outside FM antenna or contact your dealer.
Occasional cracking noise during FM reception.	The station is too far away. An incorrect antenna is used.	Select a new station. Check with your dealer to be sure you have a correct antenna.
The analog discrete output sound of the DVD player cannot be reproduced correctly.	Antennas are not connected properly. Ignition noise from automobiles.	Check connections. Move the antenna farther from automobile traffic.
No colors on the on-screen display.	An incorrect source is selected.	Select "DVDMULTI" as the source on the receiver.
Howling during record playing.	The sound setting of the DVD player is incorrect. The color system of the connected TV is not NTSC.	Check the sound setting of the DVD player. Connect an NTSC TV.
Remote control does not work.	Your remote is too close to speakers. The remote control mode selector is not set correctly.	Move speakers away from the turntable. Set the selector correctly either to the "AUDIO/TV/VCR" position or to "CATV/SAT" position.
Remote control does not work.	There is an obstruction in front of the remote control sensor on the receiver. Batteries are weak.	Remove the obstruction. Replace batteries.

Sanky	039, 048
Sansui	041, 067
Sanyo	046, 047, 104, 240
Scott	043, 045, 121, 184, 211, 212
Sears	035, 037, 042, 046, 047, 054, 104, 105
Sharp	048, 062
Shintom	072
Shogun	240
Singer	072
Sony	032, 033, 034, 035
STS	042
Sylvania	000, 035, 043, 081
Symphonic	000
Tatung	041
Teac	000, 041
Technics	035, 162
Teknika	000, 035, 037
TMK	240
Toshiba	043, 045, 212
Totevision	037, 240
Unitech	240
Vector	045
Vector Research	038
Video Concepts	045
Videoseonic	240
Wards	000, 035, 042, 047, 048, 060, 062, 072, 149, 212, 240
XR-1000	000, 035, 072
Yamaha	038
Zenith	033, 034, 039

Manufacturers' codes listed on page 48 to 51 are subject to change without notice. If they are changed, this remote control cannot operate the equipment.

Specifications

Amplifier

Output Power At Stereo operation
At Surround operation
Front Channels
Center channel
Rear channels

120 watts per channel, min. RMS, both channels driven into 8 ohms, 20 Hz to 20 kHz with no more than 0.02% total harmonic distortion.

120 watts per channel, min. RMS, driven into 8 ohms at 1 kHz, with no more than 0.8% total harmonic distortion.

120 watts, min. RMS, driven into 8 ohms at 1 kHz, with no more than 0.8% total harmonic distortion.

60 watts per channel, min. RMS, driven into 8 ohms at 1 kHz, with no more than 0.8% total harmonic distortion.

0.02%* at 120 watts output
(* Measured by JVC Audio Analysis System)

Total Harmonic Distortion (8 ohms, 1 kHz)

Audio Input Sensitivity/Impedance (1 kHz)

PHONO (MM)
CD, TAPE/VCR, TV SOUND, VCR1, VIDEO1, VIDEO2, DVD (FRONT)/CENTER/REAR/SUBWOOFER)

2.5 mV/47 k ohms
230 mV/47 k ohms

Audio Output Level

TAPE/VCR, VCR1

230 mV

Signal-to-Noise Ratio ('66 IHF/76 IHF)

PHONO
CD, TAPE/VCR, TV SOUND, VCR1, VIDEO1, VIDEO2, DVD (FRONT)/CENTER/REAR/SUBWOOFER)

70 dB/78 dB (at REC OUT)
91 dB/80 dB

Frequency Response (8 ohms)

PHONO
CD, TAPE/VCR, TV SOUND, VCR1, VIDEO1, VIDEO2, DVD (FRONT)/CENTER/REAR/SUBWOOFER)

20 Hz to 20 kHz (±0.5 dB)
20 Hz to 20 kHz (±1 dB)

RIAA Phono Equalization

Loudness Control
(Volume Control at -40 dB)

±0.5 dB (20 Hz to 20 kHz)
+6 ±1 dB at 100 Hz
+4 ±1 dB at 10 kHz

S.E.A.

Center Frequencies Control Range

100 Hz, 1 kHz, 10 kHz
±10 dB ±2 dB

Video

Video Input Sensitivity/Impedance

TAPE/VCR, VCR1, DVD, VIDEO1, VIDEO2

1 Vp-p/75 ohms

Video Output Level

TAPE/VCR, VCR1, MONITOR OUT

1 Vp-p/75 ohms

Synchronization

Negative

Signal-to-Noise Ratio

45 dB

On-Screen Color System

NTSC

FM tuner (IHF)

Tuning Range

87.5 MHz to 108.0 MHz

Usable Sensitivity

Monaural
10.8 dBf (0.95 µV/75 ohms)
16.3 dBf (1.8 µV/75 ohms)
38.3 dBf (22.5 µV/75 ohms)

50 dB Quieting Sensitivity

Monaural
Stereo

Signal-to-Noise Ratio (IHF-A weighted)

Monaural
Stereo

80 dB at 85 dBf
73 dB at 85 dBf

Total Harmonic Distortion

Monaural
Stereo

0.15% at 1 kHz
0.2% at 1 kHz

Stereo Separation at REC OUT

40 dB at 1 kHz

Capture Ratio

1.5 dB at 85 dBf

Alternate Channel Selectivity

60 dB: (±400 kHz)

Frequency Response

30 Hz to 15 kHz: (+0.5 dB, -3 dB)

AM tuner

Tuning Range

530 kHz to 1,710 kHz

Usable Sensitivity

Loop antenna
External antenna

300 µV/m
30 µV

Signal-to-Noise Ratio

50 dB (100 mV/m)

General

Power Requirements

AC 120V, 60 Hz

Power Consumption

370 watts/500 VA
2 watts (in standby mode)

Dimensions (W x H x D)

17 3/16 x 6 3/16 x 16 1/4 inches
(435 x 156.5 x 412 mm)

Mass

25.1 lbs (11.4 kg)

Designs & specifications are subject to change without notice.

JVC

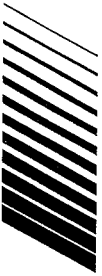

Warnings, Cautions and Others



CAUTION
RISK OF ELECTRIC SHOCK
DANGER



TO REDUCE THE RISK OF ELECTRIC SHOCK,
DO NOT REMOVE COVER OR BACK.
NO USER SERVICEABLE PARTS INSIDE.
REFER SERVICING TO QUALIFIED SERVICE PERSONNEL.

The lightning flash with arrowhead symbol, within an equilateral triangle is intended to alert the user to the presence of uninsulated "dangerous voltage" within the product's enclosure that may be of sufficient magnitude to constitute a risk of electric shock to persons.



The exclamation point within an equilateral triangle is intended to alert the user to the presence of important operating and maintenance (servicing) instructions in the literature accompanying the appliance.

CAUTION

To reduce the risk of electrical shocks, fire, etc.:

1. Do not remove screws, covers or cabinet.
2. Do not expose this appliance to rain or moisture.

Caution — POWER switch!
Disconnect the mains plug to shut the power off completely. The POWER switch in any position does not disconnect the mains line. The power can be remote controlled.

Caution — SPEAKER LOAD SELECTOR switch!
Match the position of SPEAKER LOAD SELECTOR switch on the back panel to the impedance of the speaker connected, to protect from overheating.

WARNING: TO REDUCE THE RISK OF FIRE OR ELECTRIC SHOCK, DO NOT EXPOSE THIS APPLIANCE TO RAIN OR MOISTURE.

AUDIO/VIDEO CONTROL RECEIVER

RX-992VBK

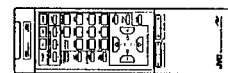

COMPU LINK
Remote Link

AV/COMPU LINK

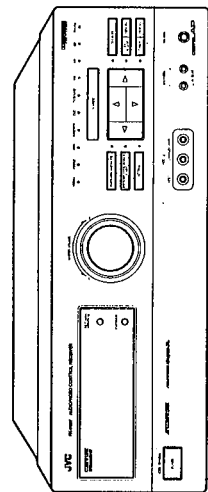

INSTRUCTIONS

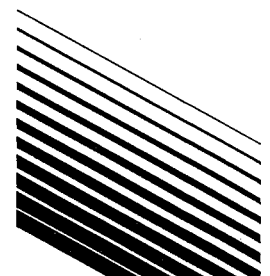

For Customer Use:
Enter below the Model No. and Serial No. which are located either on the rear, bottom or side of the cabinet. Retain this information for future reference.

Model No. _____
Serial No. _____

LET0025-001A (U) G-1

Table of Contents

Getting Started	2
Before Installation	2
Checking the Supplied Accessories	2
Switches, Buttons and Controls	3
Connecting the FM and AM Antennas	5
Connecting the Speakers	6
Connecting Audio/Video Components	8
Connecting the Power Cord	11
Putting Batteries in the Remote Control	11
Basic Operations	12
Turning the Power On and Off	12
Selecting the Source to Play	12
Adjusting the Volume	13
Selecting the Front Speakers	13
Muting the Sound	14
Recording a Source	14
Basic Settings	15
Adjusting the Front Speaker Output Balance	15
Listening at Low Volume (Loudness)	15
Using the Sleep Timer	16
Selecting the Center Speaker Size	17
Using Visual Confirmation	18
One Touch Operation	19
About the One Touch Operation	19
Using the One Touch Operation	19
Receiving Radio Broadcasts	20
Tuning in Stations Manually	20
Using Preset Tuning	20
Selecting the FM Reception Mode	21
Assigning Names to Preset Stations	22
Using the SEA Modes	23
Selecting Your Favorite SEA Mode	23
Creating Your Own SEA Mode	24
Activating the Surround Sounds	25
Using the DAP Modes	26
Using the DVD MULTI Playback Mode	28
Using the Surround Modes	30
Using the On-Screen Display to Control the Receiver	36
COMPU LINK Remote Control System	40
AV COMPU LINK Remote Control System	41
Using the Remote Control	43
Using the Remote Control for Operating JVC Audio/Video Components	43
Simplifying the Operations Using the Remote Control	47
Operating the Other Manufacturers' Audio/Video Components	49
Troubleshooting	52
Specifications	53

 This mark indicates that you can also use the menu function to do the same operations. Actual operations using the menu function are explained on the pages indicated next to the marks.

Getting Started

This section explains how to connect audio/video components and speakers to the receiver, and how to connect the power supply.

Before Installation

General

- Be sure your hands are dry.
- Turn the power off to all components.
- Read the manuals supplied with the components you are going to connect.

Locations

- Install the receiver in a location that is level and protected from moisture.
- The temperature around the receiver must be between 23° and 95° F (-5° and 35° C).
- Make sure there is good ventilation around the receiver. Poor ventilation could cause overheating and damage the receiver.

Handling the receiver

- Do not insert any metal object into the receiver.
- Do not disassemble the receiver or remove screws, covers, or cabinet.
- Do not expose the receiver to rain or moisture.

Checking the Supplied Accessories

Check to be sure you have all of the following items, which are supplied with the receiver. The number in the parenthesis indicates the quantity of the pieces supplied.

- Remote Control (1)
- Batteries (2)
- AM Loop Antenna (1)
- FM Antenna (1)

If anything is missing, contact your dealer immediately.

Switches, Buttons and Controls

Become familiar with the main switches and controls on your receiver before use.

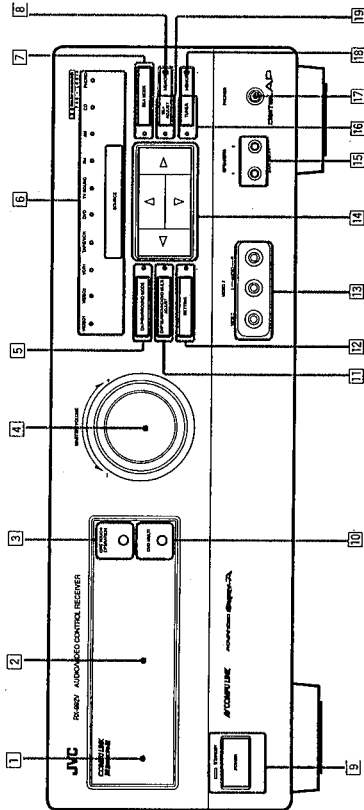

Refer to the pages in parentheses for details.

Front Panel

- 1 Remote sensor (11)
- 2 Display (12)
- 3 ONE TOUCH OPERATION button and lamp (19)
- 4 MASTER VOLUME control (13)
- 5 DAP/SURROUND MODE button and lamp (26, 31)
- 6 SOURCE button and lamps (12)
- 7 SEA MODE button and lamp (23)
- 8 MEMORY button for SEA adjustments (24)
- 9 POWER button and STANDBY lamp (12)
- 10 DVD MULTI button and lamp (12)
- 11 DAP/SURROUND/DVD MULTI ADJUST button and lamp (26, 28, 31)
- 12 SETTING button and lamp (15)
- 13 VIDEO 2 input jacks (10)
- 14 Control $\Delta / \nabla / \triangleleft / \triangleright$ buttons
- 15 SPEAKERS 1/2 buttons (13)
- 16 TUNER button and lamp (20)
- 17 PHONES jack (14)
- 18 MEMORY button for presenting channels (20)
- 19 SEA ADJUST button and lamp (24)

IMPORTANT
To use Control $\Delta / \nabla / \triangleleft / \triangleright$ buttons (14) on the front panel:

What these buttons actually do depends on which function you are trying to adjust. Before using these buttons, select the function by pressing one of the function selecting buttons (5, 6, 7, 8, 9, 10, 11, 12, 13), and being sure its lamp is lit.

However, pressing MENU (18) on the remote control overrides the selected function and causes Control $\Delta / \nabla / \triangleleft / \triangleright$ button to act like the $\Delta / \nabla / \triangleleft / \triangleright$ buttons (14) on the ON SCREEN CONTROL section of the remote control (though a lamp for the selected function remains lit).

To return the remote control (though a lamp for the selected behavior under the selected function, press the function button again.

Remote Control

Outside panel

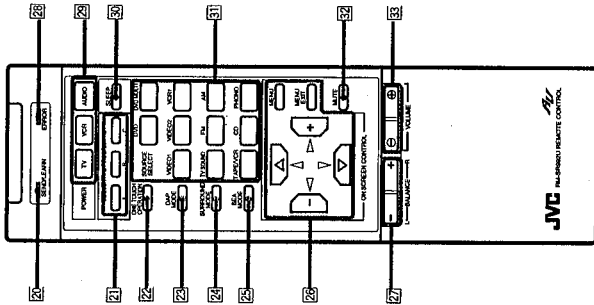

How to open the outside panel

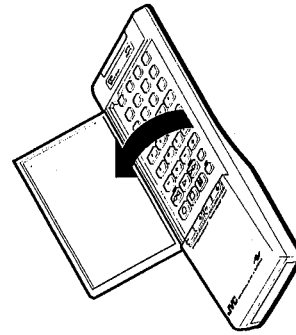

Inside panel

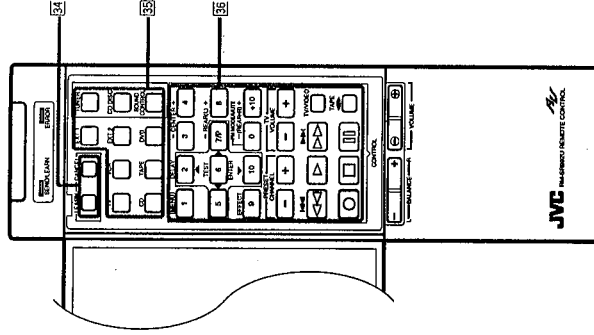

Remote Control Unit

- 21 SEND/LEARN indicator (47, 49)
- 22 SEQUENTIAL PROGRAM KEYS (47)
- 23 ONE TOUCH OPERATION button (19)
- 24 DAP MODE button (27)
- 25 SURROUND MODE button (34)
- 26 SEA MODE button (23)
- 27 Menu function buttons (ON SCREEN CONTROL section) (36)
- 28 BALANCE L/R (+/-) buttons (15)
- 29 ERROR indicator (47, 49)
- 30 Power buttons (POWER section) (12, 45, 46)
- 31 SLEEP button (16)
- 32 Source select buttons (SOURCE SELECT section) (13)
- 33 MUTE button (14)
- 34 VOLUME +/- buttons (13)

Inside panel

- 34 Learning function buttons (47, 49)
- 35 Remote mode section (43)
- 36 10 keys (21)
- Sound Adjustment buttons (27, 29, 34)
- Component operating buttons (45)

IMPORTANT
About the $\Delta / \nabla / \triangleleft / \triangleright$ buttons on the ON SCREEN CONTROL section (14) of the remote control: If you press these buttons, the menu function starts operating. So, make sure you are showing the on-screen display on the TV before pressing these buttons.

Connecting the Speakers

You can connect the following speakers:

- Two pairs of front speakers to produce normal stereo sound.
- One pair of rear speakers to enjoy the surround effect.
- One center speaker to produce more effective surround effect (to emphasize human voices).
- One subwoofer to enhance the bass.

For each speaker (except for subwoofer), connect the black (-) and red (+) terminals on the rear panel to the black (-) and red (+) terminals marked on the speakers. For connecting a subwoofer, see page 7.

CAUTION:
Use speakers with the **SPEAKER IMPEDANCE** indicated by the speaker terminals.

Connecting the front speakers

Cut, twist and remove the insulation at the end of each speaker signal cable first, and then, connect the front speakers to the **FRONT SPEAKERS** terminals by using the cables. You can connect two pairs of front speakers (one pair to the **FRONT SPEAKERS** ① terminals, and another pair to the **FRONT SPEAKERS** ② terminals).

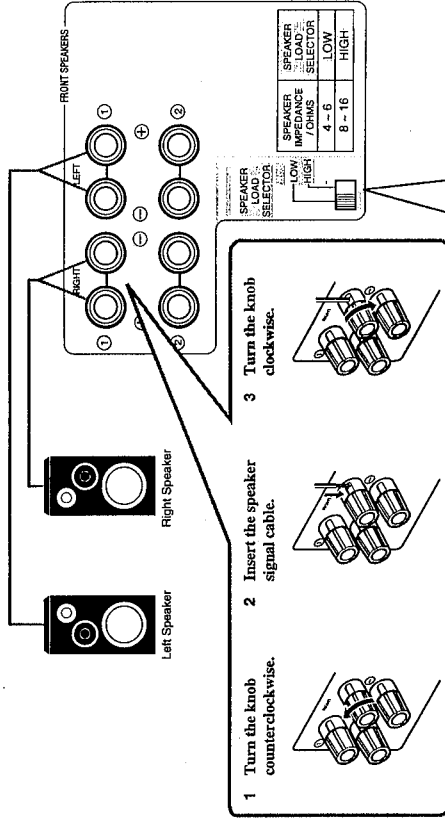

Notes:

- To obtain the best possible output power from the receiver, and to prevent the receiver from being overheated, the receiver has the **SPEAKER LOAD SELECTOR** which should be set to match the impedance of the connected speakers. Set this selector according to the indications by the **FRONT SPEAKERS** terminals.
- When you connect two pairs of the speakers to the **FRONT SPEAKERS** terminals, use the speakers having the impedance within the same range.

Connecting the FM and AM Antennas

FM Antenna Connections

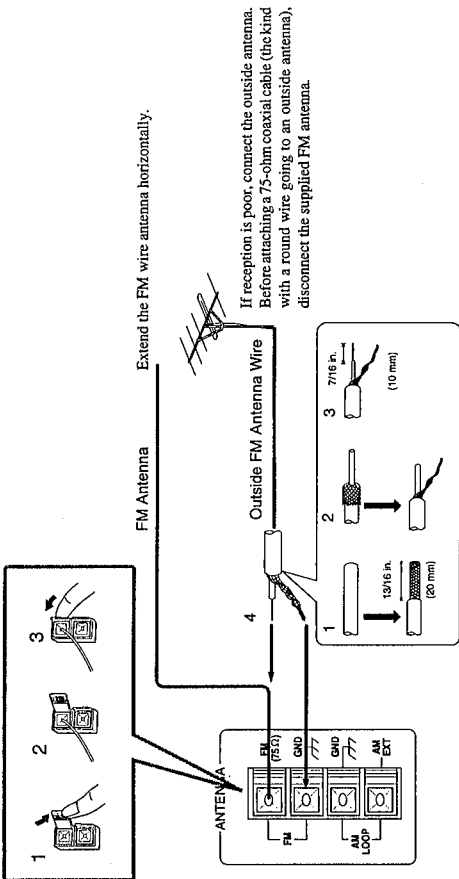

How to strip the 75-ohm coaxial cable and connect it to the FM terminals

1. Strip back the outside covering of the 75-ohm coaxial cable to expose the braided metallic mesh about 13/16 inches (20 mm).
2. Pull the mesh back and twist it into a single connector, as shown in the illustration above.
3. Strip the insulation about 7/16 inches (10 mm) back from the central wire.
4. Insert the twisted mesh and the central wire to the FM terminals, as shown in the illustration above.

AM Antenna Connections

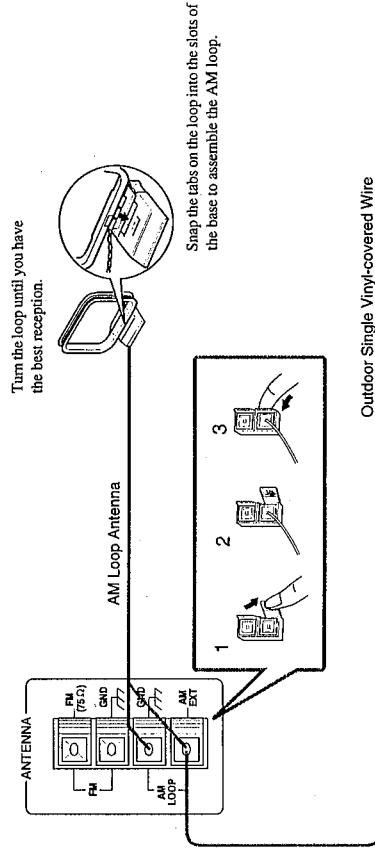

Note:
Make sure the antenna conductors do not touch any other terminals, connecting cords and power cord. This could cause poor reception.

Connecting Audio/Video Components

You can connect the following audio/video components to this receiver using cables with RCA pin plugs (not supplied). Refer also to the manuals supplied with your components. If you want to connect a component not listed in the table below, refer to the manual supplied with it.

Audio Components	Video Components
• Turntable	• DVD (Digital Video Disc) player
• CD player	• TV
• Cassette deck	• VCR(s)
	• Video disc player
	• Video camera

- Notes:**
- If you connect a sound-enhancing device such as a graphic equalizer between the source components and this receiver, the sound output through this receiver may be distorted.
 - You can connect either a cassette deck or a VCR to the TAPE/VCR jacks, whichever you want.
 - Any turntables incorporating a small-output cartridge such as an MC (moving-coil type) must be connected to this receiver through a commercial head amplifier or step-up transformer. Direct connection may result in insufficient volume.

Audio component connections

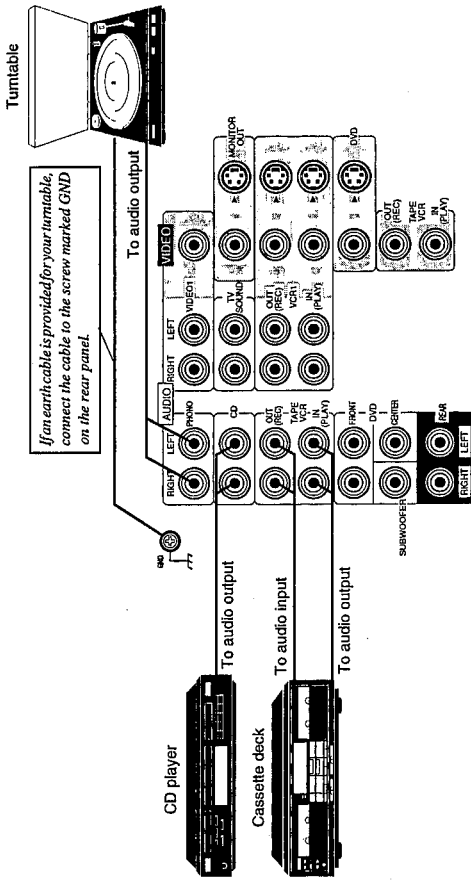

If your audio components have a COMPU LINK-3 terminal

The COMPU LINK remote control system allows you to control other JVC audio components from the receiver or vice versa. Connect your audio components and the receiver with the cable (monaural mini-plug supplied with those components) as well as the connection above.

For detailed information about the connection and the COMPU LINK-3 remote control system, see page 40.

Notes:

- If you want to operate a cassette deck using the COMPU LINK remote control system, connect the cassette deck to the TAPE/VCR jacks, not to the VCR1 jacks.
- The COMPU LINK-3 remote control system is the upgraded version of the COMPU LINK-1 and COMPU LINK-2. Even if your component has the COMPU LINK-1 or COMPU LINK-2 jacks, you can still connect it in the COMPU LINK-3 remote control system, but some functions may not work correctly.

Connecting the rear and center speakers

Cut, twist and remove the insulation at the end of each speaker signal cable first, and then connect rear speakers to the REAR SPEAKERS terminals and a center speaker to the CENTER SPEAKER terminals by using the cables.

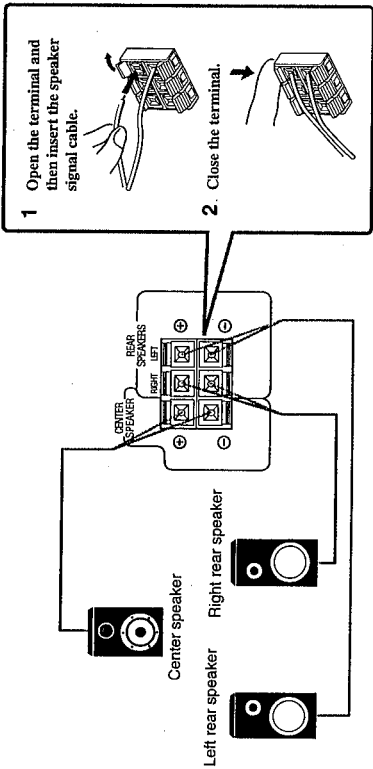

Note:

You can register the center speaker size after you finish its connection. If you register it, you do not have to set the center speaker mode when setting the surround mode. (If you do not use a center speaker, register that information.) See page 17.

Connecting the subwoofer speaker

You can enhance the bass by connecting a subwoofer. Connect the input jack of a powered subwoofer to the SUBWOOFER OUT jack on the rear panel, using a cable with RCA pin plugs.

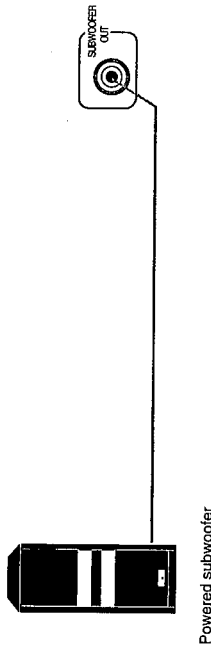

Video component connections

If your video components have S-video (Y/C-separation) terminals, connect them using S-video cables (not supplied). Connecting these video components through the S-video input/output terminals will give you get better picture playback quality.

IMPORTANT:

This receiver is equipped with both the composite video and S-video input/output terminals for connecting video components. You do not have to connect both the composite video and S-video terminals. However, remember that the video signals from the composite video input terminals on the rear are output only through the composite video output terminals, while the ones from the S-video input terminals on the rear are output only through the S-video output terminals. Therefore, if a recording video equipment and a playing video equipment are connected to the receiver through the different video terminals, you cannot record the picture from the recording equipment. In addition, if the TV and a playing video equipment are connected to the receiver through the different video terminals, you cannot view the playback picture from the playing equipment on the TV.

To view and record the playback picture from the video components connected to the VIDEO1, VIDEO2, and TAPE/VCR jacks, you must connect the TV and the recording video equipment through the composite video terminals.

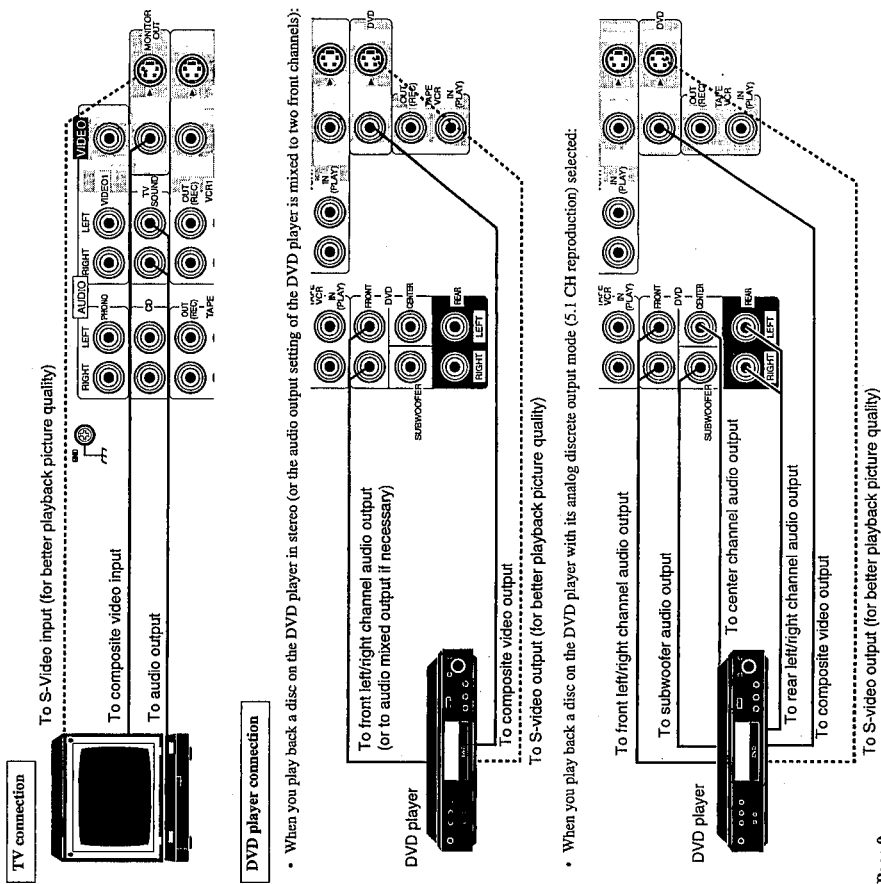

VCR and video disc player connection

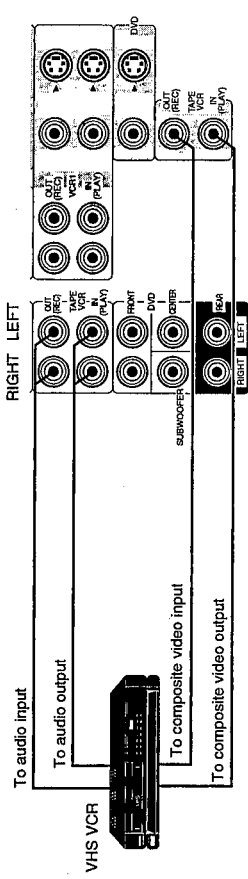
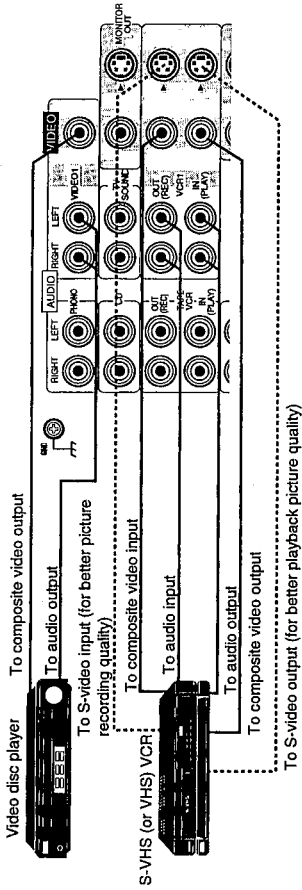

Video camera connection

You can use the VIDEO 2 input jacks on the front panel. These jacks are convenient for connecting and disconnecting the component frequently.

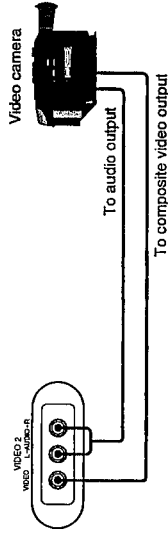

If your video components have an AV COMPU LINK terminal

The AV COMPU LINK remote control system allows you to control other JVC video components from the receiver or vice versa. For detailed information about the connection and the AV COMPU LINK remote control system, see pages 41 and 42.

Notes:

- If you want to use the AV COMPU LINK remote control system:
 - Connect the receiver to the Video Input 2 jack on the TV if you connect the TV through the composite video terminal of the MONITOR OUT jacks.
 - Connect the receiver to the Video Input 1 jack on the TV if you connect the TV through the S-video terminal of the MONITOR OUT jacks.
- The AV COMPU LINK remote control system cannot control the video components connected to the VIDEO1, VIDEO2, and TAPE/VCR jacks on the receiver, but can control only the VCR connected to the VCR1 jacks and the DVD player connected to the DVD jacks. You cannot connect two VCRs into the AV COMPU LINK remote control system.
- Some VCRs use the AV COMPU LINK jacks for the SWAP editing. However, you cannot use both the AV COMPU LINK remote control and the SWAP editing at the same time. For the SWAP editing, see the manual supplied with the VCR.

Connecting the Power Cord

Before plugging the receiver into an AC outlet, make sure that all connections have been made. When the power cord is connected, the STANDBY lamp above the POWER button lights up.

Keep the power cord away from the connecting cables for the TV, VCR, and antenna. The power cord may cause noise or screen interference. We recommend that you use a coaxial cable to connect the antenna, since it is well-shielded against interference.

Notes:

- A small amount of power is always consumed even in standby mode. To switch off the power completely, unplug the power cord from the AC outlet.
- If the power cord is unplugged or a power failure occurs, preset settings will be erased in a few days.

CAUTIONS:

- Do not touch the power cord with wet hands.
- Do not pull on the power cord to unplug the cord. When unplugging the cord, always grasp the plug so as not to damage the cord.

Putting Batteries in the Remote Control

Before using the remote control, put two supplied batteries first. When using the remote control, aim the remote control directly at the remote sensor on the receiver.

1. On the back of the remote control, remove the cover as illustrated.
2. Insert batteries. Make sure to observe the proper polarity: (+) to (+) and (-) to (-).
3. Replace the cover in.

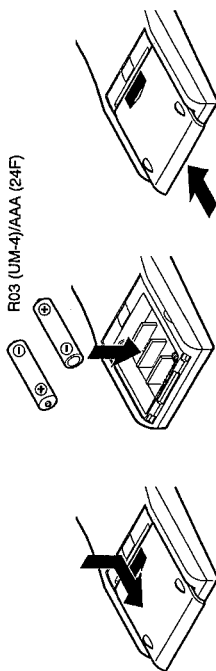

If the range or effectiveness of the remote control decreases, replace the batteries. Use two R03 (UM-4)/AAA (24F) type dry-cell batteries.

Note:

When you replacing the batteries, finish it without delay, otherwise, the control signals you have stored are all erased. (See pages 47 and 49.)

CAUTIONS:

- Follow these precautions to avoid leaking or cracking cells:
 - Place batteries in the remote control so they match the polarity indicated, (+) to (+) and (-) to (-).
 - Use the correct type of batteries. Batteries that look similar may differ in voltage.
 - Always replace both batteries at the same time.
 - Do not expose batteries to heat or flame.

Basic Operations

The following operations are commonly used when you play any sound source.

Turning the Power On and Off

On the front panel:

To turn on the power, press POWER.

The STANDBY lamp goes off. The name of the current source appears on the display.

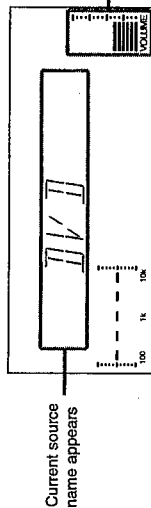

Current source name appears

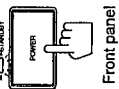

Front panel

Volume level is also shown here whenever the power is on.

To turn off the power, press POWER again.

The STANDBY lamp lights up.

From the remote control:

To turn on the power, press AUDIO.

The STANDBY lamp goes off. The name of the current source appears on the display.

To turn off the power, press AUDIO again.

The STANDBY lamp lights up.



Remote, Outside



See also page 36.

Selecting the Source to Play

You need to select the source before you start playing any source.

On the front panel:

1. Press SOURCE so that the Control Δ / ∇ / \triangleleft / \triangleright buttons work for selecting the source.
2. Press Control Δ / ∇ until the source name you want appears on the display. The selected source lamp also lights up.

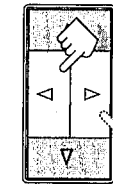
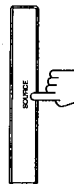

Selected source name appears

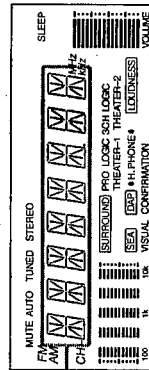

CAUTIONS:

- For selecting DVD MULTI playback mode as the source: Press DVD MULTI so that the lamp above the button lights up. Each time you press the button, the DVD MULTI playback mode turns on and off, and the "DVD" and "DVMULTI" alternately appears on the display.
- Select "DVD" when you play back a disc in stereo or the audio output setting of the DVD player is mixed to two front channels.
- Select "DVMULTI" when you play back a disc on the DVD player with its analog discrete output mode (5.1 CH reproduction) selected. To enjoy "DVMULTI" mode, see page 28.

Notes:

- You can change the source to another even while the DVD MULTI lamp is lit.
- You can also select "DVMULTI" by pressing Control \triangleleft / \triangleright when "DVD" is selected.

From the remote control:

Press one of the buttons on the SOURCE SELECT section.

- DVD Play back a stereo digital video disc.
- DVD MULTI Play back a digital video disc using the analog discrete output mode (S-1 CH reproduction) on the DVD player.
- VIDEO1 Each time you press the button, the DVD MULTI playback mode turns on and off.
- VIDEO2 Play back a video source on the video component connected to the VIDEO1 jacks.
- VCR1 Play back a video source on the video component connected to the VIDEO2 jacks.
- TV SOUND Listen to TV sounds.
- FM* Listen to FM broadcasts.
- AM* Listen to AM broadcasts.
- TAPE/VCR* Listen to a cassette tape (or play back a video source) connected to the TAPE/VCR jacks.
- CD* Listen to a CD.
- PHONO* Listen to a record.

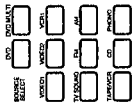

Remote: Outside

Note:
When you press one of the buttons on the SOURCE SELECT section marked above with an asterisk (*), the receiver automatically turns on.

Adjusting the Volume

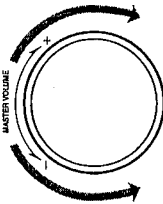

Front panel



Remote: Outside

When you change the volume level, the volume level is shown on the display.

On the front panel:

- To increase the volume, turn MASTER VOLUME clockwise.
- To decrease the volume, turn MASTER VOLUME counterclockwise.

Note:

When you turn MASTER VOLUME rapidly, the volume level also changes rapidly.
When you turn MASTER VOLUME slowly, the volume level also changes slowly.

From the remote control:

- To increase the volume, press VOLUME +.
- To decrease the volume, press VOLUME -.

CAUTION:

Always set the volume level to the minimum before starting any source. If the volume level is left turned up, the sudden blast of sound energy can permanently damage your hearing and/or ruin your speakers.

Selecting the Front Speakers



Front panel

On the front panel only:

When you have connected two pairs of the front speakers, you can select which to use. Pressing SPEAKERS 1 or SPEAKERS 2 to set it in the -ON position activates the respective pair of the speakers.

To use the speakers connected to the FRONT SPEAKERS ① terminals, press SPEAKERS 1 to set it in the -ON position, and press SPEAKERS 2 to set it in the -OFF position.

To use the speakers connected to the FRONT SPEAKERS ② terminals, press SPEAKERS 2 to set it in the -ON position, and press SPEAKERS 1 to set it in the -OFF position.

To use both pairs of the speakers, press both SPEAKERS 1 and 2 to set them in the -ON position.
To use neither pair of the speakers, press both SPEAKERS 1 and 2 to set them in the -OFF position.

Note:

When only one set of the speakers is connected to either the FRONT SPEAKERS ① or ② terminals, do not press both SPEAKERS 1 and 2 to set them in the -ON position. If you do, no sound comes out of the front speakers.

Listening with Headphones

A standard pair of headphones can be connected to the PHONES jack on the front panel.

To listen with only headphones, press both SPEAKERS 1 and 2 to set them in the -OFF position. No sound comes out of the front speakers.

CAUTION:

Be sure to turn down the volume before connecting or putting on headphones, as high volume can damage both the headphones and your hearing.

Muting the Sound



Remote: Outside

From the remote control only:

To mute the sound through all the speakers and headphones connected, press MUTE so that "MUTE" appears on the display and the volume turns off.

To cancel the mute, press MUTE again so that "OFF" appears on the display.

Turning MASTER VOLUME or pressing VOLUME +/- also restores the sound at the previous volume level.

Recording a Source

You can record any source playing through the receiver to the cassette deck (or VCR) connected to the TAPE/VCR jacks and the VCR connected to the VCR1 jacks at the same time.

However, to record the picture on the VCR(s), the VCR(s) and the playing source equipment must be connected using the video cable of the same type (either composite or S-video). For example, if the DVD player is connected only using the S-video cable and the VCR is connected only using the composite video cable, you cannot record the picture from the DVD player on this VCR.

While recording, you can listen to the selected sound source at whatever sound level you like, without affecting the sound levels of the recording.

Note:

The output volume level, SEA, DAP, and surround adjustments cannot affect the recording.

See also
page 37.



Using the Sleep Timer

Using the Sleep Timer, you can fall asleep to music and know the receiver will turn off by itself rather than play all night.

On the front panel:

1. Press SETTING so that the Control $\Delta / \nabla / \triangleleft / \triangleright$ buttons work for setting the Sleep Timer. The lamp next to the button lights up.
2. Press Control Δ / ∇ until "<SLEEP>" appears on the display.
3. Press Control $\triangleleft / \triangleright$ to set the shut-off time. Each time you press the button, the shut-off time on the display changes as follows:
The SLEEP indicator lights up on the display.

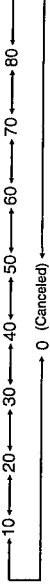

When the shut-off time comes
The receiver turns off automatically.

To check or change the time remaining until the shut-off time
Press SETTING, if necessary, so that the Control $\Delta / \nabla / \triangleleft / \triangleright$ buttons work for setting the Sleep Timer.

1. Press Control Δ / ∇ if necessary, until "<SLEEP>" appears on the display.
2. Press Control $\triangleleft / \triangleright$ once.
3. The remaining time until the shut-off time appears in minutes.
 - To change the shut-off time, press Control $\triangleleft / \triangleright$ repeatedly.

To cancel the Sleep Timer

Press Control $\triangleleft / \triangleright$ repeatedly in step 3 above until "0" appears on the display. (The SLEEP indicator goes off.) Turning off the power also cancels the Sleep Timer.

From the remote control:

Press SLEEP repeatedly.
The SLEEP indicator lights up and the shut-off time appears on the display.
Each time you press the button, the shut-off time on the display changes as follows:

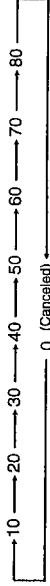

Remote: Outside

To check or change the time remaining until the shut-off time
Press SLEEP once. The remaining time until the shut-off time appears in minutes.

- To change the shut-off time, press SLEEP repeatedly.

To cancel the Sleep Timer

Press SLEEP repeatedly until "0" appears on the display. (The SLEEP indicator goes off.) Turning off the power also cancels the Sleep Timer.

See also
page 36.



Adjusting the Front Speaker Output Balance

If the sounds you hear from the front right and left speakers are unequal, you can adjust the speaker output balance.

On the front panel:

1. Press SETTING so that the Control $\Delta / \nabla / \triangleleft / \triangleright$ buttons work for adjusting the balance. The lamp next to the button lights up.
2. Press Control Δ / ∇ until "BALANCE" appears on the display.
3. Press Control $\triangleleft / \triangleright$ to adjust the balance.
 - Pressing Control \triangleleft decreases the right channel output.
 - Pressing Control \triangleright decreases the left channel output.

From the remote control:

- Press BALANCE L/R (-/+).
- Pressing BALANCE L (-) decreases the right channel output.
 - Pressing BALANCE R (+) decreases the left channel output.

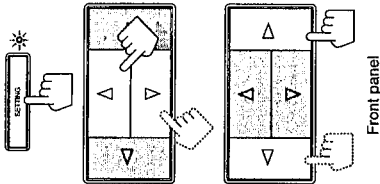

Front panel

See also
page 37.



Listening at Low Volume (Loudness)

Human ears are not sensitive to bass at low volume. To compensate for this, the loudness function automatically boosts the bass level as you lower the volume.

Note:
The loudness function affects the front speaker sounds only.

On the front panel only:

1. Press SETTING so that the Control $\Delta / \nabla / \triangleleft / \triangleright$ buttons work for setting the loudness function. The lamp next to the button lights up.
2. Press Control Δ / ∇ until "LOUDNESS" appears on the display.
3. Press Control $\triangleleft / \triangleright$ to set the loudness function to "ON" or "OFF."
 - Select "ON" to activate the loudness function. The LOUDNESS indicator lights up on the display.
 - Select "OFF" to cancel it. The indicator goes off.

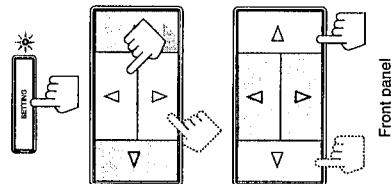

Front panel

One Touch Operation

This receiver can memorize the optimum sound settings for each playing source.

About the One Touch Operation

JVC's One Touch Operation function is used to assign and store different sound settings for each different playing source. By using this function, you don't have to change the settings every time you change the source. The stored settings for the newly selected source are automatically recalled.

The following can be stored for each source:

- Volume level (see page 13)
- Balance (see page 15)
- Loudness (see page 15)
- SEA modes (see page 23)
- DAP mode settings (see page 26)
- DVD MULTI playback mode settings (see page 28)
- Surround mode settings (see page 31)

Notes:

- If the source is FM or AM, the One Touch Operation function works only when the preset channels, from 1 — 20 are tuned in. You can assign a different setting for each preset channel.
- The DAP mode, DVD MULTI playback mode, and surround mode cannot be used at the same time.

Using the One Touch Operation

To store the sound settings

1. Press ONE TOUCH OPERATION. The ONE TOUCH OPERATION lamp lights up, then the previously memorized settings are recalled and appear on the display in turn.



Front panel

2. Adjust the sound using the functions listed above. The newly adjusted settings are memorized.

To recall the sound settings

With the ONE TOUCH OPERATION lamp lit, the settings for the currently selected source is recalled, and appears on the display when the source is selected.

To cancel the One Touch Operation function

Press ONE TOUCH OPERATION so that the lamp goes off. (Even though the One Touch Operation function is canceled, the recalled sound effects remain active.)



Remote: Outside

Receiving Radio Broadcasts

You can browse through all the stations or use the preset function to go immediately to a particular station.

See also page 38.

Tuning in Stations Manually

On the front panel only:

1. Press TUNER so that the Control Δ / ∇ / \triangleleft / \triangleright buttons work for tuner settings. The lamp next to the button lights up.
2. Press Control Δ / ∇ until "<FM AM>" appears on the display.
3. Press Control \triangleleft / \triangleright to select the band. Each time you press the button, the band alternates between FM and AM.
4. Press Control Δ / ∇ until "<TUNING+>" appears on the display.
5. Press Control \triangleleft / \triangleright until you find the frequency you want.
 - Pressing Control \triangleleft decreases the frequency.
 - Pressing Control \triangleright increases the frequency.

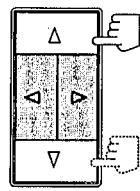
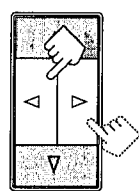
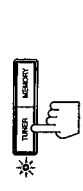

Front panel

Notes:

- When you hold down Control \triangleleft / \triangleright in step 5, the frequency keeps changing until you press the button again or a station is tuned in.
- When a station of sufficient signal strength is tuned in, the TUNED indicator lights up on the display. When an FM stereo program is received, the STEREO indicator also lights up.

See also page 38.

Using Preset Tuning

Once a station is assigned to a channel number, the station can be quickly tuned. You can preset up to 40 stations at random.

Storing the preset stations

On the front panel only:

1. Tune in the station you want to preset (see above). If you want to store the FM reception mode for this station, select the FM reception mode you want. See page 21 for details.
2. Press MEMORY (next to the TUNER button). "CH:" appears and the channel number position starts flashing on the display for about 5 seconds.
3. Press Control Δ / ∇ to select a channel number while the channel number position is flashing.
 - Pressing Control Δ increases the number.
 - Pressing Control ∇ decreases the number.

Note:

You can use the 10 keys on the remote control to select the preset number. When using the 10 keys, be sure that they are activated for tuner, not for the CD and others. (See page 43.)

4. Press MEMORY (next to the TUNER button) again while the selected channel number is flashing on the display. The selected channel number stops flashing. The station is assigned to the selected channel number.
5. Repeat steps 1 to 4 until you store all the stations you want.

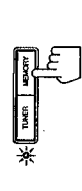
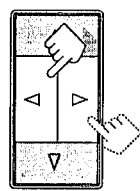
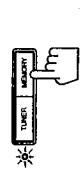

Front panel

To cancel a stored preset station

Storing a new station on a used number erases the previously stored one.

To be continued to the next page

See also
page 38.



Assigning Names to Preset Stations

You can assign a name of up to five characters to each preset station (from preset channel number 1 to 20). When a preset station is tuned in, its assigned name will appear on the display.

Tuning in a preset station

On the front panel:

1. Press **TUNER** so that the Control $\Delta / \nabla / \triangleleft / \triangleright$ buttons work for tuner settings. The lamp next to the button lights up.
2. Press Control Δ / ∇ until "PRESET+" appears on the display.
3. Press Control $\triangleleft / \triangleright$ to select a preset channel. Each time you press the button, the preset channels change.
 - Pressing Control \triangleleft changes preset channels in decreasing order.
 - Pressing Control \triangleright changes preset channels in increasing order.

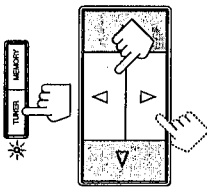

From the remote control:

1. Press **FM** or **AM**. Each time you press the button, the band alternates between FM and AM.
2. Open the outside panel of the remote control and press **PRESET CHANNEL +/-**.

To select a preset channel number directly, press 10 keys on the inside panel.

- For channel number 5, press 5.
- For channel number 15, press +10 then 5.
- For channel number 20, press +10 then 10.
- For channel number 30, press +10, +10, then 10.

Note: When you use the 10 keys on the remote control, be sure that they are activated for tuner, not for the CD and others. (See page 43).

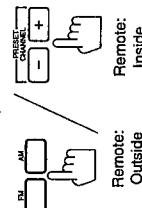

Selecting the FM Reception Mode

You can change the FM reception mode while listening an FM broadcast. You can also store the FM reception mode for each preset station. (See page 20).

On the front panel:

1. Press **TUNER** so that the Control $\Delta / \nabla / \triangleleft / \triangleright$ buttons work for tuner settings. The lamp next to the button lights up.
2. Press Control Δ / ∇ until "FM MODE" appears on the display.
3. Press Control $\triangleleft / \triangleright$ to select either "AUTO" or "MONO."
 - Normally select "AUTO."
 - When an FM stereo broadcast is hard to receive or noisy, select "MONO."

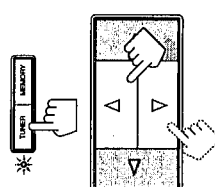

AUTO:	When a program is broadcast in stereo, you will hear stereo sound; when in monaural, you will hear monaural sounds. This mode is also useful to suppress static noise between stations. The MUTE AUTO indicator lights up on the display.
MONO:	Reception will be improved although you will lose the stereo effect. In this mode, you will hear noise while tuning into the stations. The MUTE AUTO indicator goes off on the display.

From the remote control:

Press **FM MODE/MUTE**. Each time you press the button, "AUTO" and "MONO" is alternately selected, and appears on the display.

Note: When using the FM MODE/MUTE button, be sure that the 10 keys are activated for tuner, not for the CD and others. (See page 43).

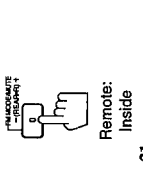

On the front panel only:

1. Tune in a preset station (preset channel number 1 to 20). See page 21 for details.
2. Press **MEMORY** (next to the **TUNER** button). The preset channel number starts flashing.

Note: If you press Control Δ / ∇ while the preset channel number is flashing, you can change the preset channel number.

3. Press Control \triangleright (or \triangleleft) until the first character position starts flashing.

4. Press Control Δ / ∇ to select a character. You can use characters listed below.

5. When a character you want appears, press Control \triangleright (or \triangleleft). The next (or previous) character position starts flashing.

6. Repeat steps 4 and 5 to enter up to five characters.
7. Press **MEMORY** (next to the **TUNER** button) again, while the last selected character is flashing, after you have assigned a name.

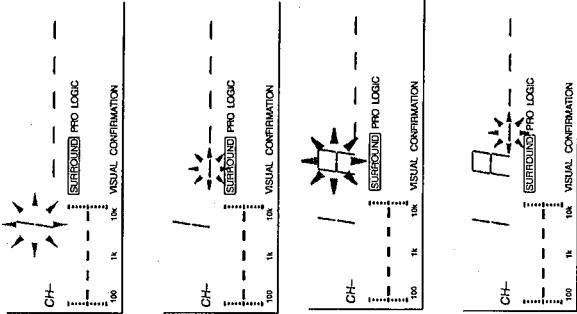

Front panel

To erase the input characters
Insert blanks using the same procedure described above.

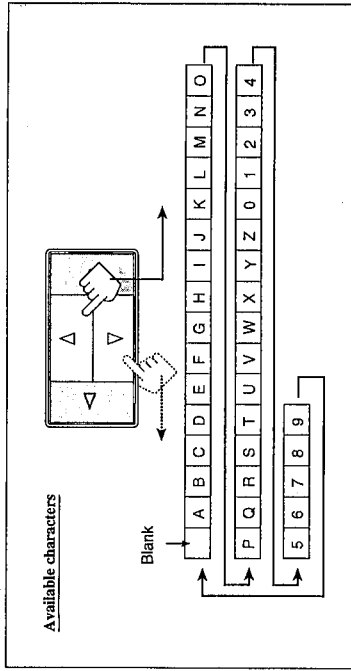

See also page 38.



Creating Your Own SEA Mode

You can adjust and store your own SEA adjustment into memory (USERMODE).

On the front panel only:

If you do not want to store your adjustment, but rather want to adjust the SEA temporarily, skip step 3 below.

1. Press SEA ADJUST so that the Control Δ / ∇ / \triangleleft / \triangleright buttons work for the SEA adjustment. The lamp next to the button lights up.

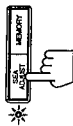

2. Adjust the SEA frequency and its level.
 - Press Control \triangleleft / \triangleright to select the frequency range to adjust.
 - Press Control Δ / ∇ to adjust the level.

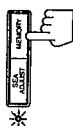
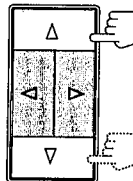
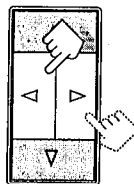
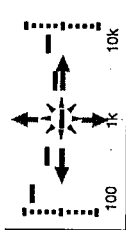

Front panel

3. Press MEMORY (next to the SEA ADJUST button). Your adjustment is stored into USERMODE.

To recall your own SEA adjustment
See page 23.

To erase a stored adjustment

Storing a new adjustment into USERMODE erases the previously stored one.

Using the SEA Modes

The SEA (Sound Effect Amplifier) modes give you control of the way your music sounds.

Note:
The SEA modes cannot be used for recording.

See also page 38.



Selecting Your Favorite SEA Mode

On the front panel:

1. Press SEA MODE so that the Control Δ / ∇ buttons work for selecting the SEA mode. The lamp next to the button lights up.
2. Press Control Δ / ∇ until the mode you want appears on the display. Each time you press the button, the SEA mode changes as follows:

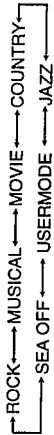

Note:
When the SEA mode is turned on, the SEA indicator lights up on the display.

ROCK:	Gives a heavy sound. Both high and low frequencies are boosted.
MUSICAL:	Enhance the mid-frequency range, which the human voice is mostly made up of.
MOVIE:	Adds breadth to sounds so you feel like you are in a movie theater.
COUNTRY:	Enhances the high-frequency range so that instruments such as the violin and banjo are emphasized.
JAZZ:	Gives a feeling of a live atmosphere. Good for acoustic music.
USERMODE:	Your original SEA adjustment (see page 24).
SEA OFF:	No SEA mode is applied (see below).

To cancel the SEA mode, press Control Δ / ∇ until "SEA OFF" appears in step 2 above. The SEA indicator goes off from the display.

From the remote control:

Press SEA MODE repeatedly until the SEA mode you want appears on the display. Each time you press the button, the SEA mode changes as follows:



Note:

When the SEA mode is turned on, the SEA indicator lights up on the display.

To cancel the SEA mode, press SEA MODE repeatedly until "SEA OFF" appears on the display. The SEA indicator also goes off.

Remote: Outside

Using the DAP Modes

The receiver can reproduce the sounds of the DVD player with its analog discrete output mode turned on. Moreover, the built-in digital surround processor provides two groups of programs — DAP (Digital Acoustic Processor) modes and surround modes (Dolby Surround and JVC Theater Surround).

You cannot use the DAP mode and surround mode at the same time. When you turn on the DAP mode, the surround mode is turned off (if it has been on), and vice versa.

- Notes:
- The digital surround processor has no effect on monaural sources.
 - The digital surround processor cannot be used for recording.

On the DAP mode

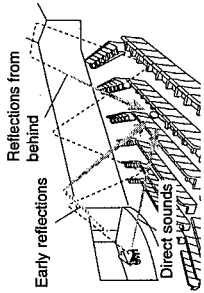

The sound heard in a concert hall or club consists of direct sound and indirect sound — early reflections and reflections from behind. Direct sounds reach the listener directly without any reflection. On the other hand, indirect sounds are delayed by the distances of the ceiling and walls. These direct sounds and indirect sounds are the most important elements of the acoustic surround effects. The DAP mode can create these important elements, and gives you a real "being there" feeling by using the front speakers and rear speakers.

On DVD multi playback mode

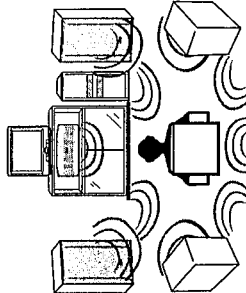

This receiver provides the DVD MULTI playback mode for reproducing the analog discrete output mode of the DVD player. The soundtracks of the movies are designed to sound best in movie theaters. This means they cannot be reproduced in a home environment as intended by movie-makers. With the introduction of the discrete multi-channel soundtracks of the DVD player, enables dynamic sound experiences of a movie theater in your home in the same way as intended by movie-makers.

To activate the DVD MULTI playback mode, you need to set the playing mode of the DVD player according to your speaker arrangement.

On surround mode

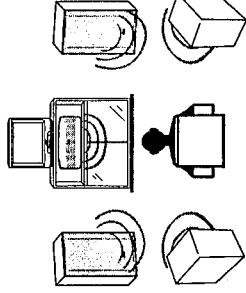

With this receiver, you can use two types of the surround mode.

Dolby Surround
Dolby Surround has been developed to reproduce the important elements of the acoustic surround at home. To watch the soundtracks of video software bearing the mark which includes the same encoded surround information as found in Dolby Stereo films, the receiver can provide you with 2 Dolby Surround modes (Dolby Pro Logic and Dolby 3ch Logic).
Dolby Pro Logic: Select this mode when optional center and rear speakers are connected.
Dolby 3ch Logic: Select this mode when a center speaker is connected without rear speakers.

JVC's Theater (1 and 2) Surround
In order to reproduce a more realistic sound field in your listening room while playing soundtracks of video software bearing the mark , JVC's Theater Surround has been designed to give you clearer vocals and to create a real "being there" feeling. The sound is reproduced through the front speakers, rear speakers, and center speaker.

* Manufactured under license from Dolby Laboratories Licensing Corporation. Additionally licensed under Canadian patent number 1,037,871. "Dolby," and the double-D symbol, "Pro Logic" are trademarks of Dolby Laboratories Licensing Corporation.

You can use five DAP modes — "Dance Club, Live Club, Hall, Pavilion, and Headphones." These modes (except "Headphones") require the front speakers and the rear speakers, but do not require a center speaker to enlarge the sound field.

Among the DAP modes, "Headphones" is very special. It can create the same stereo sound as you listen through the speakers off air while listening to a source using headphones. So, you can feel as if you were not using the headphones and listening to music in a room.

Note:
When you select "DVDMULTI" as the source to play, you cannot select the DAP mode.

On the front panel:

1. Press DAP/SURROUND MODE so that the Control Δ / ∇ / \triangleleft / \triangleright buttons work for selecting the DAP/surround modes.
The lamp next to the button lights up.
2. Press Control \triangleleft / \triangleright to select the DAP mode.
The DAP indicator lights up on the display.
Each time you press the button, the DAP and surround modes alternately comes into effect.

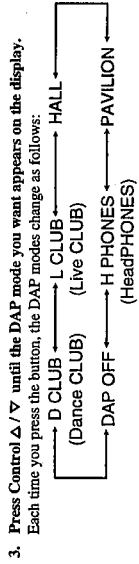

Dance CLUB	Gives a throbbing bass beat.
Live CLUB	Gives the feeling of a live music club with a low ceiling.
HALL	Gives clear vocal and the feeling of a concert hall.
PAVILION	Gives the spacious feeling of a pavilion with a high ceiling.
HeadPHONES*	Gives a spacious stereo effect when listening with headphones.
DAP OFF	No DAP mode is applied.

Note:
When you select "Headphones" (the \oplus PHONE indicator lights up), you cannot adjust the rear speaker output level in the following steps.

4. Press DAP/SURROUND/DVD MULTI ADJUST so that the Control Δ / ∇ / \triangleleft / \triangleright buttons work for adjusting the selected mode.
The lamp next to the button lights up.

5. Press Control Δ / ∇ until "REAR +" appears on the display.

6. Press Control \triangleleft / \triangleright to adjust the rear speaker output level.
• Pressing Control \triangleleft decreases the output level up to -10 dB.
• Pressing Control \triangleright increases the output level up to +10 dB.

Note:
You cannot adjust the left and right rear speaker output level separately.

7. Press Control Δ / ∇ until "EFFECT+" appears on the display.

8. Press Control \triangleleft / \triangleright to adjust the effect level.
Each time you press the button, the effect level changes as follows:



As the number increases, the selected DAP mode becomes stronger.

Note:
When you select "Headphones" (the \oplus PHONE indicator lights up), you cannot select "EFFECT 5."
To cancel the DAP mode, press Control Δ / ∇ until "DAP OFF" appears in step 3 above. The DAP indicator goes off from the display.

Activating the Surround Sounds

The receiver can reproduce the sounds of the DVD player with its analog discrete output mode turned on. Moreover, the built-in digital surround processor provides two groups of programs — DAP (Digital Acoustic Processor) modes and surround modes (Dolby Surround and JVC Theater Surround).

You cannot use the DAP mode and surround mode at the same time. When you turn on the DAP mode, the surround mode is turned off (if it has been on), and vice versa.

- Notes:
- The digital surround processor has no effect on monaural sources.
 - The digital surround processor cannot be used for recording.

On the DAP mode

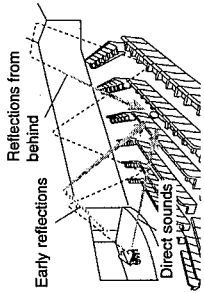

The sound heard in a concert hall or club consists of direct sound and indirect sound — early reflections and reflections from behind. Direct sounds reach the listener directly without any reflection. On the other hand, indirect sounds are delayed by the distances of the ceiling and walls. These direct sounds and indirect sounds are the most important elements of the acoustic surround effects. The DAP mode can create these important elements, and gives you a real "being there" feeling by using the front speakers and rear speakers.

On DVD multi playback mode

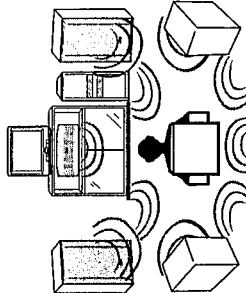

This receiver provides the DVD MULTI playback mode for reproducing the analog discrete output mode of the DVD player. The soundtracks of the movies are designed to sound best in movie theaters. This means they cannot be reproduced in a home environment as intended by movie-makers. With the introduction of the discrete multi-channel soundtracks of the DVD player, enables dynamic sound experiences of a movie theater in your home in the same way as intended by movie-makers.

To activate the DVD MULTI playback mode, you need to set the playing mode of the DVD player according to your speaker arrangement.

On surround mode

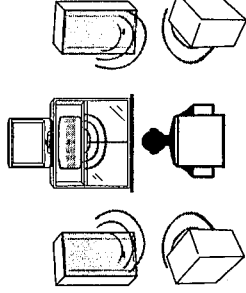

With this receiver, you can use two types of the surround mode.

Dolby Surround
Dolby Surround has been developed to reproduce the important elements of the acoustic surround at home. To watch the soundtracks of video software bearing the mark which includes the same encoded surround information as found in Dolby Stereo films, the receiver can provide you with 2 Dolby Surround modes (Dolby Pro Logic and Dolby 3ch Logic).
Dolby Pro Logic: Select this mode when optional center and rear speakers are connected.
Dolby 3ch Logic: Select this mode when a center speaker is connected without rear speakers.

JVC's Theater (1 and 2) Surround
In order to reproduce a more realistic sound field in your listening room while playing soundtracks of video software bearing the mark , JVC's Theater Surround has been designed to give you clearer vocals and to create a real "being there" feeling. The sound is reproduced through the front speakers, rear speakers, and center speaker.

* Manufactured under license from Dolby Laboratories Licensing Corporation. Additionally licensed under Canadian patent number 1,037,871. "Dolby," and the double-D symbol, "Pro Logic" are trademarks of Dolby Laboratories Licensing Corporation.

See also
page 38.



Using the DVD MULTI Playback Mode

This receiver provides the DVD MULTI playback mode for reproducing the analog discrete output mode of the DVD player.
Before playing back a DVD, refer also to the manual supplied with the DVD player.

Speaker arrangements for DVD MULTI playback

The following illustrations show how to obtain the optimum sound environment for the DVD MULTI playback mode. Try to find the speaker direction and location to create the optimum sound field.

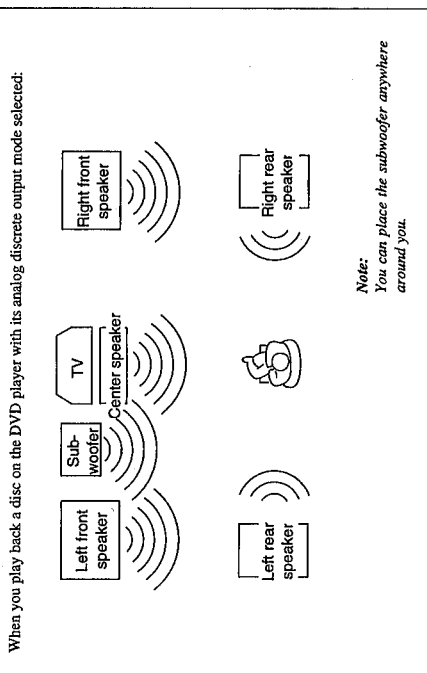

From the remote control:

1. Press **DAP MODE** until the **DAP** mode you want appears on the display.
The **DAP** indicator also lights up on the display.
Each time you press the button, the **DAP** modes change as follows:



Remote: Outside



Note:

When you select "Headphones" (the **H**PHONE indicator lights up), you cannot adjust the rear speaker output level in the following steps.

2. Open the outside panel and press **SOUND CONTROL** on the remote mode section.
The remote control is activated for sound adjustments.



3. Press **REAR (L) +/-** to adjust the rear speaker output level.
 - Pressing **REAR (L) -** decreases the output level up to -10 dB.
 - Pressing **REAR (L) +** increases the output level up to +10 dB.



Note:

You cannot adjust the left and right rear speaker output level separately.

4. Press **EFFECT** to adjust the effect level.
Each time you press the button, the effect level changes as follows:



Remote: Inside



As the number increases, the selected **DAP** mode becomes stronger.

Note:

When you select "Headphones" (the **H**PHONE indicator lights up), you cannot select "EFFECTS."

To cancel the **DAP** mode, press **DAP MODE** until "DAP OFF" appears.
The **DAP** indicator goes off from the display.

Activating the DVD MULTI playback

You can adjust the DVD MULTI playback mode while playing back a DVD using the analog discrete output mode on the DVD player.
Once you made adjustments, the receiver memorizes the adjustments until you change them. You also need to set the DVD player to the analog discrete output mode.

Note:

When you select "DVDMULTI" as the source to play, the **DAP** and **surround** modes are canceled temporarily.

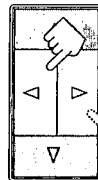
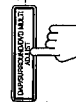

Front panel

On the front panel:

1. Press **DVD MULTI** so that "DVDMULTI" appears on the display.
The lamp above the button and the DVD lamp (of the source lamps) light up.
2. Select the analog discrete output mode on the DVD player, and start playing a DVD.
Refer to the manual supplied with the DVD player.
If you want to make any adjustment, go to the following steps.
3. Press **DAPSURROUND/DVD MULTI ADJUST** so that the Control $\Delta / \nabla / \triangleleft / \triangleright$ buttons work for adjusting the DVD MULTI playback mode.
The lamp next to the button lights up.
4. Press Control Δ / ∇ until "CENTER+" appears on the display.

To be continued to the next page

See also
page 39.



Using the Surround Modes

With this receiver, you can use two types of the surround mode — Dolby Surround and JVC Theater Surround

Speaker arrangements for surround mode

The following illustrations show how to obtain the optimum sound environment for surround modes. Try to find the speaker direction and location to create the optimum sound field.

CASE 1 When you have added a center speaker and rear speakers

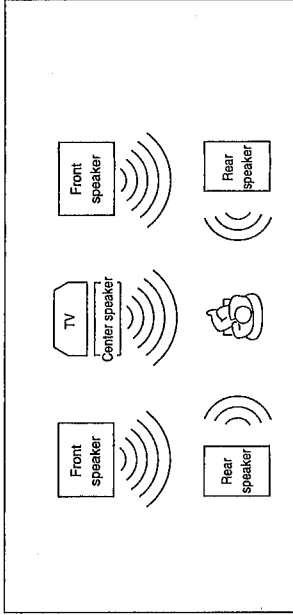

In this case:

1. Select "PROLOGIC," "THEATER1" or "THEATER2."
2. Select "NORMAL" or "WIDE" for center mode.

See pages 31 to 34 for more details.

CASE 2 When you have added rear speakers (without a center speaker)

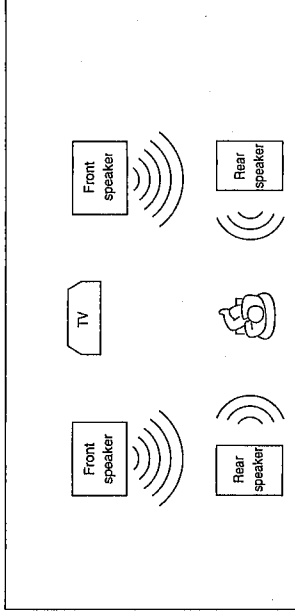

In this case:

1. Select "PROLOGIC," "THEATER1" or "THEATER2."
2. Select "PHANTOM" for center mode.

See pages 31 to 34 for more details.

CASE 3 When you have added a center speaker (without rear speakers)

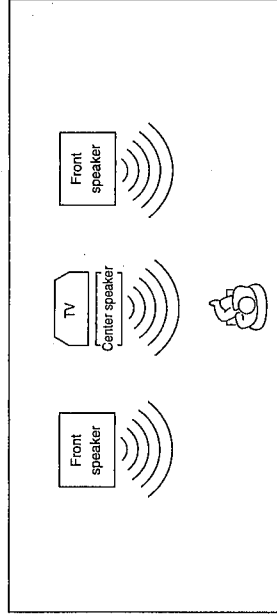

In this case:

1. Select "3CHLOGIC."
2. Select "NORMAL" or "WIDE" for center mode.

See pages 31 to 34 for more details.

5. Press Control \triangleleft / \triangleright to adjust the center speaker output level.
 - Pressing Control \triangleleft decreases the output level up to -10 dB.
 - Pressing Control \triangleright increases the output level up to +10 dB.

6. Press Control \triangle / ∇ until "REAR L+" appears on the display.
 - Pressing Control \triangleleft / \triangleright to adjust the left rear speaker output level.
 - Pressing Control \triangleleft decreases the output level up to -10 dB.
 - Pressing Control \triangleright increases the output level up to +10 dB.

7. Press Control \triangle / ∇ until "REAR R+" appears on the display.
 - Pressing Control \triangleleft / \triangleright to adjust the right rear speaker output level.
 - Pressing Control \triangleleft decreases the output level up to -10 dB.
 - Pressing Control \triangleright increases the output level up to +10 dB.

8. Press Control \triangle / ∇ until "CNT TONE" (Center Tone) appears on the display.

9. Press Control \triangleleft / \triangleright to select the center tone you want. The center tone adjustment affects the mid-frequency range, which the human voice is mostly made up of. Each time you press the button, the display changes to show the following:

SOFT2 \longleftrightarrow SOFT1 \longleftrightarrow FLAT \longleftrightarrow SHARP1 \longleftrightarrow SHARP2

To make the dialogue clearer, select "SHARP1" (little) or "SHARP2" (much).
To make the dialogue softer, select "SOFT1" (little) or "SOFT2" (much).
When "FLAT" is selected, no adjustment is applied.

From the remote control:

Note:
If you want to use the remote control for adjusting the center tone, use the menu function (see page 38).

1. Press DVD MULTI until "DVMULTI" appears on the display. The DVD MULTI lamp and the DVD lamp of the source lamps light up.
2. Select the analog discrete output mode on the DVD player, and start playing a DVD. Refer to the manual supplied with the DVD player.

If you want to make any adjustment, go to the following steps.

3. Open the outside panel and press SOUND CONTROL on the remote mode section. The remote control is activated for adjusting the sound.

4. Press CENTER +/- to adjust the center speaker output level.
 - Pressing CENTER - decreases the output level up to -10 dB.
 - Pressing CENTER + increases the output level up to +10 dB.

5. Press REAR (L) +/- to adjust the left rear speaker output level.
 - Pressing REAR (L) - decreases the output level up to -10 dB.
 - Pressing REAR (L) + increases the output level up to +10 dB.

6. Press (REAR-R) +/- to adjust the right rear speaker output level.
 - Pressing (REAR-R) - decreases the output level up to -10 dB.
 - Pressing (REAR-R) + increases the output level up to +10 dB.

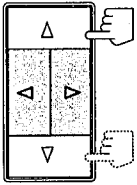
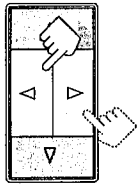
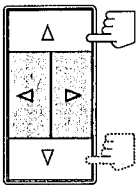

Front panel



Remote: Outside



Remote: Inside

Preparing for the surround mode

Once you have set the surround modes, you can use the same adjustment every time you want to activate the surround you want. The receiver memorizes surround adjustments for each mode.

Notes:

When you select "DVIDMULTI" as the source to play, you cannot select or adjust the surround mode.

On the front panel:

1. Press DAP/SURROUND MODE so that the Control $\Delta / \nabla / \triangleleft / \triangleright$ buttons work for selecting the DAP/surround modes. The lamp next to the button lights up.
2. Press Control $\triangleleft / \triangleright$ to select the surround mode. The SURROUND indicator lights up on the display. Each time you press the button, the DAP and surround modes alternately come into effect.
3. Press Control Δ / ∇ until the surround mode you want appears on the display. Each time you press the button, the surround modes change as follows (the indicator of the selected surround mode also lights up on the display):

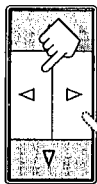
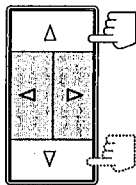

Front panel

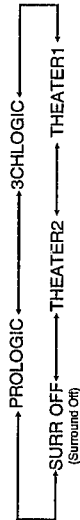

PROLOGIC	Select this mode to watch a video source with Dolby Surround when you have connected the rear speakers (and a center speaker).
3CHLOGIC	Select this mode to watch a video source with Dolby Surround when you have connected a center speaker and no rear speakers.
THEATER1	Select this mode to watch a video source with Dolby Surround when you have connected the rear speakers (and a center speaker). This mode gives you the feeling of a small movie theater with a seating capacity of 100.
THEATER2	Select this mode to watch a video source with Dolby Surround when you have connected the rear speakers (and a center speaker). This mode gives you the feeling of a large movie theater with a seating capacity of 1000.
SURR OFF	No surround mode is applied.

4. Press DAP/SURROUND/DVD MULTI ADJUST so that the Control $\Delta / \nabla / \triangleleft / \triangleright$ buttons work for adjusting the surround mode. The lamp next to the button lights up.

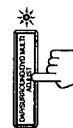

5. Press Control Δ / ∇ until "CNT MODE" (Center Mode) appears on the display.

6. Press Control $\triangleleft / \triangleright$ to select the center mode.

Each time you press the button, the center modes change as follows:

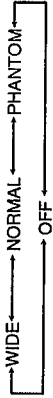

WIDE	Select this mode when the center speaker can reproduce the bass better than the front speakers. All signals of the center channel are output through the center speaker.
NORMAL	Select this mode when the center speaker cannot reproduce the bass better than the front speakers. The bass portions of the center channel signals are output through the front speakers.
PHANTOM	Select this mode when you do not use a center speaker. The center speaker channel signals are output through the front speakers.
OFF	Select this mode to turn off the center speaker channel.

Notes:

- If you have already set the "center speaker size" following the procedure described on page 17, you do not have to select the center mode in this procedure.
- When you have selected "3CHLOGIC," you cannot select "PHANTOM."

7. Press Control Δ / ∇ until "DELAY +*" appears on the display.
8. Press Control $\triangleleft / \triangleright$ to adjust the delay time of the rear speaker output. Each time you press the button, the delay time changes as follows:



DELAY 1	Select this when the distance from you to your rear speakers is greater than that to the front speakers.
DELAY 2	Select this when the distance from you to your rear speakers is almost equal to that to the front speakers.
DELAY 3	Select this when the distance from you to your rear speakers is a little less than that to the front speakers.
DELAY 4	Select this when the distance from you to your rear speakers is much less than that to the front speakers.

Note:

When you have selected "3CHLOGIC," you cannot adjust the delay time.

9. Press Control Δ / ∇ until "TEST" appears on the display, then press Control $\triangleleft / \triangleright$ to start checking the speaker output balance. "TEST" starts flashing on the display, and a test tone comes out of the speakers in the following order:

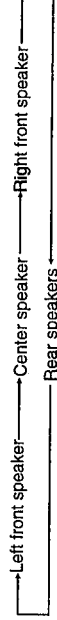

Notes:

- No test tone comes out of the rear speakers when you have selected "3CHLOGIC."
- No test tone comes out of the center speaker when you select "PHANTOM" or "OFF" for the center mode.

Front panel

To be continued to the next page

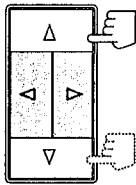
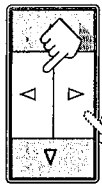

Front panel

10. If necessary, adjust the speaker output level as follows:

- To adjust the rear speaker output level, press Control Δ / ∇ until "REAR +" appears on the display, then press Control $\triangleleft / \triangleright$.
- To adjust the center speaker output level, press Control Δ / ∇ until "CENTER +" appears on the display, then press Control $\triangleleft / \triangleright$.

Notes:

- You cannot adjust the left and right rear speaker output level separately.
- You cannot adjust the rear speaker output level when you have selected "3CHLOGIC."
- You cannot adjust the center speaker output level when you select "PHANTOM" or "OFF" for the center mode.

11. Press Control Δ / ∇ until "TEST" appears on the display, then press Control $\triangleleft / \triangleright$ to stop the test tone.

12. Press Control Δ / ∇ until "CNT TONE" (Center Tone) appears on the display.

13. Press Control $\triangleleft / \triangleright$ to select the center tone you want.

The center tone adjustment affects the mid-frequency range, which the human voice is mostly made up of. Each time you press the button, the display changes to show the following:

SOFT2 \longleftrightarrow SOFT1 \longleftrightarrow FLAT \longleftrightarrow SHARP1 \longleftrightarrow SHARP2

To make the dialogue clearer, select "SHARP 1" (little) or "SHARP 2" (much).
To make the dialogue softer, select "SOFT 1" (little) or "SOFT 2" (much).
When "FLAT" is selected, no adjustment is applied.

Note:

The center tone cannot be adjusted when sounds do not come out of the center speaker.

If you have selected the JVC Theater Surround, go to the following steps.

14. Press Control Δ / ∇ until "--EFFECT+" appears on the display.

15. Press Control $\triangleleft / \triangleright$ to adjust the effect level.

Each time you press the button, the effect level changes as follows:



As the number increases, the surround mode becomes stronger.

Note:

When you have selected Dolby Surround, you cannot select the effect level.

From the remote control:

Note:

If you want to use the remote control for adjusting the center mode and the center tone, use the menu function (see page 39).

1. Press SURROUND MODE until the surround mode you want appears on the display.

The SURROUND indicator also lights up on the display. Each time you press the button, the surround modes change as follows (the indicator of the selected surround mode also lights up on the display):



2. Open the outside panel and press SOUND CONTROL on the remote mode section. The remote control is activated for adjusting the sound.

3. Press DELAY to adjust the delay time of the rear speaker output.

Each time you press the button, the delay time changes as follows:



Note:

When you have selected "3CHLOGIC," you cannot adjust the delay time.

4. Press TEST to start checking the speaker output balance.

"TEST" starts flashing on the display, and a test tone comes out of the speakers in the following order:

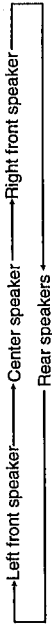

Notes:

- No test tone comes out of the rear speakers when you have selected "3CHLOGIC."
- No test tone comes out of the center speaker when you select "PHANTOM" or "OFF" for the center mode.

5. If necessary, adjust the speaker output level as follows:

- To adjust the rear speaker output level, press REAR +/-.
- To adjust the center speaker output level, press CENTER +/-.

Pressing - decreases the output level up to -10 dB.

Pressing + increases the output level up to +10 dB.

Notes:

- You cannot adjust the left and right rear speaker output level separately.
- You cannot adjust the rear speaker output level when you have selected "3CHLOGIC."
- You cannot adjust the center speaker output level when you select "PHANTOM" or "OFF" for the center mode.

6. Press TEST again to stop the test tone.

If you have selected the JVC Theater Surround, go to the following steps.

7. Press EFFECT to adjust the effect level.

Each time you press the button, the effect level changes as follows:



As the number increases, the surround mode becomes stronger.

Note:

When you have selected Dolby Surround, you cannot select the effect level.



Remote: Outside

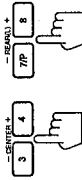

Remote: Inside

Listening at Low Volume (Loudness) (Also see page 15)

1. Press MENU.
The MAIN MENU appears on the TV.
 2. Press Δ / ∇ to move \square to "SETTING," then press \triangle / \triangleright .
The SETTING menu appears.
 3. Press Δ / ∇ to move \square to "LOUDNESS."
 4. Press \triangle / \triangleright to set the loudness function to "ON" or "OFF."
 5. When you finish, press MENU EXIT.
The menu disappears from the TV.
- Using the Sleep Timer** (Also see page 16)
1. Press MENU.
The MAIN MENU appears on the TV.
 2. Press Δ / ∇ to move \square to "SETTING," then press \triangle / \triangleright .
The SETTING menu appears.
 3. Press Δ / ∇ to move \square to "SLEEP TIMER."
 4. Press \triangle / \triangleright to set the shut-off time.
 5. When you finish, press MENU EXIT.
The menu disappears from the TV.

Selecting the Center Speaker Size (Also see page 17)

Note: When the surround mode is off, you cannot select the center speaker size.

1. Press MENU.
The MAIN MENU appears on the TV.
2. Press Δ / ∇ to move \square to "SETTING," then press \triangle / \triangleright .
The SETTING menu appears.
3. Press Δ / ∇ to move \square to "CENTER SFX" (Center Speaker).
4. Press \triangle / \triangleright repeatedly until the appropriate center speaker size is selected.
5. When you finish, press MENU EXIT.
The menu disappears from the TV.

Using Visual Confirmation (Also see page 18)

1. Press MENU.
The MAIN MENU appears on the TV.
2. Press Δ / ∇ to move \square to "SETTING," then press \triangle / \triangleright .
The SETTING menu appears.
3. Press Δ / ∇ to move \square to "VISUAL CONFIRM." (Visual Confirmation).
4. Press \triangle / \triangleright to set Visual Confirmation to "ON" or "OFF."
5. When you finish, press MENU EXIT.
The menu disappears from the TV.

Operating the Tuner

1. Press MENU.
The MAIN MENU appears on the TV.
2. Press Δ / ∇ to move \square to "TUNER," then press \triangle / \triangleright .
The TUNER menu appears.
3. Press Δ / ∇ to move \square to the item you want to set or adjust, then press \triangle / \triangleright .
On the TUNER menu, you can do the following:
"CH": Select a preset channel station. (See page 21)
If you want to assign a name to a preset channel, see page 22.
"BAND": Select the band. (See page 20)
"TUNING": Tune in a station manually. (See page 20)
"FM MODE": Select the FM reception mode. (See page 21)
4. When you finish, press MENU EXIT.
The menu disappears from the TV.

SETTING menu

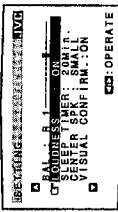

SETTING menu

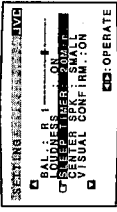

SETTING menu

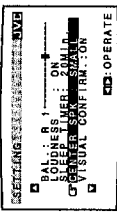

SETTING menu



TUNER menu

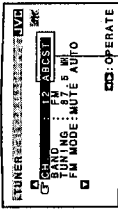

If you have assigned the name to this preset station, it appears here.

SEA MODE menu

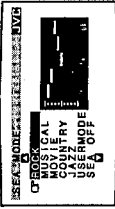

SEA ADJUST menu



DVD MULTI adjustment menu

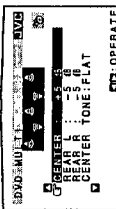

Adjusting the DVD MULTI Playback Mode (Also see page 28)

Before adjusting the DVD MULTI playback mode, you have to select "DYDMULTI" as the source to play.

1. Press MENU.
The MAIN MENU appears on the TV.
2. Press Δ / ∇ to move \square to "DYD/SURR/DAP ADJUST," then press \triangle / \triangleright .
The DVD MULTI menu appears.
3. Press Δ / ∇ to move \square to the item you want to set or adjust, then press \triangle / \triangleright .
On DVD MULTI adjustment menu, you can do the following:
"CENTER": Adjust the center speaker output level.
"REAR L": Adjust the left rear speaker output level.
"REAR R": Adjust the right rear speaker output level.
"CENTER TONE": Select the center tone.
4. When you finish, press MENU EXIT.
The menu disappears from the TV.

COMPU LINK Remote Control System

The COMPU LINK remote control system allows you to operate JVC audio components through the remote sensor on the receiver.
To use this remote control system, you need to connect JVC audio components through the COMPU LINK-3 (SYNCHRO) jacks (see below) in addition to the connections using cables with RCA pin plugs (see page 8).

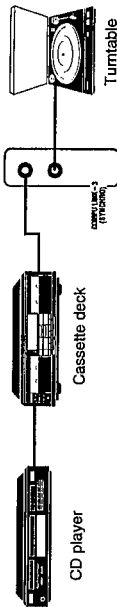

Notes:

- If your audio component has two COMPU LINK-3 (SYNCHRO) jacks, you can use either one. If it has only one COMPU LINK-3 (SYNCHRO) jack, connect it so that it is the last item in the series of components. (For example, the turntable or CD player in the diagram above.)
- Refer also to the manuals supplied with your audio components.

This remote control system allows you to use four functions listed below.

Remote Control through the Remote Sensor on the Receiver

You can control the connected audio components through the remote sensor on the receiver using this remote control. For details, see pages 43 and 44.

Note:

Aim the remote control directly at the remote sensor on the receiver.

Automatic Source Selection

When you press the play (▶) button on a connected component or on its own remote control, the receiver automatically turns on and changes the source to the component. On the other hand, if you select a new source on the receiver or the remote control, the selected component begins playing immediately.
In both cases, the previously selected source continues playing without sound for a few seconds.

Automatic Power On/Off (only possible with the COMPU LINK-3 connection)

Both the CD player and cassette deck turn on and off along with the receiver.
When you turn on the receiver, the CD player or cassette deck will turn on automatically, depending on which component has been previously selected.

When you turn off the receiver, both the CD player and cassette deck will turn off.

Synchronized Recording

Synchronized recording means the cassette deck starts recording as soon as a CD or a record begins playing.

To use synchronized recording, follow these steps:

- 1 Put a tape in the cassette deck, and a disc in the CD player (or a record on the turntable).
- 2 Press the record (●) button and the pause (⏸) button on the cassette deck at the same time. This puts the cassette deck into recording pause.

Note:

If you do not press the record (●) button and pause (⏸) button at the same time, the synchronized recording feature will not operate.

- 3 Press the play (▶) button on the CD player or on the turntable.

The source changes on the receiver, and as soon as play starts, the cassette deck starts recording. When the play ends, the cassette deck enters recording pause, and stops about 4 seconds later.

Notes:

- During synchronized recording, the selected source cannot be changed.
- If your CD player is playing in program mode, a 4-second blank is recorded between tracks so that the music scan feature of your cassette deck can be used on the recorded tape.
- If the power of any component is shut off during synchronized recording, the COMPU LINK remote control system may not operate properly. In this case, you must start again from the beginning.

Selecting the DAP or Surround Modes (Also see pages 26 and 30)

Note:

When the source is "DVMULTI", you cannot select the DAP or the surround mode.

1. Press MENU.
The MAIN MENU appears on the TV.

2. Press Δ / ▽ to move ◀ to "SURR/DAP," then press ◀ / ▷.
The DAP or SURROUND menu (previously selected mode) appears.

3. Press ◀ / ▷ to select either the surround or DAP mode.
The DAP MODE menu or SURROUND MODE menu appears.

4. Press Δ / ▽ to move ◀ to one of the DAP modes or surround modes.
If you want to adjust the selected mode, go to the following steps.

5. Press MENU.
The MAIN MENU appears on the TV again.

6. Press Δ / ▽ to move ◀ to "DVD/SURR/DAP ADJUST," then press ◀ / ▷.
The adjustment menu for the mode you have selected in step 4 appears.

7. Press Δ / ▽ to move ◀ to the item you want to set or adjust, then press ◀ / ▷.
On these adjustment menus, you can do the following:

For Dolby Pro Logic:

- "CENTER MODE": Select the center mode.
- "TEST": Output a test tone.
- "CENTER": Adjust the center speaker output level.
- "REAR": Adjust the rear speaker output level.
- "DELAY": Adjust the delay time of the rear speaker sound.
- "CENTER TONE": Select the center tone.

For Dolby 3ch Logic:

- "CENTER MODE": Select the center mode.
- "TEST": Output a test tone.
- "CENTER": Adjust the center speaker output level.
- "CENTER TONE": Select the center tone.

For JVC Theater Surround:

- "CENTER MODE": Select the center mode.
- "TEST": Output a test tone.
- "CENTER": Adjust the center speaker output level.
- "REAR": Adjust the rear speaker output level.
- "DELAY": Adjust the delay time of the rear speaker sound.
- "CENTER TONE": Select the center tone.
- "EFFECT": Adjust the effect level.

For DAP modes:

- "REAR": Adjust the rear speaker output level. (This cannot be adjusted for "Headphones.")
- "EFFECT": Adjust the effect level.

8. When you finish, press MENU EXIT.
The menu disappears from the TV.

DAP MODE menu

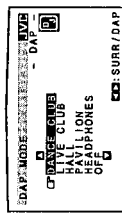

SURROUND MODE menu

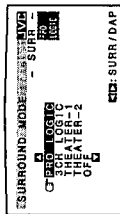

PRO LOGIC adjustment menu

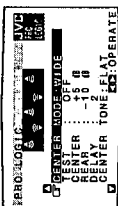

3CH LOGIC adjustment menu

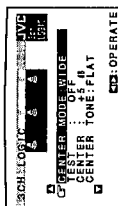

Theater Surround adjustment menu (eg. THEATER-1)

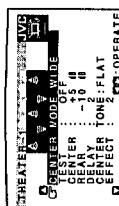

DAP mode adjustment menu (eg. DANCE CLUB)

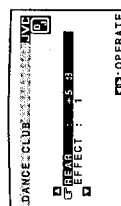

AV COMPULINK Remote Control System

The AV COMPULINK remote control system allows you to operate JVC video components (TV, VCR, and DVD player) through the receiver.

CONNECTIONS:

To use this remote control system, you need to connect JVC video components you want to operate, following the procedures below.

1. Connect your TV, VCR, and DVD player as follows, using the cable with the monaural mini-plug (not supplied).
2. Connect the audio input/output jacks on the VCR, DVD player, and TV using the cables with RCA pin plug. See pages 9 and 10.
3. Connect the video input/output jacks on the VCR, DVD player, and TV as follows using the cables with RCA pin plug or with S-video plug.

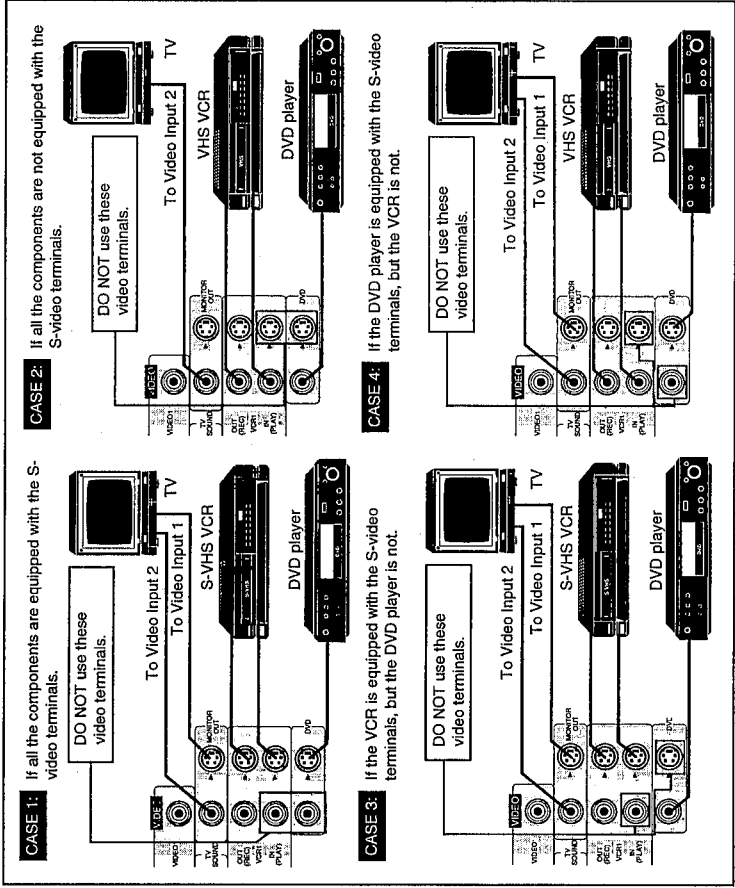
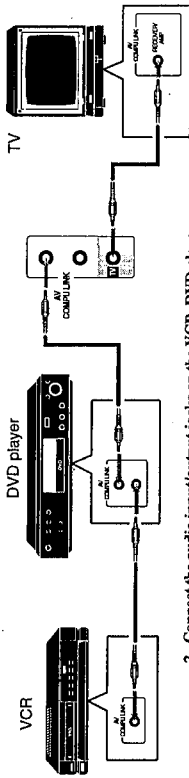

4. When turning on the TV for the first time after the AV COMPULINK connection, turn the TV volume to the minimum using the TV volume control on the TV.

FUNCTIONS:

This remote control system allows you to use five functions listed below.

Note:
Refer also to the manuals supplied with your video components.

- **Remote Control of the TV through the Remote Sensor on the Receiver**
You can control the TV through the remote sensor on the receiver using this remote control. For details, see page 46.

Note:
Aim the remote control directly at the remote sensor on the receiver when operating the TV. (However, to operate the VCR or DVD player, always aim the remote control directly at the remote sensor on the VCR or on the DVD player.)

- **One-Touch Video Play**
Simply by inserting a video cassette without its safety tab into the VCR1 (the VCR connected to the VCR1 jacks), you can enjoy the video playback without setting other switches manually. The receiver automatically turns on and changes the source to "VCR1." The TV automatically turns on and changes the input mode to the position so that you can view the playback picture. When you insert a video cassette with its safety tab, press the play (▶) button on the VCR1 or on the remote control. So, you can get the same result.

- **One-Touch DVD Play**
Simply by starting playback on the DVD player, you can enjoy the DVD playback without setting other switches manually. The receiver automatically turns on and changes the source to "DVD" or "DVDMULTI" — "DVD" is automatically selected when a disc played in stereo or the audio output setting of the DVD player is mixed to two front channels, while "DVD MULTI" is automatically selected when a disc played back using the analog discrete output mode on the DVD player. The TV automatically turns on and changes the input mode to the position so that you can view the playback picture.

- **Automatic Selection of TV's Input Mode**
 - When you select "TV SOUND" as the source to play on the receiver, the TV automatically changes the input mode to the TV tuner so that you can watch TV.
 - When you select "VIDEO1," "VIDEO2," or "TAPE/VCR" as the source to play on the receiver, the TV automatically changes the input mode to Video Input 2 so that you can watch the playback picture.
 - When you select "DVD," "DVDMULTI," or "VCR1" as the source to play on the receiver, the TV automatically changes the input mode to the appropriate position (either Video Input 1 or Video Input 2) so that you can view the playback picture.

Note:
When you select "TV SOUND" as the source on the receiver, you cannot see the on-screen displays (such as Visual Confirmation and the menu function) since the AV COMPULINK remote control system automatically changes the TV's input mode to the TV tuner. If you do not mind stopping listening to the TV sounds, you can then show the on-screen displays after changing the TV's input mode to the appropriate position (either Video Input 1 or Video Input 2) the receiver is connected to.

- **Automatic Power On/Off**
The TV, VCR1 (the VCR connected to the VCR1 jacks), and DVD player turn on and off along with the receiver. When you turn on the receiver:
 - If the previously selected source is "VCR1," the TV and VCR1 will turn on automatically.
 - If the previously selected source is "VIDEO1," "VIDEO2," or "TV SOUND," only the TV will turn on automatically.
 - If the previously selected source is "DVD" or "DVDMULTI," the TV and DVD player will turn on automatically.
 When you turn off the receiver, the TV, VCR1 and the DVD player will turn off.

Note:
If you turn off the receiver while recording on the VCR1, the VCR1 will not turn off, but continue recording.

Using the Remote Control

Using this remote control, you can operate audio/video components of not only JVC's but also the other manufacturers'. To operate the other manufacturers' components, see page 49.

Using the Remote Control for Operating JVC Audio/Video Components

IMPORTANT:

- To operate JVC audio components using this remote control:
 - You need to connect JVC audio components through the COMPU LINK-3 (SYNCHRO) jacks (see page 40) in addition to the connections using cables with RCA pin plugs (see page 8).
 - Aim the remote control directly at the remote sensor on the receiver.
 - Select a source with the buttons on the SOURCE SELECT section (outside panel) of the remote control, or press the buttons on the remote mode section (inside panel) of the remote control. If you select a source on the front panel, the remote control will not operate that source.

Tuner

After pressing FM or AM (on the SOURCE SELECT section of the outside panel) or TUNER (on the remote mode section of the inside panel), you can perform the following operations on the built-in tuner:

- 1 - 10, +10 Selects the preset channels directly.
 - For preset channel number 5, press 5.
 - For preset channel number 15, press +10, then 5.
 - For preset channel number 20, press +10, then 10.
 - For preset channel number 30, press +10, +10, then 10.
- FM MODE/MUTE Changes the FM reception mode.
- PRESET CHANNEL +/- Changes the preset channels.

Note:

To activate the remote control for tuner operations, you can use the FM button on the AM button on the SOURCE SELECT section or the TUNER button on the remote mode section. If you press the button on the remote mode section, you can operate the tuner using the remote control, but the playing source will not be changed to "FM" or "AM."

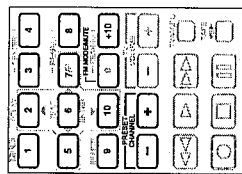

Remote: Inside

Sound control section (Amplifier)

You can always perform the following operations:

- DAP MODE: Changes the DAP modes.
- SURROUND MODE: Changes the surround modes.
- SEA MODE: Changes the SEA modes.

Remote: Outside

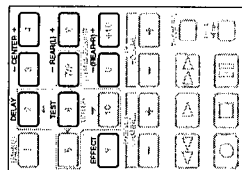

Remote: Inside

After pressing SOUND CONTROL on the remote mode section of the inside panel, you can perform the following operations:

- CENTER +/-: Changes the center speaker output level for the DVD MULTI playback and surround modes.
- REAR (L) +/-: Changes the left rear speaker output level for DAP and surround modes.
- (REAR-R) +/-: Changes the right rear speaker output level for the DVD MULTI playback mode.
- EFFECT: Changes the effect level for DAP and surround modes.
- DELAY: Changes the delay time for surround modes.
- TEST: Checks the speaker output level for surround modes.

Note:

After adjusting sounds, press the corresponding button on the remote mode section to operate your target source by using 10 keys; otherwise, 10 keys cannot be used for operating your target source.

CD player

After pressing CD (either on the SOURCE SELECT section of the outside panel or on the remote mode section of the inside panel), you can perform the following operations on a CD player:

- Starts playing.
- Returns to the beginning of the current (or previous) track.
- Skips to the beginning of the next track.
- Stops playing.
- Stops playing temporarily. To release it, press ►.
- 1 - 10, +10 Selects a track number directly.
 - For track number 5, press 5.
 - For track number 15, press +10, then 5.
 - For track number 20, press +10, then 10.
 - For track number 30, press +10, +10, then 10.

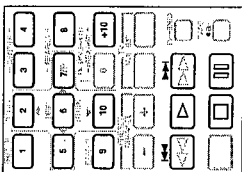

Remote: Inside

Note:

To activate the remote control for CD operations, you can use either one of the CD buttons — the one on the SOURCE SELECT section; the other on the remote mode section. If you press the one on the remote mode section, you can operate the CD player using the remote control, but the playing source will not be changed to "CD."

CD player-changer

After pressing CD DISC (on the remote mode section of the inside panel), you can perform the following operations on a CD player-changer:

- Starts playing.
- Returns to the beginning of the current (or previous) track.
- Skips to the beginning of the next track.
- Stops playing.
- Stops playing temporarily. To release it, press ►.
- 1 - 6, 7/P Select the number of a disc installed in a CD player-changer.

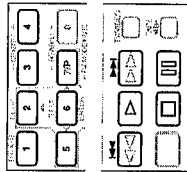

Remote: Inside

Cassette deck

After pressing TAPE/CR (on the SOURCE SELECT section of the outside panel) or TAPE (on the remote mode section of the inside panel), you can perform the following operations on a cassette deck:

- Starts playback.
- Fast winds the tape from right to left.
- Fast winds the tape from left to right.
- Changes the direction of tape running.
- Stops operation.
- Stops playing or recording temporarily. To release it, press ►.
- Press this button with ► to start recording.
- Press this button with II to enter the recording standby mode.

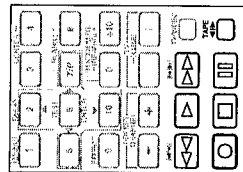

Remote: Inside

Note:

To activate the remote control for deck operations, you can use either the TAPE/CR button on the SOURCE SELECT section or the TAPE button on the remote mode section. If you press the button on the remote mode section, you can operate the cassette deck using the remote control, but the playing source will not be changed to "TAPE/CR."

Turntable

After pressing PHONO (on the SOURCE SELECT section), you can perform the following operations on a turntable:

- Starts playing.
- Stops playing.

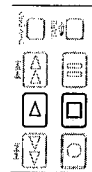

Remote: Inside

TV

After pressing TV SOUND (on the SOURCE SELECT section of the outside panel) or TV (on the remote mode section of the inside panel), you can also perform the following operations on the TV:

- 1-9, 0, +10 Selects the TV channels.
- +10 button functions as the 100+ button when selecting a channel number higher than 100.
- PRESET CHANNEL +/- Changes the TV channels.
- TV VOLUME +/- Changes the TV volume.

Notes:

- To activate the remote control for TV operations, you can use either the TV SOUND button on the SOURCE SELECT section or the TV button on the remote mode section. If you press TV on the remote mode section, you can operate the TV using the remote control, but the playing source will not be changed to "TV SOUND."
- You can always turn the TV on and off by pressing TV on the POWER section (outside panel) on the remote control.

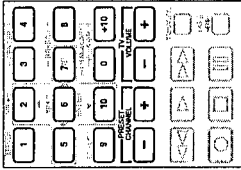

Remote: Inside

IMPORTANT:

- You need to connect JVC video components using this remote control: to the connections using cables with RCA pin plugs (see pages 9 and 10).
- Some JVC VCR can accept two types of the control signals — remote code "A" and "B." Before using this remote control, make sure that the remote control code of the VCR connected to the VCR1 jacks is set to code "A."
- When operating the VCR, aim the remote control directly at the remote sensor on the VCR.
- When operating the DVD player, aim the remote control directly at the remote sensor on the DVD player.
- When operating the TV, aim the remote control directly at the remote sensor on the receiver.
- Select a source with the buttons on the SOURCE SELECT section (outside panel) of the remote control, or press the buttons on the remote mode section (inside panel) of the remote control. If you select a source on the front panel, the remote control will not operate that source.

VCR

After pressing VCR1 (on the SOURCE SELECT section of the outside panel) or VCR (on the remote mode section of the inside panel), you can perform the following operations on a VCR:

- Starts playback
- Rewinds a tape
- Fast winds a tape
- Stops operation.
- Stops playing or recording temporarily. To release it, press ▶.
- Press this button with II to start recording.
- Press this button with III to enter the recording standby mode.
- Changes the TV channels on the VCR.
- Selects the TV channels on the VCR.
- 1-9, 0
- TV/VIDEO
- Switches the tuner output mode.

Notes:

- To activate the remote control for VCR operations, you can use either the VCR1 button on the SOURCE SELECT section or the VCR button on the remote mode section. If you press the one on the remote mode section, you can operate the VCR using the remote control, but the playing source will not be changed to "VCR1."
- You can always turn the VCR on and off by pressing VCR on the POWER section (outside panel) on the remote control.

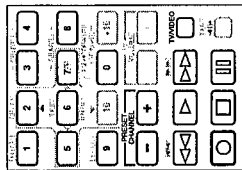

Remote: Inside

DVD player

After pressing DVD or DVD MULTI (on the SOURCE SELECT section of the outside panel) or DVD (on the remote mode section of the inside panel), you can perform the following operations on a DVD player:

- Starts playing.
- Returns to the beginning of the current track.
- Skips to the beginning of the next track.
- Stops playing.
- Stops playing temporarily. To release it, press ▶.

The following buttons can be used for the DVD menu operations.

MENU/ENTER/▲/▼/◀/▶

Note:

- To activate the remote control for DVD operations, you can use the DVD or DVD MULTI button on the SOURCE SELECT section and the DVD button on the remote mode section. If you press DVD on the remote mode section, you can operate the DVD player using the remote control, but the playing source will not be changed to "DVD" or "DVD MULTI."

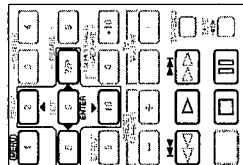

Remote: Inside

Simplifying the Operations Using the Remote Control

You can program and store a series of operations in a specific order you want. After making a program, you can perform these programmed operations at a press of the SEQUENTIAL PROGRAM KEY.

Programming a series of operations

You can make 3 different programs, each containing up to 16 steps.

- 1 Open the outside panel of the remote control.
- 2 Press LEARN so that the SEND/LEARN indicator lights up (green).
- 3 Close the outside panel.

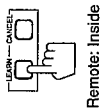

Remote: Inside

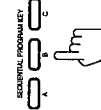

Remote: Outside

- 4 Press SEQUENTIAL PROGRAM KEY A, B, or C to which you want to assign a program you are making from now. The SEND/LEARN indicator starts flashing.

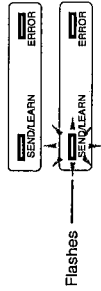

Note:

If the ERROR indicator lights up (red) while the SEND/LEARN indicator is flashing, you have already assigned a program to that SEQUENTIAL PROGRAM KEY. To add steps to the program, continue to step 5. If you do not want to change it, press another SEQUENTIAL PROGRAM KEY after the SEND/LEARN indicator stops flashing.

- 5 While the SEND/LEARN indicator is flashing, press the button you want to store as the first step of the program. Both the SEND/LEARN and ERROR indicators light up, and then only the ERROR indicator goes off.

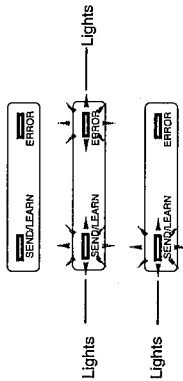

When the SEND/LEARN indicator goes off and starts flashing again, the first step is stored. The ERROR indicator lights up while the SEND/LEARN indicator is flashing.

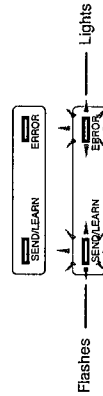

Note:

If the SEND/LEARN indicator stops flashing before you press the button, repeat from step 4 again.

- 6 Repeat steps 5 until you program up to 16 steps.

Notes:

- If the ERROR indicator flashes 3 times, you cannot program this step.
- 16 steps are already programmed or this particular step is not programmable.
- You cannot program an operation performed by pressing two buttons at the same time — like pressing ● and ▶ at the same time to start recording.
- Do not program a TV operation step immediately after the step of turning on the TV. The TV operation may be ignored since the TV is not yet ready to accept the signal.

- 7 Press LEARN again to finish the programming procedure. Both the SEND/LEARN and ERROR indicators go off.

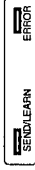

CAUTION:

When replacing the batteries, finish it without delay, otherwise, the stored signals are all erased.

Erasing a program

- 1 Open the outside panel of the remote control.

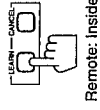

Remote: Inside

- 2 Press LEARN so that the SEND/LEARN indicator lights up (green).

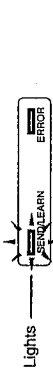

- 3 Press CANCEL. Both the SEND/LEARN and ERROR indicators light up.

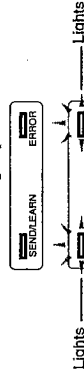

Remote: Outside

- 4 Close the outside panel, and press and hold SEQUENTIAL PROGRAM KEY A, B, or C to which the program you want to erase has been assigned to, until both the SEND/LEARN and ERROR indicators start flashing.

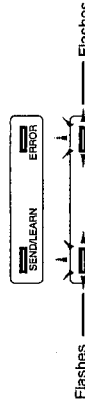

Note: If the ERROR indicator remains lit, no program is assigned to the SEQUENTIAL PROGRAM KEY. In this case, press CANCEL to turn off the ERROR indicator.

- 5 Press LEARN again to finish the erasing procedure. The SEND/LEARN indicator goes off.

Operating the Other Manufacturers' Audio/Video Components

The remote control supplied with the receiver can learn and memorize the signals used for the other manufacturers' remote control unit. By storing these signals, you can operate the other manufacturers' audio/video components.

Storing the signals

Before storing another manufacturer's signals, make sure that manufacturer's remote control unit (hereafter called "target remote control") actually works.

- 1 Place the two remote controls on a level surface with signal transmitting windows facing each other. Leave a space of 2 to 4 inches (5 to 10 cm) between the two remote controls; otherwise, storing may be failed.

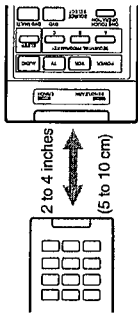

- 2 Open the outside panel of this remote control.
- 3 Press LEARN so that the SEND/LEARN indicator lights up (green).

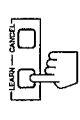

Remote: Inside

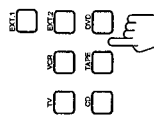

Remote: Inside

Buttons you can assign signals to

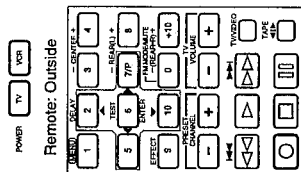

Remote: Inside

Using stored signals

When you want to use the stored signals, follow the procedure below.

- 1 Open the outside panel of the remote control.
- 2 Press one of the remote mode buttons.
- 3 Press the desired button.

Note: When you have stored signals into the TV and VCR buttons, simply pressing the button will send the stored signals. You do not have to press a remote mode button.

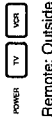

Remotes: Outside

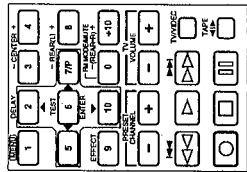

Remote: Inside

After several seconds, the SEND/LEARN indicator goes off and lights up again. This means that the storing is successfully finished.

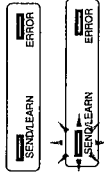

Lights

Notes:

- If the SEND/LEARN indicator stops flashing before you press the button on the target remote control, repeat from step 5 again.
- If the ERROR indicator lights red and does not go off, you have failed in storing the signal.
- If the ERROR indicator flashes, you have failed in storing the signal. Try again. However some signals do not match to this remote control even though this remote control can learn most infrared signals.

- 7 Repeat steps 5 to 6 to store more signals in the same remote mode.
- 8 Repeat steps 4 to 6 to store more signals in a different remote mode.

- 8 Press LEARN to finish the storing procedure.

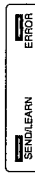

Note:

The signals stored into this remote control from the target remote control deviates slightly from the original signals. Since some components will not accept these deviating signals, you may not be able to operate those components using this remote control even though the storing procedure has been successfully finished.

CAUTION: When replacing the batteries, finish it without delay, otherwise, the stored signals are all erased.



Remote: Inside



Troubleshooting

Use this chart to help you solve daily operational problems. If there is any problem you cannot solve, contact your JVC service center.

PROBLEM	POSSIBLE CAUSE	SOLUTION
The display does not light up.	The power cord is not plugged in.	Plug the power cord into an AC outlet.
No sound from speakers.	Speaker signal cables are not connected. The SPEAKERS 1 and 2 buttons are not set correctly. An incorrect source is selected.	Check speaker wiring and reconnect if necessary. Press SPEAKERS 1 and 2 correctly. Select the correct source.
Sound from one speaker only.	Mute is activated. Speaker signal cables are not connected properly.	Press MUTE to cancel the mute. Check speaker wiring and reconnect if necessary.
Continuous hiss or buzzing during FM reception.	The balance is set to one extreme. Incoming signal is too weak. The station is too far away.	Adjust the balance properly. Connect an outside FM antenna or contact your dealer. Select a new station.
Occasional cracking noise during FM reception.	An incorrect antenna is used. Antennas are not connected properly.	Check with your dealer to be sure you have a correct antenna. Check connections.
The analog discrete output sound of the DVD player cannot be reproduced correctly.	Ignition noise from automobiles. An incorrect source is selected. The sound setting of the DVD player is incorrect.	Move the antenna farther from automobile traffic. Select "DVIDMULTI" as the source on the receiver. Check the sound setting of the DVD player.
No colors on the on-screen display.	The color system of the connected TV is not NTSC.	Connect an NTSC TV.
Howling during record playing.	Your turntable is too close to speakers.	Move speakers away from the turntable.
Remote control does not work.	Stored control signals are erased. There is an obstruction in front of the remote control sensor on the receiver. Batteries are weak.	Store the control signals again. Remove the obstruction. Replace batteries.

Erasing stored signals

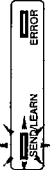
After erasing stored signals, preset signals are resumed and you can operate JVC's components again.

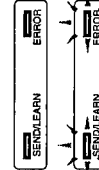
- 1 Open the outside panel of the remote control.
- 2 Press LEARN so that the SEND/LEARN indicator lights up (green).

- 3 Press CANCEL.
Both the SEND/LEARN and ERROR indicators light up.

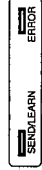
- 4 Press and hold the one of the buttons on the remote mode section until both the SEND/LEARN and ERROR indicators start flashing.
All the signals assigned in the selected remote mode are erased at the same time.
You cannot erase a signal assigned to a particular button only.

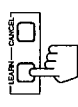
Note:
If the ERROR indicator remains lit, no signals are assigned to the buttons in the selected remote mode.
In this case, press CANCEL to turn off the ERROR indicator.

- 5 Press LEARN again to finish the erasure.
The SEND/LEARN indicator goes off.



Remote: Inside



Remote: Inside

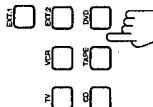

Remote: Inside

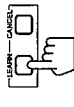

Remote: Inside

Specifications

Amplifier

Output Power At Stereo operation
At Surround operation Front Channels
Center channel
Rear channels

120 watts per channel, min. RMS, both channels driven into 8 ohms, 20 Hz to 20 kHz with no more than 0.02% total harmonic distortion.

120 watts per channel, min. RMS, driven into 8 ohms at 1 kHz with no more than 0.8% total harmonic distortion.

120 watts, min. RMS, driven into 8 ohms at 1 kHz, with no more than 0.8% total harmonic distortion.

60 watts per channel, min. RMS, driven into 8 ohms at 1 kHz, with no more than 0.8% total harmonic distortion.

0.02% * at 120 watts output
(* Measured by JVC Audio Analysis System)

Audio Input Sensitivity/Impedance (1 kHz)
PHONO (MM)
CD, TAPE/VCR, TV SOUND, VCR1, VIDEO1, VIDEO2, DVD (FRONT/CENTER/REAR/SUBWOOFER)

2.5 mV/47 k ohms
230 mV/47 k ohms

Audio Output Level
TAPE/VCR, VCR1
230 mV

Signal-to-Noise Ratio (86 IHF/78 IHF)
PHONO
CD, TAPE/VCR, TV SOUND, VCR1, VIDEO1, VIDEO2, DVD (FRONT/CENTER/REAR/SUBWOOFER)

70 dB/78 dB (at REC OUT)
91 dB/80 dB

Frequency Response (8 ohms)
PHONO
CD, TAPE/VCR, TV SOUND, VCR1, VIDEO1, VIDEO2, DVD (FRONT/CENTER/REAR/SUBWOOFER)

20 Hz to 20 kHz (±0.5 dB)
20 Hz to 20 kHz (±1 dB)

RIAA Phono Equalization
Loudness Control (Volume Control at -40 dB)
S.E.A.

±0.5 dB (20 Hz to 20 kHz)
+6 ±1 dB at 100 Hz
+4 ±1 dB at 10 kHz
100 Hz, 1 kHz, 10 kHz
±10 dB ±2 dB

Video

Video Input Sensitivity/Impedance
TAPE/VCR, VCR1, DVD, VIDEO1, VIDEO2
TAPE/VCR, VCR1, DVD

Composite video: 1 Vp-p/75 ohms
S-video (Y: luminance): 1 Vp-p/75 ohms
S-video (C: chrominance, burst): 0.286 Vp-p/75 ohms

Video Output Level
TAPE/VCR, VCR1, MONITOR OUT

Composite video: 1 Vp-p/75 ohms
S-video (Y: luminance): 1 Vp-p/75 ohms
S-video (C: chrominance, burst): 0.286 Vp-p/75 ohms

Synchronization
Signal-to-Noise Ratio
On-Screen Color System

Negative
45 dB
NTSC

FM tuner (IHF)

Tuning Range
87.5 MHz to 108.0 MHz

Usable Sensitivity
10.8 dBf (0.95 µV/75 ohms)

50 dB Quieting Sensitivity
16.3 dBf (1.8 µV/75 ohms)
38.3 dBf (22.5 µV/75 ohms)

Signal-to-Noise Ratio (IHF-A weighted)
80 dB at 85 dBf
75 dB at 85 dBf

Total Harmonic Distortion
0.15% at 1 kHz
0.2% at 1 kHz

Stereo Separation at REC OUT
40 dB at 1 kHz

Capture Ratio
1.5 dB at 85 dBf

Alternate Channel Selectivity
60 dB; (±400 kHz)

Frequency Response
30 Hz to 15 kHz; (+0.5 dB, -3 dB)

AM tuner

Tuning Range
530 kHz to 1,710 kHz

Usable Sensitivity
300 µV/m
30 µV

Signal-to-Noise Ratio
50 dB (100 mV/m)

General

Power Requirements
AC 120V_~, 60 Hz

Power Consumption
370 watts/500 V A
2 watts (in standby mode)

Dimensions (W x H x D)
17 7/8 x 6 3/16 x 16 1/4 inches
(455 x 156.5 x 412 mm)

Mass
25.1 lbs (11.4 kg)

Designs & specifications are subject to change without notice.

Description of Major LSIs

■ MN101C01DAB (IC401) : System controller

1. Terminal Layout

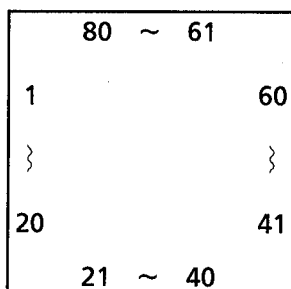

2. Description

Pin No.	Symbol	I/O	Description	Pin No.	Symbol	I/O	Description
1		--	GND	45	SEADATA	O	Data to IC551
2	VCR1 S/C	I	VCR1 composite detect signal	46	SEACLK	O	Clock to IC551
3	DVD S/C	I	DVD composite detect signal	47	4/8Ω SELLECT	O	4/8Ω select signal output
4	SYNCDET	I	VIDEO SYNCH. signal from IC204	48	4/8Ω DETECT	I	4/8Ω detect signal input
5~10		--	GND	49	DAP BUSY	I	BUSY signal from IC096
11	VDD	--	Power supply	50	DAP REQ	O	REQUEST signal for IC096
12	OSC2	--	Oscillation terminal	51	DAP RESET	O	RESET signal for IC096
13	OSC1	--	Oscillation terminal	52	M/CS	O	Chip select RX-882/RX-992
14	VSS	--	GND	53	MRESET	O	Reset signal to IC411
15	X1	--	GND	54	STATUS	I	Status signal from IC411
16	X0	--	Not used	55	COMMAND	O	Command data to IC411
17		--	GND	56	MCLK	O	Clock to IC411
18	DATA	O	Data to IC321,IC322,IC331,IC333,IC351,IC361	57	RVOLSTB	O	Strobe signal to IC333
19		--	GND	58	CVOLSTB	O	Strobe signal to IC361
20	CLK	O	Clock to IC321,IC322,IC331,IC333,IC351,IC361	59	FVOLSTB	O	Strobe signal to IC331
21~23		--	GND	60	ASWSTB	O	Strobe signal to IC321,IC322,IC351
24	SURON/OFF	O	Surround ON/OFF control	61	SMUTE	O	Source mute control
25	RESET	I	Reset signal input	62~64	CENT3~1	O	Center level control signal
26	TCE	O	Chip enable output	65	TUN/MEMI	O	TUN/MEMORY indication control
27	TCK	O	Clock signal output	66	SEAADJ/MEMI	O	SEAADJ/MEMORY indication control
28	IFDATA	I	Data signal from IC102	67	SEAI	O	SEA MODE indication control
29	TDATA	O	Data signal for IC102	68	SETI	O	SETTING indication control
30	TMUTE	O	Tuner mute control signal	69	ADJI	O	DAP/SURROUND/DVD MULTI ADJ indication control
31	TUNED	I	TUNED signal input	70	SUR/DAPI	O	DAP/SURROUND MODE indication control
32	STEREO	I	STEREO signal input	71	PHONOI	O	PHONO indication control
33		--	GND	72	CDI	O	CD indication control
34	MBUSY	I	Busy signal from IC411	73	AMI	O	AM indication control
35	INHIN	I	Inhibit signal input	74	FMI	O	FM indication control
36	OSD DATA	O	Data for IC203	75	TVSOUNDI	O	TV SURROUND indication control
37	OSD STB	O	Chip select signal for IC203	76	DVDI	O	DVD indication control
38	OSD CLK	O	Clock output for IC203	77	TAPE/VCRI	O	TAPE/VCR indication control
39~42	VIDEO1~4	O	VIDEO SELECT signal output	78	VCR1I	O	VCR1 indication control
43		--	GND	79	VIDEO2I	O	VIDEO2 indication control
44	VL/VH	O	RY881 control signal	80	VIDEO1I	O	VIDEO1 indication control

■ MN171602JAAN (IC411) : FL & System controller

1. Terminal Layout

VDD	1	64	OSC1
S16	2	63	OSC2
S15	3	62	VSS
S14	4	61	X2
S13	5	60	X1
S12	6	59	K10
S11	7	58	K11
S10	8	57	K12
S9	9	56	K13
S8	10	55	ONEI
S7	11	54	DVDMULTI
S6	12	53	STANDBYI
S5	13	52	
S4	14	51	TVC
S3	15	50	TVO
S2	16	49	VCR0
S1	17	48	DCSOUT
VPP	18	47	DCSIN
1G/KO0	19	46	VCR1
2G/KO1	20	45	RMI
3G/KO2	21	44	M/CS
4G/KO3	22	43	MRESET
5G/KO4	23	42	STATUS
6G	24	41	COMMAND
7G	25	40	MCLK
8G	26	39	MBUSY
9G/KO5	27	38	JOG1
10G	28	37	JOG2
11G	29	36	POWER
12G	30	35	17G
13G	31	34	16G
14G	32	33	15G

2.Key Matrix

	KEY IN 0 (PIN59)	KEY IN 1 (PIN58)	KEY IN 2 (PIN57)	KEY IN 3 (PIN56)
KEY OUT 0 (PIN19)	POWER (S401)	DVDMULTI (S401)	ONE TOUCH OPERATION (S403)	—
KEY OUT 1 (PIN20)	SEA MEMORY (S405)	SURROUND /DAP (S406)	AD JUST (S407)	SETTING (S408)
KEY OUT 2 (PIN21)	↑ (S409)	→ (S410)	SOURCE (S411)	SEA (S412)
KEY OUT 3 (PIN22)	↓ (S413)	← (S414)	SEA AD JUST (S415)	TUNER (S416)
KEY OUT 4 (PIN23)	TUNER MEMORY (S417)	—	—	—
KEY OUT 5 (PIN27)	—	C/J.C (D421)	882/992 (D422)	TUNER TEST (D423)

3. Description

Pin No.	Symbol	I/O	Description	Pin No.	Symbol	I/O	Description
1	V _{DD}	--	Power supply	45	RMI	I	Remote signal input
2~17	S16~S1	O	Segment control signal	46	VCR IN	I	AV compulink
18	V _{PP}	--	Power supply	47	DCS IN	I	Compulink signal input
19~23	1G/KO0~ 5G/KO4	O	Grid control signal / Key matrix output	48	DCS OUT	O	Compulink signal input
24~26	6G~8G	O	Grid control signal	49	VCR OUT	O	AV compulink
27	9G/KO5	O	Grid control signal / Key matrix output	50	TVO	O	AV compulink
28~35	10G~17G	O	Grid control signal	51	TVC	O	AV compulink
36	POWER	O	POWER ON/OFF control	52		--	Non connection
37	JOG2	I	Input 2 of JOG pulse	53	STANDBYI	O	STANDBY LED control signal
38	JOG1	I	Input 1 of JOG pulse	54	DVDMULTI	O	DVD MULTI LED control signal
39	MBUSY	O	Busy signal to IC401	55	ONEI	O	ONE TOUCH LED control signal
40	MCLK	I	Clock to IC401	56~59	K13~K10	I	Key matrix Input
41	COMMAND	I	Command data from IC401	60	X1		GND
42	STATUS	O	Status signal to IC401	61	X2	--	Not used
43	MRESET	I	Reset signal from IC401	62	VSS	--	GND
44	M/CS	I	Chip select RX-882/RX-992	63,64	OSC2,OSC1	--	Oscillation terminal

■ LC72131 (IC102) : PLL Synthesizer

1. Terminal Layout

XIN	1	22	XOUT
	2	21	VSS
PLLCE	3	20	LPF OUT
PLLDA	4	19	LPF IN
PLLCK	5	18	PD
IFDATA	6	17	VDD
<u>FM</u>	7	16	FM OSC
<u>MW</u>	8	15	AM OSC
<u>LW</u>	9	14	
AUTO/MONO	10	13	IF REQ
POWER	11	12	FM/AM IF

2. Block Diagram

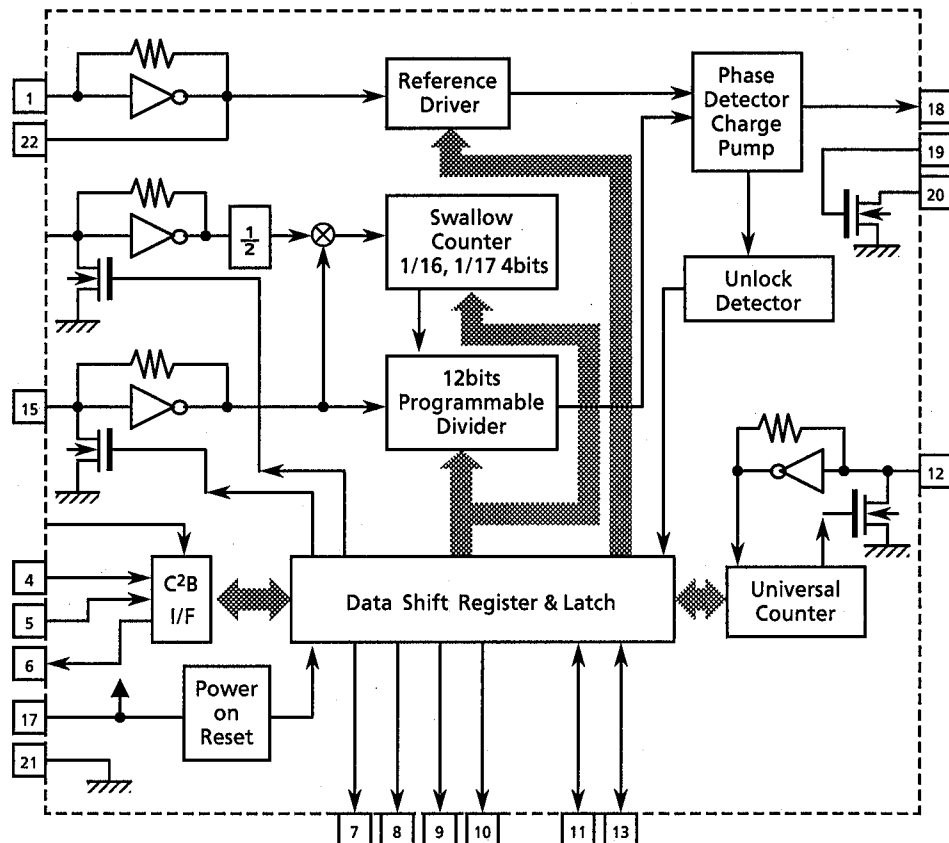

3. Pin Functions

Pin No.	Symbol	I/O	Functions	Pin No.	Symbol	I/O	Functions
1	X in	I	Crystal oscillator (7.2MHz).	12	FM/AM IF	I	Universal counter input
2		--	Not use	13	IF REQ	O	Output the "IF-signal request" to IC102
3	PLLCE	I	Fix the chip enable to "H" when inputting(DI) and outputting (DO) the serial data	14		I	Not use
4	PLLDA	I	Receive the control data from the controller (IC201).	15	AMOSC		Input the local oscillator signal of AM.
5	PLLCK	I	This clock is used to synchronize data when transmitting the data of DI and DO.	16	FM OSC	I	Input the local oscillator signal of FM.
6	IFDATA	O	Transmit the data from LC72131 to the controller which is synchronized with CK.	17	VDD	O	This is a terminal of power supply.
7	<u>FM</u>	O	It is "L" on FM mode.	18	PD	O	PLL charge pump output : When the local oscillator signal frequency is higher than the reference frequency high level signals will output. When it is lower than the reference frequency, low level signals will output. When it is same as reference frequency signals, it will be floating.
8	<u>MW</u>	O	It is "L" on MW mode.	19	LPF IN	I	Transistor used for the PLL active low-pass filter
9	<u>LW</u>	O	It is "L" on LW mode.	20	LPF OUT	O	Transistor used for the PLL active low-pass filter
10	<u>AUTO</u> <u>MONO</u>	O	It is "L" on monaural, "H" on auto.	21	VSS	--	Connected to GND
11	POWER	O	Regulator control signal PON "H", STANDBY "L"	22	X out	O	Crystal oscillator (7.2MHz).

■ LA1266A (IC104) : FM AM IF AMP & detector

1. The main function descriptions

- (1) Amplify and detect of FM intermodulation frequencies.
- (2) It has local oscillator and mixer for AM, and amplify the AM-IF signal.

2. Top View

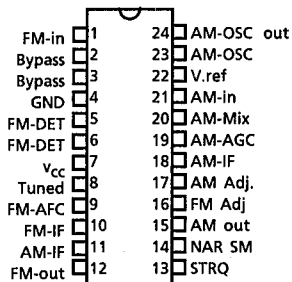

3. Block Diagram

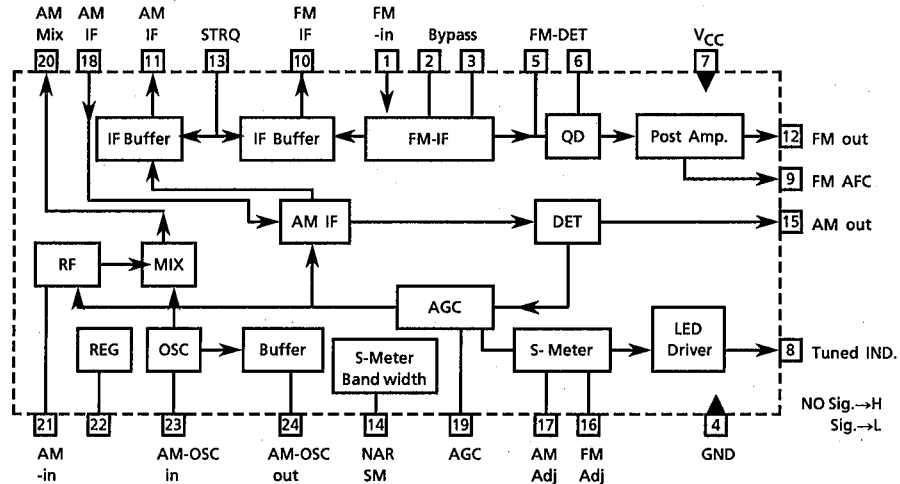

4. Pin Function Description

Pin No.	Symbol	I/O	Functions and Operations
1	FM in	I	This is an input terminal of FM IF Signal.
2, 3	Bypass	--	Bypass of FM IF Amp.
4	GND	--	This is the device ground terminal.
5, 6	FM DET	--	FM detect transformer.
7	V _{CC}	--	This is the power supply terminal.
8	Tuned	O	When the set is tuning, this terminal become "L".
9	FM AFC	O	This is an output terminal of voltage for FM - AFC.
10	FM IF out	O	When the IF REQ signal of IC251(LC7218) applies to pin13, the signal of FM IF outputs.
11	AM IF out	O	When the IF REQ signal of IC251(LC7218) applies to pin13, the signal of AM IF outputs.
12	FM out	O	FM detection output.
13	STRQ	I	The IF-signals come out from pin10 (FM-IF) or pin11 (AM-IF) while this terminal goes to "High".
14	NAR SM	--	Control the Band-width of AM signal meter.
15	AM out	O	AM detection output.
16	FM Adj	--	For adjust the stop level (or mute level) of FM.
17	AM Adj	--	For adjust the stop level (or mute level) of AM.
18	AM-IF	I	Input of AM IF Signal.
19	AM-AGC	I	This is an AGC voltage Input terminal for AM.
20	AM-MIX	O	This is an output terminal for AM mixer.
21	AM-IN	I	This is an input terminal for AM RF Signal.
22	V.REF	--	Control the Band-width of FM signal meter.
23	AM-OSC	--	This is a terminal of AM Local oscillation circuit.
24	AM-OSC out	O	AM Local Oscillation Signal output.

■ LA3401 (IC105) : FM MPX Detector

1. The main function descriptions

- (1) Detect the FM Multiplex Signal (Stereo signal).
- (2) When receiving FM Stereo Signal, it outputs the signal for indicator.
- (3) AM/FM Audio Amplifier.

2. Terminal Layout

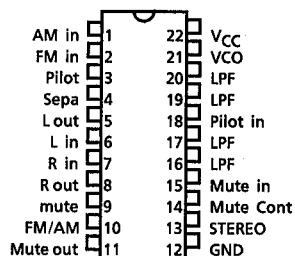

3. Block Diagram

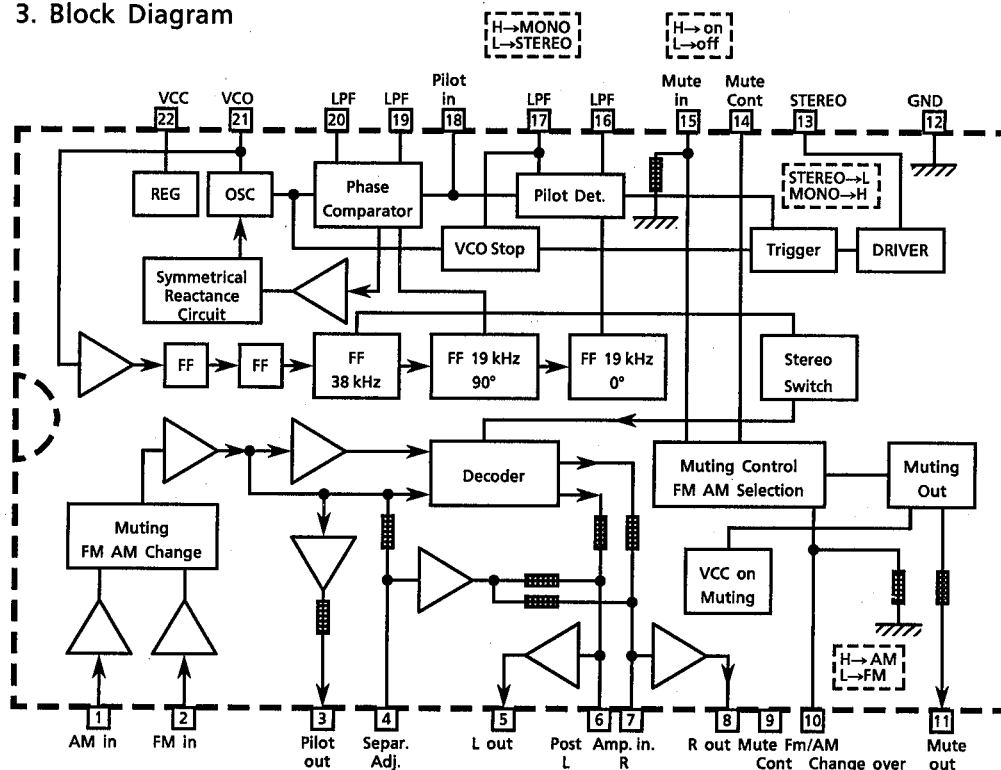

4. Pin Function Description

Pin No.	Symbol	I/O	Functions and Operations
1	AM in	I	This is an input terminal for AM detection signal.
2	FM in	I	This is an input terminal for FM detection signal.
3	Pilot out	O	Output of MPX pilot signal (Connect to Pin18).
4	Sepa. Adj.	--	Separation adjustment.
5	L. out	O	Left channel signal output.
6	L	O	Reversal output of Pin5.
7	R	O	Reversal output of Pin8.
8	R out	O	Right channel signal output
9	Mute Cont	--	The mute time is controlled by the connected capacitor when turning the power switch on.
10	FM / AM	I	Change over the FM / AM input. "H" : AM, "L" : FM
11	Mute out	--	Not use
12	GND	--	Ground terminal.
13	Stereo	O	Stereo indicator output. Stereo : "L", Mono : "H"
14	Mute Cont	--	The mute time is controlled by the connected capacitor when changing over the FM / AM .
15	Mute in	I	Mute signal input. "H" : Mute on, "L" : Mute off.
16	LPF	--	Low pass filter of pilot detector.
17	LPF	--	While this terminal goes to "H", the VCO stop.
18	Pilot in	I	Pilot input.
19	LPF	--	Low-pass filter of PLL.
20	LPF	--	Low-pass filter of PLL.
21	VCO	I	Voltage controlled oscillator terminal.
22	V _{CC}	--	Power supply.

■ TMP87C847U-4195 (IC096) : CMOS 8-bit Microcontroller

1. Terminal Layout

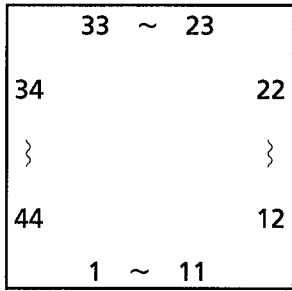

2. Block Diagram

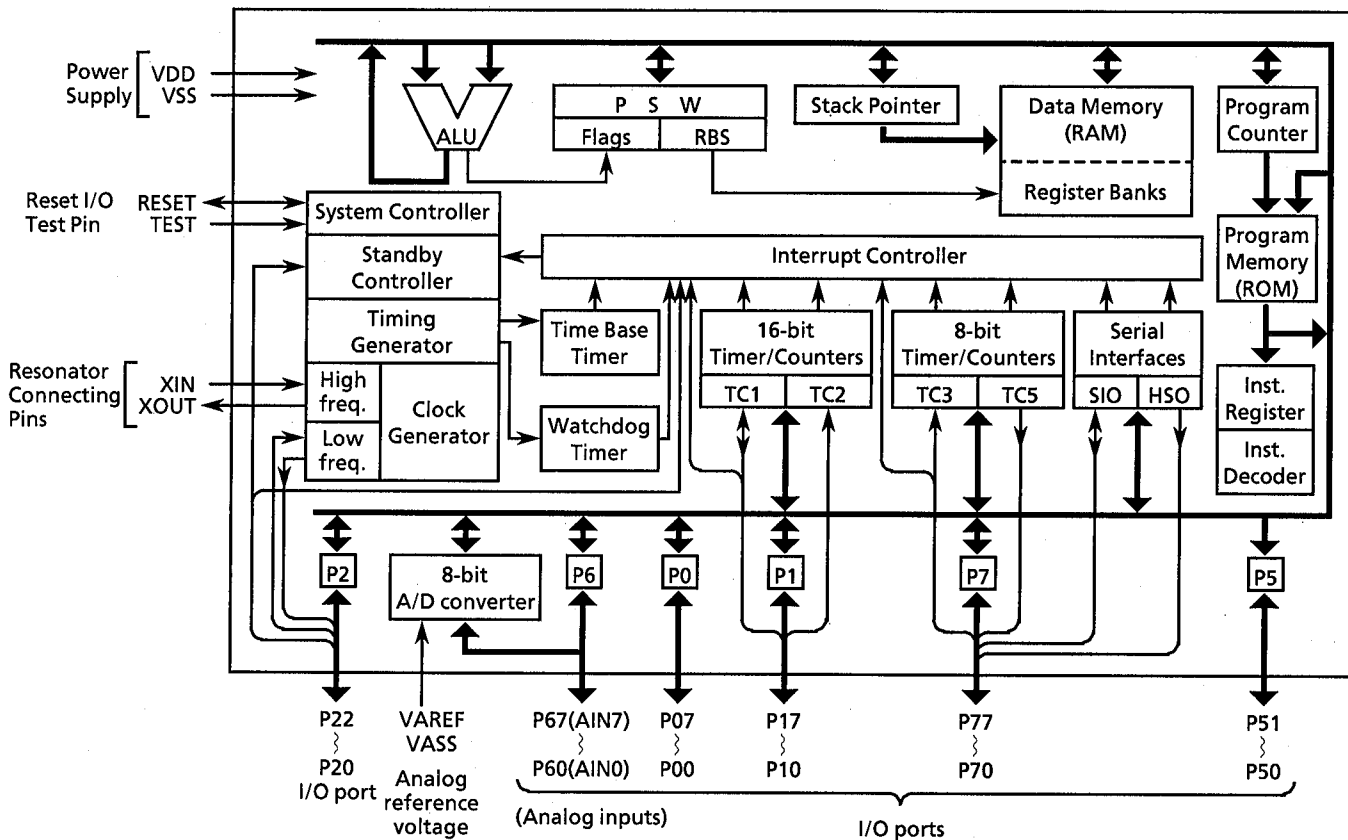

3. Pin Functions

Pin No.	Symbol	I/O	Functions
1	P73 (SCK)	I	Serial clock input from IC401
2	P72 (PWM/PDO)	I/O	Not used
3	P71 (INT4)	I/O	Not used
4	P70 (INT3/TC3)	I/O	Not used
5	P07 (ACK)	I	Acknowledge signal input from IC081
6	P06 (IFCD)	O	Command/data switching signal to IC081

Pin No.	Symbol	I/O	Functions
7	P05 ($\overline{\text{CS}}$)	O	Chip select signal output to IC081
8	P04 ($\overline{\text{RST}}$)	O	Reset signal output to IC081
9	P03 (TEST0)	I	Test terminal, generally it is used as "L"
10	P02 (TB2)	I	Test terminal, generally it is used as "L"
11	P01 (TB1)	I	Test terminal, generally it is used as "L"
12	P00 (TB0)	I	Test terminal, generally it is used as "L"
13	TEST	I	Test pin for out-going test. Be tied to low
14	$\overline{\text{RESET}}$	I	Reset signal input or watchdog timer output/address-trap-reset output/system-clock-reset output
15	XIN	I	Resonator connecting pins for high-frequency clock. For inputting external clock, XIN is used and XOUT is opened
16	XOUT	O	Not used
17	VSS	--	GND
18	VAREF	--	Analog reference voltage
19~26	P60 (AIN0)~ P67 (AIN7)	I/O	Not used
27	P50	O	Not used
28	P51 (MUTE)	O	Mute signal output
29	P10 (INT0)	I/O	Not used
30	P11 ($\overline{\text{REQ}}$)	I	External interrupt request signal from IC401
31	P12 ($\overline{\text{BUSY}}$)	O	Busy output to IC401
32	P13 (DVO)	I/O	Not used
33	P14 (PPG)	I/O	Not used
34	P15 (VOL STB)	O	Volume strobe signal output for write data to IC341
35	P16 (VOL SI)	O	Volume serial data signal output to IC341
36	P17 (VOL CK)	O	Volume clock output for data transfer to IC341
37	P20 (INT5/STOP)	I/O	Not used
38	P21 (XTIN)	I/O	Not used
39	P22 (XTOUT)	I/O	Not used
40	VDD	--	Power supply (5V)
41	P77 (IFDI)	O	Serial data output to IC081
42	P76 (IFCK)	O	Shift clock output to IC081
43	P75 (SO)	I/O	Not used
44	P74 (SI)	I	Serial data input from IC401

■ TC9332F-010 (IC081) : Audio digital signal processor

1. Terminal Layout

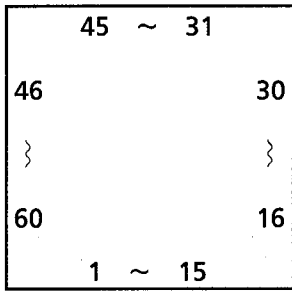

2. Block Diagram

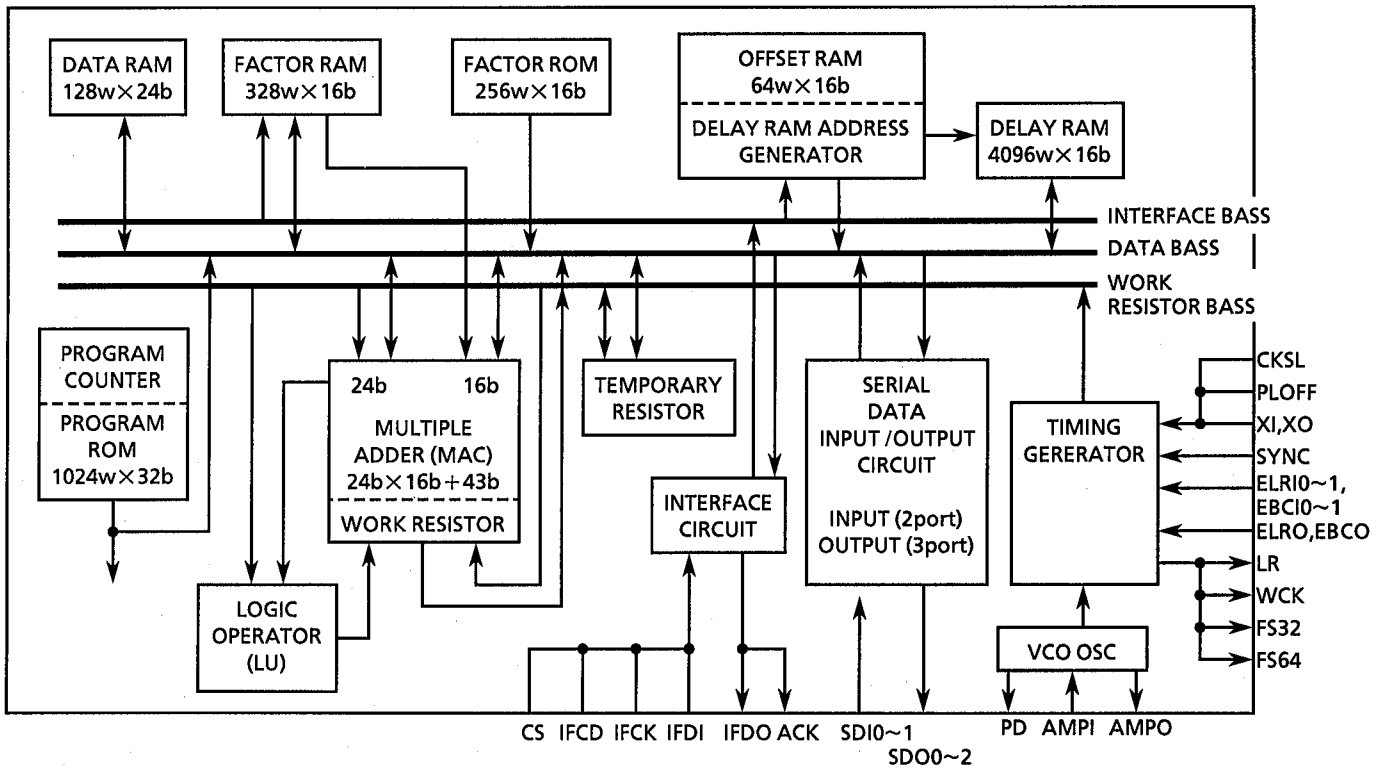

3. Pin Functions

Pin No.	Symbol	I/O	Functions
1~3	TP8~TP6	O	Test data output, Generally it is used as open
4	VDD	--	Power supply
5	VSS	--	GND
6~11	TP5~TP0	O	Test data output. Generally it is used as open
12	VSSR	--	GND for inner delay RAM (DLRAM)
13	VDDR	--	Power supply for inner delay RAM (DLRAM) (5V)
14	VSS	--	GND
15	SDO2	O	Not used
16	SDO1	O	Serial data output to IC061

Pin No.	Symbol	I/O	Functions
17	SDO0	O	Serial data output to IC041
18	SDI1	I	Not used
19	SDI0	I	Serial data input from IC021
20	LR	O	LR clock output (1fs)
21	WCK	O	Word clock output (2fs)
22	FS32	O	Bit clock output (32fs)
23	FS64	O	Bit clock output (64fs)
24	EBC0	I	Bit clock input. Shift clock input for SDO 0/1/2 data output
25	EBCI1	I	Bit clock input. Shift clock input for SDI 0/1 data input
26	EBCI0	I	Bit clock input. Shift clock input for SDI 0/1 data input
27	ELRO	I	LR clock input for SDO 0/1/2 data output
28	ELRI1	I	LR clock input for SDI 0/1 data input
29	ELRI0	I	LR clock input for SDI 0/1 data input
30	SYNC	I	Synchronizing signal input. SYNC signal edge sets program counter "0" forcefully. The microprocessor controls the polarity
31	VDD	--	Power supply (5V)
32	XI	I	X'tal oscillation terminal
33	XO	O	X'tal oscillation terminal
34	VSS	--	GND
35	CKSL	I	Oscillation clock switching terminal L:384fs, H:512fs
36	PLOFF	I	Oscillation mode switching terminal for 'Xtal and VCO. Built-in VCO oscillation mode in "L" and 'Xtal oscillation mode in "H"
37	PD	O	Phase comparison data output
38	VSSA	--	Analog GND
39	AMPO	O	Amplifier output for L.P.F
40	AMPI	I	Amplifier input for L.P.F
41	VDDA	--	Analog Power supply (5V)
42~44	TES0~TES2	I	Test terminal, Generally it is transmitted from μ -com when cs is lactive
45	$\overline{\text{RST}}$	I	Reset signal input from IC096
46	$\overline{\text{CS}}$	I	Chip select signal input from IC096
47	IFCD	I	It selects command or data input mode from IC096. It recognizes the command in "H" and the data in "L"
48	IFDI	I	μ -com data input. Firstly, LSB of data and command are received.
49	IFDO	O	Data output of data bass. LSB of data bus data is transmitted to μ -com
50	IFCK	I	Shift clock input form IC096
51	$\overline{\text{ACK}}$	O	Acknowledge signal output for IC096. Acknowledge signal is output when command and data's parity are OK
52	VSS	--	GND
53~60	TP16~TP9	O	Test data output. Generally, it is used as open

■ TDA1386T (IC041,061) : Noise shaping filter-DAC

1. Terminal Layout

VDDA	1	24	VDDO
VSSA	2	23	VSSO
TEST1	3	22	VREF
BCK	4	21	VOR
WS	5	20	FILTCLR
DATA	6	19	FILTCL
CKSL1	7	18	VOL
CKSL2	8	17	APP0
VSSD	9	16	APP1
VDDD	10	15	APP2
TEST2	11	14	APPL
SYSCLK	12	13	APP3

2. Block Diagram

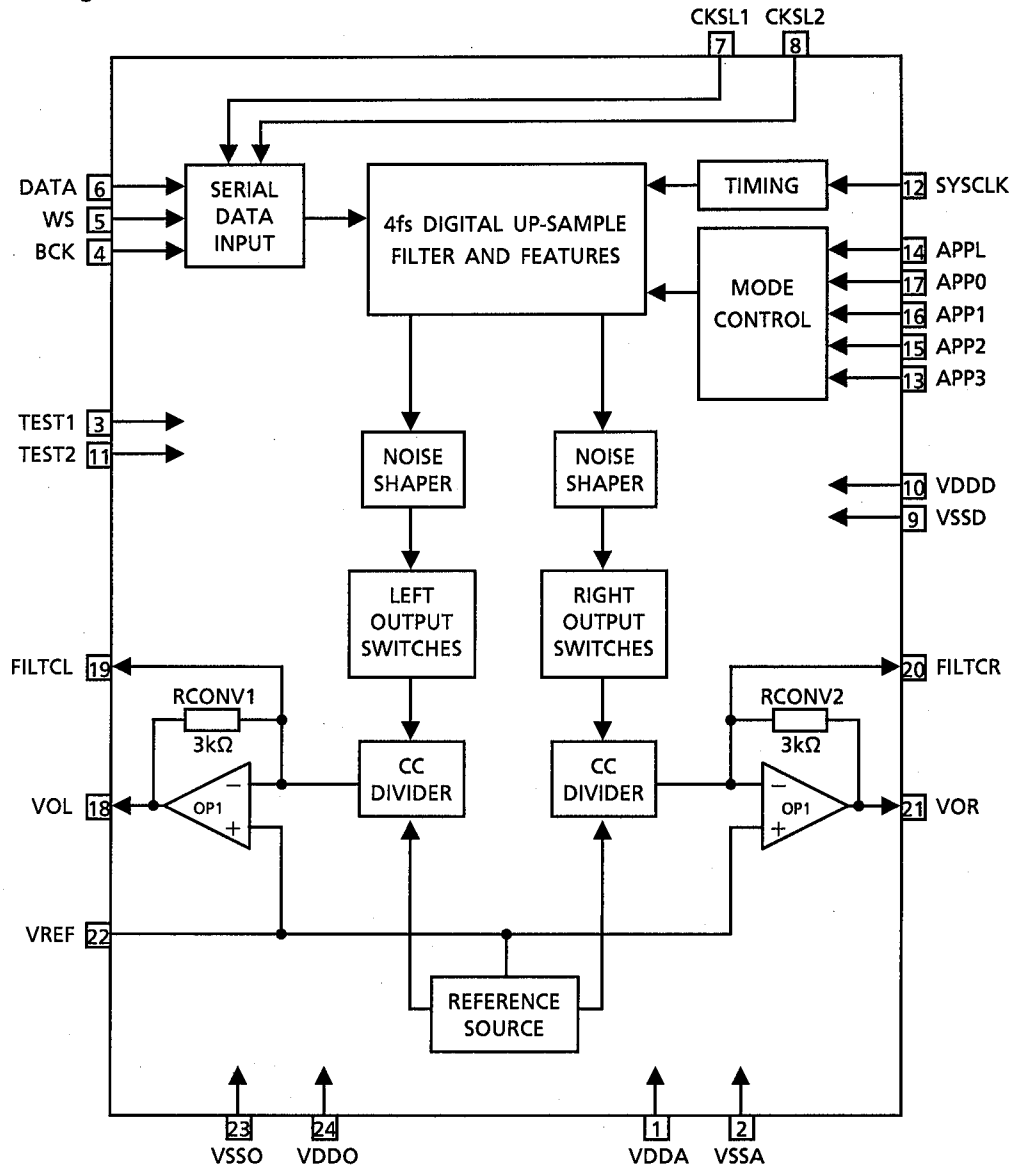

3. Pin Functions

Pin No.	Symbol	I/O	Functions
1	VDDA	--	Analog supply voltage (5V)
2	VSSA	--	Analog ground
3	TEST1	--	Test input 1 ; pin should be connected to ground
4	BCK	I	Bit clock input from IC081
5	WS	I	Word select input from IC081
6	DATA	I	Data input from IC081
7	CKSL1	I	Format selection 1
8	CKSL2	I	Format selection 2
9	VSSD	--	Digital ground
10	VDDD	--	Digital supply voltage (5V)
11	TEST2	--	Test input 2 ; pin should be connected to ground
12	SYSCLK	I	System clock 256fs input from IC093
13	APP3	I	Application mode 3 input
14	APPL	I	Application mode selection input
15	APP2	I	Application mode 2 input
16	APP1	I	Application mode 1 input
17	APP0	I	Application mode 0 input
18	VOL	O	Left channel output
19	FILTCL	O	Capacitor for left channel first-order filter function, should be connected between pins 19 and 18
20	FILTCR	O	Capacitor for right channel first-order filter function, should be connected between pins 20 and 21
21	VOR	O	Right channel output
22	VREF	--	Internal reference voltage for output channels (0.5 VDDO typ.)
23	VSSO	--	Operational amplifier ground
24	VDDO	--	Operational amplifier supply voltage (5V)

■ SAA7367T (IC021) : A/D Converter

1. Terminal Layout

SFOR	1	24	SLAVE
STDB	2	23	VDDA
OVLD	3	22	VREFL
CKIN	4	21	BIL
VDD	5	20	BOL
VSS	6	19	VDACP
SDO	7	18	VDACN
SWS	8	17	BOR
SCK	9	16	BIR
TEST 1	10	15	VREFR
HPEN	11	14	IREF
TEST B	12	13	VSSA

2. Block Diagram

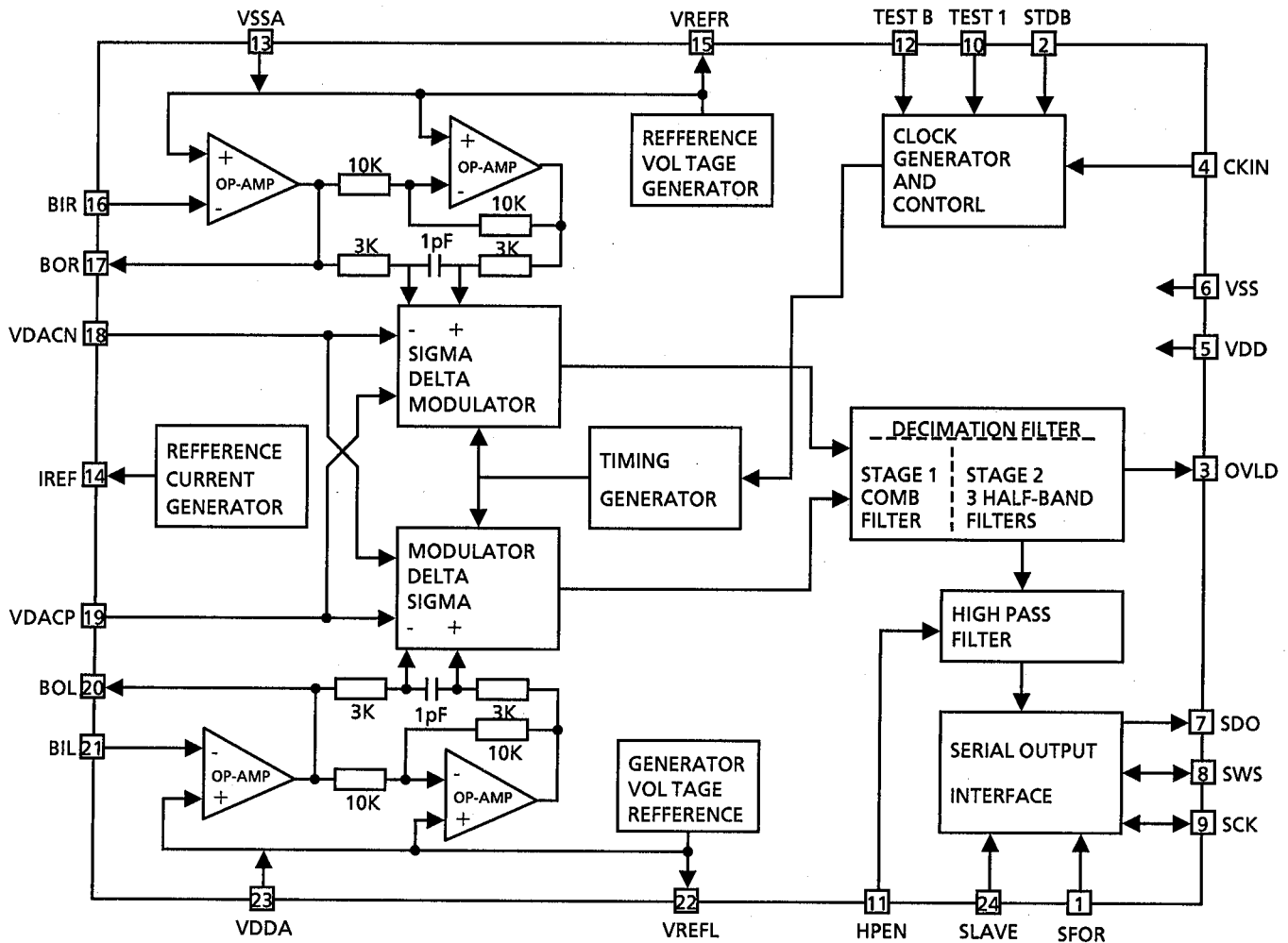

3. Pin Functions

Pin No.	Symbol	I/O	Functions
1	SFOR	I	Input for selecting serial interface output format. HIGH = Format 1 . LOW = Format 2
2	STDB	I	Input for selecting STANDBY mode HIGH = Normal operation LOW = STANDBY (Low power consumption)
3	OVLD	O	Overload indication output. This pin indicates whether the internal digital signal is within 1dB of maximum. In STANDBY mode this output is in high impedance
4	CKIN	I	System clock input from IC093
5	VDD	--	Supply for the digital section (5V)
6	VSS	--	Ground supply for the digital section
7	SDO	O	Serial interface data output to IC081. In STANDBY mode this output is in high impedance
8	SWS	I/O	Serial interface word select signal. This pin is the word select input to the serial interface.
9	SCK	I/O	Serial interface clock. This pin is the input for the external bit clock.
10	TEST1	I	Test input 1. This pin should be left open circuit
11	HPEN	I	High pass filter enable input. (HPEN HIGH = enabled). If unconnected this pin defaults HIGH
12	TESETB	I	Test input 2. This pin should be left open circuit
13	VSSA	--	Ground supply for the analogue section
14	IREF	--	Current reference mode
15	VREFR	--	VDDA/2 reference generator for the right channel analog section
16	BIR	I	Buffer op-amp inverting input for right channel
17	BOR	O	Buffer op-amp output for right channel
18	VDACN	I	Negative 1 bit DAC reference voltage input, normally connected to 0V
19	VDACP	I	Positive 1 bit DAC reference voltage input, normally connected to 5V
20	BOL	O	Buffer op-amp output for left channel
21	BIL	I	Buffer op-amp inverting input for left channel
22	VREFL	--	VDDA/2 reference generator for the left channel analog section
23	VDDA	--	Supply for the analog section (5V)
24	SLAVE	I	Input for selecting serial interface operating mode MASTER/SLAVE HIGH = SLAVE, LOW = MASTER If unconnected the pin will default LOW

■ UPC1860 (IC204) : Burst lock clock generator (Use for RX-992VBK only)

1. Terminal Layout

NC	1	36	SSI
CV _{CC} 1	2	35	NC
NC	3	34	VSSI
CIN	4	33	HDF
ACCF	5	32	OSD SINC
NC	6	31	HKO
CKF	7	30	S.GND
COUT	8	29	HSOF1
APCF	9	28	HSOF2
C.GND	10	27	HSOF3
SCOF1	11	26	AFCF
SCOF2	12	25	SVCC
SCOF3	13	24	NC
CV _{CC} 2	14	23	NH50
CV _{CC} 3	15	22	NC
VCO0	16	21	NC
NE	17	20	V50
ESC1	18	19	N/P

2. Block Diagram

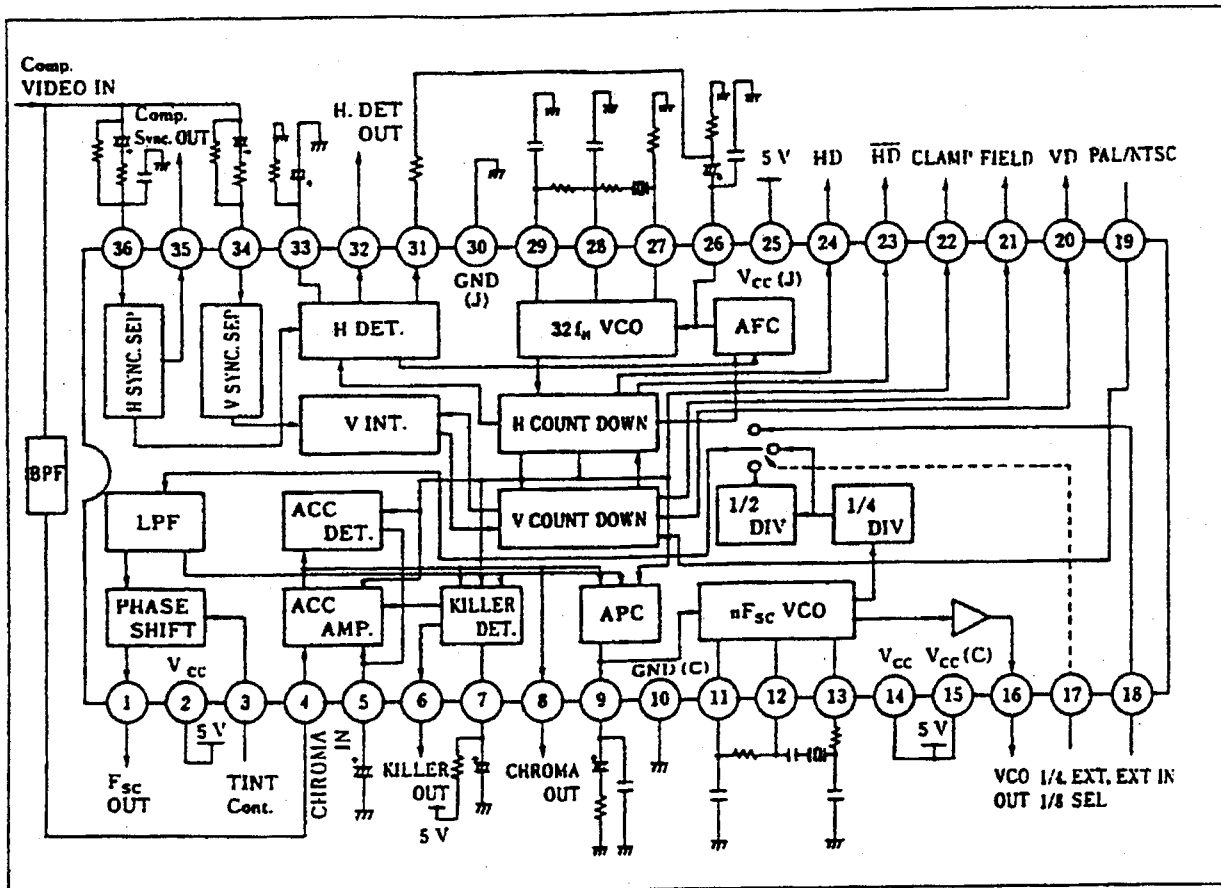

■ JCE8007 (IC203) : ON Screen display controller

1. Terminal Layout

YIN	1	28	AVSS
CIN	2	27	YOUT
VIN	3	26	COUT
AVCC	4	25	VOUT
FSCO	5	24	CS
VBLK	6	23	SIN
VCC	7	22	SCLK
EXS	8	21	TEST
XS	9	20	VOC0
HSYNC	10	19	VOC1
VSYNC	11	18	VOC2
EXHSYN	12	17	VOB
EXVSYN	13	16	XD
VSS	14	15	EXD

2. Block Diagram

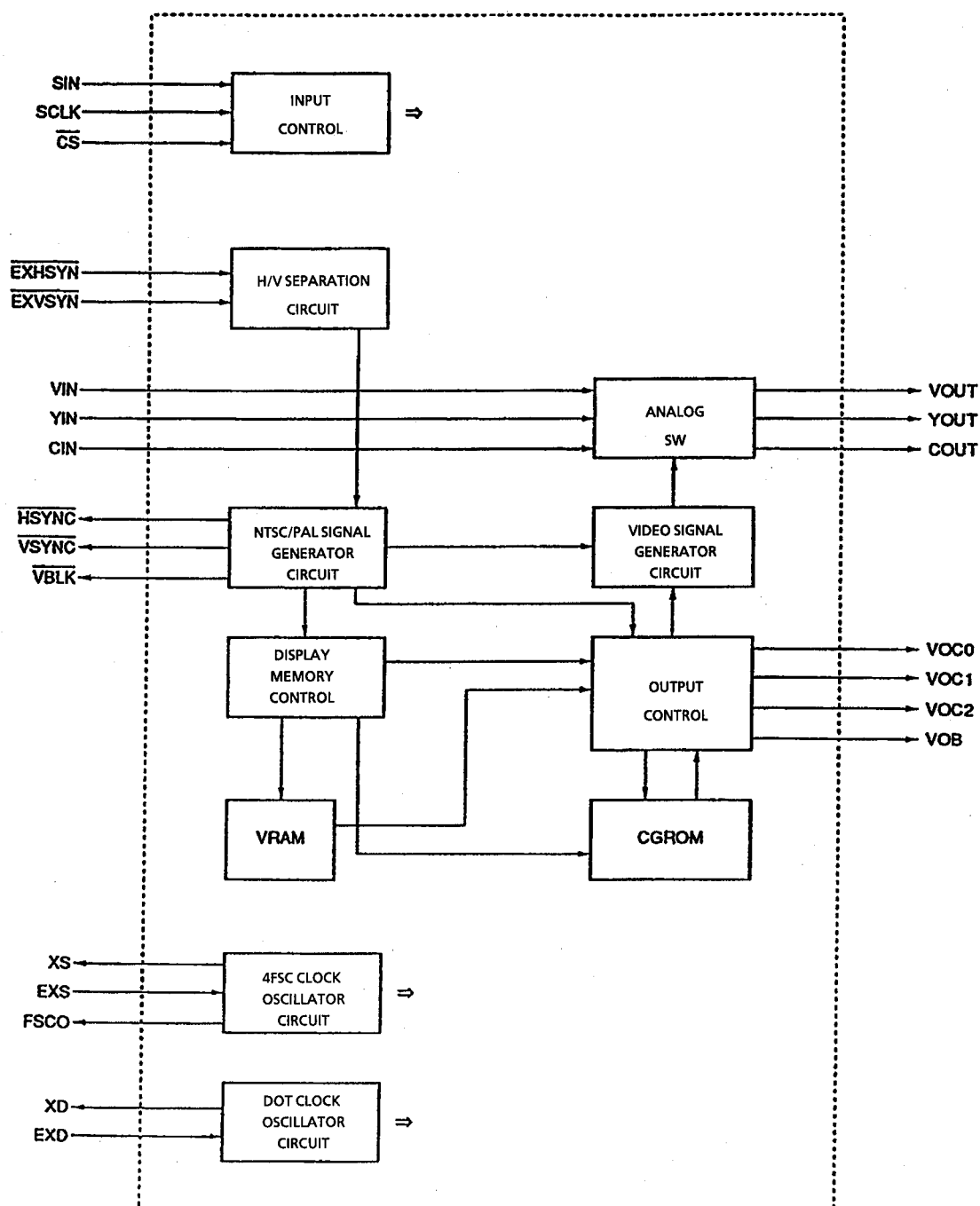

■ NJM2279D (IC211,212) : Video Switch (Use for RX-992VBK only)

1. Terminal Layout

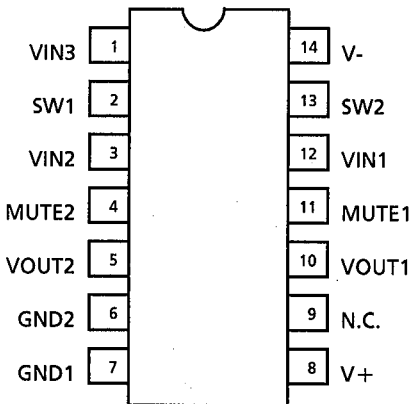

2. Block Diagram

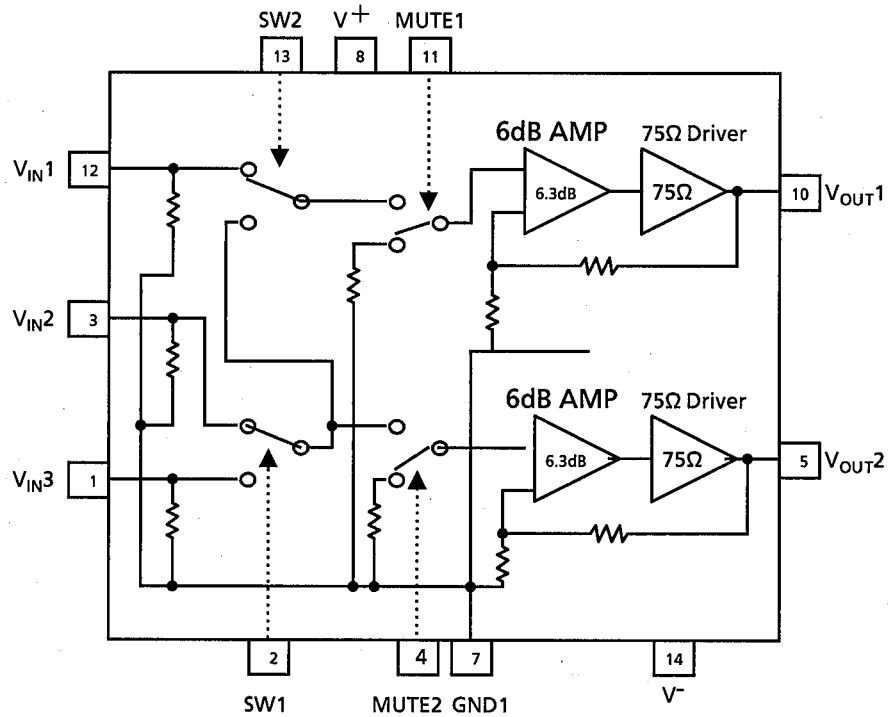

■ TC74HC00A (IC205) : 2 CH NAND Gate (Use for RX-992VBK Only)

1. Terminal Layout

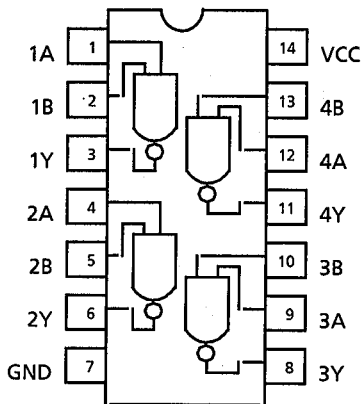

2. Pin Function

A	B	Y
L	L	H
L	H	H
H	L	H
H	H	L

■ BA7604N (IC202) : Video Audio Switcher

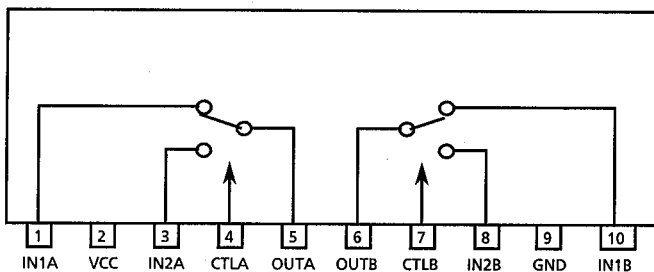

■TC9162N,TC9163N, TC9164N : Analog Switch

1.Functions

These analog switches are controlled by 14 bit serial data from computer for selecting the source.

2.Terminal Layout & Block diagram

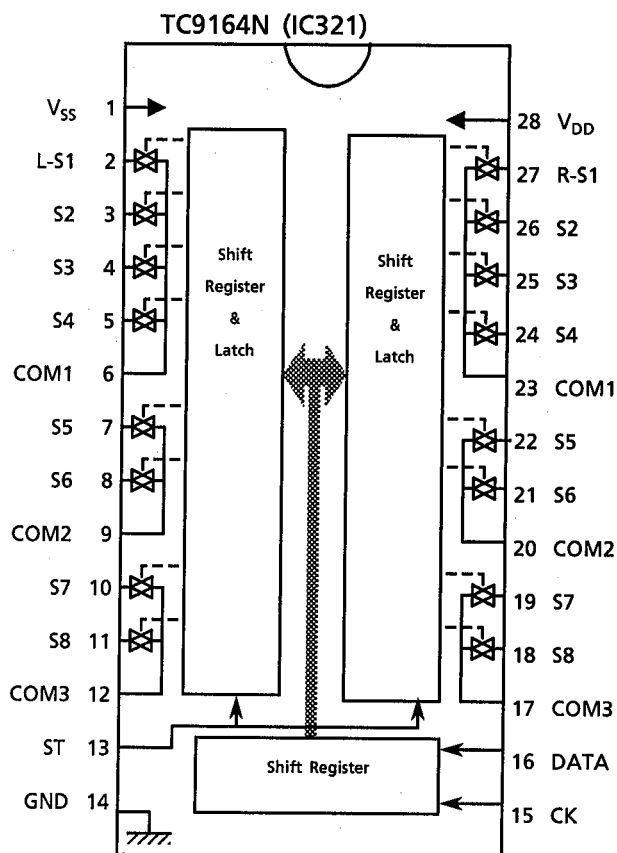
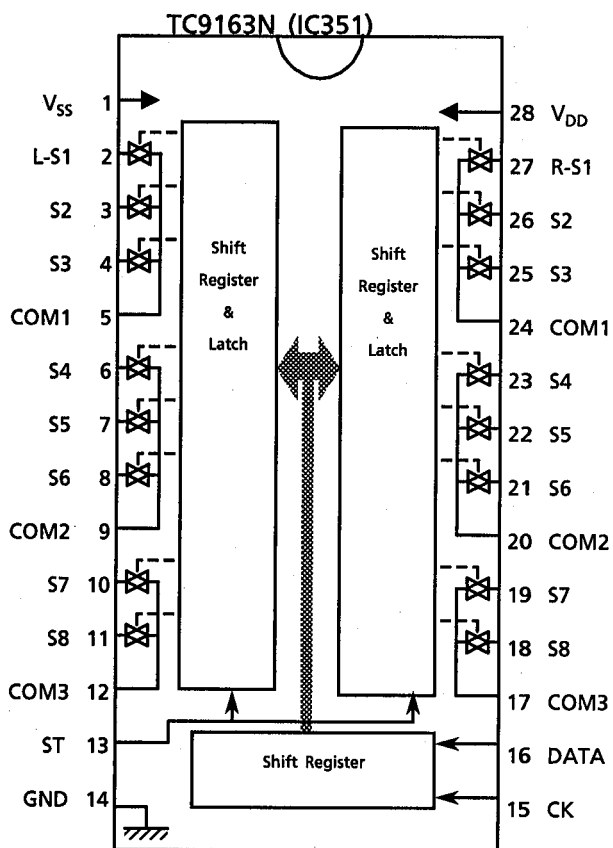
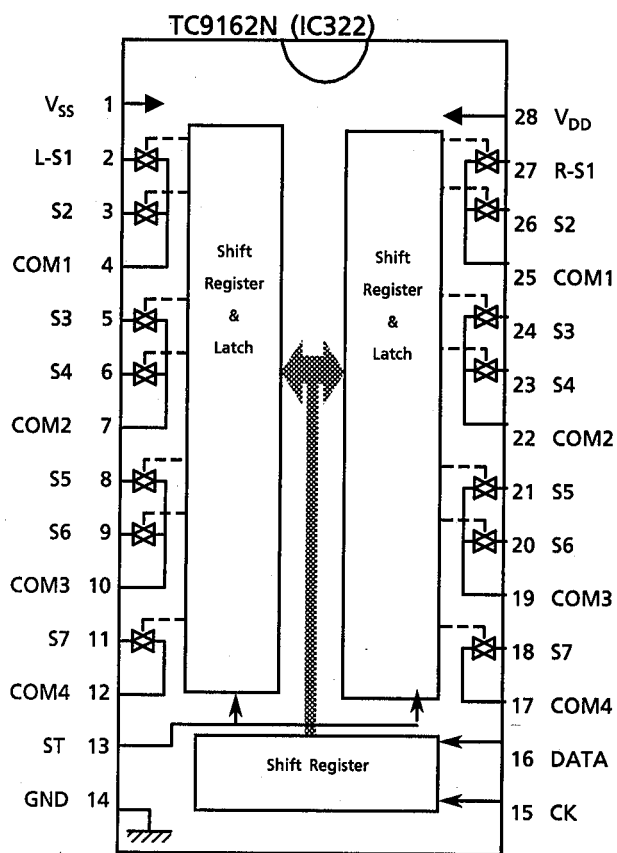

3. First 10bits are used to source select. Last 4bits are chip select. The switches (S1~S8) are connected to common terminals (COM1~COM3) according to the DATA from computer.

	Chip Select Bit			
	S11	S12	S13	S14
TC9162N	0	0	0	0
TC9163N	1	0	0	0
TC9164N	0	1	0	0

■ LC7522 (IC551) : Variable Resistor for SEA Control

1. Terminal Layout

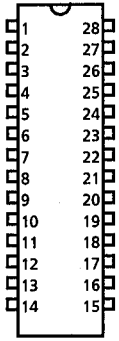

2. Block Diagram

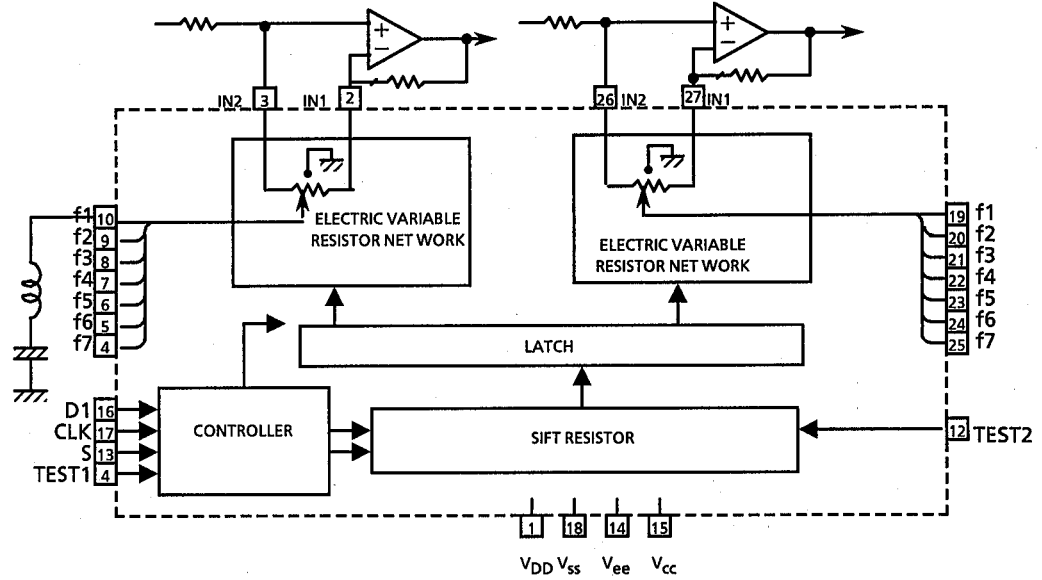

3. Pin Functions

Pin No.	Pin Name	Functions
1	V _{DD}	Power supply +7V for audio signal
18	V _{SS}	Ground.
14	V _{EE}	Power supply -7V for audio signal.
15	V _{CC}	Power supply +5V
2,27	IN 1	Audio signal input
3, 26	IN 2	The inversion signal of the operational amplifier inputs to IN 1 normally. The non-inversion signal of the operational amplifier inputs to IN 2 normally.
16	DI	Data input from the CPU. Schmitt inverter type
17	CLK	Clock signal input from the CPU. Schmitt inverter type
4~10 19~25	f1~f7	For connect to band-pass filter. f1~f7x2 (Left and Right)
11	TEST 1	Not use
12	TEST 2	Not use
13	S	Chip Select
28	NC	Not use

■ M5243P (IC552) : S.E.A. Graphic Equalizer

1. Functions

It makes inductive characteristic instead of coil.

2. Block Diagram

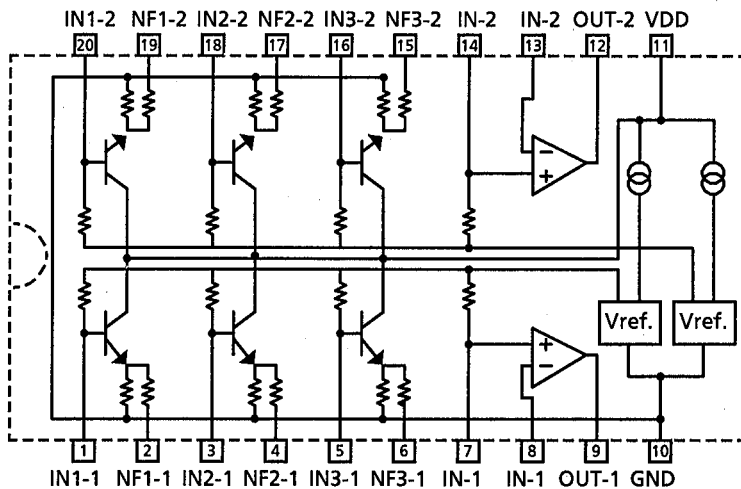

■ BU4051BC (IC371) : Analog Multiplexers / Demultiplexers

1. Terminal Layout

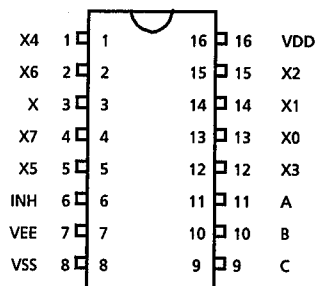

2. Block Diagram

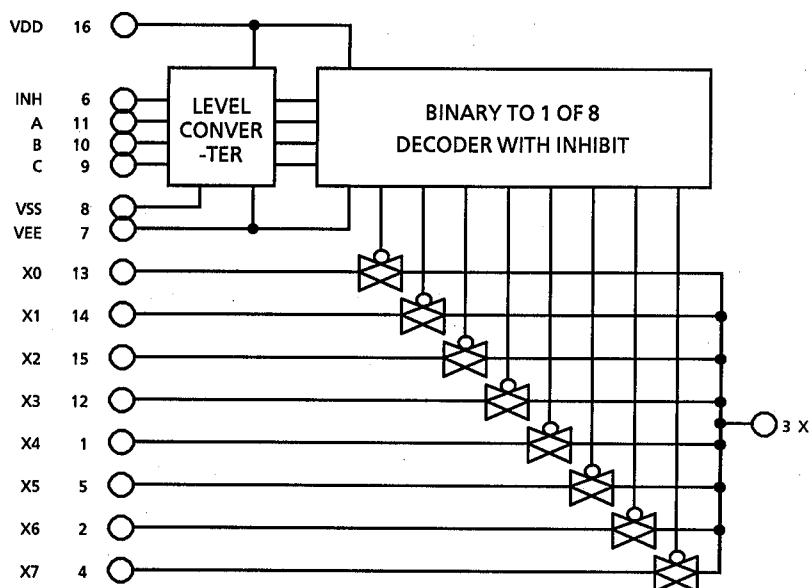

■ TC74HC74AF(IC093) : Dual d flip flop with preset and clear

1. Terminal Layout

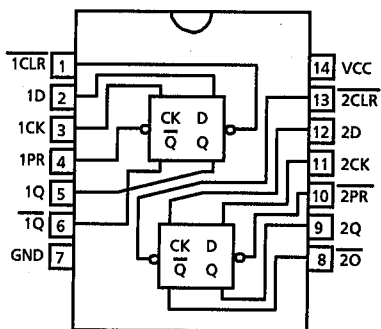

2. Pin function

INPUTS				OUTPUTS		FUNCTION
CLR	PR	D	CK	Q	Q̄	
L	H	X	X	L	H	CLEAR
H	L	X	X	H	L	PRESET
L	L	X	X	H	H	—
H	H	L	↑	L	H	—
H	H	H	↑	H	L	—
H	H	X	↓	Q _n	Q̄ _n	NO CHANGE

X: Don't care

■ VC5022-2 (IC701,702) : Super A

1. Terminal Layout

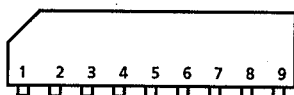

2. Block Diagram

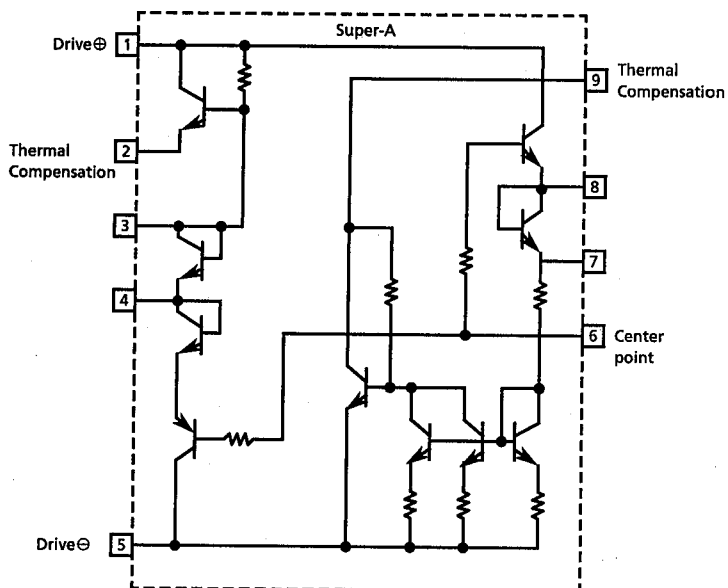

■ TA7317P (IC901) : Protector

1. Terminal Layout

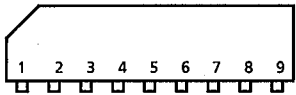

2. Block Diagram

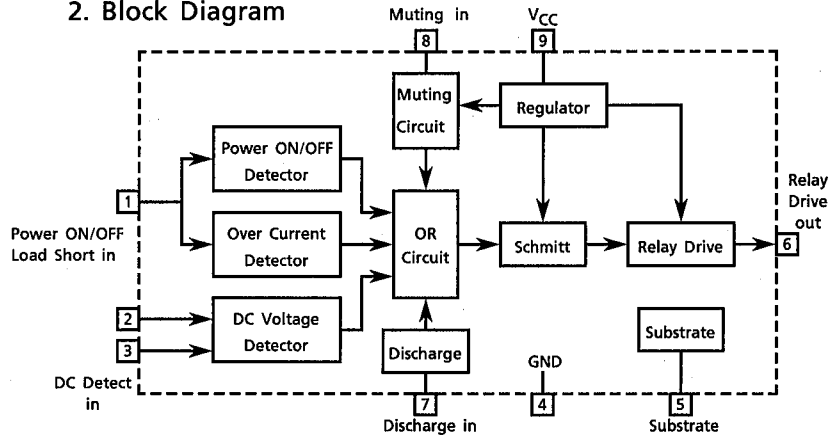

■ GP1U27X (IC402) : Receiver for remote controller

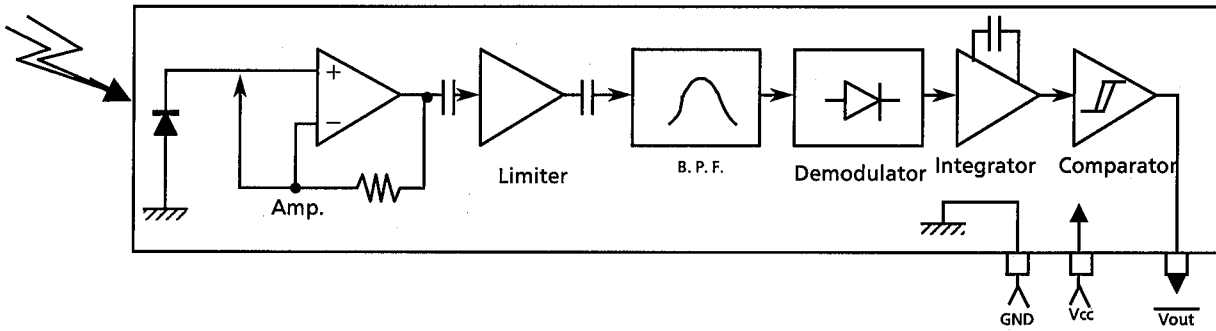

■ BA7625 (IC201) : Video Selector

1. Terminal Layout

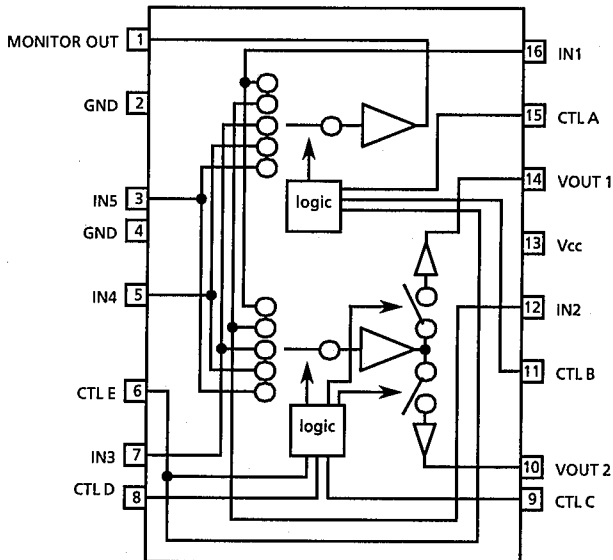

2. Function Table

A	B	E	MONITOR OUT
L	L	*	IN1
H	L	*	IN2
L	H	*	IN3
H	H	L	IN4
H	H	H	IN5

C	D	E	V OUT1
L	L	*	--
H	L	*	IN2
L	H	*	IN3
H	H	L	IN4
H	H	H	IN5

C	D	E	V OUT2
L	L	*	IN1
H	L	*	---
L	H	*	IN3
H	H	L	IN4
H	H	H	IN5

Internal Connections of the FL Display

■ELU0001-215 : DI400

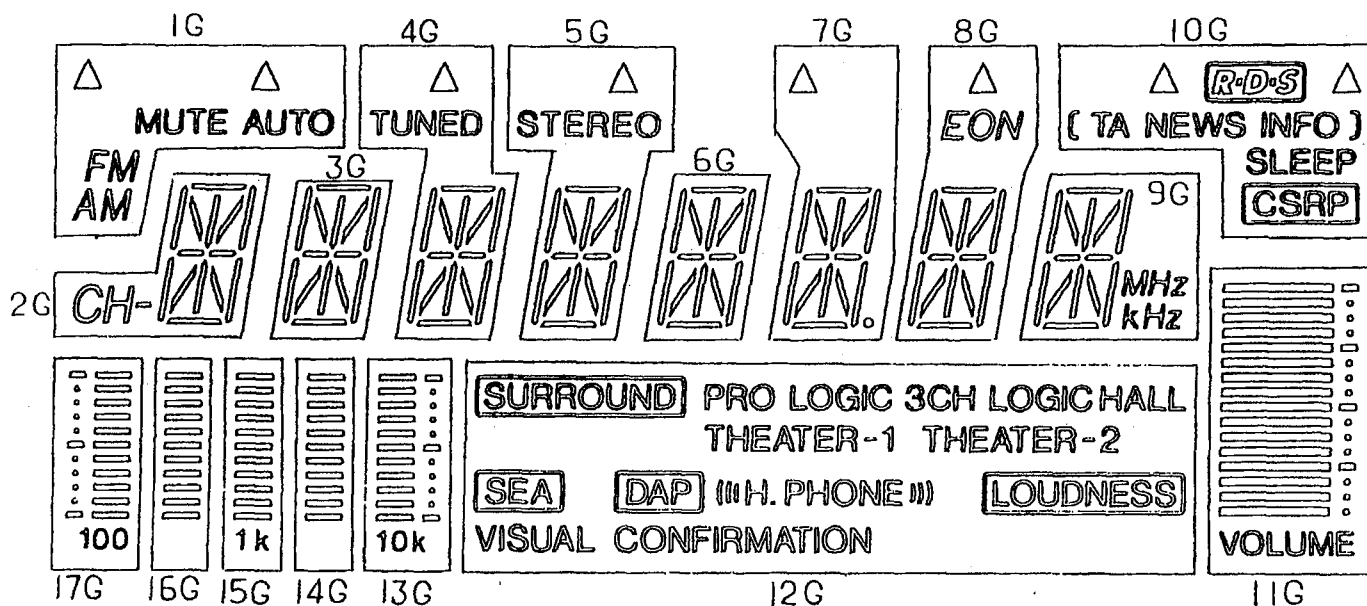

Pin Connection

TERMINAL NO.	1	2	3	4	5	6	7	8	9	10	11	12	13	14							
ELECTRODE	F1	F1	F1	NP	17G	16G	15G	14G	13G	12G	11G	10G	9G	8G							
TERMINAL NO.	15	16	17	18	19	20	21	22	23	24	25	26	27	28	29	30	31	32	33	34	
ELECTRODE	7G	6G	5G	4G	3G	2G	1G	NP	NP	NP	NP	NP	NP	P	P	P	P	P	P	P	
TERMINAL NO.									35	36	37	38	39	40	41	42	43	44	45	46	47
ELECTRODE									P	P	P	P	P	P	P	P	P	NP	F2	F2	F2

Notes F: Filament NP: No Pin
G: Grid
P: Anode

Internal Connection - Anode Designation

	1G	2G	3G	4G	5G	6G	7G	8G	9G	10G
S1		a	a	a	a	a	a	a	a	CSRP
S2		b	b	b	b	b	b	b	b	SLEEP
S3		i	i	i	i	i	i	i	i	TA
S4		j	j	j	j	j	j	j	j	NEWS
S5		h	h	h	h	h	h	h	h	INFO
S6		f	f	f	f	f	f	f	f	[]
S7		k	k	k	k	k	k	k	k	Δ (Right)
S8		g	g	g	g	g	g	g	g	R.D.S
S9		c	c	c	c	c	c	c	c	Δ (Left)
S10		l	l	l	l	l	l	l	l	
S11	FM	n	n	n	n	n	n	n	n	
S12	AM	m	m	m	m	m	m	m	m	
S13	MUTE AUTO	e	e	e	e	e	e	e	e	
S14		d	d	d	d	d	d	d	d	
S15	Δ (Left)	CH-		TUNED	STEREO		(Δ)	EON	MHz	
S16	Δ (Right)			Δ	Δ		Δ	Δ	KHz	

	11G	12G	13G	14G	15G	16G	17G
S1	A1						
S2	A2	LOUDNESS					Scale (Left)
S3	A3	VISUAL CON- FIRMATION	10k		1k		100
S4	A4						
S5	A5		B1	B1	B1	B1	B1
S6	A6		B2	B2	B2	B2	B2
S7	A7		B3	B3	B3	B3	B3
S8	A8	THEATER-2	B4	B4	B4	B4	B4
S9	A9	HALL	B5	B5	B5	B5	B5
S10	A10	3CH LOGIC	B6	B6	B6	B6	B6
S11	A11	H. PHONE	B7	B7	B7	B7	B7
S12	A12	THEATER-1	B8	B8	B8	B8	B8
S13	A13	PRO LOGIC	B9	B9	B9	B9	B9
S14	A14	DAP	B10	B10	B10	B10	B10
S15	A15	SEA	B11	B11	B11	B11	B11
S16	A16	SURROUND	Scale (Right)				

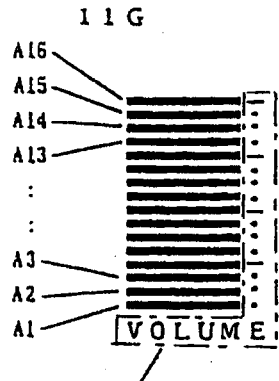
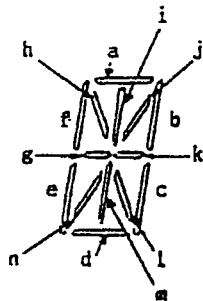

These segments pattern are connected to 11G.

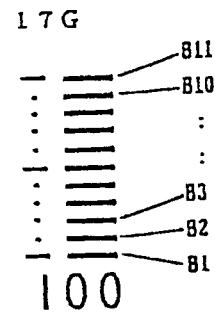

The segment pattern of 13G to 16G is same as above.

Disassembly Procedures

(1) Removing the top cover

1. Remove 4 screws **A** fastening both sides of top cover, and 3 screws **B** fastening the rear side.
2. Remove the top cover.

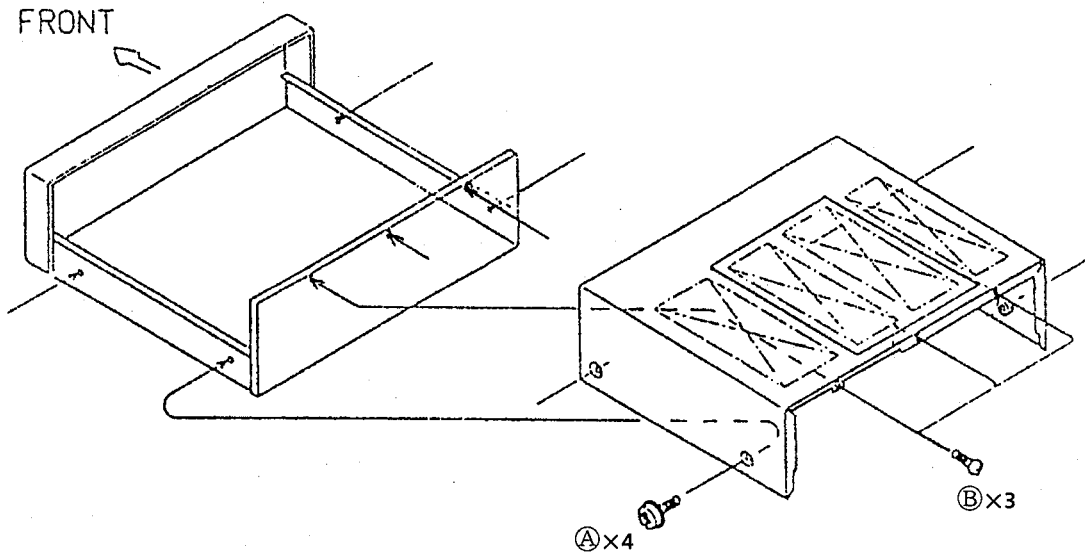

(2) Removing the Bottom Cover

1. Remove 16 screws **C** and **C''**.
2. Remove the bottom cover.

※ The screw **C''** which secures the bottom cover is also used for ground.
It is necessary to ground before checking after the bottom cover is removed.

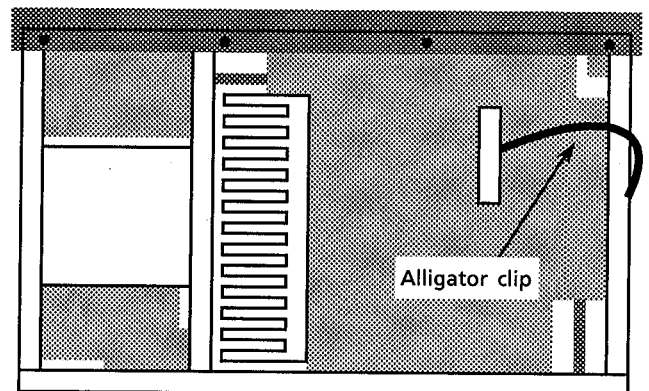
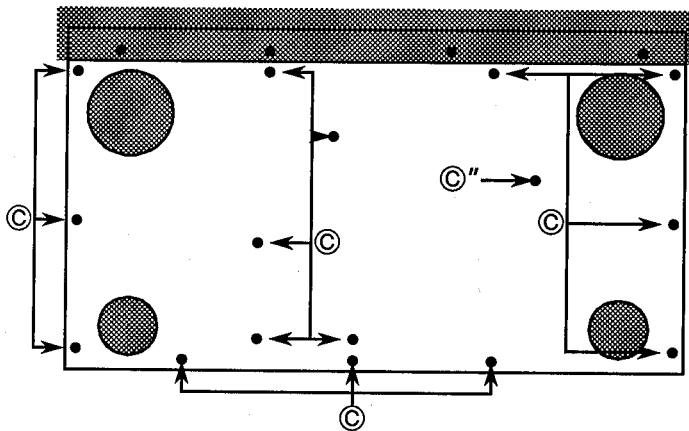

A .. E61660-004

B ... E73273-003

C, C'' SBSG3008CC

(3) Removing the Front Panel Assembly

1. Removing the top cover.
2. Remove 3 screws © fastening top of the front panel, and 4 screws ① fastening bottom of it.
3. Remove the front panel disconnecting some wires. (CN411,CN414,CN512,CN513)

(4) Removing the Front P.C. Board

1. Removing the top cover.
2. Removing the front panel assembly.
3. Remove 9 screws ②.
4. Remove the Master volume knob.
5. Remove a nut fastening the Master volume.
6. Remove the front P.C. Board.

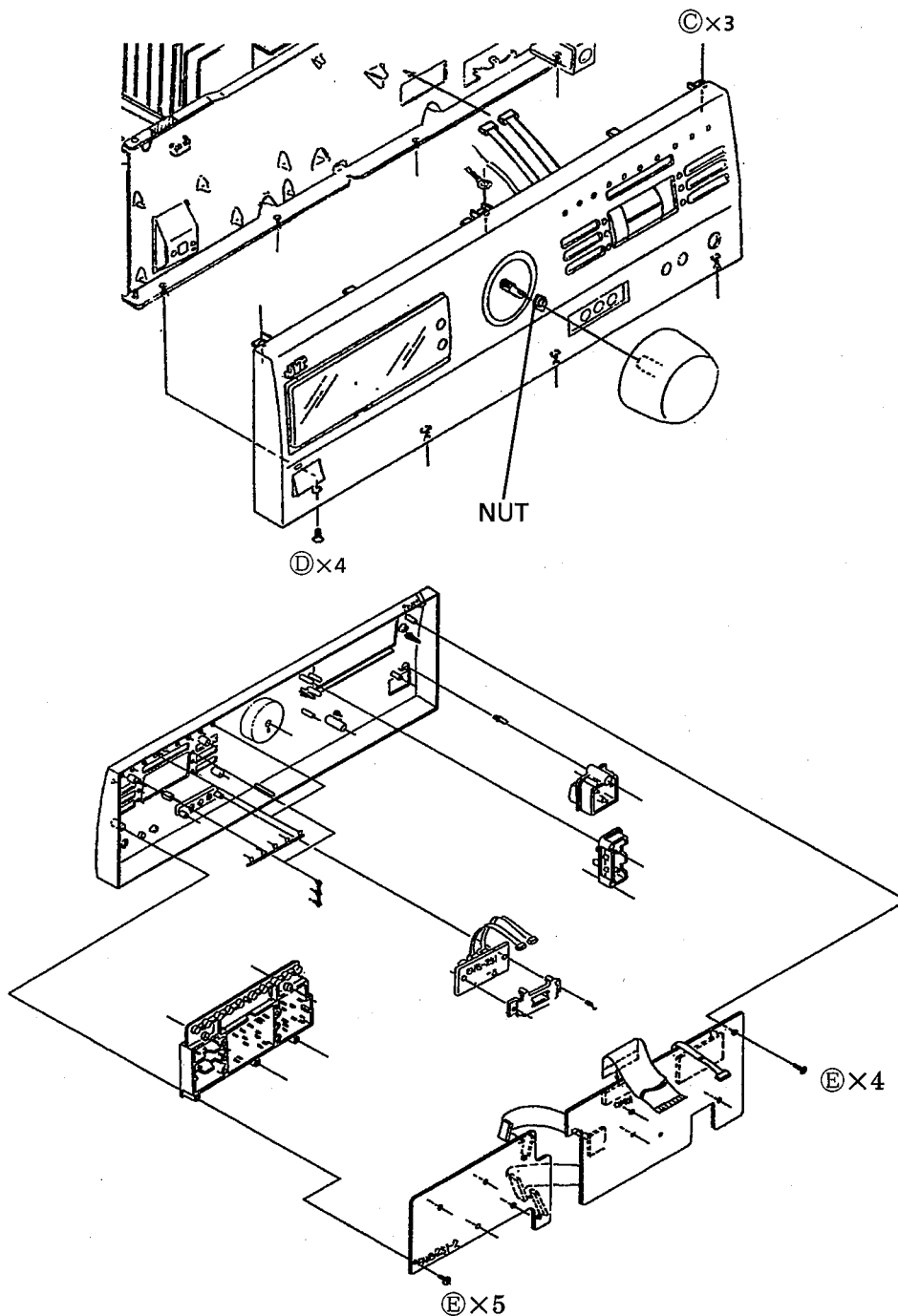

© .. SBSG3008CC

① ... SDSG3008M

② ... SDSF2608Z

(5) Removing the Rear Panel

1. Removing the top cover.
2. Remove 19 screws ⑤, ⑤". (Remove 21 screws ⑤, ⑤". (RX-992VBK))
3. Remove 3 screws ③ fastening bottom sides of rear panel.
4. Take it out.

※ 11pcs. of screw ⑤" which secure the rear panel are also used for ground.
Installing of those screws is required before checking.

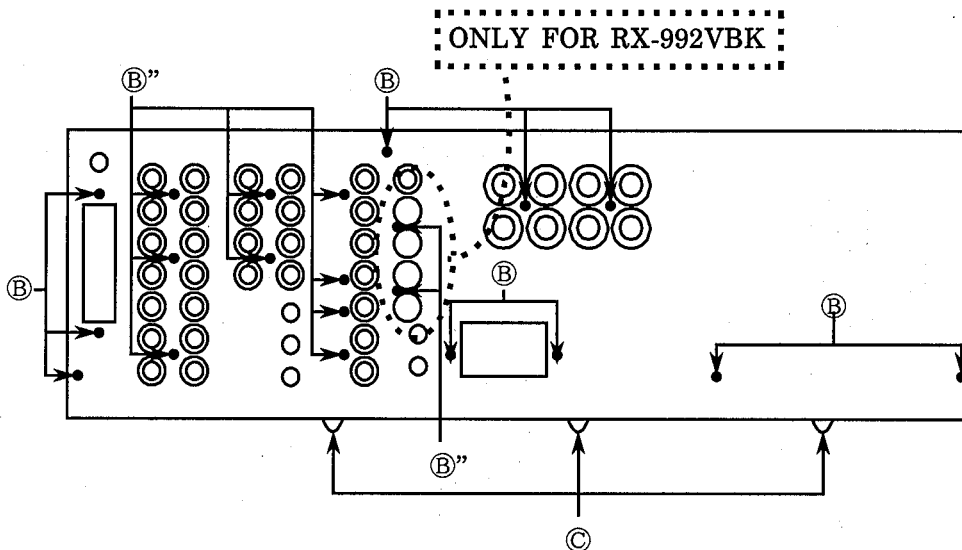

⑤, ⑤" E73273-003

③ SBSG3008CC

(6) Removing the Power Transistor

1. Remove the rear panel and bottom cover.
2. Remove screw © and plastic rivet fastening DAP PCB (ENP-054).
3. Disconnect CN001 to disassemble the tuner PCB (ENA-172). (Remove each wires if necessary.)
4. Disconnect CN611 and CN612 to disassemble the audio PCB (ENC-137-1) and DAP PCB. (Remove each wires if necessary.)
5. Disconnect CN605 and CN606 to disassemble the input PCB (ENC-137-2). (Remove each wires if necessary.)
6. Disconnect CN501 to disassemble the video PCB (END-106-2). (Remove each wires if necessary.)
7. Disconnect CN505 to disassemble the subwoofer PCB (END-106-3). (Remove each wires if necessary.)

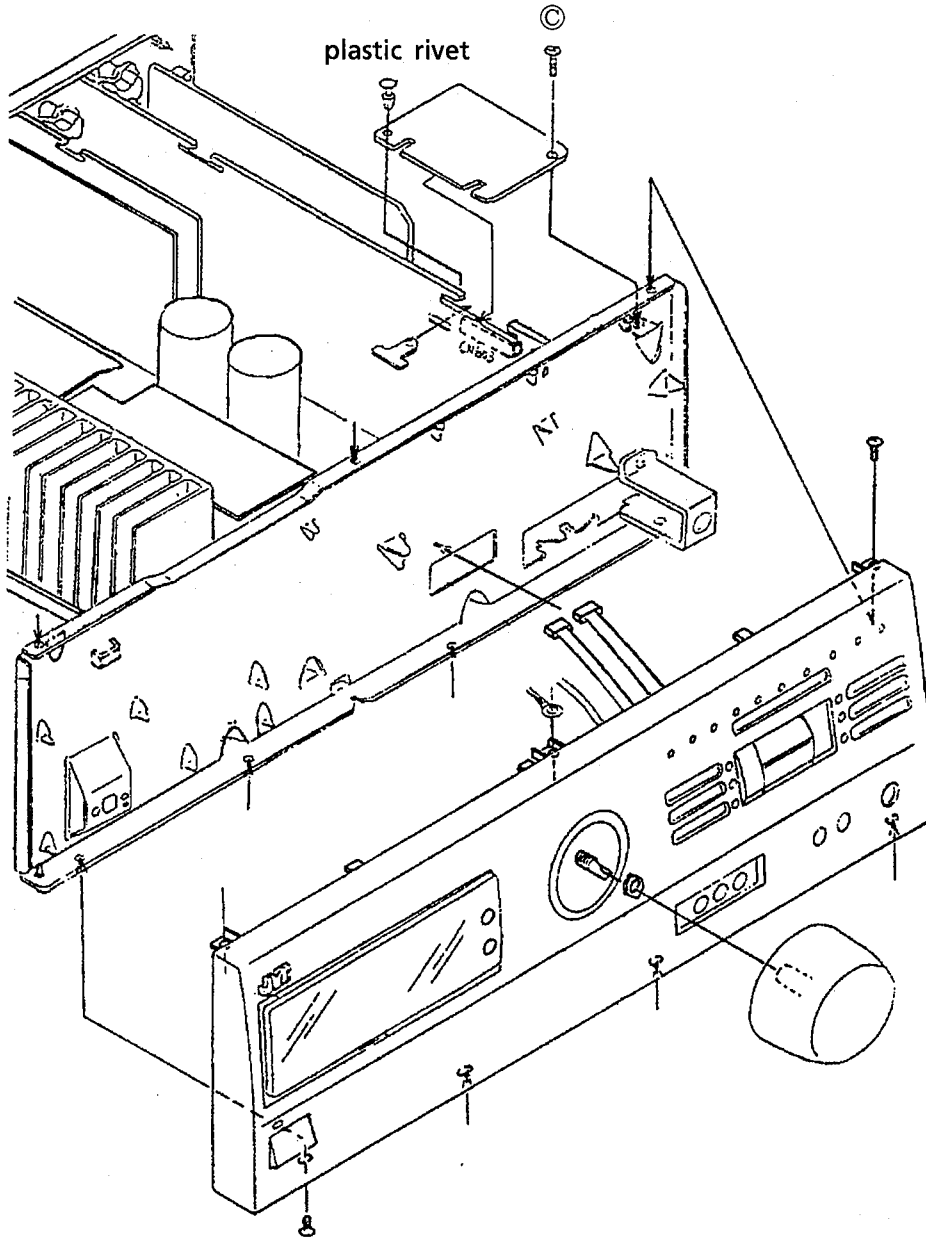

8. Unsolder the broken transistor.
9. Remove the some screws ⑤ fastening it.
10. Remove it.

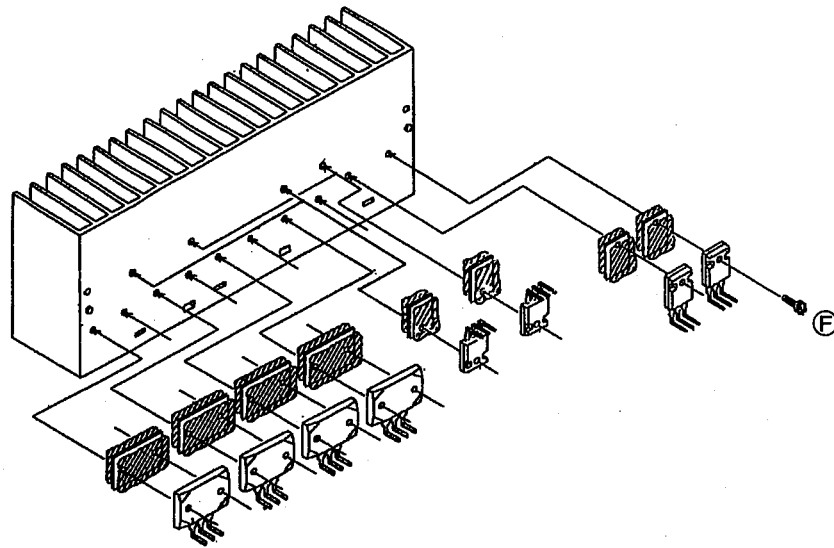

⑤ E73525-003

ADJUSTMENT PROCEDURES

■ Tuner section

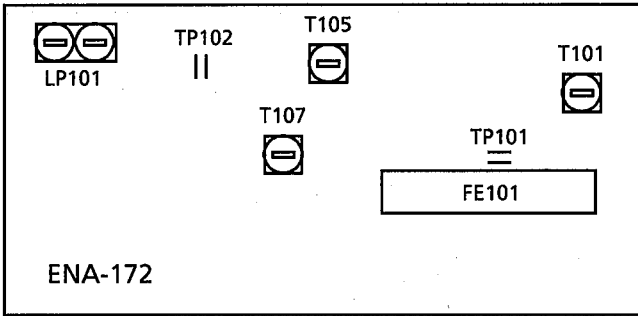

Tuning range

Area	Range	
	MW (kHz)	FM (MHz)
the U.S.A., Canada	530~1710	87.5MHz~108MHz

(1) Tuning Voltage

Confirm the voltages in the table at TP101.

FM Tuning voltage (Unit : V)

Area	Frequency	
	87.5MHz	108MHz
the U.S.A., Canada,	1.6 ± 1.0	8.0 ± 2.0

AM Tuning voltage (Unit : V)

Area	Frequency (MW)						
	522KHz	530KHz	531KHz	1600KHz	1602KHz	1629KHz	1710KHz
the U.S.A., Canada	—	$1.0 > 0.5$	—	—	—	—	8.0 ± 0.8

(2) FM Center meter

Receive a broadcast by using the function of 'AUTO STOP'.

Adjust T105 (Detector coil) so that the voltage at TP102 becomes $0 \pm 1.5mV$.

■ Power Amplifier section

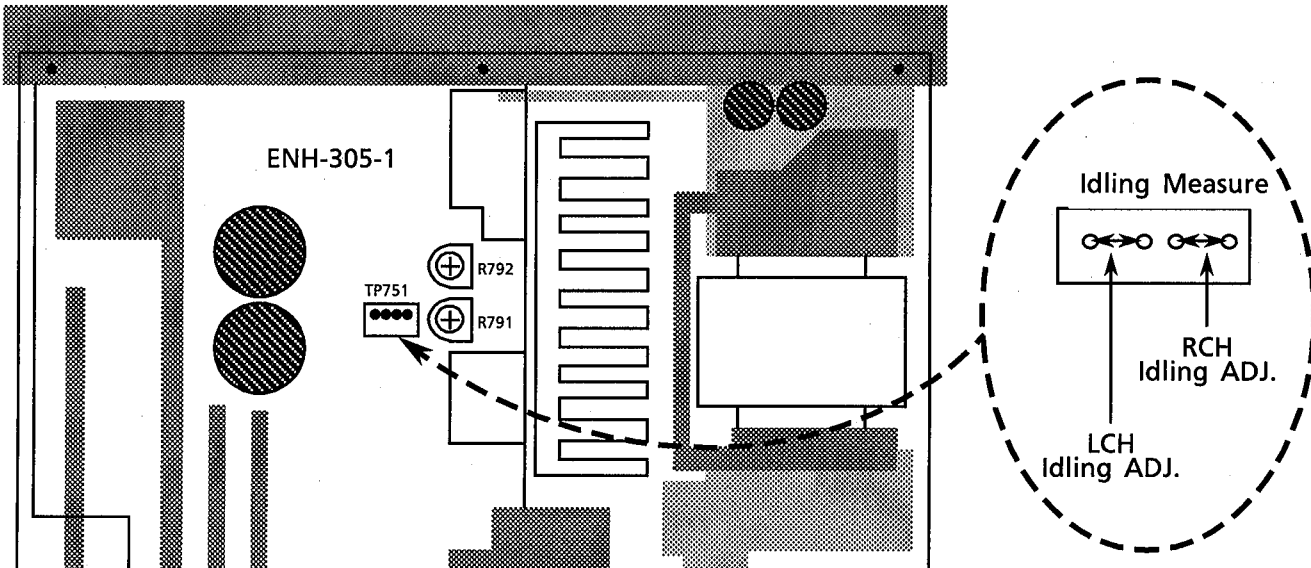

■ Idling current

- (1) Set the volume control to minimum during this adjustment. Set DAP and surround mode "OFF". And set speaker load selector "HIGH".
- (2) Turn R791 and R792 fully counterclockwise to warm up before adjustment.
If the heatsink is already warm from previous use the correct adjustment can not be made.
- (3) Connect a DC voltmeter to TP751.
- (4) Adjust TP751, so that the DC voltmeter becomes $1mV \sim 10mV$.

Block Diagrams

■ Control Section

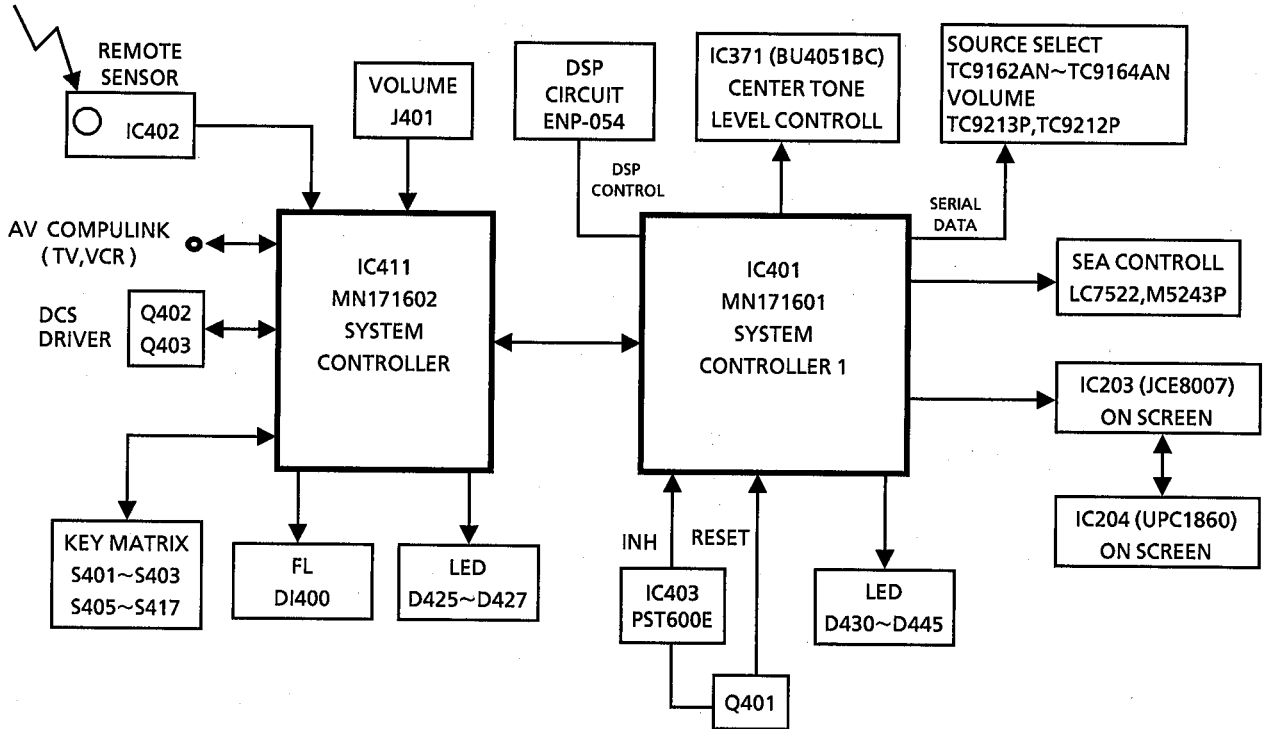

■ Power Supply Section

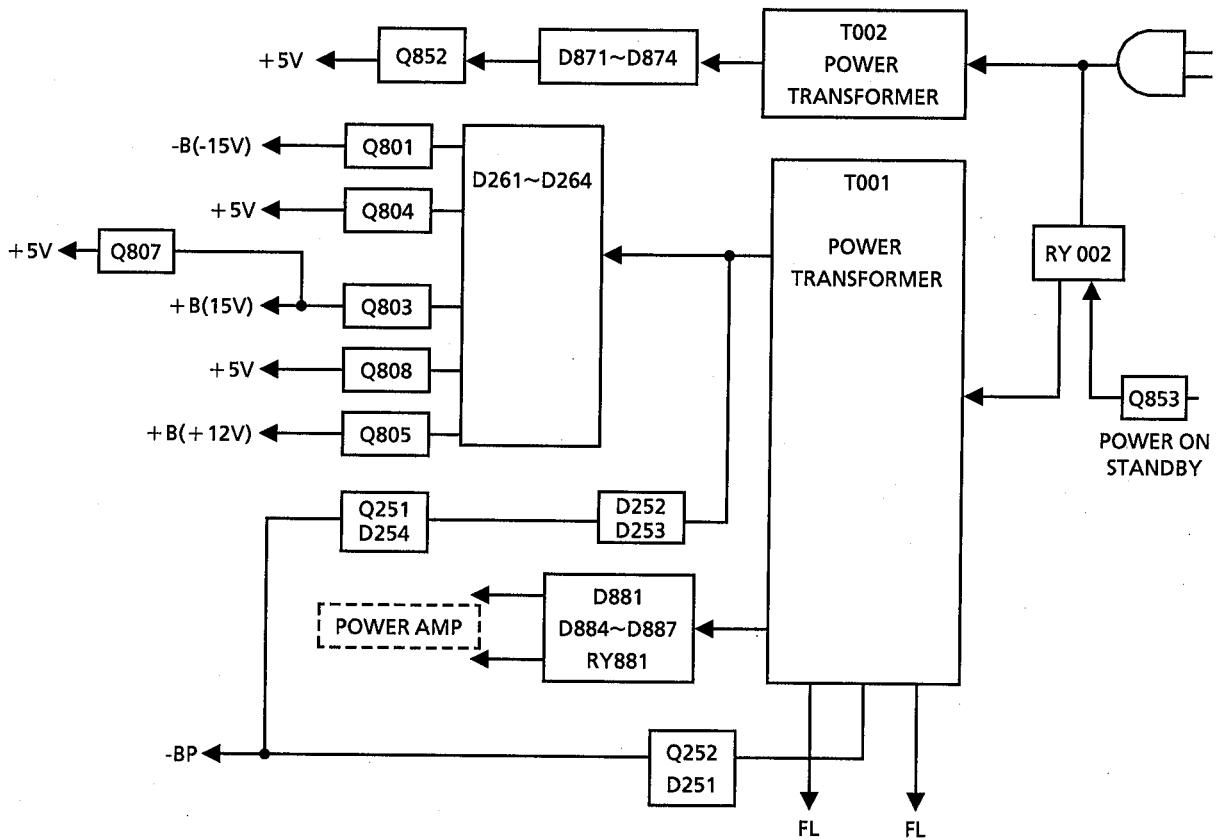

■ Tuner Section

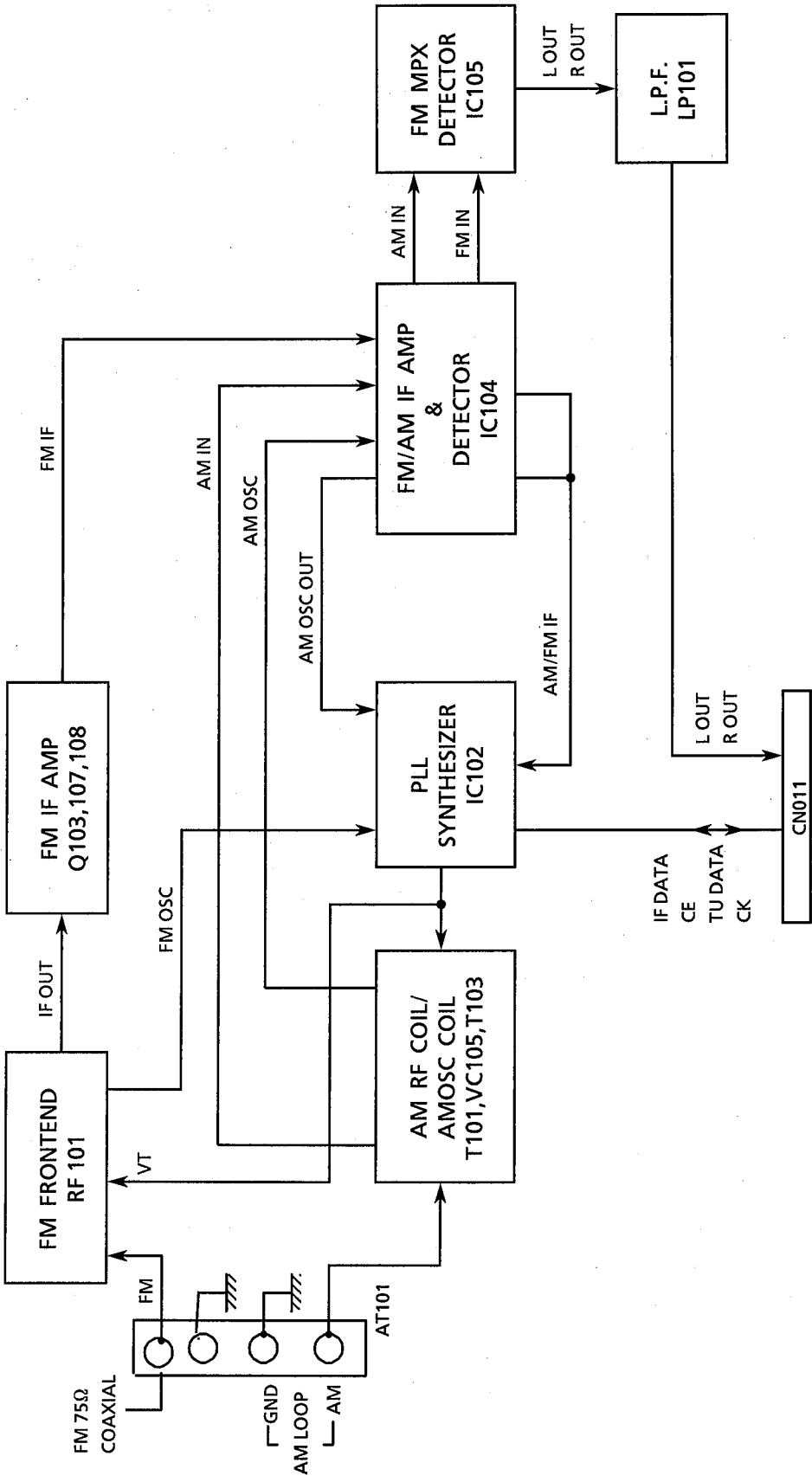

■ DAP Section

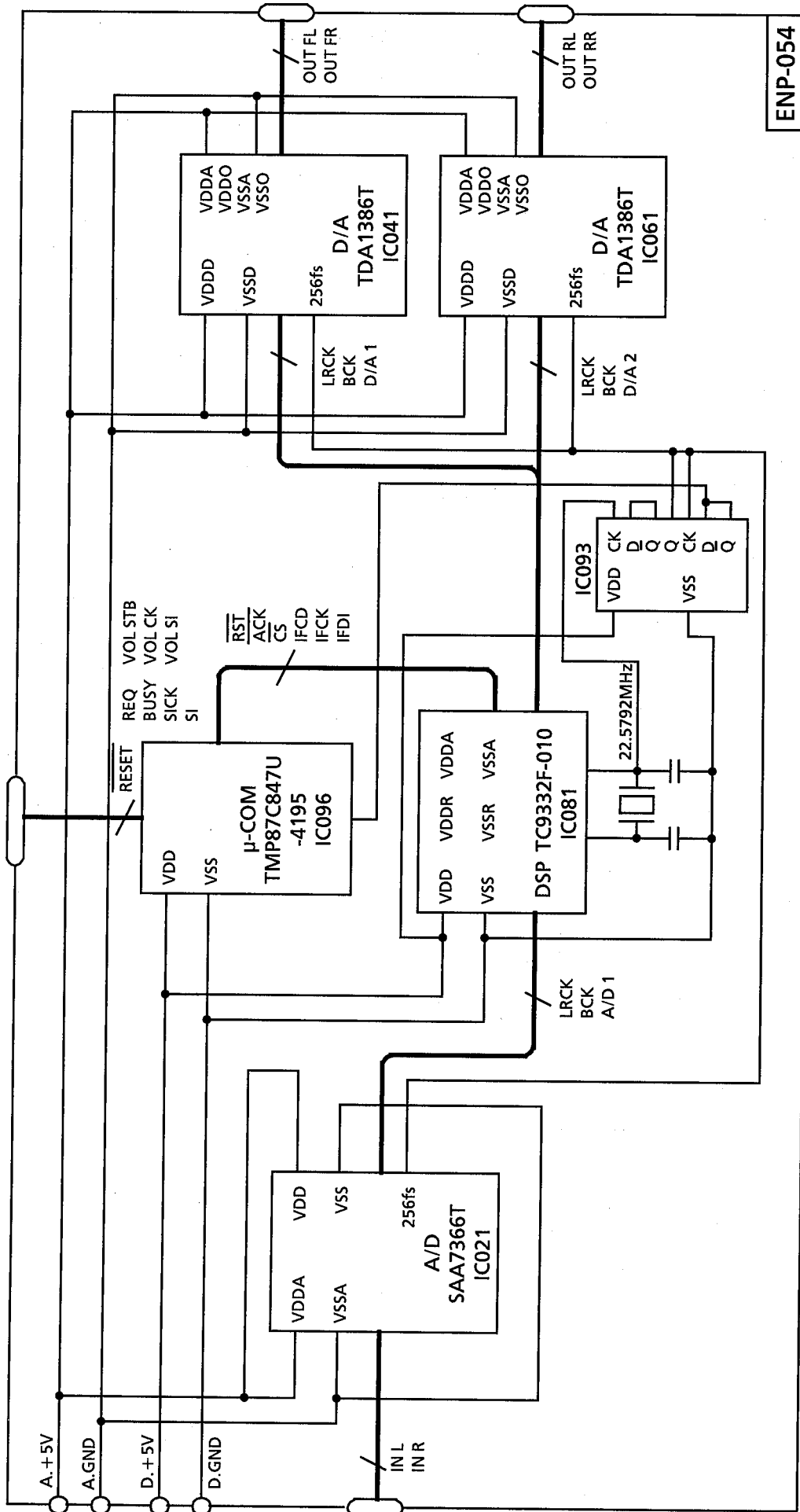

ENP-054

— MEMO —

SIGNAL FLOW

(NOTE) RX-992VBK ONLY

AUDIO

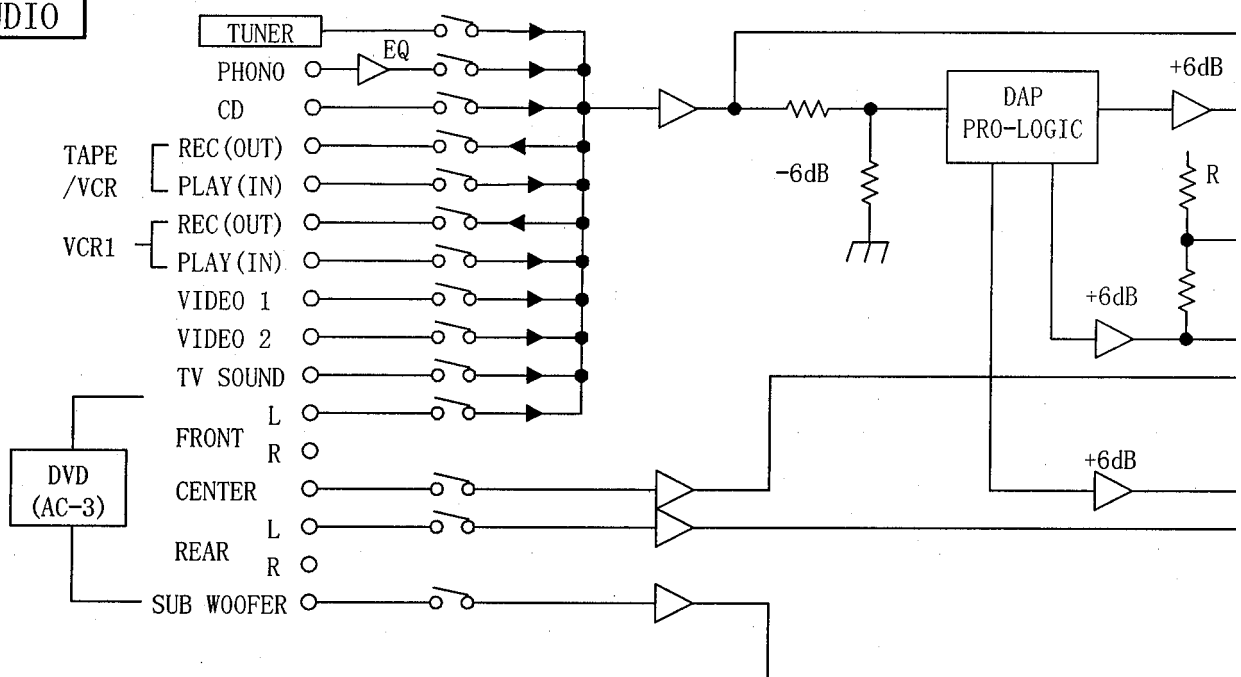

VIDEO

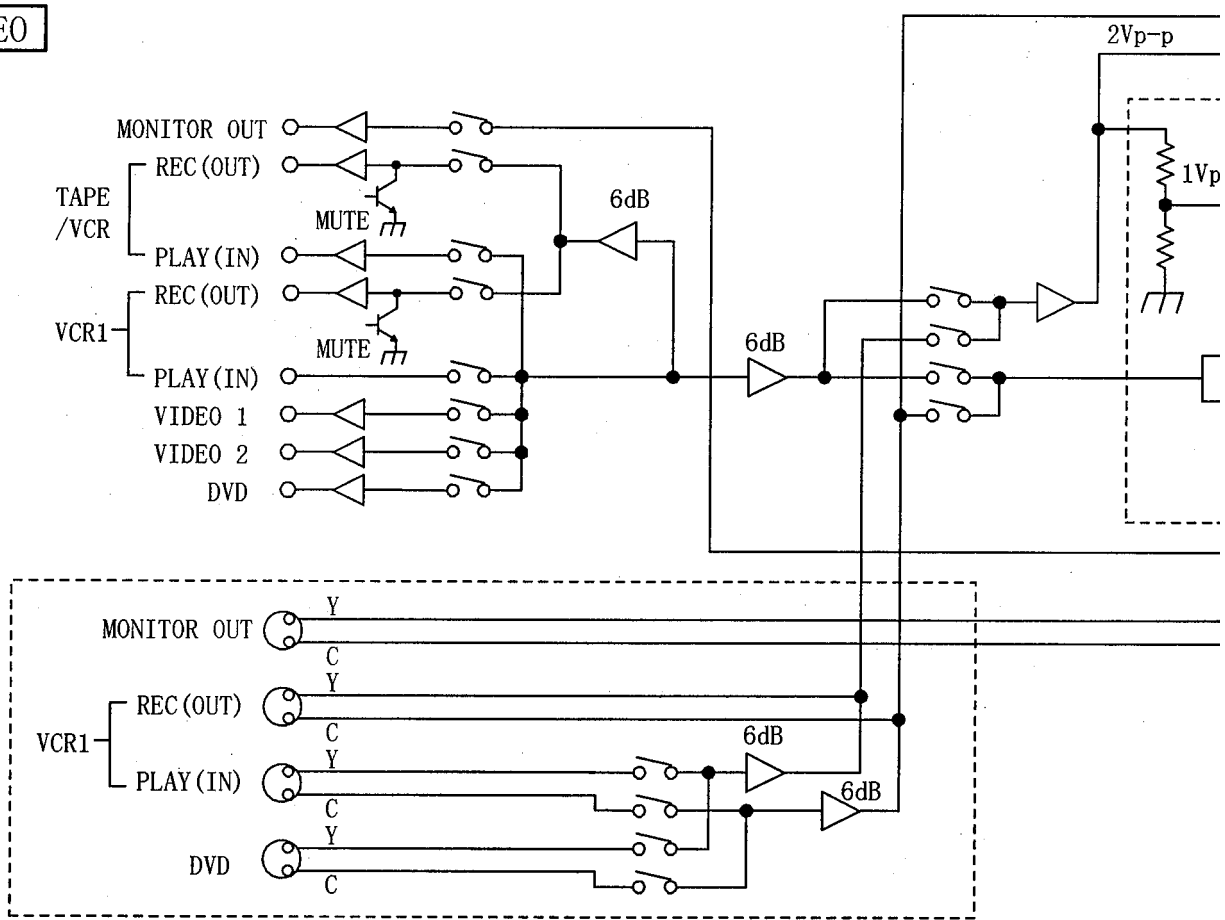

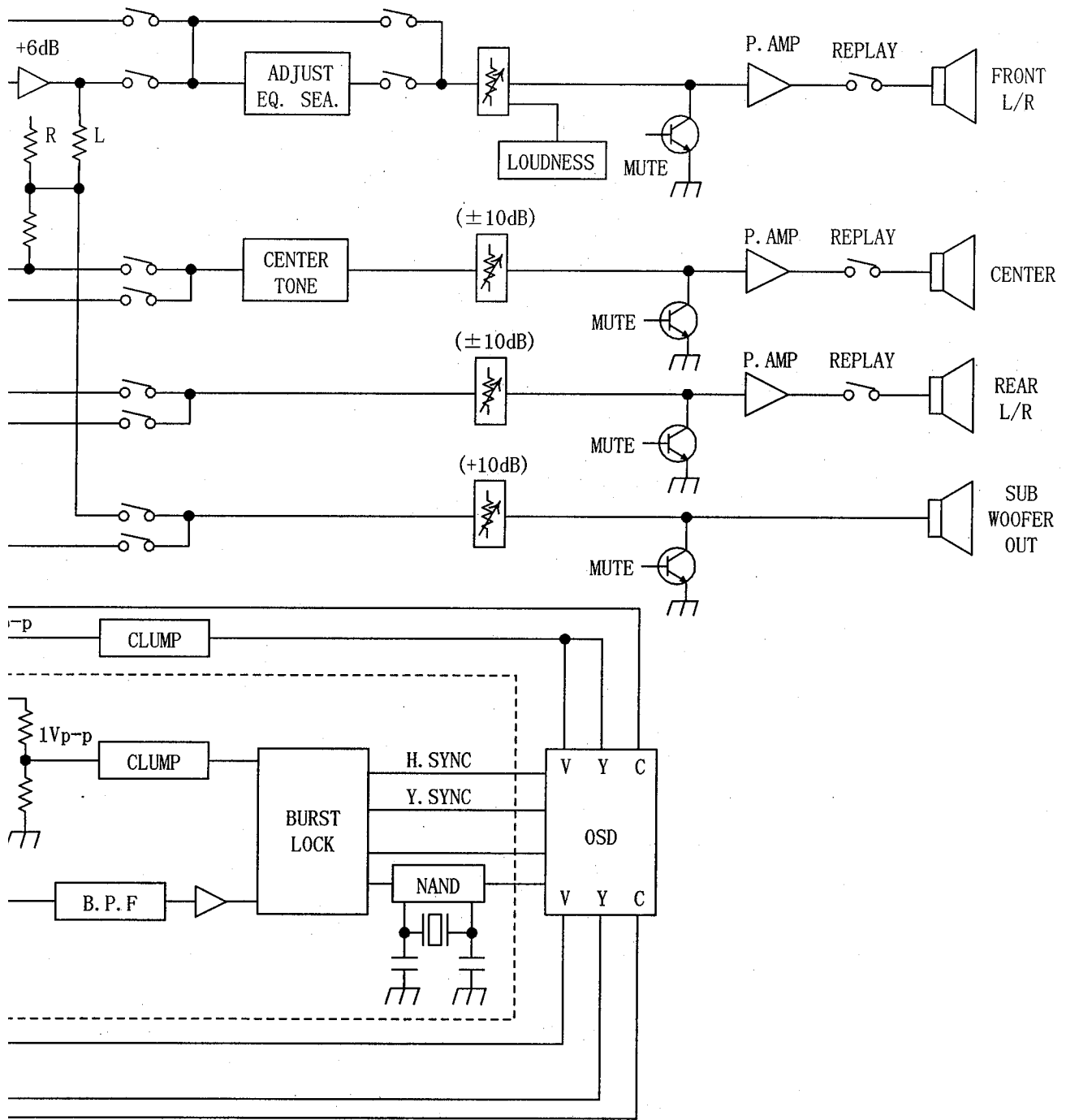

Schematic Diagrams

1 2 3 4 5 6 7 8

A
B
C
D
E
F
G
H
I
J

■ Tuner Section

FOR J, C
ENA-172-1

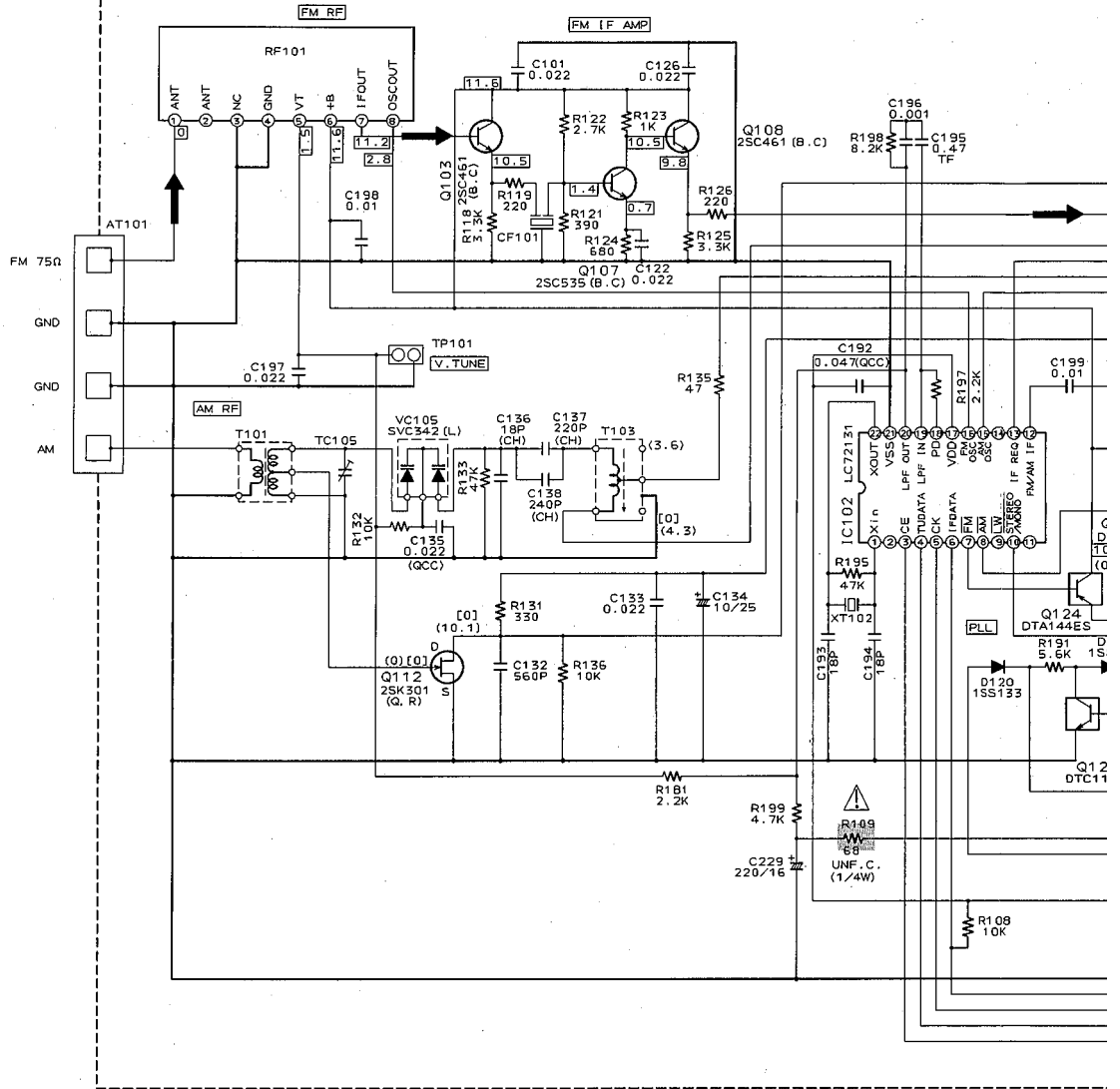

RF101
EAF2203-004

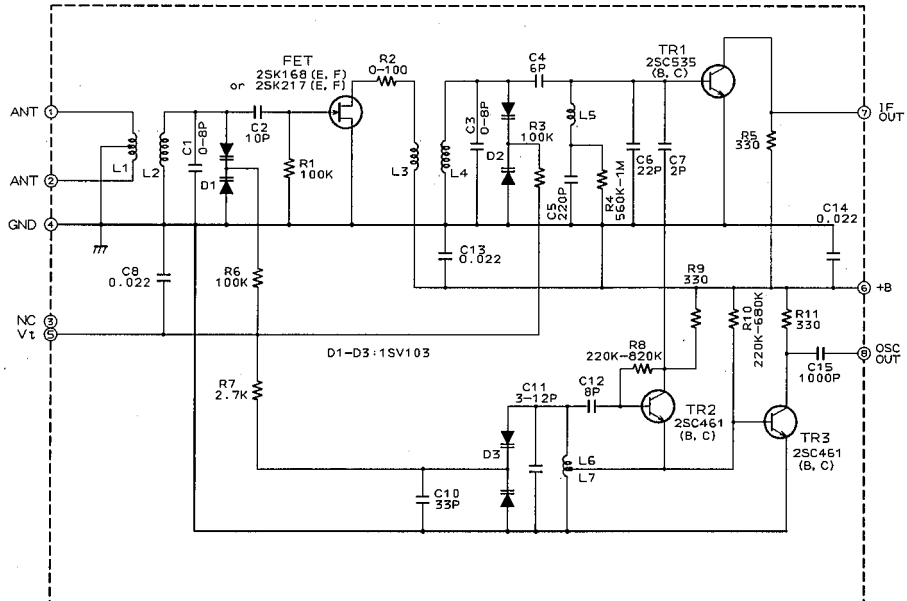

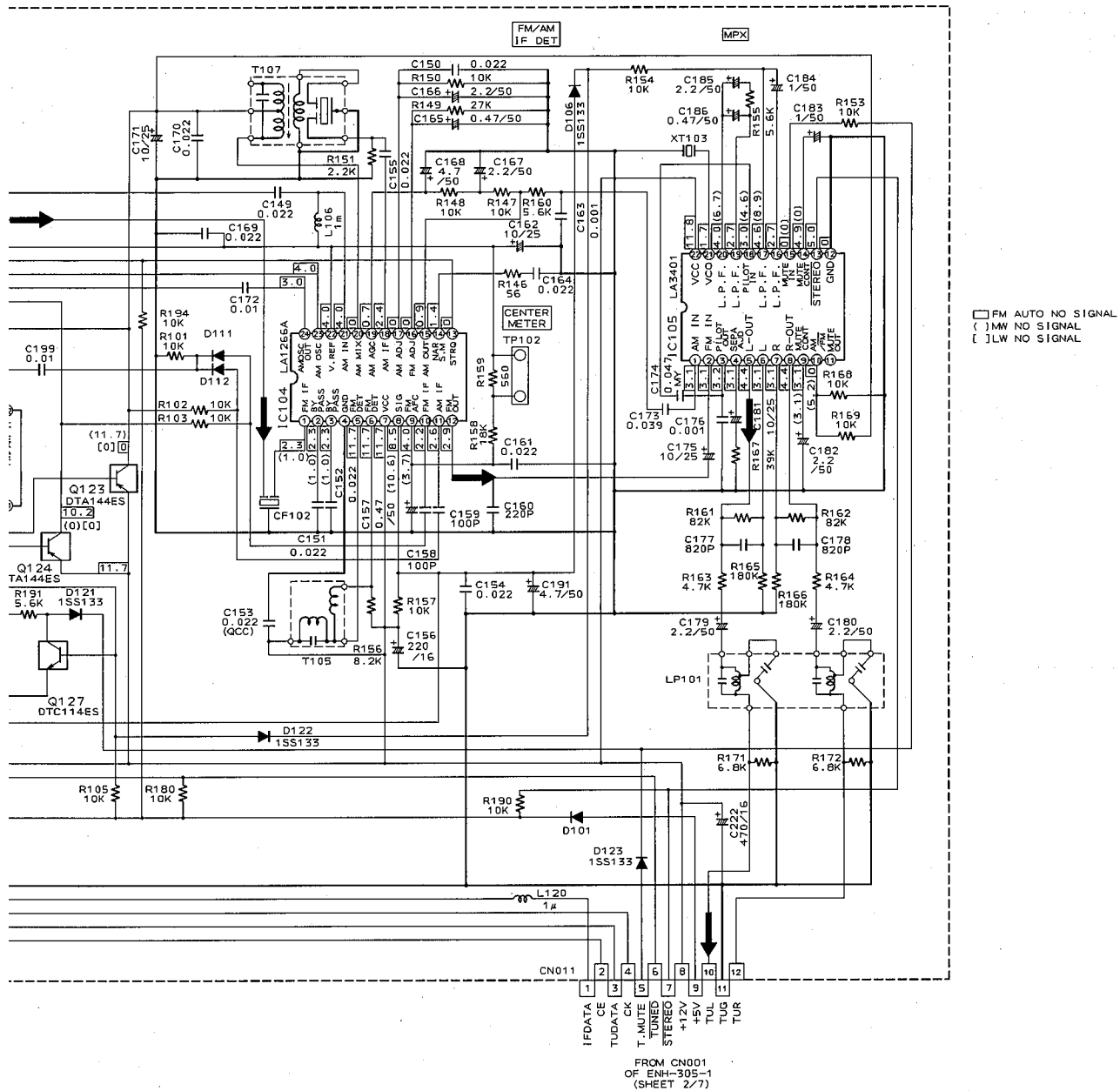

— Note —

1. ➔ indicates MAIN signal path.
2. ◻▶ indicates REAR signal path.
3. ➤ indicates CENTER signal path.
4. When replacing the parts in the darkened are () and those marked with △, be sure to use the designated parts to ensure safety.
5. This is the standard circuit diagram.
The design and contents are subject to change without notice.

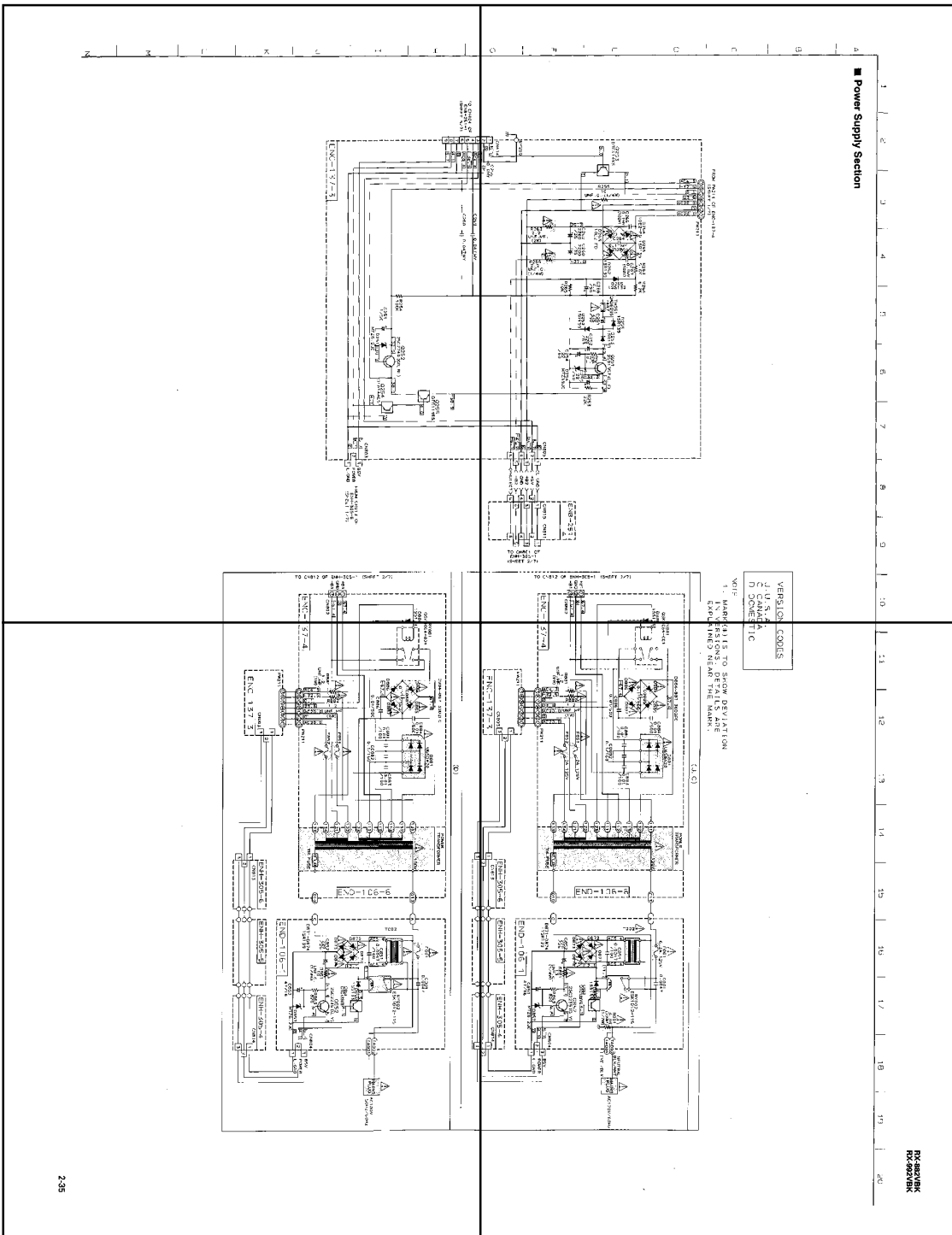

G H I C K L M N Z

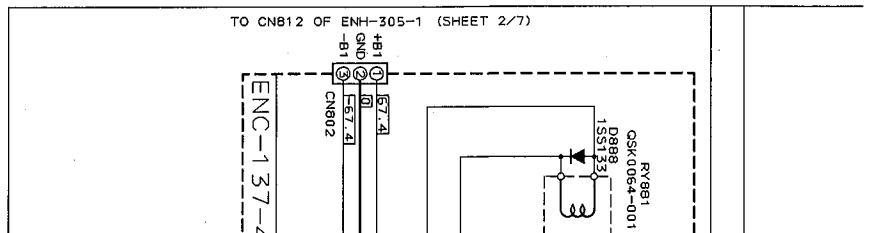
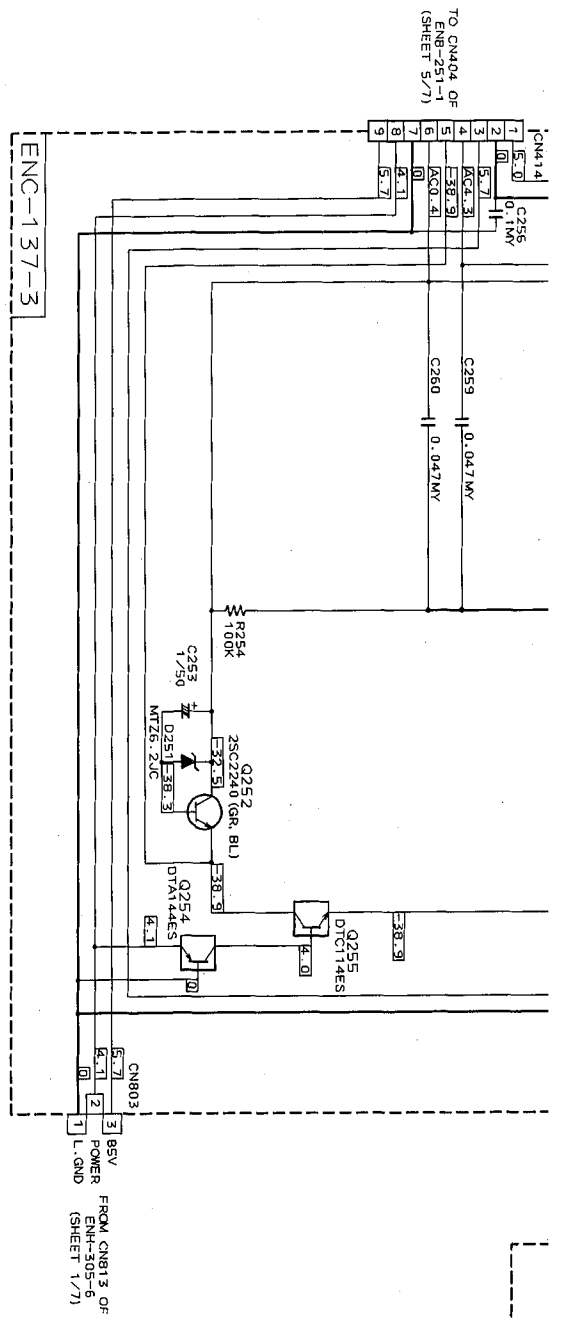

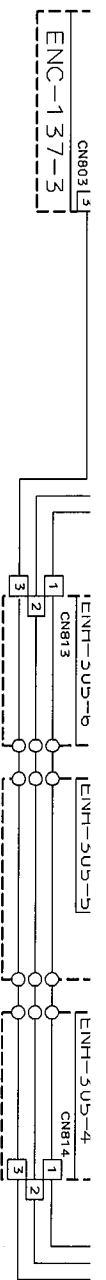

(D)

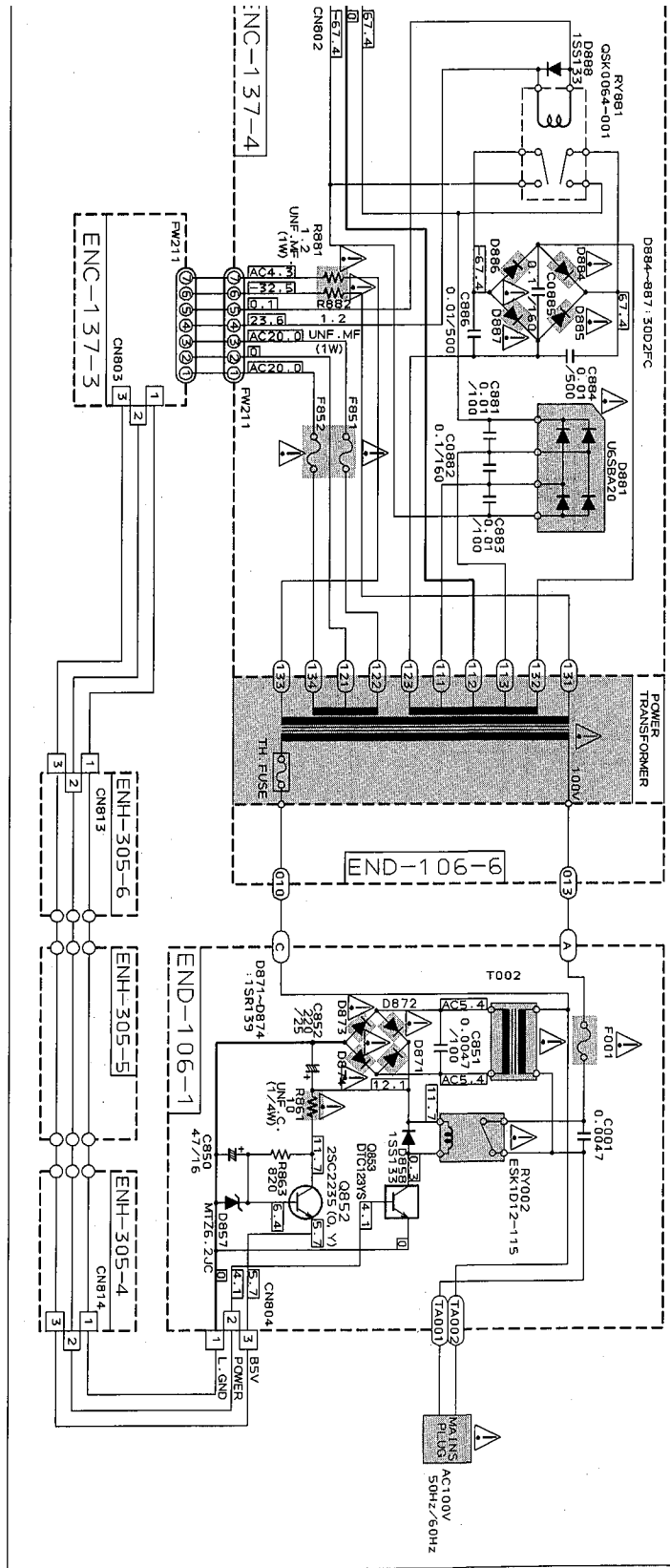

P2-36-a

P2-36-b

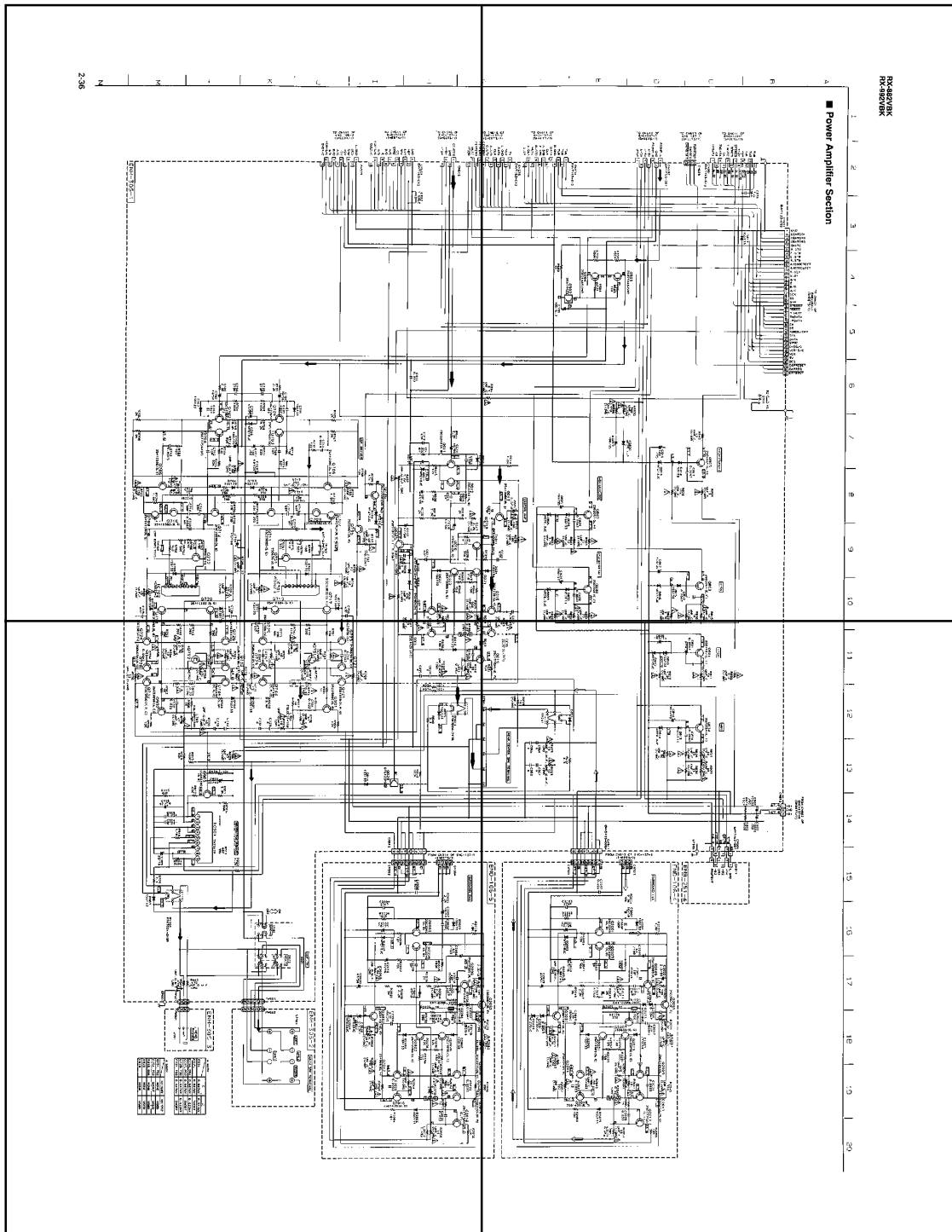

P2-36-c

P2-36-d

Power Amplifier Section

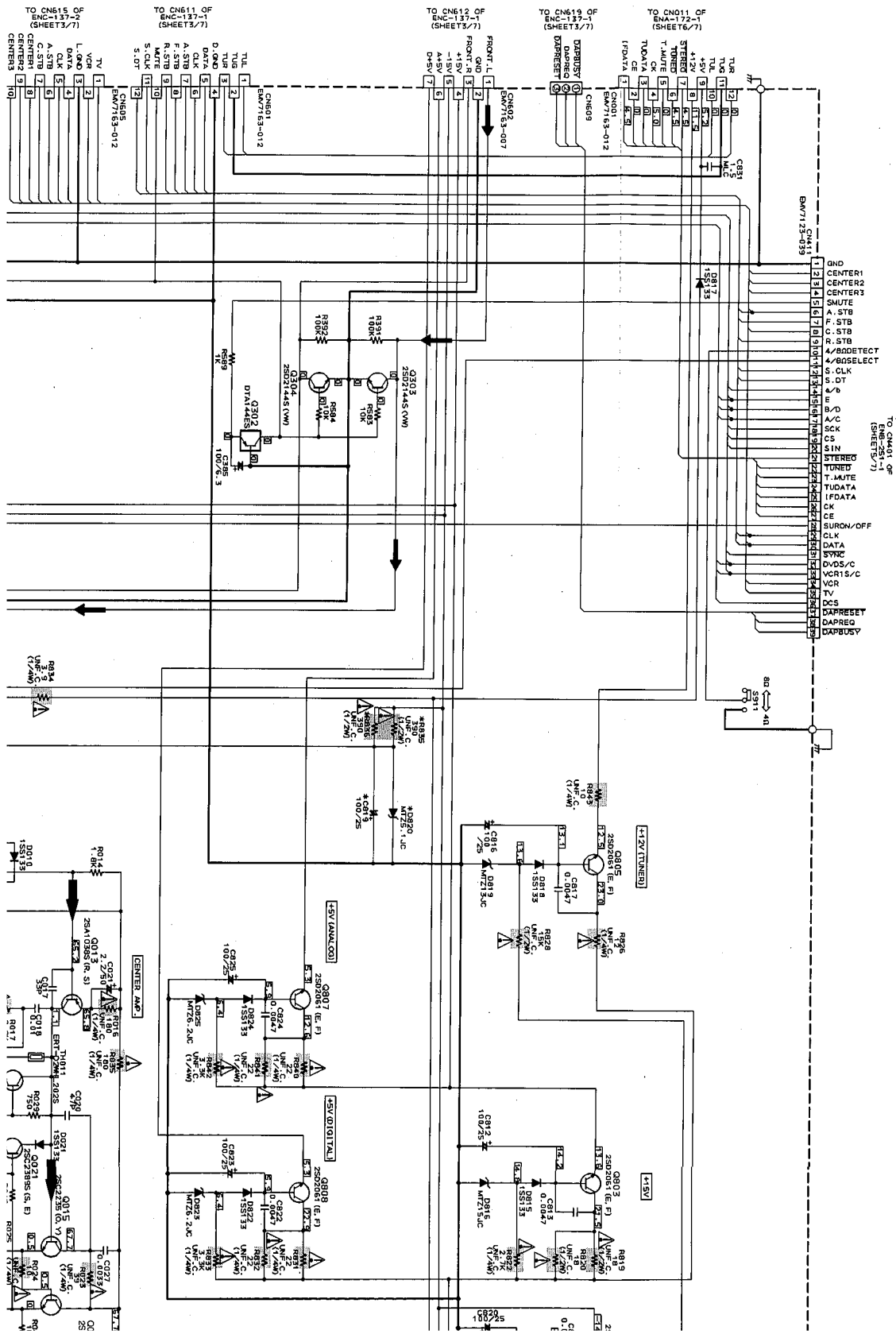

P2-37-a

P2-37-b

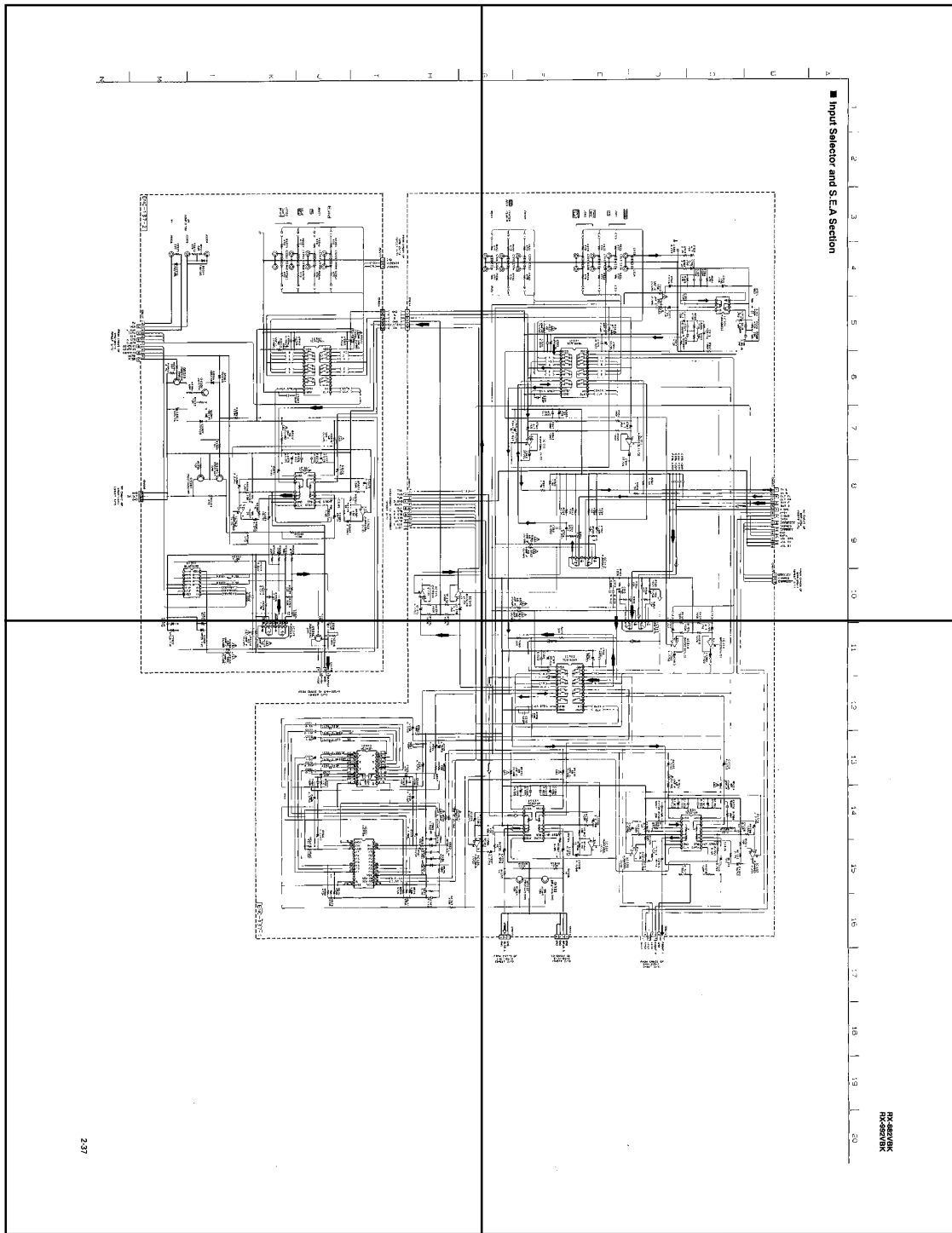

P2-37-c

P2-37-d

1 2 3 4 5 6 7 8 9 10

Input Selector and S.E.A Section

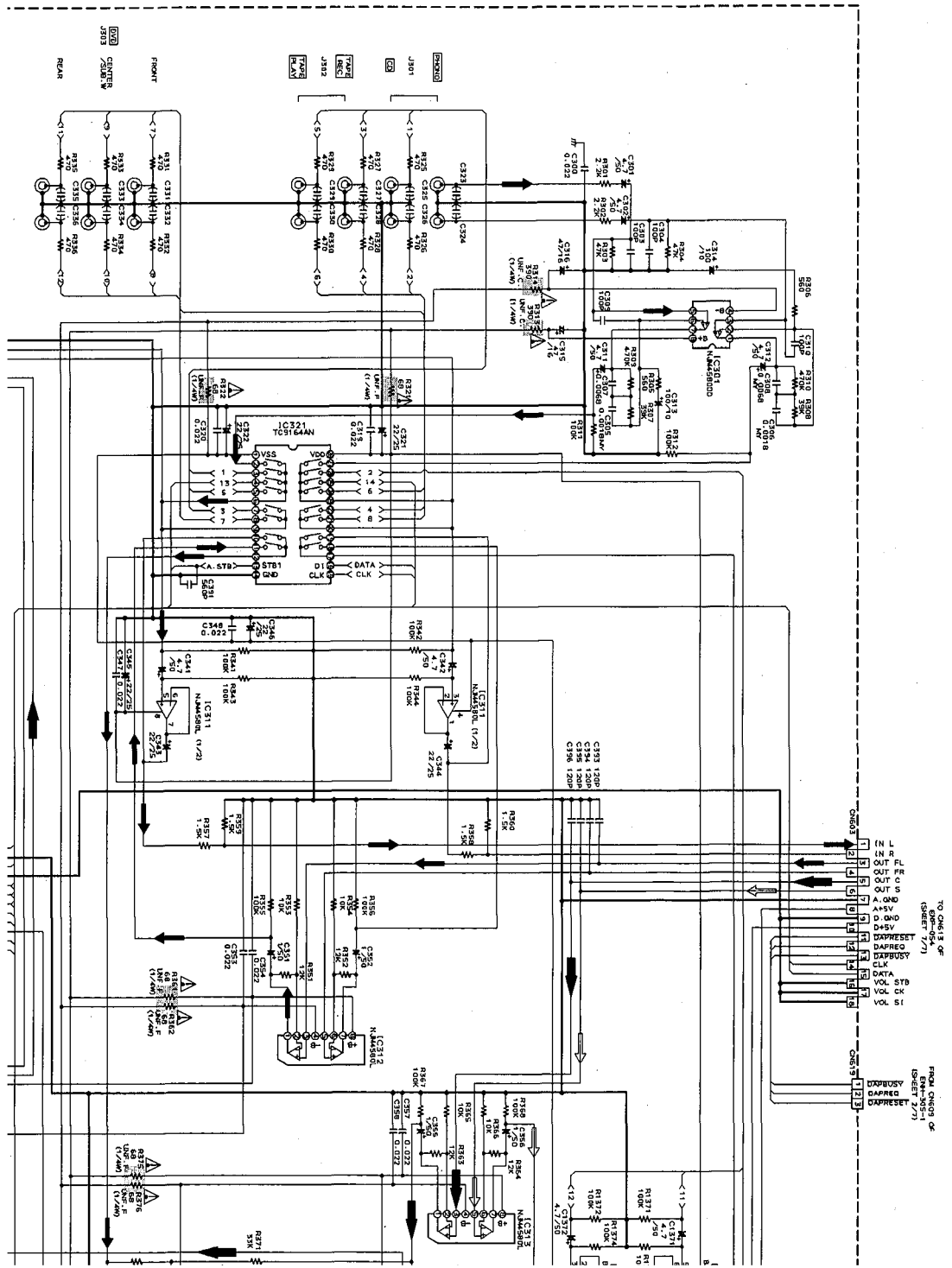

G

F

E

D

C

B

A

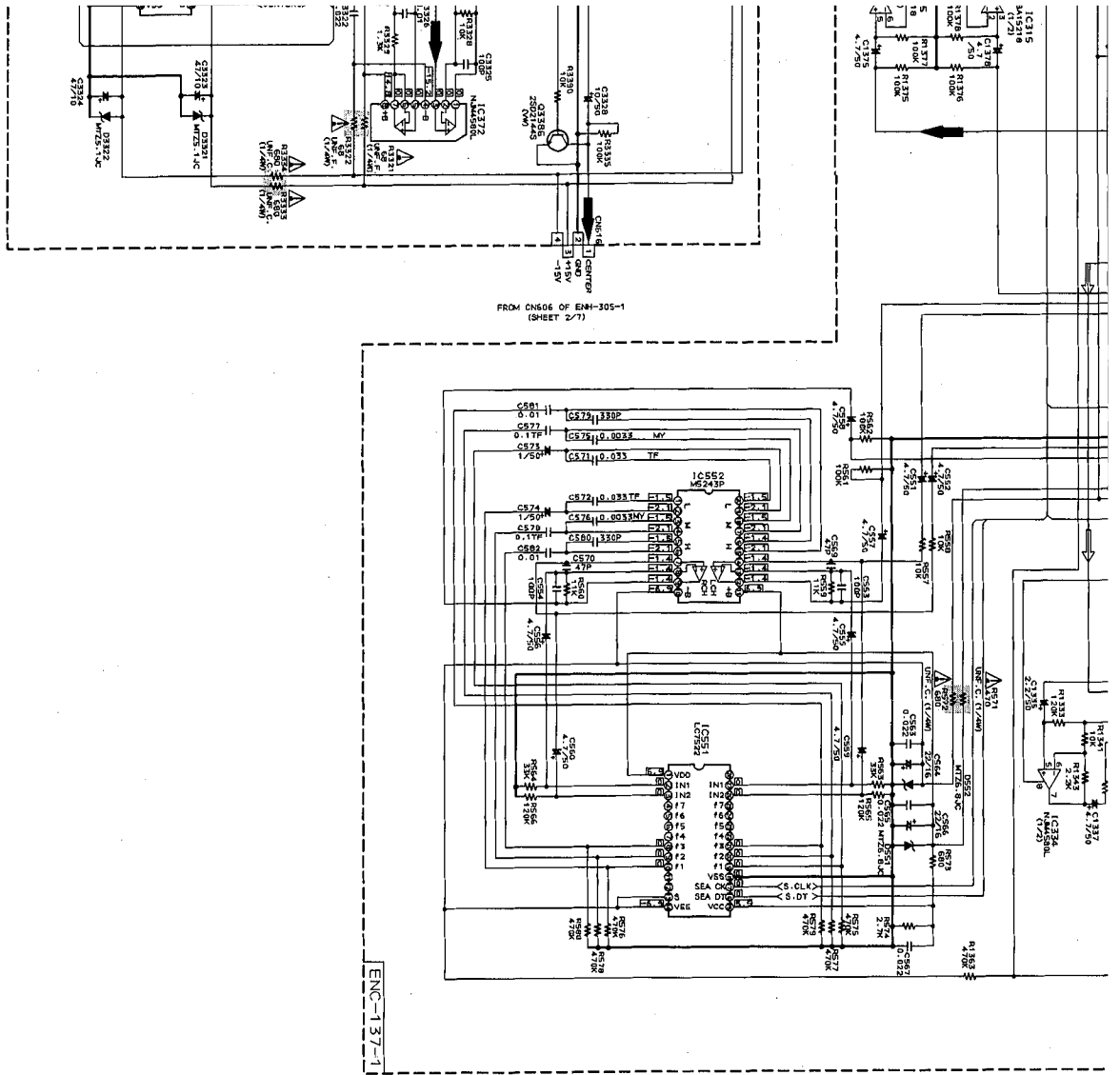

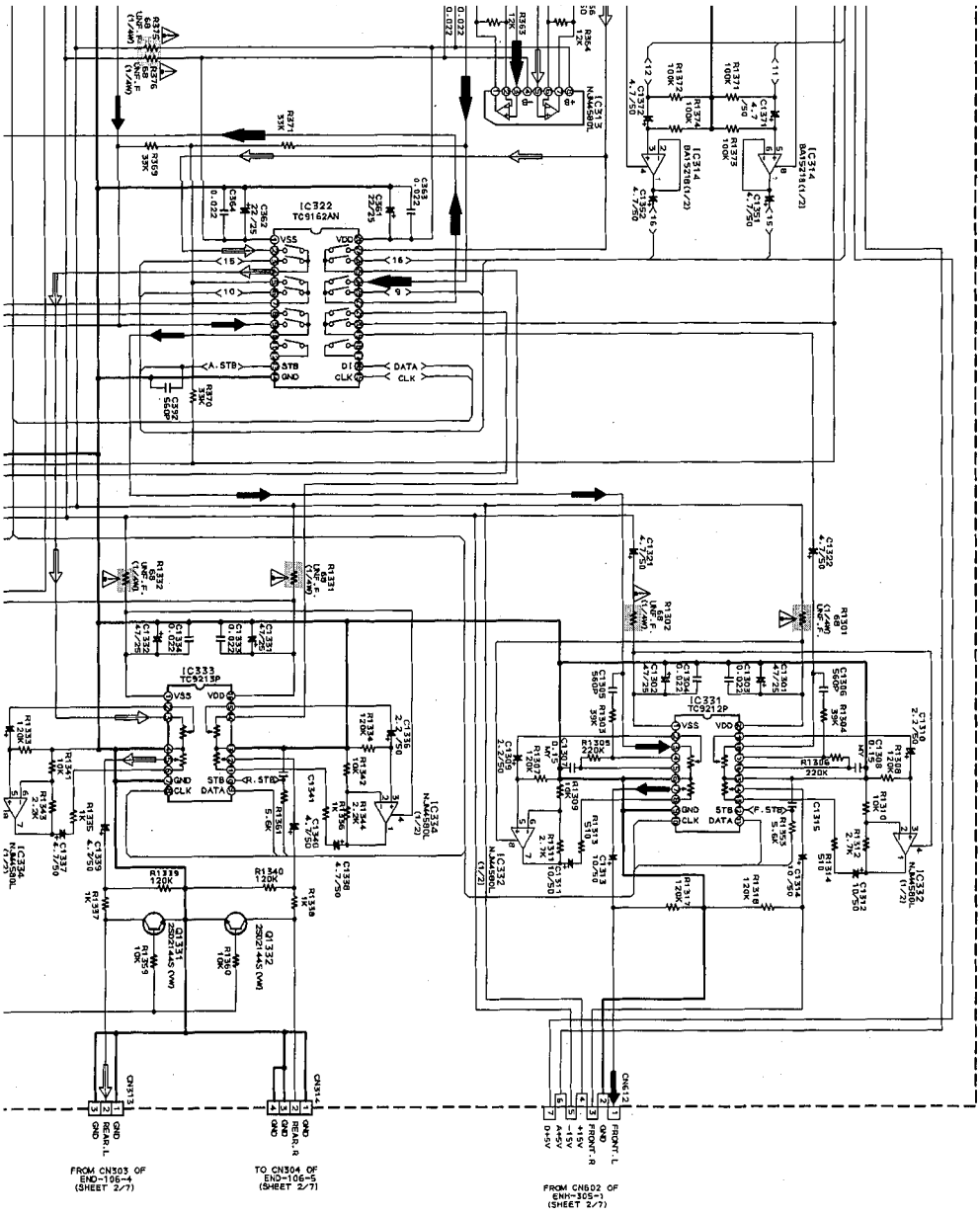

RX-992VBK
RX-992VBK

P2-38-a

P2-38-b

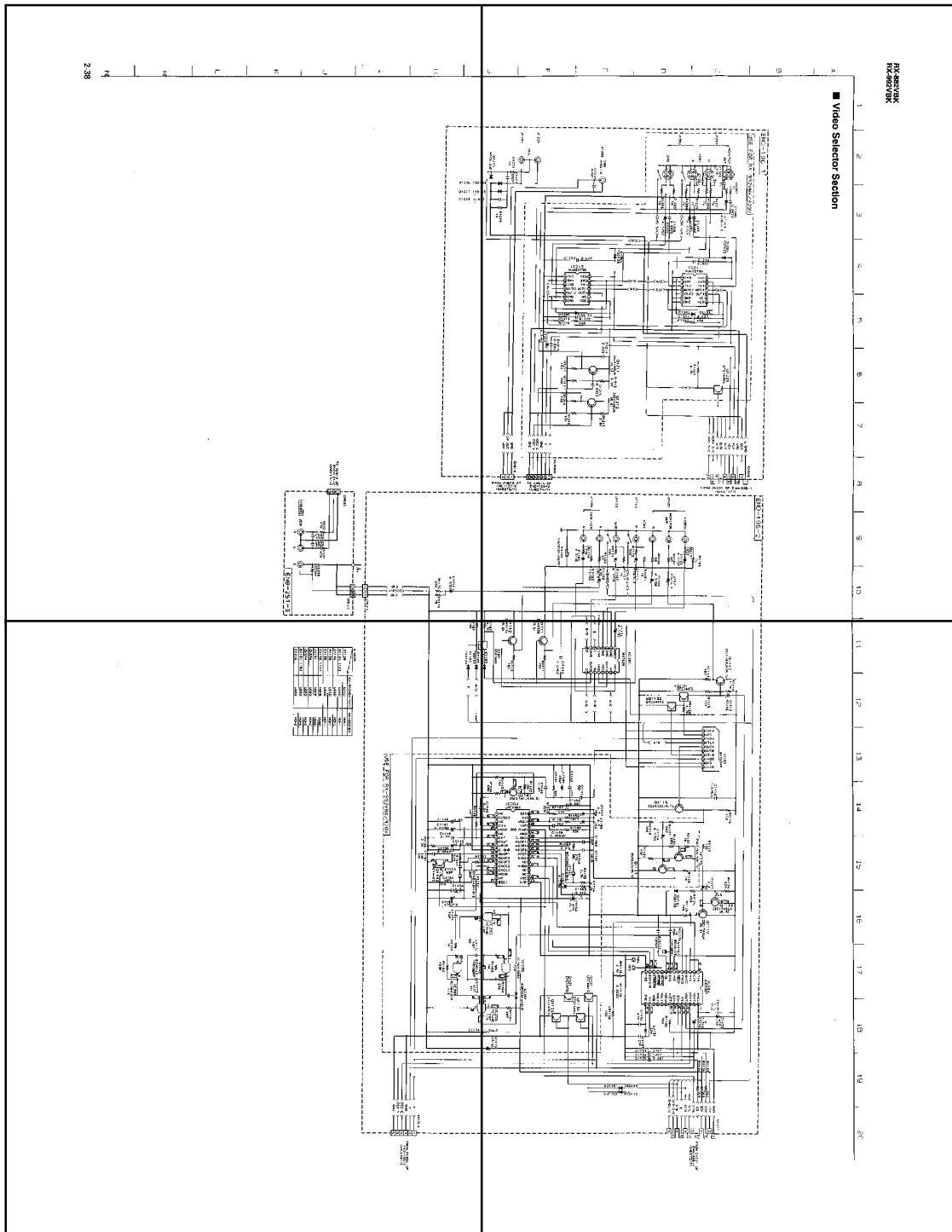

P2-38-c

P2-38-d

G
H
I
J
K
L
M
N

2-38

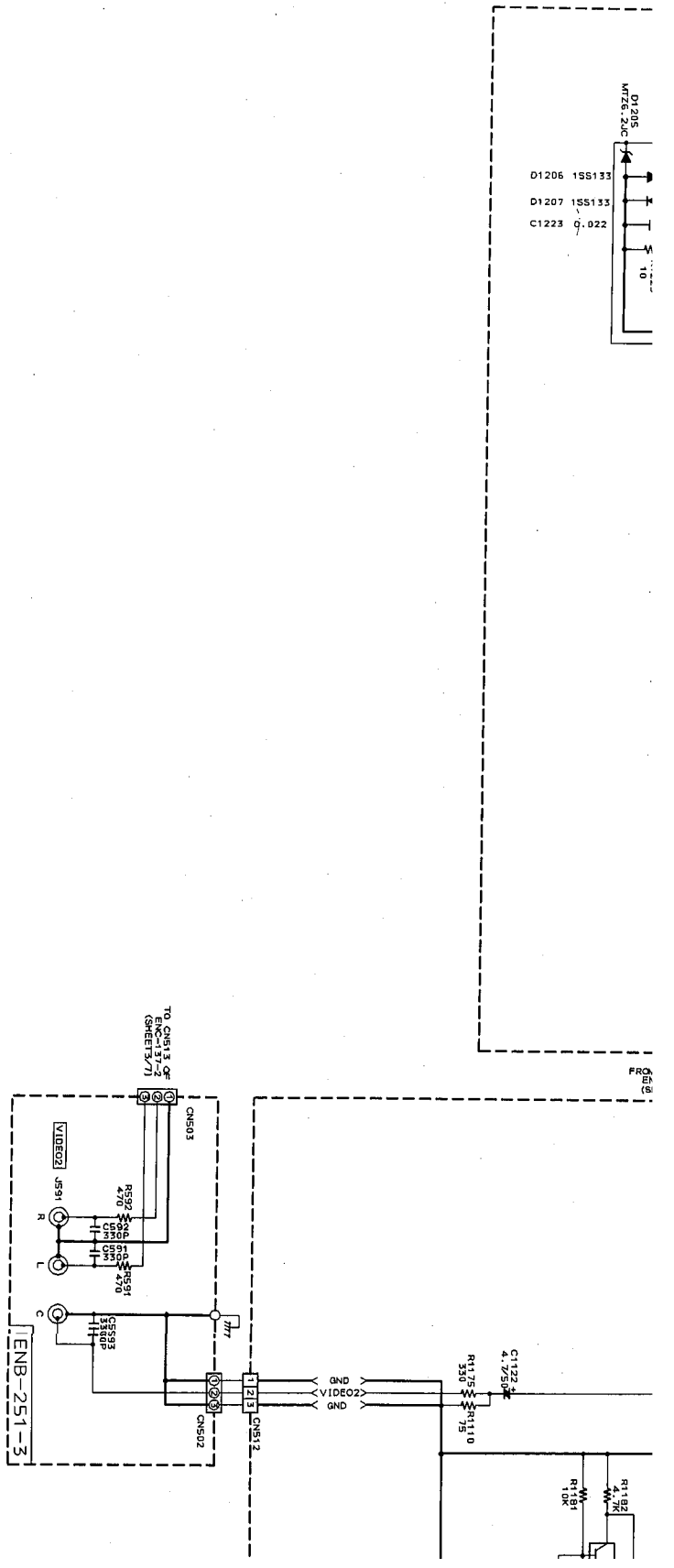
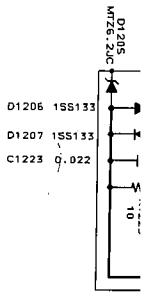

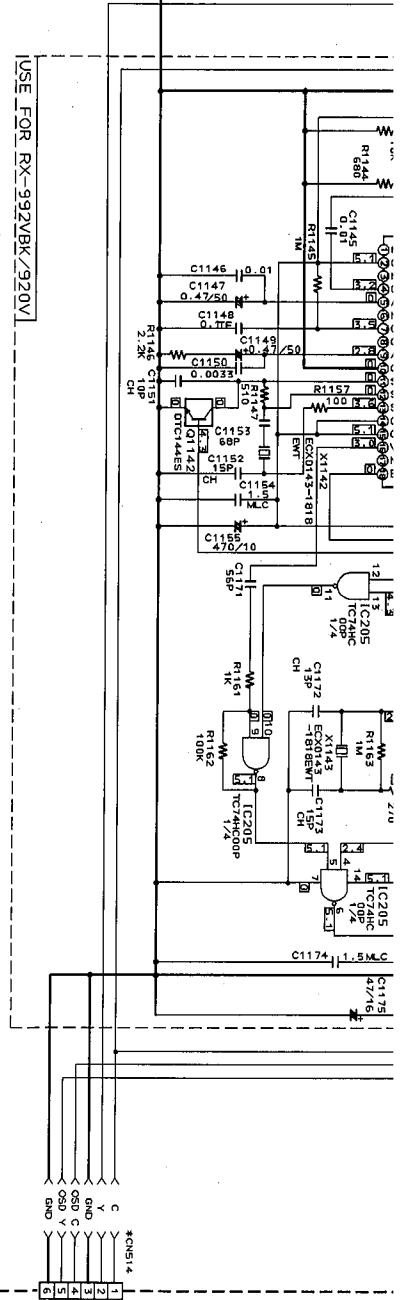
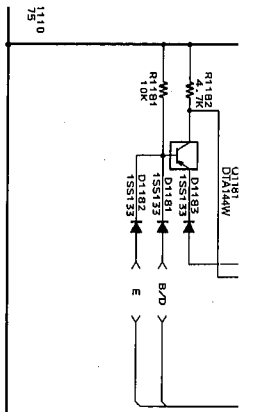

USE FOR RX-992VBK/920V

* MARK

MARK	RX-992VBK/920	RX-882VBK
R1128	USED	NONE
Q1121, 1122	USED	NONE
R1136	USED	NONE
R1138	USED	NONE
C1138	USED	NONE
C1176, 1177	NONE	NONE
X1161	NONE	USED
ONS14	USED	NONE
D1151, 1152	USED	NONE
C1216	USED	NONE

1-3

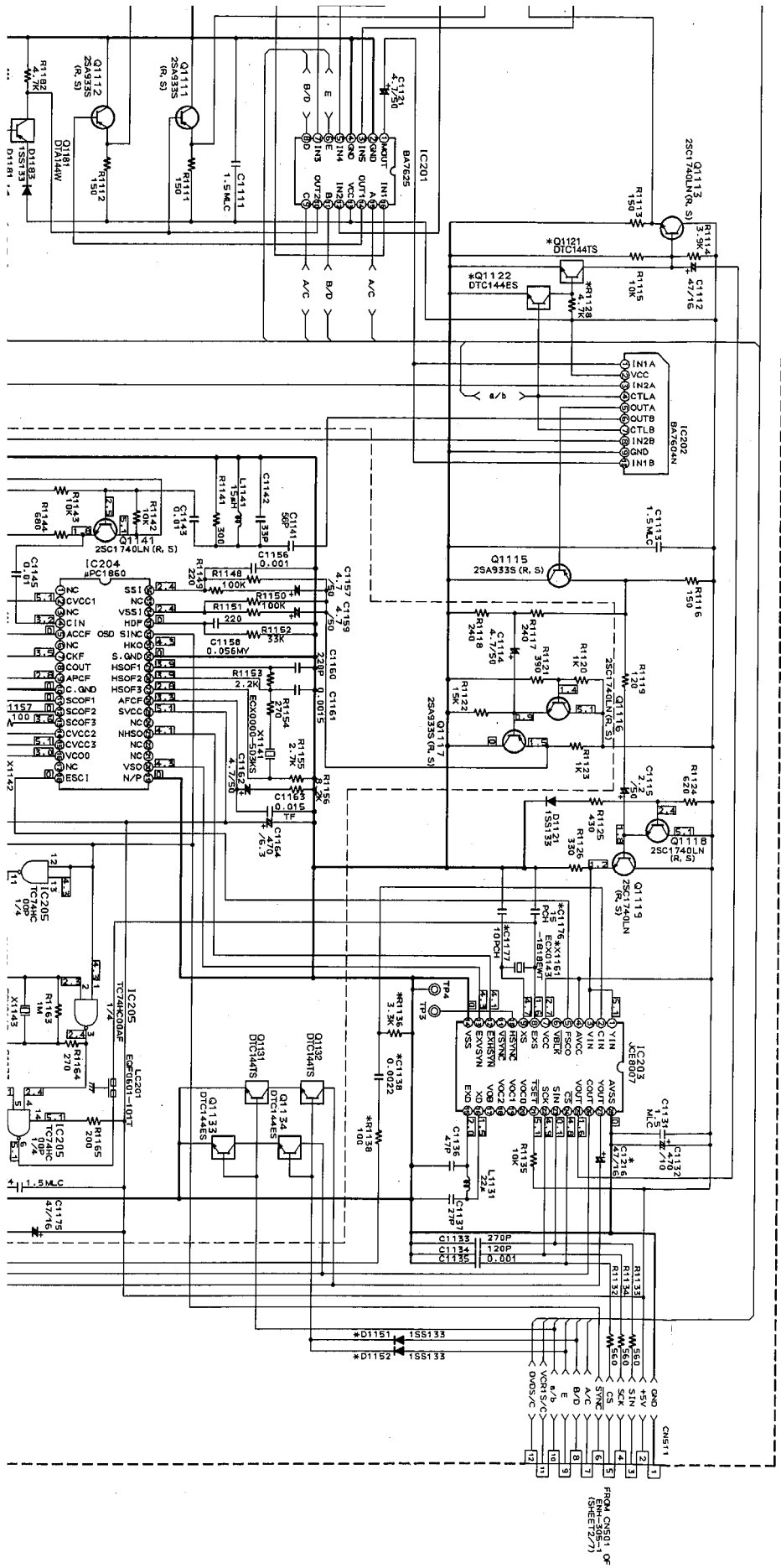

P2-39-a

P2-39-b

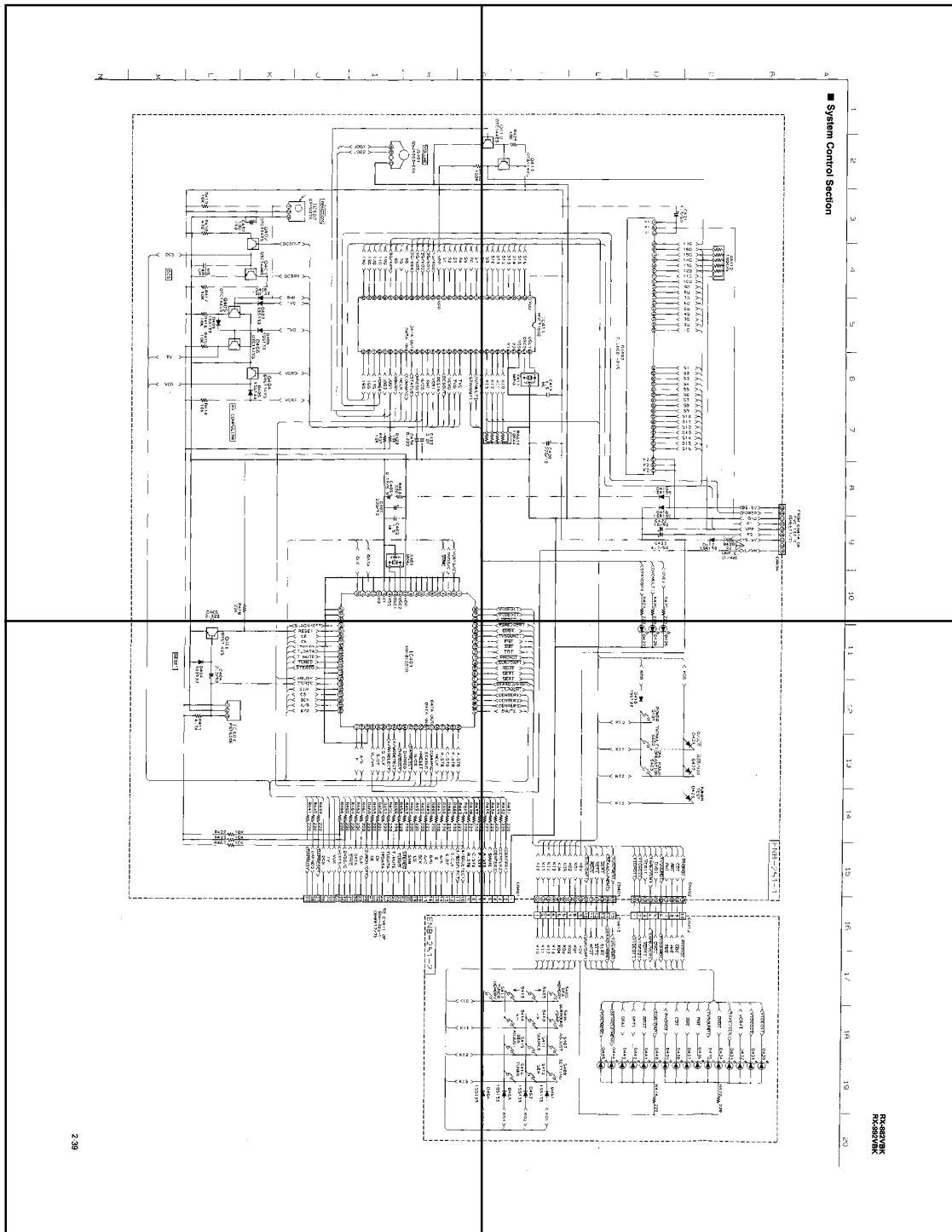

239

P2-39-c

P2-39-d

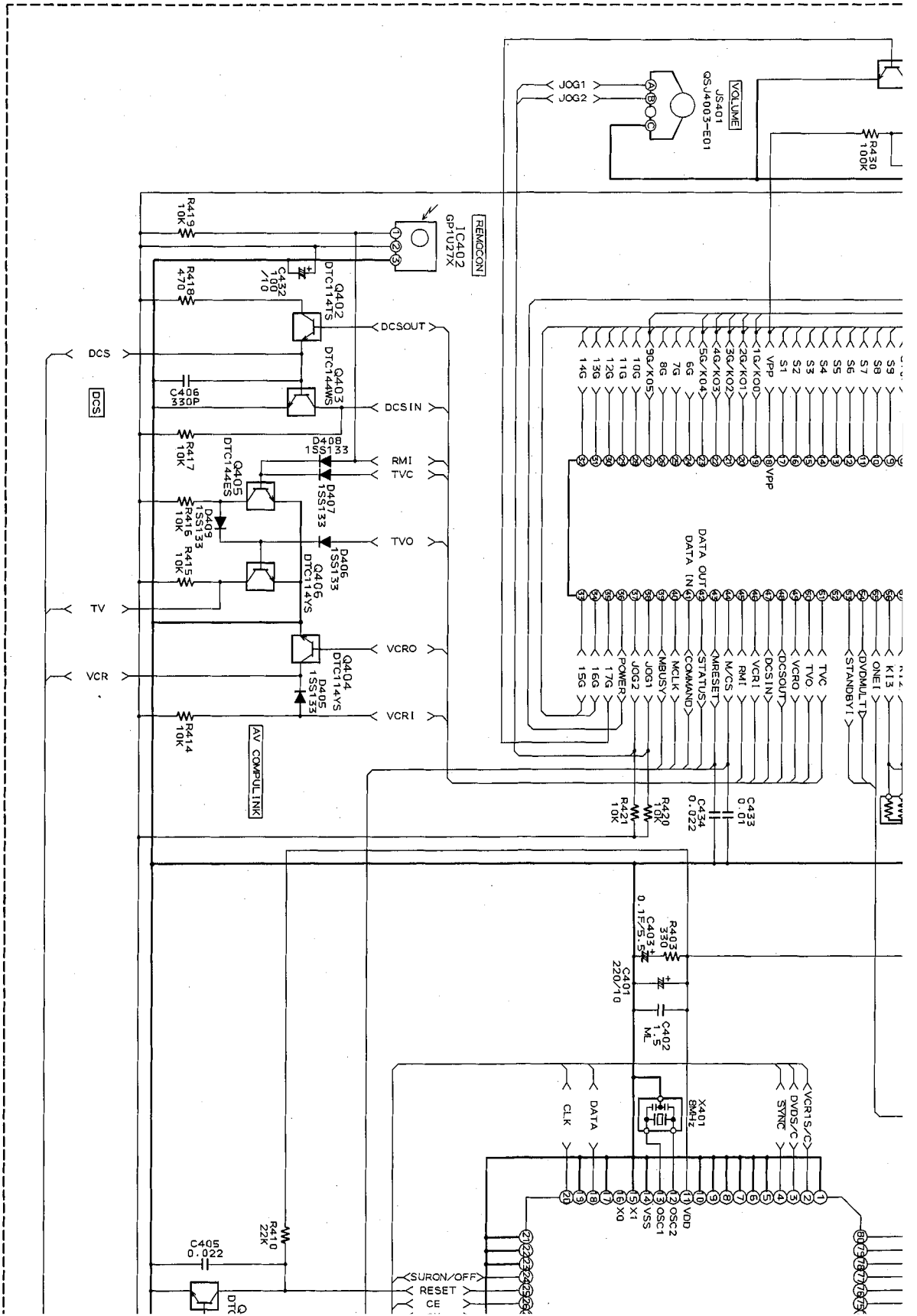

System Control Section

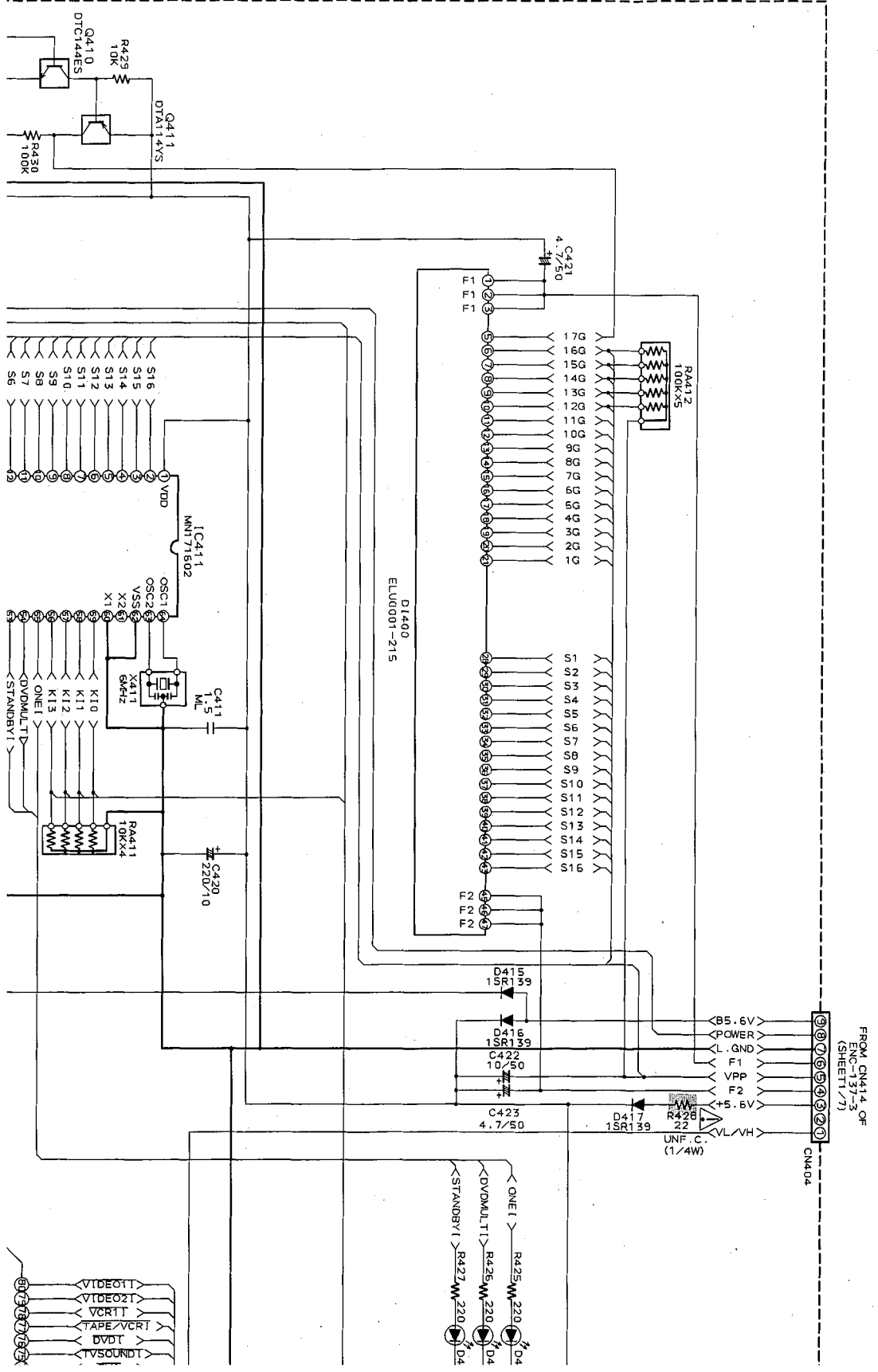

FROM CN414 OF ENC-137-3 (SHEET 1/7)

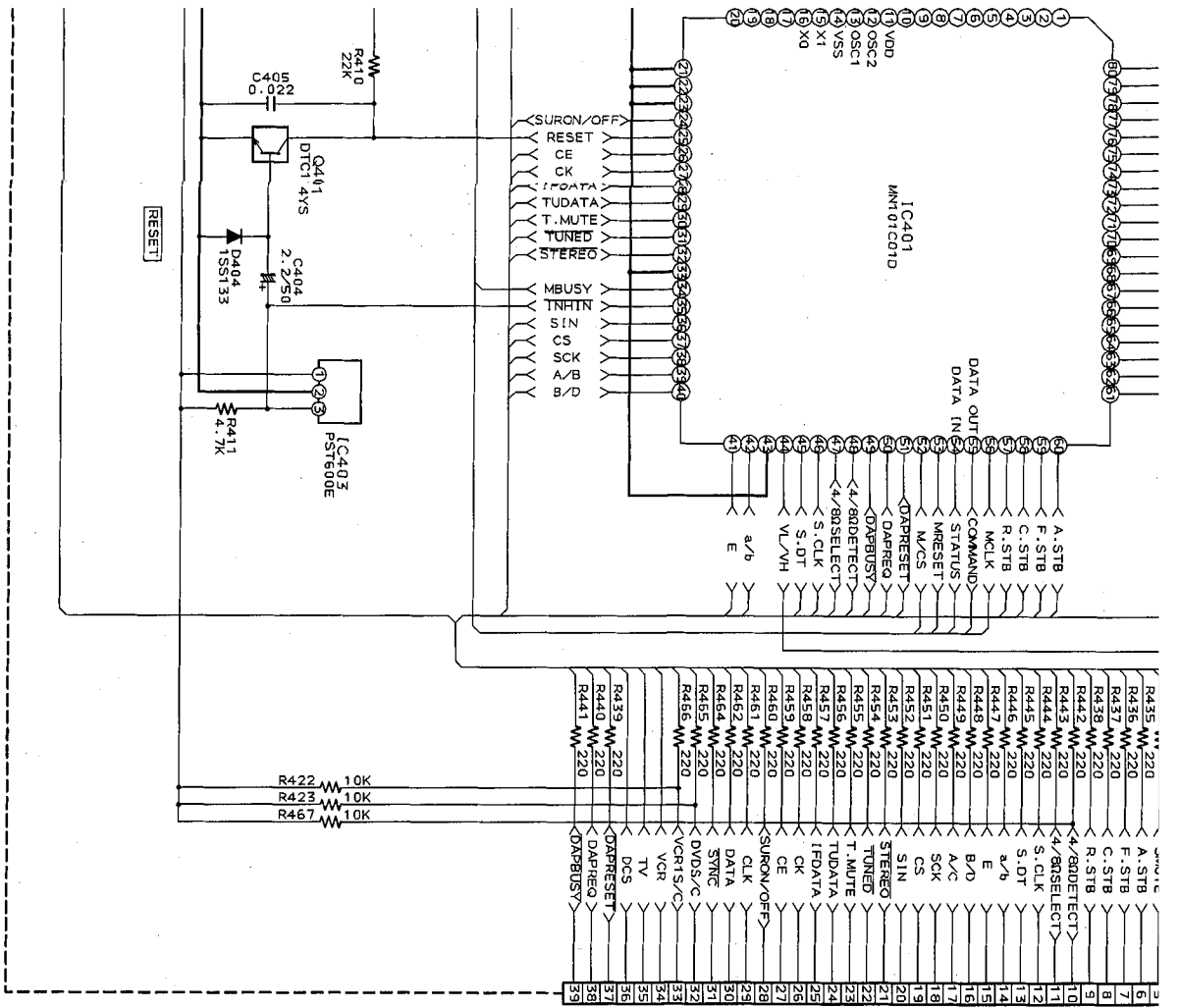

TO CN411 OF
ENH-305-1
(SHEET 2/7)

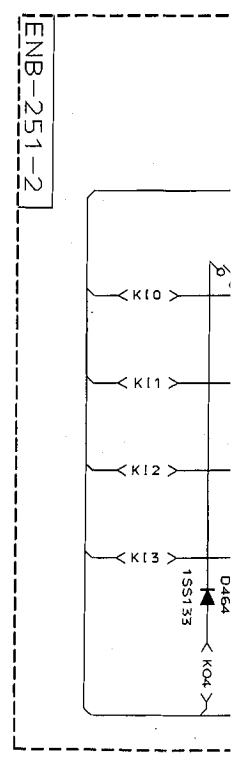

10 11 12 13 14 15 16 17 18 19 20

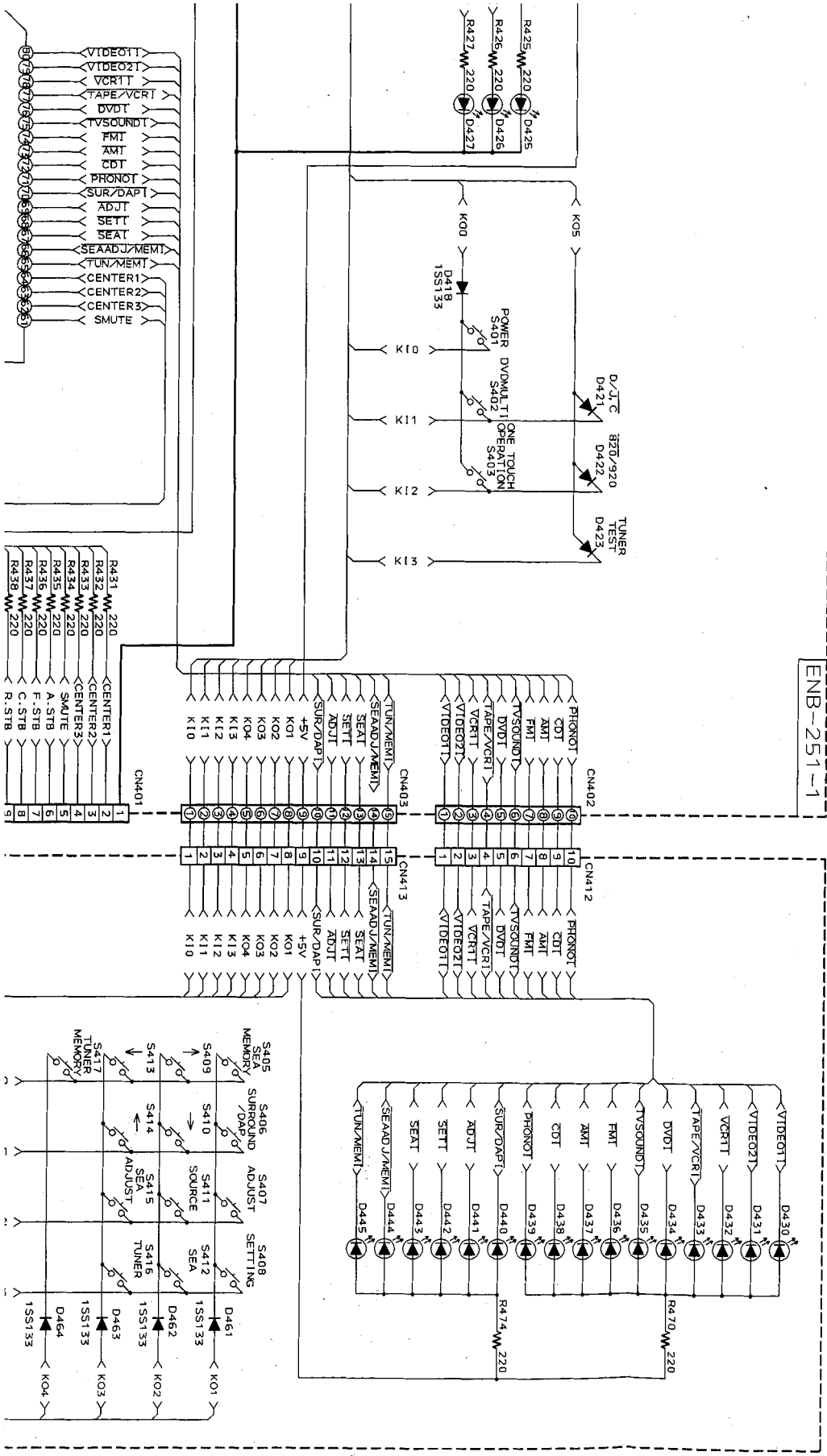

P2-40-a

P2-40-b

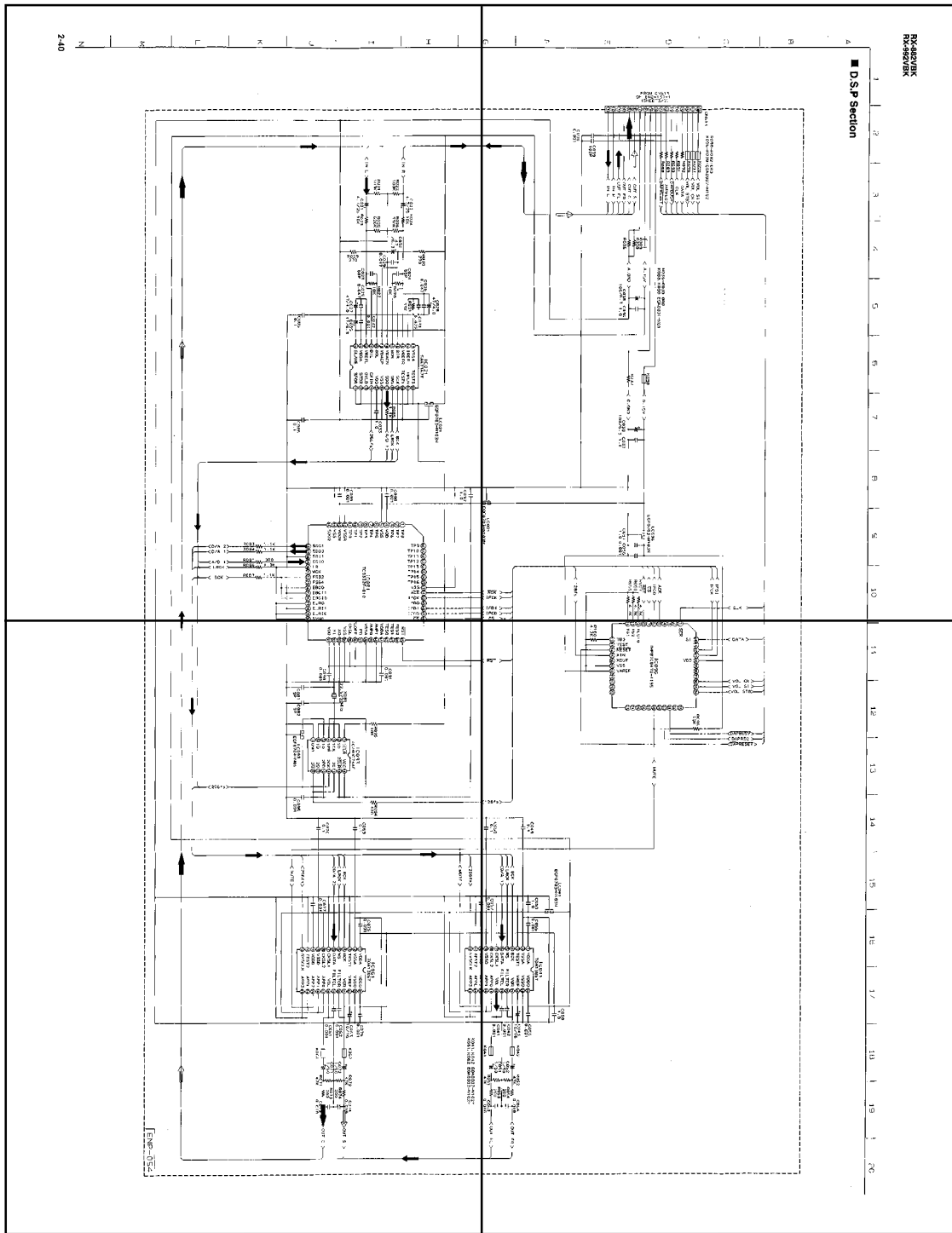

P2-40-c

P2-40-d

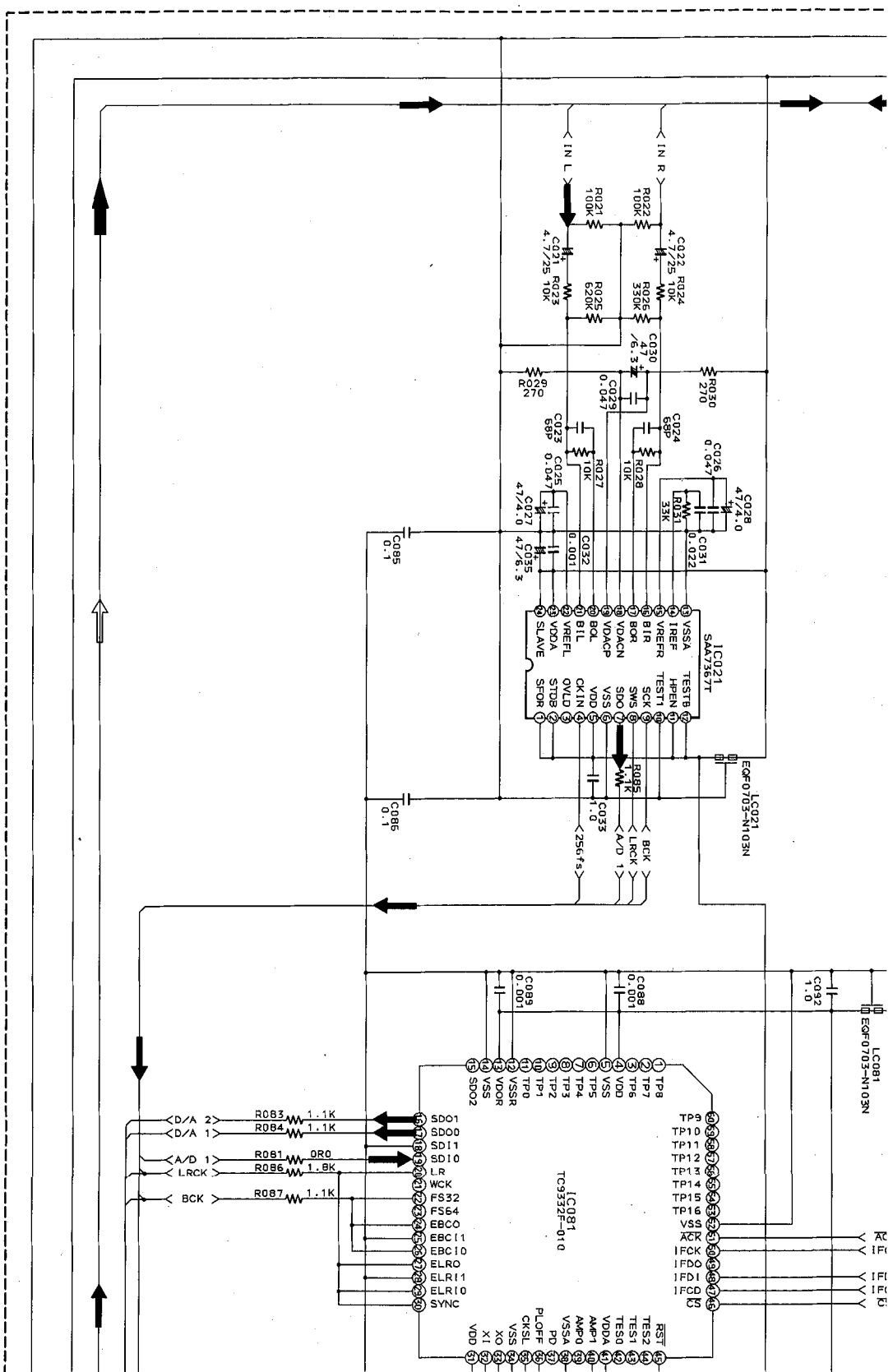

■ D.S.P Section

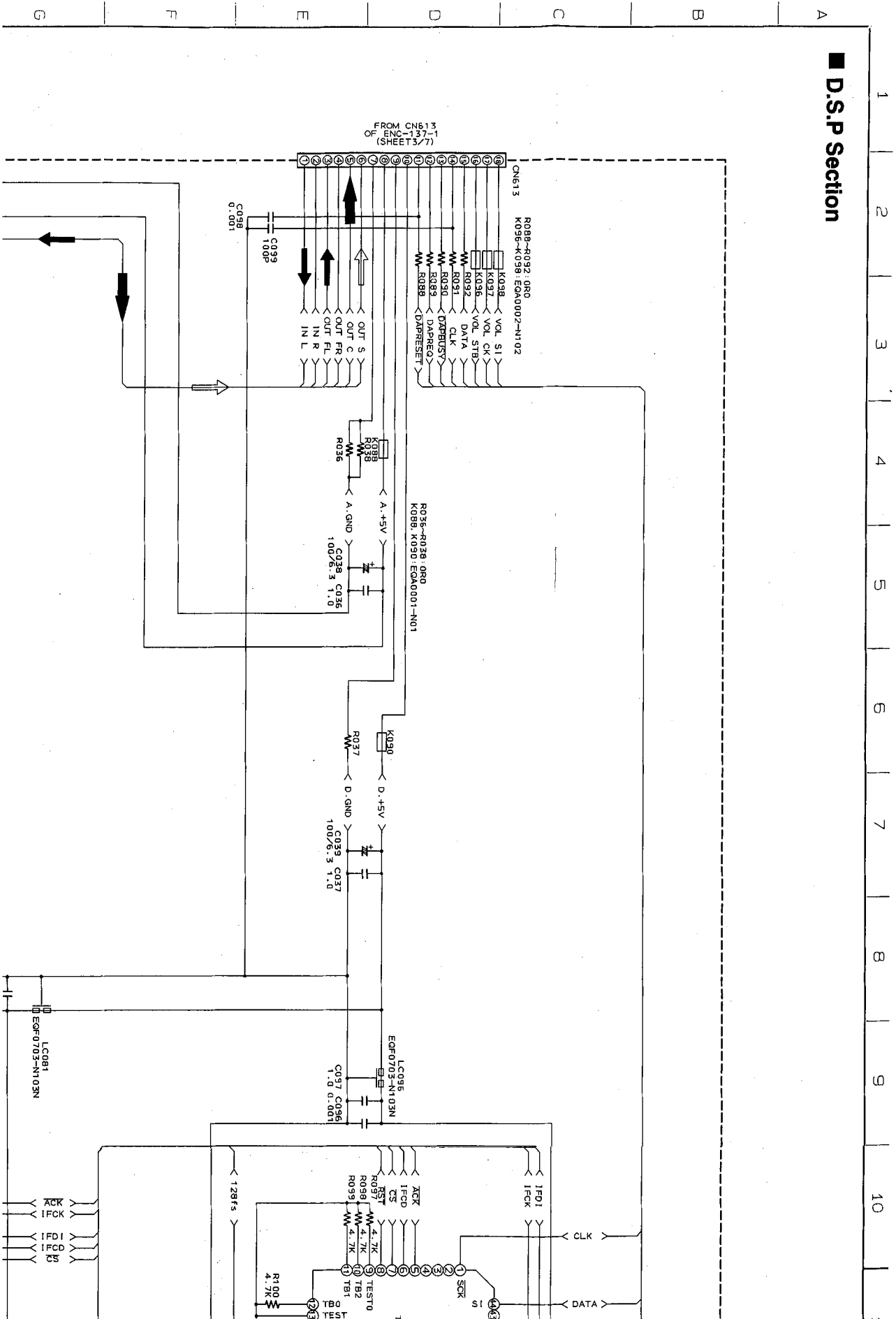

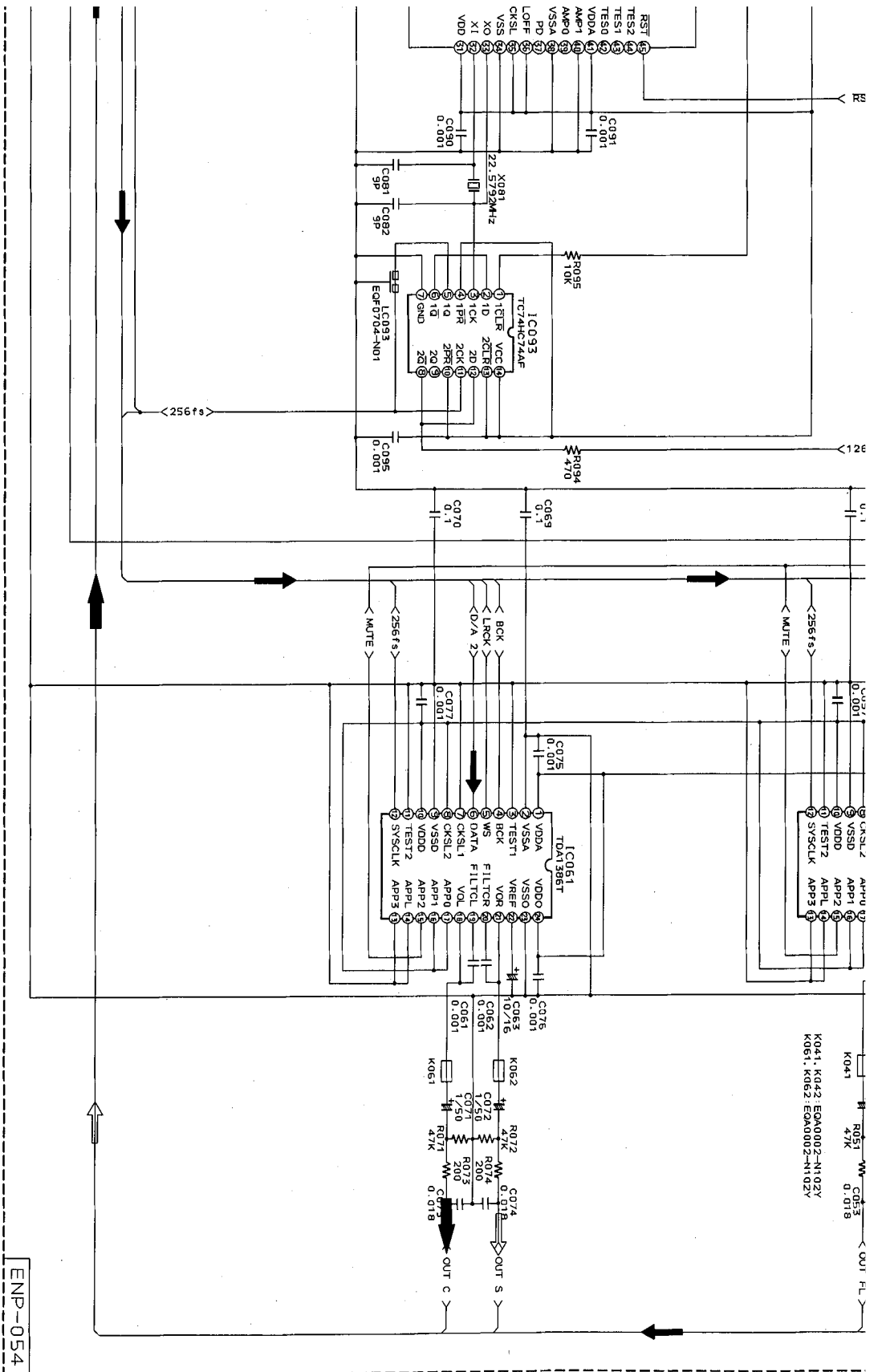

ENP-054

11 | 12 | 13 | 14 | 15 | 16 | 17 | 18 | 19 | 20

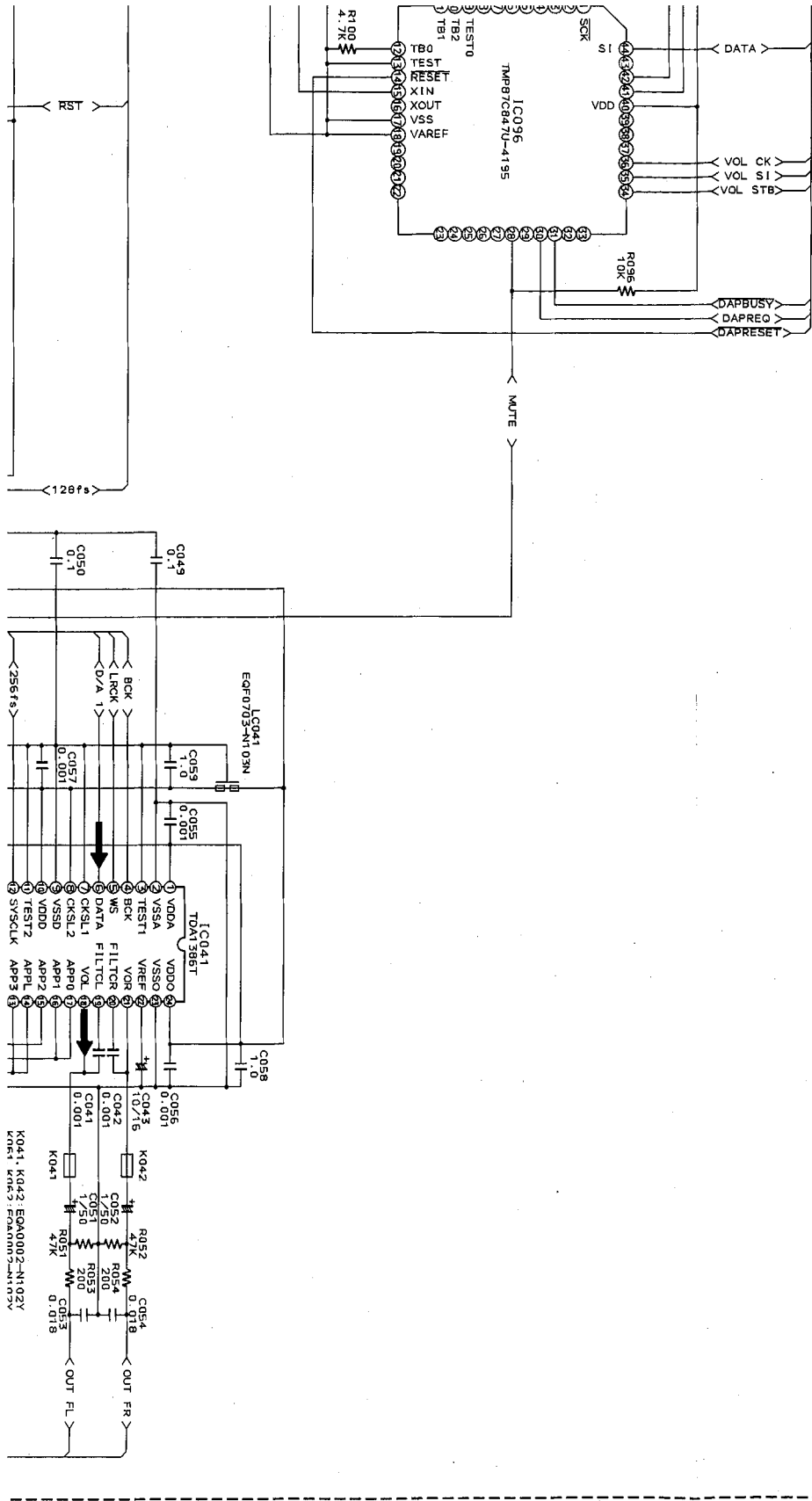

P2-41-a

P2-41-b

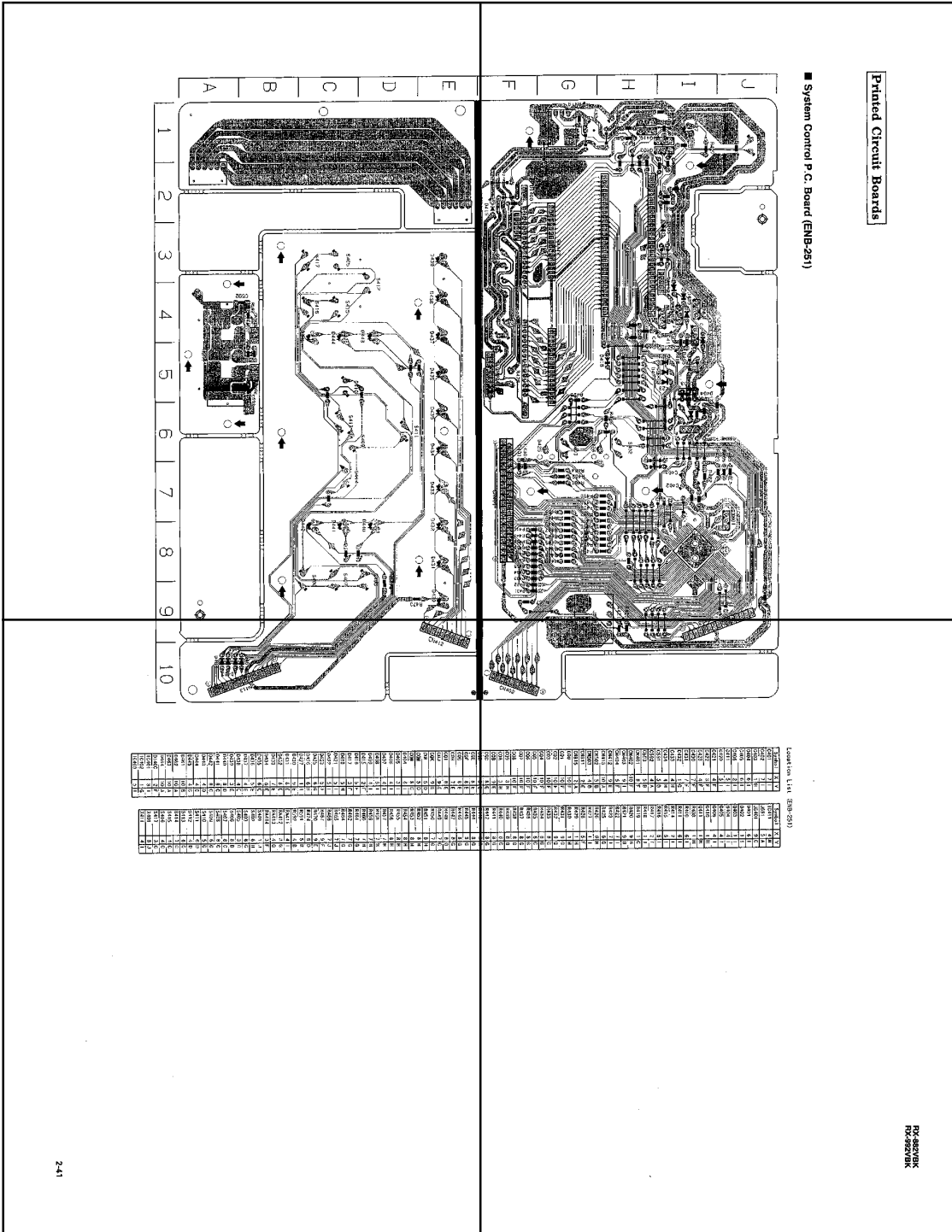

P2-41-c

P2-41-d

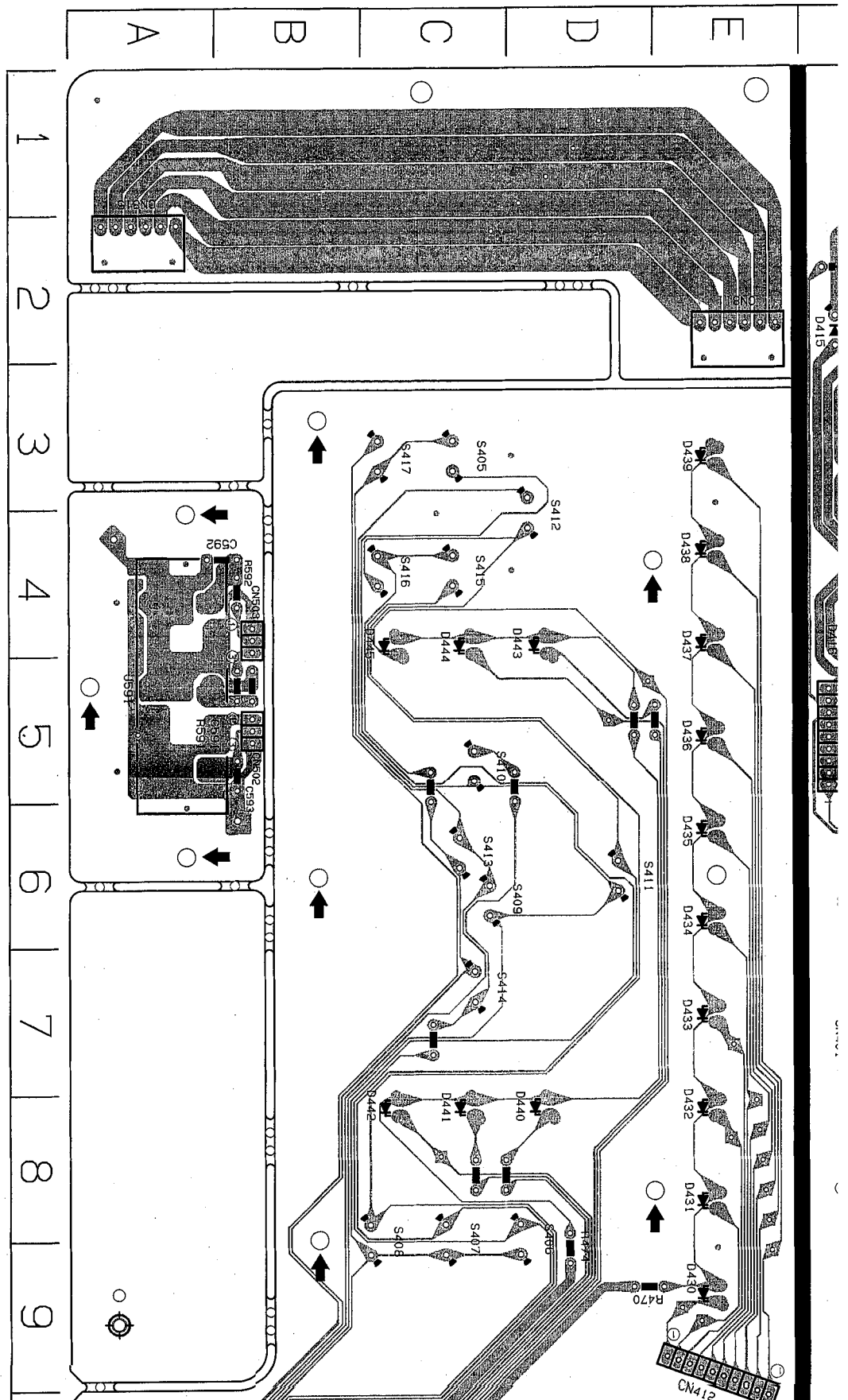

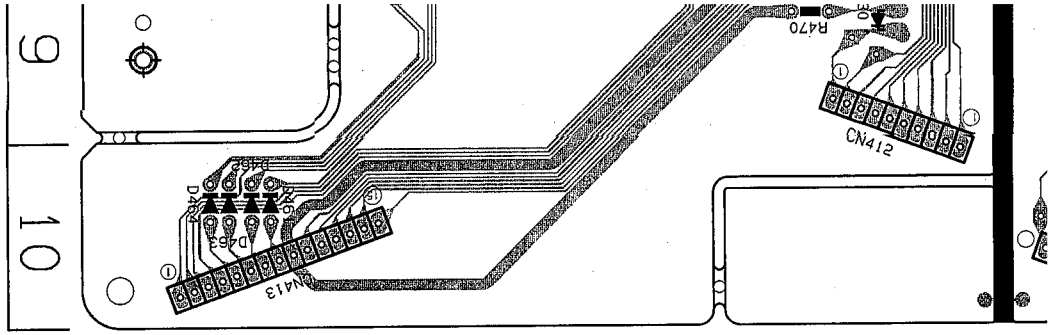

U400	9 E	R442	8 G
U00	8 E	R443	8 G
U0D	8 E	R444	8 G
U0E	8 E	R445	8 G
U0F	8 E	R446	8 G
U0G	8 E	R447	8 G
U0H	7 E	R448	8 G
U0I	8 E	R449	7 G
U0J	9 E	R450	7 G
U0K	9 E	R451	8 H
U0L	5 D	R452	8 H
U0M	5 D	R453	8 H
U0N	8 C	R454	8 H
U0O4	6 I	R455	8 H
U405	3 I	R456	8 H
U406	4 I	R457	7 H
U407	4 I	R458	7 H
U408	5 I	R459	7 H
U409	4 I	R460	7 H
U415	2 F	R461	7 H
U416	5 F	R462	7 G
U417	3 F	R463	7 G
U418	3 H	R464	7 G
U421	5 I	R465	7 J
U422	5 I	R466	7 J
U423	5 I	R467	9 F
U425	6 G	R470	9 E
U426	6 H	R474	8 D
U427	1 I	R591	5 B
U430	9 E	R592	4 B
U431	8 E	RA411	4 I
U432	8 E	RA412	3 G
U433	7 E	RA413	4 G
U434	6 E	RA414	3 F
U435	6 E	S401	1 J
U436	5 E	S402	6 H
U437	4 E	S403	6 G
U438	4 E	S405	3 C
U439	3 E	S406	8 D
U440	8 D	S407	8 C
U441	8 C	S408	8 C
U442	8 C	S409	6 C
U443	4 D	S410	5 C
U444	4 C	S411	6 D
U445	4 C	S412	4 D
U461	10 B	S413	6 C
U462	10 A	S414	7 C
U463	10 A	S415	4 C
U464	10 A	S416	4 C
D1400	2 F	S417	3 C
D1401	8 I	X401	8 J
D1402	1 G	X411	4 I
D1403	5 I		

Location List (ENB-251)

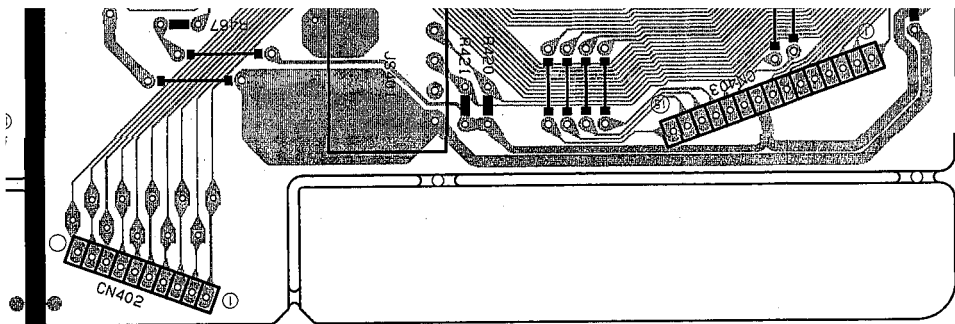

Symbol	X	Y	Symbol	X	Y
C401	7	I	IC411	4	H
C402	7	I	J591	5	A
C403	1	H	JS401	9	G
C404	6	I	Q401	6	I
C405	6	I	Q402	1	I
C406	2	I	Q403	1	I
C411	5	I	Q404	4	I
C420	5	I	Q405	4	I
C421	4	F	Q406	4	I
C422	3	F	Q410	1	H
C423	4	F	Q411	1	H
C430	7	F	R403	1	H
C431	7	F	R410	6	I
C432	1	G	R411	6	I
C433	4	H	R414	2	I
C434	4	H	R415	5	I
C591	5	B	R416	5	I
C592	4	A	R417	2	I
C593	5	B	R418	1	I
CN401	8	F	R419	1	G
CN402	10	F	R420	9	H
CN403	9	I	R421	9	H
CN404	5	F	R422	7	I
CN412	9	E	R423	7	I
CN413	10	A	R425	6	G
CN502	5	B	R426	6	H
CN503	4	B	R427	1	I
CN811	2	E	R428	5	F
CN815	2	A	R429	1	H
Q00	10	F	R430	1	H
Q01	10	F	R431	9	G
Q02	10	F	R432	9	G
Q03	10	F	R433	8	G
Q04	10	F	R434	8	G
Q05	10	F	R435	8	G
Q06	10	F	R436	8	G
Q07	10	F	R437	8	G
Q08	10	F	R438	8	G
Q09	3	H	R439	8	G
Q0A	3	H	R440	8	G
Q0B	9	E	R441	8	G
Q0C	8	E	R442	8	G
Q0D	8	E	R443	8	G
Q0E	8	E	R444	8	G

P2-42-a

P2-42-b

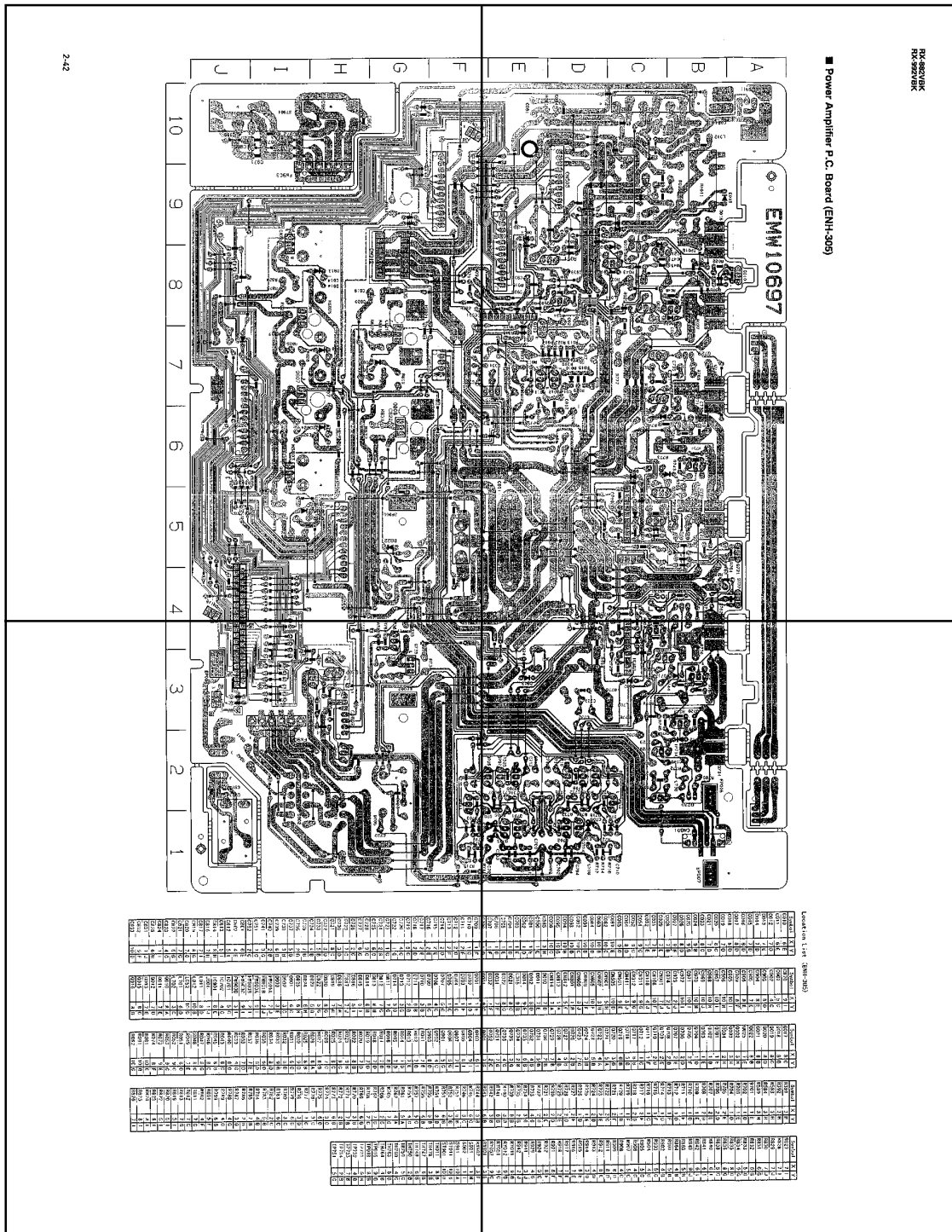

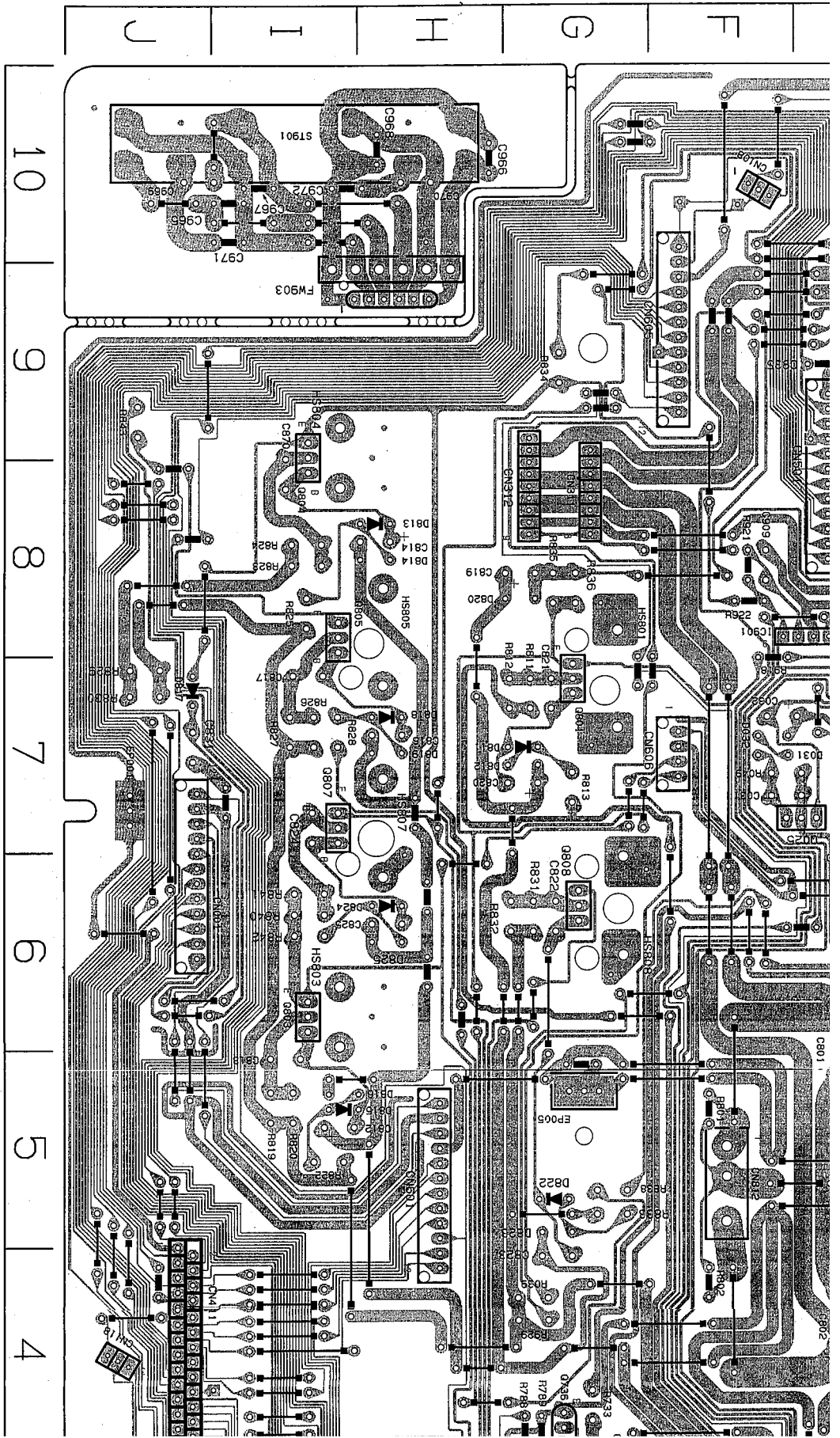

■ Power Amplifier P.C. Board (ENH-305)

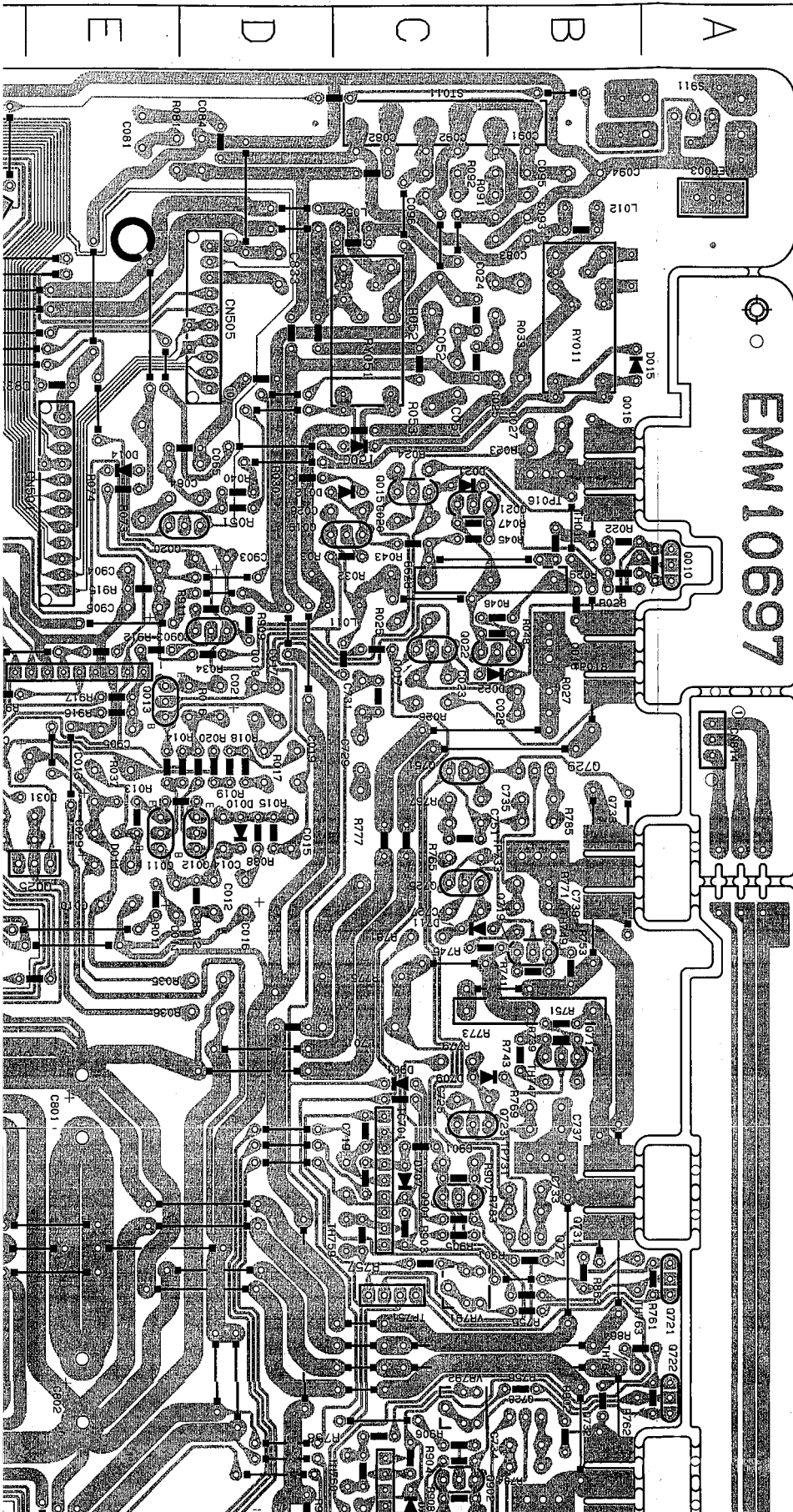

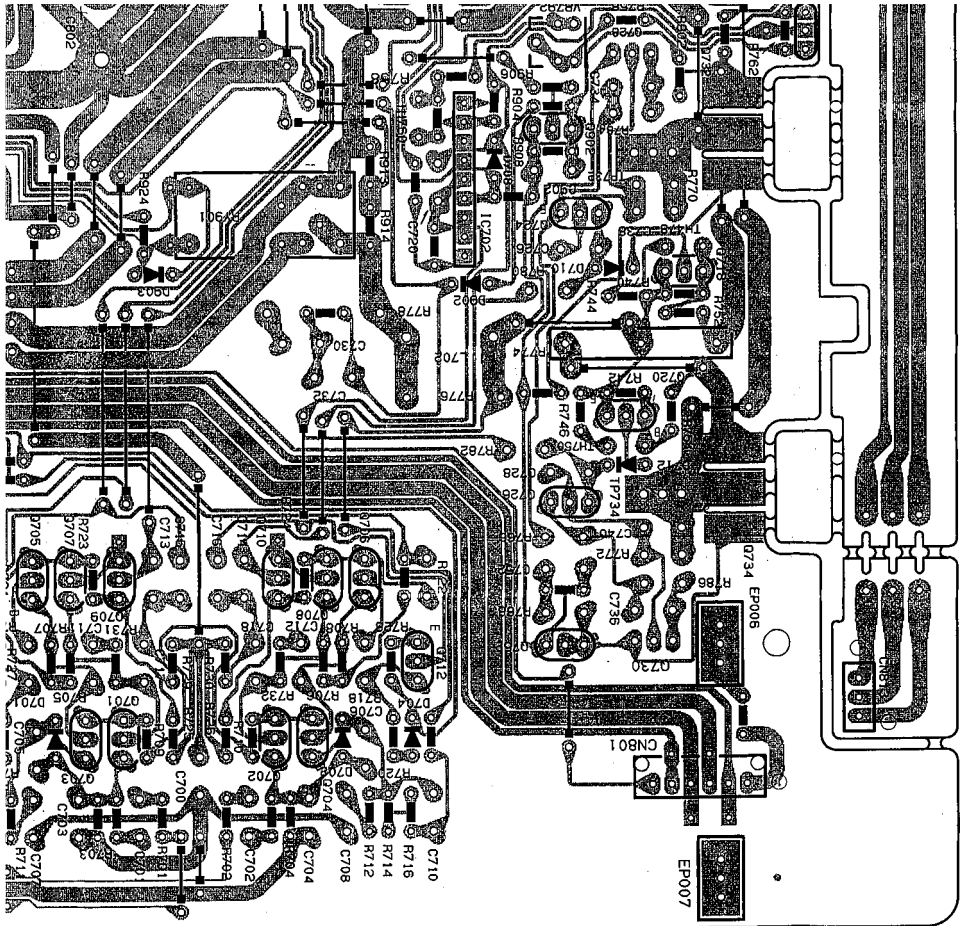

Location List (ENH-305)

Symbol	X	Y	Symbol	X	Y	Symbol	X	Y	Symbol	X	Y	Symbol	X	Y
C010	6E	9I	G870	9I	1	0017	8C	3H	R327	7I	1	R827	7I	1
C011	6E	5C	G901	5C	1	0018	8B	3H	R392	3H	7I	R828	7I	1
C012	7D	4G	G902	4G	1	0019	8C	3H	R583	3H	7J	R829	7J	1
C013	7E	8D	G903	8D	1	0020	8D	3H	R584	3H	7J	R830	7J	1
C014	7D	8E	G904	8E	1	0021	8B	3H	R589	3H	6G	R831	6G	6
C015	7D	7E	G905	7E	1	0022	8B	3H	R701	1E	6G	R832	6G	6
C016	6D	8E	G906	8E	1	0025	7E	3H	R702	1D	5G	R833	5G	6
C017	8D	8F	G909	8F	1	0302	3H	1E	R703	1E	9G	R834	9G	6
C018	8D	10I	G965	10I	1	0303	3H	2E	R704	1D	8G	R835	8G	6
C019	7D	10H	G966	10H	1	0304	2H	2E	R705	2E	5G	R836	8G	6
C020	8C	10I	G967	10I	1	0701	1D	2D	R706	1E	6I	R838	6I	1
C021	7D	10H	G968	10H	1	0702	1E	2E	R707	2E	6I	R840	6I	1
C022	8C	10H	G969	10J	1	0703	1E	2E	R708	2D	6I	R841	6I	1
C023	8C	10H	G970	10H	1	0704	1D	2E	R709	1E	6I	R842	6I	1
C024	9B	10I	G971	10I	1	0705	2F	2E	R710	1D	9J	R843	9J	1
C025	9B	10I	G972	10I	1	0706	2E	2E	R711	1E	4B	R864	4B	1
C026	8D	2J	G973	2J	1	0707	2E	2E	R712	1F	4B	R864	4B	1
C027	9B	2J	G974	2J	1	0708	2D	2E	R713	1D	4B	R864	4B	1
C028	7B	7J	G975	7J	1	0709	2E	2E	R714	1D	4B	R864	4B	1
C029	7E	7J	G976	7J	1	0710	2D	2E	R715	1F	4C	R901	4C	1
C030	7E	7E	G977	7E	1	0711	1F	1E	R716	1C	4C	R902	4C	1
C031	7E	4J	G978	4J	1	0712	1C	6B	R717	2F	4C	R903	4C	1
C032	7E	9G	G979	9G	1	0713	1C	6B	R718	2D	4C	R904	4C	1
C033	9C	9G	G980	9G	1	0714	3B	3B	R719	1F	4C	R905	4C	1
C034	8D	3J	G981	3J	1	0715	6B	3B	R720	1D	4C	R906	4C	1
C035	9D	10D	G982	10D	1	0716	6B	3B	R721	2F	4C	R907	4C	1
C036	9D	10D	G983	10D	1	0717	5A	3B	R722	2C	4C	R908	4C	1
C037	10E	5H	G984	5H	1	0718	5A	3B	R723	2C	4C	R909	4C	1
C038	10C	5H	G985	5H	1	0719	4A	3B	R724	2E	4C	R910	4C	1
C039	10B	5H	G986	5H	1	0720	4A	3B	R725	2E	4C	R911	4C	1
C040	10B	5H	G987	5H	1	0721	3B	3B	R726	2E	4C	R912	4C	1
C041	10B	5H	G988	5H	1	0722	3B	3B	R727	2E	4C	R913	4C	1
C042	10B	5H	G989	5H	1	0723	3B	3B	R728	2E	4C	R914	4C	1
C043	10B	5H	G990	5H	1	0724	3B	3B	R729	2E	4C	R915	4C	1
C044	10B	5H	G991	5H	1	0725	3B	3B	R730	2E	4C	R916	4C	1
C045	10B	5H	G992	5H	1	0726	3B	3B	R731	2E	4C	R917	4C	1
C046	10B	5H	G993	5H	1	0727	3B	3B	R732	2E	4C	R918	4C	1
C047	10B	5H	G994	5H	1	0728	3B	3B	R733	2E	4C	R919	4C	1
C048	10B	5H	G995	5H	1	0729	3B	3B	R734	2E	4C	R920	4C	1
C049	10B	5H	G996	5H	1	0730	3B	3B	R735	2E	4C	R921	4C	1
C050	10C	7A	G997	7A	1	0731	2B	2E	R736	2E	4C	R922	4C	1
C051	10C	7A	G998	7A	1	0732	2B	2E	R737	2E	4C	R923	4C	1
C052	10C	7A	G999	7A	1	0733	2B	2E	R738	2E	4C	R924	4C	1
C053	10C	7A	G1000	7A	1	0734	2B	2E	R739	2E	4C	R925	4C	1
C054	10C	7A	G1001	7A	1	0735	2B	2E	R740	2E	4C	R926	4C	1
C055	10C	7A	G1002	7A	1	0736	2B	2E	R741	2E	4C	R927	4C	1
C056	10C	7A	G1003	7A	1	0737	2B	2E	R742	2E	4C	R928	4C	1
C057	10C	7A	G1004	7A	1	0738	2B	2E	R743	2E	4C	R929	4C	1
C058	10C	7A	G1005	7A	1	0739	2B	2E				R930	4C	1
C059	10C	7A	G1006	7A	1	0740	2B	2E				R931	4C	1
C060	10C	7A	G1007	7A	1	0741	2B	2E				R932	4C	1
C061	10C	7A	G1008	7A	1	0742	2B	2E				R933	4C	1
C062	10C	7A	G1009	7A	1	0743	2B	2E				R934	4C	1
C063	10C	7A	G1010	7A	1	0744	2B	2E				R935	4C	1
C064	10C	7A	G1011	7A	1	0745	2B	2E				R936	4C	1
C065	10C	7A	G1012	7A	1	0746	2B	2E				R937	4C	1
C066	10C	7A	G1013	7A	1	0747	2B	2E				R938	4C	1
C067	10C	7A	G1014	7A	1	0748	2B	2E				R939	4C	1
C068	10C	7A	G1015	7A	1	0749	2B	2E				R940	4C	1
C069	10C	7A	G1016	7A	1	0750	2B	2E				R941	4C	1
C070	10C	7A	G1017	7A	1	0751	2B	2E				R942	4C	1
C071	10C	7A	G1018	7A	1	0752	2B	2E				R943	4C	1
C072	10C	7A	G1019	7A	1	0753	2B	2E				R944	4C	1
C073	10C	7A	G1020	7A	1	0754	2B	2E				R945	4C	1
C074	10C	7A	G1021	7A	1	0755	2B	2E				R946	4C	1
C075	10C	7A	G1022	7A	1	0756	2B	2E				R947	4C	1
C076	10C	7A	G1023	7A	1	0757	2B	2E				R948	4C	1
C077	10C	7A	G1024	7A	1	0758	2B	2E				R949	4C	1
C078	10C	7A	G1025	7A	1	0759	2B	2E				R950	4C	1
C079	10C	7A	G1026	7A	1	0760	2B	2E				R951	4C	1
C080	10C	7A	G1027	7A	1	0761	2B	2E				R952	4C	1
C081	10C	7A	G1028	7A	1	0762	2B	2E				R953	4C	1
C082	10C	7A	G1029	7A	1	0763	2B	2E				R954	4C	1
C083	10C	7A	G1030	7A	1	0764	2B	2E				R955	4C	1
C084	10C	7A	G1031	7A	1	0765	2B	2E				R956	4C	1
C085	10C	7A	G1032	7A	1	0766	2B	2E				R957	4C	1
C086	10C	7A	G1033	7A	1	0767	2B	2E				R958	4C	1
C087	10C	7A	G1034	7A	1	0768	2B	2E				R959	4C	1
C088	10C	7A	G1035	7A	1	0769	2B	2E				R960	4C	1
C089	10C	7A	G1036	7A	1	0770	2B	2E				R961	4C	1
C090	10C	7A	G1037	7A	1	0771	2B	2E				R962	4C	1
C091	10C	7A	G1038	7A	1	0772	2B	2E				R963	4C	1
C092	10C	7A	G1039	7A	1	0773	2B	2E				R964	4C	1
C093	10C	7A	G1040	7A	1	0774	2B	2E				R965	4C	1
C094	10C	7A	G1041	7A	1	0775	2B	2E				R966	4C	1
C095	10C	7A	G1042	7A	1	0776	2B	2E				R967	4C	1
C096	10C	7A	G1043	7A	1	0777	2B	2E				R968	4C	1
C097	10C	7A	G1044	7A	1	0778	2B	2E				R969	4C	1
C098	10C	7A	G1045	7A	1	0779	2B	2E				R970	4C	1
C099	10C	7A	G1046	7A	1	0780	2B	2E				R971	4C	1
C100	10C	7A	G1047	7A	1	0781	2B	2E				R972	4C	1
C101	10C	7A	G1048	7A	1	0782	2B	2E				R973	4C	1
C102	10C	7A	G1049	7A	1	0783	2B	2E				R974	4C	1
C103	10C	7A	G1050	7A	1	0784	2B	2E				R975	4C	1
C104	10C	7A	G1051	7A	1	0785	2B	2E				R976	4C	1
C105	10C	7A	G1052	7A	1	0786	2B	2E				R977	4C	1
C106	10C	7A	G1053	7A	1	0787	2B	2E				R978	4C	1
C107	10C	7A	G1054	7A	1	0788	2B	2E				R979	4C	1
C108	10C	7A	G1055	7A	1	0789	2B	2E				R980	4C	1
C109	10C	7A	G1056	7A	1	0790	2B	2E				R981	4C	1
C110	10C	7A	G1057	7A	1	0791	2B	2E				R982	4C	1
C111	10C	7A	G1058	7A	1	0792	2B	2E				R983	4C	1
C112	10C	7A	G1059	7A	1	0793	2B	2E				R984	4C	1
C113	10C	7A	G1060	7A	1	0794	2B	2E				R985	4C	1
C114	10C	7A	G1061	7A	1	0795	2B	2E				R986	4C	1
C115	10C	7A	G1062	7A										

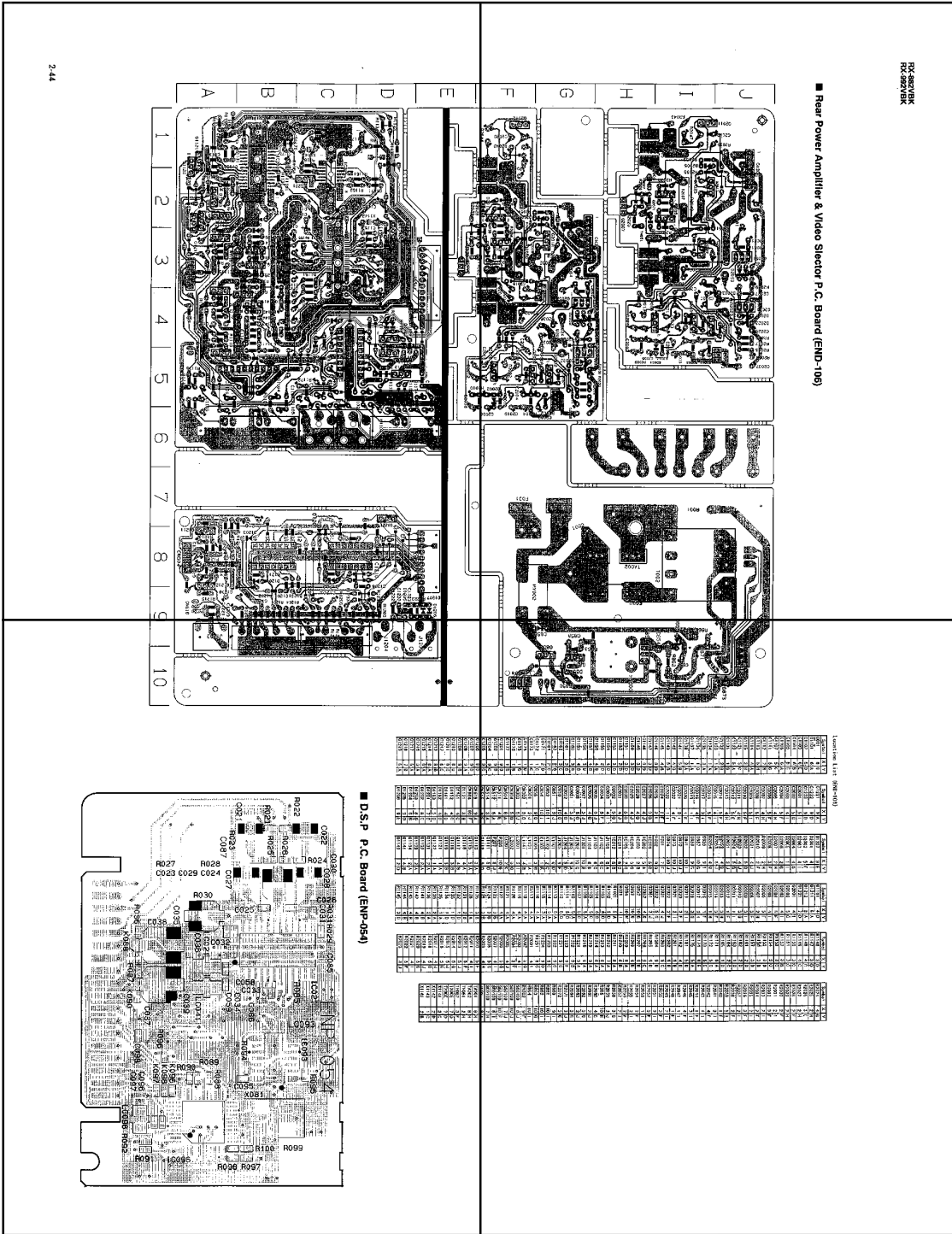

■ Rear Power Amplifier & Video Selector P.C. Board (END-106)

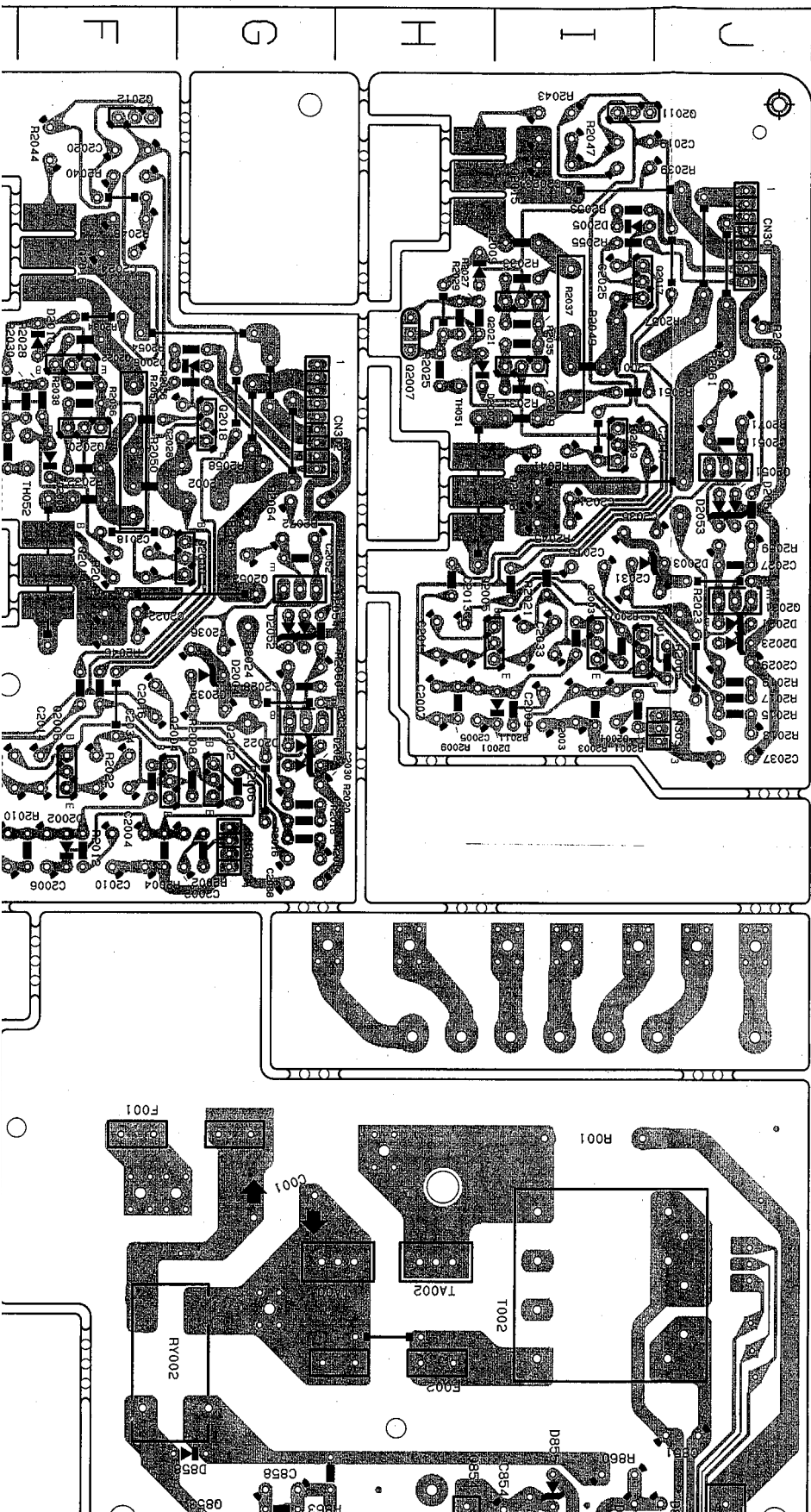

Location List (END-106)

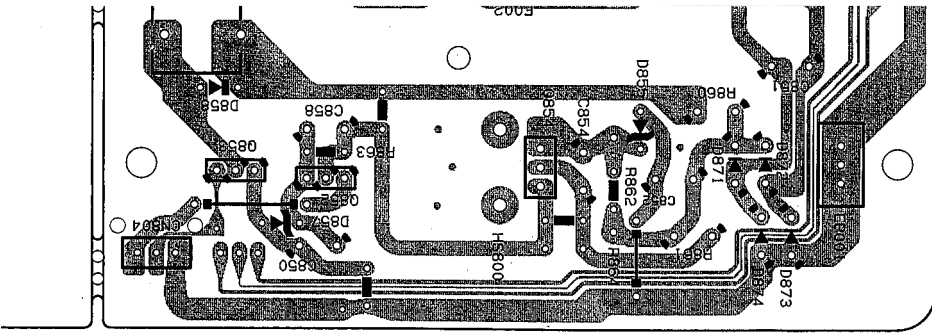

Symbol	X	Y	Symbol	X	Y	Symbol	X	Y	Symbol	X	Y	Symbol	X	Y	Symbol	X	Y
R001	8	G	G1221	9	A	D1207	9	E	R1181	4	D	R1146	3	D	R2024	4	G
G1101	6	A	G1222	9	D	D2001	4	I	Q1211	8	A	R1147	3	D	R2025	2	H
G1102	5	D	G1223	9	D	D2002	5	F	Q1221	7	D	R1148	4	C	R2026	3	E
G1103	6	E	G2001	5	I	D2003	4	I	Q1221	7	D	R1149	4	C	R2027	2	H
G1104	6	B	G2002	5	G	D2004	4	G	Q2001	4	I	R1150	3	C	R2028	2	F
G1105	5	C	G2003	4	I	D2005	1	I	Q2002	5	G	R1151	3	C	R2029	2	H
G1106	6	A	G2004	5	F	D2006	2	G	Q2003	4	I	R1152	3	B	R2030	2	F
G1107	5	C	G2005	4	H	D2007	2	H	Q2004	5	F	R1153	3	C	R2031	2	F
G1111	5	C	G2006	5	F	D2008	3	F	Q2005	4	I	R1154	3	C	R2032	3	F
G1112	2	B	G2007	4	H	D2009	2	H	Q2006	5	F	R1155	3	B	R2033	2	I
G1113	5	B	G2008	5	E	D2010	2	F	Q2007	2	H	R1156	3	B	R2034	2	F
G1114	4	A	G2009	5	I	D2011	4	J	Q2008	3	E	R1157	3	D	R2035	2	I
G1115	3	B	G2010	5	F	D2012	5	G	Q2009	3	I	R1161	2	D	R2036	3	F
G1121	5	C	G2011	4	H	D2022	4	J	Q2010	3	G	R1162	2	D	R2037	2	F
G1122	5	C	G2012	4	H	D2023	4	J	Q2011	3	G	R1163	1	C	R2038	2	F
G1122	5	A	G2012	5	E	D2024	5	G	Q2011	1	I	R1164	2	C	R2039	1	I
G1131	1	B	G2012	4	H	D2051	3	J	Q2012	1	F	R1165	1	D	R2040	1	F
G1132	2	B	G2014	5	F	D2052	4	G	Q2013	3	H	R1171	6	A	R2041	3	I
G1133	1	A	G2014	4	I	D2053	3	J	Q2014	3	F	R1172	5	C	R2042	4	F
G1134	1	A	G2016	5	F	D2054	4	G	Q2015	1	H	R1173	5	C	R2043	1	F
G1135	2	A	G2016	5	F	D2055	9	I	Q2016	1	F	R1174	6	E	R2044	1	F
G1136	1	B	G2017	3	I	D2057	9	I	Q2017	2	I	R1175	5	A	R2045	1	F
G1137	1	A	G2018	4	F	D2058	10	G	Q2018	3	G	R1181	5	D	R2046	4	F
G1138	2	A	G2019	1	I	D2059	10	J	Q2019	2	I	R1182	4	D	R2047	1	I
G1141	5	B	G2020	1	F	D2061	10	J	Q2020	3	F	R1201	9	B	R2048	1	F
G1142	4	B	G2021	3	I	D2062	10	J	Q2021	2	I	R1202	9	B	R2049	2	F
G1143	5	B	G2022	4	F	D2063	10	J	Q2022	2	F	R1203	9	C	R2050	3	F
G1145	4	B	G2023	1	I	D2064	7	F	Q2023	4	J	R1204	9	B	R2051	3	F
G1146	3	D	G2024	2	F	D2065	9	G	Q2024	5	G	R1205	9	D	R2052	3	F
G1147	3	D	G2025	2	F	D2066	9	G	Q2025	3	J	R1206	9	C	R2053	1	F
G1148	3	D	G2026	3	G	D2067	9	G	Q2026	4	G	R1207	9	B	R2054	2	F
G1149	3	D	G2027	4	J	D2068	9	G	Q2027	5	A	R1208	9	B	R2055	2	F
G1150	3	D	G2028	4	G	D2069	10	J	Q2028	10	G	R1209	8	A	R2056	2	F
G1151	2	D	G2029	5	G	D2070	10	J	Q2029	10	H	R1210	8	B	R2057	2	F
G1152	2	D	G2030	5	G	D2071	7	F	Q2030	10	H	R1211	9	A	R2058	2	F
G1153	3	D	G2031	4	J	D2072	7	F	Q2031	7	I	R1212	7	A	R2059	3	G
G1154	4	D	G2032	4	J	D2073	7	F	Q2032	5	G	R1213	8	A	R2060	4	G
G1155	2	D	G2033	4	I	D2074	7	F	Q2033	4	G	R1214	8	A	R2061	2	J
G1156	4	B	G2034	5	F	D2075	6	C	Q2034	6	B	R1215	9	A	R2062	3	G
G1157	4	B	G2035	5	F	D2076	6	C	Q2035	10	H	R1216	8	A	R2063	2	J
G1158	3	B	G2036	4	G	D2077	6	C	Q2036	10	G	R1217	8	A	R2064	3	G
G1159	3	B	G2037	5	J	D2078	6	C	Q2037	5	A	R1218	8	A	R2065	3	G
G1160	4	B	G2038	6	G	D2079	6	C	Q2038	5	A	R1219	8	A	R2066	4	G
G1161	2	D	G2039	4	I	D2080	6	C	Q2039	6	B	R1220	8	A	R2067	4	G
G1162	3	C	G2040	5	F	D2081	6	C	Q2040	6	B	R1221	9	A	R2068	2	J
G1163	3	C	G2041	4	I	D2082	6	C	Q2041	6	B	R1222	9	D	R2069	3	G
G1164	2	C	G2042	4	G	D2083	6	C	Q2042	6	B	R1223	9	E	R2070	3	J
G1165	3	C	G2043	4	G	D2084	6	C	Q2043	6	B	R1224	9	E	R2071	3	J
G1166	3	C	G2044	4	G	D2085	6	C	Q2044	6	B	R1225	9	E	R2072	3	J
G1167	3	C	G2045	4	G	D2086	6	C	Q2045	6	B	R1226	9	E	R2073	3	J
G1168	3	C	G2046	4	G	D2087	6	C	Q2046	6	B	R1227	9	E	R2074	3	J
G1169	3	C	G2047	4	G	D2088	6	C	Q2047	6	B	R1228	9	E	R2075	3	J
G1170	3	C	G2048	4	G	D2089	6	C	Q2048	6	B	R1229	9	E	R2076	3	J
G1171	2	D	G2049	4	G	D2090	6	C	Q2049	6	B	R1230	9	E	R2077	3	J
G1172	1	C	G2050	4	G	D2091	6	C	Q2050	6	B	R1231	9	E	R2078	3	J
G1173	1	C	G2051	4	G	D2092	6	C	Q2051	6	B	R1232	9	E	R2079	3	J
G1174	1	D	G2052	4	G	D2093	6	C	Q2052	6	B	R1233	9	E	R2080	4	G
G1175	1	D	G2053	4	G	D2094	6	C	Q2053	6	B	R1234	9	E	R2081	4	G
G1176	1	B	G2054	4	G	D2095	6	C	Q2054	6	B	R1235	9	E	R2082	4	G
G1177	1	B	G2055	4	G	D2096	6	C	Q2055	6	B	R1236	9	E	R2083	4	G
G1178	1	D	G2056	4	G	D2097	6	C	Q2056	6	B	R1237	9	E	R2084	4	G
G1179	1	D	G2057	4	G	D2098	6	C	Q2057	6	B	R1238	9	E	R2085	4	G
G1180	1	D	G2058														

■ Tuner P.C. Board (ENA-172)

■ Tuner P.C. Board (ENA-172)

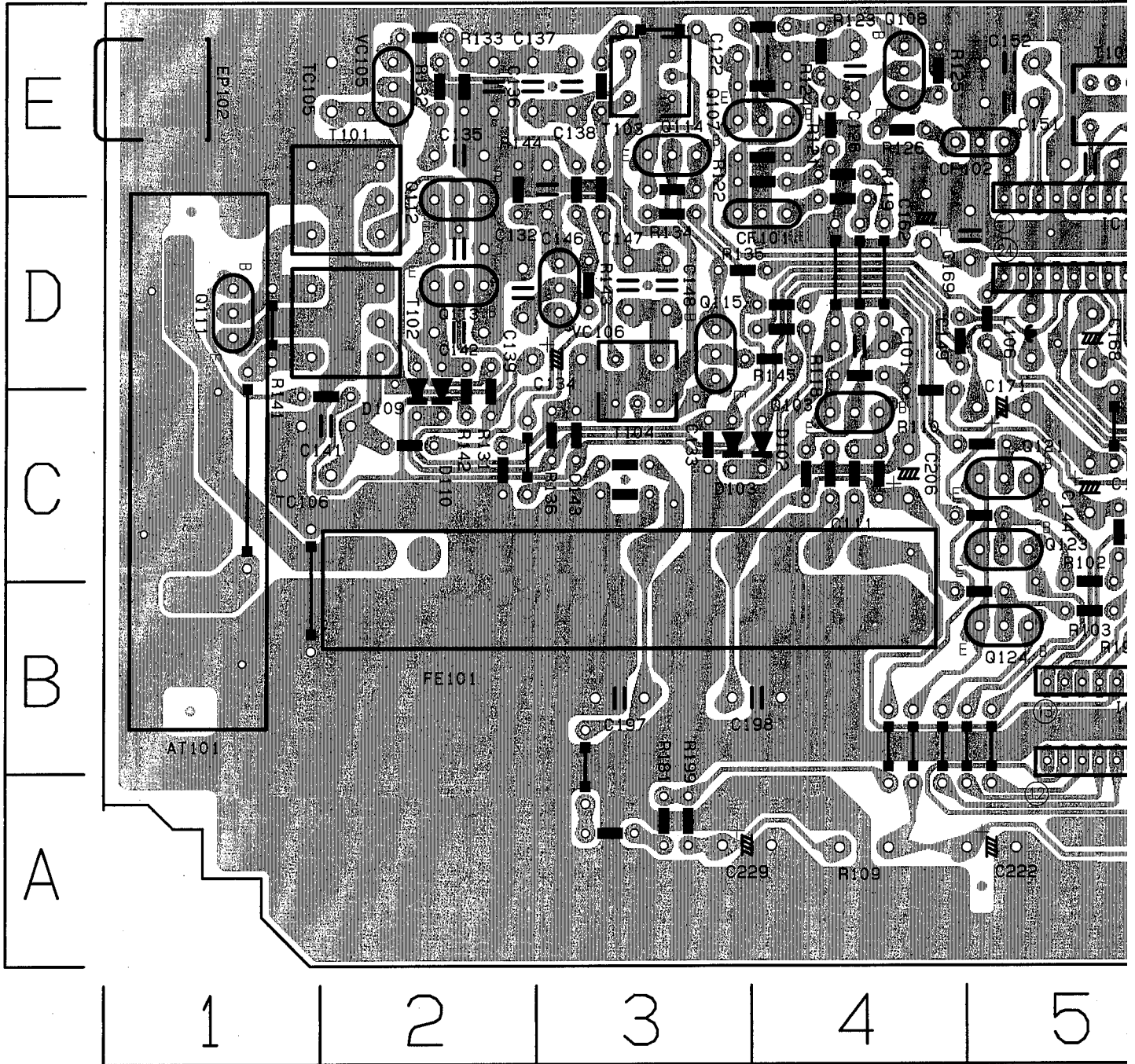

Location List
(ENA-172)

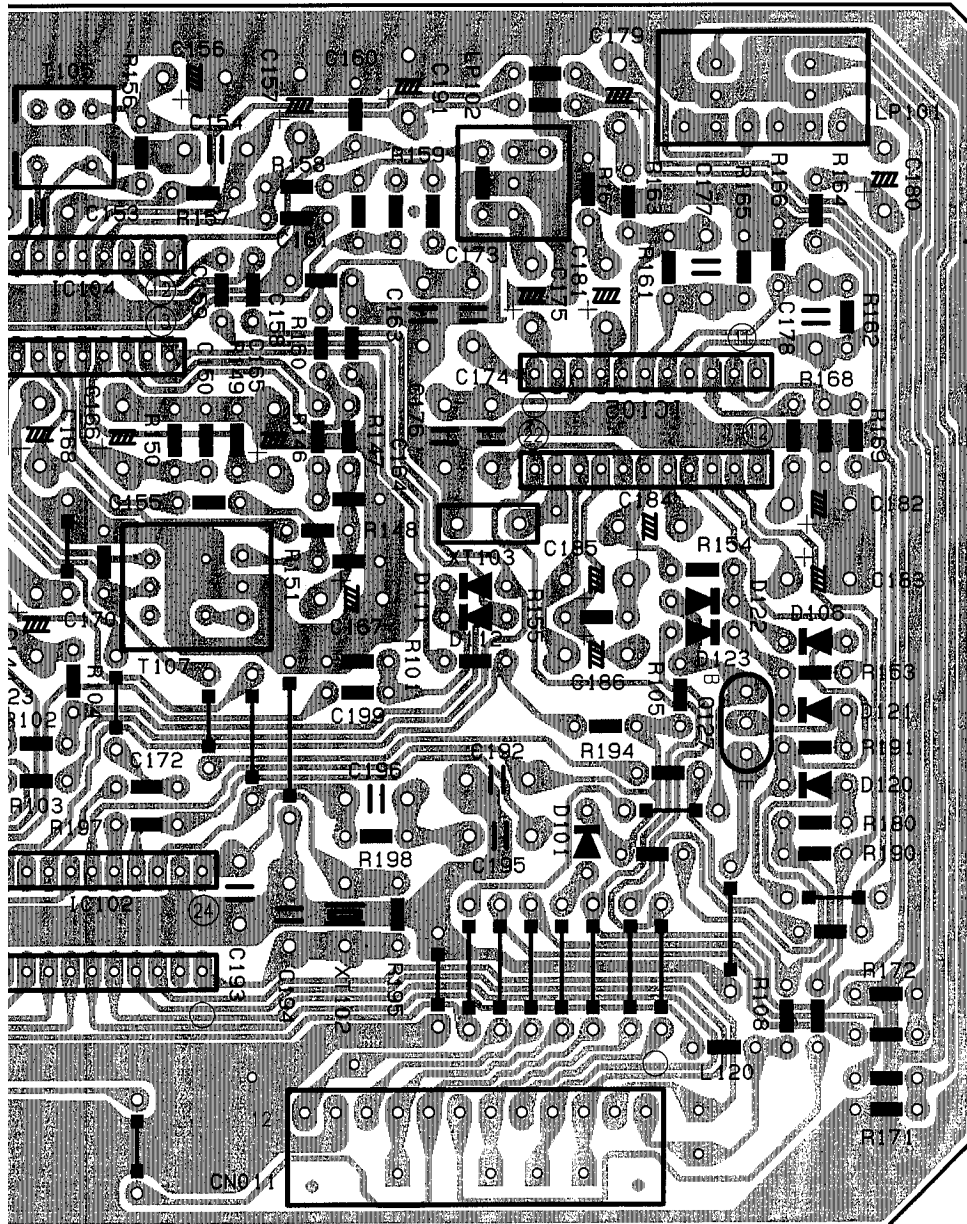

Symbol	X	Y	Symbol	X	Y	Symbol	X	Y
C101	4	D	C183	8	H	R103	5	B
C111	4	C	C184	7	H	R104	5	H
C122	3	E	C185	7	H	R105	7	C
C126	4	E	C186	7	H	R108	8	A
C132	2	D	C191	6	E	R109	4	F
C133	3	C	C192	7	B	R110	4	C
C134	2	D	C193	6	G	R118	4	D
C135	2	E	C194	6	G	R119	4	D
C136	2	E	C195	7	B	R121	3	E
C137	2	E	C196	6	G	R122	4	E
C138	3	E	C197	3	G	R123	4	E
C139	2	D	C198	3	B	R124	3	E
C141	2	C	C199	6	C	R125	4	E
C142	2	D	C206	4	H	R126	4	E
C143	3	C	C222	4	F	R131	2	D
C144	5	C	C229	3	A	R132	2	E
C146	3	D	CF101	4	D	R133	2	E
C147	3	D	CF102	5	J	R134	3	D
C148	3	D	CN011	6	F	R135	4	D
C149	4	D	D101	7	B	R136	3	C
C150	6	D	D102	4	H	R141	2	C
C151	5	E	D103	3	C	R142	2	D
C152	5	E	D106	8	C	R143	3	D
C153	5	E	D109	2	D	R144	2	E
C154	6	E	D110	2	D	R145	3	D
C155	6	E	D111	7	H	R146	6	D
C156	6	E	D112	7	C	R147	6	D
C157	6	E	D120	8	G	R148	6	C
C158	6	I	D121	8	C	R149	6	D
C159	6	D	D122	7	H	R150	6	D
C160	6	J	D123	7	C	R151	6	C
C161	6	J	FE101	2	C	R153	8	C
C162	4	D	IC102	6	B	R154	8	C
C163	6	I	IC104	5	D	R155	7	C
C164	6	H	IC105	7	D	R156	5	E
C165	6	D	L106	5	D	R157	6	E
C166	5	D	L120	8	A	R158	6	E
C167	6	H	LP101	8	E	R159	6	E
C168	5	I	LP102	7	E	R160	6	I
C169	5	I	Q103	4	C	R161	7	E
C170	5	H	Q107	4	E	R162	8	D
C171	5	C	Q108	4	J	R163	7	E
C172	6	G	Q111	1	D	R164	8	E
C173	7	I	Q112	2	I	R165	8	E
C174	7	I	Q113	2	D	R166	8	E
C175	7	I	Q114	3	E	R167	7	E
C176	7	D	Q115	3	D	R168	8	D
C177	8	J	Q121	5	C	R169	8	D
C178	8	D	Q123	5	C	R171	8	A
C179	7	J	Q124	5	B	R172	8	A
C180	8	J	Q127	8	C	R180	8	B
C181	7	I	R101	6	H	R181	3	A
C182	8	C	R102	5	G	R190	8	B

Symbol	X	Y
R191	8	B
R194	7	C
R195	6	B
R197	6	B
R198	6	B
R199	3	A
T101	1	D
T102	1	D
T103	3	E
T104	3	D
T105	5	E
T107	5	C
TC105	2	E
TC106	1	C
XT102	6	B
XT103	7	C

