

RX-884PBK
RX-884PGD
RX-884VBK

JVC

SERVICE MANUAL

AUDIO/VIDEO CONTROL RECEIVER

RX-884PBK RX-884PGD RX-884VBK

Area Suffix

UF(PBK/PGD) China
UT(PBK/VBK) Taiwan
US(PBK) Singapore
U (PBK/VBK) Universal

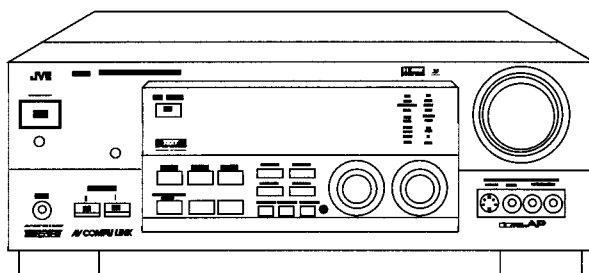
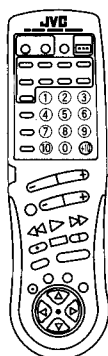

TEXT
COMPU LINK

COMPU LINK
/// Remote ///

3D
3D-PHONIC

DIGITAL AP

DOLBY SURROUND
PRO · LOGIC

Contents

Safety Precautions	1-2	Adjustment Procedures	2-25
Instruction Book	1-3~38	Block Diagrams	3-1
Description of Major ICs	2-1	Schematic Diagrams	3-4
Internal Connection of Display	2-20	Printed Circuit Boards	3-13~18
Disassembly Procedures	2-22	Parts List	4-1~19



RX-884PBK/RX-884PGD/RX-884VBK

Safety Precautions

1. This design of this product contains special hardware and many circuits and components specially for safety purposes. For continued protection, no changes should be made to the original design unless authorized in writing by the manufacturer. Replacement parts must be identical to those used in the original circuits. Services should be performed by qualified personnel only.
2. Alterations of the design or circuitry of the product should not be made. Any design alterations of the product should not be made. Any design alterations or additions will void the manufacturer's warranty and will further relieve the manufacture of responsibility for personal injury or property damage resulting therefrom.
3. Many electrical and mechanical parts in the products have special safety-related characteristics. These characteristics are often not evident from visual inspection nor can the protection afforded by them necessarily be obtained by using replacement components rated for higher voltage, wattage, etc. Replacement parts which have these special safety characteristics are identified in the Parts List of Service Manual. Electrical components having such features are identified by shading on the schematics and by (Δ) on the Parts List in the Service Manual. The use of a substitute replacement which does not have the same safety characteristics as the recommended replacement parts shown in the Parts List of Service Manual may create shock, fire, or other hazards.
4. The leads in the products are routed and dressed with ties, clamps, tubings, barriers and the like to be separated from live parts, high temperature parts, moving parts and/or sharp edges for the prevention of electric shock and fire hazard. When service is required, the original lead routing and dress should be observed, and it should be confirmed that they have been returned to normal, after re-assembling.
5. Leakage current check (Electrical shock hazard testing)
After re-assembling the product, always perform an isolation check on the exposed metal parts of the product (antenna terminals, knobs, metal cabinet, screw heads, headphone jack, control shafts, etc.) to be sure the product is safe to operate without danger of electrical shock. Do not use a line isolation transformer during this check.

- Plug the AC line cord directly into the AC outlet. Using a "Leakage Current Tester", measure the leakage current from each exposed metal parts of the cabinet, particularly any exposed metal part having a return path to the chassis, to a known good earth ground. Any leakage current must not exceed 0.5mA AC (r.m.s.)

- Alternate check method
Plug the AC line cord directly into the AC outlet. Use an AC voltmeter having, 1,000 ohms per volt or more sensitivity in the following manner. Connect a 1,500 10W resistor paralleled by a 0.15 F AC-type capacitor between an exposed metal part and a known good earth ground. Measure the AC voltage across the resistor with the AC voltmeter. Move the resistor connection to each exposed metal part, particularly any exposed metal part having a return path to the chassis, and measure the AC voltage across the resistor. Now, reverse the plug in the AC outlet and repeat each measurement. voltage measured Any must not exceed 0.75 V AC (r.m.s.).

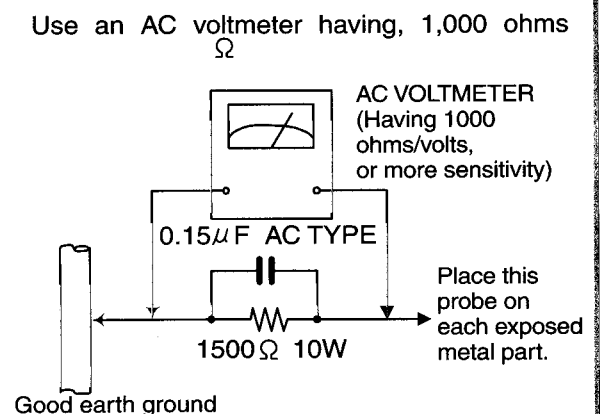

Warning

1. This equipment has been designed and manufactured to meet international safety standards.
2. It is the legal responsibility of the repairer to ensure that these safety standards are maintained.
3. Repairs must be made in accordance with the relevant safety standards.
4. It is essential that safety critical components are replaced by approved parts.
5. If mains voltage selector is provided, check setting for local voltage.

⚠ CAUTION Burrs formed during molding may be left over on some parts of the chassis. Therefore, pay attention to such burrs in the case of preforming repair of this system.

2. Instructions

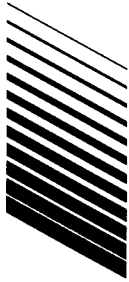

JVC

Mains (AC) Line Instruction (not applicable for Europe, U.S.A., Canada, Australia and U.K.)

Instrucción sobre la línea de la red (CA) (no aplicable para Europa, EE.UU., Canadá, Australia, ni el Reino Unido)

Instrução sobre a tensão da rede eléctrica (CA) (não aplicável para a Europa, os E.U.A., o Canadá, a Austrália e o Reino Unido)

主 (AC) 電源線路說明 (不適用於歐洲、美國、加拿大、澳洲及英國型號)

تعليمات التيار الرئيسي (المتردد) (لا ينطبق لاوربا وكندا واستراليا والمملكة المتحدة)

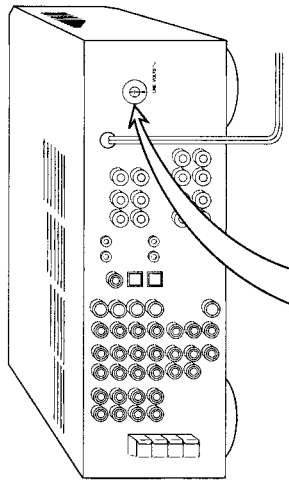

IMPORTANT for mains (AC) line
BEFORE PLUGGING IN, do check that your mains (AC) line voltage corresponds with the position of the voltage selector switch provided on the outside of this equipment and, if different, reset the voltage selector switch, to prevent from a damage or risk of fire/electric shock.

IMPORTANT para a linha de la red (CA)
ANTES DE ENCHUFAR EL EQUIPO, compruebe si la tensión de la línea de la red (CA) corresponde con la posición del selector de tensión situado en la parte exterior del equipo, y si es diferente, reajuste el selector de tensión para evitar el riesgo de incendios/descargas eléctricas.

IMPORTANT para a ligação à tensão da rede (CA)
ANTES DE LIGAR O APARELHO A UMA TOMADA DA REDE, verifique se a tensão da rede CA corresponde à posição do selector de voltagem localizado na parte externa deste equipamento. Caso não corresponda, reajuste o selector de voltagem a fim de evitar avarias ou riscos de incêndio e choque eléctrico.

有關主 (AC) 電源線路的重要事項
 接插電源以前，務請檢查當地的主 (AC) 電源線路電壓是否和位於本機外面的電壓選擇開關設定的位置一致。如果不一致，即重新設定電壓選擇開關，以免損害機件或引起火災/觸電的危險。

هام من أجل خط التيار المتردد (AC) الرئيسي
 قبل اكمال التثبيت، تأكد من ان نطاق خط التيار المتردد (AC) الرئيسي يتطابق مع موضع مفتاح اختيار التوتيق الخارج هذه المعدات وانما اختلفت، فقم بإعادة ضبط مفتاح اختيار التوتيق. لتجنب اخطار الصدمة الكهربائية واحتمار الحريق.

有關主 (AC) 電源線路的重要事項
 接插電源以前，務請檢查當地的主 (AC) 電源線路電壓是否和位於本機外面的電壓選擇開關設定的位置一致。如果不一致，即重新設定電壓選擇開關，以免損害機件或引起火災/觸電的危險。

AUDIO/VIDEO CONTROL RECEIVER

RECEPTOR DE CONTROL DE AUDIO/VIDEO
 RECEPTOR DE COMANDO AUDIO/VIDEO
 聲/視頻控制接收機

RX-884PBK

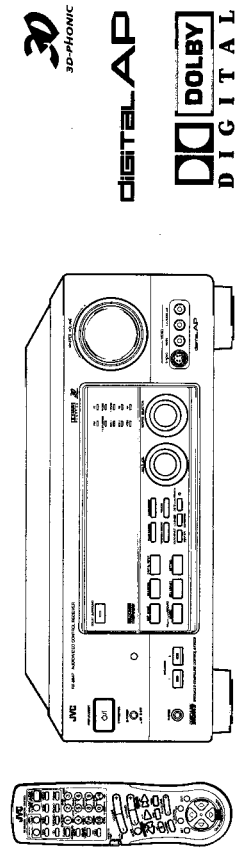

- TEXT COMPU LINK
- COMPU LINK Remote III
- 3D-Phonic
- DIGITAL AP
- DOLBY DIGITAL

INSTRUCTIONS
 MANUAL DE INSTRUCCIONES
 INSTRUÇÕES
 使用說明書

For Customer Use:
 Enter below the Model No. and Serial No. which are located either on the rear, bottom or side of the cabinet. Retain this information for future reference.

Model No. _____
 Serial No. _____

LVT0017-001A (U. US)

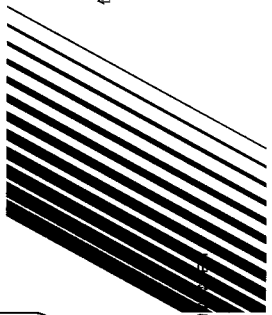

03980FM

JVC

VICTOR COMPANY OF JAPAN, LIMITED

EN, SP, PR, CH

English

Espanol

Portugues

中文

注意：正確的通風方法

為了防止觸電、火災以及避免損壞，

按如下要求放置機器：

- 前面： 側面： 上面： 背面： 底座： 不要放置障礙物，水平放置。
- 側面： 傾面的 10cm 之內不要放置障礙物。
- 上面： 傾面的 10cm 之內不要放置障礙物。
- 背面： 背面的 15cm 之內不要放置障礙物。
- 底座： 不要放置障礙物，水平放置。

此外，如圖所示，儘可能保持最佳的空氣循環。

Caution: Proper Ventilation

To avoid risk of electric shock and fire and to protect from damage.

Locate the apparatus as follows:

- Front: No obstructions in 10 cm from the sides.
- Sides: No obstructions in 10 cm from the top.
- Top: No obstructions in 15 cm from the back.
- Back: No obstructions, place on the level surface.

In addition, maintain the best possible air circulation as illustrated.

Precaución: Ventilación Adecuada

Para evitar el riesgo de choque eléctrico e incendio y para proteger el

aparato contra daños.

Ubique el aparato de la siguiente manera:

- Fronte: Espacio abierto sin obstrucciones
- Lados: 10 cm sin obstrucciones a los lados
- Parte superior: 10 cm sin obstrucciones en la parte superior
- Parte trasera: 15 cm sin obstrucciones en la parte trasera
- Fondo: Sin obstrucciones, coloque sobre una superficie nivelada

Además, mantenga la mejor circulación de aire posible como se ilustra.

Precaução: ventilação apropriada

Para prevenir o risco de choque elétrico ou incêndio e para proteger o

aparelho contra danos.

Localize-o da seguinte maneira:

- Fronte: Espaço aberto, sem obstruções
- Lados: Espaço de 10 cm sem obstruções nos lados
- Topo: Espaço de 10 cm sem obstruções acima
- Trás: Espaço de 15 cm sem obstruções atrás
- Parte inferior: Sem obstruções. Coloque o aparelho em superfície nivelada.

Mantenha, além disso, a maior circulação de ar possível, como indica a ilustração.

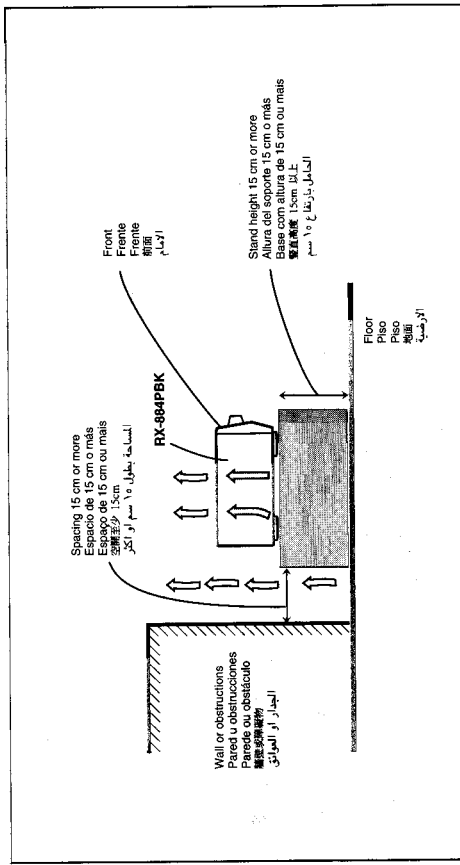

Warnings, Cautions and Others / Avisos, precauciones y otras notas / Advertências, precauções e outras notas / 警告，注意及其他須知事項

تحذيرات، تنبيهات وأشياء أخرى

CAUTION

- To reduce the risk of electrical shocks, fire, etc.:
- 1. Do not remove screws, covers or cabinet.
- 2. Do not expose this appliance to rain or moisture.

PRECAUCIÓN

- Para reducir riesgos de choques eléctricos, incendio, etc.:
- 1. No extraiga los tornillos, los cubiertas ni la caja.
- 2. No exponga este aparato a la lluvia o a la humedad.

ATENÇÃO

- Para reduzir riscos de choques elétricos, incêndio, etc.:
- 1. Não retire parafusos nem desmonte as tampas ou o gabinete.
- 2. Não exponha este aparelho à chuva nem à umidade.

Caution — Ⓞ Power switch and STANDBY/ON button!

- 1. When doing initial setting, complete all the connections required, connect the mains plug into the wall outlet, and set the Ⓞ POWER switch to ON. After these, it will be available to operate STANDBY/ON button and so on.
- 2. When not in use, set the Ⓞ POWER switch to OFF.
- 3. Disconnect the mains plug to shut the power off completely. The Ⓞ POWER switch and STANDBY/ON button in any position do not disconnect the mains line.
- 4. The power can be remote controlled.

Precaución — Interruptor Ⓞ POWER y botón STANDBY/ON

- Este unidad dispone de un interruptor Ⓞ POWER que sirve para reducir al mínimo el consumo de alimentación para proporcionar mayor seguridad operacional. Por lo tanto,
- 1. Al ejecutar el ajuste inicial, después de completar todas las conexiones requeridas, conectar el cable de alimentación a una toma de pared, y activar el interruptor Ⓞ POWER. Entonces, será posible ejecutar operaciones tales como la conmutación del estado de alimentación.
- 2. Desactivar el interruptor Ⓞ POWER al dejar la unidad fuera de uso.
- 3. Desconectar el cable de alimentación para desactivar la alimentación totalmente. Cualquier que sea la posición de ajustes del interruptor Ⓞ POWER y el botón STANDBY/ON, la alimentación no es cortada completamente.
- 4. La alimentación puede ser controlada remotamente.

Precaução — Interruptor POWER e botão STANDBY/ON

- Este aparelho dispõe de um interruptor Ⓞ POWER que possibilita reduzir ao mínimo o seu consumo de energia por medida de segurança. Assim,
- 1. Nos ajustes iniciais, efetue todas as conexões necessárias, ligue o plugue de alimentação à tomada e coloque o interruptor Ⓞ POWER em ON. Feito isso, será possível operar o botão STANDBY/ON e as diversas funções.
- 2. Quando não utilizar o aparelho, coloque o interruptor Ⓞ POWER em OFF.
- 3. Remova o plugue de alimentação da tomada para desligar o aparelho completamente. O interruptor Ⓞ POWER e o botão STANDBY/ON, em qualquer de suas posições, não desligam a alimentação do aparelho.
- 4. É possível controlar remotamente a função do interruptor POWER.

注意 — Ⓞ POWER 開關及 STANDBY/ON 按鈕！

- 本機備有 Ⓞ POWER 開關，能減少電能消耗，使用安全。因此
- 1. 在開始設定時，確保完成所有必要的接線，主電源插頭將移至電源插座，並且把 Ⓞ POWER 開關置為 ON（開啟）之後，它便可操作 STANDBY/ON 功能等。
- 2. 不用本機時，把 Ⓞ POWER 開關置為 OFF（關閉）。
- 3. 若要完全切斷電源，必須把主電源插頭拔起。Ⓞ POWER 開關和 STANDBY/ON 開關的任何位置皆不能切斷主電源。
- 4. 遙控器可用來開關電源。

تحذير - مفتاح الطاقة الكهربائية POWER Ⓞ و زر الاستعداد للتشغيل/التشغيل STANDBY/ON Ⓞ /

- هذا الجهاز مزود بمفتاح الطاقة الكهربائية POWER Ⓞ ويمكن بالتحكم عن طريق استيفاء الحالة الكهربائية وأيضا من أجل سلامة الاستعمال. لذلك يرجى عمل ما يلي:
- 1. عند إجراء الضبط الأولي، اكمل كافة التوصيلات المطلوبة. اربط الحبل الطاقة الكهربائية مع فتحة بطارية الطاقة الكهربائية. ثم اضغط مفتاح الطاقة الكهربائية POWER Ⓞ على زر وضع التشغيل/التشغيل OFF.
- 2. في حالة عدم استعمال الجهاز، اضغط مفتاح الطاقة الكهربائية POWER Ⓞ على زر وضع إيقاف التشغيل/التشغيل STANDBY/ON Ⓞ و زر الاستعداد للتشغيل/التشغيل STANDBY/ON Ⓞ في أي وضع خذ الحالة الكهربائية الرئيسية من الجهاز.
- 3. يمكن التحكم عن بعد بالحالة الكهربائية.

Table of Contents

Parts Identification	3	Using the DSP Modes	30
Getting Started	4	Using the 3D-PHONIC Modes.....	31
Before Installation.....	4	Using the DAP Modes.....	34
Checking the Supplied Accessories.....	4	Using the Dolby Digital and Dolby Pro Logic Modes.....	36
Setting the Voltage Selector Switch.....	4	Using the Theater Surround Mode.....	39
Connecting the FM and AM Antennas.....	5	Using the On-Screen Menus	43
Connecting the Speakers.....	6	Selecting the Source to Play.....	43
Connecting Audio/Video Components.....	9	Selecting the Different Sources for Picture and Sound.....	43
Connecting the Power Cord.....	13	Using the DSP Modes.....	43
Putting Batteries in the Remote Control.....	13	Adjusting the Front Speaker Output Balance.....	44
Basic Operations	14	Listening at Low Volume (Loudness).....	44
Turning the Power On and Off (Standby).....	14	Attenuating the Input Signal.....	44
Selecting the Source to Play.....	14	Adjusting the Subwoofer Output Level.....	45
Adjusting the Volume.....	15	Adjusting the DSP Modes.....	45
Selecting the Front Speakers.....	16	Selecting Your Favorite SEA Mode.....	46
Muting the Sound.....	16	Creating Your Own SEA Mode.....	47
Recording a Source.....	16	Basic Settings.....	47
Attenuating the Input Signal.....	16	Operating the Tuner.....	48
Adjusting the Subwoofer Output Level.....	17	Storing the Preset Stations.....	48
Basic Settings	18	Assigning Names to the Preset Stations.....	49
Changing the Source Name.....	18	COMPU LINK Remote Control System	50
Selecting the Input Mode.....	18	TEXT COMPU LINK Remote Control System	51
Adjusting the Front Speaker Output Balance.....	19	Showing the Disc Information on the TV Screen.....	52
Setting the Subwoofer Information.....	19	Searching a Disc (Only for the CD Player).....	53
Listening at Low Volume (Loudness).....	19	Using the User File (Only for the CD Player with the User File Function).....	55
Digital Input (DIGITAL IN) Terminal Setting.....	20	Entering the Disc Information.....	56
Setting the Speakers for the DSP Modes.....	20	Operating JVC's Audio/Video Components	58
One Touch Operation	23	Operating Other Manufacturers' Components	62
About the One Touch Operation.....	23	Troubleshooting	66
Using the One Touch Operation.....	23	Specifications	67
Receiving Radio Broadcasts	24		
Setting the AM Tuner Interval Spacing.....	24		
Tuning in Stations Manually.....	24		
Using Preset Tuning.....	25		
Selecting the FM Reception Mode.....	26		
Assigning Names to Preset Stations.....	27		
Using the SEA Modes	28		
Selecting Your Favorite SEA Mode.....	28		
Creating Your Own SEA Mode.....	29		

Parts Identification

Become familiar with the buttons and controls on the receiver before use.

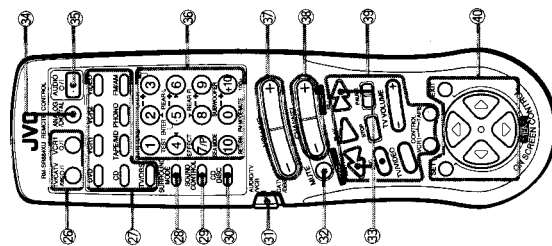
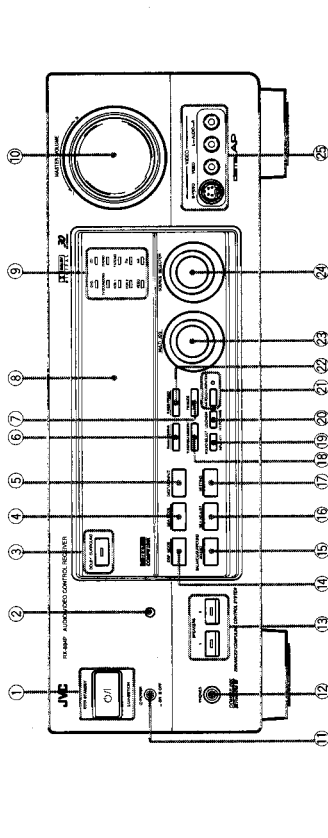

Refer to the pages in parentheses for details.

Front Panel

- ① STANDBY/ON (1) button and STANDBY lamp (14)
- ② Remote sensor (13)
- ③ DOLBY SURROUND button and lamp (38)
- ④ SEA MODE button (28) *
- ⑤ DIGITAL INPUT button (18)
- ⑥ FM/AM TUNING button (24) *
- ⑦ FM MODE button (26)
- ⑧ Display (14)
- ⑨ Source lamps (14)
- ⑩ MASTER VOLUME control (15)
- ⑪ POWER switch (13)
- ⑫ PHONES jack (16)
- ⑬ SPEAKERS 1/2 buttons and lamps (16)
- ⑭ DSP MODE button (31) *
- ⑮ BALANCE/SURROUND ADJUST button (19, 32) *
- ⑯ SEA ADJUST button (29) *
- ⑰ SETTING button (19) *
- ⑱ TUNER/SEA MEMORY button (25, 27, 29)
- ⑲ SOUND SELECT/INPUT ATT. button (15, 17)
- ⑳ LOUDNESS/SOURCE NAME button (18, 19)
- ㉑ ONE TOUCH OPERATION button and lamp (23)
- ㉒ TUNER PRESET button (25) *
- ㉓ MULTI JOG control
- What this control actually does depends on which function you are trying to adjust. Before using this control, select the function by pressing one of the buttons marked with *.
- ㉔ SOURCE SELECTOR control (14)
- ㉕ VIDEO input jacks (11)

Remote Control

- ㉖ TV/CATV/DBS (1) and VCR (1) buttons (60, 61)
- ㉗ Remote selecting buttons (15)
- ㉘ SURROUND MODE button (33)
- ㉙ SOUND CONTROL button (28, 33, 38)
- ㉚ CD DISC button (59)
- ㉛ Remote control mode selector (AUDIO/TV/VCR, CATV/DBS) (14, 58, 62)
- To operate an audio system, TV, and VCR, set this selector to "AUDIO/TV/VCR."
- To operate a CATV converter and DBS tuner, set this selector to "CATV/DBS."
- ㉜ MUTE button (16)
- ㉝ TUNING UP/TUNING DOWN buttons (24)
- Before using this control, make sure that you have pressed FM/AM button on the remote control.
- ㉞ ANALOG/DIGITAL button (18)
- ㉟ AUDIO (1) button (14)
- ㊱ 10 keys for selecting preset channel (25)
- ㊲ 10 keys for adjusting sound (28, 33)
- ㊳ 10 keys for operating audio/video components (58, 62)
- ㊴ VOLUME buttons (+/-) (15)
- ㊵ CHANNEL buttons (+/-) (60, 62)
- ㊶ Operating buttons for audio/video components (58, 62)
- ㊷ MENU operating buttons (SET, EXIT, Δ , ∇ , \leftarrow , \rightarrow) (43)

Getting Started

This section explains how to connect audio/video components and speakers to the receiver, and how to connect the power supply.

Before Installation

General

- Be sure your hands are dry.
- Turn the power off to all components.
- Read the manuals supplied with the components you are going to connect.

Locations

- Install the receiver in a location that is level and protected from moisture.
- The temperature around the receiver must be between -5° and 35° C (23° and 95° F).
- Make sure there is good ventilation around the receiver. Poor ventilation could cause overheating and damage the receiver.

Handling the receiver

- Do not insert any metal object into the receiver.
- Do not disassemble the receiver or remove screws, covers, or cabinet.
- Do not expose the receiver to rain or moisture.

Checking the Supplied Accessories

Check to be sure you have all of the following items, which are supplied with the receiver.

The number in the parentheses indicates quantity of the pieces supplied.

- Remote Control (1)
- Batteries (2)
- AM Loop Antenna (1)
- FM Antenna (1)
- Audio Signal Attenuating Cord (1)
- AC Plug Adaptor (1) (except for People's Republic of China)

If anything is missing, contact your dealer immediately.

Setting the Voltage Selector Switch

Before connections, always do the following first if necessary.

How to set the voltage selector:

Set the correct voltage for your area with the voltage selector switch on the rear panel. Use a screw driver to rotate the switch so the number the arrow is pointing at is the same as the voltage where you are plugging in the receiver.

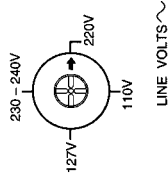

Getting Started

Connecting the FM and AM Antennas

FM Antenna Connections

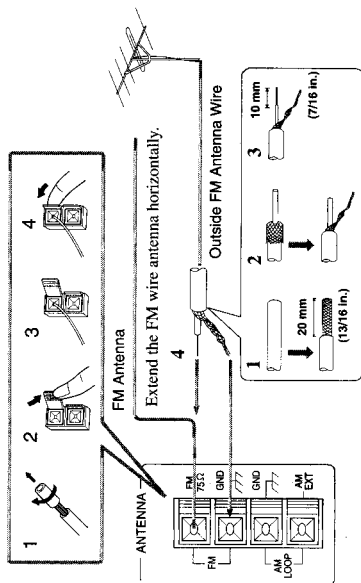

How to strip the 75Ω coaxial cable and connect it to the FM terminals

- Strip back the outside covering of the 75Ω coaxial cable to expose the braided metallic mesh about 20 mm (13/16 inches).
- Pull the mesh back and twist it into a single connector as shown in the illustration above.
- Strip the insulation about 10 mm (7/16 inches) back from the central wire.
- Insert the twisted mesh and the central wire to the FM terminals, as shown in the illustration above.

AM Antenna Connections

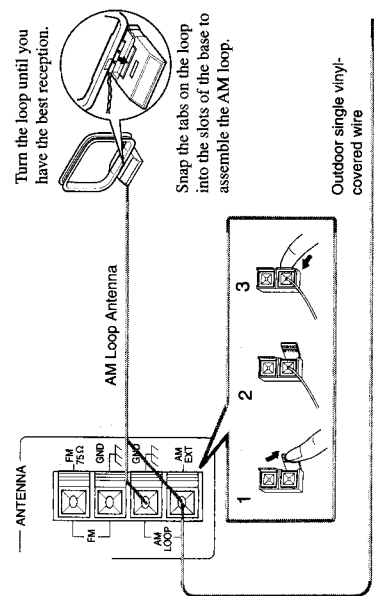

Connecting the Speakers

You can connect the following speakers:

- Two pairs of front speakers to produce normal stereo sound.
- One pair of rear speakers to enjoy the surround effect.
- One center speaker to produce more effective surround effect (to emphasize human voices).
- One subwoofer to enhance the bass.

IMPORTANT:

After connecting the speakers listed above, set the speaker setting information properly to obtain the best possible performance. For details, see pages 19 and 20.

For each speaker (except for subwoofer), connect the (-) and (+) terminals on the rear panel to the (-) and (+) terminals marked on the speakers. For connecting a subwoofer, see page 7.

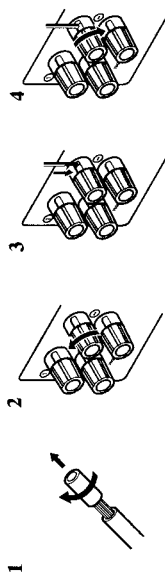

- Cut, twist and remove the insulation at the end of each speaker signal cable.
- Turn the knob counterclockwise.
- Insert the speaker signal cable.
- Turn the knob clockwise.

Connecting the front speakers

Connect the front speakers to the FRONT SPEAKERS terminals. You can connect two pairs of front speakers (one pair to the FRONT SPEAKERS ① terminals, and another pair to the FRONT SPEAKERS ② terminals).

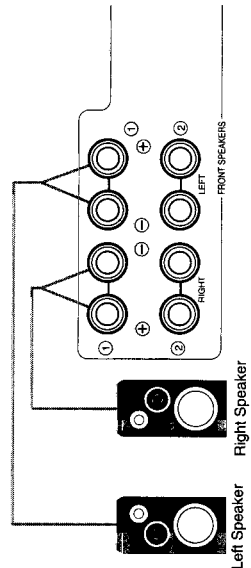

CAUTION:

Use speakers with the SPEAKER IMPEDANCE indicated by the speaker terminals.

- Notes:**
- Make sure the antenna conductors do not touch any other terminals, connecting cords and power cord. This could cause poor reception.
 - If reception is poor, connect an outdoor single vinyl-covered wire to the AM EXT terminal. (Keep the AM loop antenna connected.)

Getting Started

Connecting the rear and center speakers

Connect the rear speakers to the REAR SPEAKERS terminals and a center speaker to the CENTER SPEAKER terminals.

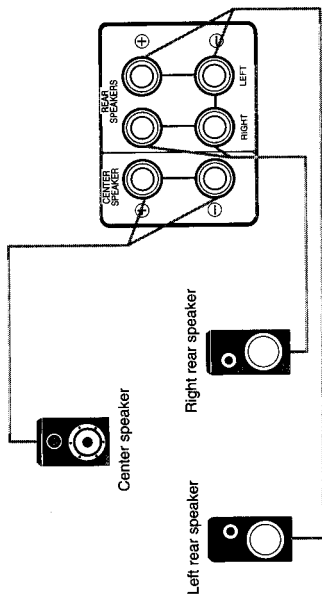

Connecting the subwoofer speaker

Connect the input jack of a powered subwoofer to the SUBWOOFER OUT jack on the rear panel, using a cable with RCA pin plugs.

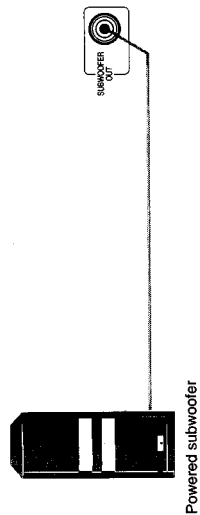

About the speaker impedance

The required speaker impedance of the front speakers does differ depending on whether both the FRONT SPEAKERS ① and FRONT SPEAKERS ② terminals are used or only one of them is used.

CASE 1 When you connect only one set of front speakers

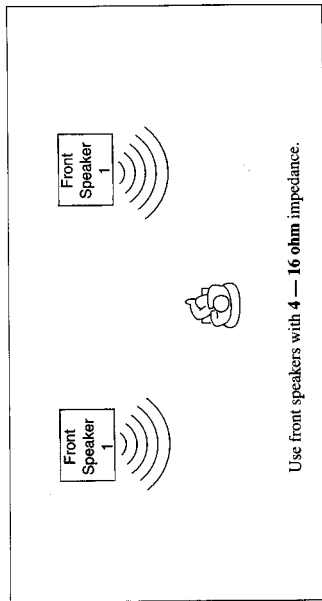

CASE 2 When you connect two sets of front speakers

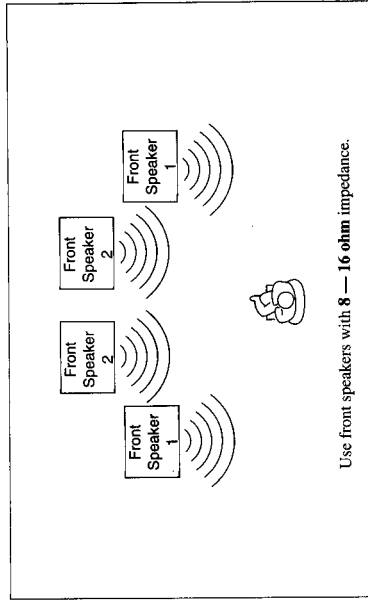

CAUTION:
When connecting speakers, use speakers with the same SPEAKER IMPEDANCE indicated by the speaker terminals.

CAUTION:
Use speakers with the SPEAKER IMPEDANCE indicated by the speaker terminals.

Connecting Audio/Video Components

You can connect the following audio/video components to this receiver. Refer also to the manuals supplied with your components. If you want to connect a component not listed in the table below, refer to the manual supplied with it.

Audio Components	Video Components
• Turntable	• DVD player*
• CD player*	• TV
• Cassette deck or MD recorder*	• DBS tuner*
	• VCRs
	• Video camera

* You can connect these components using the methods described in "Analog connections" (below) or in "Digital connections" (see page 12).

Analog connections

Audio component connections

Use the cables with RCA pin plugs (not supplied). Connect the white plug to the audio left jack, and the red plug to the audio right jack.

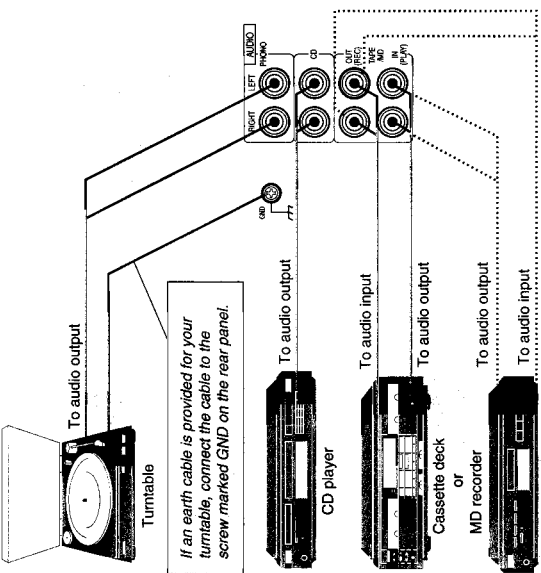

If your audio components have a COMPU LINK-3 or TEXT COMPU LINK terminal

- See also page 50 for detailed information about the connection and the COMPU LINK-3 remote control system.
- See also page 51 for detailed information about the connection and the TEXT COMPU LINK remote control system.

Video component connections

Use the cables with RCA pin plugs (not supplied). Connect the white plug to the audio left jack, the red plug to the audio right jack, and the yellow plug to the video jack. If your video components have S-video (Y/C-separation) terminals, connect them using S-video cables (not supplied). Connecting these video components through the S-video input/output terminals will give you better picture playback (or recording) quality.

IMPORTANT:

This receiver is equipped with both the composite video and S-video input/output terminals for connecting video components. You do not have to connect both the composite video and S-video terminals. However, remember that the video signals from the composite video input terminals are output only through the composite video output terminals, while the ones from the S-video input terminals are output only through the S-video output terminals. Therefore, if a recording video component and a playing video component are connected to the receiver through the different video terminals, you cannot record the picture from the playing component on the recording component. In addition, if the TV and a playing video component are connected to the receiver through the different video terminals, you cannot view the playback picture from the playing component on the TV.

To view and record the playback picture from the video component connected to the VCR 2 jacks, you must connect the TV and the recording video component through the composite video terminals.

Connecting the TV and/or DBS tuner

You can connect either the TV or DBS tuner to the TV SOUND/DBS jacks.

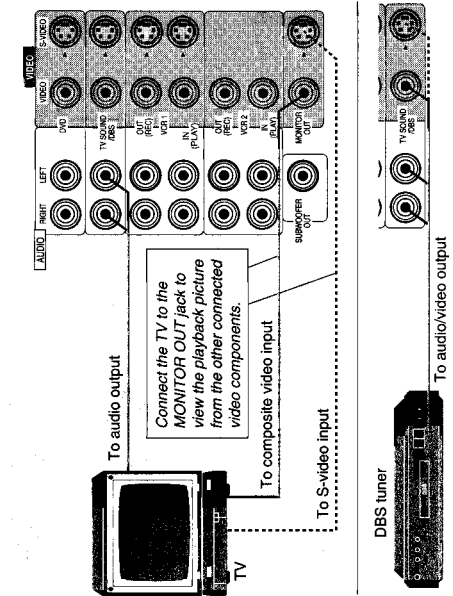

Note: When connecting an audio/video component (ex.: Video CD player) with "karaoke" — singing along — function, use the audio signal attenuating cord supplied with this receiver. If not, sound may be distorted.

- Notes:**
- Use the video components of the PAL color system.
 - When connecting the TV to the TV SOUND/DBS jacks, DO NOT connect to these video input terminals.
 - When connecting the DBS tuner to the TV SOUND/DBS jacks, change the source name, which will be shown on the display when selected as the source, to "DBS." See page 18 for details.
 - To enjoy Dolby Digital with the DBS tuner as the source, connect the DBS tuner using the method described in "Digital connections" on page 12.

Getting Started

Connecting DVD player

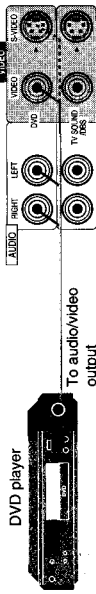

Connecting VCRs

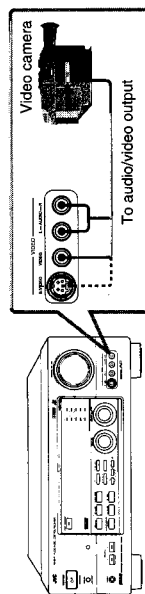
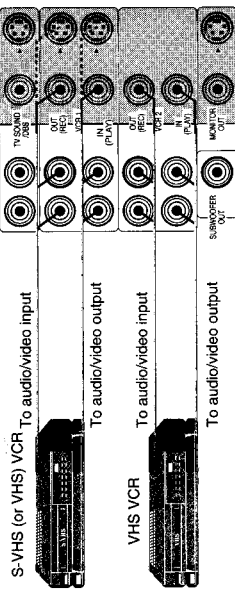

Note:

To enjoy Dolby Digital with the DVD player as the source, connect the DVD player, using the method described in "Digital connections" on page 12.

Digital connections

This receiver is equipped with three DIGITAL IN terminals — one digital coaxial terminal and two digital optical terminals. To enjoy Dolby Digital, you have to connect the source components using the DIGITAL IN terminals. You can connect any component to any one of the digital terminals using the digital coaxial cable (not supplied) or digital optical cable (not supplied).

DBS tuner



DVD player



CD player



MD recorder

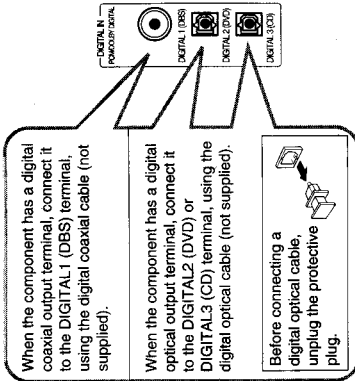

Notes:

- When shipped from the factory, the DIGITAL IN terminals has been set for use with the following components.
 - DIGITAL 1 (coaxial): For DBS tuner
 - DIGITAL 2 (optical): For DVD player
 - DIGITAL 3 (optical): For CD player
- When you want to operate the CD player or MD recorder using the COMPU LINK remote control system, connect the target component also as described in "Analog connections" (see page 9).

IMPORTANT:

- When connecting the DVD player or the DBS tuner using the digital terminal, you also need to connect it to the video jack (either composite video terminal or S-video terminal) on the rear. Without connecting it to the video jack, you can view no playback picture.
- After connecting the above components using the DIGITAL IN terminals, set the following correctly if necessary.
 - Select the digital input mode correctly. For details, see "Selecting the Input Mode" on page 18.
 - Set the digital input (DIGITAL IN) terminal setting correctly. For details, see "Digital Input (DIGITAL IN) Terminal Setting" on page 20.

Getting Started

Connecting the Power Cord

Before plugging the receiver into an AC outlet, make sure that all connections have been made.

1. Plug the power cord into an AC outlet.
2. Press **⓪ POWER** to set it in the **—ON** position. The STANDBY lamp lights up. A small amount of power is always consumed.



To shut off the power completely Press **⓪ POWER** to set it in the **⓪ OFF** position.

Keep the power cord away from the connecting cables and the antenna. The power cord may cause noise or screen interference. We recommend that you use a coaxial cable to connect the antenna, since it is well-shielded against interference.

The difference between the **⓪ POWER** switch and the STANDBY/ON **⓪/1** button

- The **⓪ POWER** switch is the mains supply switch, allowing the receiver to connect to the mains supply. To shut off the power completely, press the **⓪ POWER** switch to set it in the **⓪ OFF** position.
- The STANDBY/ON **⓪/1** button is a functional on/off (standby) switch, and does not disconnect the receiver from the mains supply. A small amount of power is consumed even in standby mode for the receiver to accept signals from the remote control.

Putting Batteries in the Remote Control

Before using the remote control, put two supplied batteries first. When using the remote control, aim the remote control directly at the remote sensor on the receiver.

1. On the back of the remote control, remove the battery cover as illustrated.
2. Insert batteries. Make sure to observe the proper polarity: (+) to (+) and (-) to (-).
3. Replace the cover.

R03 (UM-4)AAA (24F)

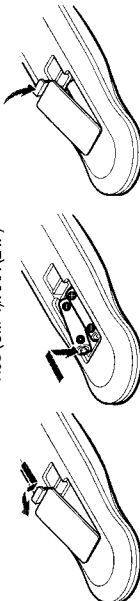

If the range or effectiveness of the remote control decreases, replace the batteries. Use two R03 (UM-4)AAA (24F) type dry-cell batteries.

Basic Operations

The following operations are commonly used when you play any sound source.

IMPORTANT:

When using the Remote Control, check to see if its remote control mode selector is set to the correct position:
To operate an audio system, TV, and VCR, set it to "AUDIO/TV/VCR."
To operate a CATV converter and DBS tuner, set it to "CATV/DBS."



Turning the Power On and Off (Standby)

On the front panel:

To turn on the power, press STANDBY/ON **⓪/1**. The STANDBY lamp goes off. The name of the current source (or station frequency) appears on the display.



Current source name appears



Current volume level is shown here

To turn off the power (into standby mode), press STANDBY/ON **⓪/1** again. The STANDBY lamp lights up.

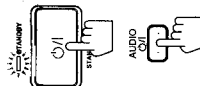

From the remote control:

To turn on the power, press AUDIO **⓪/1**. The STANDBY lamp goes off. The name of the current source (or station frequency) appears on the display.

To turn off the power (into standby mode), press AUDIO **⓪/1** again. The STANDBY lamp lights up.

Selecting the Source to Play

On the front panel:

Turn SOURCE SELECTOR until the source name you want appears on the display.

As you turn the selector, the source changes as follows:

→ CD → PHONO → TAPE/MD → FM → AM → DVD → VIDEO → VCR2 → VCR1 → TV SOUND/DBS

The selected source lamp also lights up.

Selected source name appears

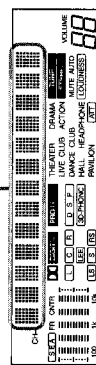

Source lamps on the front panel

Note:

Pressing the STANDBY/ON **⓪/1** button again turns off the power (into standby mode) and lights the STANDBY lamp. A small amount of power is consumed in standby mode. To turn the power off completely, press the **⓪ POWER** switch to set it in the **⓪ OFF** position on the front panel.

What are the following indicators?

When you select the source encoded with Dolby Digital and start playback, the following indicators light up on the display to show the signal being input to this receiver. (Only the indicators for the received signals light up.)

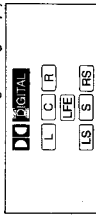

L: Left front channel
R: Right front channel
C: Center channel
LS: Left rear channel
RS: Right rear channel (monaural)
LFE: Subwoofer channel

Note:

When connecting an MD recorder (to the TAPE/MD jacks), and a DBS tuner (to the TV SOUND/DBS jacks), change the source name appears on the display. For details, see page 18.

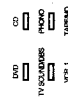

Source lamps on the front panel

Basic Operations

From the remote control:

Press one of the source selecting buttons directly.

- DVD Selects the DVD player.
- VCR1 Selects the video component connected to the VCR1 jacks.
- VCR2 Selects the video component connected to the VCR2 jacks.
- VIDEO Selects the video component connected to the VIDEO jacks.
- CD* Selects the CD player.
- TAPE/MD* Selects the cassette deck or the MD recorder.
- PHONO* Selects the turntable.
- FM/AM* Selects an FM and AM broadcast.

Each time you press the button, the band alternates between FM and AM.

- Selects TV sounds when the remote control selector is set to "AUDIO/TV/VCR."
- Selects the DBS tuner when the remote control selector is set to "CATV/DBS."

Selecting different sources for picture and sound

You can watch picture from a video component while listening to sound from another component.

1. Press SOUND SELECT briefly while viewing the picture from a video component such as the VCR or DVD player, etc.

"SOUND SELECT" appears on the display.

2. Turn SOURCE SELECTOR to select the sound (except the TV sound), while the indication of the above step is still on the display.

From the remote control:

Press one of the audio source selecting buttons (CD, TAPE/MD, PHONO, FM/AM), while viewing the picture from a video component such as the VCR or DVD player, etc.

Adjusting the Volume

On the front panel:

To increase the volume, turn MASTER VOLUME clockwise.
To decrease the volume, turn it counterclockwise.

When you turn MASTER VOLUME rapidly, the volume level also changes rapidly.
When you turn MASTER VOLUME slowly, the volume level also changes slowly.

From the remote control:

To increase the volume, press VOLUME +.
To decrease the volume, press VOLUME -.

Selecting the Front Speakers

On the front panel only:

When you have connected two pairs of the front speakers, you can select which to use.

Press SPEAKERS 1 or SPEAKERS 2 to select the speaker to use.

Each time you press the button, the lamp on the respective button turns on and off. When the lamp on either button lights up, the respective speakers are activated.

IMPORTANT:

You can activate two pairs of the front speakers at the same time only when no signals are sent to the center and rear speakers. Otherwise, activating one pair of the speakers deactivates the other.

Listening only with headphones

1. Connect a pair of headphones to the PHONES jack on the front panel.
2. Press SPEAKERS 1 and/or 2 so that no lamps on the buttons are turned on.

Muting the Sound

From the remote control only:

Press MUTE to mute the sound through all speakers and headphones connected.

"MUTE" appears on the display and the volume turns off (the volume level indicator also goes off).

To restore the sound, press MUTE again so that "OFF" appears on the display. Turning MASTER VOLUME or pressing VOLUME +/- also restores the sound at the previous volume level.

Recording a Source

You can record any source playing through the receiver to the cassette deck or the MD recorder connected to the TAPE/MD jacks and the VCRs connected to the VCR1 and VCR2 jacks at the same time.

While recording, you can listen to the selected sound source at whatever sound level you like, without affecting the sound levels of the recording.

Note:

If you use any of the DSP modes other than the 3D-PHONIC modes and "HEADPHONE" with both front speakers activated, the speakers connected to the FRONT SPEAKERS terminals are deactivated.

CAUTION:

Be sure to turn down the volume before connecting or putting on headphones, as high volume can damage both the headphones and your hearing.

Note:

You cannot shut off the sound through the subwoofer using the SPEAKERS 1 and 2 buttons.

Note:

The output volume level and SEA modes cannot affect the recording.

IMPORTANT:

When recording the digital source, turn off the DSP mode.

Basic Operations

English

Attenuating the Input Signal

When the input level of the playing source through the analog terminals is too high, the sounds will be distorted. If this happens, you need to attenuate the input signal level to prevent the sound distortion.

On the front panel only:

Press and hold **SOUND SELECT/INPUT ATT.** until "INPUT ATT ON" appears on the display. The ATT indicator also lights up on the display.

Each time you press and hold the button, the input attenuator mode turns on ("INPUT ATT ON") and off ("INPUT NORMAL"). You can set input attenuator mode separately for each source.



Adjusting the Subwoofer Output Level

You can adjust the subwoofer output level if you have selected "YES" for the "SUBWOOFER" (see page 19). Once it has been adjusted, the receiver memorizes the adjustment.

On the front panel:

1. Press **BALANCE/SURROUND ADJUST** repeatedly until "SUBWFR LEVEL" appears on the display. The display changes to show the current setting.

2. Turn **MULTI JOG** to adjust the subwoofer output level (-10 dB to +10 dB), while the indication of the previous step is still on the display.



From the remote control:

1. Press **SOUND CONTROL**. 10 keys are activated for sound adjustments.

2. Press **SUBWOOFER +/-** to adjust the subwoofer output level (-10 dB to +10 dB).



Basic Settings

Some of the following settings are required after connecting and positioning your speakers in your listening room, while others will make operations easier.

English

IMPORTANT:

When using the Remote Control, check to see if its remote control mode selector is set to the correct position: To operate this receiver, set it to "AUDIO/TV/VCR" (except when selecting the DBS tuner as the source).

Changing the Source Name

When you have connected an MD recorder to the TAPE/MD jacks or the DBS tuner to the TV SOUND/DBS jacks on the rear panel, Change the source name shown on the display when you select the MD recorder or DBS tuner as the source.

On the front panel only:

1. When changing the source name from "TAPE" to "MD":
 - Turn **SOURCE SELECTOR** until "TAPE" appears.
 - When changing the source name from "TV SOUND" to "DBS":
 - Turn **SOURCE SELECTOR** until "TV SOUND" appears.



2. Press and hold **LOUDNESS/SOURCE NAME** until "ASSGN. MD" or "ASSGN. DBS" appears on the display.

To change the source names to "TAPE" or "TV SOUND," repeat the same procedure above (in step 1, select "MD" or "DBS," then press and hold **SOURCE NAME**).

Selecting the Input Mode

When you have connected some components such as CD player, MD recorder, DVD player and the DBS tuner using digital terminals (see page 12), you need to change the input mode for these components to the digital input.

On the front panel:

1. Turn **SOURCE SELECTOR** until the source (CD, MD, DBS, or DVD) for which you want to change the input mode from analog input to digital input.
2. Press **DIGITAL INPUT** to change the input mode. Each time you press the button, the input mode alternates between the digital input and analog input.



From the remote control:

1. Press the source selecting button (CD, TAPE/MD, TV/DBS, or DVD) for which you want to change the input mode from analog input to digital input.
2. Press **ANALOG/DIGITAL** to change the input mode. Each time you press the button, the input mode alternates between the digital input and analog input.



Note:

- Without changing the source name, you can still use the connected components. However, there may be some inconvenience.
- "TAPE" or "TV SOUND" will appear on the display when you select the MD recorder or DBS tuner.
 - You cannot use the digital input (see below) for the MD recorder and the DBS tuner.
 - You cannot use the COMPU LINK remote control system (see page 50) to operate the MD recorder.

Note:

Once you have set the digital input for these components, it is always used every time you select these components as the source.

Basic Settings

Adjusting the Front Speaker Output Balance

If the sounds you hear from the front right and left speakers are unequal, you can adjust the speaker output balance.

On the front panel only:

1. Press **BALANCE/SURROUND ADJUST** repeatedly until "L/R BALANCE" appears on the display. The display changes to show the current setting.
2. Turn **MULTI JOG** to adjust the balance, while the indication of the previous step is still on the display.
 - Turning it clockwise decreases the left channel output.
 - Turning it counterclockwise decreases the right channel output.

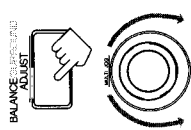

Setting the Subwoofer Information

Register whether or not you have connected a subwoofer.

On the front panel only:

1. Press **SETTING** repeatedly until "SUBWOOFER" appears on the display. The display changes to show the current setting.
2. Turn **MULTI JOG** to register whether you have connected a subwoofer or not, while the indication of the previous step is still on the display. As you turn it, the subwoofer setting alternates between "YES" and "NO."

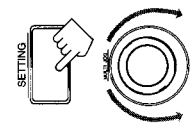

YES	Select this when you use a subwoofer.
NO	Select this when you do not use a subwoofer.

Listening at Low Volume (Loudness)

Human ears are not sensitive to bass at low volume. To compensate for this, the loudness function automatically boosts the bass level as you lower the volume.

On the front panel only:

- Press **LOUDNESS/SOURCE NAME** briefly to select the loudness function.
- Each time you press the button, the loudness function turns on ("LOUDNESS ON") and off ("LOUDNESS OFF").
- Select "LOUDNESS ON" to activate the loudness function.
- The **LOUDNESS** indicator lights up on the display.
- Select "LOUDNESS OFF" to cancel it.
- The indicator goes off.



Digital Input (DIGITAL IN) Terminal Setting

When you use the digital input terminals, you have to register what components are connected to which terminals (DIGITAL IN 1/2/3).

On the front panel only:

1. Press **SETTING** repeatedly until "DIGITAL IN" appears on the display. The display changes to show the current setting. DIGITAL 2 terminal setting

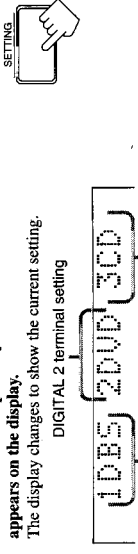

2. Turn **MULTI JOG** to select the appropriate digital terminal setting, while the indication of the previous step is still on the display.

- ≡ 1 DBS 2 DVD 3 CD ≡ DIGITAL 3 terminal setting
- ≡ 1 MD 2 DVD 3 CD ≡ 1 MD 2 DVD 3 CD
- ≡ 1 CD 2 DVD 3 MD ≡ 1 CD 2 DVD 3 MD
- ≡ 1 DVD 2 CD 3 MD ≡ 1 DVD 2 CD 3 MD
- ≡ 1 DBS 2 CD 3 MD ≡ DBS 2 DVD 3 MD
- ≡ (back to the beginning)

Setting the Speakers for the DSP Modes

To obtain the best possible surround sound of the DSP modes, you have to register the information about the speakers arrangement after all connections are completed.

Front, Center, and Rear Speaker Setting

Register the sizes of the other speakers.

On the front panel only:

1. Press **SETTING** repeatedly until "FRONT SPK" (Front Speaker), "CENTER SPK" (Center Speaker) or "REAR SPK" (Rear Speaker) appears on the display. The display changes to show the current setting.
2. Turn **MULTI JOG** to select the appropriate item about your front, center and rear speakers, while the indication of the previous step is still on the display. As you turn it, the display changes to show the following: LARGE → SMALL → NONE

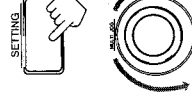

LARGE	Select this when the speaker size is relatively large.
SMALL	Select this when the speaker size is relatively small.
NONE	Select this when you have not connect a speaker. (Not selectable for the front speakers)

Note:
When shipped from the factory, the DIGITAL IN terminals can be used as the digital input for the following components.

- DIGITAL 1 (coaxial): For DBS tuner.
- DIGITAL 2 (optical): For DVD player.
- DIGITAL 3 (optical): For CD player.

Note:
When you change your speakers, you need to register the information about the speakers again.

Notes:

- If the size of the cone speaker unit built in your speaker is greater than 12 cm (4 3/4 inches), select "LARGE," and if it is smaller than 12 cm (4 3/4 inches), select "SMALL."
- If you have selected "NO" for the subwoofer setting above, you can only select "LARGE" for the front speaker setting.

Basic Settings

Center Delay Time Setting

Register the delay time of the sound from the center speaker, comparing that of the sound from the front speakers.
If the distance from your listening point to the center speaker is equal to that to the front speakers, select 0 msec. As the distance to the center speaker becomes shorter, increase the delay time.

On the front panel:

1. Press SETTING repeatedly until "CENTER DELAY" appears on the display.
The display changes to show the current setting.
2. Turn MULTI JOG to select the delay time of the center speaker output, while the indication of the previous step is still on the display.
 - Turn it clockwise to increase the delay time from 0 msec ("C. DELAY 0ms") to 5 msec ("C. DELAY 5ms").
 - Turn it counterclockwise to decrease the delay time from 5 msec ("C. DELAY 5ms") to 0 msec ("C. DELAY 0ms").

Rear Delay Time Setting

Register the delay time of the sound from the rear speakers, comparing that of the sound from the front speakers.
If the distance from your listening point to the rear speakers is equal to that to the front speakers, select 0 msec. As the distance to the rear speakers becomes shorter, increase the delay time.

On the front panel:

1. Press SETTING repeatedly until "REAR DELAY" appears on the display.
The display changes to show the current setting.
2. Turn MULTI JOG to select the delay time of the rear speaker output, while the indication of the previous step is still on the display.
 - Turn it clockwise to increase the delay time from 0 msec ("R. DELAY 0ms") to 15 msec ("R. DELAY 15ms").
 - Turn it counterclockwise to decrease the delay time from 15 msec ("R. DELAY 15ms") to 0 msec ("R. DELAY 0ms").

Crossover Frequency Setting

Small speaker cannot reproduce the bass sound very well. So, if you have used a small speaker any for the front, center, or rear channels, this receiver automatically reallocate the bass elements, originally assigned to the channel for which you have connected the small speaker, to another channel (for which you have connected the large speaker).
To use this function properly, you need to set this crossover frequency level according to the size of the small speaker connected.

On the front panel only:

1. Press SETTING repeatedly until "CROSSOVER FRQ" (Crossover Frequency) appears on the display.
The display changes to show the current setting.

Note:

- 1 msec increase (or decrease) in delay time corresponds to 30 cm (11 1/16 inches) decrease (or increase) in distance.

Notes:

- 1 msec increase (or decrease) in delay time corresponds to 30 cm (11 1/16 inches) decrease (or increase) in distance.
- It is recommended that the rear delay time for Dolby Digital be set to 5 msec.

2. Turn MULTI JOG to select the crossover frequency level according to the size of the small speaker connected, while the indication of the previous step is still on the display.
As you turn it, the display changes to show the following:
→ CROSS: 80Hz → CROSS: 100Hz → CROSS: 120Hz →

CROSS: 80Hz	Select this when the cone speaker unit built in the speaker is about 12 cm (4 7/16 inches).
CROSS: 100Hz	Select this when the cone speaker unit built in the speaker is about 10 cm (3 15/16 inches).
CROSS: 120Hz	Select this when the cone speaker unit built in the speaker is about 8 cm (3 1/16 inches).

Low Frequency Effect Attenuator Setting

If the bass sound is distorted while playing back a source using Dolby Digital, follow the procedure below.

On the front panel only:

1. Press SETTING repeatedly until "LFE ATT" (Low Frequency Effect Attenuator) appears on the display.
The display changes to show the current setting.
2. Turn MULTI JOG to select the low frequency effect attenuator level, while the indication of the previous step is still on the display.
As you turn it, the display changes to show the following:
LFE ATT: 0dB → LFE ATT: 10dB

LFE ATT: 0dB	Normally select this.
LFE ATT: 10dB	Select this when the bass sound is distorted.

Dynamic Range Compression Setting

You can compress the dynamic range (difference between maximum sound and minimum sound) of the reproduced sound. This is useful when enjoying surround sound at night.

On the front panel only:

1. Press SETTING repeatedly until "D. RANGE COMP." (Dynamic Range Compression) appears on the display.
The display changes to show the current setting.
2. Turn MULTI JOG to select the appropriate item about the compression level, while the indication of the previous step is still on the display.
As you turn it, the display changes to show the following:
→ COMP.: OFF → COMP.: MID → COMP.: MAX →

COMP.: OFF	Select this when you want to enjoy surround with its full dynamic range. (No effect applied.)
COMP.: MID	Select this when you want to reduce the dynamic range a little. (Factory setting.)
COMP.: MAX	Select this when you want to apply the compression effect fully. (Useful at night.)

Note:

This function takes effect only when playing back a source using the Dolby Digital.
However, if you have selected "LARGE" for all speakers (see page 20), this function will not take effect.

Note:
This function takes effect only when playing back a source using the Dolby Digital.

Note:
This function takes effect only when playing back a source using the Dolby Digital.

One Touch Operation

This receiver can memorize the optimum sound settings for each playing source.

About the One Touch Operation

JVC's One Touch Operation function is used to assign and store different sound settings for each different playing source. By using this function, you do not have to change the settings every time you change the source. The stored settings for the newly selected source are automatically recalled.

The following can be stored for each source:

- Volume level (see page 15)
- Input attenuator mode (see page 17)
- Subwoofer output level (see page 17)
- Input mode (see page 18)
- Balance (see page 19)
- Loudness (see page 19)
- SEA modes (see page 28)
- DSP modes
 - 3D-PHONIC mode settings (see page 31)
 - DAP mode settings (see page 34)
 - Surround mode settings (see page 36 and 39)

Using the One Touch Operation

On the front panel only:

To store the sound settings

1. Press **ONE TOUCH OPERATION**. The **ONE TOUCH OPERATION** lamp lights up, then the previously memorized settings are recalled.
2. Adjust the sound using the functions listed above. The newly adjusted settings are memorized.



To recall the sound settings

With the **ONE TOUCH OPERATION** lamp lit, the settings for the currently selected source is recalled when the source is selected.

To cancel the One Touch Operation function

Press **ONE TOUCH OPERATION** so that the lamp goes off. (Even though the One Touch Operation function is canceled, the recalled sound effects remain active.)

Note:
If the source is FM or AM, you can assign a different setting for each band.

Receiving Radio Broadcasts

You can browse through all the stations or use the preset function to go immediately to a particular station.

IMPORTANT:

When using the Remote Control, check to see if its remote control mode selector is set to the correct position:
To operate this receiver, set it to "AUDIO/TV/VCR" (except when selecting the DBS tuner as the source).



Setting the AM Tuner Interval Spacing

Some countries space AM stations 9 kHz apart, and other countries use 10 kHz spacing. When shipped, the spacing is set to 9 kHz.

On the front panel only:

To select the 10 kHz interval:

Be sure the receiver is turned off, but is plugged into an AC outlet and **POWER** is pressed to set it in the **-ON** position. Hold down **TUNER PRESET** and press **STANDBY/ON**. "10K STEP" appears on the display for about three seconds. Now the 10 kHz interval is selected.

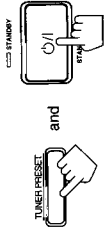

To change back to the 9 kHz interval:

Be sure the receiver is turned off, but is plugged into an AC outlet and **POWER** is pressed to set it in the **-ON** position. Hold down **FM MODE** and press **STANDBY/ON**. "9K STEP" appears on the display for about three seconds. Now the 9 kHz interval is selected.

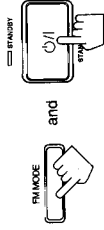

Tuning in Stations Manually

On the front panel:

1. Press **FM/AM TUNING** to select the band. Each time you press the button, the band alternates between FM and AM.
2. Turn **MULTI JOG** until you find the frequency you want.
 - Turning it clockwise increases the frequency.
 - Turning it counterclockwise decreases the frequency.

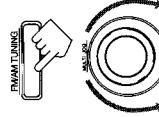

From the remote control:

1. Press **FM/AM** to select the band. Each time you press the button, the band alternates between FM and AM.
2. Press **TUNING DOWN** or **TUNING UP** repeatedly until you find the frequency you want.

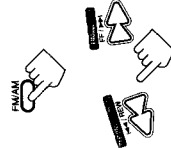

- Notes:**
- When you turn **MULTI JOG** quickly or hold the **TUNING UP** or **TUNING DOWN** in step 2, the frequency keeps changing until a station is tuned in.
 - When a station of sufficient signal strength is tuned in, the **TUNED** indicator lights up on the display.
 - When an FM stereo program is received, the **STEREO** indicator also lights up.

Using Preset Tuning

Once a station is assigned to a channel number, the station can be quickly tuned. You can preset up to 40 stations at random.

To store the preset stations

On the front panel only:

1. Tune in the station you want to preset (see page 24). If you want to store the FM reception mode for this station, select the FM reception mode you want. See page 26 for details.
2. Press **TUNER/SEA MEMORY**. "CH:" appears and the channel number position starts flashing on the display for about 5 seconds.
3. Turn **MULTI JOG** to select a channel number while the channel number position is flashing.
4. Press **TUNER/SEA MEMORY** again while the selected channel number is flashing on the display. The selected channel number stops flashing. The station is assigned to the selected channel number.
5. Repeat steps 1 to 4 until you store all the stations you want.



To erase a stored preset station

Storing a new station on a used number erases the previously stored one.

To tune in a preset station

On the front panel:

1. Press **TUNER PRESET**.
2. Turn **MULTI JOG** to select a preset channel.



From the remote control:

1. Press **FM/AM**. Each time you press the button, the band alternates between FM and AM.
2. Press **10 keys** to select a preset channel number.
 - For channel number 5, press 5.
 - For channel number 15, press +10 then 5.
 - For channel number 20, press +10 then 10.
 - For channel number 30, press +10, +10, then 10.

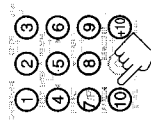

Note:

You can use the 10 keys on the remote control to select the preset number. When using the 10 keys, be sure that they are activated for tuner, not for the CD and others. (See page 58.)

Note:

When you use the 10 keys on the remote control, be sure that they are activated for tuner, not for the CD and others. (See page 58.)

Selecting the FM Reception Mode

When an FM stereo broadcast is hard to receive or noisy, set the FM reception mode to "MONO." (When shipped from the factory, this mode has been set to "AUTO.") You can change the FM reception mode while receiving an FM broadcast.

Press **FM MODE** on the front panel or **FM MODE/MUTE** on the remote control.

Each time you press the button, the FM reception mode alternates between "AUTO" and "MONO."



AUTO:	When a program is broadcasted in stereo, you will hear stereo sound; when in monaural, you will hear monaural sounds. This mode is also useful to suppress static noise between stations. The MUTE AUTO indicator lights up on the display.
MONO:	Reception will be improved although you will lose the stereo effect. In this mode, you will hear noise while tuning into the stations. The MUTE AUTO indicator goes off on the display.

Notes:

- You can store the FM reception mode for each preset station.
- When using the **FM MODE/MUTE** button, be sure that the 10 keys are activated for tuner, not for the CD and others. (See page 58.)

Receiving Radio Broadcasts

English

Assigning Names to Preset Stations

You can assign a name of up to four characters to each preset station. When a preset station is tuned in, its assigned name will appear on the display.

On the front panel only:

1. Tune in a preset station.
See page 25 for details.

2. Press **TUNER/SEA MEMORY**.
The preset channel number starts flashing for about 5 seconds.

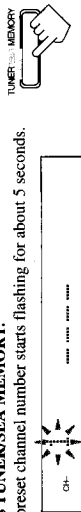

3. Press **TUNER PRESET**, while the preset channel number is flashing.
The first character position starts flashing.



4. Turn **MULTI JOG** to select the first character, while the first character position is flashing.
You can use characters listed below.



5. Press **TUNER PRESET**, while a character you want is flashing.
The next (or previous) character position starts flashing.



6. Repeat steps 4 and 5 to enter up to four characters.

7. Press **TUNER/SEA MEMORY** while the last selected character is flashing after you have assigned a name.

To erase the input characters

Insert spaces using the same procedure described above.

Available characters

The diagram shows a hand turning the 'MULTI JOG' knob. Below it, a grid of characters is shown. The first row contains letters A through N. The second row contains letters P through Z. The third row contains numbers 1 through 9. A cursor is shown pointing to the letter 'A' in the first row.

Using the SEA Modes

The SEA (Sound Effect Amplifier) modes give you control of the way your music sounds.

English

IMPORTANT:

When using the Remote Control, check to see if its remote control mode selector is set to the correct position:
To operate this receiver, set it to "AUDIO/TV/VCR" (except when selecting the DBS tuner as the source).



Selecting Your Favorite SEA Mode

On the front panel:

1. Press **SEA MODE**.
The display changes to show the current setting.
2. Turn **MULTI JOG** until the mode you want appears on the display, while the indication of the previous step is still on the display.
As you turn it, the SEA mode changes as follows:

SEA ROCK ← SEA MUSICAL → SEA MOVIE → SEA COUNTRY → SEA OFF → SEA USERMODE → SEA JAZZ

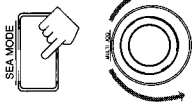

SEA ROCK:	Gives a heavy sound. Both high and low frequencies are boosted.
SEA MUSICAL:	Enhance the mid-frequency range, which the human voice is mostly made up of.
SEA MOVIE:	Adds breadth to sounds so you feel like you are in a movie theater.
SEA COUNTRY:	Enhances the high-frequency range so that instruments such as the violin and banjo are emphasized.
SEA JAZZ:	Gives a feeling of a live atmosphere. Good for acoustic music.
SEA USERMODE:	Your original SEA adjustment (see page 29).
SEA OFF:	No SEA mode is applied (see below).

To cancel the SEA mode

Turn **MULTI JOG** until "SEA OFF" appears in step 2 above. The SEA indicator goes off from the display.

From the remote control:

1. Press **SOUND CONTROL**.
10 keys are activated for sound adjustments.



2. Press **SEA MODE** repeatedly until the SEA mode you want appears on the display.
Each time you press the button, the SEA mode changes as follows:

SEA ROCK ← SEA MUSICAL → SEA MOVIE → SEA COUNTRY → SEA OFF → SEA USERMODE → SEA JAZZ



To cancel the SEA mode

Press **SEA MODE** until "SEA OFF" appears in step 2 above. The SEA indicator goes off from the display.

Notes:

- The SEA modes cannot be used for recording.
- When the SEA mode is turned on, the SEA indicator lights up on the display.
- When the SEA mode is used with the DAP mode (see page 34), sounds may be distorted. If this happens, turn off the DAP mode or decrease the effect level of the DAP mode.

Note:

- When the SEA mode is turned on, the SEA indicator lights up on the display.

Using the SEA Modes

Creating Your Own SEA Mode

You can adjust and store your own SEA adjustment into memory (SEA USERMODE).

On the front panel only:

If you do not want to store your adjustment, but rather want to adjust the SEA temporarily, skip step 4 below.

1. Press SEA ADJUST repeatedly until the frequency range (100Hz, 1kHz or 10kHz) you want appears on the display.

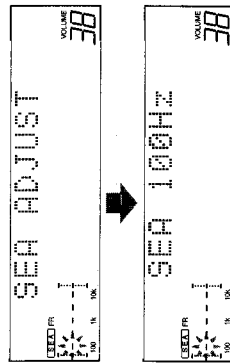

2. Turn MULTI JOG to adjust the SEA level of the selected frequency range, while the indication of the previous step is still on the display.

- Turning it clockwise increases the level.
- Turning it counterclockwise decreases the level.

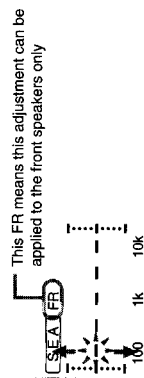

This FR means this adjustment can be applied to the front speakers only

3. Repeat step 1 and 2 to adjust other frequency ranges if necessary.

4. Press TUNER/SEA MEMORY, while the indication of the previous step is still on the display. Your adjustment is stored into the SEA USERMODE.



To recall your own SEA adjustment

See page 28.

To erase a stored adjustment

Storing a new adjustment into SEA USERMODE erases the previously stored one.

Using the DSP Modes

The built-in Surround Processor provides three types of the DSP (Digital Signal Processor) mode — 3D-PHONIC mode, DAP (Digital Acoustic Processor) mode and Surround mode (Dolby Digital, Dolby Pro Logic and JVC's Theater Surround.)

On the 3D-PHONIC mode

The 3D-PHONIC mode gives you such a nearly surround effect as it is reproduced through the Dolby Surround decoder, which is widely used to reproduce sounds with a feeling of movement like those experienced in movie theaters. The 3D-PHONIC mode is the result of research on sound localization technology carried out at JVC for many years and makes it possible to reproduce the surround sound with only two front speakers.

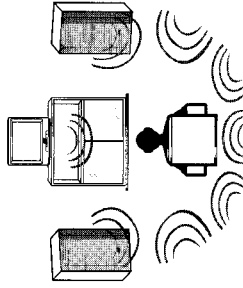

On the DAP mode

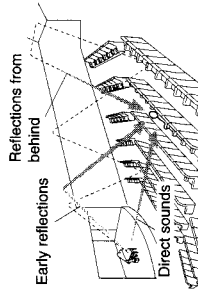

The sound heard in a concert hall or club consists of direct sound and indirect sound — early reflections and reflections from behind. Direct sounds reach the listener directly without any reflection. On the other hand, indirect sounds are delayed by the distances of the ceiling and walls. These direct sounds and indirect sounds are the most important elements of the acoustic surround effects. The DAP mode can create these important elements, and gives you a real "being there" feeling.



On Surround mode



With this receiver, you can use two types of the surround mode.

Dolby Surround (Dolby Digital and Dolby Pro Logic)

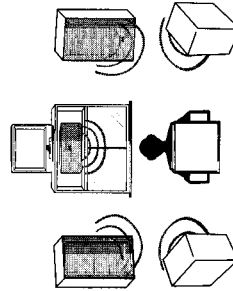
Used to watch the soundtracks of software encoded with Dolby Digital (bearing the mark ) or with Dolby Surround (bearing the mark )). Dolby Digital and Dolby Pro Logic can be selected automatically according to software played back.



JVC's Theater Surround

In order to reproduce a more realistic sound field in your listening room while playing soundtracks of software encoded with Dolby Digital (bearing the mark ) or with Dolby Surround (bearing the mark )), Theater Surround has been designed to create a real "being there" feeling.

Notes:

- The DSP modes has no effect on monaural sources.
- You can not use the two types of the DSP modes at the same time.

IMPORTANT:

When recording the digital source, turn off the DSP mode.

Note:

To enjoy the software encoded with Dolby Digital, you must connect the source component using the digital terminal on the rear of this receiver.

Manufactured under license from Dolby Laboratories. "Dolby," "Pro Logic," the double-D symbol are trademarks of Dolby Laboratories. Confidential Unpublished works. ©1992-1997 Dolby Laboratories, Inc. All rights reserved.



Using the DSP Modes

IMPORTANT:



When using the Remote Control, check to see if its remote control mode selector is set to the correct position:
To operate this receiver, set it to "AUDIO/TV/VCR" (except when selecting the DBS tuner as the source).



Using the 3D-PHONIC Modes

When using the 3D-PHONIC modes, you need only two front speakers to reproduce the soundtracks of software encoded with Dolby Digital (bearing the mark ) or with Dolby Surround (bearing the mark ) or with Dolby Surround (bearing the mark ) .

On the front panel:

1. Select and play the source encoded with Dolby Digital (bearing the mark ) or with Dolby Surround (bearing the mark ) .
 • When you play back the source encoded with Dolby Digital and select the digital input for that source, the  DIGITAL indicator lights up on the display.



2. Press DSP MODE.
 The current DSP mode appears on the display.

3. Turn MULTI JOG until the mode — 3D ACTION (or 3D DIGITAL), 3D DRAMA, or 3D THEATER — you want appears on the display, while the indication of the previous step is still on the display.
 As you turn it, the DSP modes change as follows (the 3D-PHONIC and DSP indicators also light up on the display):

When the digital input is selected to play the source encoded with Dolby



For other sources:

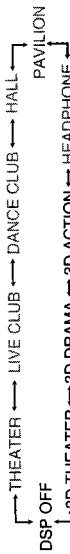

3D ACTION:	Best for action and war movies — where the action is fast and explosive.
3D DRAMA:	Best for dramas and romantic movies — where the action is slow and soft.
3D THEATER:	Reproduces the sound field of a theater.
3D DIGITAL:	Reproduces multi-sound source encoded with Dolby Digital.
DSP OFF:	No DSP mode is applied.

For the other modes, see pages 34 and 39.

If you need to make any adjustment, go to the following steps.

BALANCE/SURROUND ADJUST

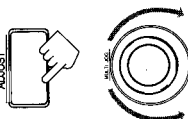

4. Press BALANCE/SURROUND ADJUST repeatedly until "DSP EFFECT" appears on the display.
 The display changes to show the current setting.

5. Turn MULTI JOG to select the effect level, while the indication of the previous step is still on the display.
 As you turn it, the effect level changes as follows:

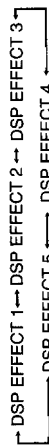

As the number increases, the selected 3D-PHONIC mode becomes stronger.

To cancel the 3D-PHONIC mode

Turn MULTI JOG until "DSP OFF" appears in step 3.
 The 3D-PHONIC and DSP indicators go off from the display.

Notes:

- To enjoy the software encoded with Dolby Digital, you must connect the source component using the digital terminal on the rear of this receiver.
- The 3D-PHONIC mode is not used with the other DSP modes such as the DAP mode and the Surround mode. When the 3D-PHONIC mode is turned on, the other DSP mode, if used, will be turned off.

Notes on the indications:



- The indicator of the selected DSP mode also lights up on the display while selecting.
- The PRO LOGIC indicator lights up when the Dolby Pro Logic decoder built in this receiver is activated.
- The Dolby Pro Logic decoder is used not only for the analog sources but also for the sources encoded with Dolby Digital in the following cases:
 - When only front channel signals are encoded.
 - When front channel and monaural rear channel signals are encoded.
 While the Dolby Pro Logic is activated for this type of Dolby Digital source, the  DIGITAL indicator goes off.

Note:

Once you have adjusted the 3D-PHONIC modes, it is memorized for each 3D-PHONIC mode.

Using the DSP Modes

From the remote control:

1. Select and play the source encoded with Dolby Digital (bearing the mark ) or with Dolby Surround (bearing the mark ).
 - When you play back the source encoded with Dolby Digital and select the digital input for that source, the **DIGITAL** indicator lights up on the display.

2. Press **SURROUND MODE** repeatedly until the mode — **3D ACTION** (or **3D DIGITAL**), **3D DRAMA**, or **3D THEATER** — you want appears on the display.
 Each time you press the button, the DSP modes change as follows (the **3D-PHONIC** and **DSP** indicators also light up on the display):

When the digital input is selected to play the source encoded with Dolby Digital:

 **DOLBY DIGITAL** → **DIG-THEATER** → **OFF** → **3D DIGITAL** → **HEADPHONE**

For other sources:

 **PRO LOGIC** → **THEATER** → **LIVE CLUB** → **DANCE CLUB** → **HALL** → **PAVILION**
 **3D THEATER** → **3D DRAMA** → **3D ACTION** → **HEADPHONE**

3. Press **SOUND CONTROL**.
 10 keys are activated for sound adjustments.

4. Press **EFFECT** to select the effect level.
 Each time you press the button, the effect level changes as follows:

 **DSP EFFECT 1** → **DSP EFFECT 2** → **DSP EFFECT 3** → **DSP EFFECT 4** → **DSP EFFECT 5**

As the number increases, the selected **3D-PHONIC** mode becomes stronger.

To cancel the 3D-PHONIC mode

Press **SURROUND MODE** repeatedly until "OFF" appears. The **3D-PHONIC** and **DSP** indicators go off from the display.

Note:

- The **3D-PHONIC** mode is not used with the other **DSP** modes such as the **DAP** mode and the **Surround mode**. When the **3D-PHONIC** mode is turned on, the other **DSP** mode, if used, will be turned off.

Notes on the indications:

- The indicator of the selected **DSP** mode also lights up on the display while selecting.
- The **PRO LOGIC** indicator lights up when the **Dolby Pro Logic** decoder built in this receiver is activated.
- The **Dolby Pro Logic** decoder is used not only for the analog sources but also for the sources encoded with **Dolby Digital** in the following cases:
 - When only front channel signals are encoded.
 - When front channel and monaural rear channel signals are encoded.
 While the **Dolby Pro Logic** is activated for this type of **Dolby Digital** source, the **DIGITAL** indicator goes off.

Note:

Once you have adjusted the **3D-PHONIC** modes, it is memorized for each **3D-PHONIC** mode.

Using the DAP Modes

You can use five **DAP** modes — "Live Club, Dance Club, Hall, Pavilion, and Headphones" for any source. Among the **DAP** modes, "Headphones" is very special. It can create the same stereo sound as you listen through the speakers off air while listening to a source using headphones. So, you can feel as if you were not using the headphones and listening to music in a room. If the digital input is selected to play the source encoded with **Dolby Digital**, you can only select "Headphones."

On the front panel:

1. Press **DSP MODE**.
 The current **DSP** mode appears on the display.
2. Turn **MULTI JOG** until the mode (**LIVE CLUB**, **DANCE CLUB**, **HALL**, **PAVILION**, or **HEADPHONE**) you want appears on the display, while the indication of the previous step is still on the display. The **DSP** indicator also lights up on the display.

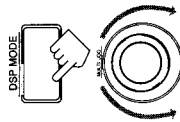

As you turn it, the **DSP** modes change as follows:

 **THEATER** → **LIVE CLUB** → **DANCE CLUB** → **HALL** → **PAVILION**
 **DSP OFF**

When the digital input is selected to play the source encoded with **Dolby Digital**:

 **3D THEATER** → **3D DRAMA** → **3D ACTION** → **HEADPHONE**
 **DIG-THEATER** → **HEADPHONE**
 **DSP OFF** → **3D DIGITAL**

LIVE CLUB:	Gives the feeling of a live music club with a low ceiling.
DANCE CLUB:	Gives a throbbing bass beat.
HALL:	Gives clear vocal and the feeling of a concert hall.
PAVILION:	Gives the spacious feeling of a pavilion with a high ceiling.
HEADPHONE:	Gives a spacious stereo effect when listening with headphones.
DSP OFF:	No DSP mode is applied.

For the other modes, see pages 31 and 39.

If you need to make any adjustment, go to the following steps.

3. Adjust the speaker output levels as follows.
 - 1) Press **BALANCE/SURROUND ADJUST** repeatedly until one of the indications appears on the display.
 - "REAR L LEVEL": To adjust the left speaker level.
 - "REAR R LEVEL": To adjust the right speaker level.
 - 2) Turn **MULTI JOG** to adjust the selected speaker output level (from -10 dB to $+10$ dB), while the indication of the previous step is still on the display.
 - 3) Repeat 1) and 2) to adjust the other speaker output levels.

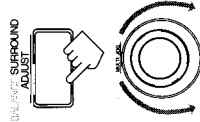

Notes:

- The **DAP** mode is not used with the other **DSP** modes such as the **3D-PHONIC** mode and the **Surround mode**. When the **DAP** mode is turned on, the other **DSP** mode, if used, will be turned off.
- When the **DAP** mode is used with the **SEA** mode (see page 28), sounds may be distorted. If this happens, turn off the **SEA** mode.

Note:

The indicator of the selected **DSP** mode also lights up on the display while selecting.

Note:

When you select "HEADPHONE", you cannot go to the following steps. No adjustments can be made for "HEADPHONE."

Note:

You cannot adjust the rear speaker levels when "REAR SPK" is set to "NONE" (see page 20).

Continued to the next page.

Using the DSP Modes

SURROUND ADJUST

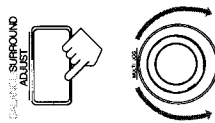

- Adjust the effect level.
1) Press **BALANCE/SURROUND ADJUST** repeatedly until "DSP EFFECT" appears on the display.
2) Turn **MULTI JOG** to select the effect level, while the indication of the previous step is still on the display. As you turn it, the effect level changes as follows:
 DSP EFFECT 1 → DSP EFFECT 2 → DSP EFFECT 3 → DSP EFFECT 4 → DSP EFFECT 5 → DSP EFFECT 4 → DSP EFFECT 3 → DSP EFFECT 2 → DSP EFFECT 1
 As the number increases, the selected DAP mode becomes stronger.

To cancel the DAP mode

Turn **MULTI JOG** until "DSP OFF" appears in step 2. The DSP indicator goes off from the display.

From the remote control:

- Press **SURROUND MODE** repeatedly until the mode you want appears on the display.
The DSP indicator also lights up on the display.

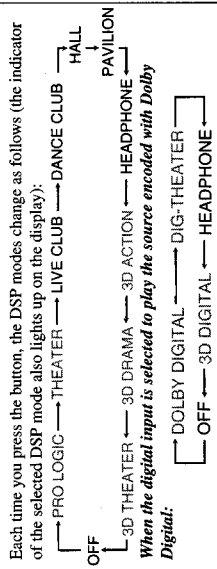

If you need to make any adjustment, go to the following steps.

- Press **SOUND CONTROL**.
10 keys are activated for sound adjustments.
- Adjust the speaker output levels as follows:
 - To adjust the left rear speaker level, press **REAR-L +/-**.
 - To adjust the right rear speaker level, press **REAR-R +/-**.
- Press **EFFECT** to select the effect level.
Each time you press the button, the effect level changes as follows:
 DSP EFFECT 1 → DSP EFFECT 2 → DSP EFFECT 3 → DSP EFFECT 4 → DSP EFFECT 5 → DSP EFFECT 4 → DSP EFFECT 3 → DSP EFFECT 2 → DSP EFFECT 1
 As the number increases, the selected DAP mode becomes stronger.

To cancel the DAP mode

Press **SURROUND MODE** repeatedly until "OFF" appears. The DSP indicator goes off from the display.

Using the Dolby Digital and Dolby Pro Logic Modes

Once you have adjusted the Dolby Digital and Dolby Pro Logic modes, this receiver memorizes adjustment for each mode.
To activate the Dolby Digital and Dolby Pro Logic modes, follow the procedure below.

From the remote control:

- Select and play the source encoded with Dolby Digital (bearing the mark) or with Dolby Surround (bearing the mark).
When you play back the source encoded with Dolby Digital and select the digital input for that source, the **DIGITAL** indicator lights up on the display.
- Press **SURROUND MODE** repeatedly until "PRO LOGIC" or "DOLBY DIGITAL" appears on the display.
Dolby Digital or Dolby Pro Logic is automatically selected according to the source being played back.
When **Dolby Pro Logic** is selected, the lamp on the **DOLBY SURROUND** button (on the front panel) lights red.
When **Dolby Digital** is selected, the lamp on the **DOLBY SURROUND** button (on the front panel) lights green.

Each time you press the button, the DSP modes change as follows:

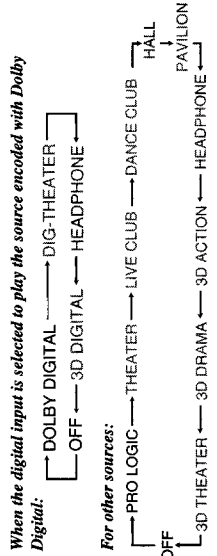

If you need to make any adjustment, go to the following steps.

- Press **SOUND CONTROL**.
10 keys are activated for sound adjustments.

Continued to the next page.

Notes:

- To enjoy the software encoded with Dolby Digital, you must connect the source component using the digital terminal on the rear of this receiver.
- When the signals come into this receiver through the analog connection from the source component, "PRO LOGIC" is automatically selected.
- The Surround mode is not used with the other DSP modes such as the DAP mode and 3D-PHONIC mode. When the Surround mode is turned on, the other DSP mode, if used, will be turned off.

Notes on the indications:

- The **PRO LOGIC** indicator lights up when the Dolby Pro Logic decoder built in this receiver is activated.
 - The Dolby Pro Logic decoder is used not only for the analog sources but also for the sources encoded with Dolby Digital in the following cases:
 - When only front channel signals are encoded.
 - When front channel and monaural rear channel signals are encoded.
- While the Dolby Pro Logic is activated for this type of Dolby Digital source, the **DIGITAL** indicator goes off.

Using the DSP Modes

English

4. Press TEST to start checking the speaker output balance.

"TEST TONE L" starts flashing on the display, and a test tone comes out of the speakers in the following order:

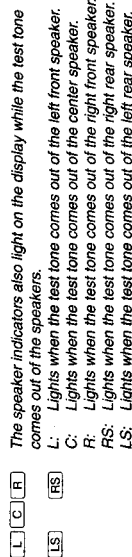
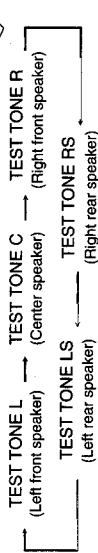

The speaker indicators also light on the display while the test tone comes out of the speakers.

- L: Lights when the test tone comes out of the left front speaker.
- C: Lights when the test tone comes out of the center speaker.
- R: Lights when the test tone comes out of the right front speaker.
- RS: Lights when the test tone comes out of the right rear speaker.
- LS: Lights when the test tone comes out of the left rear speaker.

IMPORTANT:

- Output the test tone while playing back an audio source. With the DVD digital input selected as the source, no test tone may come out while no signal is input to this receiver.
- Test tone comes out even while playing back a source encoded with Dolby Digital. In this case, the PRO LOGIC indicator lights up on the display.

5. Adjust the speaker output levels as follows:

- To adjust the center speaker level, press CNTR +/-.
- To adjust the left rear speaker level, press REAR-L +/-.
- To adjust the right rear speaker level, press REAR-R +/-.

6. Press TEST again to stop the test tone.

7. Press CNTR TONE to select the center tone level you want.

The center tone adjustment affects the mid-frequency range, which the human voice is mostly made up of. Each time you press the button, the display changes to show the following:

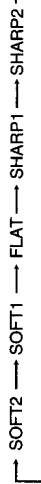

A adjusted level are also shown on the equalizer display.

This CNTR means this adjustment can be applied to the center speaker only. (Example: When "FLAT" is selected.)

- To make the dialogue clearer, select "SHARP1" (little) or "SHARP2" (much).
- To make the dialogue softer, select "SOFT1" (little) or "SOFT2" (much). When "FLAT" is selected, no adjustment is applied.

To cancel the Surround mode

Press SURROUND MODE repeatedly until "OFF" appears.

Notes:

- No test tone comes out of the center speakers when "CENTER SPK" is set to "NONE" (see page 20).
- No test tone comes out of the rear speakers when "REAR SPK" is set to "NONE" (see page 20).
- If the TV is turned on and the proper video input is selected on the TV, the test tone screen will appear on the TV.

Notes:

- You can adjust the speaker output levels and center tone without outputting the test tone.
- You cannot adjust the center speaker output level when "CENTER SPK" is set to "NONE" (see page 20).
- You cannot adjust the rear speaker levels when "REAR SPK" is set to "NONE" (see page 20).

Note:

The center tone cannot be adjusted when "CENTER SPK" is set to "NONE" (see page 20).

On the front panel:

You can also use the buttons on the front panel to adjust the Dolby Digital and Dolby Pro Logic modes. However, no test tone is available when using the buttons on the front panel. So, make adjustments while listening to the sound of the source played back.

- Select and play the source encoded with Dolby Digital (bearing the mark) or with Dolby Surround (bearing the mark). When you play back the source encoded with Dolby Digital and select the digital input for that source, the indicator lights up on the display.

- Press DOLBY SURROUND so that the lamp on the button lights up.

"SURROUND ON" appears on the display.

Dolby Digital or Dolby Pro Logic is automatically selected according to the source being played back.

When Dolby Pro Logic is selected, the lamp on the DOLBY SURROUND button lights red.

When Dolby Digital is selected, the lamp on the DOLBY SURROUND button lights green.

If you need to make any adjustment, go to the following steps.

3. Adjust the speaker output levels as follows.

- Press BALANCE/SURROUND ADJUST repeatedly until one of the indications appears on the display. "CENTER LEVEL": To adjust the center speaker level. "REAR L LEVEL": To adjust the left speaker level. "REAR R LEVEL": To adjust the right speaker level.
- Turn MULTI JOG to adjust the selected speaker output level (from -10 dB to +10 dB), while the indicator of the previous step is still on the display.
- Repeat 1) and 2) to adjust the other speaker output levels.

- Press BALANCE/SURROUND ADJUST repeatedly until "CENTER TONE" appears on the display.

The display changes to show the current setting.

- Turn MULTI JOG to select the center tone level you want, while the indication of the previous step is still on the display.

The center tone adjustment affects the mid-frequency range, which the human voice is mostly made up of. As you turn it, the display changes to show the following:

SOFT2 → SOFT1 → FLAT → SHARP1 → SHARP2

To make the dialogue clearer, select "SHARP1" (little) or "SHARP2" (much).

To make the dialogue softer, select "SOFT1" (little) or "SOFT2" (much).

When "FLAT" is selected, no adjustment is applied.

To cancel the Surround mode

Press DOLBY SURROUND again so that "SURROUND OFF" appears.

Notes:

- To enjoy the software encoded with Dolby Digital, you must connect the source component using the digital terminal on the rear of this receiver.
- When the signals come into this receiver through the analog connection from the source component, "PRO LOGIC" is automatically selected.
- The Surround mode is not used with the other DSP modes such as the DAP mode and 3D-PHONIC mode. When the Surround mode is turned on, the other DSP mode, if used, will be turned off.

Notes on the indications:

- The PRO LOGIC indicator lights up when the Dolby Pro Logic decoder built in this receiver is activated.
- The Dolby Pro Logic decoder is used not only for the analog sources but also for the sources encoded with Dolby Digital in the following cases:
 - When only front channel signals are encoded.
 - When front channel and monaural rear channel signals are encoded.
- While the Dolby Pro Logic is activated for this type of Dolby Digital source, the indicator goes off.

Notes:

- You cannot adjust the center speaker level when "CENTER SPK" is set to "NONE" (see page 20).
- You cannot adjust the rear speaker levels when "REAR SPK" is set to "NONE" (see page 20).



English

Using the DSP Modes

Using the Theater Surround Mode

Once you have adjusted the Theater Surround mode, this receiver memorizes the adjustment. To activate the Theater Surround mode, follow the procedure below.

From the remote control:

1. Select and play the source encoded with Dolby Digital (bearing the mark ) or with Dolby Surround (bearing the mark ).
When you play back the source encoded with Dolby Digital and select the digital input for that source, the **DDIGITAL** indicator lights up on the display.
2. Press **SURROUND MODE** repeatedly until "THEATER" or "DIG-THEATER" appears on the display.
The DSP and THEATER indicators also light up on the display.

Each time you press the button, the DSP modes change as follows:

When the digital input is selected to play the source encoded with Dolby Digital:

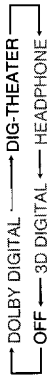

For other sources:



If you need to make any adjustment, go to the following steps.

3. Press SOUND CONTROL.

10 keys are activated for sound adjustments.

4. Press TEST to start checking the speaker output balance.

"TEST TONE L" starts flashing on the display, and a test tone comes out of the speakers in the following order:



The speaker indicators also light on the display while the test tone comes out of the speakers.

- L: Lights when the test tone comes out of the left front speaker.
- C: Lights when the test tone comes out of the center speaker.
- R: Lights when the test tone comes out of the right front speaker.
- RS: Lights when the test tone comes out of the right rear speaker.
- LS: Lights when the test tone comes out of the left rear speaker.

IMPORTANT:

- Output the test tone while playing back an audio source.
With the DVD digital input selected as the source, no test tone may come out while no signal is input to this receiver.
- Test tone comes out even while playing back a source encoded with Dolby Digital. In this case, the PRO LOGIC indicator lights up on the display.

5. Adjust the speaker output levels as follows:

- To adjust the center speaker level, press **CNTR +/-**.
- To adjust the left rear speaker level, press **REAR-L +/-**.
- To adjust the right rear speaker level, press **REAR-R +/-**.

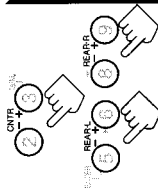

6. Press TEST again to stop the test tone.

7. Press CNTR TONE to select the center tone level you want.

The center tone adjustment affects the mid-frequency range, which the human voice is mostly made up of. Each time you press the button, the display changes to show the following:

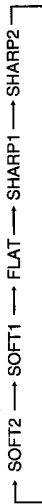

Adjusted level are also shown on the on the equalizer display.

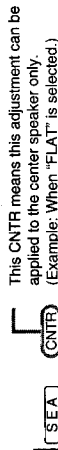

This CNTR means this adjustment can be applied to the center speaker only.
(Example: When "FLAT" is selected.)

To make the dialogue clearer, select "SHARP1" (little) or "SHARP2" (much).
To make the dialogue softer, select "SOFT1" (little) or "SOFT2" (much).
When "FLAT" is selected, no adjustment is applied.

8. Press EFFECT to select the effect level.

Each time you press the button, the effect level changes as follows:



As the number increases, the surround effect becomes stronger.

To cancel the Theater Surround mode

Press SURROUND MODE repeatedly until "OFF" appears.
The DSP and THEATER indicators goes off.

Notes:

- You can adjust the speaker output levels and center tone without outputting the test tone.
- You cannot adjust the center speaker level when "CENTER SPK" is set to "NONE" (see page 20).
- You cannot adjust the rear speaker levels when "REAR SPK" is set to "NONE" (see page 20).

Note:



The center tone cannot be adjusted when "CENTER SPK" is set to "NONE" (see page 20).

Note:

You cannot adjust the effect level when "REAR SPK" is set to "NONE" (see page 20).

On the front panel:

You can also use the buttons on the front panel to adjust the Theater Surround mode. However, no test tone is available when using the buttons on the front panel. So, make adjustments while listening to the sound of the source played back.

1. Select and play the source encoded with Dolby Digital (bearing the mark ) or with Dolby Surround (bearing the mark ).
 - When you play back the source encoded with Dolby Digital and select the digital input for that source, the **DI DIGITAL** indicator lights up on the display.
2. Press **DSP MODE**.
 - The current DSP mode appears on the display.
3. Turn **MULTI JOG** until "THEATER" or "DIG-THEATER" appears on the display, while the indication of the previous step is still on the display.
 - The **DSP** and **THEATER** indicators also light up on the display.

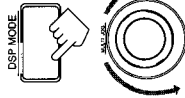

As you turn it, the DSP modes change as follows:

When the digital input is selected to play the source encoded with Dolby Digital:



For other sources:



If you need to make any adjustment, go to the following steps.

4. Adjust the speaker output levels as follows.
 - 1) Press **BALANCE/SURROUND ADJUST** repeatedly until one of the indications appears on the display.
 - "CENTER LEVEL": To adjust the center speaker level.
 - "REAR L LEVEL": To adjust the left speaker level.
 - "REAR R LEVEL": To adjust the right speaker level.
 - 2) Turn **MULTI JOG** to adjust the selected speaker output level (from -10 dB to +10 dB), while the indication of the previous step is still on the display.
 - 3) Repeat (1) and (2) to adjust the other speaker output levels.

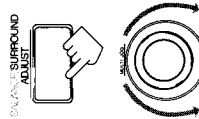

- Notes:**
- To enjoy the software encoded with Dolby Digital, you must connect the source component using the digital terminal on the rear of this receiver.
 - The Surround mode is not used with the other DSP modes such as the DAP mode and 3D-PHONIC mode. When the Surround mode is turned on, the other DSP mode, if used, will be turned off.

Notes on the indications:

- The **PRO LOGIC** indicator lights up when the Dolby Pro Logic decoder built in this receiver is activated.
- The Dolby Pro Logic decoder is used not only for the analog sources but also for the sources encoded with Dolby Digital in the following cases:
 - When only front channel signals are encoded.
 - When front channel and monaural rear channel signals are encoded.
- While the Dolby Pro Logic is activated for this type of Dolby Digital source, the **DI DIGITAL** indicator goes off.

- Notes:**
- You cannot adjust the center speaker level when "CENTER SPK" is set to "NONE" (see page 20).
 - You cannot adjust the rear speaker levels when "REAR SPK" is set to "NONE" (see page 20).

5. Press **BALANCE/SURROUND ADJUST** repeatedly until "CENTER TONE" appears on the display.
 - The display changes to show the current setting.



6. Turn **MULTI JOG** to select the center tone level you want, while the indication of the previous step is still on the display.
 - The center tone adjustment affects the mid-frequency range, which the human voice is mostly made up of.
 - As you turn it, the display changes to show the following:
 - SOFT2 → SOFT1 → FLAT → SHARP1 → SHARP2

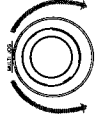

7. Press **BALANCE/SURROUND ADJUST** repeatedly until "DSP EFFECT" appears on the display.
 - The display changes to show the current setting.



8. Turn **MULTI JOG** to select the effect level, while the indication of the previous step is still on the display.
 - As you turn it, the effect level changes as follows:
 - DSP EFFECT 1 → DSP EFFECT 2 → DSP EFFECT 3 → DSP EFFECT 4 → DSP EFFECT 5
 - As the number increases, the surround effect becomes stronger.



Note:
You cannot adjust the effect level when "REAR SPK" is set to "NONE" (see page 20).

To cancel the Theater Surround mode

Turn **MULTI JOG** until "DSP OFF" appears in step 3. The **DSP** and **THEATER** indicators goes off.

Using the On-Screen Menus

You can use the menus on the TV screen to control the receiver. To use this function, you need to connect the TV to the MONITOR OUT jack on the rear panel (see page 10), and set the TV's input mode to the proper position to which the receiver is connected.

Selecting the Source to Play (Also see page 14)

1. Press any button of ON SCREEN CONTROL Δ / ∇ / \triangleleft / \triangleright once. The MAIN MENU appears on the TV.

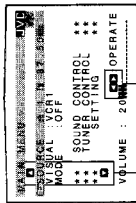

Shows the buttons you can use on the current menu. In this case, use Δ / ∇ to move \square up and down, and \triangleleft / \triangleright to select, adjust or set the item.

2. Press ON SCREEN CONTROL Δ / ∇ to move \square to "SOURCE."
3. Press ON SCREEN CONTROL \triangleleft / \triangleright to select the source.
4. When you finish, press EXIT. The menu disappears from the TV.

Selecting the Different Sources for Picture and Sound

You can view the pictures played back on a video component while listening to any source.

1. Press any button of ON SCREEN CONTROL Δ / ∇ / \triangleleft / \triangleright once. The MAIN MENU appears on the TV.
2. Press ON SCREEN CONTROL Δ / ∇ to move \square to "VISUAL."
3. Press ON SCREEN CONTROL \triangleleft / \triangleright to select a different video source.
 - When you select "OSD", see page 51.
4. When you finish, press EXIT. The menu disappears from the TV.

Using the DSP Modes (Also see pages 31, 34, 36, 39)

1. Press any button of ON SCREEN CONTROL Δ / ∇ / \triangleleft / \triangleright once. The MAIN MENU appears on the TV.
2. Press ON SCREEN CONTROL Δ / ∇ to move \square to "MODE."
3. Press ON SCREEN CONTROL \triangleleft / \triangleright to select the DSP mode you want to use.
4. When you finish, press EXIT. The menu disappears from the TV.

Adjusting the Front Speaker Output Balance (Also see page 19)

1. Press any button of ON SCREEN CONTROL Δ / ∇ / \triangleleft / \triangleright once. The MAIN MENU appears on the TV.
2. Press ON SCREEN CONTROL Δ / ∇ to move \square to "SOUND CONTROL," then press \triangleleft / \triangleright . The SOUND CONTROL menu appears on the TV.
3. Press ON SCREEN CONTROL Δ / ∇ to move \square to "BAL." (Balance).
4. Press ON SCREEN CONTROL \triangleleft / \triangleright to adjust the balance.
5. When you finish, press EXIT repeatedly until the menu disappears from the TV.



SOUND CONTROL menu

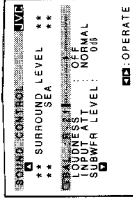

Listening at Low Volume (Loudness) (Also see page 19)

1. Press any button of ON SCREEN CONTROL Δ / ∇ / \triangleleft / \triangleright once. The MAIN MENU appears on the TV.
2. Press ON SCREEN CONTROL Δ / ∇ to move \square to "SOUND CONTROL," then press \triangleleft / \triangleright . The SOUND CONTROL menu appears on the TV.
3. Press ON SCREEN CONTROL Δ / ∇ to move \square to "LOUDNESS."
4. Press ON SCREEN CONTROL \triangleleft / \triangleright to turn the loudness "ON" or "OFF."
5. When you finish, press EXIT repeatedly until the menu disappears from the TV.

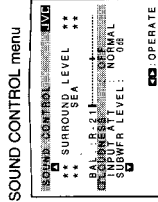

Attenuating the Input Signal (Also see page 16)

This function is available only for the sources connected using the analog terminals and takes effect only when the DSP mode is in use.

1. Press any button of ON SCREEN CONTROL Δ / ∇ / \triangleleft / \triangleright once. The MAIN MENU appears on the TV.
2. Press ON SCREEN CONTROL Δ / ∇ to move \square to "SOUND CONTROL," then press \triangleleft / \triangleright . The SOUND CONTROL menu appears on the TV.
3. Press ON SCREEN CONTROL Δ / ∇ to move \square to "INPUT ATT."
4. Press ON SCREEN CONTROL \triangleleft / \triangleright to turn the function on ("ATT ON") or off ("NORMAL").
5. When you finish, press EXIT repeatedly until the menu disappears from the TV.

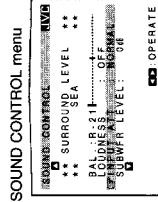

Using the On-Screen Menus

- Adjusting the Subwoofer Output Level** (Also see page 17)

You can adjust the subwoofer output level if you have selected "YES" for the "SUBWOOFER" (see page 19).

 1. Press any button of **ON SCREEN CONTROL** Δ / ∇ / \triangleleft / \triangleright **once**. The **MAIN MENU** appears on the TV.
 2. Press **ON SCREEN CONTROL** Δ / ∇ to move \square to "SOUND CONTROL," then press \triangleleft / \triangleright . The **SOUND CONTROL** menu appears on the TV.
 3. Press **ON SCREEN CONTROL** Δ / ∇ to move \square to "SUBWFR LEVEL" (Subwoofer Level).
 4. Press **ON SCREEN CONTROL** \triangleleft / \triangleright to adjust the subwoofer output level.
 5. When you finish, press **EXIT** repeatedly until the menu disappears from the TV.
- Adjusting the DSP Modes** (Also see pages 31, 34, 36, and 39)

 1. Press any button of **ON SCREEN CONTROL** Δ / ∇ / \triangleleft / \triangleright **once**. The **MAIN MENU** appears on the TV.
 2. Press **ON SCREEN CONTROL** Δ / ∇ to move \square to "MODE."
 3. Press **ON SCREEN CONTROL** \triangleleft / \triangleright to select the **DSP** mode you want to adjust.
 4. Press **ON SCREEN CONTROL** Δ / ∇ to move \square to "SOUND CONTROL," then press \triangleleft / \triangleright . The **SOUND CONTROL** menu appears.
 5. Press **ON SCREEN CONTROL** Δ / ∇ to move \square to "SURROUND LEVEL," then press \triangleleft / \triangleright . The **SURROUND LEVEL** menu appears.
 - If you select "HEADPHONE" in step 3, the **SURROUND LEVEL** menu will not appear.
 6. Press **ON SCREEN CONTROL** Δ / ∇ to move \square to the item you want to set or adjust, then press **ON SCREEN CONTROL** \triangleleft / \triangleright . On these adjustment menus, you can do the following:

For 3D-PHONIC modes:

 - "DSP EFFECT": Adjust the effect level.

For DAP modes (LIVE CLUB, DANCE CLUB, HALL, PAVILION):

 - "REAR L LEVEL": Adjust the left rear speaker output level. *
 - "REAR R LEVEL": Adjust the right rear speaker output level. *
 - "DSP EFFECT": Select the effect level.

MAIN MENU

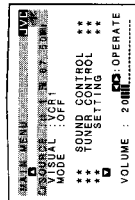

SOUND CONTROL menu

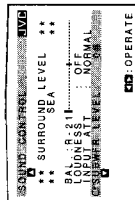

For Dolby Surround Pro Logic:

- "TEST TONE": Output a test tone.
- "CENTER LEVEL": Adjust the center speaker output level. **
- "REAR L LEVEL": Adjust the left rear speaker output level. *
- "REAR R LEVEL": Adjust the right rear speaker output level. *
- "CENTER TONE": Select the center tone level. **

For Dolby Digital:

- "TEST TONE": Output a test tone.
- "CENTER LEVEL": Adjust the center speaker output level. **
- "REAR L LEVEL": Adjust the left rear speaker output level. *
- "REAR R LEVEL": Adjust the right rear speaker output level. *
- "CENTER TONE": Select the center tone level. **

For Theater Surround and Digital Theater Surround:

- "TEST TONE": Output a test tone.
- "CENTER LEVEL": Adjust the center speaker output level. **
- "REAR L LEVEL": Adjust the left rear speaker output level. *
- "REAR R LEVEL": Adjust the right rear speaker output level. *
- "CENTER TONE": Select the center tone level. **
- "DSP EFFECT": Select the effect level. *

7. When you finish, press **EXIT** repeatedly until the menu disappears from the TV.

■ Selecting Your Favorite SEA Mode

 (Also see page 28)

1. Press any button of **ON SCREEN CONTROL** Δ / ∇ / \triangleleft / \triangleright **once**. The **MAIN MENU** appears on the TV.
2. Press **ON SCREEN CONTROL** Δ / ∇ to move \square to "SOUND CONTROL," then press \triangleleft / \triangleright . The **SOUND CONTROL** menu appears.
3. Press **ON SCREEN CONTROL** Δ / ∇ to move \square to "SEA," then press \triangleleft / \triangleright . The **SEA** menu appears.
4. Press **ON SCREEN CONTROL** Δ / ∇ to move \square to "SEA MODE."
5. Press **ON SCREEN CONTROL** \triangleleft / \triangleright to select the **SEA** mode you want.
6. When you finish, press **EXIT** repeatedly until the menu disappears from the TV.

Example:
SURROUND LEVEL menu
for Theater Surround



Notes:

- * Not displayed when "REAR SPK" is set to "NONE" (see page 20).
- ** Not displayed when "CENTER SPK" is set to "NONE" (see page 20).

MAIN MENU

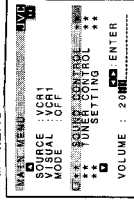

SOUND CONTROL menu

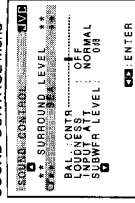

SEA menu

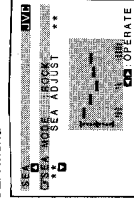

Creating Your Own SEA Mode (Also see page 29)

1. Press any button of ON SCREEN CONTROL $\Delta/\nabla/\leftarrow/\rightarrow$ once. The MAIN MENU appears on the TV.
2. Press ON SCREEN CONTROL Δ/∇ to move \square to "SOUND CONTROL," then press \leftarrow/\rightarrow . The SOUND CONTROL menu appears.
3. Press ON SCREEN CONTROL Δ/∇ to move \square to "SEA," then press \leftarrow/\rightarrow . The SEA menu appears.
4. Press ON SCREEN CONTROL Δ/∇ to move \square to "SEA ADJUST," then press \leftarrow/\rightarrow . The SEA ADJUST menu appears.
5. Press ON SCREEN CONTROL $\Delta/\nabla/\leftarrow/\rightarrow$ to adjust the SEA mode as you want.
 \leftarrow/\rightarrow : Select the frequency ranges.
 Δ/∇ : Adjust the frequency levels.
6. Press SET to store the setting into the SEA USERMODE.
 • If you press EXIT, without pressing SET in this step, you can return to the SEA menu. (The adjustment you have made is active but not stored.)
7. When you finish, press EXIT repeatedly until the menu disappears from the TV.

Basic Settings

1. Press any button of ON SCREEN CONTROL $\Delta/\nabla/\leftarrow/\rightarrow$ once. The MAIN MENU appears on the TV.
2. Press ON SCREEN CONTROL Δ/∇ to move \square to "SETTING," then press \leftarrow/\rightarrow . The SETTING 1 or SETTING 2 menu appears.
3. Press ON SCREEN CONTROL Δ/∇ to the setting item you want to adjust.
 - To go to the SETTING 2 menu, move \square to "NEXT PAGE," then press \leftarrow/\rightarrow .
 - To go back to the SETTING 1 menu, move \square to "PREVIOUS PAGE," then press \leftarrow/\rightarrow .
 On the SETTING 1 and 2 menus, you can do the following:
 - "SUBWOOFER": Set the subwoofer information (See page 19).
 - "FRONT SPK": Set the front speaker information (See page 20).
 - "CENTER SPK": Set the center speaker information (See page 20).
 - "REAR SPK": Set the rear speaker information (See page 20).
 - "CNTR DELAY": Adjust the delay time of the center speaker output (See page 21).
 - "REAR DELAY": Adjust the delay time of the rear speaker output (See page 21).
 - "CROSSOVER": Set the crossover frequency (See page 21).
 - "LFE ATT": Set the low frequency effect attenuator level (See page 22).
 - "COMP": Set the dynamic range compression (See page 22).
 - "DIGITAL 1/2/3": Set the digital input terminal. (See page 20).

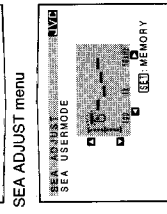
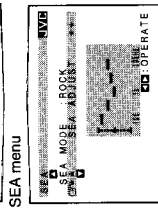
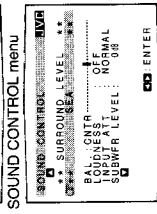
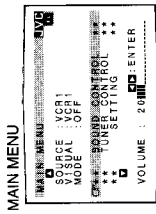

SETTING 1 menu

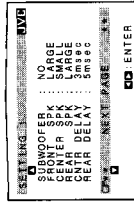

SETTING 2 menu

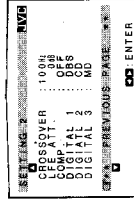

4. Press ON SCREEN CONTROL \leftarrow/\rightarrow to set (or adjust) the setting item selected in step 3.
5. When you finish, press EXIT repeatedly until the menu disappears from the TV.

Operating the Tuner

1. Press any button of ON SCREEN CONTROL $\Delta/\nabla/\leftarrow/\rightarrow$ once. The MAIN MENU appears on the TV.
2. Press ON SCREEN CONTROL Δ/∇ to move \square to "TUNER CONTROL," then press \leftarrow/\rightarrow . The TUNER CONTROL menu appears.
3. Press ON SCREEN CONTROL Δ/∇ to move \square to the item you want to set or adjust, then press ON SCREEN CONTROL \leftarrow/\rightarrow . On the TUNER CONTROL menu, you can do the following:
 - "PRESET CH": Select a preset channel station. (See page 25)
 - "BAND": Select the band. (See page 24)
 - "FREQUENCY": Tune in a station manually. (See page 24)
 - "FM MODE": Select the FM reception mode. (See page 26)
 - "PRESET MEMORY": See "Storing the Preset Stations" below.

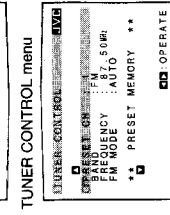
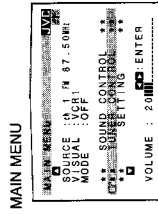

Note:

• Not displayed when an AM station is selected.

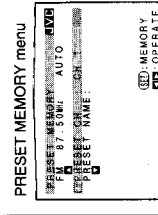

4. When you finish, press EXIT repeatedly until the menu disappears from the TV.

Storing the Preset Stations (Also see page 24)

1. Press any button of ON SCREEN CONTROL $\Delta/\nabla/\leftarrow/\rightarrow$ once. The MAIN MENU appears on the TV.
2. Press ON SCREEN CONTROL Δ/∇ to move \square to "TUNER CONTROL," then press \leftarrow/\rightarrow . The TUNER CONTROL menu appears.
3. Tune into a station on the TUNER CONTROL menu, referring to "Operating the Tuner" above.
4. Press ON SCREEN CONTROL Δ/∇ to move \square to "PRESET MEMORY," then press \leftarrow/\rightarrow . The PRESET MEMORY menu appears.
5. Press ON SCREEN CONTROL Δ/∇ to move \square to "PRESET CH."
6. Press ON SCREEN CONTROL \leftarrow/\rightarrow to select a preset station number you want.
7. Press SET to store the setting.
8. When you finish, press EXIT repeatedly until the menu disappears from the TV.

Using the On-Screen Menus

English

- Assigning Names to the Preset Stations (Also see page 26)
1. Press any button of ON SCREEN CONTROL Δ / ∇ / \triangleleft / \triangleright / \triangleleft / \triangleright once. The MAIN MENU appears on the TV.
2. Press ON SCREEN CONTROL Δ / ∇ to move \square to "TUNER CONTROL," then press \triangleleft / \triangleright . The TUNER CONTROL menu appears.
3. Press ON SCREEN CONTROL Δ / ∇ to move \square to "PRESET CH." Press ON SCREEN CONTROL \triangleleft / \triangleright to select a preset station.
4. Press ON SCREEN CONTROL Δ / ∇ to move \square to "PRESET MEMORY," then press \triangleleft / \triangleright . The PRESET MEMORY menu appears.
5. Press ON SCREEN CONTROL Δ / ∇ to move \square to "PRESET NAME," then press SET. The character entry screen appears.
6. Press ON SCREEN CONTROL Δ / ∇ to move \square to "PRESET NAME," then press SET. The character entry screen appears.
7. Press ON SCREEN CONTROL Δ / ∇ / \triangleleft / \triangleright to move \square in front of a character you want. You can also select the following:
SPACE: To enter space CANCEL: To erase the character \triangleleft / \triangleright : To go back to the previous character position or go to the next character position
8. Press SET to enter the selected character.
9. Repeat steps 7 and 8 to enter up to four characters.
10. Press ON SCREEN CONTROL Δ / ∇ / \triangleleft / \triangleright to move \square to "PRESET NAME," then press SET to store the setting. The TUNER CONTROL menu appears again.
11. When you finish, press EXIT repeatedly until the menu disappears from the TV.

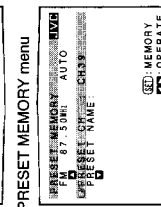
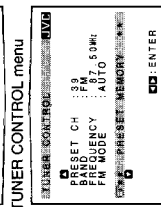
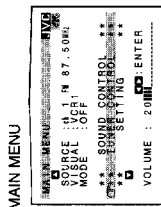

PRESET MEMORY menu:
Character entry screen

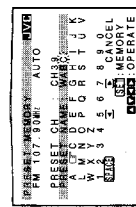
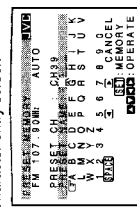

COMPU LINK Remote Control System

English

The COMPU LINK remote control system allows you to operate JVC audio components through the remote sensor on the receiver.

To use this remote control system, you need to connect JVC audio components through the COMPU LINK-3 (SYNCHRO) jacks (see below) in addition to the connections using cables with RCA pin plugs (see page 9) (and a digital cable if you want — see page 12).

- Make sure that the AC power cords of these components are unplugged before connection. Plug the AC power cords only after all connections are complete.



This remote control system allows you to use four functions listed below.

Remote Control through the Remote Sensor on the Receiver

You can control the connected audio components through the remote sensor on the receiver using this remote control. Aim the remote control directly at the remote sensor on the receiver. For details, see pages 58 and 59.

Automatic Source Selection

When you press the play (\blacktriangleright) button on a connected component or on its own remote control, the receiver automatically turns on and changes the source to the component. On the other hand, if you select a new source on the receiver or the remote control, the selected component begins playing immediately.

In both cases, the previously selected source continues playing without sound for a few seconds.

Automatic Power On/Off (Standby): only possible with the COMPU LINK-3 connection

Both the CD player and cassette deck (or MD recorder) turn on and off (standby) along with the receiver.

When you turn on the receiver, the CD player or cassette deck (or MD recorder) will turn on automatically, depending on which component has been previously selected. When you turn off the receiver, both the CD player and cassette deck (or MD recorder) will turn off (standby).

Synchronized Recording

Synchronized recording means the cassette deck (or MD recorder) starts recording as soon as a CD or a record begins playing.

To use synchronized recording, follow these steps:

- Put a tape in the cassette deck (or an MD in the MD recorder), and a disc in the CD player (or a record on the turntable).
- Press the record (\bullet) button and the pause (II) button on the cassette deck (or MD recorder) at the same time. This puts the cassette deck (or MD recorder) into recording pause. If you do not press the record (\bullet) button and pause (II) button at the same time, the synchronized recording feature will not operate.
- Press the play (\blacktriangleright) button on the CD player or on the turntable. The source changes on the receiver, and as soon as play starts, the cassette deck (or MD recorder) starts recording. When the play ends, the cassette deck (or MD recorder) enters recording pause, and stops about 4 seconds later.

Notes:

- If your audio component has two COMPU LINK-3 (SYNCHRO) jacks, you can use either one. If it has only one COMPU LINK-3 (SYNCHRO) jack, connect it so that it is the last item in the series of components. (For example, the turntable or CD player in the diagram to the left.)
- To operate the cassette deck or MD recorder using the COMPU LINK remote control system, set the source name correctly. (See page 18.)
- Refer also to the manuals supplied with your audio components.

Notes:

- During synchronized recording, the selected source cannot be changed.
- If your CD player is playing in program mode, a 4-second blank is recorded between tracks so that the music scan feature of your cassette deck can be used on the recorded tape.
- If the power of any component is shut off during synchronized recording, the COMPU LINK remote control system may not operate properly. In this case, you must start again from the beginning.

TEXT COMPU LINK Remote Control System

The TEXT COMPU LINK remote control system has been newly developed to deal with the disc information recorded in the CD Text* and MDs. Using these information in the discs, you can operate the CD player or MD recorder equipped with the TEXT COMPU LINK remote control system through the receiver.

CONNECTIONS:

To use this remote control system, you need to connect the TV to the MONITOR OUT jack on the rear panel (see page 10), and set the TV's input mode to the proper position to which the receiver is connected. **Make sure you have connected the CD player or MD recorder equipped with the TEXT COMPU LINK remote control system. If not, you cannot use the following functions.**

1. If you have already plugged your CD player, MD recorder, and this receiver into the AC outlets, unplug their AC power cords first.
2. Connect your CD player, MD recorder, and this receiver as follows, through the COMPU LINK-3 (SYNCHRO) jacks and TEXT COMPU LINK jacks.

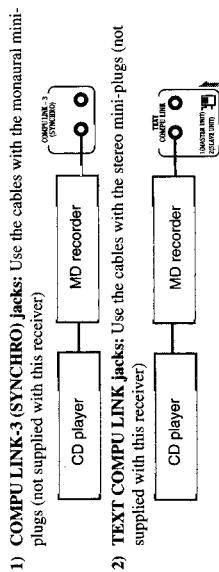

IMPORTANT:

Set the Master/Slave Selector on the rear to "1(MASTER UNIT)."
 • "2(SLAVE UNIT)" is just for the serviceman's use. The TEXT COMPU LINK remote control system does not function with the selector set to "2(SLAVE UNIT)."

3. Connect your CD player, MD recorder and this receiver, using the cables with RCA pin plugs (see page 9) and a digital cable if you want — see page 12).
4. Plug the AC power cords of these components above into the AC outlets.
5. When turning on these components for the first time, turn on the connected components first, then turn on this receiver.

FUNCTIONS:

This remote control system allows you to use the functions listed below.

Displaying the Disc Information on the TV screen

Disc information such as its performer and disc title (and track titles only when a CD Text is selected) is shown on the TV screen.

Disc Search: Only for CD Player

This remote control system can allow you to search discs by the performer, disc title, and music genre.

With this disc search, you can easily find the disc you want to play.

Additional Functions:

- If your CD player has the User File function, you can select a disc from the groups. * A "user file" is a group of the discs you make as you like on the CD player.
- If your CD player has the disc memory function, you can input the performer, disc title, and music genre about these normal audio CDs on the TV screen.

OPERATIONS

To use this remote control system, you need to connect the TV to the MONITOR OUT jack on the rear panel (see page 10), and set the TV's input mode to the proper position to which the receiver is connected. **Make sure you have connected the CD player or MD recorder equipped with the TEXT COMPU LINK remote control system. If not, you cannot use the following functions.**

Showing the Disc Information on the TV Screen

1. Press any button of ON SCREEN CONTROL $\Delta / \nabla / \triangleleft / \triangleright$ once. The MAIN MENU appears on the TV.
2. Press ON SCREEN CONTROL Δ / ∇ to move \square to "SOURCE."*
3. Press ON SCREEN CONTROL $\triangleleft / \triangleright$ to select "CD" or "MD."
4. Press ON SCREEN CONTROL Δ / ∇ to move \square to "VISUAL."
5. Press ON SCREEN CONTROL $\triangleleft / \triangleright$ to select "OSD," then press EXIT. The Disc Information screen appears on the TV.

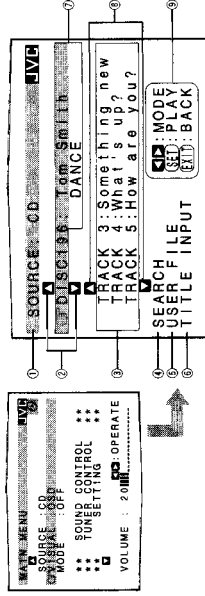

- ① Source name: CD or MD
- ② Select \square or \square then press SET to change the disc.
- ③ Track numbers and track titles.
 - The current playing (selected) track is indicated in yellow.
 - When you move \square to a track number, you can change the track information by pressing $\triangleleft / \triangleright$. Each time you press the button, track information alternates between its track title and its performer. (You can also start playing the track by pressing SET.)
- ④ Select this (move \square in front), then press SET to go to the DISC SEARCH screen (see page 53).
- ⑤ Select this (move \square in front), then press SET to go to the USER FILE screen (see page 55).
- ⑥ Select this (move \square in front), then press SET to go to the TITLE INPUT screen (see page 56).
- ⑦ Disc information such as the disc title, performer, and music genre. When this is selected (\square in front), you can change the disc information by pressing $\triangleleft / \triangleright$. Each time you press the button, disc information (see the note) changes.
- ⑧ Select \square or \square then press SET to change the track.
- ⑨ Usable buttons and their functions for the current selection. Indication here will be changed what is currently selected (\square in front) on the screen.

6. When you finish, press EXIT repeatedly until the MAIN MENU appears on the TV.

To exit from the MAIN MENU:

- 1) Press ON SCREEN CONTROL Δ / ∇ to move \square to "VISUAL."
- 2) Press ON SCREEN CONTROL $\triangleleft / \triangleright$ to select any one other than "OSD," then press EXIT.

Notes:

- The on-screen display will not appear about one minute after the power is turned on.
- The on-screen display will disappear in the following case:
 - if no operation is done for about 10 minutes.
 - if you do any operation other than explained in this section.
- To control the MD recorder using the TEXT COMPU LINK remote control system, you have to change the source name shown on the display from "TAPE" to "MD." (See page 18.)
- The number of characters to show the disc information such as the disc title or track title is limited to 32. So if the disc title, for example, is longer than 32 characters, only the first 32 characters are shown.
- Some special characters such as accented letters cannot be displayed correctly.

Note on ⑦

The following information will appear on the display:

- Disc title
- Performer
- Genre
- Song writer
- Composer
- Arranger
- Message

Only recorded information will be shown. If there is no data, "NO DATA" will appear.

Note on ⑨

For example, the SET button will be used to start play (PLAY), to go to the next screen (ENTER), and to determine the selection (ENTER).

■ Searching a Disc (Only for the CD player)

Search a disc by its performer:

1. Display the disc information screen by following the procedure on page 52.
2. Press ON SCREEN CONTROL Δ / ∇ to move \square to "SEARCH," then press SET.
The DISC SEARCH screen appears on the TV.
3. Press ON SCREEN CONTROL Δ / ∇ to move \square to "PERFORMER," then press SET.
The PERFORMER SEARCH screen appears.
4. Press ON SCREEN CONTROL $\Delta / \nabla / \triangleleft / \triangleright$ to move \square in front of the first character of the performer you want to search, then press SET.
To correct the incorrect entry, press ON SCREEN CONTROL Δ / ∇ to move \square in front of the correct character, then press SET.
To erase the incorrect entry, press ON SCREEN CONTROL Δ / ∇ to move \square to CANCEL, then press SET.

5. Press SET again.
Disc search starts, then the SEARCH RESULT screen, showing the performers, appears.
6. On the SEARCH RESULT screen, you can do the following:
 - Changing the indication of the disc information: Press ON SCREEN CONTROL Δ / ∇ to move \square to a searched disc, then press $\triangleleft / \triangleright$. Each time you press $\triangleleft / \triangleright$, the disc information alternates between its performer and its disc title.
 - Going to the Disc Information screen (see page 52): Press ON SCREEN CONTROL Δ / ∇ to move \square to a searched disc, then press SET.
 - Showing unseen disc information (if more than 5 discs are listed as a result of the search): Press ON SCREEN CONTROL Δ / ∇ to move \square to \blacksquare (or \blacktriangleright), then press SET.
 - Going back to the PERFORMER SEARCH screen: Press EXIT.

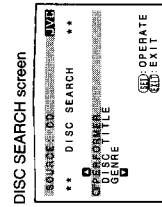

DISC SEARCH screen

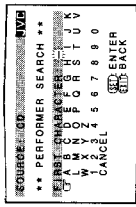

PERFORMER SEARCH screen



SEARCH RESULT screen

Note
Symbols such as \oplus , # or \$ cannot be available for search.

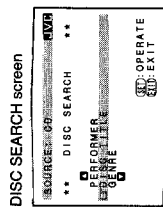

DISC SEARCH screen

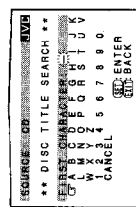

DISC TITLE SEARCH screen

5. Press SET again.
Disc search starts, then the SEARCH RESULT screen, showing the disc titles, appears.
6. On the SEARCH RESULT screen, you can do the following:
 - Changing the indication of the disc information: Press ON SCREEN CONTROL Δ / ∇ to move \square to a searched disc, then press $\triangleleft / \triangleright$. Each time you press $\triangleleft / \triangleright$, the disc information alternates between its disc title and its performer.
 - Going to the Disc Information screen (see page 52): Press ON SCREEN CONTROL Δ / ∇ to move \square to a searched disc, then press SET.
 - Showing unseen disc information (if more than 5 discs are listed as a result of the search): Press ON SCREEN CONTROL Δ / ∇ to move \square to \blacksquare (or \blacktriangleright), then press SET.
 - Going back to the DISC SEARCH screen: Press EXIT.

Search a disc by its disc title:

1. Display the disc information screen by following the procedure on page 52.
2. Press ON SCREEN CONTROL Δ / ∇ to move \square to "SEARCH," then press SET.
The DISC SEARCH screen appears on the TV.
3. Press ON SCREEN CONTROL Δ / ∇ to move \square to "DISC TITLE," then press SET.
The DISC TITLE SEARCH screen appears.
4. Press ON SCREEN CONTROL $\Delta / \nabla / \triangleleft / \triangleright$ to move \square in front of the first character of the disc title you want to search, then press SET.
To correct the incorrect entry, press ON SCREEN CONTROL Δ / ∇ to move \square in front of the correct character, then press SET.
To erase the incorrect entry, press ON SCREEN CONTROL Δ / ∇ to move \square to CANCEL, then press SET.

5. Press SET again.
Disc search starts, then the SEARCH RESULT screen, showing the disc titles, appears.
6. On the SEARCH RESULT screen, you can do the following:
 - Changing the indication of the disc information: Press ON SCREEN CONTROL Δ / ∇ to move \square to a searched disc, then press $\triangleleft / \triangleright$. Each time you press $\triangleleft / \triangleright$, the disc information alternates between its disc title and its performer.
 - Going to the Disc Information screen (see page 52): Press ON SCREEN CONTROL Δ / ∇ to move \square to a searched disc, then press SET.
 - Showing unseen disc information (if more than 5 discs are listed as a result of the search): Press ON SCREEN CONTROL Δ / ∇ to move \square to \blacksquare (or \blacktriangleright), then press SET.
 - Going back to the DISC TITLE SEARCH screen: Press EXIT.

Note
Symbols such as \oplus , # or \$ cannot be available for search.

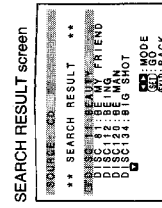

SEARCH RESULT screen

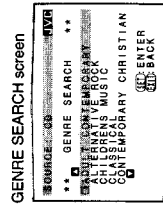

GENRE SEARCH screen



SEARCH RESULT screen

Using the User File (Only for the CD Player with the User File Function)

You can use the User File function through this receiver. For the User File function, refer to the manual supplied with your CD player.

Using your own User Files:

- Display the disc information screen by following the procedure on page 52.
- Press ON SCREEN CONTROL Δ / ∇ to move □ to "USER FILE," then press SET. The USER FILE screen appears on the TV. To show the unseen user files, press ON SCREEN CONTROL Δ / ∇ until they appear.
- Press ON SCREEN CONTROL Δ / ∇ to move □ to the User File you want, then press SET. The selected User File screen appears on the TV. The disc information shown will be the disc title. (If no disc title information is recorded for the discs, only the disc numbers will be shown.)

On this selected User File screen, you can do the following:

- Changing the indication of the disc information:** Press ON SCREEN CONTROL Δ / ∇ to move □ to a disc, then press < / >. Each time you press < / >, the disc information alternates between its disc title and its performer.
- Starting a disc play:** Press ON SCREEN CONTROL Δ / ∇ to move □ to a disc, then press SET.
- Showing unseen disc information** (if more than 5 discs are listed): Press ON SCREEN CONTROL Δ / ∇ to move □ to □ (or ◻) and press SET.
- Going back to the USER FILE screen:** Press EXIT.

User File screen

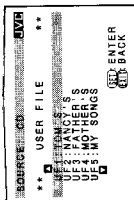

User File 1 screen

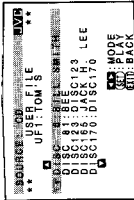

Entering the Disc Information

For the CD Player with the disc memory function:

You can use the disc memory function through this receiver. The disc information (its performer, disc title, and its music genre) of normal audio CDs will be stored into the memory built in the CD player.

- For the disc memory function, refer to the manual supplied with your CD player. The performer, disc title, and music genre information are usually recorded in a CD Text. However, if a CD Text has no genre information recorded in the disc itself, you can input its music genre by yourself.

Note: You can enter the TITLE INPUT screens for a CD Text and input its titles. However, you cannot store the titles you have input for a CD Text.

Example: Entering the following information for Disc 1

Performer: "MICHEAL"
Disc title: "MY FAVORITE"

- Display the disc information screen by following the procedure on page 52.
- Press ON SCREEN CONTROL Δ / ∇ to move □ to "TITLE INPUT," then press SET. The TITLE INPUT: PERFORMER screen appears on the TV.
- Press ON SCREEN CONTROL Δ / ∇ / < / > to move □ in front of a character you want, then press SET to enter the character.
 - If the current CD is a CD Text, go to step 5 without entering the performer.

To use the lower case letters, press ON SCREEN CONTROL Δ / ∇ / < / > to move □ to SHIFT, then press SET.

To use the upper case letters again, press ON SCREEN CONTROL Δ / ∇ / < / > to move □ to SHIFT, then press SET.

4. Repeat step 3 until you finish putting a name (up to 32 characters) to this User File.

To insert a space, press ON SCREEN CONTROL Δ / ∇ / < / > to move □ to SPACE, then press SET.

To correct an incorrect character:

- Press ON SCREEN CONTROL Δ / ∇ / < / > to move □ to ◻ or ◻, then press SET until the incorrect character is selected.
- Press ON SCREEN CONTROL Δ / ∇ / < / > to move □ to CANCEL, then press SET to erase the character.
- Press ON SCREEN CONTROL Δ / ∇ / < / > to move □ in front of an correct character, then press SET to enter a correct character.

5. Press ON SCREEN CONTROL Δ / ∇ / < / > to move □ to "DISC1:

MICHEAL (in this example)," then press SET. The TITLE INPUT: DISC TITLE screen appears.

6. Enter the disc title, referring to steps 3 and 4.

- If the current CD is a CD Text, go to the next step without entering the disc title.

Continued to the next page.

TITLE INPUT: PERFORMER screen

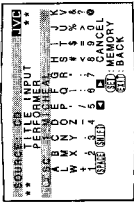
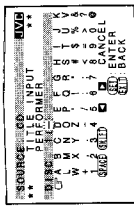

TITLE INPUT: DISC TITLE screen

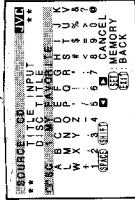
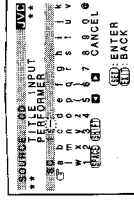
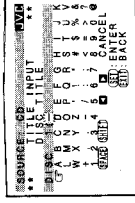

TEXT COMPU LINK Remote Control System

- Press ON SCREEN CONTROL Δ / ∇ / \leftarrow / \rightarrow to move \square to "DISC1: MY FAVORITE (in this example)," then press SET.
The TITLE INPUT: DISC 1 GENRE screen appears.
- Press ON SCREEN CONTROL Δ / ∇ to move \square to the genre you want, then press SET.
The Disc Information screen appears again.
To show the unseen genres, press ON SCREEN CONTROL Δ / ∇ until they appear.

For the MD recorder:

You can write the disc information (disc title and song titles) into the disc. You can only write the song title for the song currently selected.

- If you have the CD-MD combination deck, you can also enter the disc information (its performer, disc title, and its music genre) of normal audio CDs into the memory built in the CD-MD combination deck. (To do this, follow the procedure on page 56.)

- Display the disc information screen by following the procedure on page 52.
- Press ON SCREEN CONTROL Δ / ∇ to move \square to "TITLE INPUT," then press SET.
The DISC TITLE INPUT screen appears on the TV.
- Enter the disc title, referring to steps 3 and 4 on page 56.
 - You can enter up to 32 character for the disc title.
- Press ON SCREEN CONTROL Δ / ∇ / \leftarrow / \rightarrow to move \square to the disc title you have just entered, then press SET.
The disc title is stored into the memory, and the SONG TITLE INPUT screen for the currently selected song appears.
 - You can enter a song title for the song currently selected (indicated in yellow on the TV screen).
- Enter the song title, referring to steps 3 and 4 on page 56.
 - You can enter up to 32 character for the song title.
- Press ON SCREEN CONTROL Δ / ∇ / \leftarrow / \rightarrow to move \square to the song title you have just entered, then press SET.
The song title is stored into the memory, and the Disc Information screen appears again.

TITLE INPUT: DISC 1 GENRE screen

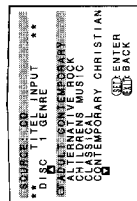

Disc Information screen



DISC TITLE INPUT screen

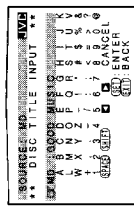
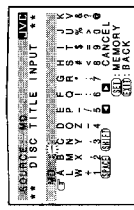

Operating JVC's Audio/Video Components

You can operate JVC's audio and video components with this receiver's remote control, since control signals for JVC components are preset in the remote control.

IMPORTANT:

To operate JVC's audio components using this remote control:

- You need to connect JVC audio components through the COMPU LINK-3 (SYNCHRO) jacks (see page 50) in addition to the connections using cables with RCA pin plugs (see page 9) or using digital cables (see page 12).
- Aim the remote control directly at the remote sensor on the receiver.

Tuner

After pressing FM/AM (with the remote control mode selector set to "AUDIO/TV/VCR"), you can perform the following operations:

- FM/AM:**
 Alternates between FM and AM.
 Selects a preset channel number directly.
 For channel number 5, press 5. For channel number 15, press +10, then 5.
 For channel number 20, press +10, then 10.

TUNING UP/TUNING DOWN:

Tunes into stations.

FM MODE/MUTE: Changes the FM reception mode.

Sound control section (Amplifier)

You can always perform the following operations (with the remote control mode selector set to "AUDIO/TV/VCR");

SURROUND MODE: Changes the DSP modes.

After pressing SOUND CONTROL (with the remote control mode selector set to "AUDIO/TV/VCR"), you can perform the following operations:

- SEA MODE:**
Changes the SEA modes.
- SUBWOOFER +/-:**
Adjusts the subwoofer output level.
- CNTR +/-:**
Adjusts the center speaker output level.
- REAR-L +/-:**
Adjusts the left rear speaker output level.
- REAR-R +/-:**
Adjusts the right rear speaker output level.
- EFFECT:**
Selects the effect level.
- TEST:**
Turns on or off the test tone output.
- CNTR TONE:**
Selects the center tone.

CD player

After pressing CD (with the remote control mode selector set to "AUDIO/TV/VCR"), you can perform the following operations on a CD player:

- PLAY:**
Starts playing.
- ◀▶:**
Returns to the beginning of the current (or previous) track.
- ▶▶:**
Skips to the beginning of the next track.
- STOP:**
Stops playing.
- PAUSE:**
Pauses playing. To release it, press PLAY.
- 1 - 10, +10:**
Selects a track number directly.
For track number 5, press 5. For track number 15, press +10, then 5. For track number 20, press +10, then 10. For track number 30, press +10, then 10.

Notes:

- If you use the buttons on the front panel or the menu function to choose a source, the remote control will not operate that source. To operate a source with the remote control, the source must be selected using buttons on the remote control.
- Check to see if its remote control mode selector is set to the correct position. To operate audio system, TVs, and VCRs, set it to "AUDIO/TV/VCR."
- Refer also to the manuals supplied with your components.

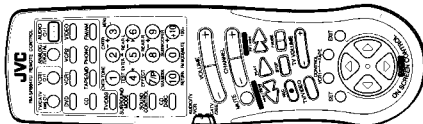

Note:

- After adjusting sounds, press the corresponding source selecting button or CD DISC to operate your target source by using 10 keys; otherwise, 10 keys cannot be used for operating your target source.

Operating JVC's Audio/Video Components

CD player-changer

After pressing CD DISC (with the remote control mode selector set to "AUDIO/TV/VCR"), you can perform the following operations on the CD player-changer:

- PLAY:** Starts playing.
- ◀◀:** Returns to the beginning of the current (or previous) track.
- ▶▶:** Skips to the beginning of the next track.
- STOP:** Stops playing.
- PAUSE:** Pauses playing. To release it, press the PLAY button.
- 1-6, 7/P:** Select the number of a disc installed in a CD player-changer.

After pressing CD (with the remote control mode selector set to "AUDIO/TV/VCR"), you can perform the following operations on the CD player-changer:

- 1-10, +10:** Selects a track number directly.
For track number 5, press 5. For track number 15, press +10, then 5. For track number 20, press +10, then 10. For track number 30, press +10, +10, then 10.

Turntable

After pressing PHONO (with the remote control mode selector set to "AUDIO/TV/VCR"), you can perform the following operations on the turntable:

- PLAY:** Starts playing.
- STOP:** Stops playing.

Cassette deck

After pressing TAPE/MD or TAPE CONTROL (with the remote control mode selector set to "AUDIO/TV/VCR"), you can perform the following operations on the cassette deck:

- PLAY:** Starts playing.
- REW:** Fast winds the tape from right to left.
- FF:** Fast winds the tape from left to right.
- STOP:** Stops operations.
- PAUSE:** Pauses playing or recording temporarily. To release it, press the PLAY button.
- REC ●:** Press this button with the PLAY button to start recording. Press this button with the PAUSE button to enter recording pause.

MD recorder

After pressing TAPE/MD or TAPE CONTROL (with the remote control mode selector set to "AUDIO/TV/VCR" position), you can perform the following operations on the MD recorder:

- PLAY:** Starts playing.
- ◀◀:** Returns to the beginning of the current (or previous) track.
- ▶▶:** Skips to the beginning of the next track.
- STOP:** Stops playing.
- PAUSE:** Pauses playing. To release it, press the PLAY button.
- REC ●:** Press this button with the PLAY button to start recording. Press this button with the PAUSE button to enter recording pause.

IMPORTANT:

To operate JVC's video components using this remote control:

- Aim the remote control directly at the remote sensor on the VCR, DVD player or TV, not on the receiver.

VCR1 (the VCR connected to the VCR1 jacks)

You can always perform the following operations (with the remote control mode selector set to "AUDIO/TV/VCR");

VCR1 ◀/▶: Turns on or off the VCR1.

After pressing VCR1 or VCR1 CONTROL (with the remote control mode selector set to "AUDIO/TV/VCR"), you can perform the following operations on the VCR:

- PLAY:** Starts playing.
- REW:** Rewinds a tape.
- FF:** Fast winds a tape.
- STOP:** Stops operations.
- PAUSE:** Pauses playing or recording temporarily. To release it, press the PLAY button.
- REC ●:** Press this button with the PLAY button to start recording.

Press this button with the PAUSE button to enter recording pause.

CHANNEL +/-: Changes the channels on the VCR.

1-9, 0: Selects the channels on the VCR.
For channel 5, press 5.
For channel 10, press 1, then 0.

DVD player

After pressing DVD (with the remote control mode selector set to "AUDIO/TV/VCR"), you can perform the following operations on a DVD player:

- PLAY:** Starts playing.
- ◀◀:** Returns to the beginning of the current (or previous) track.
- ▶▶:** Skips to the beginning of the next track.
- STOP:** Stops playing.
- PAUSE:** Stops playing temporarily. To release it, press the PLAY button.

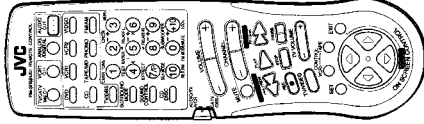

Notes:

- Some JVC VCRs can accept two types of the control signals - code "A" and "B." Before using this remote control, make sure that the remote control code of the VCR1 is set to code "A."
- You can use either the VCR1 button or the VCR1 CONTROL button to activate the buttons listed to the left. If you press VCR1, the playing source also changes. On the other hand, if you press VCR1 CONTROL, the playing source does not change.

After pressing DVD (with the remote control mode selector set to the "AUDIO/TV/VCR" position), these buttons can be used for the DVD menu operations.



Note:

For detailed menu operations, refer to the instructions supplied with the discs or the DVD player.

Operating JVC's Audio/Video Components

TV

You can always perform the following operations (with the remote control mode selector set to "AUDIO/TV/VCR"):

- TV/CATV/DBS** $\odot/1$: Turns on or off the TV.
- TV VOLUME +/-**: Adjusts the volume.
- TV/VIDEO**: Sets the input mode (either TV or VIDEO).

After pressing TV/DBS (with the remote control mode selector set to "AUDIO/TV/VCR"), you can perform the following operations on a TV:

- CHANNEL +/-**: Changes the channels.
- 1 - 9, 100+**: Selects the channels.
- RETURN**: Alternates between the previously selected channel and the current channel.

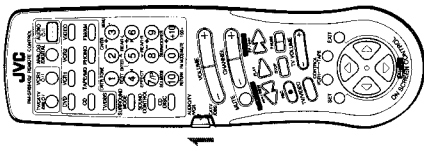

Operating Other Manufacturers' Components

This remote control supplied with the receiver can transmit control signals for other manufacturers' VCRs, TVs, CATV converters and DBS tuners. By changing the transmittable signals from preset ones to the other manufacturers', you can operate the other manufacturer's components using this remote control.

When operating the other manufacturers' components, refer also to the manuals supplied with them.

To operate these components with the remote control, first you need to set the manufacturer's code each for the VCR, TV, CATV converter, and DBS tuner.

IMPORTANT:

When using the Remote Control, check to see if its remote control mode selector is set to the correct position:

To operate an audio system, TV, and VCR, set it to "AUDIO/TV/VCR."

To operate a CATV converter and DBS tuner, set it to "CATV/DBS."



To change the transmittable signals for operating another manufacturer's TV

1. Set the remote control mode selector to "AUDIO/TV/VCR."
2. Press and hold TV/CATV/DBS $\odot/1$.
3. Press TV/DBS.
4. Enter the manufacturer's code (three digits) using buttons 1 - 9, and 0.
See the lists on page 65 to find the code.
5. Release TV/CATV/DBS $\odot/1$.
The following buttons can be used for operating the TV (with the remote control mode selector set to "AUDIO/TV/VCR"):
TV/CATV/DBS $\odot/1$: Turns on and off TV.
TV VOLUME +/-: Adjusts the volume.
TV/VIDEO: Sets the input mode (either TV or VIDEO).

After pressing TV/DBS (with the remote control mode selector set to "AUDIO/TV/VCR"), you can perform the following operations on the TV:

- CHANNEL +/-**: Changes the channels.
- 1 - 10, 0, 100+(+10)**: Selects the TV channels.
- 100+(+10)** button will function as the ENTER button if your TV requires pressing ENTER after selecting a channel number.

6. Try to operate your TV by pressing TV/CATV/DBS $\odot/1$.
When your TV turns on or off, you have entered the correct code.

7. If there are more than one code listed for your brand of TV, try each one until the correct one is entered.

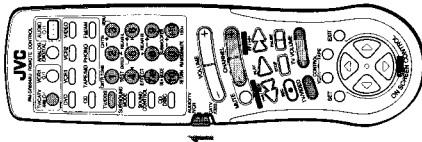

Note:
Refer also to the manual supplied with your TV.

Operating Other Manufactures' Components

To change the transmittable signals for operating a CATV converter or DBS tuner

1. Set the remote control mode selector to "CATV/DBS."
2. Press and hold TV/CATV/DBS \odot /I.
3. Press TV/DBS.
4. Enter the manufacturer's code (three digits) using buttons 1 - 9, and 0.
See the lists on page 65 to find the code.
5. Release TV/CATV/DBS \odot /I.
After setting the remote control mode selector to "CATV/DBS," you can perform the following operations on the CATV converter or on the DBS tuner:
TV/CATV/DBS \odot /I: Turns on and off the CATV converter or DBS tuner.
Changes the channels.
CHANNEL +/-: Changes the channels.
100+ (+10) button will function as the ENTER button if your CATV converter or DBS tuner requires pressing ENTER after selecting a channel number.

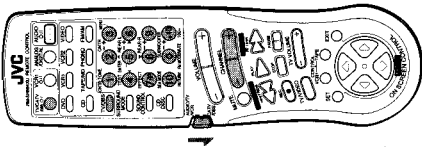

Note:
Refer also to the manual supplied with your CATV converter or DBS tuner.

To change the transmittable signals for operating another manufacturer's VCR

1. Set the remote control mode selector to "AUDIO/TV/VCR."
2. Press and hold VCR1 \odot /I.
3. Press VCR1.
4. Enter the manufacturer's code (three digits) using buttons 1 - 9, and 0.
See the lists on page 65 to find the code.
5. Release VCR1 \odot /I.
The following buttons can be used for operating the VCR (with the remote control mode selector set to "AUDIO/TV/VCR"):
VCR1 \odot /I: Turns on and off VCR.
After pressing VCR1 or VCR1 CONTROL (with the remote control mode selector set to "AUDIO/TV/VCR"), you can perform the following operations on the VCR:
CHANNEL +/-: Changes the channels on the VCR.
1 - 10, 0, 100+ (+10): Selects the channels on the VCR. 100+ (+10) button will function as the ENTER button if your VCR requires pressing ENTER after selecting a channel number.

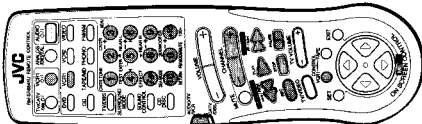

Notes:
• You can use either the VCR1 button or the VCR1 CONTROL button to activate the buttons listed to the left. If you press VCR1, the playing source also changes. On the other hand, if you press VCR1 CONTROL, the playing source does not change.
• Refer also to the manual supplied with your VCR.

6. Try to operate your CATV converter or DBS tuner by pressing TV/CATV/DBS \odot /I.
When your CATV converter or DBS tuner turns on or off, you have entered the correct code.

7. If there are more than one code listed for your brand of CATV converter or DBS tuner, try each one until the correct one is entered.

6. Try to operate your VCR by pressing VCR1 \odot /I.
When your VCR turns on or off, you have entered the correct code.

7. If there are more than one code listed for your brand of VCR, try each one until the correct one is entered.

- PLAY:** Starts playback.
STOP: Stops operations.
PAUSE: Pauses.
REW: Rewinds a tape.
FF: Fast winds a tape.
REC \bullet : Starts recording or enters recording pause.

Manufacturers' codes for TV

Anam	003, 004, 009, 068, 161, 425, 426
Anam National	161, 250, 425
Blaupunkt	554
Daewoo	066, 092, 154, 391, 402, 451
ECE	037
Eltron	009, 283
Fortress	093
Funai	264, 342
General	186
GoldStar	002, 037, 039, 178, 283, 457, 467
Grundig	535
Hitachi	145
JVC	036, 053, 069, 094, 160
Marantz	054
Matsushita	250
Mitsubishi	150, 241
National	226
NEC	030, 170
Nicamagic	216
Panasonic	161, 250
Philips	037
Pioneer	166
Samsung	060, 090, 427
Sanyo	208, 376, 424
Sharp	093, 256
Sony	000
Telefunken	252
Thomson	560
Toshiba	156, 502
Victor	038, 053, 160, 250, 376

Manufacturers' codes for CATV converters

DaenYung	008
GoldStar	838
LG Alps	779
Now	776
Samsung	702
Seawoo	780
Tongkook	777, 840
Zenith	000

Manufacturers' codes for DBS tuner

Dae Young	735
DX Antenna	752
Marantz	200
Panasonic	739
Pantech	747
Samsung	773
Sony	661
Toshiba	486

Manufacturers' codes for VCR

Akai	281, 288
Anam	037, 162, 226, 240, 278
Anam National	162, 226
Blaupunkt	226
Daewoo	020, 046, 278, 388, 552
Funai	000
General	052
GoldStar	037, 225, 471
Grundig	195
Hitachi	042, 166, 235
JVC	008, 041, 067, 384
Marantz	081
Matsushita	227
Mitsubishi	043, 061, 196
National	226
NEC	038, 040, 370
Panasonic	162, 226, 227, 367
Philips	062, 081
Pioneer	058
Samsung	240, 426, 432
Sanyo	046, 104, 368, 369
Sharp	048, 062, 363
Shinrom	072
Sony	032, 033, 034
Telefunken	187
Thomson	320
Toshiba	045, 366
Victor	008, 041, 067, 384

Manufacturers' codes listed on this page are subject to change without notice. If they are changed, this remote control cannot operate the equipment.

Troubleshooting

Use this chart to help you solve daily operational problems. If there is any problem you cannot solve, contact your JVC service center.

PROBLEM	POSSIBLE CAUSE	SOLUTION
The display does not light up.	The power cord is not plugged in or the ⊖ POWER switch pressed to set it in the ■ OFF position.	Plug the power cord into an AC outlet and/or press ⊖ POWER to set it in the ■ ON position.
No sound from speakers.	Speaker signal cables are not connected.	Check speaker wiring and reconnect if necessary.
	The SPEAKERS 1 and 2 buttons are not set correctly.	Press SPEAKERS 1 and 2 correctly.
	An incorrect source is selected.	Select the correct source.
	Muting is activated.	Press MUTE to cancel the mute.
Sound from one speaker only.	Speaker signal cables are not connected properly.	Check speaker wiring and reconnect if necessary.
	The balance is set to one extreme.	Adjust the balance property (see page 19).
Continuous hiss or buzzing during FM reception.	Incoming signal is too weak.	Connect an outside FM antenna or contact your dealer.
	The station is too far away.	Select a new station.
	An incorrect antenna is used.	Check with your dealer to be sure you have the correct antenna.
	Antennas are not connected properly.	Check connections.
Occasional crackling noise during FM reception.	Ignition noise from automobiles.	Move the antenna further from automobile traffic.
	The color system of the connected TV is not PAL.	Connect a PAL TV.
Howling during record playing.	Your turntable is too close to speakers.	Move speakers away from the turntable.
"OVERLOAD" starts flashing on the display.	Speakers are overloaded because of high volume.	Rotate the MASTER VOLUME control counterclockwise three or four times, then press STANDBY/ ON ⊖/⊕ on the front panel. If "OVERLOAD" does not disappear, unplug the AC power cord, then plug it back again.
	Speakers are overloaded because of short circuit of speaker terminals.	Press STANDBY/ON ⊖/⊕ on the front panel, then check the speaker wiring. If "OVERLOAD" does not disappear, unplug the AC power cord, then plug it back again. If speaker wiring is not short- circuited, contact your dealer.
Remote control does not work.	The remote control mode selector is not set correctly.	Set the selector correctly either to "AUDIO/VCR" or to "CATV/ DBS."
	There is an obstruction in front of the remote sensor on the receiver.	Remove the obstruction.
	Batteries are weak.	Replace batteries.

Specifications

English

Amplifier

Output Power At Stereo operation
Front channels 100 watts per channel, min. RMS, driven into 4 ohms at 1 kHz, with no more than 0.7 % total harmonic distortion. (IEC268-3/DIN)

At Surround operation
Front channels 50 watts per channel, min. RMS, driven into 8 ohms at 1 kHz, with no more than 0.7 % total harmonic distortion. (IEC268-3/DIN)

At Surround operation

Front channels 70 watts per channel, min. RMS, driven into 4 ohms at 1 kHz, with no more than 0.8 % total harmonic distortion.

Center channel 70 watts, min. RMS, driven into 4 ohms at 1 kHz, with no more than 0.8 % total harmonic distortion.

Rear channels 70 watts per channel, min. RMS, driven into 4 ohms at 1 kHz, with no more than 0.8 % total harmonic distortion.

Total Harmonic Distortion (8 ohms, 1 kHz) 0.02 %* at 50 watts output
(* Measured by JVC Audio Analysis System)

Audio Input Sensitivity/Impedance (1 kHz) PHONO (MM) 2.5 mV/47 k ohms
CD, TAPE/MD, TV SOUND/DBS, VCR1, VCR2, VIDEO, DVD

Audio Input (DIGITAL IN) Coaxial: DIGITAL 1 (DBS) 0.5 Vp-p/75 ohms
Optical: DIGITAL 2 (DVD), DIGITAL 3 (CD) -21 dBm to -15 dBm (660 nm ±30 nm)

Audio Output Level TAPE/MD, VCR1, VCR2 200 mV

Signal-to-Noise Ratio (66 IHF/DIN) PHONO 70 dB/66 dB
CD, TAPE/MD, TV SOUND/DBS, VCR1, VCR2, VIDEO, DVD 87 dB/67 dB

Frequency Response (8 ohms) PHONO 20 Hz to 20 kHz (±1 dB)
CD, TAPE/MD, TV SOUND/DBS, VCR1, VCR2, VIDEO, DVD 20 Hz to 20 kHz (±1 dB)

RIAA Phono Equalization ±0.5 dB (20 Hz to 20 kHz)

Loudness Control (Volume Control at -30 dB) +6 ±1 dB at 100 Hz
+4 ±1 dB at 10 kHz

S.E.A. Center Frequencies 100 Hz, 1 kHz, 10 kHz
Control Range ±10 dB ±2 dB

Video

Video Input Sensitivity/Impedance Composite video: TV SOUND/DBS, VCR1, VCR2, VIDEO, DVD 1 Vp-p/75 ohms
S-video: TV SOUND/DBS, VCR1, VIDEO, DVD (Y: luminance) 1 Vp-p/75 ohms
(C: chrominance, burst) 0.286 Vp-p/75 ohms

Video Output Level Composite video: VCR1, VCR2, MONITOR OUT ... 1 Vp-p/75 ohms
S-video: VCR1, MONITOR OUT 1 Vp-p/75 ohms
(Y: luminance) 1 Vp-p/75 ohms
(C: chrominance, burst) 0.286 Vp-p/75 ohms

Synchronization Negative

Signal-to-Noise Ratio 45 dB

On-Screen Color System PAL

FM tuner (IHF)

Tuning Range 87.5 MHz to 108.0 MHz

Usable Sensitivity Monaural 12.7 dBf (1.2 µV/75 ohms)
50 dB Quieting Sensitivity Monaural 16.3 dBf (1.8 µV/75 ohms)
Stereo 38.3 dBf (22.5 µV/75 ohms)

Signal-to-Noise Ratio (IHF-A weighted) Monaural 80 dB at 85 dBf
Stereo 73 dB at 85 dBf

Total Harmonic Distortion Monaural 0.15 % at 1 kHz
Stereo 0.2 % at 1 kHz

Stereo Separation at REC OUT 40 dB at 1 kHz

Capture Ratio 1.5 dB at 85 dBf

Alternate Channel Selectivity 60 dB; (±400 kHz)

Frequency Response 30 Hz to 15 kHz; (+0.5 dB, -3 dB)

AM tuner

Tuning Range 531 kHz to 1,602 kHz (at 9 kHz interval)
550 kHz to 1,600 kHz (at 10 kHz interval)

Usable Sensitivity Loop antenna 300 µV/m

Signal-to-Noise Ratio 50 dB (100 mV/m)

General

Power Requirements AC 110/127/220/230-240V^o, adjustable with the voltage selector, 50/60 Hz

Power Consumption 280 watts
2 watts (in standby mode)

Dimensions (W x H x D) 435 x 157 x 412.5 mm
(17 1/8 x 6 1/8 x 16 1/2 inches)

Mass 11.3 kg (25.0 lbs)

Designs & specifications are subject to change without notice.

English

Description of Major ICs

■ MN101C15FAF (IC401) : System Control Micon

1. Terminal Layout

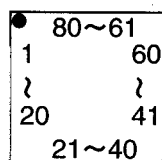

2. Pin Function

Pin No	Symbol	Functions	Pin No	Symbol	Functions
1	GND	Ground	41	VIDEO3	VIDEO 3 signal terminal
2	DVD-S/C	DVD S/C signal select terminal	42	VIDEO4	VIDEO 4 signal terminal
3	VCR1-S/C	VCR1 S/C signal select terminal	43	S.MUTE	Source mute control terminal
4	VIDEO-S/C	VIDEO S/C signal select terminal	44	—————	—————
5	TV-S/C	TV S/C select terminal	45	DSP-ACK	DSP control signal terminal
6	4/8-IN	4 ohm / 8 ohm select signal terminal	46	DSP-INT	DSP control signal terminal
7	—————	—————	47	RDS-STATUS	RDS control signal terminal
8	—————	—————	48	RDS-COMMON	RDS control signal terminal
9	PROTECT	Protect	49	INH-IN	Inhibit signal input terminal
10	GND	Ground	50	DSP-CS	DSP control signal terminal
11	VDD	Power supply	51	DSP-RESET	DSP reset signal terminal
12	OSC2	Oscillation terminal	52	M/CS	Control signal from IC400
13	OSC1	Oscillation terminal	53	M-RESET	Reset signal from IC400
14	Vss	Ground	54	STATUS	Status signal from IC400
15	XI	Ground	55	COMMAND	Command signal from IC400
16	XO	Ground	56	MCLK	Clock signal from IC400
17	GND	Ground	57	SEA-CLK	SEA clock signal from terminal
18	—————	Text signal input terminal	58	SEA-DATA	SEA data signal terminal
19	—————	Text signal output terminal	59	VL/VH	Connect to power supply board
20	—————	Master signal terminal	60	4/8 OUT	4 ohm / 8 ohm select signal terminal
21	DSP-COMMAND	DSP control signal terminal	61	SW-DADTA	Switch data signal terminal
22	DSP-STATUS	DSP control signal terminal	62	SW-CLK	Switch clock signal terminal
23	DSP-CK	DSP control signal terminal	63	VOL-STB	Volume strobo signal terminal
24	GND	Ground	64	VOL-DATA	Volume data signal terminal
25	RESET-IN	Reset signal input terminal	65	VOL-CLK	Volume clock signal terminal
26	TUNER-CE	Tuner chip enable	66	SW-STB	Switch strobo signal terminal
27	TUNER-CLK	Tuner clock signal terminal	67	OTO-LED	OTO LED signal terminal
28	TUNER-STATUS	Tuner control signal terminal	68	—————	Dolby LED (Digital)
29	TUNER-COMMAND	Tuner control signal terminal	69	FR-RELAY1	Relay 1 signal terminal
30	TUNER-MUTE	Tuner mute signal terminal	70	FR-RELAY2	Relay 2 signal terminal
31	TUNER-IN	Tuner signal input terminal	71	CNTR-RELAY	Center speaker relay terminal
32	STEREO-IN	Stereo signal input terminal	72	SUR-RELAY	Surround speaker relay terminal
33	RDS-ST	No use	73	HP-RELAY	Head Phone relay terminal
34	M-BUSY	Busy signal from IC400	74	DOLBY (PROLOGIC)	Dolby signal terminal
35	RDS-CLK	No use	75	C.TONE3	Center tone 3 signal terminal
36	OSD-DATA	OSD data signal input terminal	76	C.TONE2	Center tone 2 signal terminal
37	OSD-STB	OSD standby signal terminal	77	C.TONE1	Center tone 1 signal terminal
38	OSD-CLK	OSD clock signal terminal	78	LED-LCK	LED latch clock signal terminal
39	VIDEO1	VIDEO 1 signal terminal	79	LED-DATA	LED data signal terminal
40	VIDEO2	VIDEO 2 signal terminal	80	LED-CLK	LED clock signal terminal

■ MN172412JABZ (IC400) : FL Tube Drive Control Micon

1. Terminal Layout

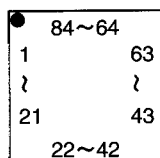

2. Pin Function

Pin No.	Symbol	Functions	Pin No.	Symbol	Functions
1	S22	Segment controlsignal output	43	JOG4	Connect to volume
2	S21	Segment controlsignal output	44	MBUSY	Busy signal to IC401
3	S20	Segment controlsignal output	45	MCLK	Clock signal to IC401
4	S19	Segment controlsignal output	46	COMMAND	Command signal to IC401
5	S18	Segment controlsignal output	47	STATUS	Status signal fot IC 401
6	S17	Segment controlsignal output	48	M/CS	Control signal to IC401
7	S16	Segment controlsignal output	49	RM	Remocon signal terminal
8	S15	Segment controlsignal output	50	VCRI	Compulink signal input
9	S14	Segment controlsignal output	51	DCSI	Compulink signal input
10	S13	Segment controlsignal output	52	DCSO	Compulink signal output
11	S12	Segment controlsignal output	53	VCRO	Compulink signal output
12	S11	Segment controlsignal output	54	TVO	Compulink output
13	S10	Segment controlsignal output	55	TVC	Compulink control output
14	S9	Segment controlsignal output	56	JOG5	Connect to multti jog
15	S8	Segment controlsignal output	57	JOG6	Connect to multti jog
16	S7	Segment controlsignal output	58	POWER	From power supply
17	S6	Segment controlsignal output	59	STANDBY	Standby signal terminal
18	S5	Segment controlsignal output	60	KI3	Key matrix input
19	S4	Segment controlsignal output	61	KI2	Key matrix input
20	S3	Segment controlsignal output	62	KI1	Key matrix input
21	S2	Segment controlsignal output	63	KI0	Key matrix input
22	S1	Segment controlsignal output	64	S36	Segment controlsignal output
23	VPP	Powe supply fot FL display	65	S35	Segment controlsignal output
24	G14	Grid controlsignal output	66	S34	Segment controlsignal output
25	G13	Grid controlsignal output	67	S33	Segment controlsignal output
26	G12	Grid controlsignal output	68	RST	Reset signal input
27	G11	Grid controlsignal output	69	X1	Connect to ground
28	G10	Grid controlsignal output	70	X2	No use
29	G9	Grid controlsignal output	71	VSS	Connect to ground
30	G8	Grid controlsignal output	72	OSC2	Oscillation terminal
31	G7	Grid controlsignal output	73	OSC1	Osillation terminal
32	G6	Grid controlsignal output	74	VDD	Power supply
33	G5	Grid controlsignal output	75	S32	Segment controlsignal output
34	G4	Grid controlsignal output	76	S31	Segment controlsignal output
35	G3	Grid controlsignal output	77	S30	Segment controlsignal output
36	G2	Grid controlsignal output	78	S29	Segment controlsignal output
37	————	Connect to Q408	79	S28	Segment controlsignal output
38	————	Connect to Q407	80	S27	Segment controlsignal output
39	G1	Grid controlsignal output	81	S26	Segment controlsignal output
40	JOG1	Connect to source selector	82	S25	Segment controlsignal output
41	JOG2	Connect to source selector	83	S24	Segment controlsignal output
42	JOG3	Connect to volume	84	S23	Segment controlsignal output

■ LA1837(IC102): FM AM IF AMP&detector, FM MPX Decoder

1. Block Diagram

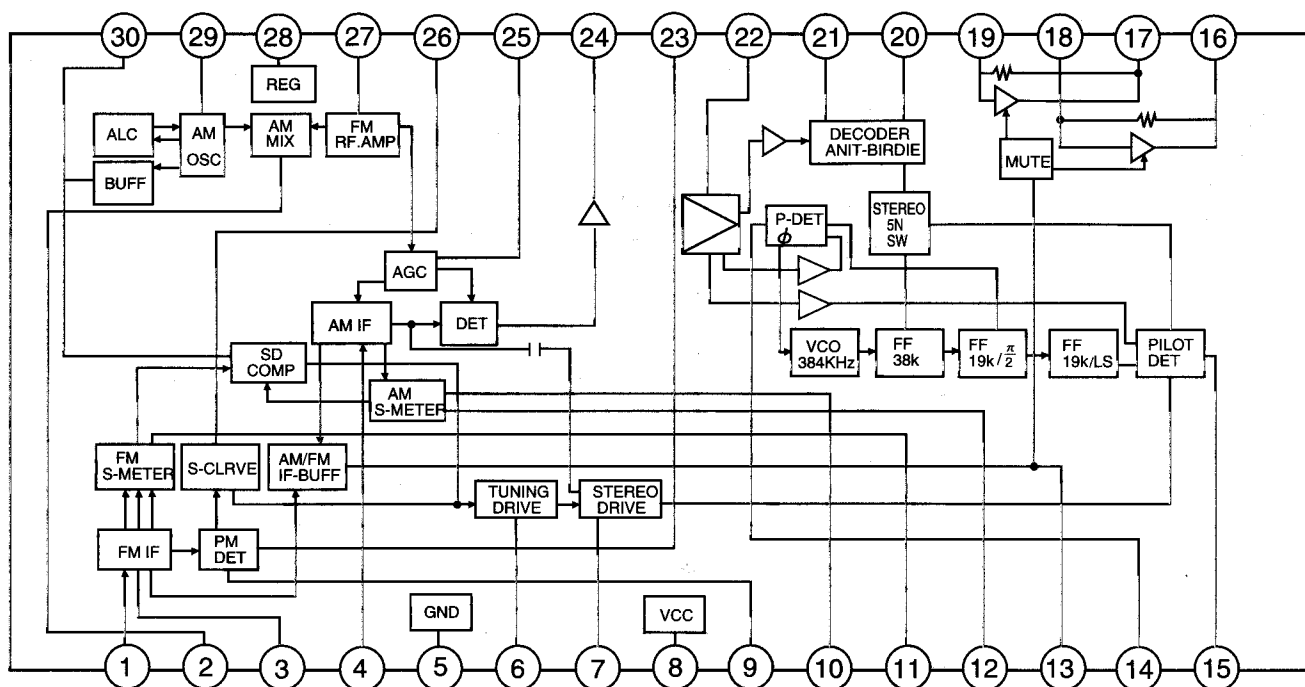

3. Pin Function

Pin No.	Symbol	I/O	Function	Pin No.	Symbol	I/O	Function
1	FM IN	I	This is an input terminal of FM IF signal.	16	L OUT	O	Left channel signal output.
2	AM MIX	O	This is an out put terminal for AM mixer.	17	R OUT	O	Right channel signal output.
3	FM IF	I	Bypass of FM IF	18	L IN	I	Input terminal of the Left channel post AMP.
4	AM IF	I	Input of AM IF Signal.	19	R IN	I	Input terminal of the Right channel post AMP.
5	GND	-	This is the device ground terminal.	20	RO	O	Mpx Right channel signal output.
6	TUNED	O	When the set is tuning,this terminal becomes "L".	21	LO	O	Mpx Left channel signal output.
7	STEREO	O	Stereo indicator output. Stereo "L", Mono: "H"	22	IF IN	I	Mpx input terminal
8	VCC	-	This is the power supply terminal.	23	FM OUT	O	FM detection output.
9	FM DET	-	FM detect transformer.	24	AM DET	O	AM detection output.
10	AM SD	-	This is a terminal of AM ceramic filter.	25	AM AGC	I	This is an AGC voltage input terminal for AM
11	FM VSM	O	Adjust FM SD sensitivity.	26	AFC	-	This is an output terminal of voltage for FM-AFC.
12	AM VSM	O	Adjust AM SD sensitivity.	27	AM RF	I	AM RF signal input.
13	MUTE	I/O	When the signal of IF REQ of IC121(LC72131) appear, the signal of FM/AM IF output. //Muting control input.	28	REG	O	Register value between pin 26 and pin28 desides the frequency width of the input signal.
14	FM/AM	I	Change over the FM/AM input. "H" :FM, "L" : AM	29	AM OSC	-	This is a terminal of AM Local oscillation circuit.
15	MONO/ST	O	Stereo : "H", Mono: "L"	30	OSC BUFFER	O	AM Local oscillation Signal output.

RX-884P/RX-884V

LC72131(IC121):PLL Synthesizer

1. Terminal Layout

XIN	1	22	XOUT
PLLCE	3	21	VSS
PLLDATA	4	20	LPF OUT
PLLCK	5	19	LPF IN
IFDATA	6	17	VDD
FM	7	16	FM OSC
MW	8	15	AM OSC
LW	9	14	
AUTO/MONO	10	13	IF REQ
POWER	11	12	FM/AM IF

2. Block Diagram

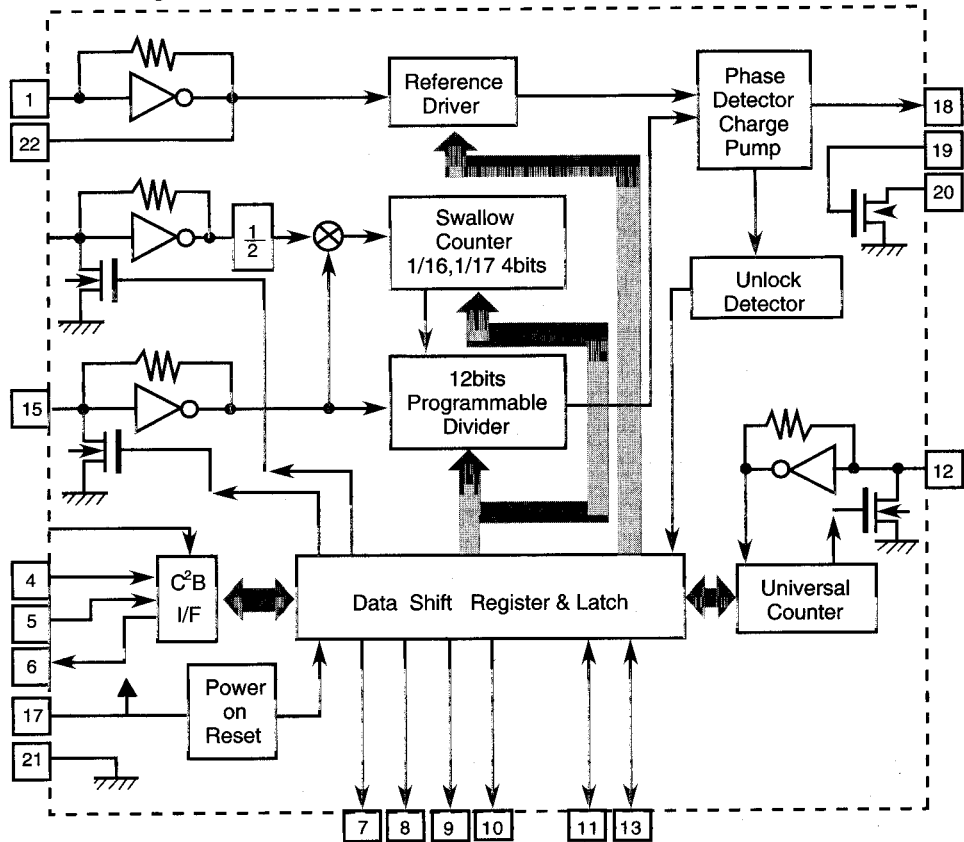

3. Pin Functions

Pin No.	Symbol	I/O	Functions	Pin No.	Symbol	I/O	Functions
1	Xin	I	Crystal oscillator (7.2MHz).	12	FM/AM IF	I	Universal counter input
2		--	Not use	13	IF REQ	O	Output the "IF-signal request" to IC102
3	PLLCE	I	Fix the chip enable to "H" when inputting (DI) and outputting (DO) the serial data	14		I	Not use
4	PLLDATA	I	Receive the control data from the controller (IC801).	15	AMOSC	I	Input the local oscillator signal of AM.
5	PLLCK	I	This clock is used to synchronize data when transmitting the data of DI and DO.	16	FM OSC	I	Input the local oscillator signal of FM.
6	IFDATA	O	Transmit the data from LC72131 to the controller which is synchronized with CK.	17	VDD	O	This is a terminal of power supply.
7	FM	O	It is "L" on FM mode.	18	PD	O	PLL charge pump output : When the local oscillator signal frequency is higher than the reference frequency high level signals will output. When it is lower than the reference frequency, low level signals will output. When it is same as reference frequency signals, it will be floating.
8	MW	O	It is "L" on MW mode.	19	LPF IN	I	Transistor used for the PLL active low-pass filter
9	LW	O	It is "L" on LW mode.	20	LPF OUT	O	Transistor used for the PLL active low-pass filter
10	AUTO/MONO	O	It is "L" on monaural, "L" on auto	21	VSS	--	Connected to GND
11	POWER	O	Regulator control signal P ON "H", STANDBY "L"	22	X out	O	Crystal oscillator(7.2MHz).

■ MB90089 (IC203) : ON Screen Display Controller

1. Terminal Layout

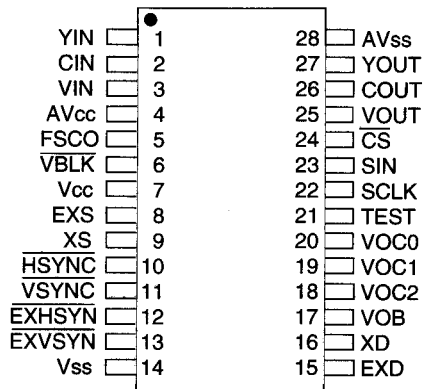

2. Block Diagram

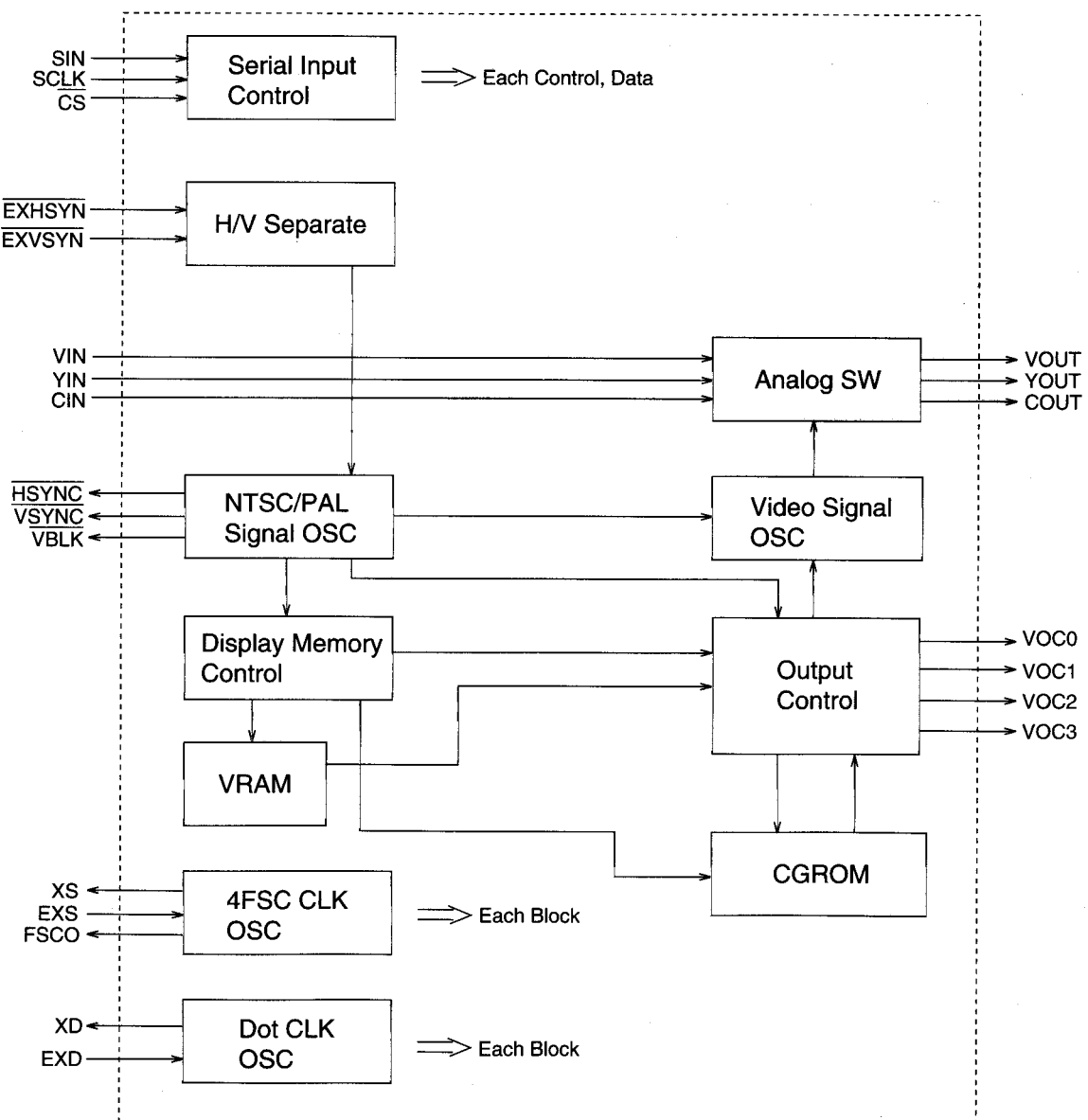

3.Functions

pin no	Symbol	I/O	Function
1	YIN	I	Lux signal Input terminal for Superinpause indocation
2	CIN	I	Contrast signal input terminal for Superinpause indication
3	VIN	I	Composit video signal input terminal for Superinpause indication
4	AVcc	-	Analog power supply terminal
5	FSCO	O	Internal collar barst phase indication signal
6	VBLK	O	Vertical blanking signal output terminal
7	Vcc	-	Power supply terminal
8	EXS	I	Clock generater outside circuit terminal for collar barst
9	XS	O	
10	HSYNC	O	Horizontal signal output terminal
11	VSYN	O	Vertical signal output terminal
12	EXHSYN	I	EXT horizontal signal input terminal
13	EXVSYN	I	EXT vertical signal input terminal
14	Vss	-	GND
15	EXD	I	Dot clock generater outside circuit signal terminal for indication
16	XD	O	
17	VOB	O	Character & background signal output terminal
18	VOC2	O	Collar signal output terminal
19	VOC1		
20	VOC0		
21	TEST	I	Test signal input terminal
22	SCLK	I	Shift clock input terminal for serial transmission
23	SIN	I	Serial data input terminal
24	CS	I	Tip select terminal
25	VOUT	O	Composit video signal output terminal
26	COUT	O	Contrast signal output terminal
27	YOUT	O	Lux signal output terminal
28	AVss	-	Anarog GND terminal

■ TC9162AN,TC9163AN, TC9164AN (IC321): Analog Switch

1.Function

Switch to On/Off of S1 to S8 by control of LSI.

2.Terminal Lay out & Block Diagram

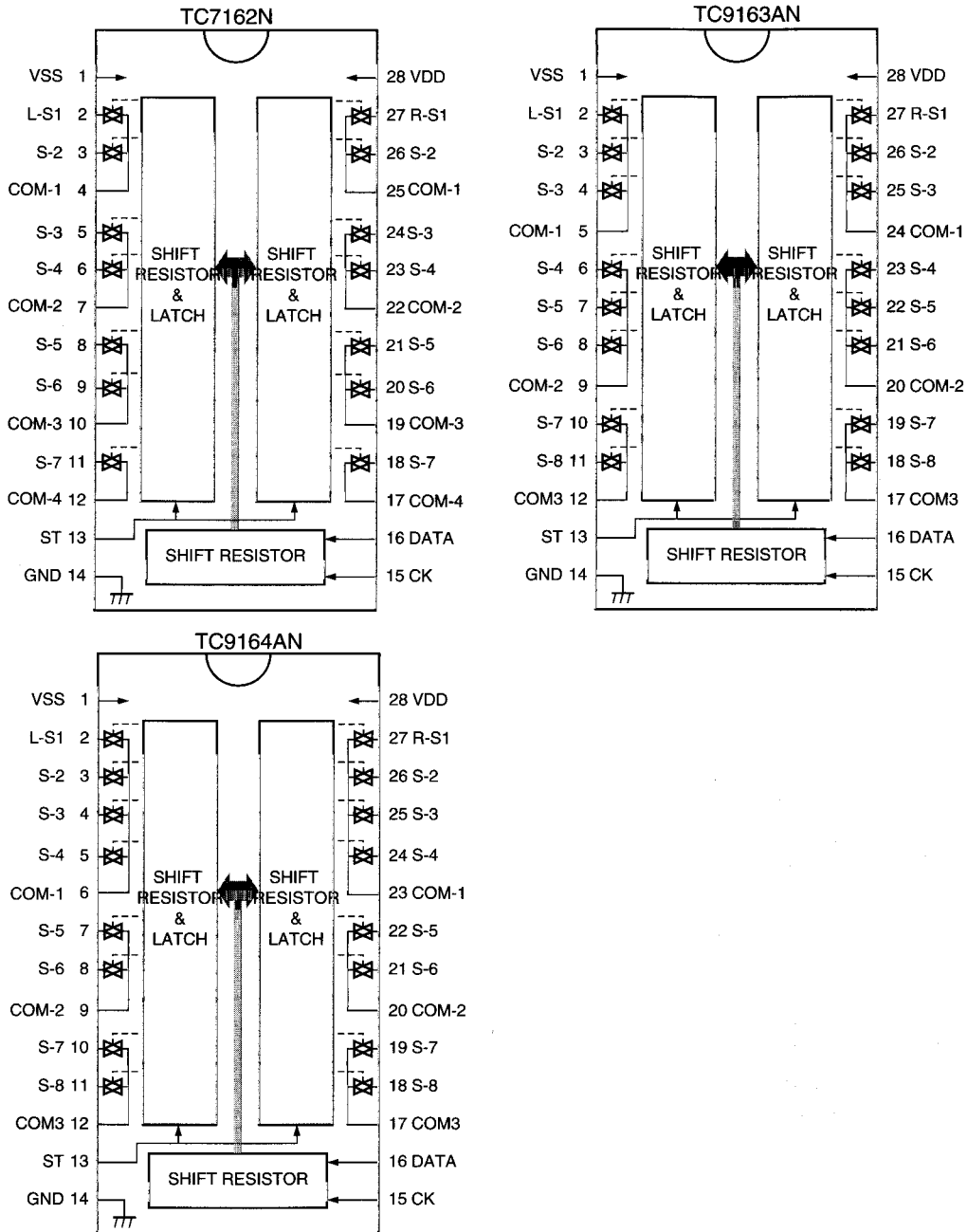

3.Corespondance of Switch & Data

S1~S8 are "1" position to ON by bit1~8 of Serial Data.

S9 is Right,S10 is Left Switch to ON/OFF. TC9162,TC9163 and TC9164 are select by bit11~14.

	Switch Select bit								Right Left		Switch Select bit				
	S1	S2	S3	S4	S5	S6	S7	S8	S9	S10	S11	S12	S13	S14	
TC9162N	S1~S8 are "0" position to ON by bit1~8 of Serial Data.								0	0	0	0			
TC9163N	S1~S8 are "1" position to ON by bit1~8 of Serial Data.								1	0	0	0			
TC9164N	S1~S8 are "1" position to ON by bit1~8 of Serial Data.								0	1	0	0			

■ LC7522(IC451) : SEA Control

1.Terminal

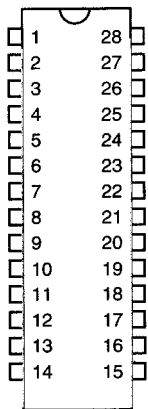

2.Brock Diagram

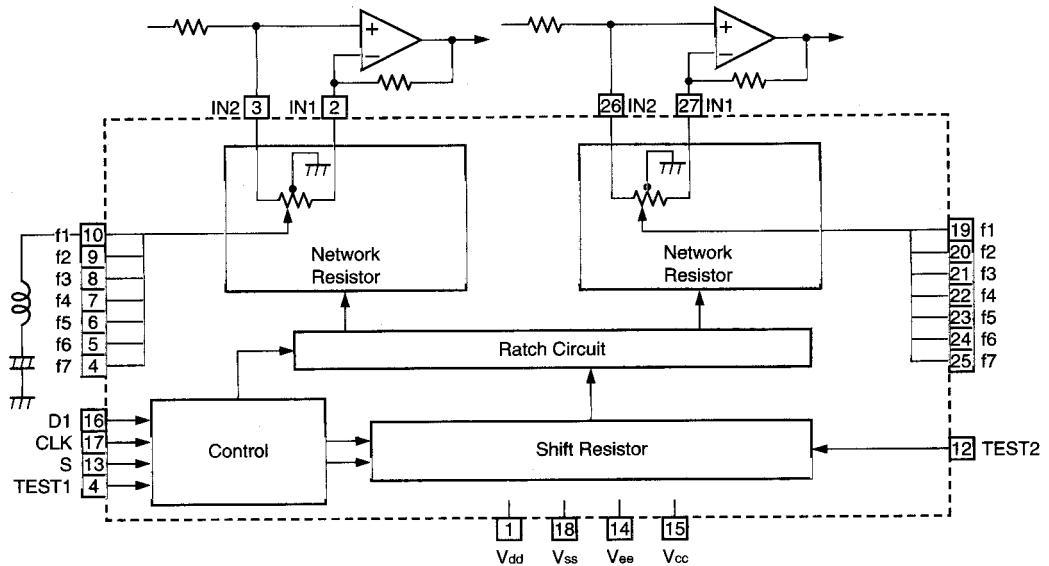

3.Function

Pin No.	Symbol	Function
1	V _{DD}	Power Supply terminal for Audio signal +7V(typ)
18	V _{SS}	Power Supply terminal 0V
14	V _{EE}	Power Supply terminal for Audio signal. Single channel use, joint VSS.
15	V _{CC}	Power Supply terminal +5V(typ)
2,27	IN 1	Audio signal Input terminal
3,26	IN 2	IN1 joint oposit input of Operation amp. IN2 joint unoposit input of Operation amp. It have Right and Left.
16	D1	Data input terminal from CPU Shumit inverter style
17	CLK	Clock input terminal from CPU Shumit inverter style
4~10 19~25	f1~f7	Joint terminal of B.P.F. f1~f7 × Right, Left Total 14 terminal
11	TEST1	Internal test terminal of IC
12	TEST2	It can use open condition
13	S	Select terminal for 2 tip use "1" input, key code 7C3→VDD joint "0" input, key code 7C2→VEE joint
28	NC	No use

■ XCF56009FJ88 (IC631) : DSP Signal Processor

1. Terminal Lay out

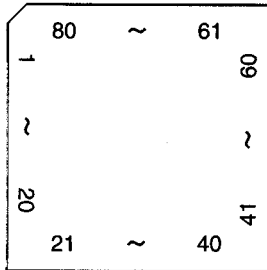

2. Block Diagram

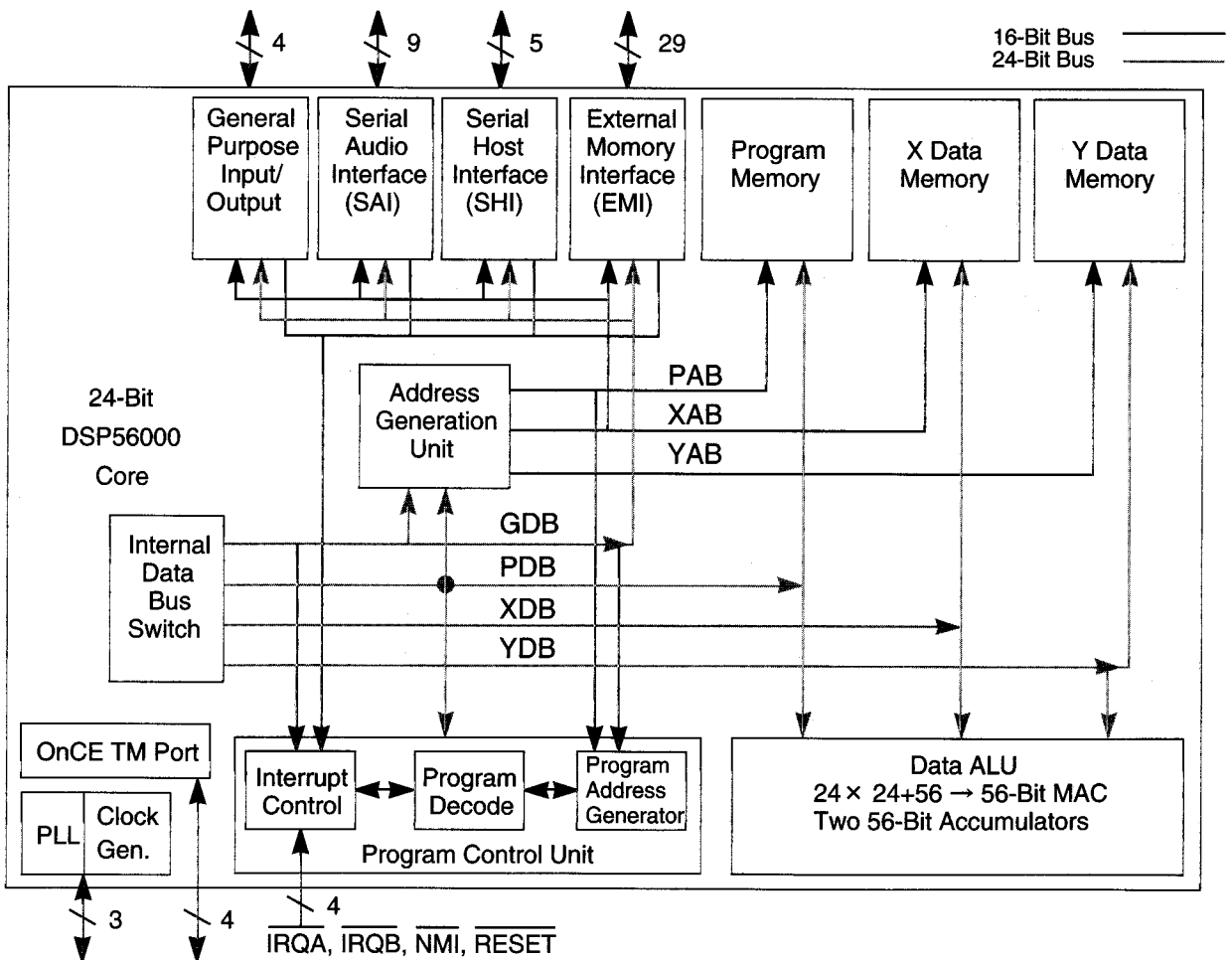

3.Pin function

Pin No	Symbol	I/O	Function	Pin No	Symbol	I/O	Function
1	GND A	---	Ground	41	MOSI	I/O	SPI Master-Out-Slave-In
2	MCS0	O	No use	42	SS	I	SPI Slave Select
3	MCS3	O	No use	43	HRQE	I/O	Host Request
4	MA14	O	No use	44	GNDS	---	Ground
5	MA13	---	No use	45	SDO2	O	No use
6	VCCA	O	Address Bus Power	46	SDO1	O	Serial Data Output
7	MA12	---	No use	47	SDO0	O	Serial Data Output
8	GND A	---	Ground	48	VCCS	---	Serial Interface Power
9	VCCQ	---	Quiet Power	49	SCKT	I/O	Serial Clock Transmit
10	GNDQ	O	Ground	50	WST	I/O	Word Select Transmit
11	MA11	O	No use	51	SCKR	I/O	Receive Serial Clock
12	MA10	O	No use	52	GNDQ	---	Ground
13	MA9	O	No use	53	VCCQ	---	Quiet Power
14	MA8	---	No use	54	GNDS	---	Ground
15	GND A	O	Ground	55	WSR	I/O	Word Select Receive
16	MA7	---	No use	56	SDI1	I	Serial Data Input
17	VCCA	O	Address Bus Power	57	SDI0	I	Serial Data Input
18	MA6	O	No use	58	DSO	O	No use
19	MA5	O	No use	59	DSI	I	No use
20	MA4	---	No use	60	DSCK	I	No use
21	GND A	O	Ground	61	DR	I	Debug Request
22	MA3	O	No use	62	MD7	I/O	No use
23	MA2	O	No use	63	MD6	I/O	No use
24	MA1	O	No use	64	MD5	I/O	No use
25	MA0	I	No use	65	MD4	I/O	No use
26	SCK	I	SPI Serial Clock	66	GNDD	---	Ground
27	EXTAL	---	External Clock/Crystal	67	MD3	I/O	No use
28	VCCQ	---	Quiet Power	68	MD2	I/O	No use
29	GNDQ	I	Ground	69	MD1	I/O	No use
30	PINIT	---	Ground	70	VCCD	---	Data Bus Power
31	GNDP	I	Ground	71	MD0	I/O	No use
32	PCAP	---	PLL Filter Capacitor	72	GNDD	---	Ground
33	VCCP	---	PLLn Power	73	GPIO3	I/O	No use
34	GNDS	I/O	Ground	74	GPIO2	I/O	No use
35	MISO	I	SPI Master-In-Slave -Out	75	GPIO1	I/O	No use
36	RESET	I	Reset	76	GPIO0	I/O	Control Signal with IC641
37	MODA	I	Mode Select	77	MRDO	O	No use
38	MODB	I	Ground	78	MWR	O	No use
39	MODC	I	Mode Select	79	MCS1	O	No use
40	VCCS	---	Serial Interface Power	80	MCS2	O	No use

■ XCB56007FJ88 (IC641) : DSP Signal Processor

1. Terminal Layout

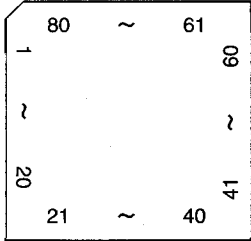

2. Block Diagram

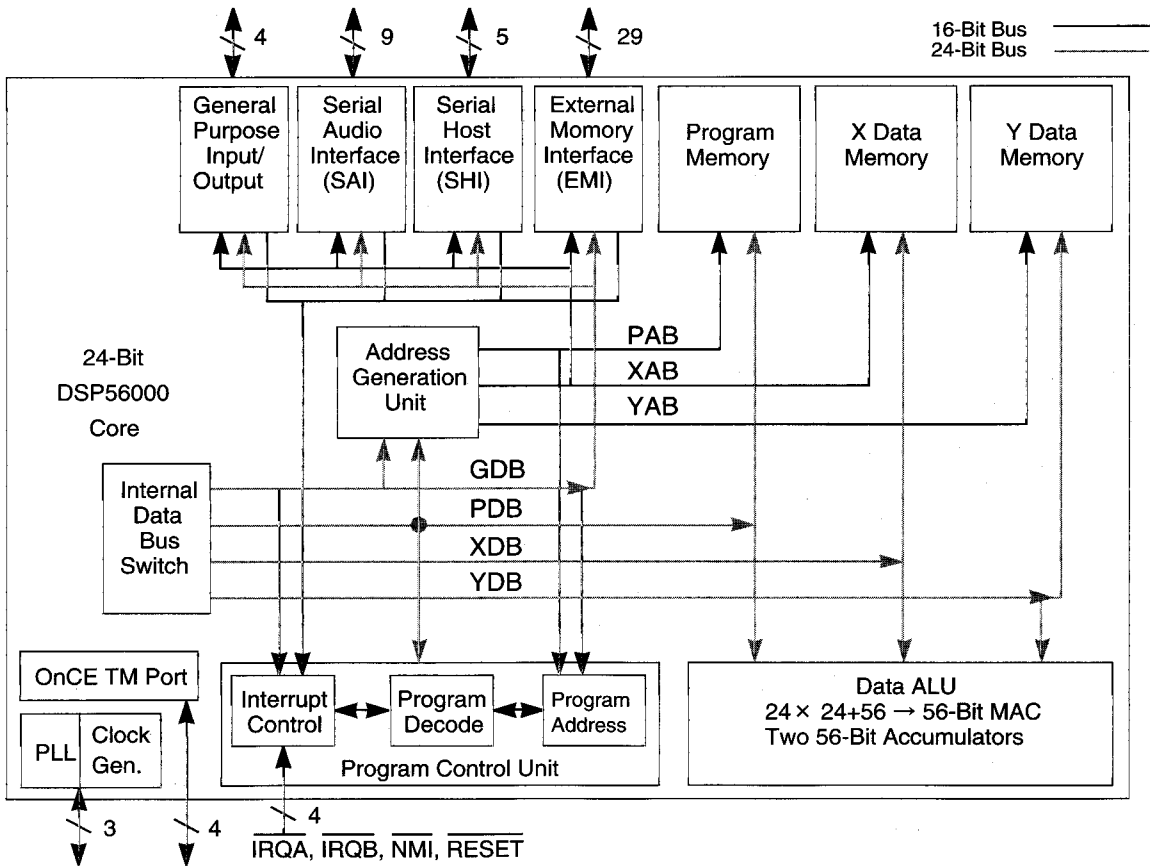

3. Functions

Pin No	Symbol	I/O	Function	Pin No	Symbol	I/O	Function
1	GND A	---	Ground	41	MOSI	I/O	SPI Master-Out-Slave-In
2	$\overline{\text{MCS0}}$	O	Memory Chip Select	42	SS	I	SPI Slave Select
3	$\overline{\text{MCS3}}$	O	No use	43	HRQE	I/O	Host Request
4	MA14	O	Memory Address	44	GNDS	---	Ground
5	MA13	O	Memory Address	45	SDO2	O	Serial Data Output
6	VCCA	---	Address Bus Power	46	SDO1	O	Serial Data Output
7	MA12	O	Memory Address	47	SDO0	O	Serial Data Output
8	GND A	---	Ground	48	VCCS	---	Serial Interface Power
9	VCCQ	---	Quiet Power	49	SCKT	I/O	Serial Clock Transmit
10	GNDQ	---	Ground	50	WST	I/O	Word Select Transmit
11	MA11	O	Memory Address	51	SCKR	I/O	Receive Serial Clock
12	MA10	O	Memory Address	52	GNDD	---	Ground
13	MA9	O	Memory Address	53	VCCQ	---	Quiet Power
14	MA8	O	Memory Address	54	GNDS	---	Ground
15	GND A	---	Ground	55	WSR	I/O	Word Select Receive
16	MA7	O	Memory Address	56	SDI1	I	Serial Data Input
17	VCCA	---	Address Bus Power	57	SDI0	I	Serial Data Input
18	MA6	O	Memory Address	58	DSO	O	No use
19	MA5	O	Memory Address	59	DSI	I/O	No use
20	MA4	O	Memory Address	60	DSCK	I/O	No use
21	GND A	---	Ground	61	DR	I	Debug Request
22	MA3	O	Memory Address	62	MD7	I/O	Data Bus
23	MA2	O	Memory Address	63	MD6	I/O	Data Bus
24	MA1	O	Memory Address	64	MD5	I/O	Data Bus
25	MA0	O	Memory Address	65	MD4	I/O	Data Bus
26	SCK	I/O	SPI Serial Clock	66	GND0	---	Ground
27	EXTAL	I	External Clock/Crystal	67	MD3	I/O	Data Bus
28	VCCQ	---	Address Bus Power	68	MD2	I/O	Data Bus
29	GNDQ	---	Ground	69	MD1	I/O	Data Bus
30	PINIT	I	Ground/PLL Initialization	70	VCCD	---	Data Bus Power
31	GNDP	---	Ground	71	MD0	I/O	Data Bus
32	PCAP	I	PLL Filter Capacitor	72	GNDO	---	Ground
33	VCCP	---	PLL Power	73	GPIO3	I/O	No use
34	GNDS	---	Ground	74	GPIO2	I/O	No use
35	MISO	I/O	SPI Master-In-Slave-Out	75	GPIO1	I/O	No use
36	RESET	I	Reset	76	GPIO0	I/O	Control Signal with IC631
37	MODA	I	Mode Select	77	MRD	O	Memory Read Strobe
38	MODB	I	Ground	78	$\overline{\text{MWR}}$	O	Memory Write strobe
39	MODC	I	Mode Select	79	$\overline{\text{MCS1}}$	O	No use
40	VCCS	---	Serial Interface Power	80	$\overline{\text{MCS2}}$	O	No use

■ MN173222JAP(IC671) : System Control Micon

1. Terminal Layout

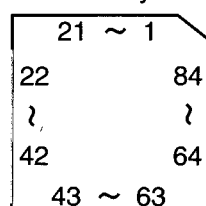

2. Key Matrix

	KEY IN 0	KEY IN 1	KEY IN 2	KEY IN 3
KEY OUT 0	POWER S401	DVD MULTI S419	—	—
KEY OUT 1	SURROUND S402	PRESET SEA S403	TUNER/BAND S404	SETTING S405
KEY OUT 2	SOURCE S406	ADJUST S407	ONE TOUCH OPERATION S408	MEMORY S409
KEY OUT 3	◁ S410	▷ S411	△ S412	▽ S413

3. Pin Function

Pin No.	Symbol	I/O	Function	Pin No.	Symbol	I/O	Function
1	IN1	I	JOG VOLUME control	52	CE	O	Chip enable to IC121
2	IN2	I	JOG VOLUME control	53	CK	O	Clock signal to IC121
3	VIDEO1	O	Video select signal	54	DI	I	Data signal from IC121
4	VIDEO2	O	Video select signal	55	DO	O	Data signal to IC121
5	PROTECT	I	Protector signal input	56	DCSI	I	COMPULINK signal input
6	POWER	O	Power ON/OFF control	57	DCSO	O	COMPULINK signal output
7	KI0	I	Key matrix input	58	DSP ERR	I	Control signal from IC601
8	KI1	I	Key matrix input	59	DSP IFOK	I	Control signal from IC601
9	KI2	I	Key matrix input	60	DSP ACK	I	Control signal from IC601
10	KI3	I	Key matrix input	61	DSP CS	O	Control signal to IC601
11	VCR S/C	I	VCR S/C select signal input	62	T.MUTE	O	Tuner mute signal output
12	G11	O	Grid control signal output	63	S.MUTE	O	Source muting control
13	G10	O	Grid control signal output	64	TV CONT	O	AV compulink control output
14	G9	O	Grid control signal output	65	TV OUT	O	AV compulink output
15	G8	O	Grid control & Key matrix output	66	VCR OUT	O	AV compulink output
16	G7	O	Grid control & Key matrix output	67	VCR IN	I	AV compulink input
17	G6	O	Grid control & Key matrix output	68	RESET IN	I	Reset signal input
18	G5	O	Grid control & Key matrix output	69	X1	-	Connect to GND
19	G4	O	Grid control signal output	70	X2	-	Non connect
20	G3	O	Grid control & Key matrix output	71	Vss	-	Connect to GND
21	G2	O	Grid control & Key matrix output	72	OSC2	-	Oscillation terminal
22	G1/KO7	O	Grid control & Key matrix output	73	OSC1	-	Oscillation terminal
23	Vpp	-	Power supply for FL display	74	VDD	-	Power supply
24~39	S1~S16	O	Segment control signal output	75	SET.I	O	SETTING indication control
40	DVD S/C	I	DVD S/C select signal input	76	ADJ.I	O	ADJUST indication control
41	CLK.D	O	Clock signal to IC601	77	SURR.I	O	SURROUND indication control
42	DATA OUT	O	Data signal to IC601	78	SOURCE.I	O	SOURCE indication control
43	DATA IN	I	Data signal from IC601	79	SEA.I	O	S.E.A. indication control
44	INH	I	Inhibit signal input	80	BAND.I	O	TUNER/BAND indication control
45	RDS CLK	-	Non connect	81	STB	O	Strobe signal to IC341~343.252.321.322
46	RDS DATA	-	Non connect	82	DATA	O	Data signal to IC341~343.252.321.322.404
47	NC	-	Non connect	83	CLK	O	Clock signal to IC341~343.252.321.322.404
48	RM	I	Remocon signal from IC402	84	STB(EX)	O	Strobe signal to IC404
49	D-START	-	Non connect				
50	STEREO	I	Stereo signal input				
51	TUNED	I	Tuning signal input				

■ CS4226-KQ (IC601) : D/A, A/D Converter

1. Terminal Layout

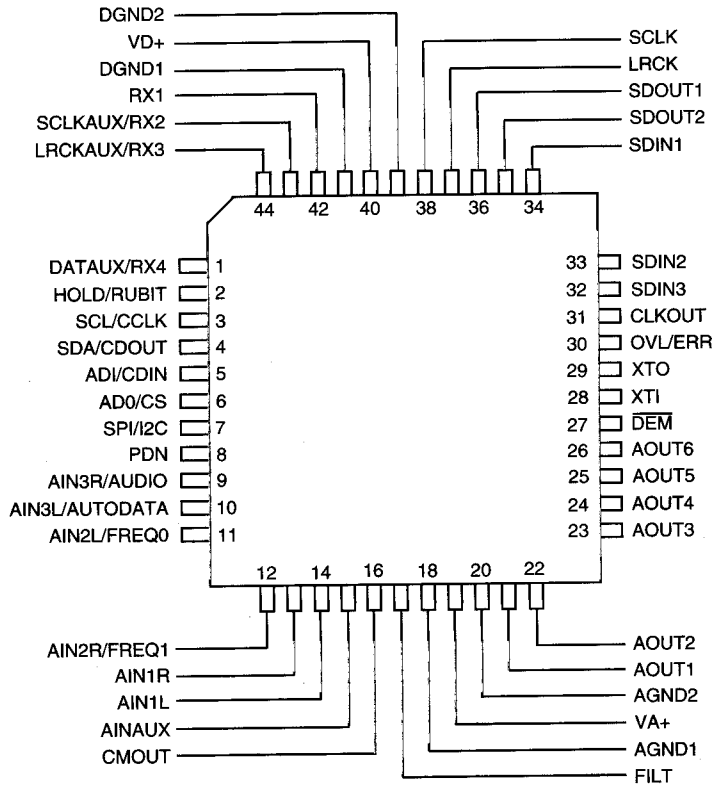

2. Block Diagram

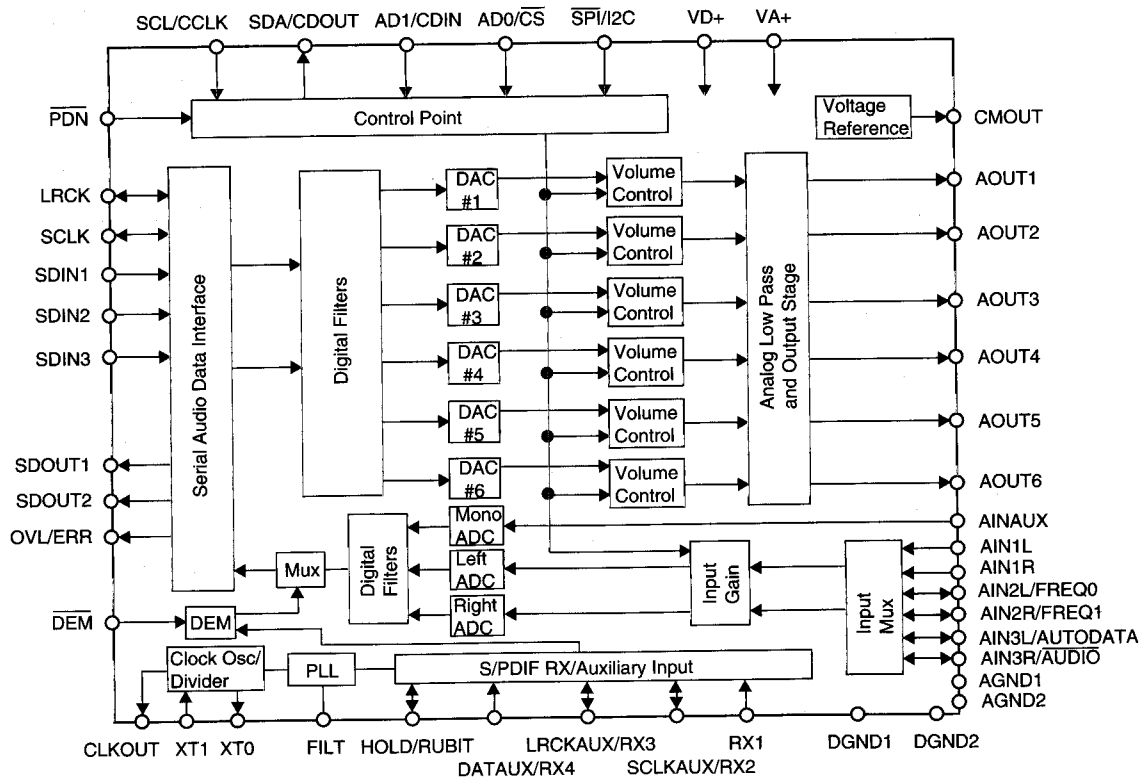

3.Functions

pin no	Symbol	Function
1	DATAUX/RX4	Auxiliary Dat Input / Receiver Channel 4
2	HOLD/RUBIT	S/PDIF Received User Bit / Hold Control
3	SLC/CCLK	Serial Control Interface Clock
4	SDA/CDOUT	Serial Control Data Out
5	ADI/CDIN	Address Bit / Serial Control Data In
6	AD0/ \overline{CS}	Address Bit / Control Port Chip Select
7	$\overline{SPI}/I2C$	Control Port Format
8	\overline{PDN}	Powerdown Pin
9	AIN3R/AUDIO	Right Channel Mux Input 3/AC3 and MPEG
10	AIN3L/AUTODATA	Left Channel Mux Input 3/AC3 and MPEG
11	AIN2L/FREQ0	Left Channel Mux Input 2/Channel Status Freq. Bits
12	AIN2R/FREQ1	Right Channel Mux Input 2/Channel Status Freq. Bits
13	AIN1R	Right Channel Mux Input 1
14	AIN1L	Left Channel Mux Input 1
15	AINAUX	Auxiliary Line Level Input
16	CMOUT	Common Mode Output
17	FILT	PLL Loop Filter Pin
18	AGND1	Analog Ground
19	VA+	Analog Power Input
20	AGND2	Analog Ground
21	AOUT1	Audio Outputs
22	AOUT2	Audio Outputs
23	AOUT3	Audio Outputs
24	AOUT4	Audio Outputs
25	AOUT5	Audio Outputs
26	AOUT6	Audio Outputs
27	\overline{DEM}	De-Emphasis Control
28	XTI	Crystal Connections
29	XTO	Crystal Connections
30	OVL/ERR	Overload Indicator
31	CLKOUT	Master Clock Output
32	SDIN3	Serial Data Input 3
33	SDIN2	Serial Data Input 2
34	SDIN1	Serial Data Input 1
35	SDOUT2	Serial Data Out put 2
36	SDOUT1	Serial Data Out put 1
37	LRCK	Left / Right Select Signal I/O
38	SCLK	DSP Serial Port Clock I/O
39	DGND2	Digital Ground
40	VD+	Digital Power Input
41	DGND1	Digital Ground
42	RX1	Receiver Channel 1
43	SCLKAUX/RX2	Auxiliary Bit Clock Input or Output / Receiver Channel 2
44	LRCKAUX/RX3	Auxiliary Word Clock Input or Output / Receiver Channel 3

■ BA7625 (IC201) : Video Selector

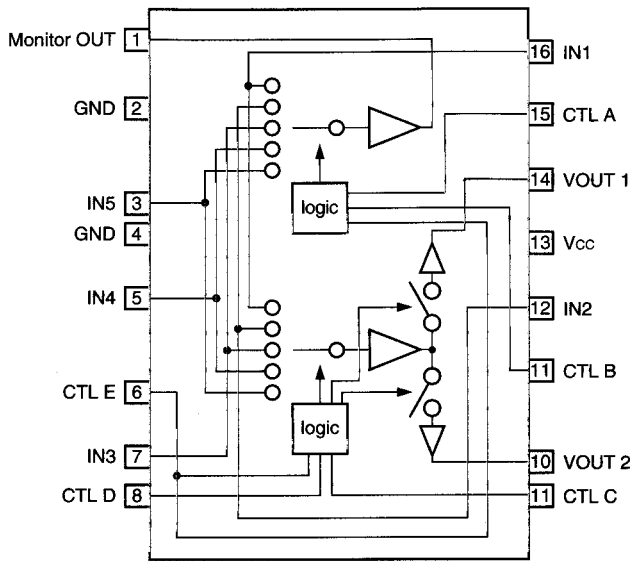

A	B	E	Monitor OUT
L	L	*	IN1
H	L	*	IN2
L	H	*	IN3
H	H	L	IN4
H	H	H	IN5

C	D	E	VOUT1
L	L	*	--
H	L	*	IN2
L	H	*	IN3
H	H	L	IN4
H	H	H	IN5

C	D	E	VOUT2
L	L	*	IN1
H	L	*	--
L	H	*	IN3
H	H	L	IN4
H	H	H	IN5

■ BA7626(IC241) : VIDEO SELECTOR

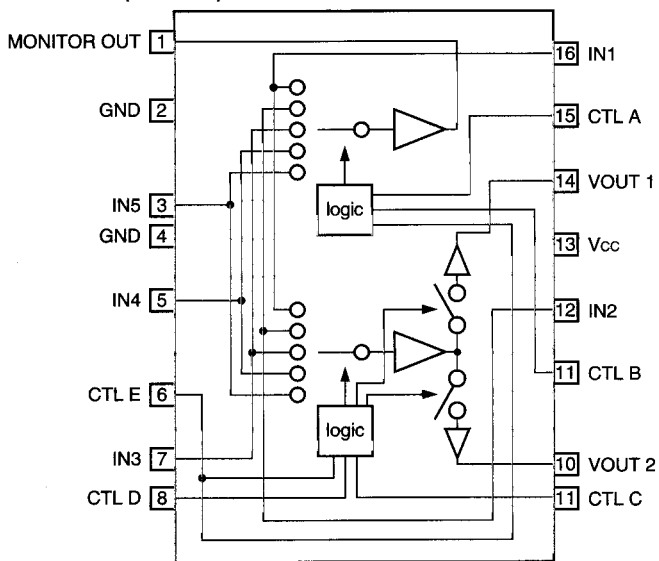

A	B	E	MONITOR OUT
L	L	*	IN1
H	L	*	IN2
L	H	*	IN3
H	H	L	IN4
H	H	H	IN5

C	D	E	VOUT1
L	L	*	--
H	L	*	IN2
L	H	*	IN3
H	H	L	IN4
H	H	H	IN5

C	D	E	VOUT2
L	L	*	IN1
H	L	*	--
L	H	*	IN3
H	H	L	IN4
H	H	H	IN5

■ NJM2285D (IC202) : Video Switch

1. Terminal Layout & Block Diagram

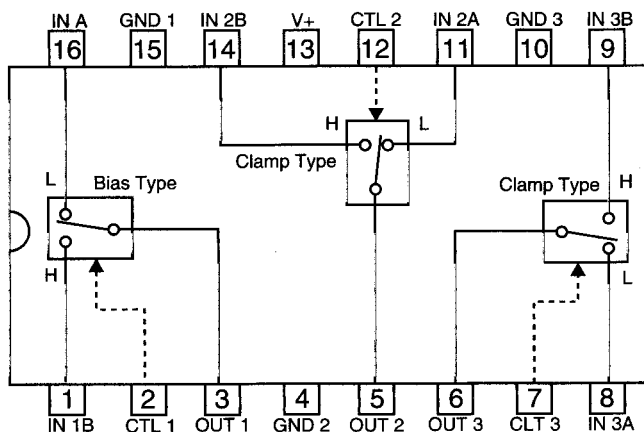

■ NJM4580DD (IC301) : Dual Ope. Amp

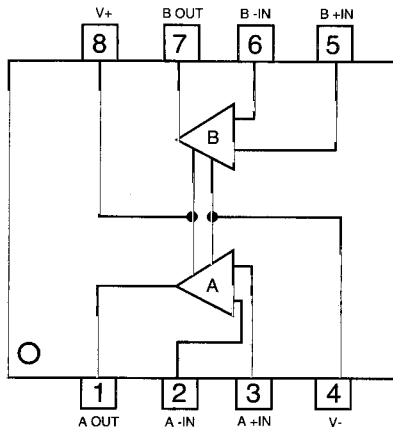

■ NJM4580L (IC361) : Dual Ope. Amp.

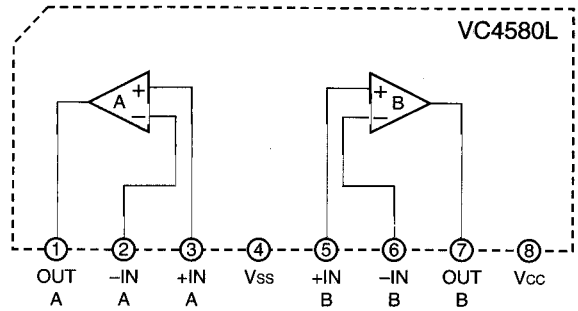

■ NJM4580D(IC305) : Dual Ope. Amp

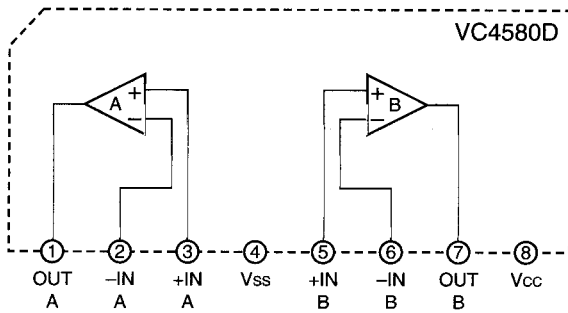

■ BA15218N (IC331,332,333) : Dual Ope. Amp.

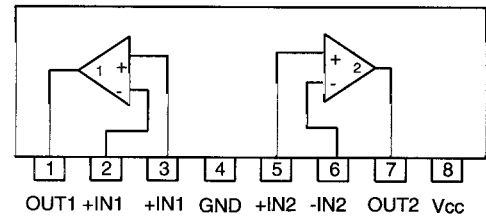

■ BU4051BC (IC341) : Analog Multiplexers / Demultiplexers

1.Terminal

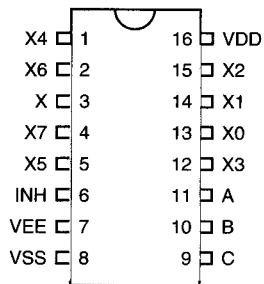

2.Brock Diagram

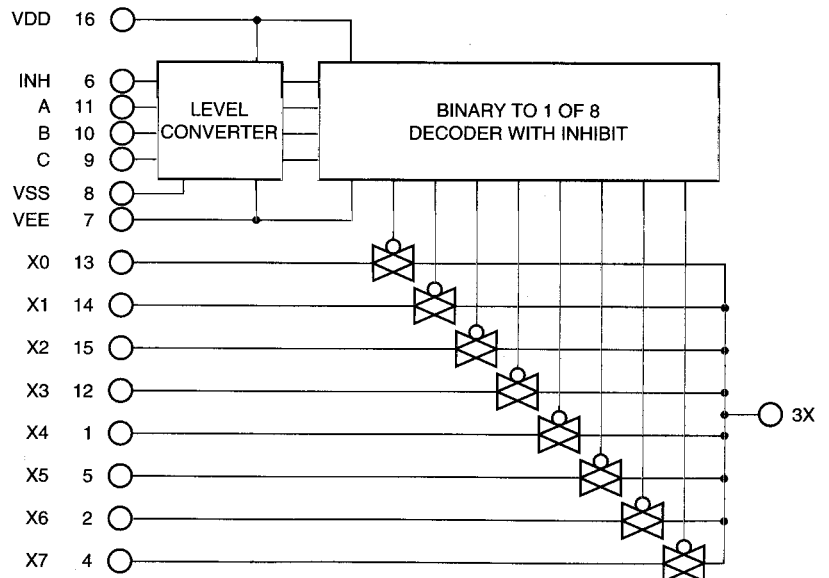

■ GP1U27151X (IC404) : Receiver for remote

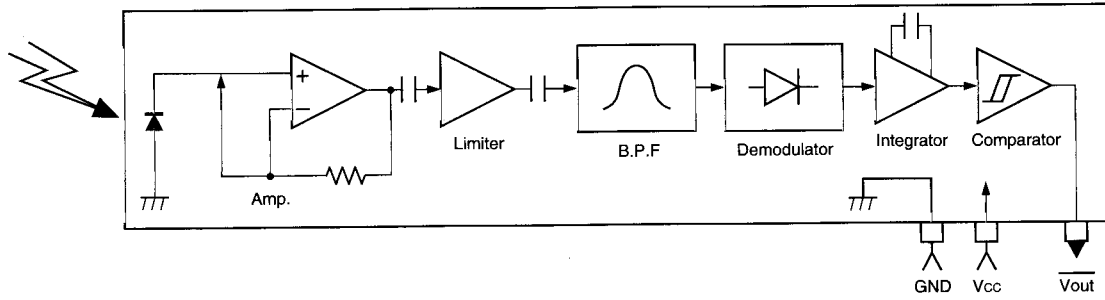

■ M5243P (IC452) : S.E.A. Graphic Equalizer

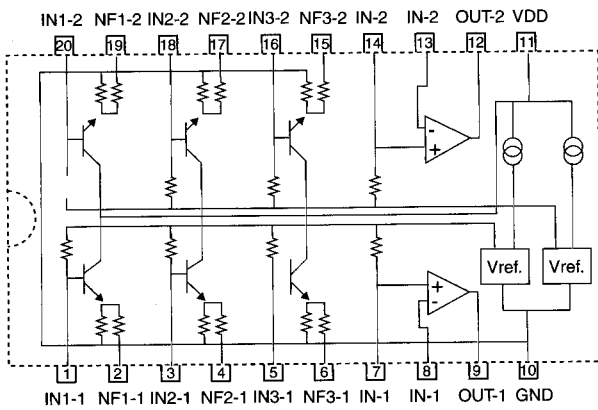

■ NJM4580E : Dual Ope. Amp. (IC501,511,521,551,561,571,581,591)

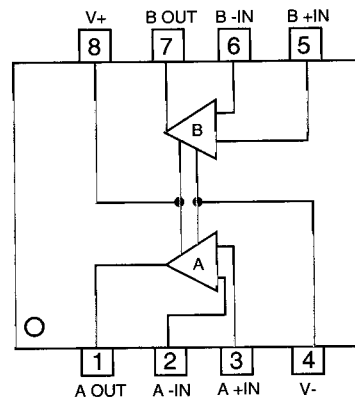

■ N341256SJ-15 (IC651) :

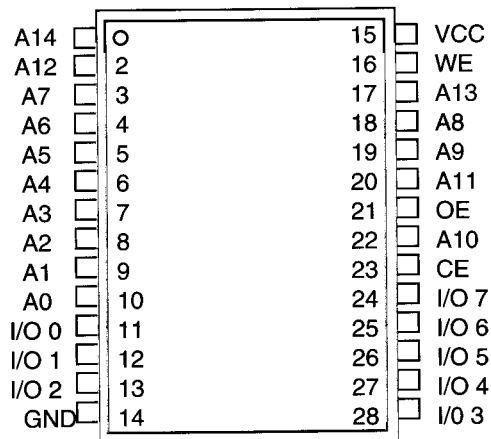

Symbol	Terminal
A0-A14	Address input
I/O 0-I/O 7	Data I / O
CE	Chip Enable input
OE	Output / Enable Input
WE	Write Enable Input
VCC	Power Supply (+5V)
GND	Ground

■ TA7317P (IC901) : Protector

1. Terminal Lay out

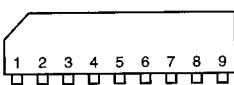

2. Block Diagram

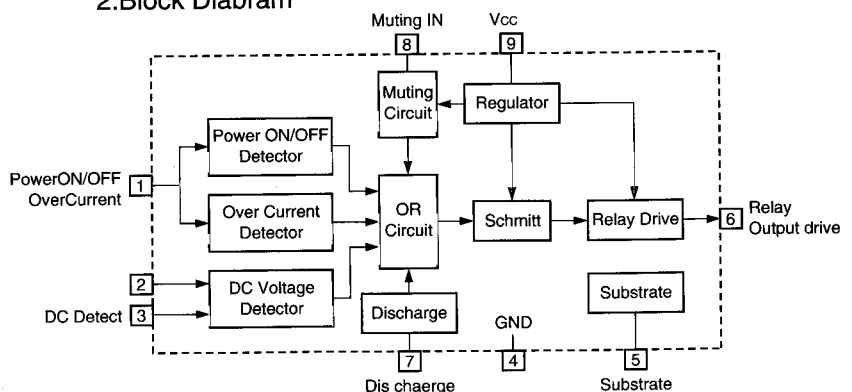

■ BU2092 (IC402) : PORT EXPANDER

1. Terminal Layout

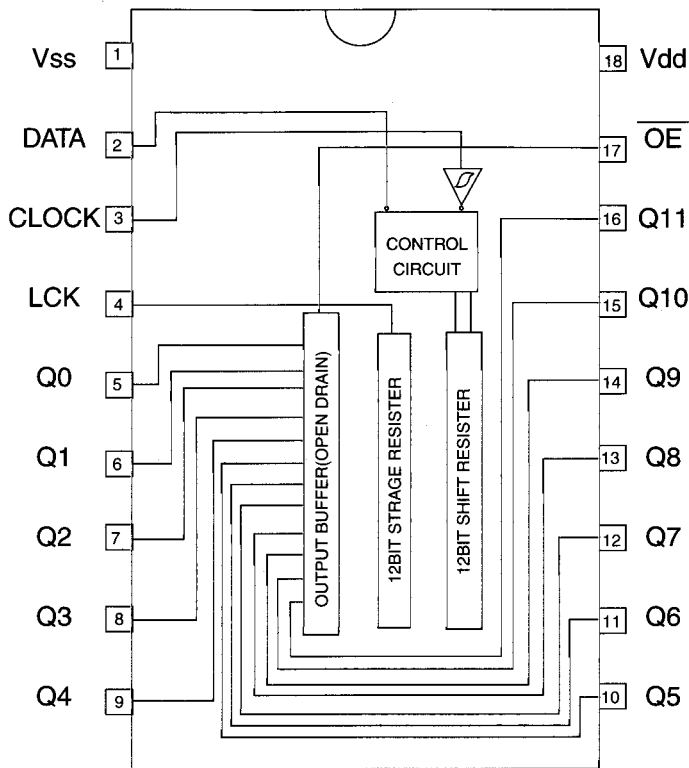

2. Pin Function

Pin No.	Symbol	I/O	Function						
1	Vss	-	Connect to GND						
2	DATA	I	Serial Data input						
3	CLOCK	I	Shift Clock of Data						
4	LCK	I	Latch Clock of Data						
5~16	Q0~Q11	O	Parallel Data Output <table border="1" style="margin-left: 20px;"> <tr> <td>Latch Data</td> <td>L</td> <td>H</td> </tr> <tr> <td>OUTPUT</td> <td>ON</td> <td>OFF</td> </tr> </table>	Latch Data	L	H	OUTPUT	ON	OFF
Latch Data	L	H							
OUTPUT	ON	OFF							
17	OE	I	Output Enable						
18	Vdd	-	Power Supply						

■ VC5022-2(IC701.702) : SUPER A

1. Terminal Layout

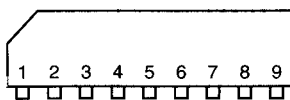

2. Block Diagram

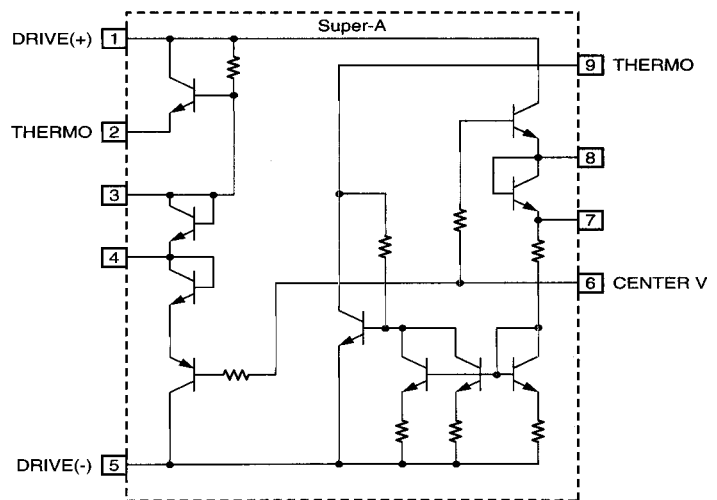

INTERNAL CONNECTION OF FL DISPLAY TUBE

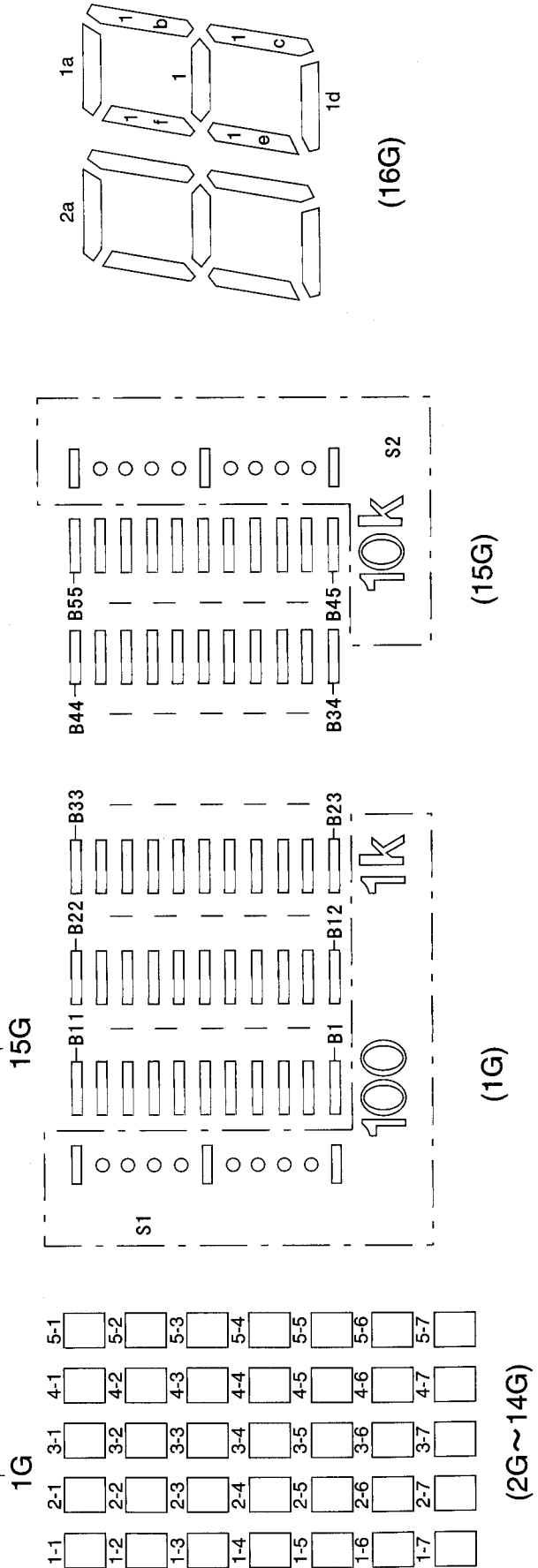
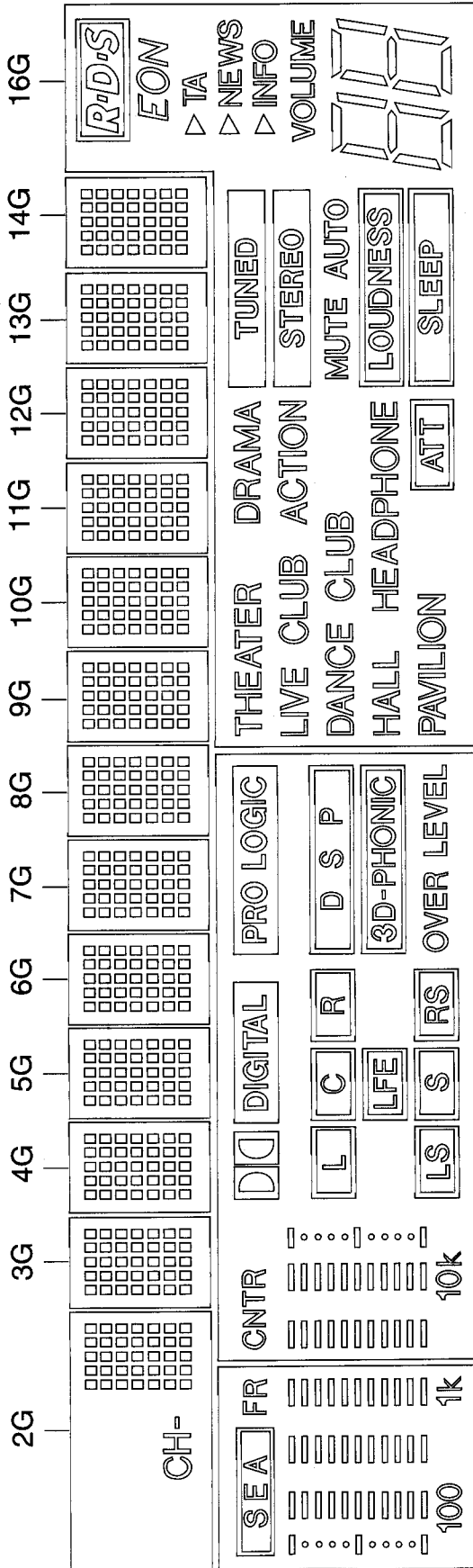

ANODE CONNECTION

	1G	2G	3G~14G	15G	16G
P1	S1	1-1	1-1	S2	-
P2	B1	2-1	2-1	B34	-
P3	B12	3-1	3-1	B45	2d
P4	B23	4-1	4-1	B35	2e
P5	B2	5-1	5-1	B46	2c
P6	B13	1-2	1-2	B36	2g
P7	B24	2-2	2-2	B47	2f
P8	B3	3-2	3-2	B37	2b
P9	B14	4-2	4-2	B48	2a
P10	B25	5-2	5-2	B38	1d
P11	B4	1-3	1-3	B49	1e
P12	B15	2-3	2-3	B39	1c
P13	B26	3-3	3-3	B50	1g
P14	B5	4-3	4-3	B40	1f
P15	B16	5-3	5-3	B51	1b
P16	B27	1-4	1-4	B41	1a
P17	B6	2-4	2-4	B52	R-D-S
P18	B17	3-4	3-4	B42	EON
P19	B28	4-4	4-4	B53	VOLUME
P20	B7	5-4	5-4	B43	▷ INFO
P21	B18	1-5	1-5	B54	▷ NEWS
P22	B29	2-5	2-5	B44	▷ TA
P23	B8	3-5	3-5	B55	ATT
P24	B19	4-5	4-5	LS	SLEEP
P25	B30	5-5	5-5	S	LOUDNESS
P26	B9	1-6	1-6	RS	PAVILION
P27	B20	2-6	2-6	OVER LEVEL	HEADPHONE
P28	B31	3-6	3-6	3D-PHONIC	HALL
P29	B10	4-6	4-6	LFE	MUTE AUTO
P30	B21	5-6	5-6	CNTR	STEREO
P31	B32	1-7	1-7	L	TUNED
P32	B11	2-7	2-7	C	DANCE CLUB
P33	B22	3-7	3-7	R	ACTION
P34	B33	4-7	4-7	D S P	LIVE CLUB
P35	SEA	5-7	5-7	D I DIGITAL	DRAMA
P36	FR	CH-	-	PRO LOGIC	THEATER

Disassembly Procedures

■ Removing the Top cover

(See Fig. 1)

1. From behind body, remove the four screws ① of the left and right side and three screws ② of the rear side on top cover.
2. Lift the back of the top cover spreading both sides to remove.

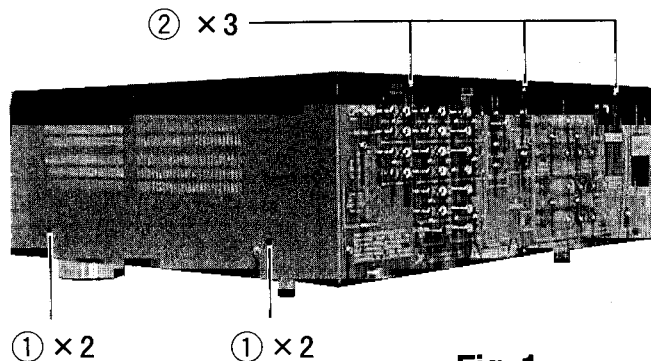

Fig. 1

■ Removing the Front panel

(See Fig. 2)

1. Remove the Top cover.
2. Disconnect the six connectors CN202, CN206, CN244, CN400, CN402 and CN416.
3. Remove the three screws ③ on top side of Front panel and five screws ④ on under the Front panel.
4. Remove the Front panel assembly.

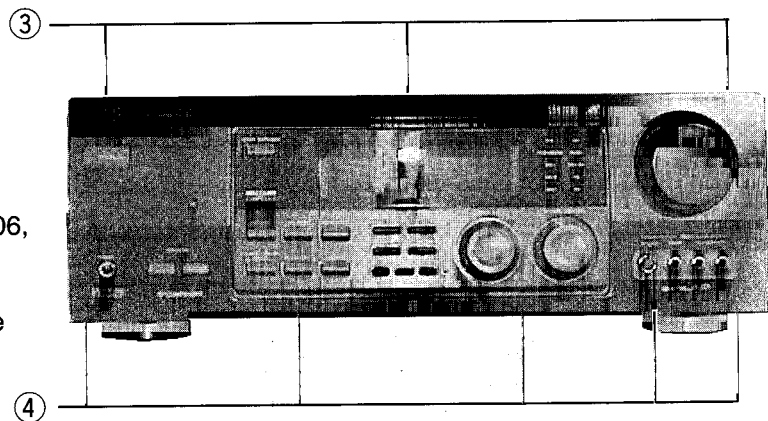

Fig. 2

■ Removing the Rear panel

(See Fig. 3)

1. Remove the Top cover.
2. Pull out the Cord stopper ⑤.
3. Remove the 27pcs screws ⑥ on Rear panel.
4. Remove the Rear panel.

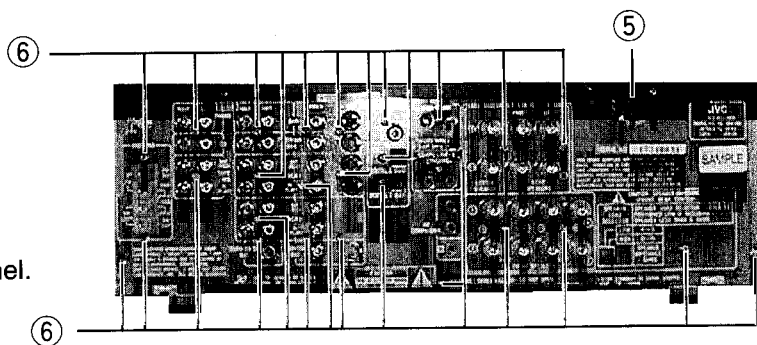

Fig. 3

■ **Removing Front P.C. board**

(See Figs. 4 and 5)

1. Remove the Top cover.
2. Remove the Front panel.
3. Pull out the volume knob ⑦ , then turn off to counterclockwise the volume nut ⑧ .
4. Remove the six screws ⑨ and disconnect connector wire at CN422 ⑩ and CN430 ⑪ .
5. Remove the Front P.C. board.

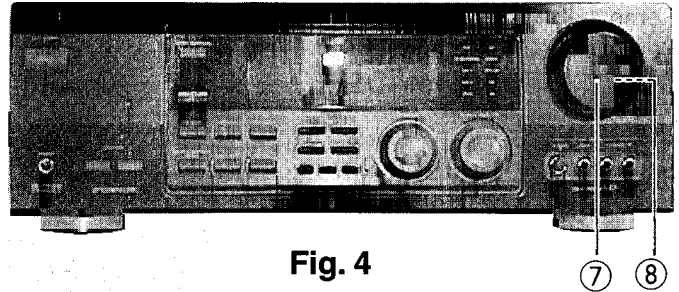

Fig. 4

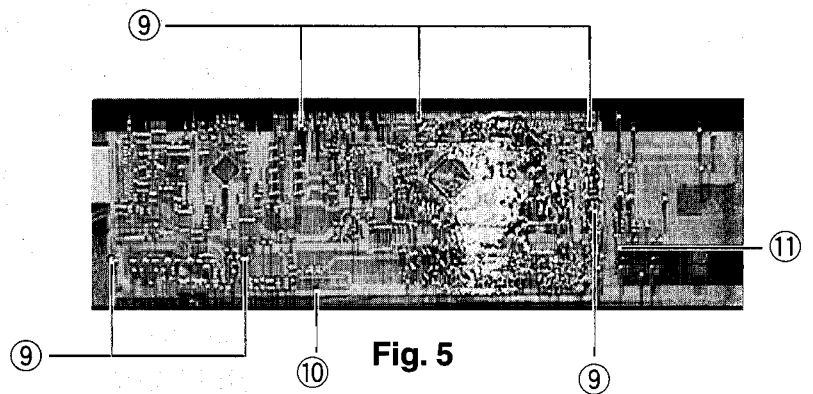

Fig. 5

■ **Removing Switch P.C. board**

(See Fig. 6)

1. Remove the Top cover.
2. Remove the Front panel.
3. Remove the Front P.C. board.
4. Remove the six screws ⑫ and disconnect connector wire at CN422 ⑬ and CN430 ⑭ .
5. Remove the P.C. board cover from four engagements ⑮ at front panel.
6. Remove the Switch P.C. board.

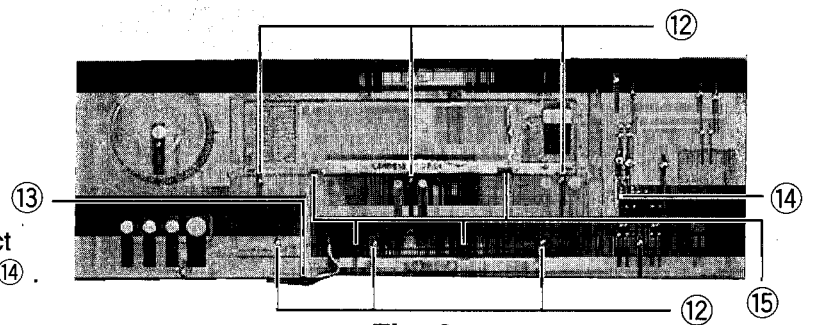

Fig. 6

■ **Removing Remote P.C. board**

(See Fig. 7)

1. Remove the Top cover.
2. Remove the Front panel.
3. Remove four screws ⑯ .
4. Remove the Remote P.C. board.

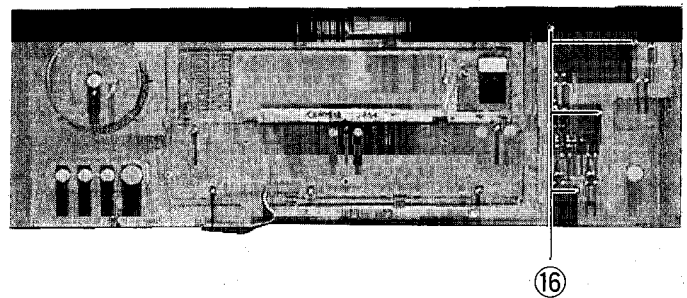

Fig. 7

■ Removing the Main P.C. board

(See Fig. 8)

1. Remove the Top cover.
2. Remove the Front panel.
3. Remove the Rear panel.
4. Remove the Joint P.C.board ⑰, ⑱ and ⑲.
5. Remove the Pre amp P.C. board ⑳.
6. Remove the Tuner P.C. board ㉑.
7. Remove the SEA P.C. board ㉒.
8. Remove the Analog P.C. board ㉓.
9. Remove the Center tone P.C. board ㉔.
10. Remove the V-Audio P.C. board ㉕.
11. Remove the Video P.C. board ㉖.
12. Remove the S-Video P.C. board ㉗.
13. Remove the TXT Compulink P.C. board ㉘.
14. Remove the seven screws ㉙ and take off the shield cover ㉚.
15. Remove the DSP P.C. board ㉛.
16. Remove the five screws ㉜.
17. The Main P.C. board slide to right way and lift up right side of the Main P.C. board.

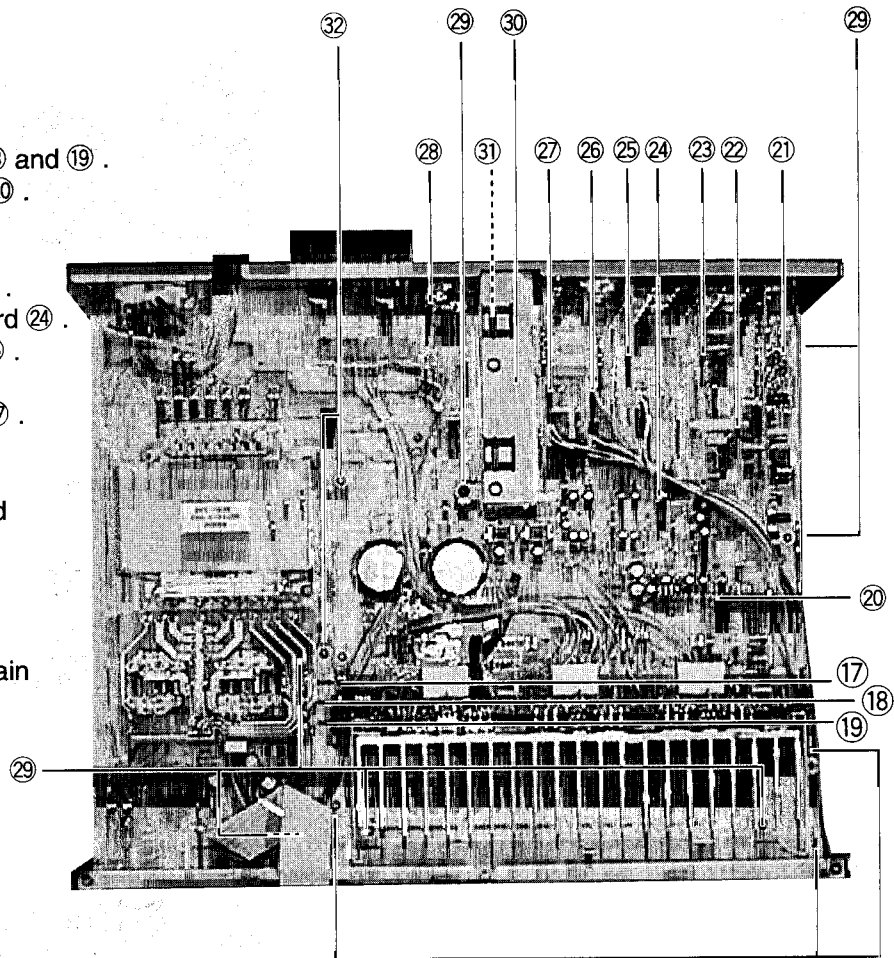

Fig. 8

■ Removing the Amp P.C. board

(See Fig. 9)

1. Remove the Top cover.
2. Remove the Front panel.
3. Remove the Rear panel.
4. Remove the Joint P.C. board ⑰, ⑱ and ⑲.
5. Remove the Pre amp P.C. board ⑳.
6. Remove the Tuner P.C. board ㉑.
7. Remove the SEA P.C. board ㉒.
8. Remove the Analog P.C. board ㉓.
9. Remove the Center tone P.C. board ㉔.
10. Remove the V-Audio P.C. board ㉕.
11. Remove the Video P.C. board ㉖.
12. Remove the S-Video P.C. board ㉗.
13. Remove the TXT Compulink P.C. board ㉘.
14. Remove the six screws ㉙ and four screws ㉚.
15. Remove the Amp P.C. board.

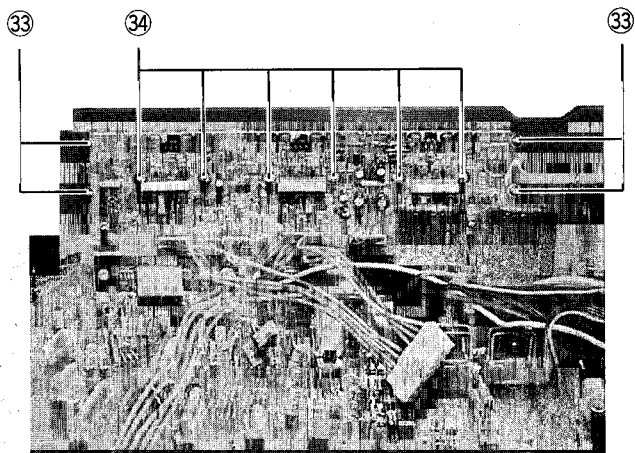

Fig. 9

Adjustment Procedures

■ TUNER SECTION

1. Tuner range

FM	87.5MHz~108.0MHz
MW	530kHz~1710kHz

2. Tuning voltage

Confirm the voltages in the table at TP101

FM tuning voltage (Unit V)

87.5MHz	1.6 <	(Nominal 2.0)
108.0MHz	8.0 <	(Nominal 9.0)

MW tuning voltage (Unit V)

530kHz	0.8 <	(Nominal 1.0)
1710kHz	8.0 <	(Nominal 8.8)

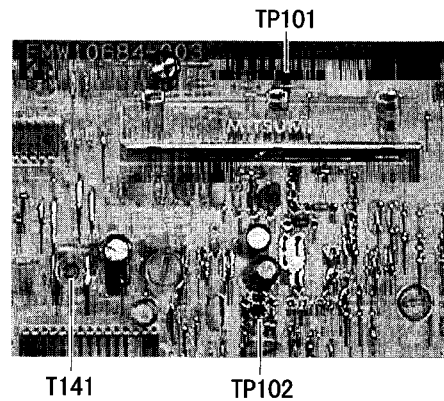

3. FM center meter

Receive a broadcast by using the function of 'AUTO STOP'

Adjust T141 (Detector coil) so that the voltage at TP102 becomes $0 \pm 1.5\text{mV}$

■ POWER AMPLIFIER SECTION

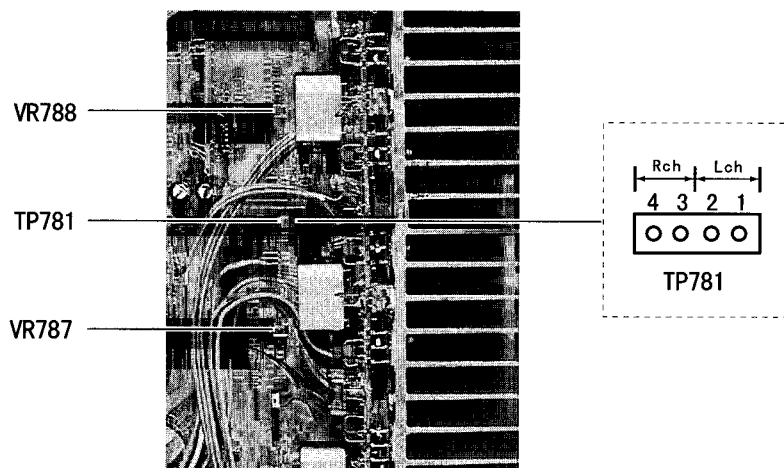

IDLING CURRENT

1. Set the volume control to minimum during this adjustment. set the surround mode "OFF"

2. Turn VR787 and VR788 fully counterclockwise to warm up before adjustment.

If the heat sink is already warm from previous use the correct adjustment can not be made.

3. For L-ch, connect a DC voltmeter between TP001's pin1 and pin2 (Lch)

And, connect it between pin3 and pin4(Rch).

4. 30 minutes later after power on, adjust VR741 for L-ch, or VR742 for R-ch so that the DC voltmeter value has $1\text{mV} \sim 10\text{mV}$.

-MEMO-

Block Diagram

CPU System

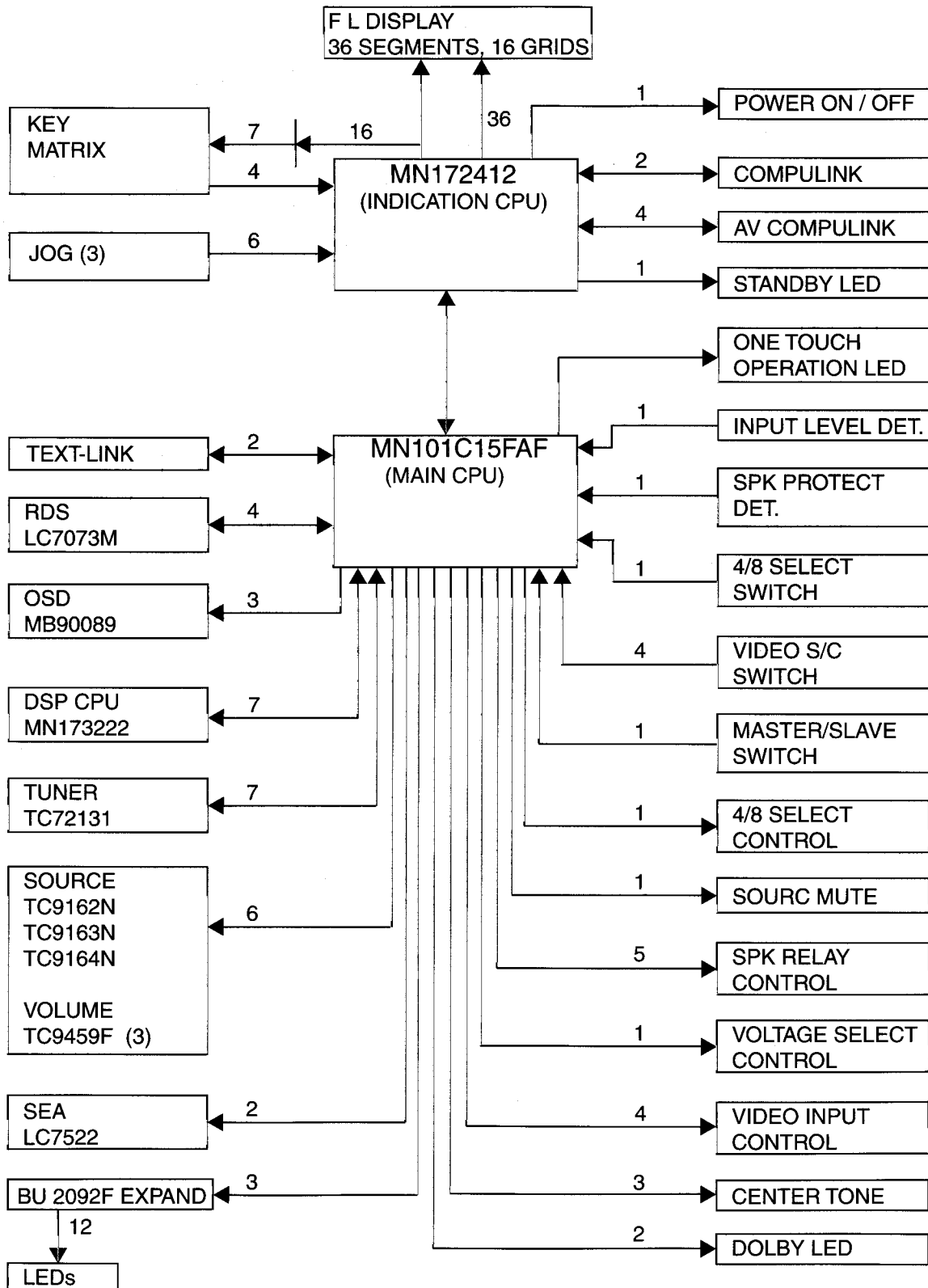

Tuner Section

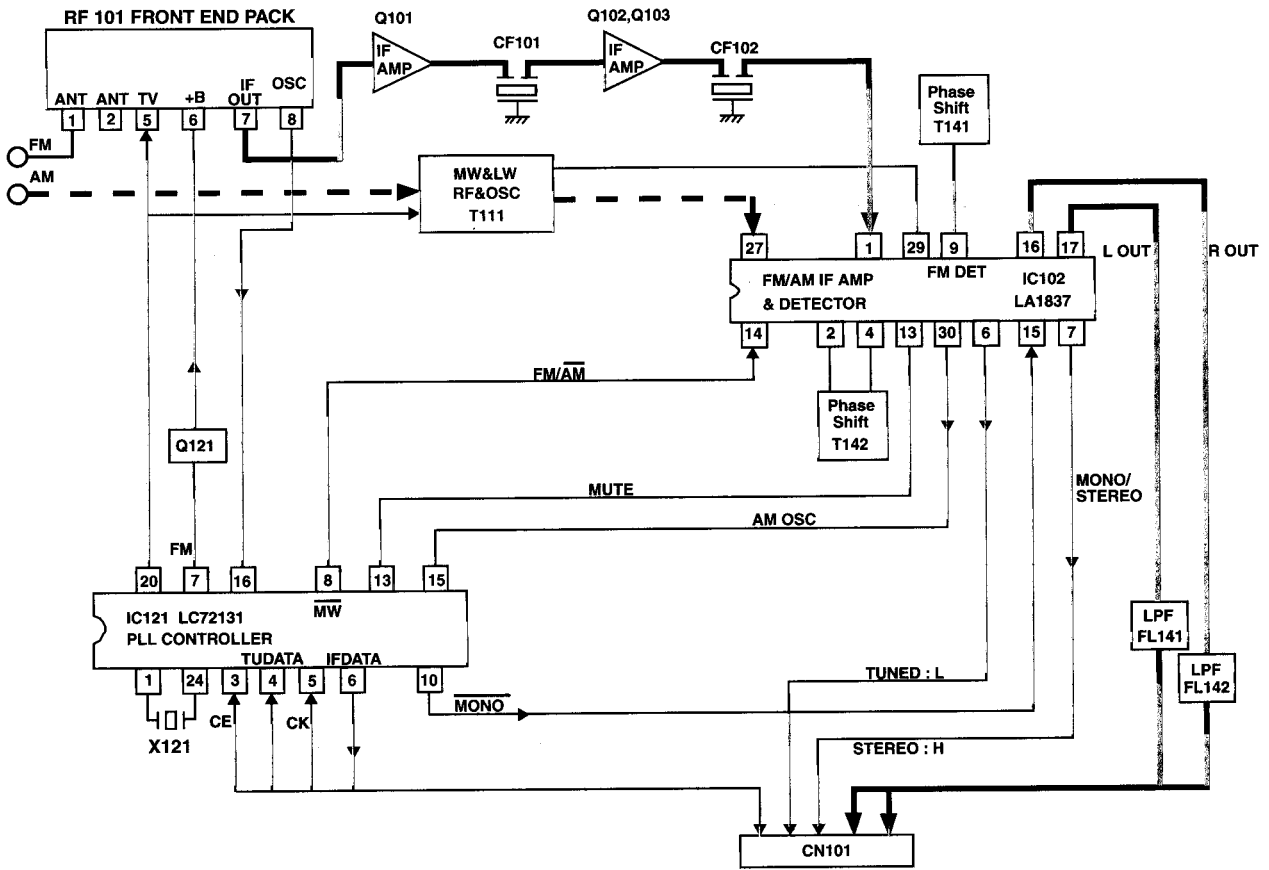

Block diagram

For RX-774/884/1024

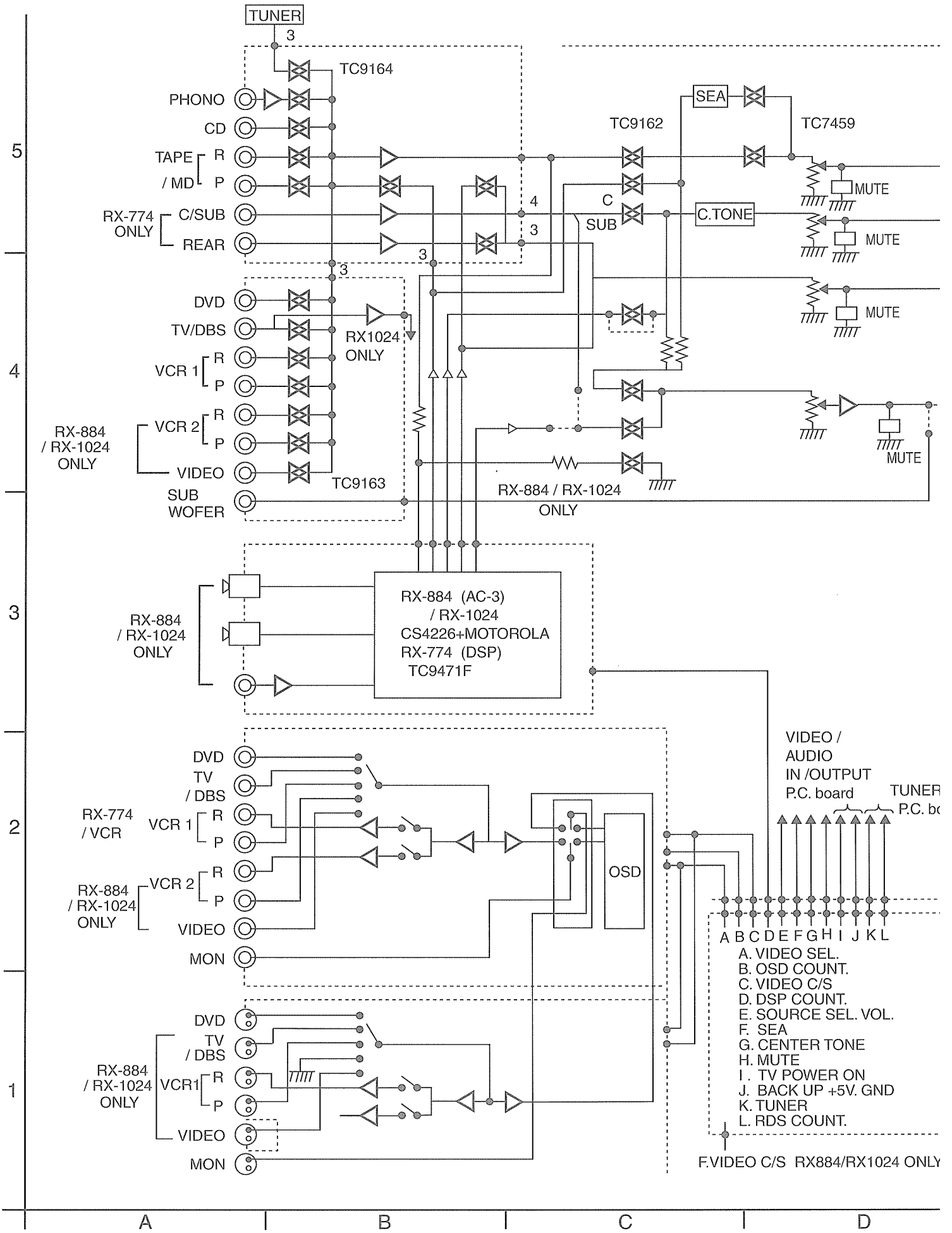

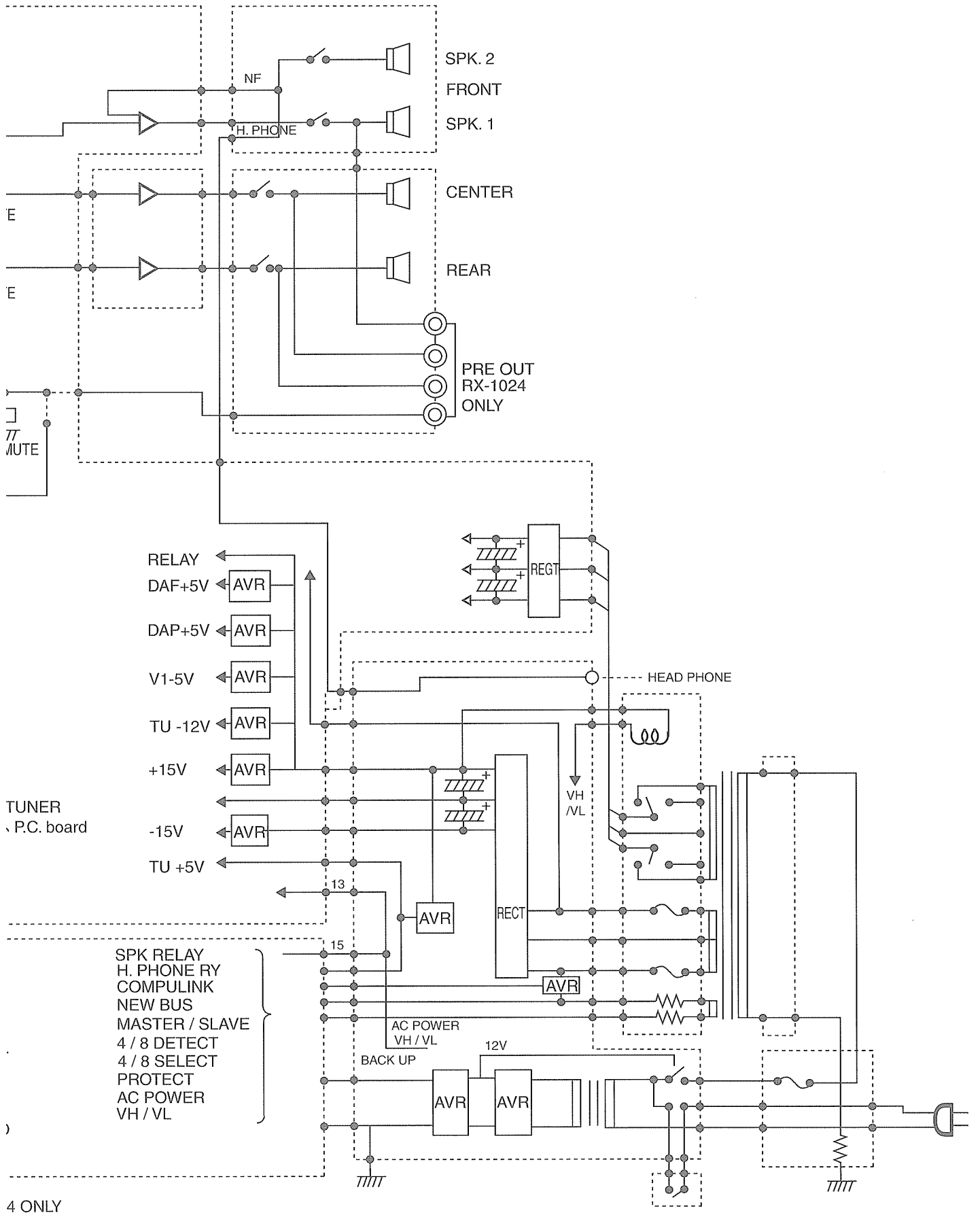

4 ONLY

Schematic Diagrams

POWER PRIMARY SECTION

5

4

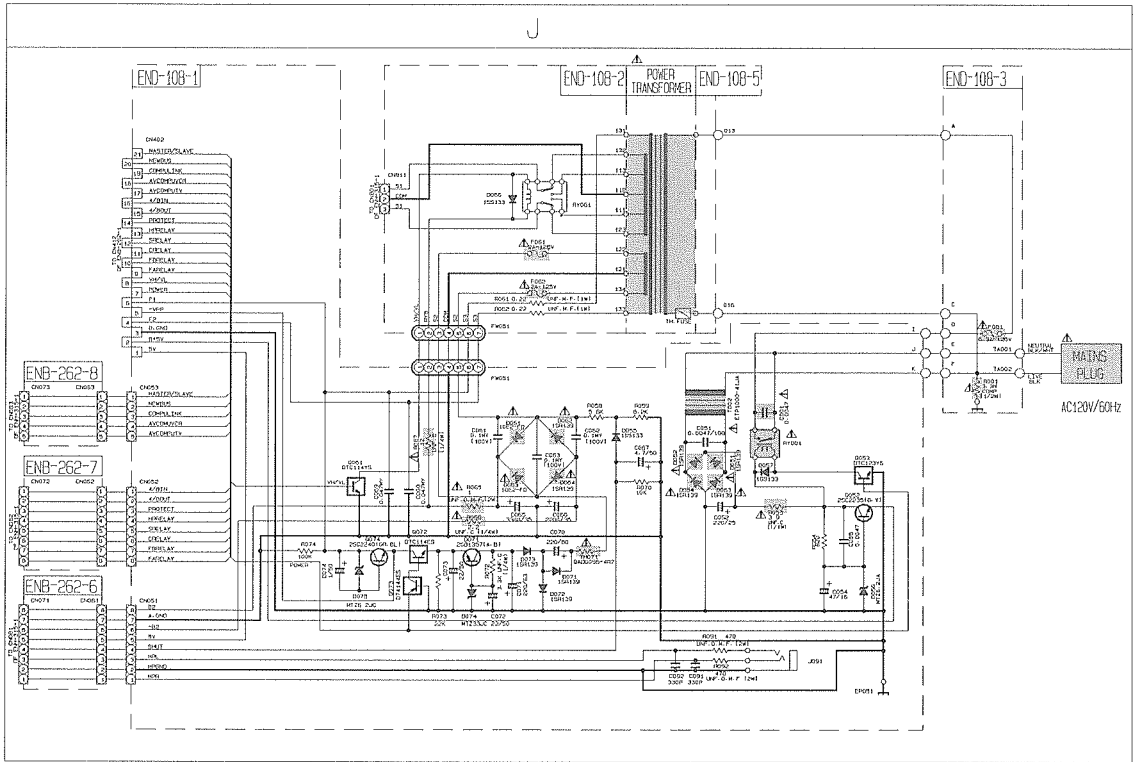

3

2

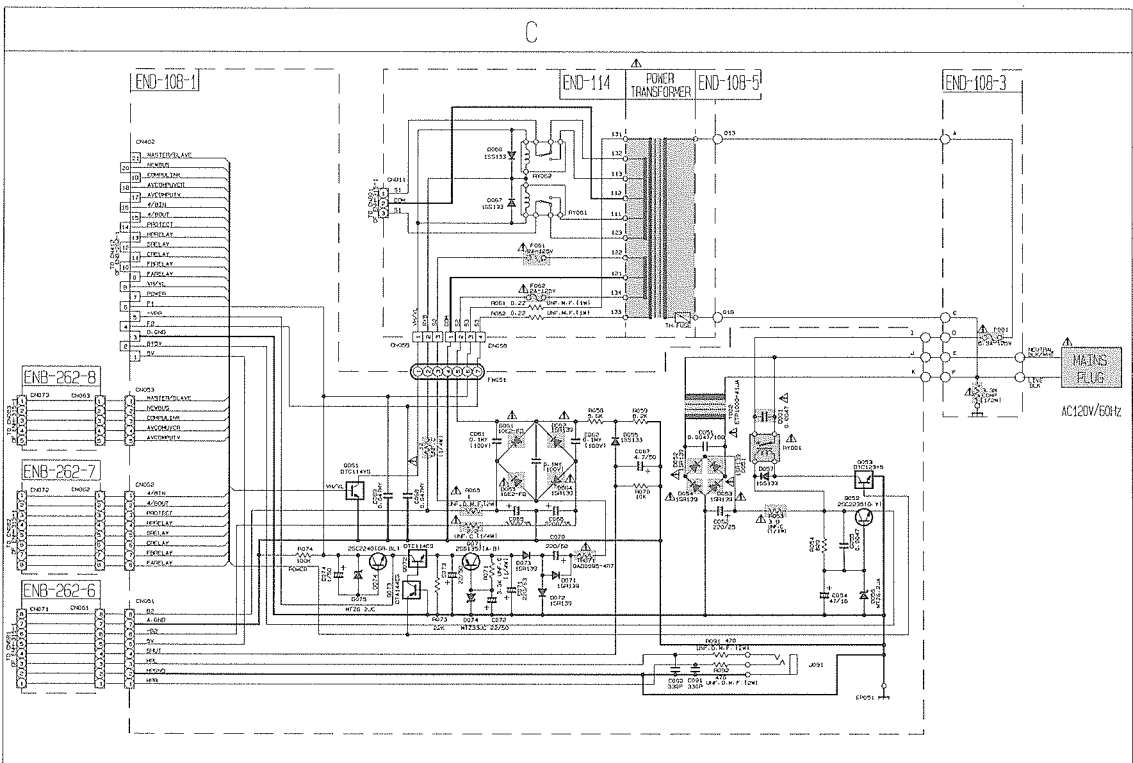

1

VERSION CODES	
EN:	NORDIC COUNTRIES
E:	CONTINENTAL EUROPE
B:	U. K.
C:	CANADA
J:	U. S. A.
US:	SINGAPORE
UT:	TAIWAN
UF:	CHINA
U:	UNIVERSAL EXCEPT ALL OF ABOVE

SHEET NUMBER	CIRCUIT DESCRIPTION
1/11	PRIMARY / RECTIFIER
2/11	VOLUME (FRONT/CENTER/REAR ch.) / SEA / SOURCE SELECT IC
3/11	AUDIO AMP (FRONT ch.1 / SPEAKER TERMINAL (FRONT ch.1) / REGULATOR / RECTIFIER
4/11	AUDIO AMP (CENTER/REAR ch.1) / SPEAKER TERMINAL (CENTER/REAR ch.1)
5/11	AUDIO SIGNAL INPUT TERMINAL / SOURCE SELECT IC / SYSTEMCONTROL SIGNAL TERMINAL
6/11	VIDEO SIGNAL INPUT TERMINAL / SOURCE SELECT IC
7/11	USER CONTROL KEYS / SYSTEMCONTROL LSI / FL DISPLAY
8/11	SUBROUND IC / DIGITAL SIGNAL INPUT TERMINAL
9/11	TUNER (ONLY C/D)
10/11	TUNER (ONLY B/E/EN)
11/11	TUNER (ONLY W/LF/US/UT)

NOTES:
MARK (*) IS TO
DETAILS ARE I

EXPLANAT
RX-BE

U / UF / US / UT

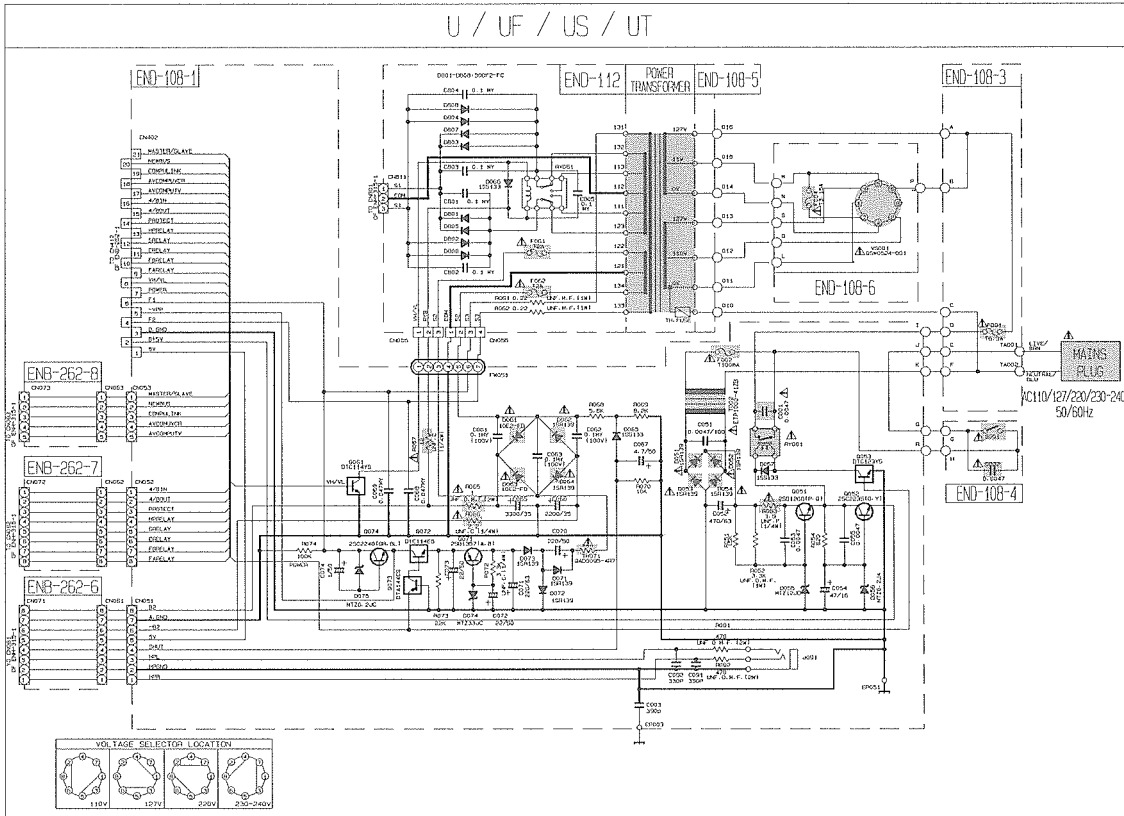

B / E / EN

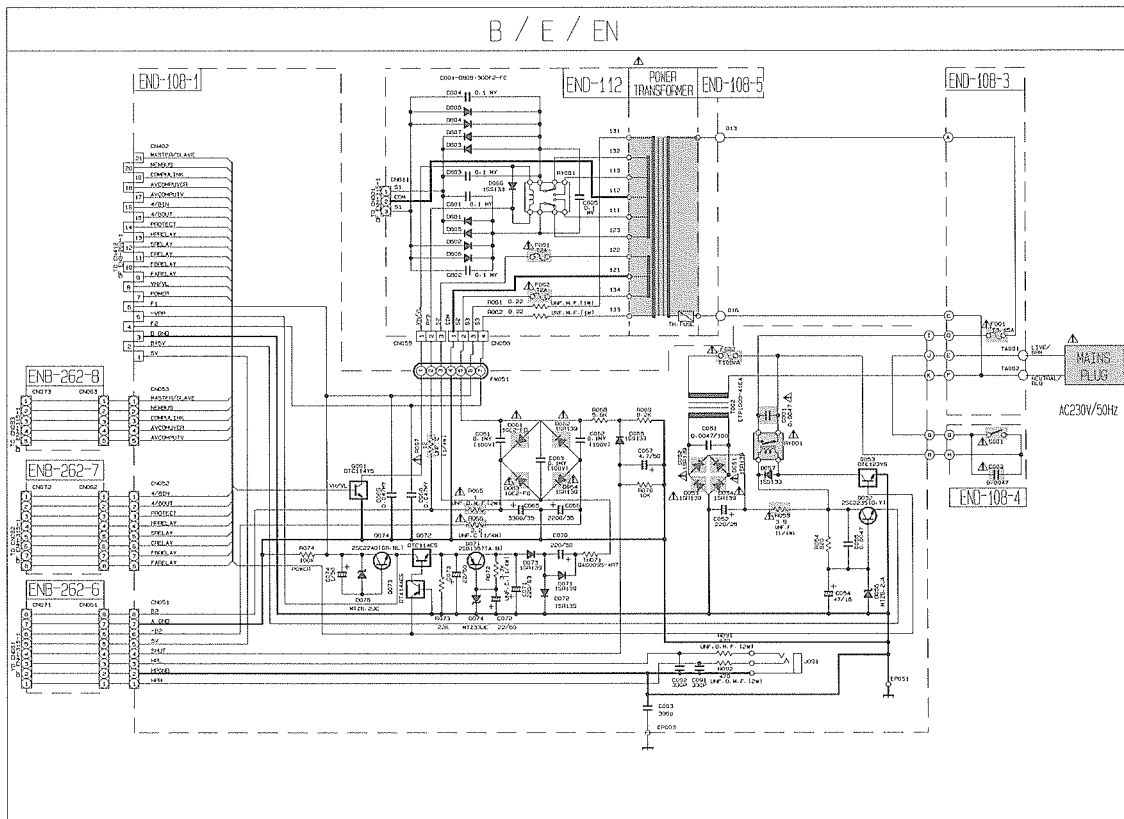

K(*) IS TO SHOW DEVIATION IN VERSIONS.

*TAILS ARE EXPLAINED NEAR THE MARK.

EXPLANATION OF OVERALL OF SCHEMA.

FX-BB4VBR/FX-BB4PBR/FX-BB4PBR/FX-BB4P6D

▲ Parts are safety assurance parts.
When replacing those parts make sure to use the specified one.

MAIN AMP. SECTION

5

4

3

2

1

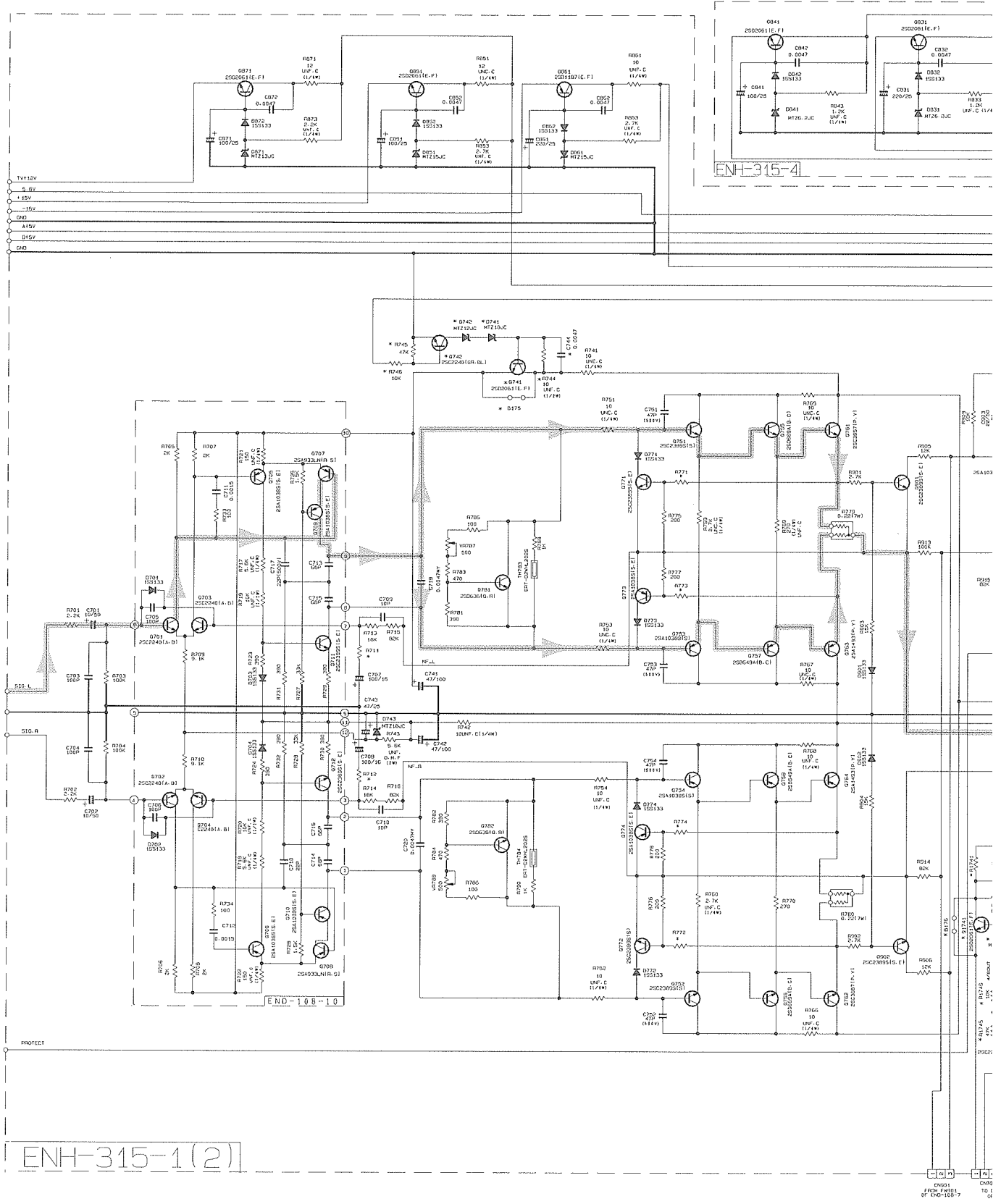

ENH-315-1(2)

A | B | C | D

FROM ENH-315-1 TO 1 OF ENH-103-1

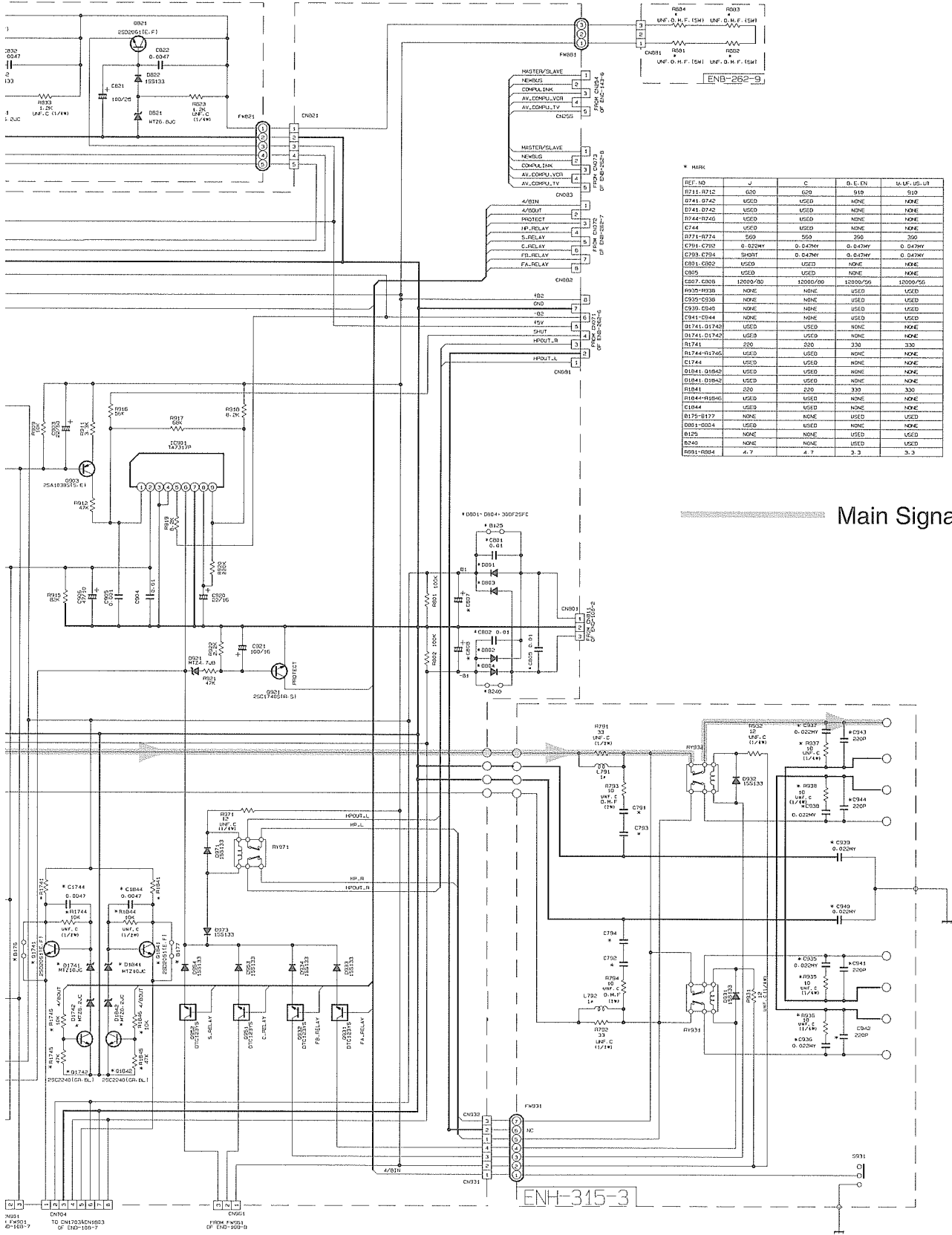

* MURC

REF. NO	Q	C	D, E, FN	U, V, US, U1
D711-D712	USED	USED	S19	S19
D741-D742	USED	USED	NONE	NONE
D741-D742	USED	USED	NONE	NONE
D744-D745	USED	USED	NONE	NONE
C744	USED	USED	NONE	NONE
D771-D774	500	500	330	330
C791-C792	0.025HY	0.047HY	0.047HY	0.047HY
C793-C794	500HT	0.047HY	0.047HY	0.047HY
C801-C802	USED	USED	NONE	NONE
C805	USED	USED	NONE	NONE
C807-C808	12000/50	12000/50	12000/50	12000/50
R939-R939	NONE	NONE	USED	USED
C939-C939	NONE	NONE	USED	USED
C939-C940	NONE	NONE	USED	USED
C941-C944	NONE	NONE	USED	USED
D1741-D1742	USED	USED	NONE	NONE
D1741-D1742	USED	USED	NONE	NONE
R1741	330	330	330	330
R1744-R1745	USED	USED	NONE	NONE
C1744	USED	USED	NONE	NONE
D1841-D1842	USED	USED	NONE	NONE
D1841-D1842	USED	USED	NONE	NONE
R1841	330	330	330	330
R1844-R1845	USED	USED	NONE	NONE
C1844	USED	USED	NONE	NONE
D1844	USED	USED	NONE	NONE
R1875-R1877	NONE	NONE	USED	USED
D851-D854	USED	USED	NONE	NONE
R125	NONE	NONE	USED	USED
R140	NONE	NONE	USED	USED
R881-R884	4.7	4.7	3.3	3.3

Main Signal

ENH-315-3

REAR / CENTER AMP. SECTION

END-108-7

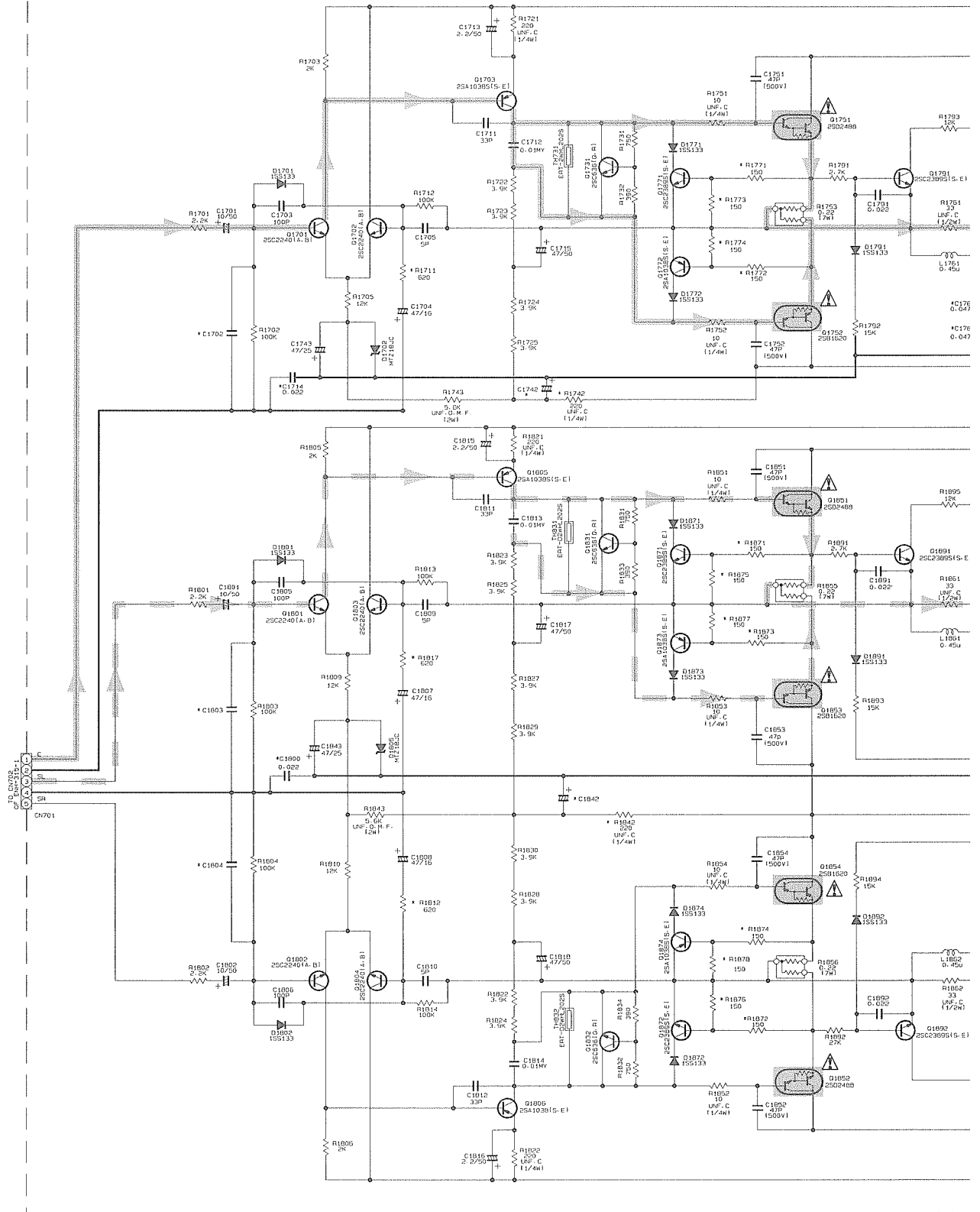

A

B

C

3-6

D

AUDIO SELECTOR SECTION

5

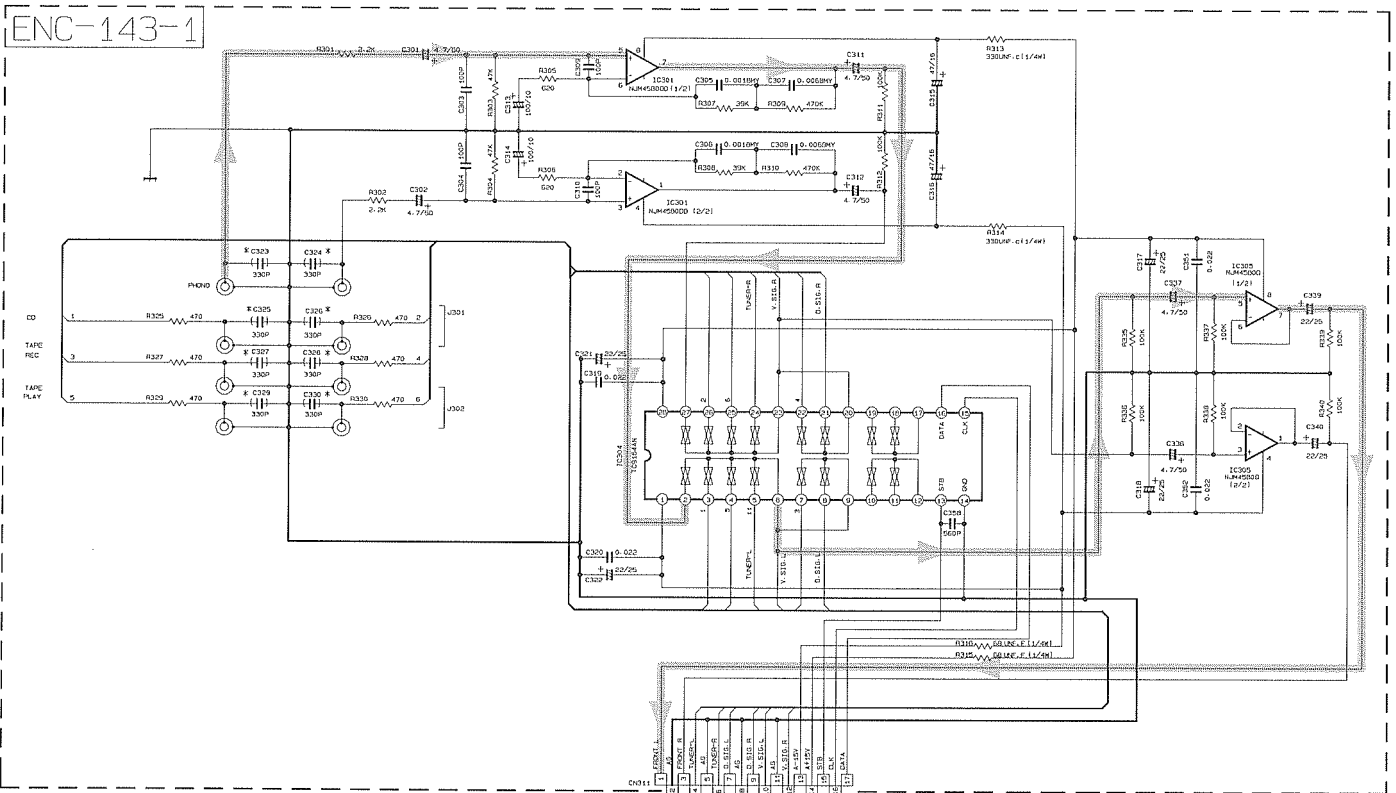

TO CN001
OF ENC-316-1

4

3

2

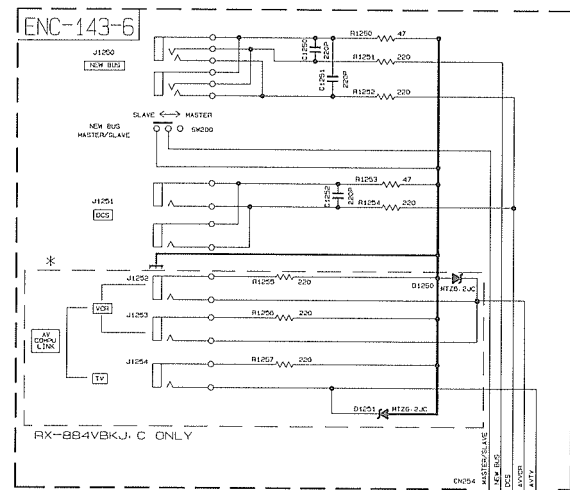

RX-884VBKJ, C ONLY

TO CN005
OF ENC-316-1

* MARK LIST

	RX-884RBK
	B. E. EN
	C323-C330 USED
	C377-C386 USED

RX-884VE

1

A

B

C

D

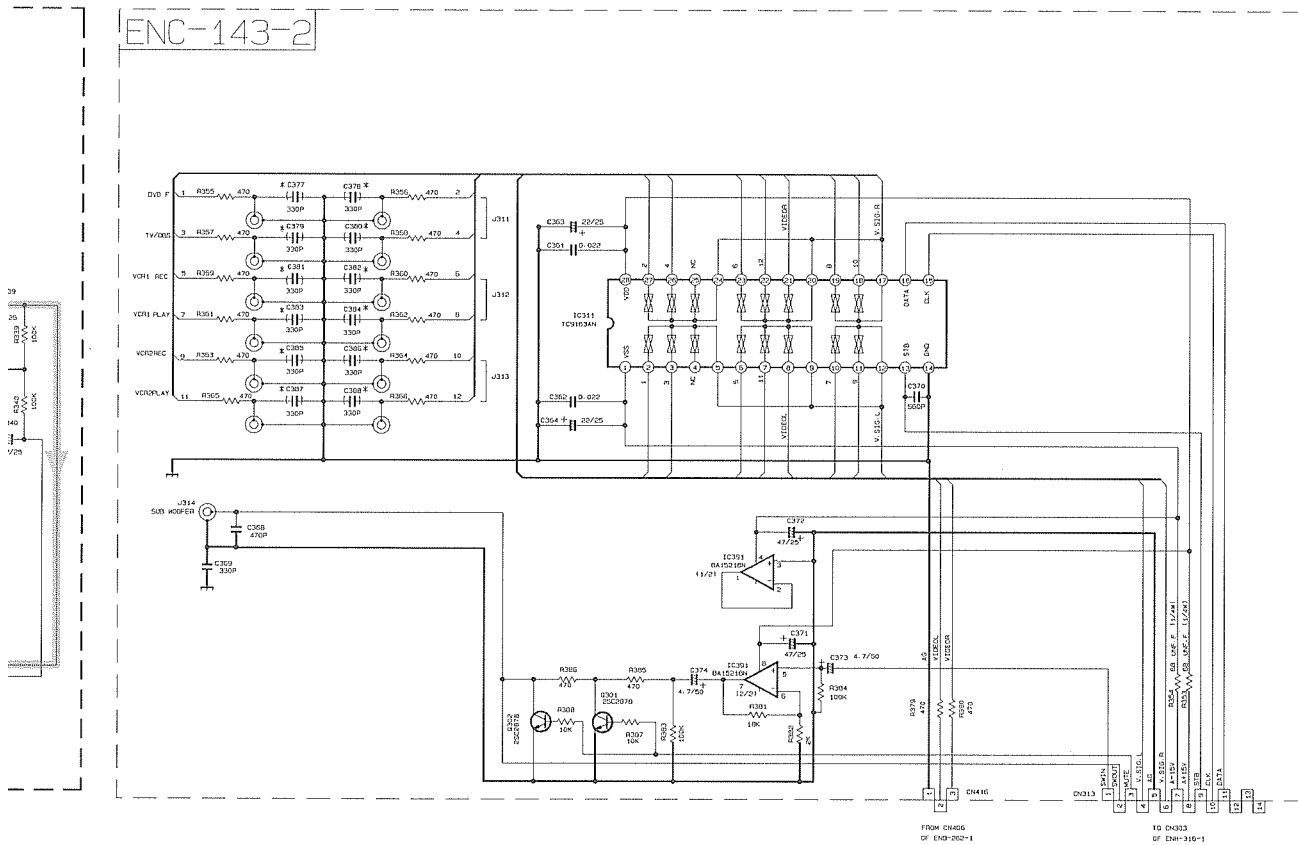

T

X-884RBK	RX-884VBK	RX-884PBK	RX-884PGD
B. E. EN	J. C. U. UT	U. U.F. US. UT	UF
USED	NONE	NONE	NONE
USED	NONE	NONE	NONE

X-884VBKJ. C ONLY

Main Signal

VIDEO SECTION

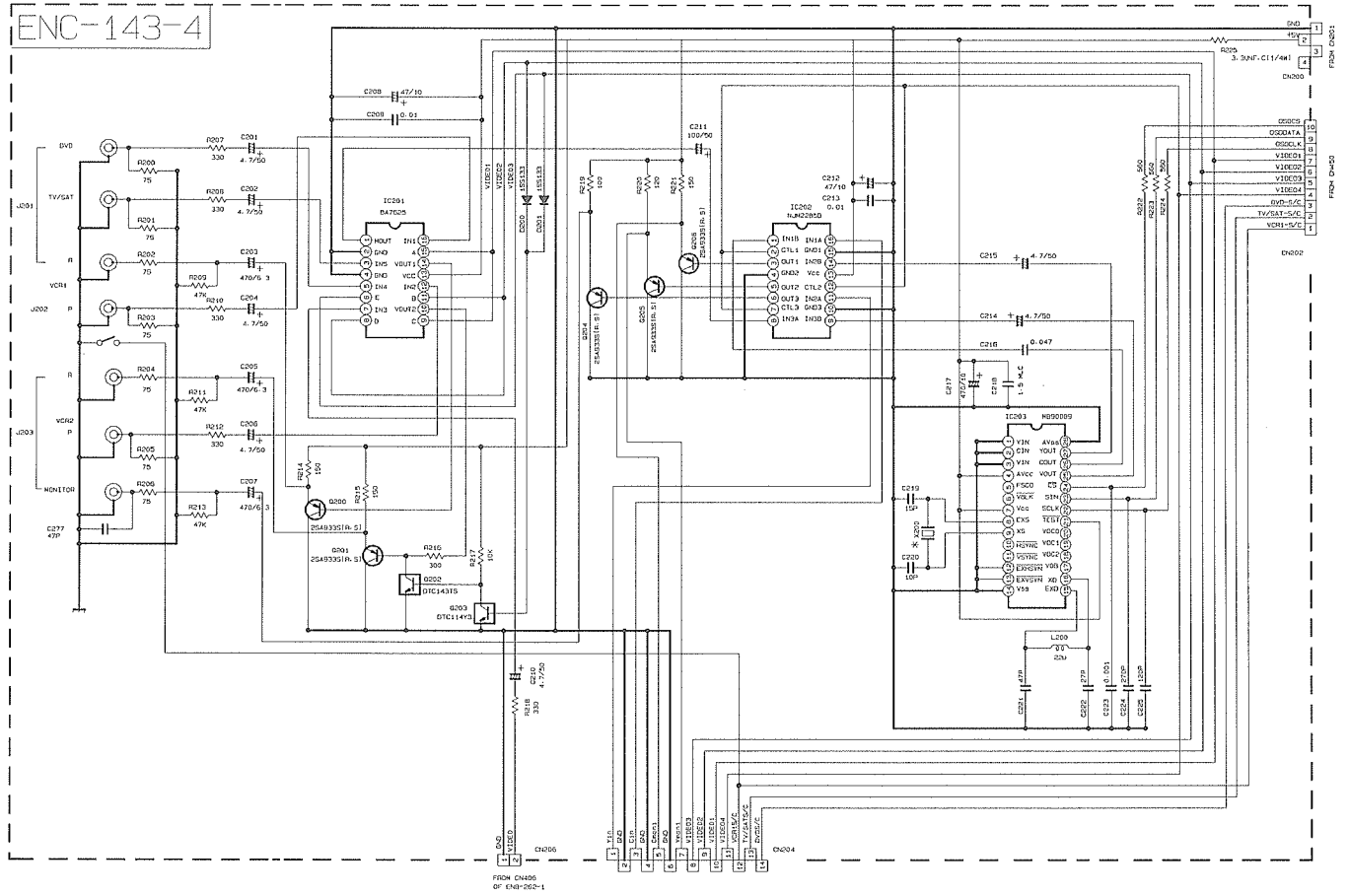

FROM CN486
OF CN487-1

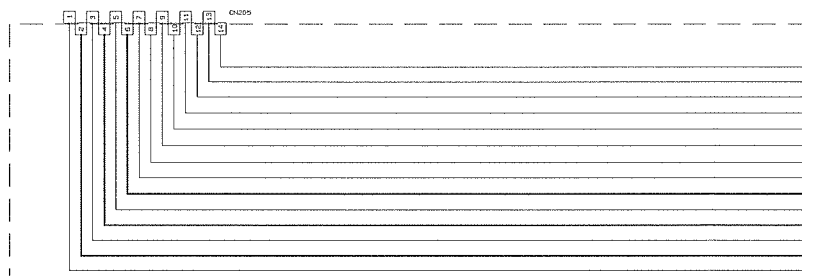

*MARK LIST

	RX-884VBK
	J. C. U. UT
X200	0AX0260-00

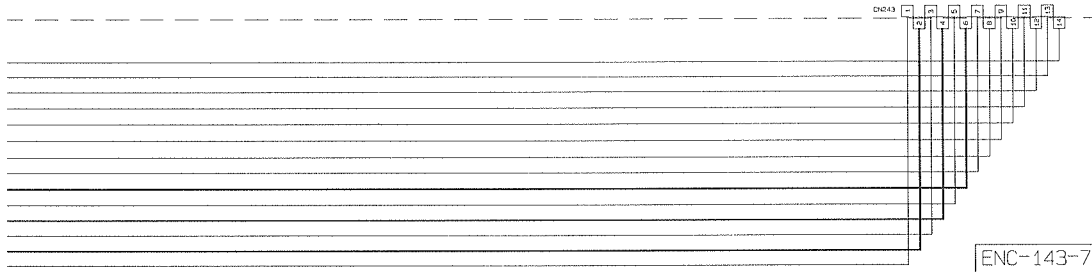
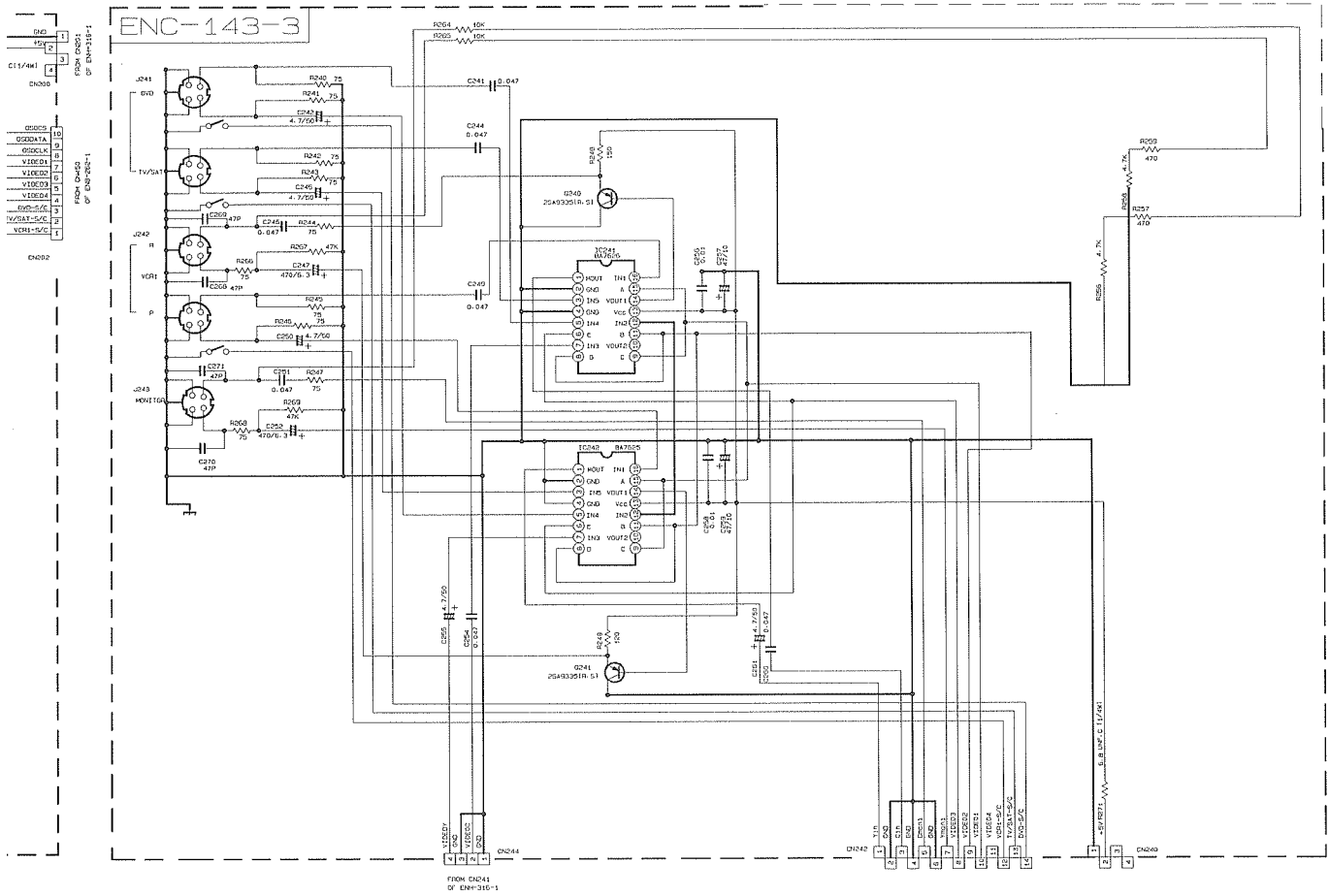

184VBK	RX-884RBK	RX-884PGD	RX-884PBK
U. UT	B. E. EN	U. UF. US. UT	UF
60-001Z	QAX0261-001Z	QAX0261-001Z	QAX0261-001Z

VOLUME CONTROL SECTION

5

4

3

2

1

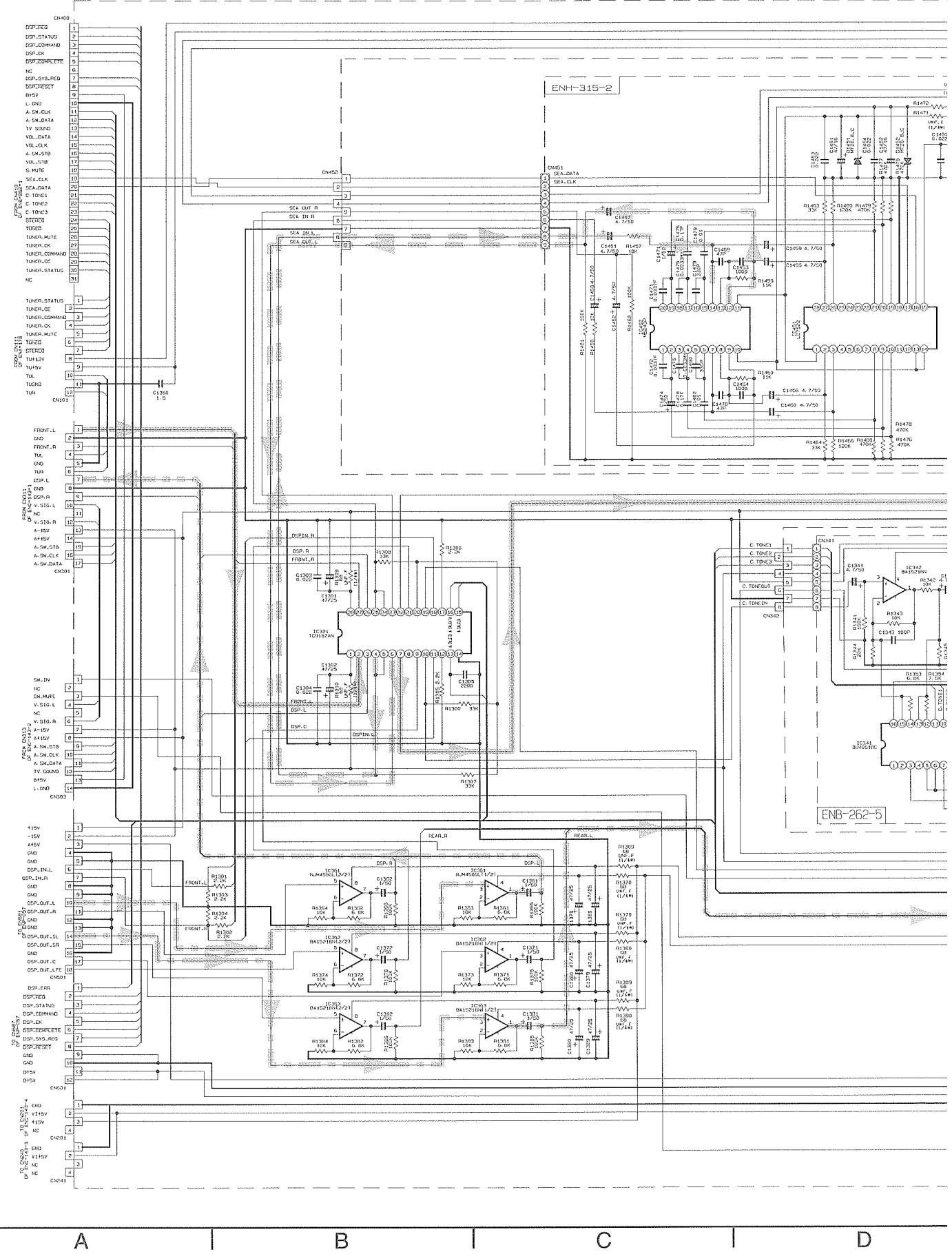

A | B | C | D

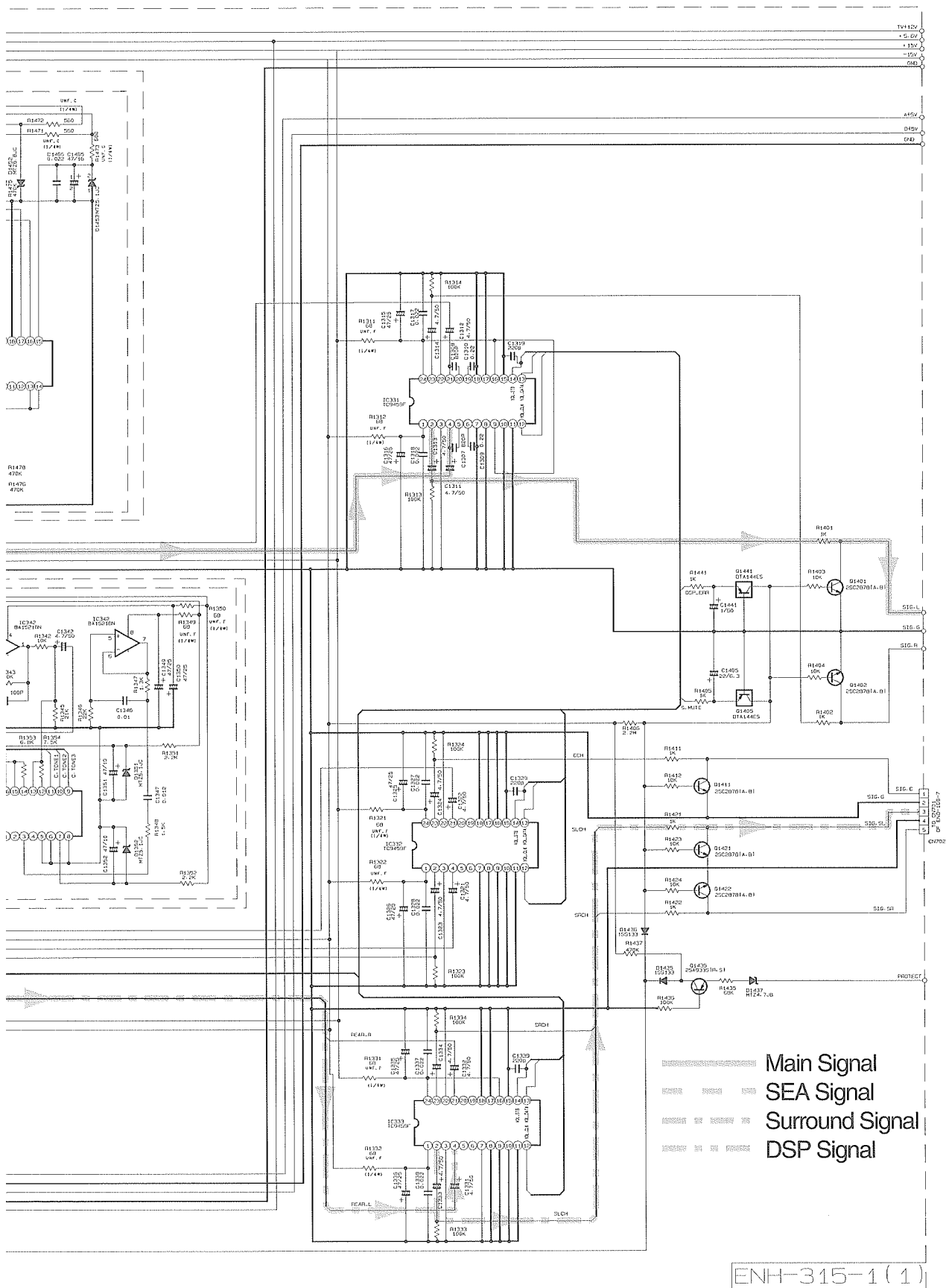

FL DISPLAY SECTION

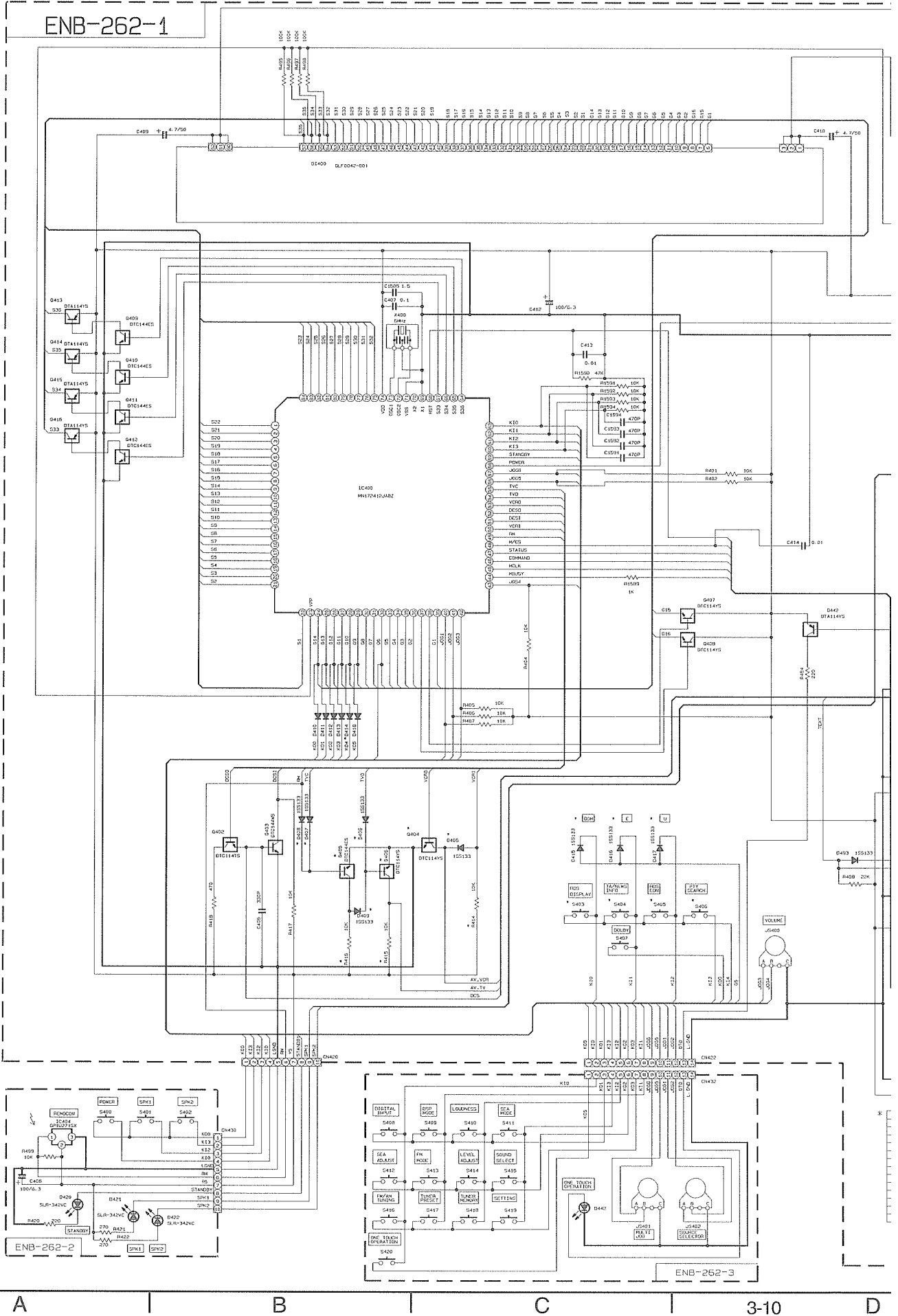

5

4

3

2

1

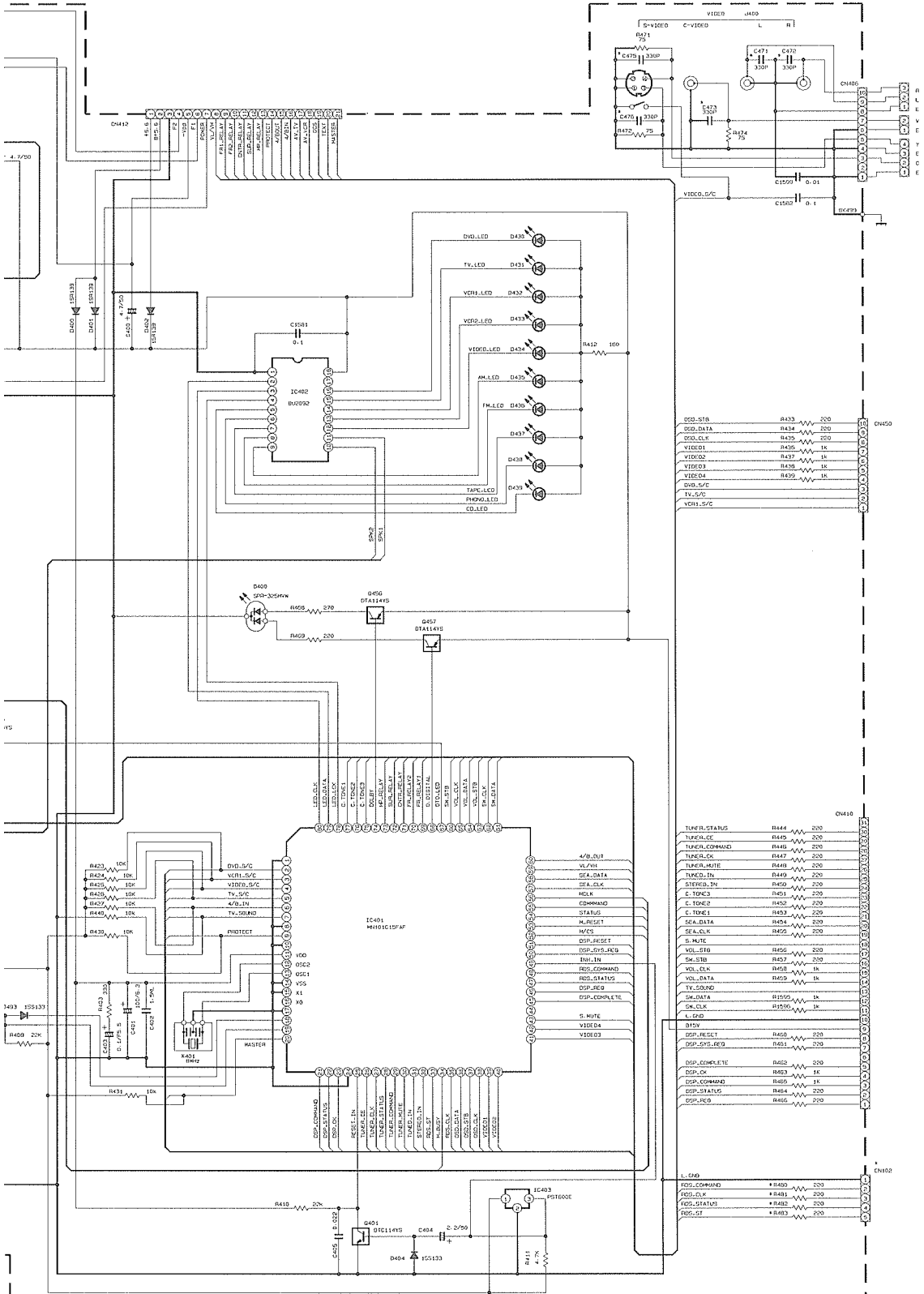

- VIDEO_S/C R433 200
- VIDEO_DATA R434 200
- VIDEO_CLK R435 200
- VIDEO1 R436 1K
- VIDEO2 R437 1K
- VIDEO3 R438 1K
- VIDEO4 R439 1K
- VIDEO_S/C
- VIDEO_L/C
- VIDEO_S/C

- TUNER_STATUS R444 200
- TUNER_L2 R445 200
- TUNER_COMMAND R446 200
- TUNER_CLK R447 200
- TUNER_WRITE R448 200
- TUNER_IN R449 200
- STEREO_IN R450 200
- C_TONE2 R451 200
- C_TONE1 R452 200
- SEA_DATA R453 200
- S_MUTE R454 200
- SEA_CLK R455 200
- VOL_BUG R456 200
- Sm_STB R457 200
- SEA_DATA R458 1K
- VOL_DATA R459 1K
- TV_SOUND R460 1K
- SEA_DATA R461 1K
- SEA_CLK R462 1K
- SmV R463 200
- DSP_RESET R464 200
- DSP_RESET R465 200
- DSP_COMPLETE R466 200
- DSP_CLK R467 1K
- DSP_COMMAND R468 1K
- DSP_STATUS R469 200
- DSP_RESET R470 200

VER.	COM.	ΔC	C-EN-B	LS-UT	VER. LS-UT
EN103	NO	NO	YES	NO	NO
EN103-3	NO	NO	YES	NO	NO
D414	NO	NO	YES	NO	NO
D415	NO	NO	YES	NO	NO
D416	YES	NO	NO	YES	YES
D417	NO	NO	NO	YES	NO
D403-0	NO	NO	YES	NO	NO
D404-0	YES	YES	NO	NO	NO
D405-0	YES	YES	NO	NO	NO
D414-0	YES	YES	NO	NO	NO
C471-2	NO	NO	YES	NO	NO
C473	NO	NO	YES	NO	NO
C475-16	NO	NO	YES	NO	NO

DSP SECTION

5

4

3

2

1

A

B

C

D

R501, R520 * N96009-007
 R521, R522 * N96009-007
 R561, R562 * N96009-007
 R581, R582 * N96009-007
 R591, R592 * N96009-007
 R595, R596 * 203

IC601
 CS4226-KQ

IC61
 11-2058312

IC671
 PH17320JAMP1

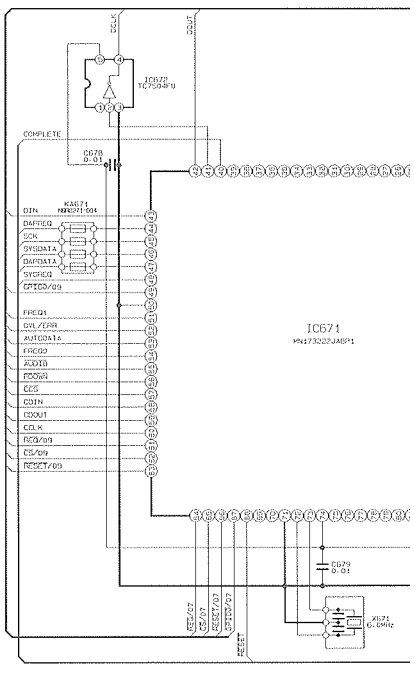
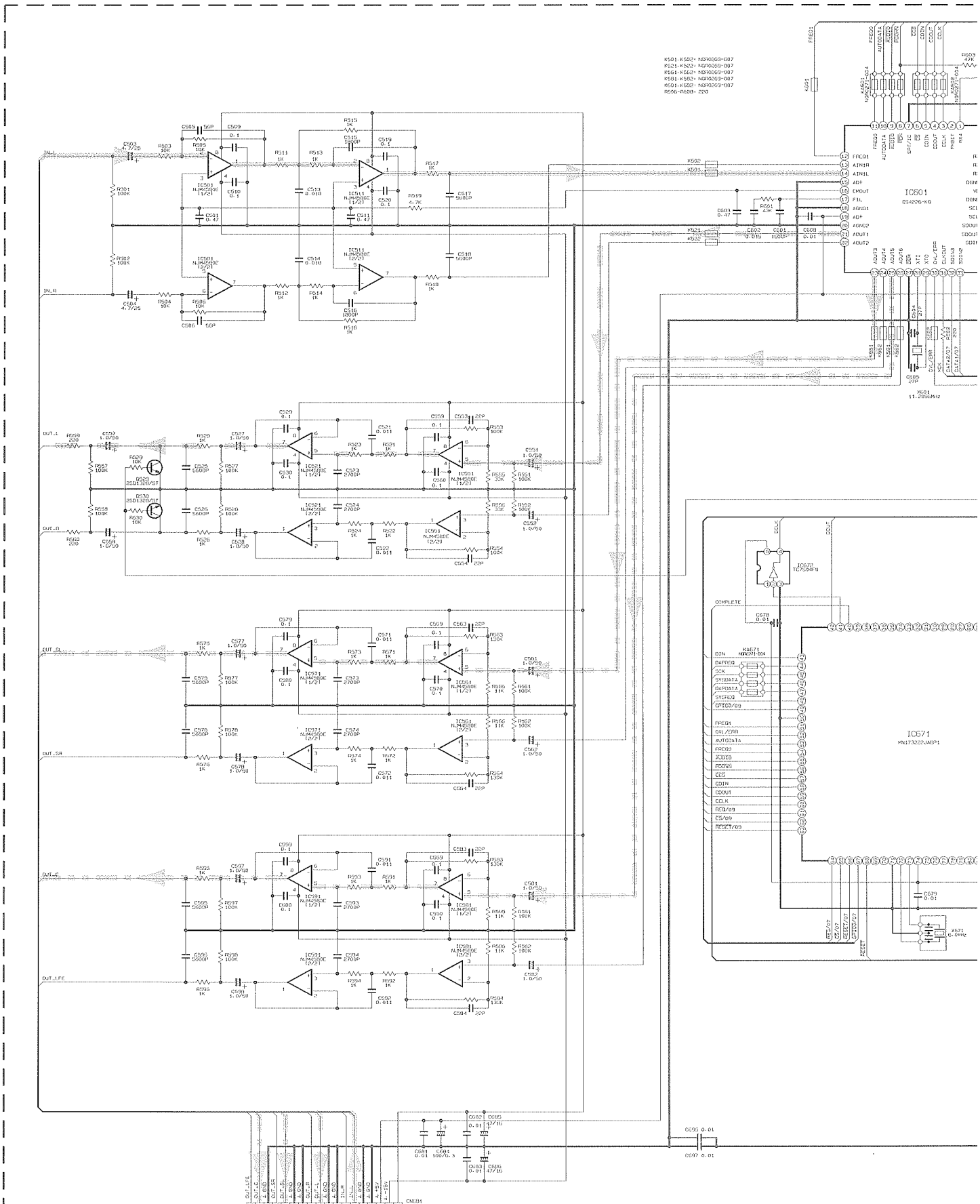

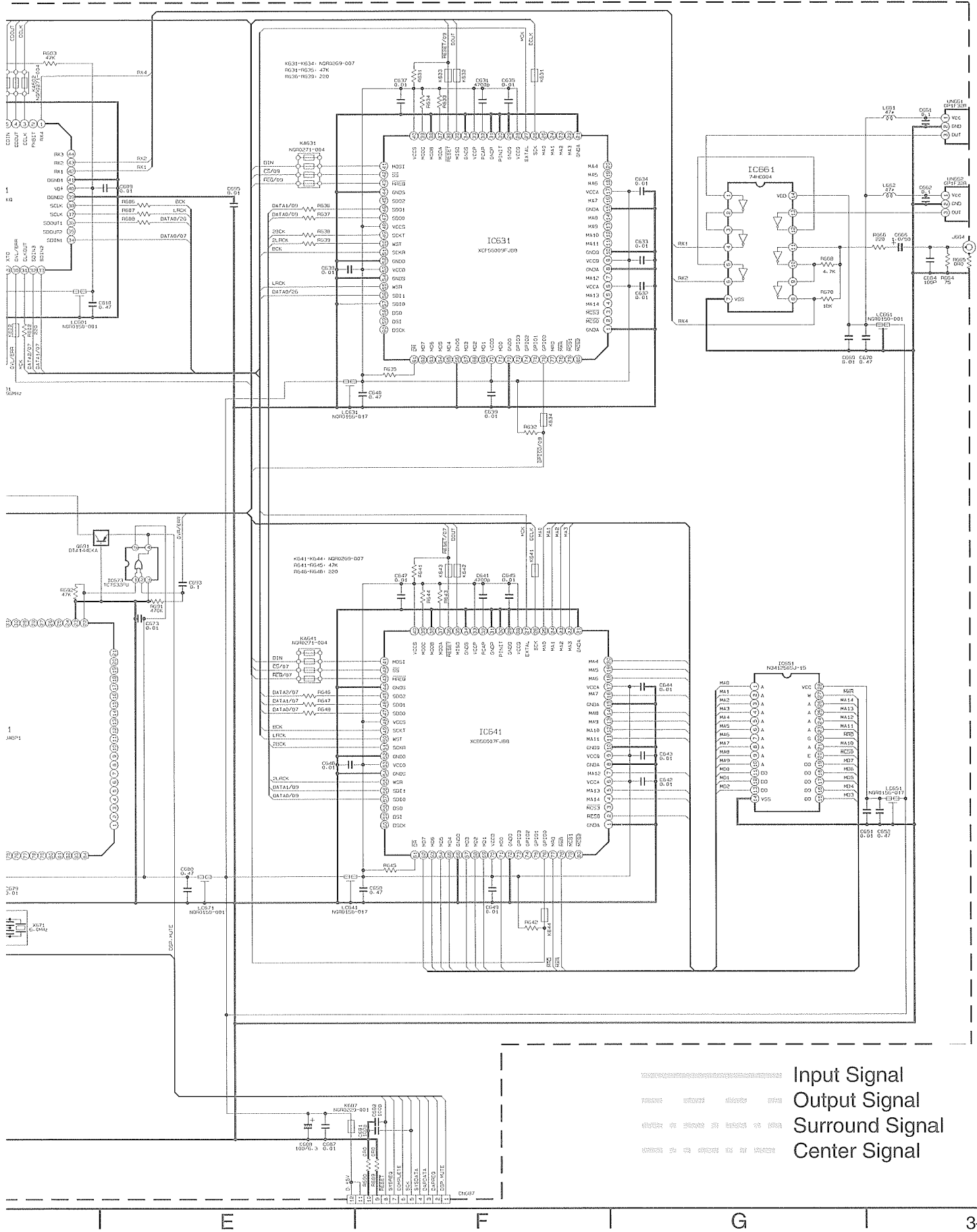

■ TUNER SECTION

FOR U, UF, UT, US
ENA-178

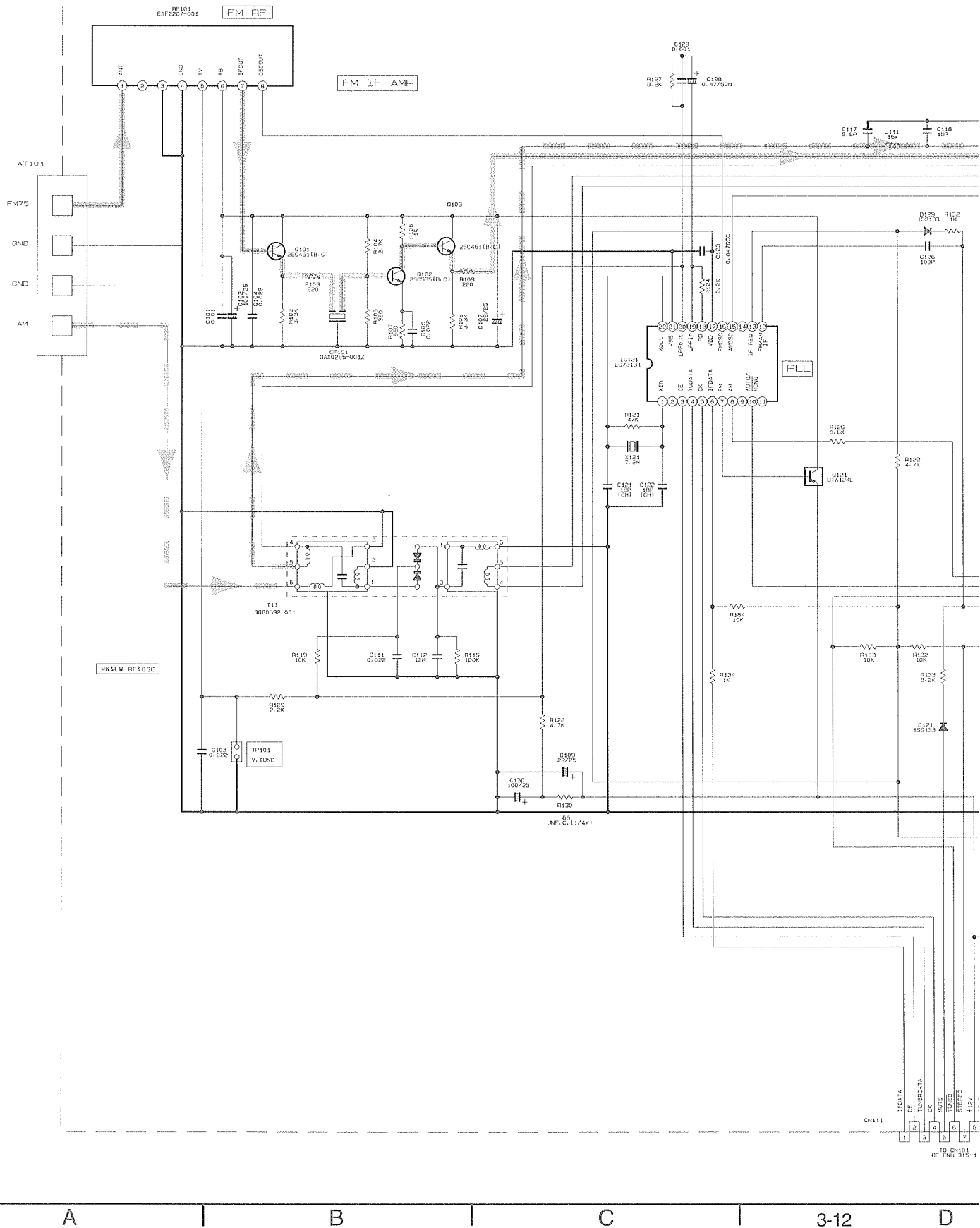

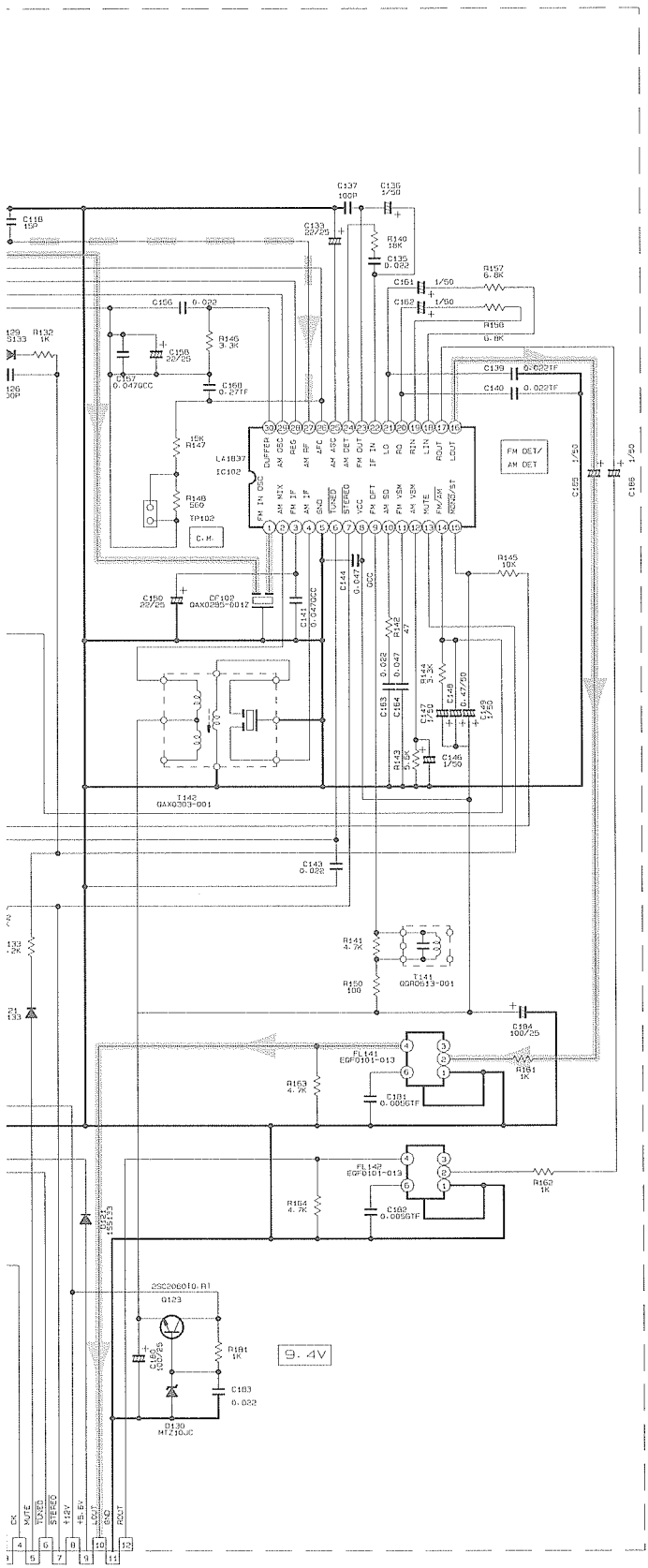

RF 101
EAF2207-001

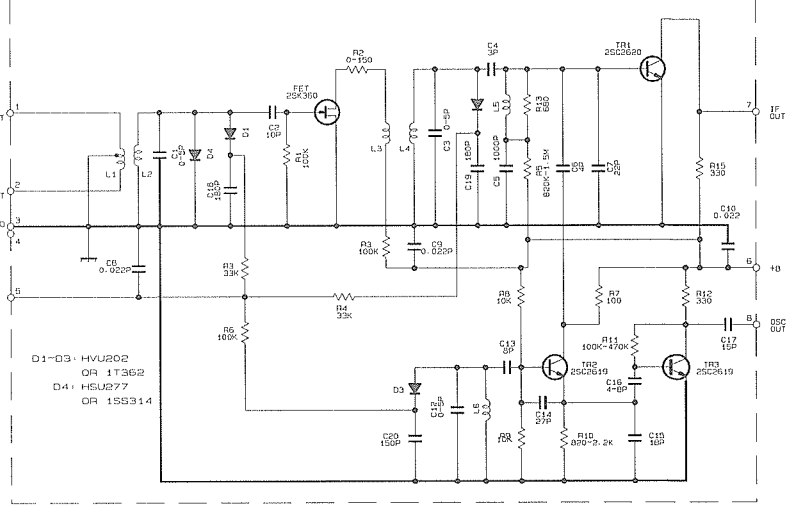

FM Signal
 AM Signal

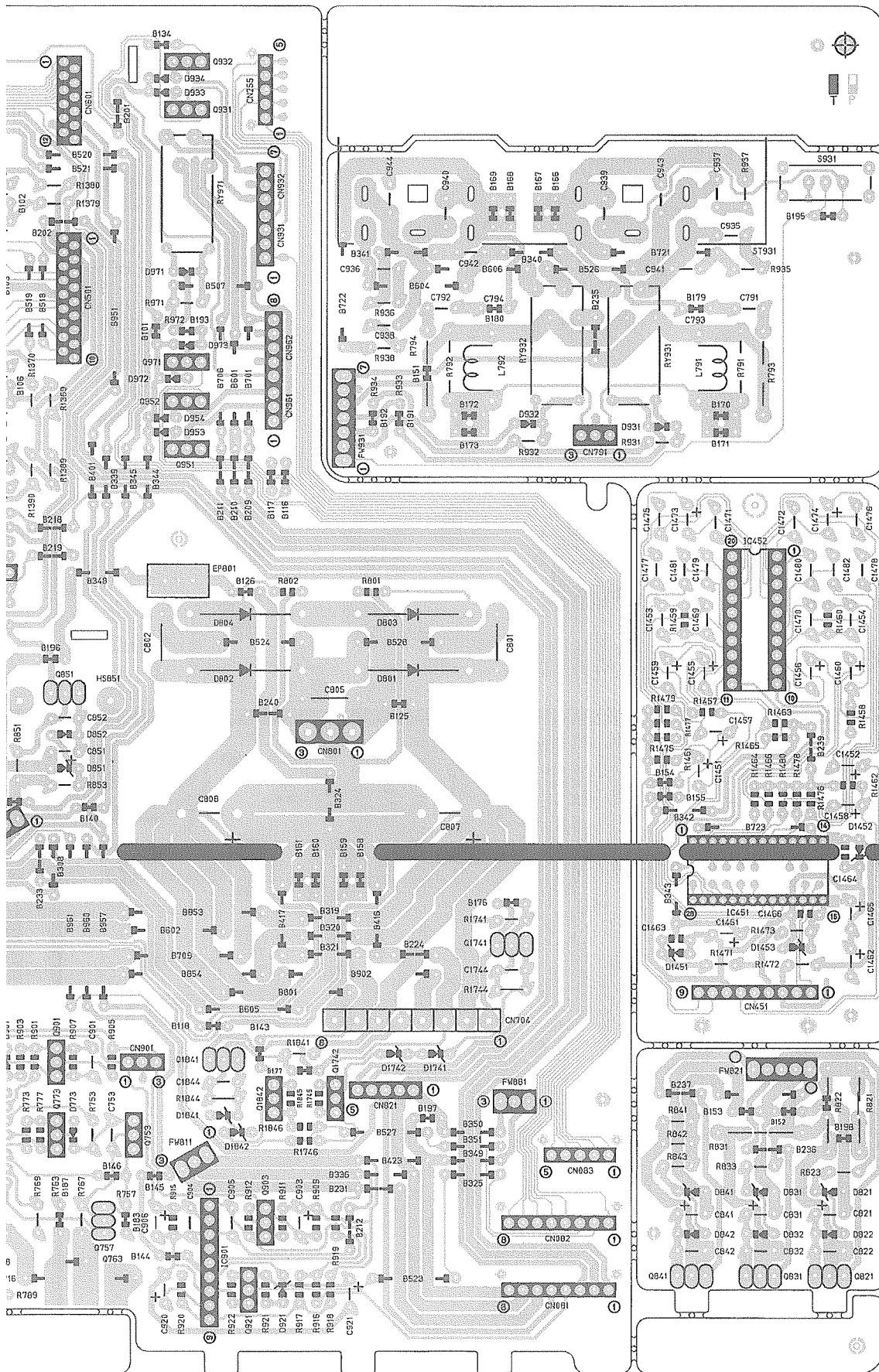

E

F

G

■ Front P.C. Board

5

4

3

2

1

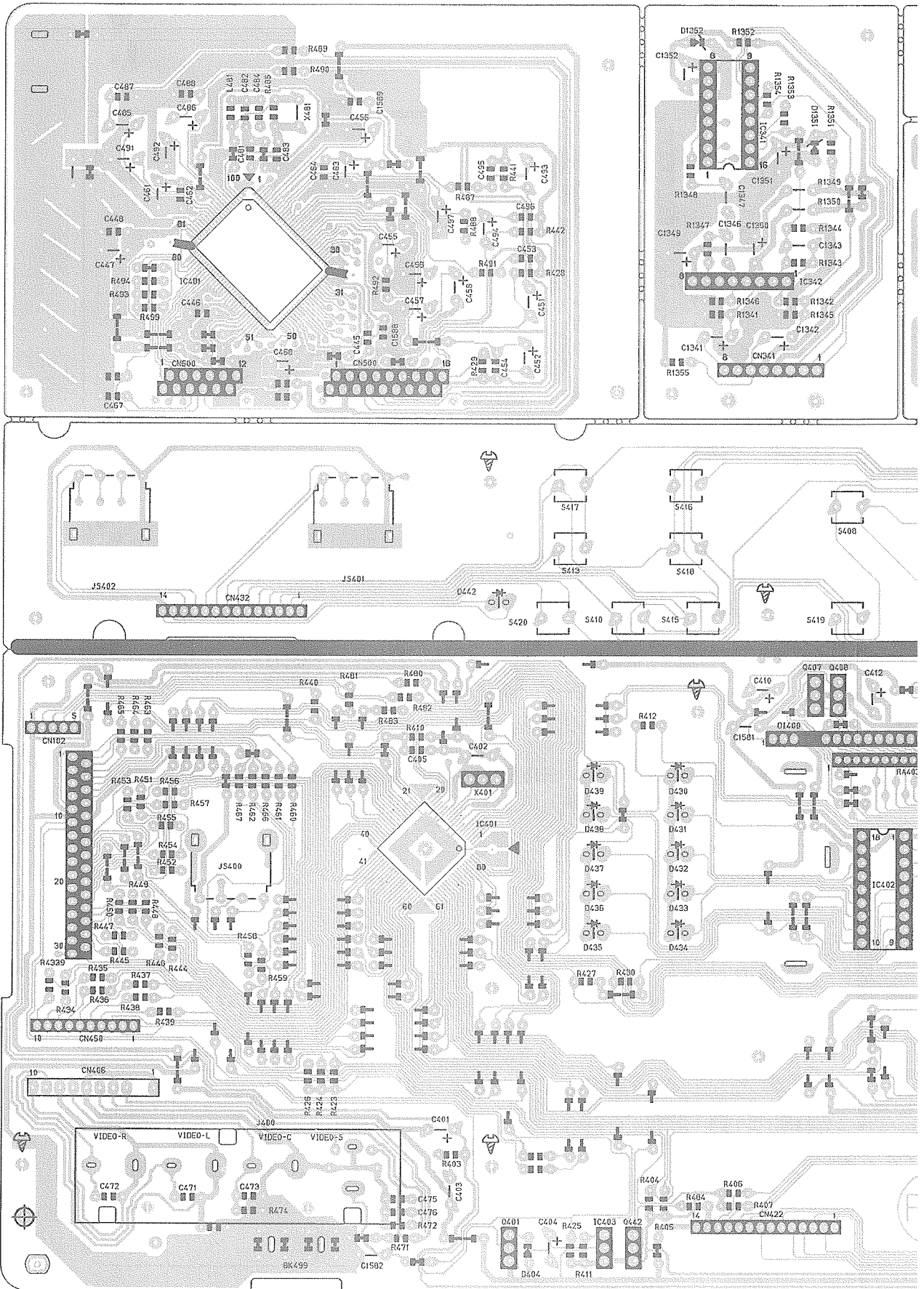

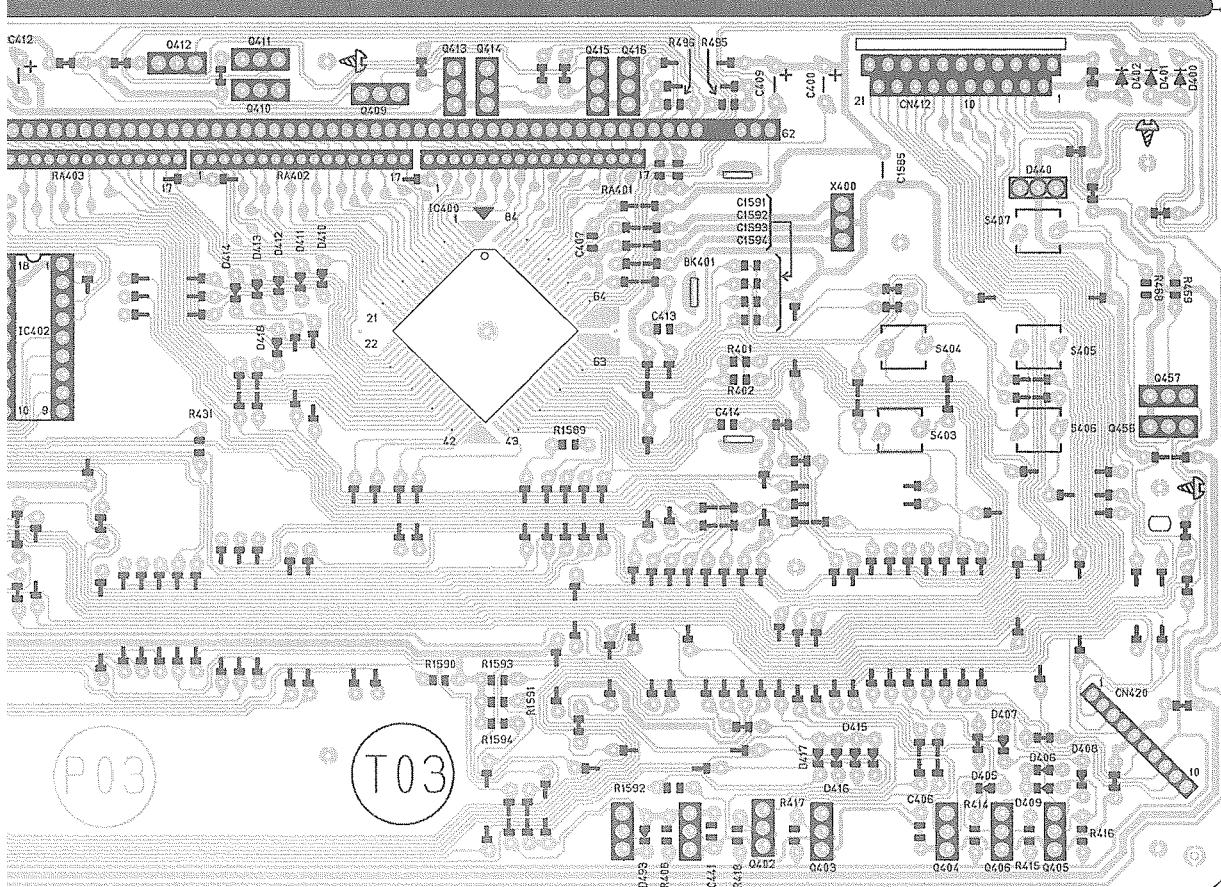
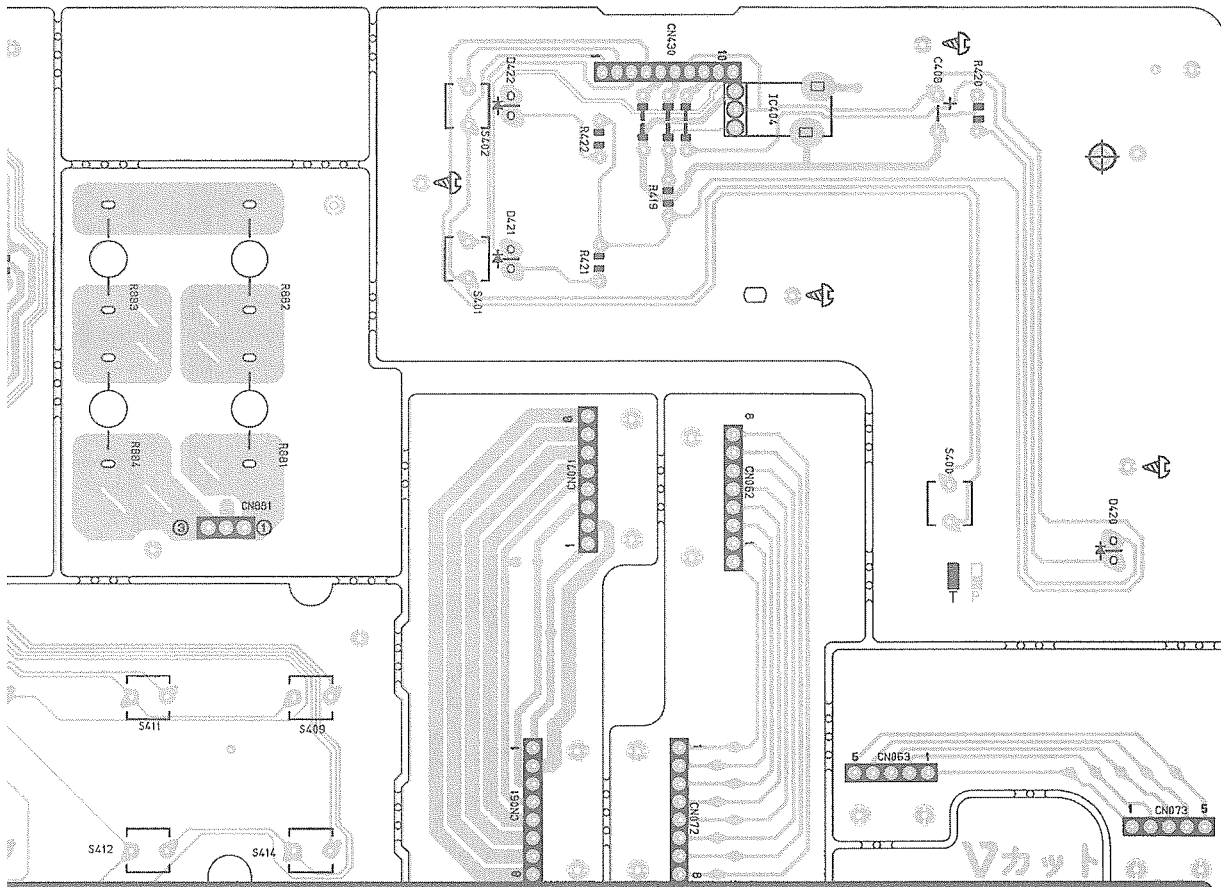

■ AC-3 P.C. Board

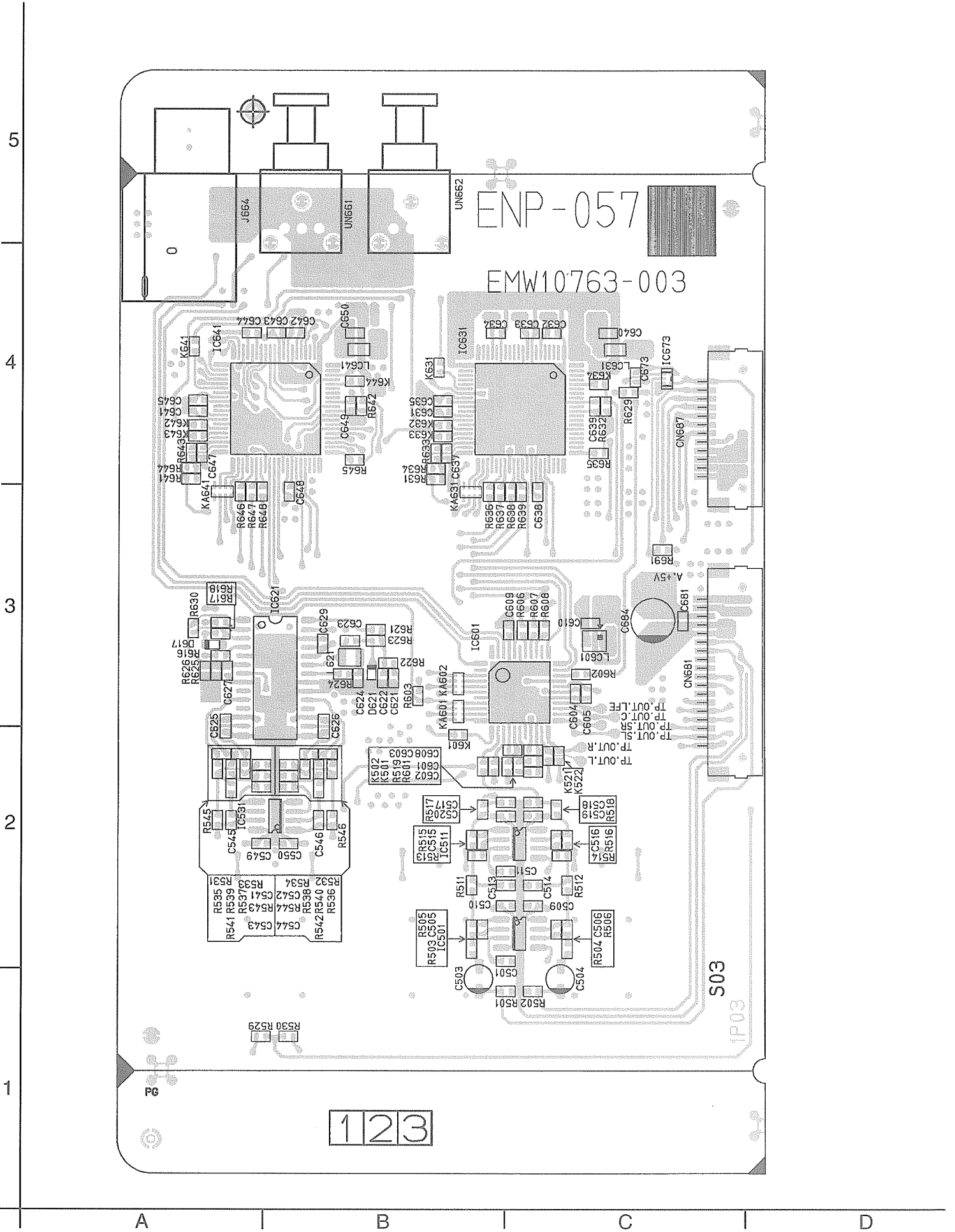

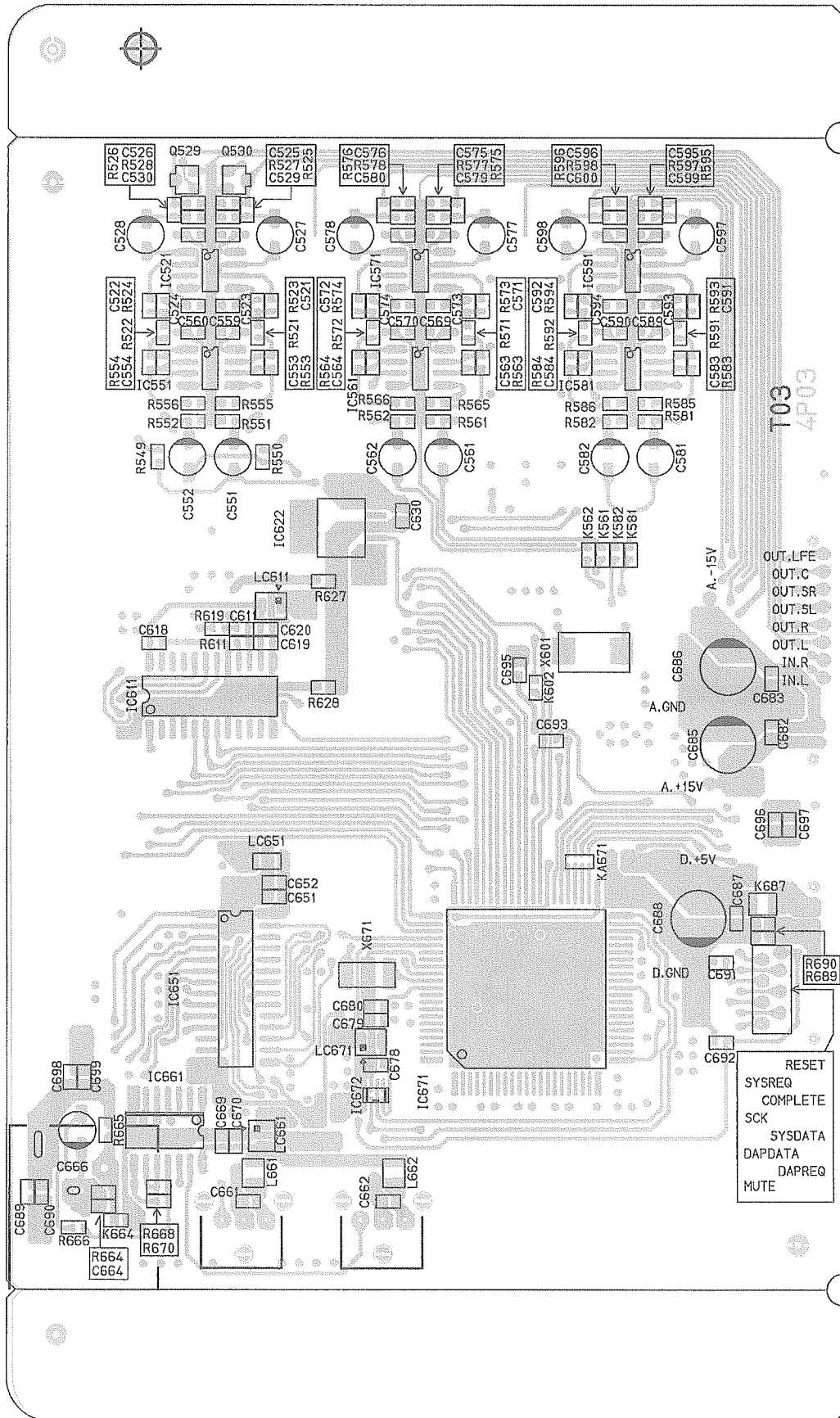

■ Control P.C. Board

5

4

3

2

1

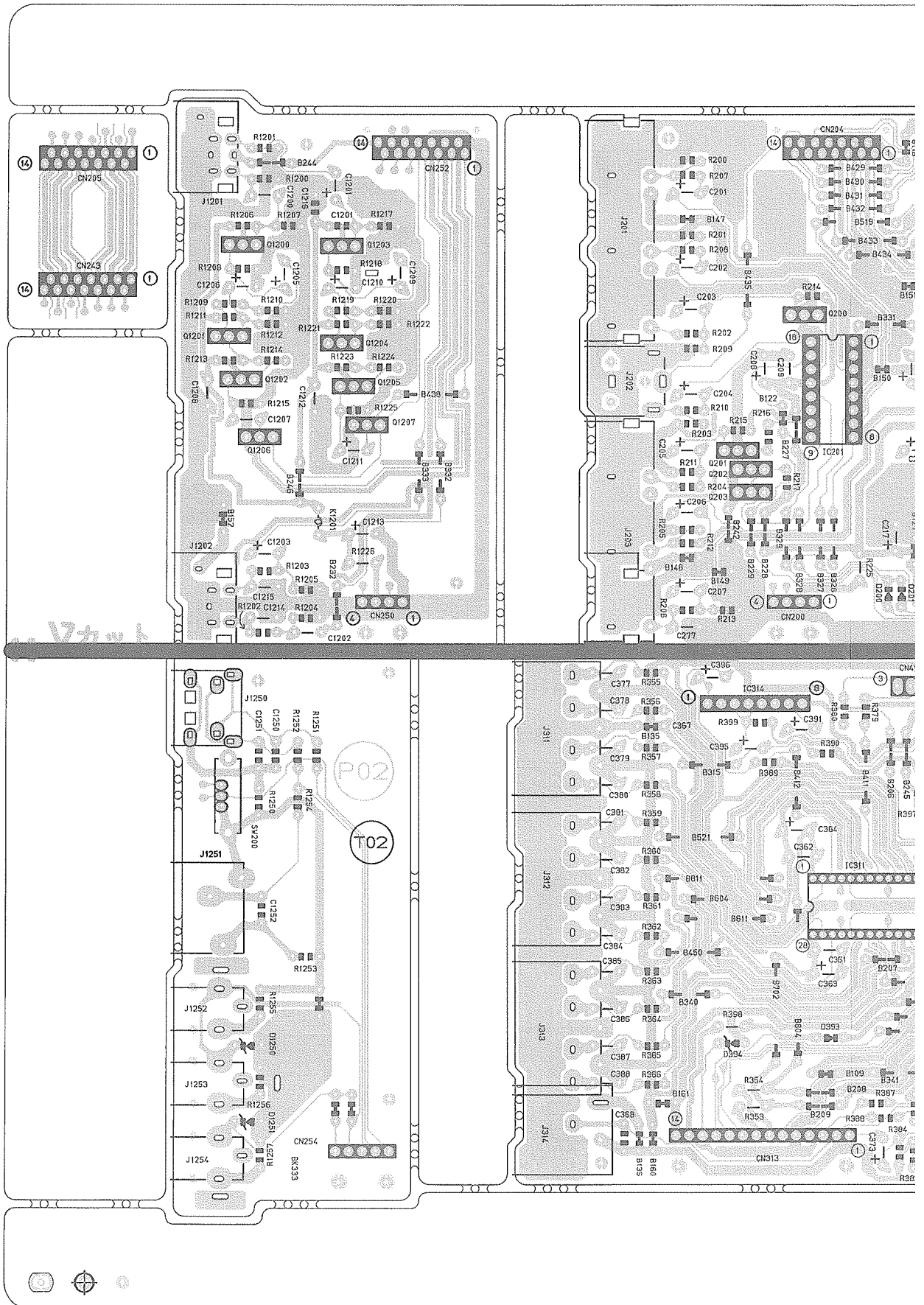

A

B

C

3-16

D

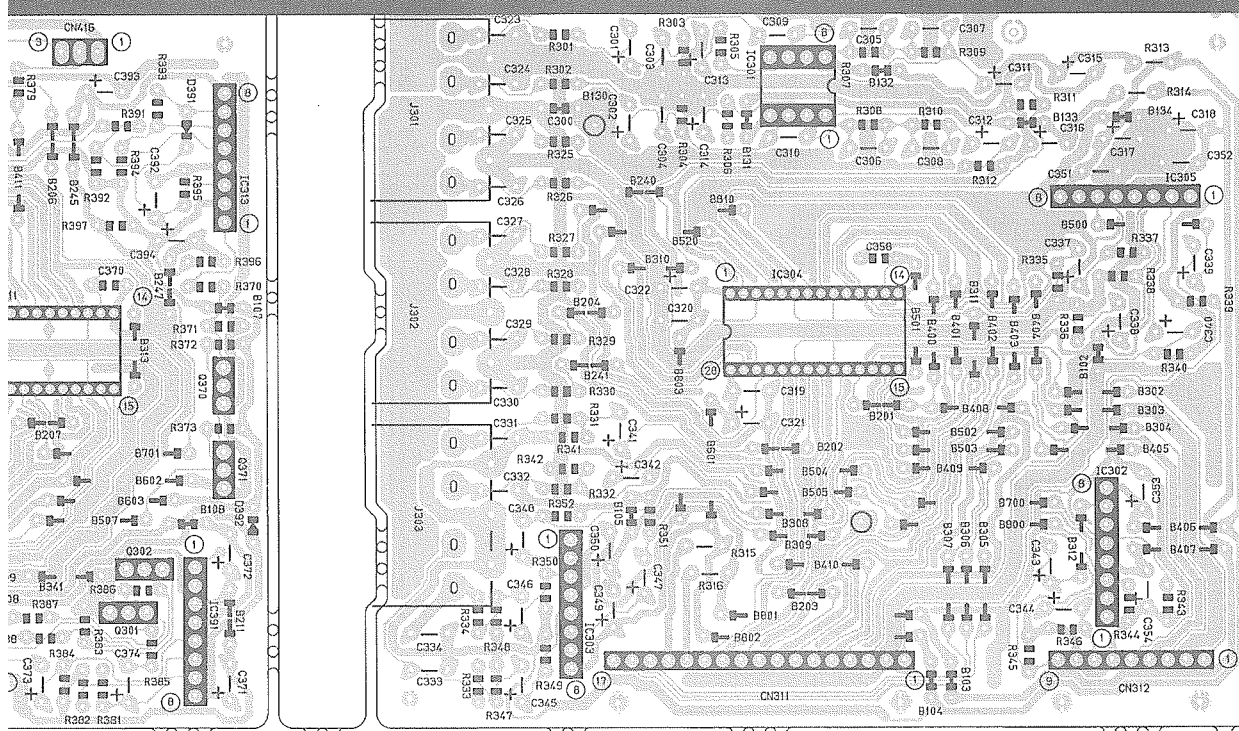
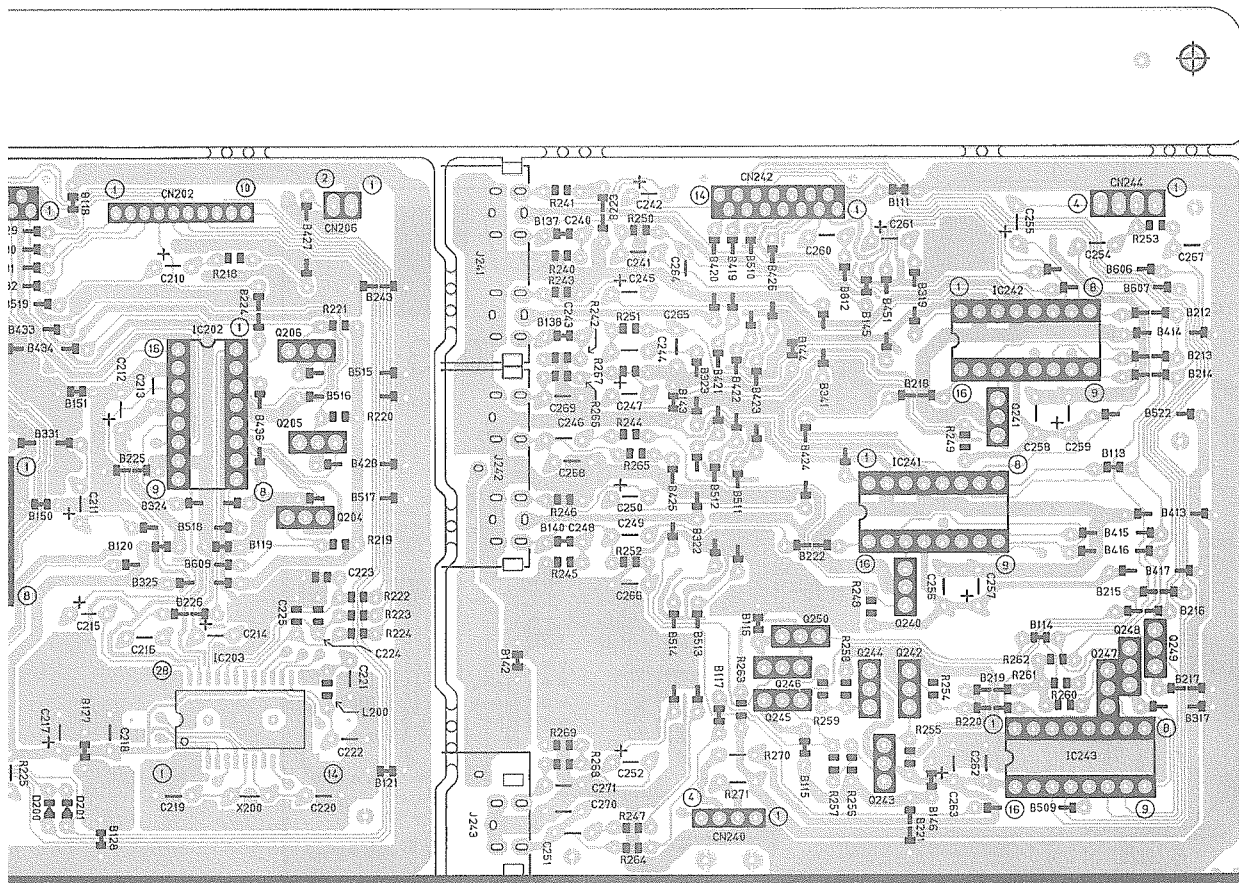

D | E | F | G | H

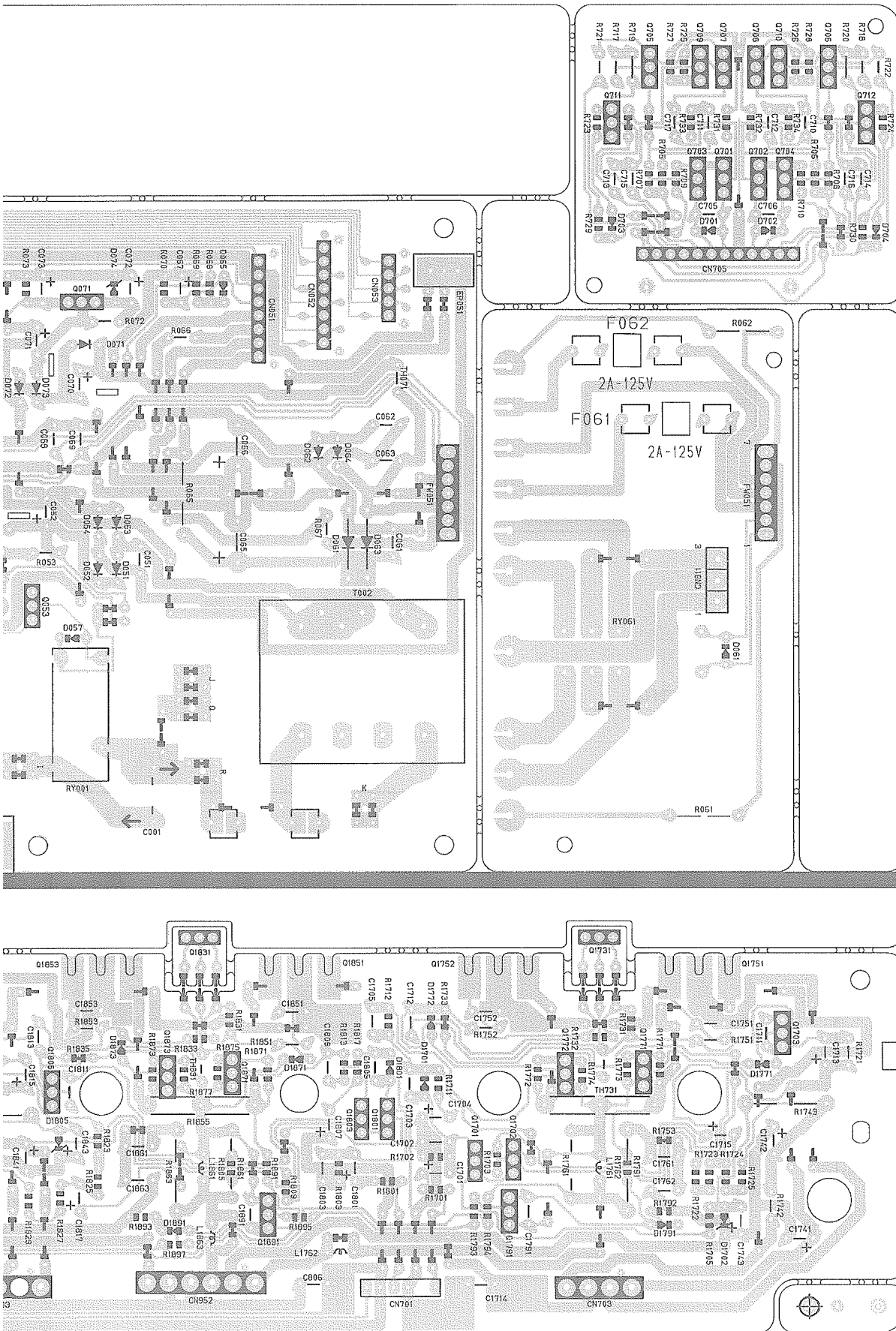

■ Tuner PC Board

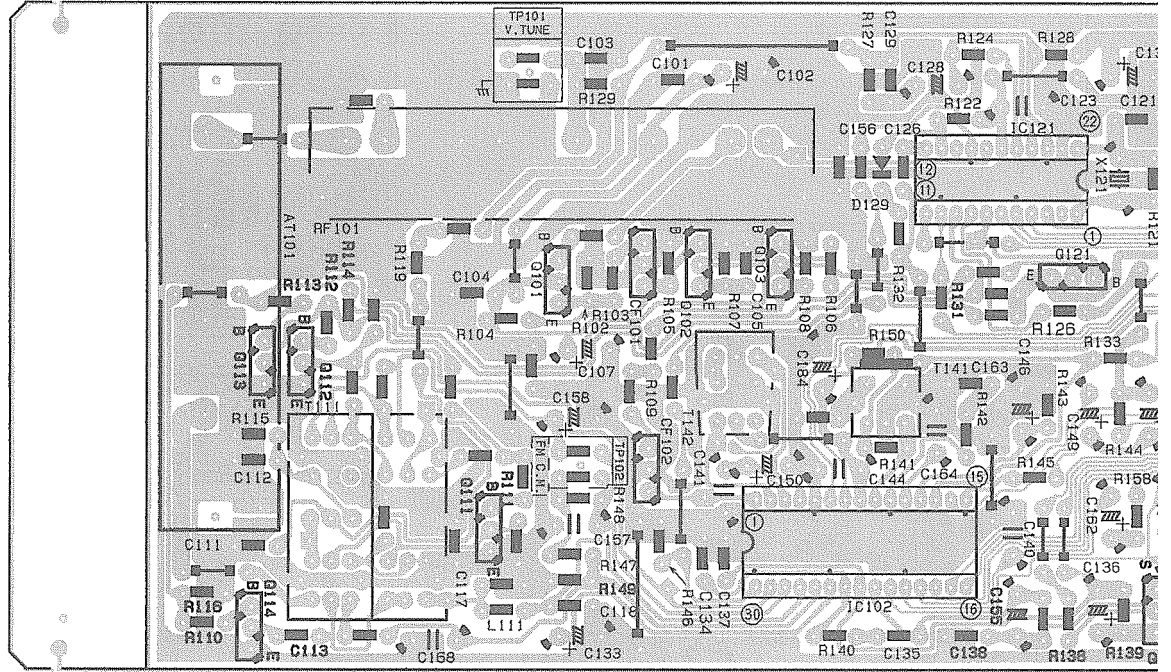

■ Resister P.C. Board

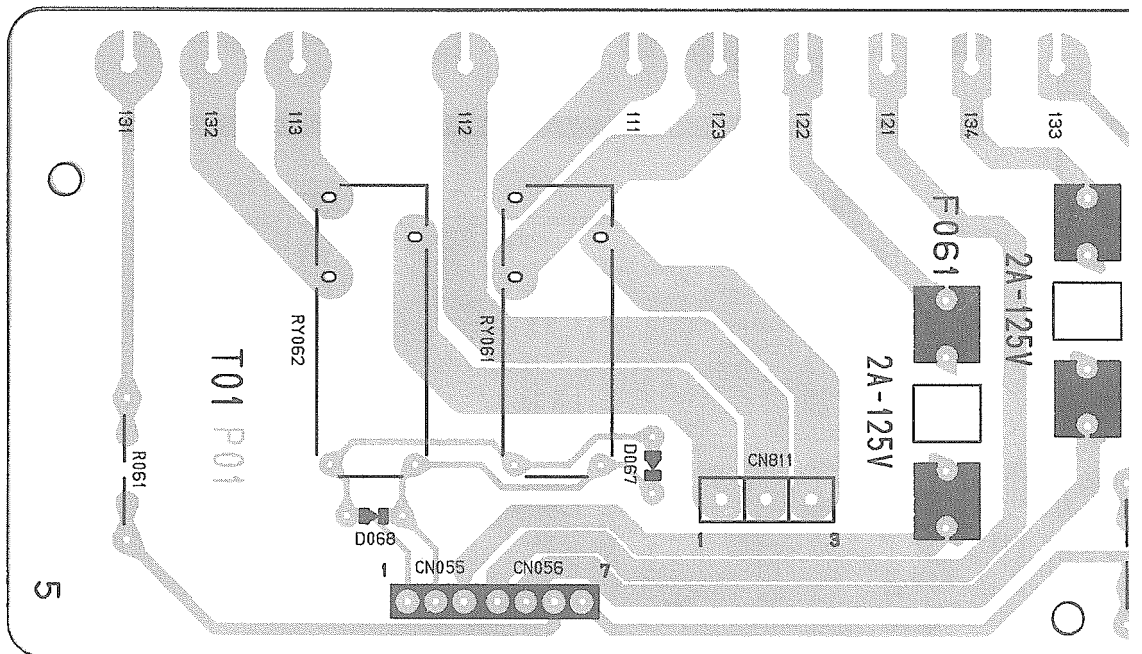

5

4

3

2

1

A

B

C

3-18

D

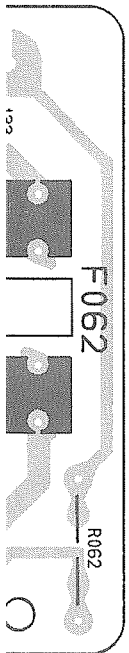
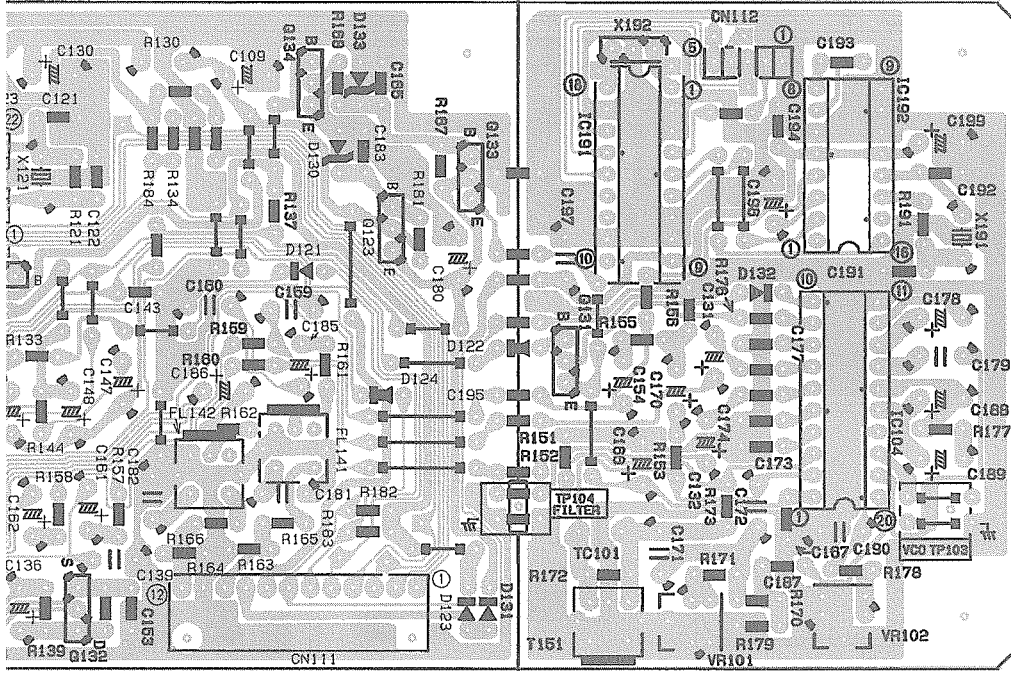

D

E

F

G

H

PARTS LIST

[RX-884PBK/RX-884PGD/RX-884VBK]

* All printed circuit boards and its assemblies are not available as service parts.

The Marks for Designated Areas

UF (PBK/PGD) ----- China
 UT (PBK/VBK) ----- Taiwan
 US (PBK) ----- Singapore
 U (PBK/VBK) ----- Universal

- Contents -

General Exploded View and Parts List	4-3
Electrical Parts List	4-5
Tuner P.C.B.	4-5
Main P.C.B.	4-6
Front P.C.B.	4-9
Control P.C.B.	4-11
AC Supply P.C.B.	4-13
AC-3 P.C.B.	4-16
Resistor P.C.B.	4-18
Accessories List	4-18
Packing Materials and Parts Number	4-19

RX-884P/RX-884V

-MEMO-

General Exploded View and Parts List

Block No. M 1 M M

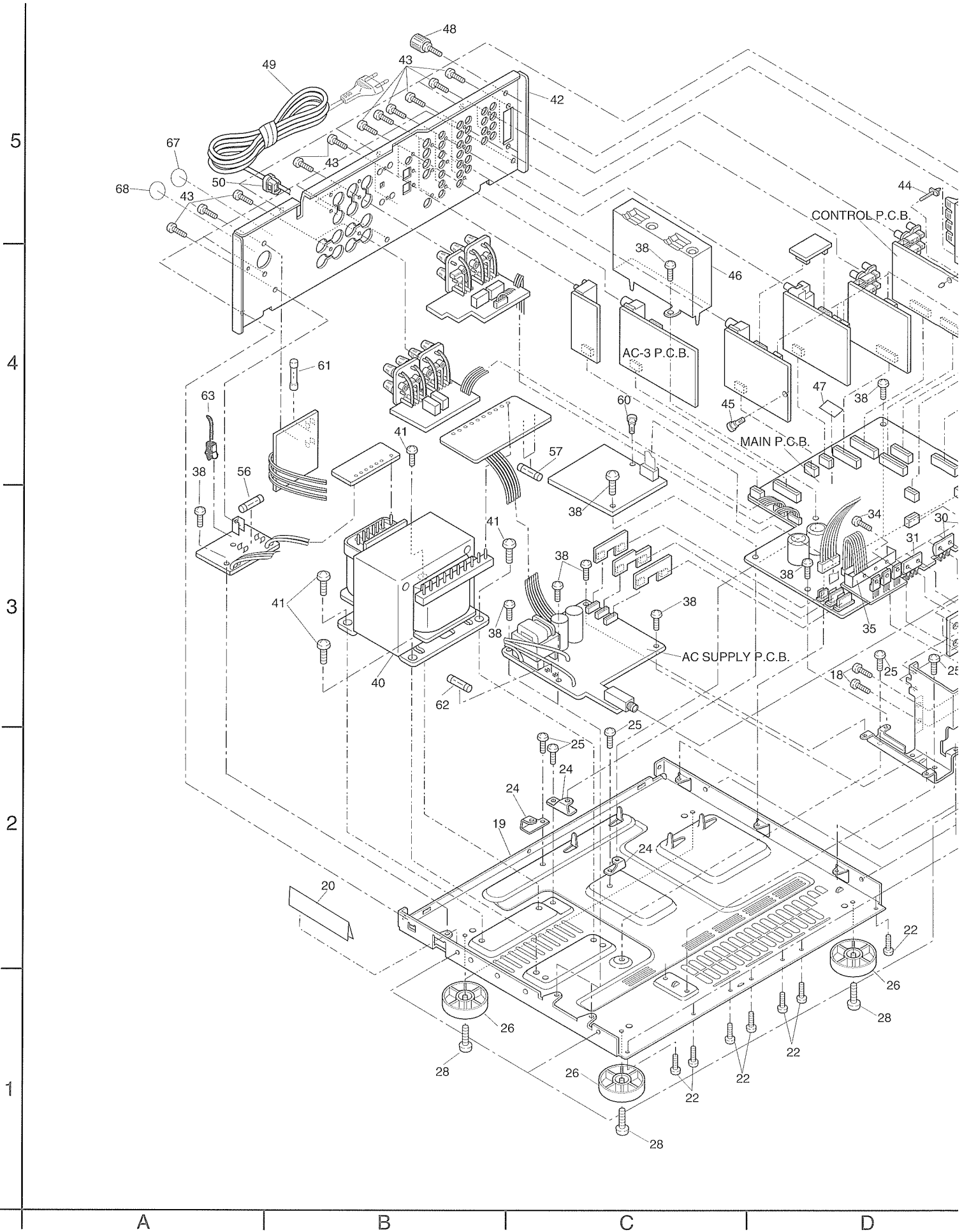

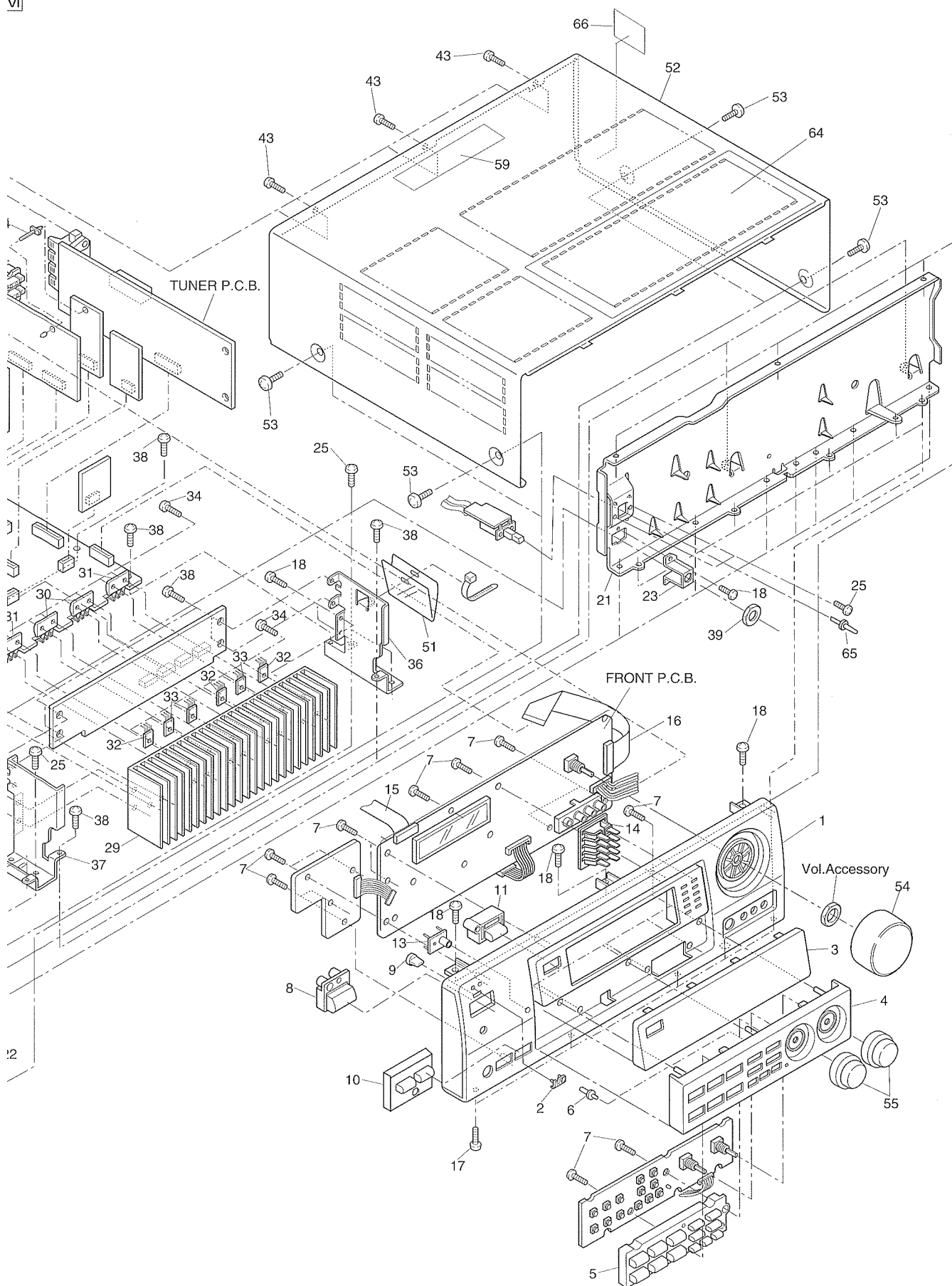

■ Parts List

Block No. M1MM

△	Item	Parts Number	Parts Name	Q'ty	Description	Version & Area
	1	LV10018-004AKP	FRONT PANEL	1		PBK
		LV10018-011A	FRONT PANEL	1		PGD
		LV10018-013AKP	FRONT PANEL	1		VBK
	2	VJD5429-001	JVC MARK	1		
	3	LV20031-001AKP	LENS	1		PBK, VBK
		LV20031-005A	LENS	1		PGD
	4	LV20032-001AKP	FRONT ESC	1		PBK, VBK
		LV20032-003A	FRONT ESC	1		PGD
	5	LV20034-001AKP	PUSH BUTTON	1		PBK, VBK
		LV20034-002A	PUSH BUTTON	1		PGD
	6	LV40099-001AKP	INDICATOR	1		
	7	QYSDSF2608Z	SCREW	18		
	8	LV30068-002AKP	P. BUTTON (POWER)	1		PBK, VBK
		LV30068-003A	P. BUTTON (POWER)	1		PGD
	9	FSJD4001-002	INDICATOR LENS	1		
	10	LV30069-001AKP	P. BUTTON ASSY	1		PBK, VBK
		LV30069-002A	P. BUTTON ASSY	1		PGD
	11	LV30071-001AKP	P. BUTTON ASSY	1		
	13	E308744-002	REMOCON PLATE	1		PBK, VBK
		E308744-003	REMOCON PLATE	1		PGD
	14	LV30073-001AKP	SOURCE INDICATO	1		
	15	QUQ412-2120CJ	FLAT WIRE	1		PBK, PGD
		VWF1221-20TTB	FLAT WIRE	1		VBK
	16	QUQ412-3122GJ	FLAT WIRE	1		PBK, PGD
		VWF1231-22TTBW	FLAT WIRE	1		VBK
	17	QYSDSG3008M	SCREW	5		PBK, VBK
		QYSDSG3008N	SCREW	5		PGD
	18	QYSBSG3008E	T. SCREW	8		
	19	LV10019-002AKP	CHASSIS BASE	1		
	20	EX0150010H09S11	FELT SPACER	1		
	21	LV10020-001AKP	FRONT BRACKET	1		
	22	QYSDSG3008E	T. SCREW	7		
	23	LE40139-001A	HEADPHONE BRACKET	1		
	24	E68587-223SM	P. W. BOARD BRACKET	3		
	25	QYSBST3006E	TAP. SCREW	9		
	26	VJF4039-00P	FOOT ASSY	4		
	28	QYSBST3010Z	TH TAP SCREW	4		
△	29	LV30075-201A	HEAT SINK	1		PBK, PGD
△		LV30075-001AKP	HEAT SINK	1		VBK
△	30	2SC3857/PY/-F1	SI. TRANSISTOR	2	3A	
△	31	2SA1493/PY/-F1	SI. TRANSISTOR	2	3A	
△	32	2SD2488/OP/-F1	SI. TRANSISTOR	3	3A	
△	33	2SB1620/OP/-F1	SI. TRANSISTOR	3	3A	
	34	E73525-003	SCREW	16		
	35	LV40390-001AKP	LEAF SPRING	1		
	36	LV20035-001AKP	H. S BRACKET (R)	1		
	37	LV20036-001AKP	H. S BRACKET (L)	1		
	38	QYSBSGG3008E	T. SCREW	17		
	39	VKZ4150-001	NUT	1		
△	40	QQT0213-002KP	POWER TRANS.	1		
	41	QYSDSTL4008E	SPECIAL SCREW	4		
	42	LV10021-018AKP	REAR PANEL	1		PBK

■ Parts List

Block No. M1MM

△	Item	Parts Number	Parts Name	Q'ty	Description	Version & Area
	42	LV10021-020A	REAR PANEL	1		PGD
		LV10021-012AKP	REAR PANEL	1		VBKU
		LV10021-014AKP	REAR PANEL	1		VBKUT
	43	QYSBSGY3008E	SPECIAL SCREW	32		
	44	E302321-001	FASTENER	1		
	45	E48729-008	PLASTIC RIVET	1		
	46	LV20037-001AKP	SHIELD CASE	1		
	47	E75896-003	SPACER	1		
	48	E409257-001	EARTH TERMINAL	1		
△	49	QMPR100-200-JC	POWER CORD	1		UF
△		QMP39E0-200	POWER CORD	1		U, US
△		QMP7520-200	POWER CORD	1		UT
△	50	QHS3771-108	CORD STOPPER	1		
	51	LV30076-001AKP	PROTECTOR	1		
	52	LV20038-002A(S)	METAL COVER	1		PBK, VBK
		LV20038-003A(S)	METAL COVER	1		PGD
	53	E406308-003	SPECIAL SCREW	4		PBK, VBK
		E406308-004	SPECIAL SCREW	4		PGD
	54	LV30480-001AKP	VOL KNOB ASS'Y	1		PBK, VBK
		LV30480-002A	VOL KNOB ASS'Y	1		PGD
	55	LV30481-001AKP	JOG KNOB ASS'Y	2		PBK, VBK
		LV30481-002A	JOG KNOB ASS'Y	2		PGD
△	56	QMF51E2-6R3-J1	FUSE	1	F001	
△	57	QMF51E2-2R0-J1	FUSE	2	F061, F062	
	59	E409396-001	CAUTION LABEL	1		
	60	E310243-002	PLASTIC RIVET	1		
△	61	QMF51E2-3R15-J1	FUSE	1	F004	
△	62	QMF51A2-R10-S	FUSE	1	F002	
	63	E307572-001	FASTENER	1		
	64	LV30077-001AKP	PROTECT SHEET	1		PBK, VBK
		LV30077-002A	PROTECT SHEET	1		PGD
	65	E407321-002SM	PUSH BUTTON	1		PBK, VBK
		E407321-005SMKP	PUSH BUTTON	1		PGD
	66	LV30092-028A	UF LABEL	1		UF
		LV30093-021A	UT LABEL	1		PBKUT
		LV30093-027A	UT LABEL	1		VBKUT
	67	E409372-001	CCEE LABEL	1		UF
	68	E409539-001	CC1B LABEL	1		UF

■ Electrical Parts List (Main P.C.B)

△	Item	Parts Number	Description	Area
		I. C. S		
	IC321	TC9162AN	I. C (DIGI-OTHER)	
	IC331	TC9459F	I. C (M)	
	IC332	TC9459F	I. C (M)	
	IC333	TC9459F	I. C (M)	
	IC361	NJM4580L	I. C (MONO-ANALOG)	
	IC362	BA15218N	I. C (MONO-ANALOG)	
	IC363	BA15218N	I. C (MONO-ANALOG)	
	IC451	LC7522	I. C (DIGI-MOS)	
	IC452	M5243AP12	I. C (M)	
	IC901	TA7317P	I. C (MONO-ANALOG)	
		DIODES		
	D743	MTZJ18C-T2	ZENER	
	D771	1SS133-T2	SI. DIODE	
	D772	1SS133-T2	SI. DIODE	
	D773	1SS133-T2	SI. DIODE	
	D774	1SS133-T2	SI. DIODE	
	D821	MTZJ6. 8C-T2	ZENER	
	D822	1SS133-T2	SI. DIODE	
	D831	MTZJ6. 2C-T2	ZENER	
	D832	1SS133-T2	SI. DIODE	
	D841	MTZJ6. 2C-T2	ZENER	
	D842	1SS133-T2	SI. DIODE	
	D851	MTZJ15C-T2	ZENER	
	D852	1SS133-T2	SI. DIODE	
	D861	MTZJ15C-T2	ZENER	
	D862	1SS133-T2	SI. DIODE	
	D871	MTZJ13C-T2	ZENER	
	D872	1SS133-T2	SI. DIODE	
	D901	1SS133-T2	SI. DIODE	
	D902	1SS133-T2	SI. DIODE	
	D921	MTZJ4. 7B-T2	ZENER	
	D931	1SS133-T2	SI. DIODE	
	D932	1SS133-T2	SI. DIODE	
	D933	1SS133-T2	SI. DIODE	
	D934	1SS133-T2	SI. DIODE	
	D953	1SS133-T2	SI. DIODE	
	D954	1SS133-T2	SI. DIODE	
	D971	1SS133-T2	SI. DIODE	
	D973	1SS133-T2	SI. DIODE	
	D1435	1SS133-T2	SI. DIODE	
	D1436	1SS133-T2	SI. DIODE	
	D1437	MTZJ4. 7B-T2	ZENER	
	D1451	MTZJ6. 8C-T2	ZENER	
	D1452	MTZJ6. 8C-T2	ZENER	
	D1453	MTZJ5. 1C-T2	ZENER	
		TRANSISTORS		
	Q751	2SC2389S/S/-T	SILICON	
	Q752	2SC2389S/S/-T	SILICON	
	Q753	2SA1038S/S/-T	SILICON	
	Q754	2SA1038S/S/-T	SILICON	
	Q755	2SD669A/BG/	SILICON	
	Q756	2SD669A/BG/	SILICON	
	Q757	2SB649A/BG/	SILICON	
	Q758	2SB649A/BG/	SILICON	
	Q771	2SC2389S/SE/-T	SI. TRANSISTOR	
	Q772	2SC2389S/SE/-T	SI. TRANSISTOR	
	Q773	2SA1038S/SE/-T	SILICON	
	Q774	2SA1038S/SE/-T	SILICON	
	Q781	2SD636/QR/	SILICON	
	Q782	2SD636/QR/	SILICON	
	Q821	2SD2061/EF/	SI. TRANSISTOR	
	Q831	2SD2061/EF/	SI. TRANSISTOR	
	Q841	2SD2061/EF/	SI. TRANSISTOR	
△	Q851	2SD2061/EF/	SI. TRANSISTOR	
△	Q861	2SB1187/EF/	SILICON	
	Q871	2SD2061/EF/	SI. TRANSISTOR	
	Q901	2SC2389S/SE/-T	SI. TRANSISTOR	
	Q902	2SC2389S/SE/-T	SI. TRANSISTOR	
	Q903	2SA1038S/SE/-T	SILICON	
	Q921	2SC1740S/RS/-T	SILICON	
	Q931	DTC123YS-T	SILICON	
	Q932	DTC123YS-T	SILICON	
	Q951	DTC123YS-T	SILICON	
	Q952	DTC123YS-T	SILICON	

△	Item	Parts Number	Description	Area
	Q1401	2SC2878/AB/-T	SILICON	
	Q1402	2SC2878/AB/-T	SILICON	
	Q1405	DTA144ES-T	SILICON	
	Q1411	2SC2878/AB/-T	SILICON	
	Q1421	2SC2878/AB/-T	SILICON	
	Q1422	2SC2878/AB/-T	SILICON	
	Q1435	2SA933S/RS/-T	SILICON	
	Q1441	DTA144ES-T	SILICON	
		CAPACITORS		
	C701	QETB1HM-106	10MF 50V E. CAP.	
	C702	QETB1HM-106	10MF 50V E. CAP.	
	C703	QCS21HJ-101A	100PF 50V CER. CAP.	
	C704	QCS21HJ-101A	100PF 50V CER. CAP.	
	C707	QETB1CM-107	100MF 16V AL E. CAP.	
	C708	QETB1CM-107	100MF 16V AL E. CAP.	
	C709	QCS21HJ-100	10PF 50V CER. CAP.	
	C710	QCS21HJ-100	10PF 50V CER. CAP.	
	C719	QFLB1HJ-472	4700PF 50V MYLAR CAP.	
	C720	QFLB1HJ-472	4700PF 50V MYLAR CAP.	
	C741	QETB2AM-476	47MF 100V AL E. CAP.	
	C742	QETB2AM-476	47MF 100V AL E. CAP.	
	C743	QETB1EM-476	47MF 25V AL E. CAP.	
	C751	QCS22HJ-470A	47PF 500V CER. CAP.	
	C752	QCS22HJ-470A	47PF 500V CER. CAP.	
	C753	QCS22HJ-470A	47PF 500V CER. CAP.	
	C754	QCS22HJ-470A	47PF 500V CER. CAP.	
	C791	QFLB1HJ-473	0. 047MF 50V MYLAR CAP.	
	C792	QFLB1HJ-473	0. 047MF 50V MYLAR CAP.	
	C793	QFLB1HJ-473	0. 047MF 50V MYLAR CAP.	
	C794	QFLB1HJ-473	0. 047MF 50V MYLAR CAP.	
	C807	QE20427-129	12000MF NP E. CAP.	
	C808	QE20427-129	12000MF NP E. CAP.	
	C821	QEHCIEM-107	100MF 25V E. CAP.	
	C822	QCF31HZ-472Z	4700PF 50V CERAMIC	
	C831	QEHCIEM-227Z	220MF 25V ELECTRO	
	C832	QCF31HZ-472Z	4700PF 50V CERAMIC	
	C841	QEHCIEM-107	100MF 25V E. CAP.	
	C842	QCF31HZ-472Z	4700PF 50V CERAMIC	
	C851	QETB1EM-107	100MF 25V AL E. CAP.	
	C852	QCF31HZ-472Z	4700PF 50V CERAMIC	
	C861	QETB1EM-107	100MF 25V AL E. CAP.	
	C862	QCF31HZ-472Z	4700PF 50V CERAMIC	
	C871	QETB1EM-107	100MF 25V AL E. CAP.	
	C872	QCF31HZ-472Z	4700PF 50V CERAMIC	
	C903	QER61HM-226	22MF 50V AL E. CAP.	
	C904	QCF31HZ-103Z	0. 01MF 50V CERAMIC	
	C905	QCB31HK-102Z	1000PF 50V CERAMIC	
	C906	QETC1AM-476ZM	47MF 10V E. CAP.	
	C920	QETB1CM-226	22MF 16V E. CAP.	
	C921	QER51CM-107	100MF 16V E. CAP.	
	C935	QFLB1HJ-223	0. 022MF 50V MYLAR CAP.	
	C936	QFLB1HJ-223	0. 022MF 50V MYLAR CAP.	
	C937	QFLB1HJ-223	0. 022MF 50V MYLAR CAP.	
	C938	QFLB1HJ-223	0. 022MF 50V MYLAR CAP.	
	C939	QFLB1HJ-223	0. 022MF 50V MYLAR CAP.	
	C940	QFLB1HJ-223	0. 022MF 50V MYLAR CAP.	
	C941	QCS21HJ-221	220PF 50V CER. CAP.	
	C942	QCS21HJ-221	220PF 50V CER. CAP.	
	C943	QCS21HJ-221	220PF 50V CER. CAP.	
	C944	QCS21HJ-221	220PF 50V CER. CAP.	
	C1301	QETB1EM-476	47MF 25V AL E. CAP.	
	C1302	QETB1EM-476	47MF 25V AL E. CAP.	
	C1303	QDVB1EZ-223Y	0. 022MF 25V C CAP.	
	C1304	QDVB1EZ-223Y	0. 022MF 25V C CAP.	
	C1307	QFLB1HJ-821	820PF 50V MYLAR CAP.	
	C1308	QFLB1HJ-821	820PF 50V MYLAR CAP.	
	C1309	QFVJ1HJ-224Z	0. 22MF 50V T. FILM	
	C1310	QFVJ1HJ-224Z	0. 22MF 50V T. FILM	
	C1311	QETB1HM-475E	4. 7MF 50V E. CAP.	
	C1312	QETB1HM-475E	4. 7MF 50V E. CAP.	
	C1313	QETB1HM-475E	4. 7MF 50V E. CAP.	
	C1314	QETB1HM-475E	4. 7MF 50V E. CAP.	
	C1315	QETB1EM-476	47MF 25V AL E. CAP.	
	C1316	QETB1EM-476	47MF 25V AL E. CAP.	
	C1317	QDVB1EZ-223Y	0. 022MF 25V C CAP.	

■ Electrical Parts List (Main P.C.B)

△	Item	Parts Number	Description	Area
	C1318	QDVB1EZ-223Y	0.022MF 25V C CAP.	
	C1319	QCBB1HK-221Y	220PF 50V CER. CAP.	
	C1321	QETB1HM-475E	4.7MF 50V E. CAP.	
	C1322	QETB1HM-475E	4.7MF 50V E. CAP.	
	C1323	QETB1HM-475E	4.7MF 50V E. CAP.	
	C1324	QETB1HM-475E	4.7MF 50V E. CAP.	
	C1325	QETB1EM-476	47MF 25V AL E. CAP.	
	C1326	QETB1EM-476	47MF 25V AL E. CAP.	
	C1327	QDVB1EZ-223Y	0.022MF 25V C CAP.	
	C1328	QDVB1EZ-223Y	0.022MF 25V C CAP.	
	C1329	QCBB1HK-221Y	220PF 50V CER. CAP.	
	C1331	QETB1HM-475E	4.7MF 50V E. CAP.	
	C1332	QETB1HM-475E	4.7MF 50V E. CAP.	
	C1333	QETB1HM-475E	4.7MF 50V E. CAP.	
	C1334	QETB1HM-475E	4.7MF 50V E. CAP.	
	C1335	QETB1EM-476	47MF 25V AL E. CAP.	
	C1336	QETB1EM-476	47MF 25V AL E. CAP.	
	C1337	QDVB1EZ-223Y	0.022MF 25V C CAP.	
	C1338	QDVB1EZ-223Y	0.022MF 25V C CAP.	
	C1339	QCBB1HK-221Y	220PF 50V CER. CAP.	
	C1360	QCZ0202-155	1.5MF 25V CER. CAP.	
	C1361	QETB1HM-105	1MF 50V AL E. CAP.	
	C1362	QETB1HM-105	1MF 50V AL E. CAP.	
	C1369	QETB1EM-476	47MF 25V AL E. CAP.	
	C1370	QETB1EM-476	47MF 25V AL E. CAP.	
	C1371	QETB1HM-105	1MF 50V AL E. CAP.	
	C1372	QETB1HM-105	1MF 50V AL E. CAP.	
	C1379	QETB1EM-476	47MF 25V AL E. CAP.	
	C1380	QETB1EM-476	47MF 25V AL E. CAP.	
	C1381	QETB1HM-105	1MF 50V AL E. CAP.	
	C1382	QETB1HM-105	1MF 50V AL E. CAP.	
	C1389	QETB1EM-476	47MF 25V AL E. CAP.	
	C1390	QETB1EM-476	47MF 25V AL E. CAP.	
	C1405	QETC1CM-226ZM	22MF 16V E. CAP.	
	C1441	QETB1HM-105	1MF 50V AL E. CAP.	
	C1451	QETB1HM-475E	4.7MF 50V E. CAP.	
	C1452	QETB1HM-475E	4.7MF 50V E. CAP.	
	C1453	QCS21HJ-101A	100PF 50V CER. CAP.	
	C1454	QCS21HJ-101A	100PF 50V CER. CAP.	
	C1455	QETB1HM-475E	4.7MF 50V E. CAP.	
	C1456	QETB1HM-475E	4.7MF 50V E. CAP.	
	C1457	QETB1HM-475E	4.7MF 50V E. CAP.	
	C1458	QETB1HM-475E	4.7MF 50V E. CAP.	
	C1459	QETB1HM-475E	4.7MF 50V E. CAP.	
	C1460	QETB1HM-475E	4.7MF 50V E. CAP.	
	C1461	QETB1CM-476	47MF 16V AL E. CAP.	
	C1462	QETB1CM-476	47MF 16V AL E. CAP.	
	C1463	QDVB1EZ-223Y	0.022MF 25V C CAP.	
	C1464	QDVB1EZ-223Y	0.022MF 25V C CAP.	
	C1465	QETB1CM-476	47MF 16V AL E. CAP.	
	C1469	QCS21HJ-470	47PF 50V CER. CAP.	
	C1470	QCS21HJ-470	47PF 50V CER. CAP.	
	C1471	QFVJ1HJ-333Z	0.033MF 50V T. FILM	
	C1472	QFVJ1HJ-333Z	0.033MF 50V T. FILM	
	C1473	QETB1HM-105	1MF 50V AL E. CAP.	
	C1474	QETB1HM-105	1MF 50V AL E. CAP.	
	C1475	QFLB1HJ-332	3300PF 50V MYLAR CAP.	
	C1476	QFLB1HJ-332	3300PF 50V MYLAR CAP.	
	C1477	QFVJ1HJ-104Z	0.1MF 50V T. FILM	
	C1478	QFVJ1HJ-104Z	0.1MF 50V T. FILM	
	C1479	QCS31HJ-331Z	330PF 50V CER. CAP.	
	C1480	QCS31HJ-331Z	330PF 50V CER. CAP.	
	C1481	QFVJ1HJ-103Z	0.01MF 50V T. FILM	
	C1482	QFVJ1HJ-103Z	0.01MF 50V T. FILM	
		RESISTORS		
	R701	QRE141J-222Y	2.2K 1/4W R. NETWORK	
	R702	QRE141J-222Y	2.2K 1/4W R. NETWORK	
	R703	QRE141J-104Y	100K 1/4W R. NETWORK	
	R704	QRE141J-104Y	100K 1/4W R. NETWORK	
	R711	QRE141J-911Y	910 1/4W R. NETWORK	
	R712	QRE141J-911Y	910 1/4W R. NETWORK	
	R713	QRE141J-183Y	18K 1/4W CARBON RES.	
	R714	QRE141J-183Y	18K 1/4W CARBON RES.	
	R715	QRE141J-823Y	82K 1/4W R. NETWORK	
	R716	QRE141J-823Y	82K 1/4W R. NETWORK	

△	Item	Parts Number	Description	Area
	R741	QRJ146J-100X	10 1/4W R. NETWORK	
	R742	QRJ146J-100X	10 1/4W R. NETWORK	
	R743	QRL022J-562	5.6K 2W R. NETWORK	
	R751	QRJ146J-100X	10 1/4W R. NETWORK	
	R752	QRJ146J-100X	10 1/4W R. NETWORK	
	R753	QRJ146J-100X	10 1/4W R. NETWORK	
	R754	QRJ146J-100X	10 1/4W R. NETWORK	
	R759	QRJ146J-272X	2.7K 1/4W R. NETWORK	
	R760	QRJ146J-272X	2.7K 1/4W R. NETWORK	
	R765	QRJ146J-100X	10 1/4W R. NETWORK	
	R766	QRJ146J-100X	10 1/4W R. NETWORK	
	R767	QRJ146J-100X	10 1/4W R. NETWORK	
	R768	QRJ146J-100X	10 1/4W R. NETWORK	
	R769	QRJ146J-271X	270 1/4W R. NETWORK	
	R770	QRJ146J-271X	270 1/4W R. NETWORK	
	R771	QRE141J-391Y	390 1/4W R. NETWORK	
	R772	QRE141J-391Y	390 1/4W R. NETWORK	
	R773	QRE141J-391Y	390 1/4W R. NETWORK	
	R774	QRE141J-391Y	390 1/4W R. NETWORK	
	R775	QRE141J-201Y	200 1/4W R. NETWORK	
	R776	QRE141J-201Y	200 1/4W R. NETWORK	
	R777	QRE141J-201Y	200 1/4W R. NETWORK	
	R778	QRE141J-201Y	200 1/4W R. NETWORK	
	R779	QRZ0197-R22	0.22 1W NETWORK RES.	
	R780	QRZ0197-R22	0.22 1W NETWORK RES.	
	R781	QRE141J-391Y	390 1/4W R. NETWORK	
	R782	QRE141J-391Y	390 1/4W R. NETWORK	
	R783	QRE141J-471Y	470 1/4W R. NETWORK	
	R784	QRE141J-471Y	470 1/4W R. NETWORK	
	R785	QRE141J-102Y	1K 1/4W R. NETWORK	
	R786	QRE141J-102Y	1K 1/4W R. NETWORK	
	R789	QRE141J-102Y	1K 1/4W R. NETWORK	
	R790	QRE141J-102Y	1K 1/4W R. NETWORK	
	R791	QRJ125J-330	33 1/2W R. NETWORK	
	R792	QRJ125J-330	33 1/2W R. NETWORK	
	R793	QRL022J-100	10 2W R. NETWORK	
	R794	QRL022J-100	10 2W R. NETWORK	
	R801	QRE141J-104Y	100K 1/4W R. NETWORK	
	R802	QRE141J-104Y	100K 1/4W R. NETWORK	
	R821	QRK126J-220X	22 1/2W R. NETWORK	
	R822	QRK126J-220X	22 1/2W R. NETWORK	
	R823	QRJ146J-821X	820 1/4W R. NETWORK	
	R831	QRL022J-100	10 2W R. NETWORK	
	R833	QRJ146J-821X	820 1/4W R. NETWORK	
	R841	QRJ146J-220X	22 1/4W R. NETWORK	
	R842	QRJ146J-220X	22 1/4W R. NETWORK	
	R843	QRJ146J-821X	820 1/4W R. NETWORK	
	R851	QRJ146J-120X	12 1/4W R. NETWORK	
	R853	QRJ146J-272X	2.7K 1/4W R. NETWORK	
	R861	QRJ146J-100X	10 1/4W R. NETWORK	
	R863	QRJ146J-272X	2.7K 1/4W R. NETWORK	
	R871	QRJ146J-120X	12 1/4W R. NETWORK	
	R873	QRJ146J-222X	2.2K 1/4W R. NETWORK	
	R901	QRE141J-272Y	2.7K 1/4W R. NETWORK	
	R902	QRE141J-272Y	2.7K 1/4W R. NETWORK	
	R903	QRE141J-153Y	15K 1/4W R. NETWORK	
	R904	QRE141J-153Y	15K 1/4W R. NETWORK	
	R905	QRE141J-123Y	12K 1/4W R. NETWORK	
	R906	QRE141J-123Y	12K 1/4W R. NETWORK	
	R909	QRE141J-103Y	10K 1/4W R. NETWORK	
	R911	QRE141J-332Y	3.3K 1/4W R. NETWORK	
	R912	QRE141J-473Y	47K 1/4W R. NETWORK	
	R913	QRE141J-104Y	100K 1/4W R. NETWORK	
	R914	QRE141J-823Y	82K 1/4W R. NETWORK	
	R915	QRE141J-823Y	82K 1/4W R. NETWORK	
	R916	QRE141J-563Y	56K 1/4W R. NETWORK	
	R917	QRE141J-683Y	68K 1/4W R. NETWORK	
	R918	QRE141J-822Y	8.2K 1/4W R. NETWORK	
	R919	QRE141J-822Y	8.2K 1/4W R. NETWORK	
	R920	QRE141J-224Y	220K 1/4W R. NETWORK	
	R921	QRE141J-473Y	47K 1/4W R. NETWORK	
	R922	QRE141J-222Y	2.2K 1/4W R. NETWORK	
	R931	QRJ146J-120X	12 1/4W R. NETWORK	
	R932	QRJ146J-120X	12 1/4W R. NETWORK	
	R935	QRZ9005-100X	10 FUSIBLE	

■ Electrical Parts List (Main P.C.B)

△	Item	Parts Number	Description	Area
	R936	QRZ9005-100X	10 FUSIBLE	
	R937	QRZ9005-100X	10 FUSIBLE	
	R938	QRZ9005-100X	10 FUSIBLE	
	R971	QRJ146J-120X	12 1/4W R. NETWORK	
	R1300	QRE141J-333Y	33K 1/4W R. NETWORK	
	R1301	QRE141J-222Y	2.2K 1/4W R. NETWORK	
	R1302	QRE141J-222Y	2.2K 1/4W R. NETWORK	
	R1303	QRE141J-222Y	2.2K 1/4W R. NETWORK	
	R1304	QRE141J-222Y	2.2K 1/4W R. NETWORK	
	R1305	QRE141J-222Y	2.2K 1/4W R. NETWORK	
	R1306	QRE141J-222Y	2.2K 1/4W R. NETWORK	
	R1307	QRE141J-333Y	33K 1/4W R. NETWORK	
	R1308	QRE141J-333Y	33K 1/4W R. NETWORK	
	R1309	QRZ9005-680X	68 FUSIBLE	
	R1310	QRZ9005-680X	68 FUSIBLE	
	R1311	QRZ9005-680X	68 FUSIBLE	
	R1312	QRZ9005-680X	68 FUSIBLE	
	R1313	QRE141J-104Y	100K 1/4W R. NETWORK	
	R1314	QRE141J-104Y	100K 1/4W R. NETWORK	
	R1321	QRZ9005-680X	68 FUSIBLE	
	R1322	QRZ9005-680X	68 FUSIBLE	
	R1323	QRE141J-104Y	100K 1/4W R. NETWORK	
	R1324	QRE141J-104Y	100K 1/4W R. NETWORK	
	R1331	QRZ9005-680X	68 FUSIBLE	
	R1332	QRZ9005-680X	68 FUSIBLE	
	R1333	QRE141J-104Y	100K 1/4W R. NETWORK	
	R1334	QRE141J-104Y	100K 1/4W R. NETWORK	
	R1361	QRE141J-682Y	6.8K 1/4W R. NETWORK	
	R1362	QRE141J-682Y	6.8K 1/4W R. NETWORK	
	R1363	QRE141J-103Y	10K 1/4W R. NETWORK	
	R1364	QRE141J-103Y	10K 1/4W R. NETWORK	
	R1365	QRE141J-104Y	100K 1/4W R. NETWORK	
	R1366	QRE141J-104Y	100K 1/4W R. NETWORK	
	R1369	QRZ9005-680X	68 FUSIBLE	
	R1370	QRZ9005-680X	68 FUSIBLE	
	R1371	QRE141J-682Y	6.8K 1/4W R. NETWORK	
	R1372	QRE141J-682Y	6.8K 1/4W R. NETWORK	
	R1373	QRE141J-103Y	10K 1/4W R. NETWORK	
	R1374	QRE141J-103Y	10K 1/4W R. NETWORK	
	R1375	QRE141J-104Y	100K 1/4W R. NETWORK	
	R1376	QRE141J-104Y	100K 1/4W R. NETWORK	
	R1379	QRZ9005-680X	68 FUSIBLE	
	R1380	QRZ9005-680X	68 FUSIBLE	
	R1381	QRE141J-682Y	6.8K 1/4W R. NETWORK	
	R1382	QRE141J-682Y	6.8K 1/4W R. NETWORK	
	R1383	QRE141J-103Y	10K 1/4W R. NETWORK	
	R1384	QRE141J-103Y	10K 1/4W R. NETWORK	
	R1385	QRE141J-104Y	100K 1/4W R. NETWORK	
	R1386	QRE141J-104Y	100K 1/4W R. NETWORK	
	R1389	QRZ9005-680X	68 FUSIBLE	
	R1390	QRZ9005-680X	68 FUSIBLE	
	R1401	QRE141J-102Y	1K 1/4W R. NETWORK	
	R1402	QRE141J-102Y	1K 1/4W R. NETWORK	
	R1403	QRE141J-103Y	10K 1/4W R. NETWORK	
	R1404	QRE141J-103Y	10K 1/4W R. NETWORK	
	R1405	QRE141J-102Y	1K 1/4W R. NETWORK	
	R1406	QRE141J-225Y	2.2M 1/4W R. NETWORK	
	R1411	QRE141J-102Y	1K 1/4W R. NETWORK	
	R1412	QRE141J-103Y	10K 1/4W R. NETWORK	
	R1421	QRE141J-102Y	1K 1/4W R. NETWORK	
	R1422	QRE141J-102Y	1K 1/4W R. NETWORK	
	R1423	QRE141J-103Y	10K 1/4W R. NETWORK	
	R1424	QRE141J-103Y	10K 1/4W R. NETWORK	
	R1435	QRE141J-683Y	68K 1/4W R. NETWORK	
	R1436	QRE141J-104Y	100K 1/4W R. NETWORK	
	R1437	QRE141J-474Y	470K 1/4W R. NETWORK	
	R1441	QRE141J-102Y	1K 1/4W R. NETWORK	
	R1457	QRE141J-103Y	10K 1/4W R. NETWORK	
	R1458	QRE141J-103Y	10K 1/4W R. NETWORK	
	R1459	QRE141J-113Y	11K 1/4W R. NETWORK	
	R1460	QRE141J-113Y	11K 1/4W R. NETWORK	
	R1461	QRE141J-104Y	100K 1/4W R. NETWORK	
	R1462	QRE141J-104Y	100K 1/4W R. NETWORK	
	R1463	QRE141J-333Y	33K 1/4W R. NETWORK	
	R1464	QRE141J-333Y	33K 1/4W R. NETWORK	

△	Item	Parts Number	Description	Area
	R1465	QRE141J-124Y	120K 1/4W R. NETWORK	
	R1466	QRE141J-124Y	120K 1/4W R. NETWORK	
	R1471	QRJ146J-561X	560 1/4W R. NETWORK	
	R1472	QRJ146J-561X	560 1/4W R. NETWORK	
	R1473	QRJ146J-681X	680 1/4W R. NETWORK	
	R1475	QRE141J-474Y	470K 1/4W R. NETWORK	
	R1476	QRE141J-474Y	470K 1/4W R. NETWORK	
	R1477	QRE141J-474Y	470K 1/4W R. NETWORK	
	R1478	QRE141J-474Y	470K 1/4W R. NETWORK	
	R1479	QRE141J-474Y	470K 1/4W R. NETWORK	
	R1480	QRE141J-474Y	470K 1/4W R. NETWORK	
	R1741	QRJ146J-331X	330 1/4W R. NETWORK	
	R1841	QRJ146J-331X	330 1/4W R. NETWORK	
	VR787	QVP0004-501Z	500 VARIABLE	
	VR788	QVP0004-501Z	500 VARIABLE	
		OTHERS		
		QUB220-09HHP	CONNECTOR WIRE ASSY	
		QUB221-13HHP	CONNECTOR WIRE ASSY	
		GWE690-26RR	VINYL WIRE	
		QWE691-26RR	VINYL WIRE	
		QWE692-38RR	VINYL WIRE	
		QWE699-38RR	VINYL WIRE	
		QYSB63008E	T. SCREW	
	L791	QQLZ003-1R0	INDUCTOR	
	L792	QQLZ003-1R0	INDUCTOR	
	CN081	QGB2510J1-08	CONNECTOR	
	CN082	QGB2510J1-08	CONNECTOR	
	CN083	QGB2510J1-05	CONNECTOR	
	CN101	QGB2510J1-12	CONNECTOR	
	CN201	QGB2510J1-04	CONNECTOR	
	CN241	QGB2510J1-04	CONNECTOR	
	CN255	QGB2510J1-05	CONNECTOR	
	CN301	QGB2510J1-17	CONNECTOR	
	CN303	QGB2510J1-14	CONNECTOR	
	CN342	QGB2510J1-08	CONNECTOR	
	CN400	GGF1205C1-31	FFC SOCKET	
	CN451	QGB2510K1-09	CONNECTOR	
	CN452	QGB2510J1-09	CONNECTOR	
	CN501	QGB1214J3-18S	CONNECTOR	
	CN601	QGB1214J3-12S	CONNECTOR	
	CN702	GGA2501C1-05	CONNECTOR	
	CN704	GGA3901C1-08	CONNECTOR	
	CN706	QGB2510J1-12	CONNECTOR	
	CN801	EWS283-003	SOCKET WIRE ASSY	
	CN821	QGD2501C1-05Z	SOCKET I.M	
	CN901	QGD2501C1-03Z	SOCKET I.M	
	CN931	QGD2501C1-04Z	SOCKET I.M	
	CN932	QGD2501C1-03Z	SOCKET I.M	
	CN961	QGD2501C1-03Z	SOCKET I.M	
	EP801	QNZ0136-001Z	1M EARTH PLATE	
	FW811	EWR33D-10SS	CORD	
	FW821	EWR35D-08LS	FLAT WIRE	
	FW881	EWR33D-25LS	FLAT WIRE	
	FW931	EWR37D-16LS	FLAT WIRE	
	HS851	E70306-001	HEAT SINK	
	HS861	E70306-001	HEAT SINK	
	HS871	E70306-001	HEAT SINK	
	RY931	QSK0042-001	RELAY	
	RY932	QSK0042-001	RELAY	
	RY971	QSK0042-001	RELAY	
	ST931	QNB0024-001	SPK. TERMINAL	
	TH783	QAD0012-202	THERMISTOR	
	TH784	QAD0012-202	THERMISTOR	
	TP781	QMV5005-004K	PLUG ASSY	

■ Electrical Parts List (Front P.C.B)

△	Item	Parts Number	Description	Area
		I. C. S		
	IC341	BU4051BG	I. C (DIGI-MOS)	
	IC342	BA15218N	I. C (MONO-ANALOG)	
	IC400	MN172412JABZ	I. C (M)	
	IC401	MN101C15FAF	I. C (M)	
	IC402	BU2092	I. C (M)	
	IC403	IC-PST600/E/-T	I. C.	
	IC404	GP1U271X	INFRARED DETECT UNIT	
		DIODES		
	D400	1SR139-200-T4	SILICON	
	D401	1SR139-200-T4	SILICON	
	D402	1SR139-200-T4	SILICON	
	D404	1SS133-T2	SI. DIODE	
	D410	1SS133-T2	SI. DIODE	
	D411	1SS133-T2	SI. DIODE	
	D412	1SS133-T2	SI. DIODE	
	D413	1SS133-T2	SI. DIODE	
	D416	1SS133-T2	SI. DIODE	
	D417	1SS133-T2	SI. DIODE	
	D418	1SS133-T2	SI. DIODE	
	D420	SLR-342VC-T	L. E. D.	
	D421	SLR-342VC-T	L. E. D.	
	D422	SLR-342VC-T	L. E. D.	
	D430	SLR-342VC-T	L. E. D.	
	D431	SLR-342VC-T	L. E. D.	
	D432	SLR-342VC-T	L. E. D.	
	D433	SLR-342VC-T	L. E. D.	
	D434	SLR-342VC-T	L. E. D.	
	D435	SLR-342VC-T	L. E. D.	
	D436	SLR-342VC-T	L. E. D.	
	D437	SLR-342VC-T	L. E. D.	
	D438	SLR-342VC-T	L. E. D.	
	D439	SLR-342VC-T	L. E. D.	
	D440	SPR-325MVW/L/-T	L. E. D.	
	D442	SLR-342VC-T	L. E. D.	
	D493	1SS133-T2	SI. DIODE	
	D1351	MTZJ5. 1C-T2	ZENER	
	D1352	MTZJ5. 1C-T2	ZENER	
		TRANSISTORS		
	Q401	DTC114YS-T	SILICON	
	Q402	DTC114TSTP	DIGITAL TRANSISTOR	
	Q403	DTC144WS-T	SILICON	
	Q407	DTC114YS-T	SILICON	
	Q408	DTC114YS-T	SILICON	
	Q409	DTC144ES-T	SILICON	
	Q410	DTC144ES-T	SILICON	
	Q411	DTC144ES-T	SILICON	
	Q412	DTC144ES-T	SILICON	
	Q413	DTA114YS-T	SILICON	
	Q414	DTA114YS-T	SILICON	
	Q415	DTA114YS-T	SILICON	
	Q416	DTA114YS-T	SILICON	
	Q442	DTA114YS-T	SILICON	
	Q456	DTA114YS-T	SILICON	
	Q457	DTA114YS-T	SILICON	
		CAPACITORS		
	C400	QEKCHM-475Z	4.7MF 50V ELECTRO	
	C401	QEKCOJM-107Z	100MF 6.3V ELECTRO	
	C402	QCZ0202-155	1.5MF 25V CER. CAP.	
	C403	QE20329-10AZ	ELECTRO	
	C404	QER61HM-225	2.2MF 50V ELECTRO	
	C405	QDVB1EZ-223Y	0.022MF 25V C CAP.	
	C406	QCBBIHK-331Y	330PF 50V CER. CAP.	
	C407	QCFB1HZ-104Y	0.1MF 50V CER. CAP.	
	C408	QEKCOJM-107Z	100MF 6.3V ELECTRO	
	C409	QEKCHM-475Z	4.7MF 50V ELECTRO	

△	Item	Parts Number	Description	Area
	C410	QEKCHM-475Z	4.7MF 50V ELECTRO	
	C412	QEKCOJM-107Z	100MF 6.3V ELECTRO	
	C413	QDYB1CM-103Y	0.01MF 16V C CAP.	
	C414	QDYB1CM-103Y	0.01MF 16V C CAP.	
	C1341	QETB1HM-475E	4.7MF 50V E. CAP.	
	C1342	QETB1HM-475E	4.7MF 50V E. CAP.	
	C1343	QCS21HJ-101A	100PF 50V CER. CAP.	
	C1346	QFLB1HJ-103	0.01MF 50V MYLAR CAP.	
	C1347	QFLB1HJ-123	0.012MF 50V MYLAR CAP.	
	C1349	QETB1EM-476	47MF 25V AL E. CAP.	
	C1350	QETB1EM-476	47MF 25V AL E. CAP.	
	C1351	QETC1AM-476ZM	47MF 10V E. CAP.	
	C1352	QETC1AM-476ZM	47MF 10V E. CAP.	
	C1581	QFVJ1HJ-104Z	0.1MF 50V T. FILM	
	C1582	QFVJ1HJ-104Z	0.1MF 50V T. FILM	
	C1585	QCZ0202-155	1.5MF 25V CER. CAP.	
	C1591	QCBBIHK-471Y	470PF 50V CER. CAP.	
	C1592	QCBBIHK-471Y	470PF 50V CER. CAP.	
	C1593	QCBBIHK-471Y	470PF 50V CER. CAP.	
	C1594	QCBBIHK-471Y	470PF 50V CER. CAP.	
	C1599	QDYB1CM-103Y	0.01MF 16V C CAP.	
		RESISTORS		
	R401	QRE141J-103Y	10K 1/4W R. NETWORK	
	R402	QRE141J-103Y	10K 1/4W R. NETWORK	
	R403	QRE141J-331Y	330 1/4W R. NETWORK	
	R404	QRE141J-103Y	10K 1/4W R. NETWORK	
	R405	QRE141J-103Y	10K 1/4W R. NETWORK	
	R406	QRE141J-103Y	10K 1/4W R. NETWORK	
	R407	QRE141J-103Y	10K 1/4W R. NETWORK	
	R408	QRE141J-223Y	22K 1/4W R. NETWORK	
	R410	QRE141J-223Y	22K 1/4W R. NETWORK	
	R411	QRE141J-472Y	4.7K 1/4W R. NETWORK	
	R412	QRE141J-181Y	180 1/4W R. NETWORK	
	R417	QRE141J-103Y	10K 1/4W R. NETWORK	
	R418	QRE141J-471Y	470 1/4W R. NETWORK	
	R419	QRE141J-103Y	10K 1/4W R. NETWORK	
	R420	QRE141J-221Y	220 1/4W R. NETWORK	
	R421	QRE141J-271Y	270 1/4W R. NETWORK	
	R422	QRE141J-271Y	270 1/4W R. NETWORK	
	R423	QRE141J-103Y	10K 1/4W R. NETWORK	
	R424	QRE141J-103Y	10K 1/4W R. NETWORK	
	R425	QRE141J-103Y	10K 1/4W R. NETWORK	
	R426	QRE141J-103Y	10K 1/4W R. NETWORK	
	R427	QRE141J-103Y	10K 1/4W R. NETWORK	
	R430	QRE141J-103Y	10K 1/4W R. NETWORK	
	R431	QRE141J-103Y	10K 1/4W R. NETWORK	
	R433	QRE141J-221Y	220 1/4W R. NETWORK	
	R434	QRE141J-221Y	220 1/4W R. NETWORK	
	R435	QRE141J-221Y	220 1/4W R. NETWORK	
	R436	QRE141J-102Y	1K 1/4W R. NETWORK	
	R437	QRE141J-102Y	1K 1/4W R. NETWORK	
	R438	QRE141J-102Y	1K 1/4W R. NETWORK	
	R439	QRE141J-102Y	1K 1/4W R. NETWORK	
	R440	QRE141J-103Y	10K 1/4W R. NETWORK	
	R444	QRE141J-221Y	220 1/4W R. NETWORK	
	R445	QRE141J-221Y	220 1/4W R. NETWORK	
	R446	QRE141J-221Y	220 1/4W R. NETWORK	
	R447	QRE141J-221Y	220 1/4W R. NETWORK	
	R448	QRE141J-221Y	220 1/4W R. NETWORK	
	R449	QRE141J-221Y	220 1/4W R. NETWORK	
	R450	QRE141J-221Y	220 1/4W R. NETWORK	
	R451	QRE141J-221Y	220 1/4W R. NETWORK	
	R452	QRE141J-221Y	220 1/4W R. NETWORK	
	R453	QRE141J-221Y	220 1/4W R. NETWORK	
	R454	QRE141J-221Y	220 1/4W R. NETWORK	
	R455	QRE141J-221Y	220 1/4W R. NETWORK	

■ Electrical Parts List (Front P.C.B)

△	Item	Parts Number	Description	Area
	R456	QRE141J-221Y	220 1/4W R. NETWORK	
	R457	QRE141J-221Y	220 1/4W R. NETWORK	
	R458	QRE141J-102Y	1K 1/4W R. NETWORK	
	R459	QRE141J-102Y	1K 1/4W R. NETWORK	
	R460	QRE141J-221Y	220 1/4W R. NETWORK	
	R461	QRE141J-221Y	220 1/4W R. NETWORK	
	R462	QRE141J-221Y	220 1/4W R. NETWORK	
	R463	QRE141J-102Y	1K 1/4W R. NETWORK	
	R464	QRE141J-221Y	220 1/4W R. NETWORK	
	R465	QRE141J-102Y	1K 1/4W R. NETWORK	
	R466	QRE141J-221Y	220 1/4W R. NETWORK	
	R468	QRE141J-271Y	270 1/4W R. NETWORK	
	R469	QRE141J-221Y	220 1/4W R. NETWORK	
	R471	QRE141J-750Y	75 1/4W R. NETWORK	
	R472	QRE141J-750Y	75 1/4W R. NETWORK	
	R474	QRE141J-750Y	75 1/4W R. NETWORK	
	R484	QRE141J-271Y	270 1/4W R. NETWORK	
	R495	QRE141J-104Y	100K 1/4W R. NETWORK	
	R496	QRE141J-104Y	100K 1/4W R. NETWORK	
	R497	QRE141J-104Y	100K 1/4W R. NETWORK	
	R498	QRE141J-104Y	100K 1/4W R. NETWORK	
	R881	QRZ0209-4R7	4.7 2W OXIDE METAL	
	R882	QRZ0209-4R7	4.7 2W OXIDE METAL	
	R883	QRZ0209-4R7	4.7 2W OXIDE METAL	
	R884	QRZ0209-4R7	4.7 2W OXIDE METAL	
	R1341	QRE141J-104Y	100K 1/4W R. NETWORK	
	R1342	QRE141J-103Y	10K 1/4W R. NETWORK	
	R1343	QRE141J-203Y	20K 1/4W R. NETWORK	
	R1344	QRE141J-203Y	20K 1/4W R. NETWORK	
	R1345	QRE141J-273Y	27K 1/4W R. NETWORK	
	R1346	QRE141J-223Y	22K 1/4W R. NETWORK	
	R1347	QRE141J-132Y	1.3K 1/4W R. NETWORK	
	R1348	QRE141J-182Y	1.8K 1/4W R. NETWORK	
	R1349	QRZ9005-680X	68 FUSIBLE	
	R1350	QRZ9005-680X	68 FUSIBLE	
	R1351	QRE141J-222Y	2.2K 1/4W R. NETWORK	
	R1352	QRE141J-222Y	2.2K 1/4W R. NETWORK	
	R1353	QRE141J-682Y	6.8K 1/4W R. NETWORK	
	R1354	QRE141J-752Y	7.5K 1/4W R. NETWORK	
	R1355	QRE141J-104Y	100K 1/4W R. NETWORK	
	R1589	QRE141J-102Y	1K 1/4W R. NETWORK	
	R1590	QRE141J-473Y	47K 1/4W R. NETWORK	
	R1591	QRE141J-103Y	10K 1/4W R. NETWORK	
	R1592	QRE141J-103Y	10K 1/4W R. NETWORK	
	R1593	QRE141J-103Y	10K 1/4W R. NETWORK	
	R1594	QRE141J-103Y	10K 1/4W R. NETWORK	
	R1595	QRE141J-102Y	1K 1/4W R. NETWORK	
	R1596	QRE141J-102Y	1K 1/4W R. NETWORK	
		OTHERS		
	J400	QND0026-001	PIN JACK	
	S400	QSW0683-001Z	PUSH SWITCH	
	S401	QSW0683-001Z	PUSH SWITCH	
	S402	QSW0683-001Z	PUSH SWITCH	
	S407	QSW0683-001Z	PUSH SWITCH	
	S408	QSW0683-001Z	PUSH SWITCH	
	S409	QSW0683-001Z	PUSH SWITCH	
	S410	QSW0683-001Z	PUSH SWITCH	
	S411	QSW0683-001Z	PUSH SWITCH	
	S412	QSW0683-001Z	PUSH SWITCH	
	S413	QSW0683-001Z	PUSH SWITCH	
	S414	QSW0683-001Z	PUSH SWITCH	
	S415	QSW0683-001Z	PUSH SWITCH	
	S416	QSW0683-001Z	PUSH SWITCH	
	S417	QSW0683-001Z	PUSH SWITCH	
	S418	QSW0683-001Z	PUSH SWITCH	
	S419	QSW0683-001Z	PUSH SWITCH	

△	Item	Parts Number	Description	Area
	S420	QSW0683-001Z	PUSH SWITCH	
	X400	QAX0112-001Z	RESONATOR I. M	
	X401	QAX0246-001Z	RESONATOR I. M	
	BK400	E308566-001	FL HOLDER	
	BK401	E308566-002	FL HOLDER	
	BK499	E70225-002	EARTH PLATE	
	CN061	QGB2510K1-08	CONNECTOR	
	CN062	QGB2510K1-08	CONNECTOR	
	CN063	QGB2510K1-05	CONNECTOR	
	CN071	QGB2510K1-08	CONNECTOR	
	CN072	QGB2510K1-08	CONNECTOR	
	CN073	QGB2510K1-05	CONNECTOR	
	CN341	QGB2510K1-08	CONNECTOR	
	CN406	EWS21A-001	SOCKET WIRE ASSY	
	CN410	QGF1205F1-31	CONNECTOR	
	CN412	QGF1210G1-21	CONNECTOR	
	CN420	EWS26A-F908J	SOCKET WIRE ASSY	
	CN422	QGA2001F1-14	14P PLUG ASSY	
	CN430	QGA2001F1-10	10P PLUG ASSY	
	CN432	EWS26E-F908J	SOCKET WIRE ASSY	
	CN450	EWS26A-A940J	SOCKET WIRE ASSY	
	CN881	QGD2501C1-03Z	SOCKET I. M	
	DI400	QLF0042-001	FLUORESCENT DISPLAY TUBE	
	FS400	E3400-444	FELT SPACER	
	FS401	E3400-444	FELT SPACER	
	FS489	E3400-431	FELT SPACER	
	JS400	QSW0502-001	SW	
	JS401	QSW0672-001	ROTARY SWITCH	
	JS402	QSW0672-001	ROTARY SWITCH	

■ Electrical Parts List (Control P.C.B)

△	Item	Parts Number	Description	Area
		I. C. S		
	IC201	BA7625	I. C (MONO-ANALOG)	
	IC202	NJM2285D	I. C (M)	
	IC203	MB90089PF-206	I. C (M)	
	IC241	BA7626	I. C (MONO-ANALOG)	
	IC242	BA7625	I. C (MONO-ANALOG)	
	IC301	NJM4580D-D	I. C.	
	IC304	TC9164AN	I. C (DIGI-MOS)	
	IC305	NJM4580L	I. C (MONO-ANALOG)	
	IC311	TC9163AN	I. C (DIGI-MOS)	
	IC391	BA15218N	I. C (MONO-ANALOG)	
		DIODES		
	D200	1SS133-T2	SI. DIODE	
	D201	1SS133-T2	SI. DIODE	
		TRANSISTORS		
	Q200	2SA933S/RS/-T	SILICON	
	Q201	2SA933S/RS/-T	SILICON	
	Q202	DTG143TS-T	SILICON	
	Q203	DTG114YS-T	SILICON	
	Q204	2SA933S/RS/-T	SILICON	
	Q205	2SA933S/RS/-T	SILICON	
	Q206	2SA933S/RS/-T	SILICON	
	Q240	2SA933S/RS/-T	SILICON	
	Q241	2SA933S/RS/-T	SILICON	
	Q301	2SC2878/AB/-T	SILICON	
	Q302	2SC2878/AB/-T	SILICON	
		CAPACITORS		
	C201	QETB1HM-475E	4.7MF 50V E. CAP.	
	C202	QETB1HM-475E	4.7MF 50V E. CAP.	
	C203	QETB0JM-477	470MF 6.3V AL E. CAP.	
	C204	QETB1HM-475E	4.7MF 50V E. CAP.	
	C205	QETB0JM-477	470MF 6.3V AL E. CAP.	
	C206	QETB1HM-475E	4.7MF 50V E. CAP.	
	C207	QETB0JM-477	470MF 6.3V AL E. CAP.	
	C208	QETC1AM-476ZM	47MF 10V E. CAP.	
	C209	QCF31HZ-103Z	0.01MF 50V CERAMIC	
	C210	QETB1HM-475E	4.7MF 50V E. CAP.	
	C211	QETB1HM-107	100MF 50V E. CAP.	
	C212	QETC1AM-476ZM	47MF 10V E. CAP.	
	C213	QCF31HZ-103Z	0.01MF 50V CERAMIC	
	C214	QETB1HM-475E	4.7MF 50V E. CAP.	
	C215	QETB1HM-475E	4.7MF 50V E. CAP.	
	C216	QDX31EM-473Z	0.047MF 25V C CAP.	
	C217	QETB1AM-477	470MF 10V E. CAP.	
	C218	QCZ0202-155	1.5MF 25V CER. CAP.	
	C219	QDC31HJ-150Z	15PF 50V C CAP.	
	C220	QDC31HJ-100Z	10PF 50V C. CAPA. I. M	
	C221	QDC31HJ-470Z	47PF 50V C. CAPA. I. M	
	C222	QDC31HJ-270Z	27PF 50V ACCAPA. I. M	
	C223	QCB1HK-102	1000PF 50V CER. CAP.	
	C224	QCB1HK-271Y	270PF 50V CER. CAP.	
	C225	QCB1HK-121Y	120PF 50V CER. CAP.	
	C241	QDX31EM-473Z	0.047MF 25V C CAP.	
	C242	QETB1HM-475E	4.7MF 50V E. CAP.	
	C244	QDX31EM-473Z	0.047MF 25V C CAP.	
	C245	QETB1HM-475E	4.7MF 50V E. CAP.	
	C246	QDX31EM-473Z	0.047MF 25V C CAP.	
	C247	QETB0JM-477	470MF 6.3V AL E. CAP.	
	C249	QDX31EM-473Z	0.047MF 25V C CAP.	
	C250	QETB1HM-475E	4.7MF 50V E. CAP.	
	C251	QDX31EM-473Z	0.047MF 25V C CAP.	
	C252	QETB0JM-477	470MF 6.3V AL E. CAP.	
	C254	QDX31EM-473Z	0.047MF 25V C CAP.	
	C255	QETB1HM-475E	4.7MF 50V E. CAP.	
	C256	QCF31HZ-103Z	0.01MF 50V CERAMIC	
	C257	QETC1AM-476ZM	47MF 10V E. CAP.	

△	Item	Parts Number	Description	Area
	C258	QCF31HZ-103Z	0.01MF 50V CERAMIC	
	C259	QETC1AM-476ZM	47MF 10V E. CAP.	
	C260	QDX31EM-473Z	0.047MF 25V C CAP.	
	C261	QETB1HM-475E	4.7MF 50V E. CAP.	
	C268	QCS21HJ-470	47PF 50V CER. CAP.	
	C269	QCS21HJ-470	47PF 50V CER. CAP.	
	C270	QCS21HJ-470	47PF 50V CER. CAP.	
	C271	QCS21HJ-470	47PF 50V CER. CAP.	
	C277	QCS21HJ-470	47PF 50V CER. CAP.	
	C301	QETB1HM-475E	4.7MF 50V E. CAP.	
	C302	QETB1HM-475E	4.7MF 50V E. CAP.	
	C303	QCS21HJ-101A	100PF 50V CER. CAP.	
	C304	QCS21HJ-101A	100PF 50V CER. CAP.	
	C305	QFLB1HJ-182	1800PF 50V MYLAR CAP.	
	C306	QFLB1HJ-182	1800PF 50V MYLAR CAP.	
	C307	QFLB1HJ-682	6800PF 50V MYLAR CAP.	
	C308	QFLB1HJ-682	6800PF 50V MYLAR CAP.	
	C309	QCS21HJ-101A	100PF 50V CER. CAP.	
	C310	QCS21HJ-101A	100PF 50V CER. CAP.	
	C311	QETB1HM-475E	4.7MF 50V E. CAP.	
	C312	QETB1HM-475E	4.7MF 50V E. CAP.	
	C313	QETC1AM-107ZN	100MF 10V E. CAP.	
	C314	QETC1AM-107ZN	100MF 10V E. CAP.	
	C315	QETB1CM-476	47MF 16V AL E. CAP.	
	C316	QETB1CM-476	47MF 16V AL E. CAP.	
	C317	QETB1EM-226N	22MF 25V E. CAP.	
	C318	QETB1EM-226N	22MF 25V E. CAP.	
	C319	QCF31HZ-223Z	0.022MF 50V CERAMIC	
	C320	QCF31HZ-223Z	0.022MF 50V CERAMIC	
	C321	QETB1EM-226N	22MF 25V E. CAP.	
	C322	QETB1EM-226N	22MF 25V E. CAP.	
	C337	QETB1HM-475E	4.7MF 50V E. CAP.	
	C338	QETB1HM-475E	4.7MF 50V E. CAP.	
	C339	QETB1EM-226N	22MF 25V E. CAP.	
	C340	QETB1EM-226N	22MF 25V E. CAP.	
	C351	QCF31HZ-223Z	0.022MF 50V CERAMIC	
	C352	QCF31HZ-223Z	0.022MF 50V CERAMIC	
	C358	QCB1HK-561Y	560PF 50V CER. CAP.	
	C361	QCF31HZ-223Z	0.022MF 50V CERAMIC	
	C362	QCF31HZ-223Z	0.022MF 50V CERAMIC	
	C363	QETB1EM-226N	22MF 25V E. CAP.	
	C364	QETB1EM-226N	22MF 25V E. CAP.	
	C368	QCB1HK-471Y	470PF 50V CER. CAP.	
	C369	QCB1HK-331Y	330PF 50V CER. CAP.	
	C370	QCB1HK-561Y	560PF 50V CER. CAP.	
	C371	QETB1EM-476	47MF 25V AL E. CAP.	
	C372	QETB1EM-476	47MF 25V AL E. CAP.	
	C373	QETB1HM-475E	4.7MF 50V E. CAP.	
	C374	QETB1HM-475E	4.7MF 50V E. CAP.	
	C1250	QCB1HK-221Y	220PF 50V CER. CAP.	
	C1251	QCB1HK-221Y	220PF 50V CER. CAP.	
	C1252	QCB1HK-221Y	220PF 50V CER. CAP.	
		RESISTORS		
	R200	QRE141J-750Y	75 1/4W R. NETWORK	
	R201	QRE141J-750Y	75 1/4W R. NETWORK	
	R202	QRE141J-750Y	75 1/4W R. NETWORK	
	R203	QRE141J-750Y	75 1/4W R. NETWORK	
	R204	QRE141J-750Y	75 1/4W R. NETWORK	
	R205	QRE141J-750Y	75 1/4W R. NETWORK	
	R206	QRE141J-750Y	75 1/4W R. NETWORK	
	R207	QRE141J-331Y	330 1/4W R. NETWORK	
	R208	QRE141J-331Y	330 1/4W R. NETWORK	
	R209	QRE141J-473Y	47K 1/4W R. NETWORK	
	R210	QRE141J-331Y	330 1/4W R. NETWORK	
	R211	QRE141J-473Y	47K 1/4W R. NETWORK	
	R212	QRE141J-331Y	330 1/4W R. NETWORK	

■ Electrical Parts List (Control P.C.B)

△	Item	Parts Number	Description	Area
	R213	QRE141J-473Y	47K 1/4W R. NETWORK	
	R214	QRE141J-151Y	150 1/4W R. NETWORK	
	R215	QRE141J-151Y	150 1/4W R. NETWORK	
	R216	QRE141J-301Y	300 1/4W R. NETWORK	
	R217	QRE141J-103Y	10K 1/4W R. NETWORK	
	R218	QRE141J-331Y	330 1/4W R. NETWORK	
	R219	QRE141J-101Y	100 1/4W R. NETWORK	
	R220	QRE141J-121Y	120 1/4W R. NETWORK	
	R221	QRE141J-151Y	150 1/4W R. NETWORK	
	R222	QRE141J-561Y	560 1/4W R. NETWORK	
	R223	QRE141J-561Y	560 1/4W R. NETWORK	
	R224	QRE141J-561Y	560 1/4W R. NETWORK	
	R225	QRJ146J-3R3X	3.3 1/4W R. NETWORK	
	R240	QRE141J-750Y	75 1/4W R. NETWORK	
	R241	QRE141J-750Y	75 1/4W R. NETWORK	
	R242	QRE141J-750Y	75 1/4W R. NETWORK	
	R243	QRE141J-750Y	75 1/4W R. NETWORK	
	R244	QRE141J-750Y	75 1/4W R. NETWORK	
	R245	QRE141J-750Y	75 1/4W R. NETWORK	
	R246	QRE141J-750Y	75 1/4W R. NETWORK	
	R247	QRE141J-750Y	75 1/4W R. NETWORK	
	R248	QRE141J-151Y	150 1/4W R. NETWORK	
	R249	QRE141J-121Y	120 1/4W R. NETWORK	
	R256	QRE141J-472Y	4.7K 1/4W R. NETWORK	
	R257	QRE141J-471Y	470 1/4W R. NETWORK	
	R258	QRE141J-472Y	4.7K 1/4W R. NETWORK	
	R259	QRE141J-471Y	470 1/4W R. NETWORK	
	R264	QRE141J-103Y	10K 1/4W R. NETWORK	
	R265	QRE141J-103Y	10K 1/4W R. NETWORK	
	R266	QRE141J-750Y	75 1/4W R. NETWORK	
	R267	QRE141J-473Y	47K 1/4W R. NETWORK	
	R268	QRE141J-750Y	75 1/4W R. NETWORK	
	R269	QRE141J-473Y	47K 1/4W R. NETWORK	
	R271	QRJ146J-6R8X	6.8 1/4W R. NETWORK	
	R301	QRE141J-222Y	2.2K 1/4W R. NETWORK	
	R302	QRE141J-222Y	2.2K 1/4W R. NETWORK	
	R303	QRE141J-473Y	47K 1/4W R. NETWORK	
	R304	QRE141J-473Y	47K 1/4W R. NETWORK	
	R305	QRE141J-621Y	620 1/4W R. NETWORK	
	R306	QRE141J-621Y	620 1/4W R. NETWORK	
	R307	QRE141J-393Y	39K 1/4W R. NETWORK	
	R308	QRE141J-393Y	39K 1/4W R. NETWORK	
	R309	QRE141J-474Y	470K 1/4W R. NETWORK	
	R310	QRE141J-474Y	470K 1/4W R. NETWORK	
	R311	QRE141J-104Y	100K 1/4W R. NETWORK	
	R312	QRE141J-104Y	100K 1/4W R. NETWORK	
	R313	QRJ146J-331X	330 1/4W R. NETWORK	
	R314	QRJ146J-331X	330 1/4W R. NETWORK	
	R315	QRZ9005-680X	68 FUSIBLE	
	R316	QRZ9005-680X	68 FUSIBLE	
	R325	QRE141J-471Y	470 1/4W R. NETWORK	
	R326	QRE141J-471Y	470 1/4W R. NETWORK	
	R327	QRE141J-471Y	470 1/4W R. NETWORK	
	R328	QRE141J-471Y	470 1/4W R. NETWORK	
	R329	QRE141J-471Y	470 1/4W R. NETWORK	
	R330	QRE141J-471Y	470 1/4W R. NETWORK	
	R335	QRE141J-104Y	100K 1/4W R. NETWORK	
	R336	QRE141J-104Y	100K 1/4W R. NETWORK	
	R337	QRE141J-104Y	100K 1/4W R. NETWORK	
	R338	QRE141J-104Y	100K 1/4W R. NETWORK	
	R339	QRE141J-104Y	100K 1/4W R. NETWORK	
	R340	QRE141J-104Y	100K 1/4W R. NETWORK	
	R353	QRZ9005-680X	68 FUSIBLE	
	R354	QRZ9005-680X	68 FUSIBLE	
	R355	QRE141J-471Y	470 1/4W R. NETWORK	
	R356	QRE141J-471Y	470 1/4W R. NETWORK	

△	Item	Parts Number	Description	Area
	R357	QRE141J-471Y	470 1/4W R. NETWORK	
	R358	QRE141J-471Y	470 1/4W R. NETWORK	
	R359	QRE141J-471Y	470 1/4W R. NETWORK	
	R360	QRE141J-471Y	470 1/4W R. NETWORK	
	R361	QRE141J-471Y	470 1/4W R. NETWORK	
	R362	QRE141J-471Y	470 1/4W R. NETWORK	
	R363	QRE141J-471Y	470 1/4W R. NETWORK	
	R364	QRE141J-471Y	470 1/4W R. NETWORK	
	R365	QRE141J-471Y	470 1/4W R. NETWORK	
	R366	QRE141J-471Y	470 1/4W R. NETWORK	
	R379	QRE141J-471Y	470 1/4W R. NETWORK	
	R380	QRE141J-471Y	470 1/4W R. NETWORK	
	R381	QRE141J-183Y	18K 1/4W CARBON RES	
	R382	QRE141J-202Y	2K 1/4W R. NETWORK	
	R383	QRE141J-104Y	100K 1/4W R. NETWORK	
	R384	QRE141J-104Y	100K 1/4W R. NETWORK	
	R385	QRE141J-471Y	470 1/4W R. NETWORK	
	R386	QRE141J-471Y	470 1/4W R. NETWORK	
	R387	QRE141J-103Y	10K 1/4W R. NETWORK	
	R388	QRE141J-103Y	10K 1/4W R. NETWORK	
	R1250	QRE141J-101Y	100 1/4W R. NETWORK	
	R1251	QRE141J-221Y	220 1/4W R. NETWORK	
	R1252	QRE141J-221Y	220 1/4W R. NETWORK	
	R1253	QRE141J-471Y	470 1/4W R. NETWORK	
	R1254	QRE141J-221Y	220 1/4W R. NETWORK	
		OTHERS		
		QUB220-10HPPH	WIRE	
	J201	QNN0078-001	PIN JACK	
	J202	QNN0067-001	PIN JACK	
	J203	QNN0078-001	PIN JACK	
	J241	QND0002-001	CONNECT TERMINAL	
	J242	QND0028-001	PIN JACK	
	J243	QND0024-001	PIN JACK	
	J301	QNN0056-001	PIN JACK	
	J302	QNN0056-001	PIN JACK	
	J311	QNN0056-001	PIN JACK	
	J312	QNN0056-001	PIN JACK	
	J313	QNN0056-001	PIN JACK	
	J314	QNN0107-001	PIN JACK	
	L200	QGL231K-220Y	INDUCTOR	
	X200	QAX0261-001Z	CRYSTAL	
	CN200	QGB2510K1-04	CONNECTOR	
	CN202	QGA2001F1-10	10P PLUG ASSY	
	CN204	QGB1214K1-14S	CONNECT TERMINAL	
	CN205	QGB1214J1-14S	CONNECT TERMINAL	
	CN206	QGA2501F1-02	CONNECTOR	
	CN240	QGB2510K1-04	CONNECTOR	
	CN242	QGB1214K1-14S	CONNECT TERMINAL	
	CN243	QGB1214J1-14S	CONNECT TERMINAL	
	CN244	QGA2501F1-04	CONNECTOR	
	CN254	QGB2510K1-05	CONNECTOR	
	CN311	QGB2510K1-17	CONNECTOR	
	CN313	QGB2510K1-14	CONNECTOR	
	CN416	QGA2501F1-03	CONNECTOR	
	J1250	QNS0077-001	PIN JACK	
	J1251	QNS0083-001	PIN JACK	
	SW200	QSW0673-001	LEVER SWITCH	

■ Electrical Parts List (AC Supply P.C.B)

△	Item	Parts Number	Description	Area
		DIODES		
	D051	1SR139-200-T4	SILICON	
	D052	1SR139-200-T4	SILICON	
	D053	1SR139-200-T4	SILICON	
	D054	1SR139-200-T4	SILICON	
	D055	MTZJ12C-T2	ZENER	
	D056	MTZJ6. 2A-T2	ZENER	
	D057	1SS133-T2	SI. DIODE	
△	D061	10E2-FD	DIODE	
	D062	1SR139-200-T4	SILICON	
△	D063	10E2-FD	DIODE	
	D064	1SR139-200-T4	SILICON	
	D065	1SS133-T2	SI. DIODE	
	D066	1SS133-T2	SI. DIODE	
	D071	1SR139-200-T4	SILICON	
	D072	1SR139-200-T4	SILICON	
	D073	1SR139-200-T4	SILICON	
	D074	MTZJ33C-T2	ZENER	
	D075	MTZJ6. 2C-T2	ZENER	
	D701	1SS133-T2	SI. DIODE	
	D702	1SS133-T2	SI. DIODE	
	D703	1SS133-T2	SI. DIODE	
	D704	1SS133-T2	SI. DIODE	
△	D801	30DF2-FC	SILICON	
△	D802	30DF2-FC	SILICON	
△	D803	30DF2-FC	SILICON	
△	D804	30DF2-FC	SILICON	
△	D805	30DF2-FC	SILICON	
△	D806	30DF2-FC	SILICON	
△	D807	30DF2-FC	SILICON	
△	D808	30DF2-FC	SILICON	
	D951	1SS133-T2	SI. DIODE	
	D952	1SS133-T2	SI. DIODE	
	D1701	1SS133-T2	SI. DIODE	
	D1702	MTZJ18C-T2	ZENER	
	D1771	1SS133-T2	SI. DIODE	
	D1772	1SS133-T2	SI. DIODE	
	D1791	1SS133-T2	SI. DIODE	
	D1801	1SS133-T2	SI. DIODE	
	D1802	1SS133-T2	SI. DIODE	
	D1805	MTZJ18C-T2	ZENER	
	D1871	1SS133-T2	SI. DIODE	
	D1872	1SS133-T2	SI. DIODE	
	D1873	1SS133-T2	SI. DIODE	
	D1874	1SS133-T2	SI. DIODE	
	D1891	1SS133-T2	SI. DIODE	
	D1892	1SS133-T2	SI. DIODE	
		TRANSISTORS		
	Q051	2SD1266/QP/	SILICON	
	Q052	2SC2235/OY/-T	SILICON	
	Q053	DTC123YS-T	SILICON	
	Q061	DTC114YS-T	SILICON	
	Q071	2SB1357/EF/-T	SILICON	
	Q072	DTC114ES	DIGITAL TRANSISTOR	
	Q073	DTA144ES-T	SILICON	
	Q074	2SC2240/GL/-T	SILICON	
	Q701	2SC2240-BL/AB/	SI. TRANSISTOR	
	Q702	2SC2240-BL/AB/	SI. TRANSISTOR	
	Q703	2SC2240-BL/AB/	SI. TRANSISTOR	
	Q704	2SC2240-BL/AB/	SI. TRANSISTOR	
	Q705	2SA1038S/SE/-T	SILICON	
	Q706	2SA1038S/SE/-T	SILICON	
	Q707	2SA933LN/RS/-T	SILICON	
	Q708	2SA933LN/RS/-T	SILICON	
	Q709	2SA1038S/SE/-T	SILICON	
	Q710	2SA1038S/SE/-T	SILICON	

△	Item	Parts Number	Description	Area
	Q711	2SC2389S/SE/-T	SI. TRANSISTOR	
	Q712	2SC2389S/SE/-T	SI. TRANSISTOR	
	Q1701	2SC2240-BL/AB/	SI. TRANSISTOR	
	Q1702	2SC2240-BL/AB/	SI. TRANSISTOR	
	Q1703	2SA1038S/S/-T	SILICON	
	Q1731	2SD636/QR/	SILICON	
	Q1771	2SC2389S/SE/-T	SI. TRANSISTOR	
	Q1772	2SA1038S/SE/-T	SILICON	
	Q1791	2SC2389S/SE/-T	SI. TRANSISTOR	
	Q1801	2SC2240-BL/AB/	SI. TRANSISTOR	
	Q1802	2SC2240-BL/AB/	SI. TRANSISTOR	
	Q1803	2SC2240-BL/AB/	SI. TRANSISTOR	
	Q1804	2SC2240-BL/AB/	SI. TRANSISTOR	
	Q1805	2SA1038S/S/-T	SILICON	
	Q1806	2SA1038S/S/-T	SILICON	
	Q1831	2SD636/QR/	SILICON	
	Q1832	2SD636/QR/	SILICON	
	Q1871	2SC2389S/SE/-T	SI. TRANSISTOR	
	Q1872	2SC2389S/SE/-T	SI. TRANSISTOR	
	Q1873	2SA1038S/SE/-T	SILICON	
	Q1874	2SA1038S/SE/-T	SILICON	
	Q1891	2SC2389S/SE/-T	SI. TRANSISTOR	
	Q1892	2SC2389S/SE/-T	SI. TRANSISTOR	
		CAPACITORS		
△	C001	QCZ9019-472	4700PF C. CAP.	
△	C002	QCZ9019-472	4700PF C. CAP.	
	C003	QOBB1HK-391Y	390PF 50V CER. CAP.	
	C051	QFN82AK-472	4700PF 100V METAL. MYLAR	
	C052	QETM1JM-477	470MF 63V ELECTRO	
	C053	QCF31HZ-472Z	4700PF 50V CERAMIC	
	C054	QETN1CM-477Z	470MF 16V ELECTRO	
	C055	QCF31HZ-472Z	4700PF 50V CERAMIC	
	C061	QFN82AJ-104	0.1MF 100V MYLAR CAP.	
	C062	QFN82AJ-104	0.1MF 100V MYLAR CAP.	
	C063	QFN82AJ-104	0.1MF 100V MYLAR CAP.	
	C065	QETB1VM-338	3300MF 35V AL. E. CAP.	
	C066	QETB1VM-228N	2200MF 35V E. CAP.	
	C067	QETB1HM-475E	4.7MF 50V E. CAP.	
	C068	QFLB1HJ-473	0.047MF 50V MYLAR CAP.	
	C069	QFLB1HJ-473	0.047MF 50V MYLAR CAP.	
	C070	QETB1HM-227	220MF 50V E. CAP.	
	C071	QETN1JM-227Z	220MF 63V ELECTRO	
	C072	QETB1HM-228E	22MF 50V E. CAP.	
	C073	QETB1HM-228E	22MF 50V E. CAP.	
	C074	QETB1HM-105	1MF 50V AL. E. CAP.	
	C091	QOBB1HK-331Y	330PF 50V CER. CAP.	
	C092	QOBB1HK-331Y	330PF 50V CER. CAP.	
	C705	QCS21HJ-101A	100PF 50V CER. CAP.	
	C706	QCS21HJ-101A	100PF 50V CER. CAP.	
	C710	QCS22HJ-220	22PF 500V CER. CAP.	
	C711	QFLB1HJ-152	1500PF 50V MYLAR CAP.	
	C712	QFLB1HJ-152	1500PF 50V MYLAR CAP.	
	C713	QCS21HJ-680A	68PF 50V CER. CAP.	
	C714	QCS21HJ-680A	68PF 50V CER. CAP.	
	C715	QCS21HJ-680A	68PF 50V CER. CAP.	
	C716	QCS21HJ-680A	68PF 50V CER. CAP.	
	C717	QCS22HJ-220	22PF 500V CER. CAP.	
	C801	QFN82CK-104	0.1MF 160V METAL. MYLAR	
	C802	QFN82CK-104	0.1MF 160V METAL. MYLAR	
	C803	QFN82CK-104	0.1MF 160V METAL. MYLAR	
	C804	QFN82CK-104	0.1MF 160V METAL. MYLAR	
	C805	QFN82CK-104	0.1MF 160V METAL. MYLAR	
	C1701	QETB1HM-106	10MF 50V E. CAP.	
	C1702	QCS21HJ-101A	100PF 50V CER. CAP.	
	C1703	QCS21HJ-101A	100PF 50V CER. CAP.	
	C1704	QETB1CM-476	47MF 16V AL. E. CAP.	

■ Electrical Parts List (AC Supply P.C.B)

△	Item	Parts Number	Description	Area
	C1705	QCS21HJ-5R0	5PF 50V CER. CAP.	
	C1711	QCS22HJ-330	33PF 500V CER. CAP.	
	C1712	QFLB1HJ-103	0.01MF 50V MYLAR CAP.	
	C1713	QETB1HM-225	2.2MF 50V AL. E. CAP.	
	C1714	QCF31HZ-223Z	0.022MF 50V CERAMIC	
	C1715	QETB1HM-476	47MF 50V E. CAP.	
	C1741	QETB1JM-476	47MF 63V AL. E. CAP.	
	C1742	QETB1JM-476	47MF 63V AL. E. CAP.	
	C1743	QETB1EM-476	47MF 25V AL. E. CAP.	
	C1751	QCS22HJ-470A	47PF 500V CER. CAP.	
	C1752	QCS22HJ-470A	47PF 500V CER. CAP.	
	C1761	QFLB1HJ-473	0.047MF 50V MYLAR CAP.	
	C1762	QFLB1HJ-473	0.047MF 50V MYLAR CAP.	
	C1791	QCF31HZ-223Z	0.022MF 50V CERAMIC	
	C1801	QETB1HM-106	10MF 50V E. CAP.	
	C1802	QETB1HM-106	10MF 50V E. CAP.	
	C1803	QCS21HJ-101A	100PF 50V CER. CAP.	
	C1804	QCS21HJ-101A	100PF 50V CER. CAP.	
	C1805	QCS21HJ-101A	100PF 50V CER. CAP.	
	C1806	QCS21HJ-101A	100PF 50V CER. CAP.	
	C1807	QETB1CM-476	47MF 16V AL. E. CAP.	
	C1808	QETB1CM-476	47MF 16V AL. E. CAP.	
	C1809	QCS21HJ-5R0	5PF 50V CER. CAP.	
	C1810	QCS21HJ-5R0	5PF 50V CER. CAP.	
	C1811	QCS22HJ-330	33PF 500V CER. CAP.	
	C1812	QCS22HJ-330	33PF 500V CER. CAP.	
	C1813	QFLB1HJ-103	0.01MF 50V MYLAR CAP.	
	C1814	QFLB1HJ-103	0.01MF 50V MYLAR CAP.	
	C1815	QEK01HM-225Z	2.2MF 50V ELECTRO	
	C1816	QEK01HM-225Z	2.2MF 50V ELECTRO	
	C1817	QETB1HM-476	47MF 50V E. CAP.	
	C1818	QETB1HM-476	47MF 50V E. CAP.	
	C1841	QETB1JM-476	47MF 63V AL. E. CAP.	
	C1842	QETB1JM-476	47MF 63V AL. E. CAP.	
	C1843	QETB1EM-106	10MF 25V AL. E. CAP.	
	C1851	QCS22HJ-470A	47PF 500V CER. CAP.	
	C1852	QCS22HJ-470A	47PF 500V CER. CAP.	
	C1853	QCS22HJ-470A	47PF 500V CER. CAP.	
	C1854	QCS22HJ-470A	47PF 500V CER. CAP.	
	C1861	QFLB1HJ-473	0.047MF 50V MYLAR CAP.	
	C1862	QFLB1HJ-473	0.047MF 50V MYLAR CAP.	
	C1863	QFLB1HJ-473	0.047MF 50V MYLAR CAP.	
	C1864	QFLB1HJ-473	0.047MF 50V MYLAR CAP.	
	C1891	QCF31HZ-223Z	0.022MF 50V CERAMIC	
	C1892	QCF31HZ-223Z	0.022MF 50V CERAMIC	
		RESISTORS		
	R051	QRJ146J-153X	15K 1/4W R. NETWORK	
	R052	QRL012J-332	3.3K 1W R. NETWORK	
	R053	QRZ9015-3R3	3.3 COMPOSITION	
	R054	QRE141J-821Y	820 1/4W R. NETWORK	
	R061	QRT012J-R22	0.22 1W R. NETWORK	
	R062	QRT012J-R22	0.22 1W R. NETWORK	
	R065	QRT022J-1R0	1 2W R. NETWORK	
	R066	QRJ146J-2R2X	2.2 1/4W R. NETWORK	
	R067	QRJ146J-120X	12 1/4W R. NETWORK	
	R068	QRE141J-562Y	5.6K 1/4W R. NETWORK	
	R069	QRE141J-822Y	8.2K 1/4W R. NETWORK	
	R070	QRE141J-103Y	10K 1/4W R. NETWORK	
	R072	QRJ146J-332X	3.3K 1/4W R. NETWORK	
	R073	QRE141J-223Y	22K 1/4W R. NETWORK	
	R074	QRE141J-104Y	100K 1/4W R. NETWORK	
	R081	QRE141J-104Y	100K 1/4W R. NETWORK	
	R082	QRE141J-104Y	100K 1/4W R. NETWORK	
	R083	QRE141J-104Y	100K 1/4W R. NETWORK	
	R091	QRL022J-471	470 2W OXIDE METAL	
	R092	QRL022J-471	470 2W OXIDE METAL	

△	Item	Parts Number	Description	Area
	R705	QRE141J-202Y	2K 1/4W R. NETWORK	
	R706	QRE141J-202Y	2K 1/4W R. NETWORK	
	R707	QRE141J-202Y	2K 1/4W R. NETWORK	
	R708	QRE141J-202Y	2K 1/4W R. NETWORK	
	R709	QRE141J-912Y	9.1K 1/4W R. NETWORK	
	R710	QRE141J-912Y	9.1K 1/4W R. NETWORK	
	R717	QRJ146J-562X	5.6K 1/4W R. NETWORK	
	R718	QRJ146J-562X	5.6K 1/4W R. NETWORK	
	R719	QRK126J-103X	10K 1/2W R. NETWORK	
	R720	QRK126J-103X	10K 1/2W R. NETWORK	
	R721	QRJ146J-151X	150 1/4W CARBON RES.	
	R722	QRJ146J-151X	150 1/4W CARBON RES.	
	R723	QRE141J-391Y	390 1/4W R. NETWORK	
	R724	QRE141J-391Y	390 1/4W R. NETWORK	
	R725	QRE141J-152Y	1.5K 1/4W R. NETWORK	
	R726	QRE141J-152Y	1.5K 1/4W R. NETWORK	
	R727	QRE141J-333Y	33K 1/4W R. NETWORK	
	R728	QRE141J-333Y	33K 1/4W R. NETWORK	
	R729	QRE141J-391Y	390 1/4W R. NETWORK	
	R730	QRE141J-391Y	390 1/4W R. NETWORK	
	R731	QRE141J-391Y	390 1/4W R. NETWORK	
	R732	QRE141J-391Y	390 1/4W R. NETWORK	
	R733	QRE141J-101Y	100 1/4W R. NETWORK	
	R734	QRE141J-101Y	100 1/4W R. NETWORK	
	R951	QRJ146J-120X	12 1/4W R. NETWORK	
	R952	QRJ146J-120X	12 1/4W R. NETWORK	
	R1701	QRE141J-222Y	2.2K 1/4W R. NETWORK	
	R1702	QRE141J-104Y	100K 1/4W R. NETWORK	
	R1703	QRE141J-202Y	2K 1/4W R. NETWORK	
	R1705	QRE141J-123Y	12K 1/4W R. NETWORK	
	R1711	QRE141J-911Y	910 1/4W R. NETWORK	
	R1712	QRE141J-104Y	100K 1/4W R. NETWORK	
	R1721	QRJ146J-221X	220 1/4W R. NETWORK	
	R1722	QRE141J-392Y	3.9K 1/4W R. NETWORK	
	R1723	QRE141J-392Y	3.9K 1/4W R. NETWORK	
	R1724	QRE141J-392Y	3.9K 1/4W R. NETWORK	
	R1725	QRE141J-392Y	3.9K 1/4W R. NETWORK	
	R1731	QRE141J-751Y	750 1/4W R. NETWORK	
	R1732	QRE141J-391Y	390 1/4W R. NETWORK	
	R1742	QRJ146J-331X	330 1/4W R. NETWORK	
	R1743	QRL022J-562	5.6K 2W R. NETWORK	
	R1751	QRJ146J-100X	10 1/4W R. NETWORK	
	R1752	QRJ146J-100X	10 1/4W R. NETWORK	
	R1753	QRZ0197-R22	0.22 1W NETWORK RES.	
	R1761	QRJ125J-330	33 1/2W R. NETWORK	
	R1762	QRL022J-100	10 2W R. NETWORK	
	R1771	QRE141J-391Y	390 1/4W R. NETWORK	
	R1772	QRE141J-391Y	390 1/4W R. NETWORK	
	R1773	QRE141J-201Y	200 1/4W R. NETWORK	
	R1774	QRE141J-201Y	200 1/4W R. NETWORK	
	R1791	QRE141J-272Y	2.7K 1/4W R. NETWORK	
	R1792	QRE141J-153Y	15K 1/4W R. NETWORK	
	R1793	QRE141J-123Y	12K 1/4W R. NETWORK	
	R1794	QRE141J-104Y	100K 1/4W R. NETWORK	
	R1801	QRE141J-222Y	2.2K 1/4W R. NETWORK	
	R1802	QRE141J-222Y	2.2K 1/4W R. NETWORK	
	R1803	QRE141J-104Y	100K 1/4W R. NETWORK	
	R1804	QRE141J-104Y	100K 1/4W R. NETWORK	
	R1805	QRE141J-202Y	2K 1/4W R. NETWORK	
	R1806	QRE141J-202Y	2K 1/4W R. NETWORK	
	R1809	QRE141J-123Y	12K 1/4W R. NETWORK	
	R1810	QRE141J-123Y	12K 1/4W R. NETWORK	
	R1811	QRE141J-911Y	910 1/4W R. NETWORK	
	R1812	QRE141J-911Y	910 1/4W R. NETWORK	
	R1813	QRE141J-104Y	100K 1/4W R. NETWORK	
	R1814	QRE141J-104Y	100K 1/4W R. NETWORK	

■ Electrical Parts List (AC Supply P.C.B)

△	Item	Parts Number	Description	Area
	R1821	QRJ146J-221X	220 1/4W R. NETWORK	
	R1822	QRJ146J-221X	220 1/4W R. NETWORK	
	R1823	QRE141J-392Y	3.9K 1/4W R. NETWORK	
	R1824	QRE141J-392Y	3.9K 1/4W R. NETWORK	
	R1825	QRE141J-392Y	3.9K 1/4W R. NETWORK	
	R1826	QRE141J-392Y	3.9K 1/4W R. NETWORK	
	R1827	QRE141J-392Y	3.9K 1/4W R. NETWORK	
	R1828	QRE141J-392Y	3.9K 1/4W R. NETWORK	
	R1829	QRE141J-392Y	3.9K 1/4W R. NETWORK	
	R1830	QRE141J-392Y	3.9K 1/4W R. NETWORK	
	R1831	QRE141J-751Y	750 1/4W R. NETWORK	
	R1832	QRE141J-751Y	750 1/4W R. NETWORK	
	R1833	QRE141J-391Y	390 1/4W R. NETWORK	
	R1834	QRE141J-391Y	390 1/4W R. NETWORK	
	R1842	QRJ146J-331X	330 1/4W R. NETWORK	
	R1843	QRL022J-562	5.6K 2W R. NETWORK	
	R1851	QRJ146J-100X	10 1/4W R. NETWORK	
	R1852	QRJ146J-100X	10 1/4W R. NETWORK	
	R1853	QRJ146J-100X	10 1/4W R. NETWORK	
	R1854	QRJ146J-100X	10 1/4W R. NETWORK	
	R1855	QRZ0197-R22	0.22 1W NETWORK RES.	
	R1856	QRZ0197-R22	0.22 1W NETWORK RES.	
	R1861	QRJ125J-330	33 1/2W R. NETWORK	
	R1862	QRJ125J-330	33 1/2W R. NETWORK	
	R1863	QRL022J-100	10 2W R. NETWORK	
	R1864	QRL022J-100	10 2W R. NETWORK	
	R1871	QRE141J-391Y	390 1/4W R. NETWORK	
	R1872	QRE141J-391Y	390 1/4W R. NETWORK	
	R1873	QRE141J-391Y	390 1/4W R. NETWORK	
	R1874	QRE141J-391Y	390 1/4W R. NETWORK	
	R1875	QRE141J-201Y	200 1/4W R. NETWORK	
	R1876	QRE141J-201Y	200 1/4W R. NETWORK	
	R1877	QRE141J-201Y	200 1/4W R. NETWORK	
	R1878	QRE141J-201Y	200 1/4W R. NETWORK	
	R1891	QRE141J-272Y	2.7K 1/4W R. NETWORK	
	R1892	QRE141J-272Y	2.7K 1/4W R. NETWORK	
	R1893	QRE141J-153Y	15K 1/4W R. NETWORK	
	R1894	QRE141J-153Y	15K 1/4W R. NETWORK	
	R1895	QRE141J-123Y	12K 1/4W R. NETWORK	
	R1896	QRE141J-123Y	12K 1/4W R. NETWORK	
	R1897	QRE141J-104Y	100K 1/4W R. NETWORK	
	R1898	QRE141J-104Y	100K 1/4W R. NETWORK	
		OTHERS		
		QWE881-18RR	VINYL WIRE	
		QWE881-38RR	VINYL WIRE	
		QWE882-16RR	VINYL WIRE	
		QWE882-36RR	VINYL WIRE	
		QWE883-12RR	VINYL WIRE	
		QWE884-14RR	PIN WIRE	
		QWE884-20RR	VINYL WIRE	
		QWE886-12RR	VINYL WIRE	
		QWE886-16RR	PIN WIRE	
		QWE886-26RR	VINYL WIRE	
		QWE888-14RR	PIN WIRE	
		QYSBSG3008E	T. SCREW	
	G	QWE882-14RR	VINYL WIRE	
	H	QWE880-14RR	VINYL WIRE	
	10	QWE881-12RR	VINYL WIRE	
	J091	QNS0023-001	JACK	
△	S001	QSW0650-001	PUSH SWITCH	
△	T002	ETP1000-412B	POWER TRANSFORMER	
	CN051	QGB2510J1-08	CONNECTOR	
	CN052	QGB2510J1-08	CONNECTOR	
	CN053	QGB2510J1-05	CONNECTOR	
	CN055	QGD2501C1-03Z	SOCKET I.M	
	CN056	QGD2501C1-04Z	SOCKET I.M	

△	Item	Parts Number	Description	Area
	CN402	QGF1205C1-21	CONNECTOR	
	CN701	EWS216-007	SOCKET WIRE ASSY	
	CN703	EWS288-001	VINYL WIRE	
	CN705	QGB2510K1-12	CONNECTOR	
	CN811	QGA3901F2-03	CONNECTOR	
	CN951	EWS356-004	SOCKET WIRE ASSY	
	EP001	E409182-001SM	EARTH TERMINAL	
	EP002	QNZ0136-001Z	1M EARTH PLATE	
	EP051	QNZ0136-001Z	1M EARTH PLATE	
	FC001	QNG0020-001Z	FUSE CLIP	
	FC002	QNG0020-001Z	FUSE CLIP	
	FC003	QNG0020-001Z	FUSE CLIP	
	FC004	QNG0020-001Z	FUSE CLIP	
	FC005	QNG0020-001Z	FUSE CLIP	
	FC006	QNG0020-001Z	FUSE CLIP	
	FC061	QNG0020-001Z	FUSE CLIP	
	FC062	QNG0020-001Z	FUSE CLIP	
	FC063	QNG0020-001Z	FUSE CLIP	
	FC064	QNG0020-001Z	FUSE CLIP	
	FW051	EWR37D-10LS	FLAT WIRE	
	FW901	EWR33D-08LS	CORD	
	FW961	EWR33D-15LS	FLAT WIRE	
	HS051	E70945-H40B	HEAT SINK	
	L1761	QQLZ005-R45	INDUCTOR	
	L1861	QQLZ005-R45	INDUCTOR	
	L1862	QQLZ005-R45	INDUCTOR	
△	RY001	QSK0039-001	RELAY	
	RY061	QSK0082-001	RELAY	
	RY951	QSK0042-001	RELAY	
	RY952	QSK0042-001	RELAY	
	ST951	QNB0079-001	SPEAKER TERMINAL	
	TA001	QNZ0079-001Z	TAB I.M	
	TA002	QNZ0079-001Z	TAB I.M	
	TH071	QAD0095-4R7Z	POSITIVE THERMISTOR	
	TH731	QAD0012-202	THERMISTOR	
	TH831	QAD0012-202	THERMISTOR	
	TH832	QAD0012-202	THERMISTOR	
	VS001	QSW0524-001	LEVER SWITCH	

■ Electrical Parts List (AC-3 P.C.B)

△	Item	Parts Number	Description	Area
		I. C. S		
	IC501	NJM4580E-W	I. C (M)	
	IC511	NJM4580E-W	I. C (M)	
	IC521	NJM4580E-W	I. C (M)	
	IC551	NJM4580E-W	I. C (M)	
	IC561	NJM4580E-W	I. C (M)	
	IC571	NJM4580E-W	I. C (M)	
	IC581	NJM4580E-W	I. C (M)	
	IC591	NJM4580E-W	I. C (M)	
	IC601	CS4226-KQ	I. C (M)	
	IC631	XCF56009FJ88	I. C (M)	
	IC641	XCB56007FJ88	I. C (M)	
	IC651	N341256SJ-15-X	I. C (S-RAM)	
	IC661	TC74HCU04AF-W	I. C.	
	IC671	MN173222JABP1	I. C (M)	
	IC672	TC7504FU-X	I. C (M)	
	IC673	TC7532FU-X	I. C (M)	
		CAPACITORS		
	C501	NCB30JK-474X	0.47MF 6.3V CER. CAP.	
	C503	NEA21EM-475NZ	4.7MF 25V AL. E. CAP.	
	C504	NEA21EM-475NZ	4.7MF 25V AL. E. CAP.	
	C505	NGS31HJ-560X	56PF 50V C. CAP.	
	C506	NGS31HJ-560X	56PF 50V C. CAP.	
	C509	NCB31CK-104X	0.1MF 16V C. CAPA. C. M	
	C510	NCB31CK-104X	0.1MF 16V C. CAPA. C. M	
	C511	NCB30JK-474X	0.47MF 6.3V CER. CAP.	
	C513	NCB31CK-183X	0.018MF 16V C. CAPA. C. M.	
	C514	NCB31CK-183X	0.018MF 16V C. CAPA. C. M.	
	C515	NCB31HK-182X	1800PF 50V C. CAP.	
	C516	NCB31HK-182X	1800PF 50V C. CAP.	
	C517	NCB31HK-562X	5600PF 50V C. CAP.	
	C518	NCB31HK-562X	5600PF 50V C. CAP.	
	C519	NCB31CK-104X	0.1MF 16V C. CAPA. C. M	
	C520	NCB31CK-104X	0.1MF 16V C. CAPA. C. M	
	C521	NCB31CK-103X	0.01MF 16V C. CAPA. C. M	
	C522	NCB31CK-103X	0.01MF 16V C. CAPA. C. M	
	C523	NCB31HK-272X	2700PF 50V C. CAP.	
	C524	NCB31HK-272X	2700PF 50V C. CAP.	
	C525	NCB31HK-562X	5600PF 50V C. CAP.	
	C526	NCB31HK-562X	5600PF 50V C. CAP.	
	C527	NEA21HM-105NZ	1MF 50V AL. E. CAP.	
	C528	NEA21HM-105NZ	1MF 50V AL. E. CAP.	
	C529	NCB31CK-104X	0.1MF 16V C. CAPA. C. M	
	C530	NCB31CK-104X	0.1MF 16V C. CAPA. C. M	
	C551	NEA21HM-105NZ	1MF 50V AL. E. CAP.	
	C552	NEA21HM-105NZ	1MF 50V AL. E. CAP.	
	C553	NCS31HJ-220X	22PF 50V C. CAP.	
	C554	NCS31HJ-220X	22PF 50V C. CAP.	
	C559	NCB31CK-104X	0.1MF 16V C. CAPA. C. M	
	C560	NCB31CK-104X	0.1MF 16V C. CAPA. C. M	
	C561	NEA21HM-105NZ	1MF 50V AL. E. CAP.	
	C562	NEA21HM-105NZ	1MF 50V AL. E. CAP.	
	C563	NCS31HJ-220X	22PF 50V C. CAP.	
	C564	NCS31HJ-220X	22PF 50V C. CAP.	
	C569	NCB31CK-104X	0.1MF 16V C. CAPA. C. M	
	C570	NCB31CK-104X	0.1MF 16V C. CAPA. C. M	
	C571	NCB31CK-103X	0.01MF 16V C. CAPA. C. M	
	C572	NCB31CK-103X	0.01MF 16V C. CAPA. C. M	
	C573	NCB31HK-272X	2700PF 50V C. CAP.	
	C574	NCB31HK-272X	2700PF 50V C. CAP.	
	C575	NCB31HK-562X	5600PF 50V C. CAP.	
	C576	NCB31HK-562X	5600PF 50V C. CAP.	
	C577	NEA21HM-105NZ	1MF 50V AL. E. CAP.	
	C578	NEA21HM-105NZ	1MF 50V AL. E. CAP.	
	C579	NCB31CK-104X	0.1MF 16V C. CAPA. C. M	
	C580	NCB31CK-104X	0.1MF 16V C. CAPA. C. M	
	C581	NEA21HM-105NZ	1MF 50V AL. E. CAP.	
	C582	NEA21HM-105NZ	1MF 50V AL. E. CAP.	
	C583	NCS31HJ-220X	22PF 50V C. CAP.	
	C584	NCS31HJ-220X	22PF 50V C. CAP.	
	C589	NCB31CK-104X	0.1MF 16V C. CAPA. C. M	
	C590	NCB31CK-104X	0.1MF 16V C. CAPA. C. M	

△	Item	Parts Number	Description	Area
	C591	NCB31CK-103X	0.01MF 16V C. CAPA. C. M	
	C592	NCB31CK-103X	0.01MF 16V C. CAPA. C. M	
	C593	NCB31HK-272X	2700PF 50V C. CAP.	
	C594	NCB31HK-272X	2700PF 50V C. CAP.	
	C595	NCB31HK-562X	5600PF 50V C. CAP.	
	C596	NCB31HK-562X	5600PF 50V C. CAP.	
	C597	NEA21HM-105NZ	1MF 50V AL. E. CAP.	
	C598	NEA21HM-105NZ	1MF 50V AL. E. CAP.	
	C599	NCB31CK-104X	0.1MF 16V C. CAPA. C. M	
	C600	NCB31CK-104X	0.1MF 16V C. CAPA. C. M	
	C601	NCB31HK-152X	1500PF 50V C. CAPA. C. M	
	C602	NCB31CK-153X	0.015MF 16V C. CAP.	
	C603	NCB30JK-474X	0.47MF 6.3V CER. CAP.	
	C604	NCS31HJ-270X	27PF 50V C. CAP.	
	C605	NCS31HJ-270X	27PF 50V C. CAP.	
	C608	NCB31HK-103X	0.01MF 50V C. CAP.	
	C609	NCB31HK-103X	0.01MF 50V C. CAP.	
	C610	NCB30JK-474X	0.47MF 6.3V CER. CAP.	
	C611	NCB31HK-221X	220PF 50V C. CAP.	
	C619	NCB31HK-103X	0.01MF 50V C. CAP.	
	C620	NCB30JK-474X	0.47MF 6.3V CER. CAP.	
	C631	NCB31HK-472X	4700PF 50V C. CAPA. C.	
	C632	NCB31HK-103X	0.01MF 50V C. CAP.	
	C633	NCB31HK-103X	0.01MF 50V C. CAP.	
	C634	NCB31HK-103X	0.01MF 50V C. CAP.	
	C635	NCB31HK-103X	0.01MF 50V C. CAP.	
	C637	NCB31HK-103X	0.01MF 50V C. CAP.	
	C638	NCB31HK-103X	0.01MF 50V C. CAP.	
	C639	NCB31HK-103X	0.01MF 50V C. CAP.	
	C640	NCB30JK-474X	0.47MF 6.3V CER. CAP.	
	C641	NCB31HK-472X	4700PF 50V C. CAPA. C.	
	C642	NCB31HK-103X	0.01MF 50V C. CAP.	
	C643	NCB31HK-103X	0.01MF 50V C. CAP.	
	C644	NCB31HK-103X	0.01MF 50V C. CAP.	
	C645	NCB31HK-103X	0.01MF 50V C. CAP.	
	C647	NCB31HK-103X	0.01MF 50V C. CAP.	
	C648	NCB31HK-103X	0.01MF 50V C. CAP.	
	C649	NCB31HK-103X	0.01MF 50V C. CAP.	
	C650	NCB30JK-474X	0.47MF 6.3V CER. CAP.	
	C651	NCB31HK-103X	0.01MF 50V C. CAP.	
	C652	NCB30JK-474X	0.47MF 6.3V CER. CAP.	
	C661	NCB31CK-104X	0.1MF 16V C. CAPA. C. M	
	C662	NCB31CK-104X	0.1MF 16V C. CAPA. C. M	
	C664	NCS31HJ-101X	100PF 50V C. CAPA. C. M	
	C666	NEA21HM-105NZ	1MF 50V AL. E. CAP.	
	C669	NCB31CK-103X	0.01MF 16V C. CAPA. C. M	
	C670	NCB30JK-474X	0.47MF 6.3V CER. CAP.	
	C673	NCB31CK-103X	0.01MF 16V C. CAPA. C. M	
	C678	NCB31HK-103X	0.01MF 50V C. CAP.	
	C679	NCB31HK-103X	0.01MF 50V C. CAP.	
	C680	NCB30JK-474X	0.47MF 6.3V CER. CAP.	
	C681	NCB31HK-103X	0.01MF 50V C. CAP.	
	C682	NCB31HK-103X	0.01MF 50V C. CAP.	
	C683	NCB31HK-103X	0.01MF 50V C. CAP.	
	C684	NEA20JM-107NPM	100MF 6.3V E. CAP.	
	C685	NEA21CM-476NP	47MF 16V AL. E. CAP.	
	C686	NEA21CM-476NP	47MF 16V AL. E. CAP.	
	C687	NCB31HK-103X	0.01MF 50V C. CAP.	
	C688	NEA20JM-107NPM	100MF 6.3V E. CAP.	
	C689	NCB31CK-104X	0.1MF 16V C. CAPA. C. M	
	C690	NCB31CK-104X	0.1MF 16V C. CAPA. C. M	
	C691	NCS31HJ-101X	100PF 50V C. CAPA. C. M	
	C692	NCS31HJ-101X	100PF 50V C. CAPA. C. M	
	C693	NCB31CK-104X	0.1MF 16V C. CAPA. C. M	
	C695	NCB31CK-104X	0.1MF 16V C. CAPA. C. M	
	C696	NCB31CK-104X	0.1MF 16V C. CAPA. C. M	
	C697	NCB31CK-104X	0.1MF 16V C. CAPA. C. M	
	C698	NCB31CK-104X	0.1MF 16V C. CAPA. C. M	
	C699	NCB31CK-104X	0.1MF 16V C. CAPA. C. M	
		RESISTORS		
	R501	NRSA63J-104X	RES. C. M	
	R502	NRSA63J-104X	RES. C. M	

■ Electrical Parts List (AC-3 P.C.B)

△	Item	Parts Number	Description	Area
	R503	NRSA63J-103X	RES. C.M	
	R504	NRSA63J-103X	RES. C.M	
	R505	NRSA63J-103X	RES. C.M	
	R506	NRSA63J-103X	RES. C.M	
	R511	NRSA63J-102X	RES. C.M	
	R512	NRSA63J-102X	RES. C.M	
	R513	NRSA63J-102X	RES. C.M	
	R514	NRSA63J-102X	RES. C.M	
	R515	NRSA63J-102X	RES. C.M	
	R516	NRSA63J-102X	RES. C.M	
	R517	NRSA63J-102X	RES. C.M	
	R518	NRSA63J-102X	RES. C.M	
	R519	NRSA63J-472X	RES. C.M	
	R521	NRSA63J-102X	RES. C.M	
	R522	NRSA63J-102X	RES. C.M	
	R523	NRSA63J-102X	RES. C.M	
	R524	NRSA63J-102X	RES. C.M	
	R525	NRSA63J-102X	RES. C.M	
	R526	NRSA63J-102X	RES. C.M	
	R527	NRSA63J-104X	RES. C.M	
	R528	NRSA63J-104X	RES. C.M	
	R529	NRSA63J-103X	RES. C.M	
	R530	NRSA63J-103X	RES. C.M	
	R551	NRSA63J-104X	RES. C.M	
	R552	NRSA63J-104X	RES. C.M	
	R553	NRSA63J-104X	RES. C.M	
	R554	NRSA63J-104X	RES. C.M	
	R555	NRSA63J-333X	RES. I.M	
	R556	NRSA63J-333X	RES. I.M	
	R561	NRSA63J-104X	RES. C.M	
	R562	NRSA63J-104X	RES. C.M	
	R563	NRSA63J-104X	RES. C.M	
	R564	NRSA63J-104X	RES. C.M	
	R565	NRSA63J-752X	MG RES.	
	R566	NRSA63J-752X	MG RES.	
	R571	NRSA63J-102X	RES. C.M	
	R572	NRSA63J-102X	RES. C.M	
	R573	NRSA63J-102X	RES. C.M	
	R574	NRSA63J-102X	RES. C.M	
	R575	NRSA63J-102X	RES. C.M	
	R576	NRSA63J-102X	RES. C.M	
	R577	NRSA63J-104X	RES. C.M	
	R578	NRSA63J-104X	RES. C.M	
	R581	NRSA63J-104X	RES. C.M	
	R582	NRSA63J-104X	RES. C.M	
	R583	NRSA63J-104X	RES. C.M	
	R584	NRSA63J-104X	RES. C.M	
	R585	NRSA63J-752X	MG RES.	
	R586	NRSA63J-752X	MG RES.	
	R591	NRSA63J-102X	RES. C.M	
	R592	NRSA63J-102X	RES. C.M	
	R593	NRSA63J-102X	RES. C.M	
	R594	NRSA63J-102X	RES. C.M	
	R595	NRSA63J-102X	RES. C.M	
	R596	NRSA63J-102X	RES. C.M	
	R597	NRSA63J-104X	RES. C.M	
	R598	NRSA63J-104X	RES. C.M	
	R601	NRSA63F-433X	METAL GLAZE	
	R602	NRSA63J-221X	MG RES.	
	R603	NRSA63J-473X	RES. C.M	
	R606	NRSA63J-221X	MG RES.	
	R607	NRSA63J-221X	MG RES.	
	R608	NRSA63J-221X	MG RES.	
	R611	NRSA63J-105X	MG RES.	
	R631	NRSA63J-473X	RES. C.M	
	R632	NRSA63J-473X	RES. C.M	
	R633	NRSA63J-473X	RES. C.M	
	R634	NRSA63J-473X	RES. C.M	
	R635	NRSA63J-473X	RES. C.M	
	R636	NRSA63J-221X	MG RES.	
	R637	NRSA63J-221X	MG RES.	
	R638	NRSA63J-221X	MG RES.	

△	Item	Parts Number	Description	Area
	R639	NRSA63J-221X	MG RES.	
	R641	NRSA63J-473X	RES. C.M	
	R642	NRSA63J-473X	RES. C.M	
	R643	NRSA63J-473X	RES. C.M	
	R644	NRSA63J-473X	RES. C.M	
	R645	NRSA63J-473X	RES. C.M	
	R646	NRSA63J-221X	MG RES.	
	R647	NRSA63J-221X	MG RES.	
	R648	NRSA63J-221X	MG RES.	
	R664	NRSA63J-750X	RES. C.M	
	R665	NRSA63J-OROX	RES. C.M	
	R666	NRSA63J-221X	MG RES.	
	R668	NRSA63J-472X	RES. C.M	
	R670	NRSA63J-183X	MG RES.	
	R689	NRSA63J-OROX	RES. C.M	
	R690	NRSA63J-OROX	RES. C.M	
	R691	NRSA63J-474X	RES. C.M	
	R692	QRE141J-473Y	47K 1/4W R. NETWORK	
		OTHERS		
		EWE390-08BB	VINYL WIRE	
		E3400-431	FELT SPACER	
	J664	EMN00TV-107A	PIN JACK	
	K501	NQR0269-007X	BANDPASS FILTER	
	K502	NQR0269-007X	BANDPASS FILTER	
	K521	NQR0269-007X	BANDPASS FILTER	
	K522	NQR0269-007X	BANDPASS FILTER	
	K561	NQR0269-007X	BANDPASS FILTER	
	K562	NQR0269-007X	BANDPASS FILTER	
	K581	NQR0269-007X	BANDPASS FILTER	
	K582	NQR0269-007X	BANDPASS FILTER	
	K601	NQR0269-007X	BANDPASS FILTER	
	K602	NQR0269-007X	BANDPASS FILTER	
	K631	NQR0269-007X	BANDPASS FILTER	
	K632	NQR0269-007X	BANDPASS FILTER	
	K633	NQR0269-007X	BANDPASS FILTER	
	K634	NQR0269-007X	BANDPASS FILTER	
	K641	NQR0269-007X	BANDPASS FILTER	
	K642	NQR0269-007X	BANDPASS FILTER	
	K643	NQR0269-007X	BANDPASS FILTER	
	K644	NQR0269-007X	BANDPASS FILTER	
	K687	NQR0229-001X	F. BEADS C.M	
	L661	EQL5002-470T	INDUCTOR	
	L662	EQL5002-470T	INDUCTOR	
	X601	NAX0213-001X	CRYSTAL	
	X671	NAX0192-001X	CRYSTAL	
	CN681	QGB1214K3-18W	CONNECTOR	
	CN687	QGB1214K3-12W	CONNECTOR	
	KA601	NQR0271-004X	BANDPASS FILTER	
	KA602	NQR0271-004X	BANDPASS FILTER	
	KA631	NQR0271-004X	BANDPASS FILTER	
	KA641	NQR0271-004X	BANDPASS FILTER	
	KA671	NQR0271-004X	BANDPASS FILTER	
	LC601	NQR0150-001X	EMI FILTER C.M	
	LC611	NQR0150-001X	EMI FILTER C.M	
	LC631	NQR0156-017X	EMI FILTER C.M	
	LC641	NQR0156-017X	EMI FILTER C.M	
	LC651	NQR0156-017X	EMI FILTER C.M	
	LC661	NQR0150-001X	EMI FILTER C.M	
	LC671	NQR0150-001X	EMI FILTER C.M	
	UN661	GP1F32R	OPTICAL JACK	
	UN662	GP1F32R	OPTICAL JACK	

■ Electrical Parts List (Resistor P.C.B)

△	Item	Parts Number	Description	Area
		RESISTORS		
△	R881	QRZ0209-4R7	4.7 2W OXIDE METAL	
△	R882	QRZ0209-4R7	4.7 2W OXIDE METAL	
△	R883	QRZ0209-4R7	4.7 2W OXIDE METAL	
△	R884	QRZ0209-4R7	4.7 2W OXIDE METAL	
		OTHERS		
	CN881	QGD2501C1-03Z	SOCKET I.M	

■ Accessories List

Block No. M2MM

△	Item	Parts Number	Parts Name	Q'ty	Description	Version & Area
	1	LVT0017-001A	INSTRUCTION BOOK	1		PBK
		LVT0029-001A	INSTRUCTION BOOK	1		PGD
		LVT0069-001A	INSTRUCTION BOOK	1		VBKU
		LVT0069-002A	INSTRUCTION BOOK	1		VBKUT
	2	LV40383-001A	SIGNAL CORD	1		
	3	EWP201-011	ANTENNA WIRE	1		
	4	QAL0014-001	LOOP ANTENNA	1		
	5	QAM0112-001	AC PLUG ADAPTER	1		U, US
		QAM0055-001	CONVERSION PLUG	1		UF, UT
	6	RM-SR884XUKP	WIRE-LESS REMOTE CONTROL	1		PBK, PGD
		RM-SR884NU	WIRE-LESS REMOTE CONTROL	1		VBK
	7	R03BPA/2STS	BATTERY	1		
	8	QPA02503505P	POLY BAG	1		
	9	BT-59009-1	S. CENTER LIST	1		UF
	10	BT-59011-1	WARANTY CARD	1		UF

Packing Materials and Parts Numbers

Block No. **M** **3** **M** **M**

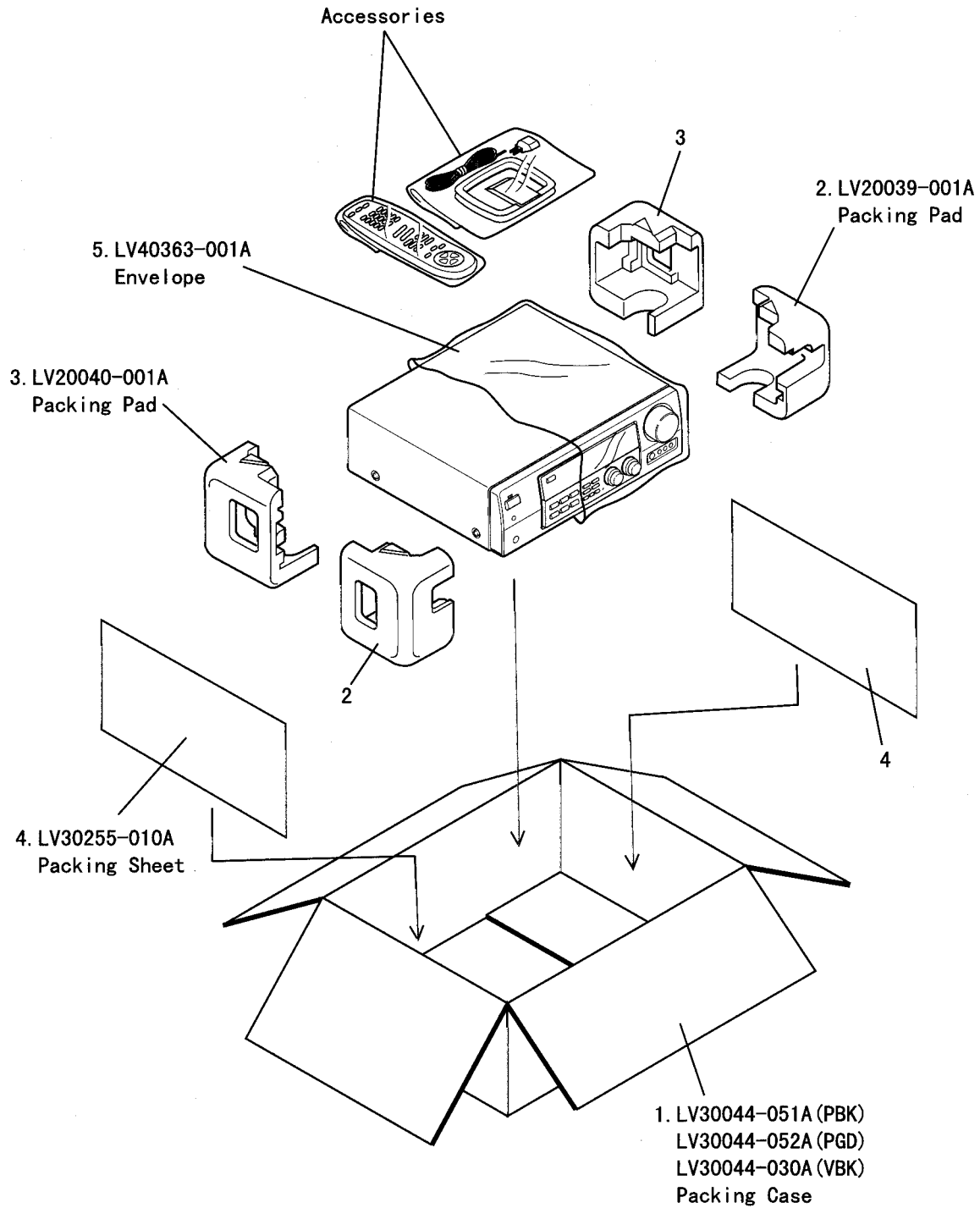

RX-884PBK
RX-884PGD
RX-884VBK

JVC

VICTOR COMPANY OF JAPAN, LIMITED

AUDIO DIVISION, 10-1, 1Chome, Ohwatari-machi, Maebashi-city, 371-8543, Japan