

JVC

SERVICE MANUAL

MICRO COMPONENT SYSTEM

UX-V3 UX-V5 / V5R FS-V5

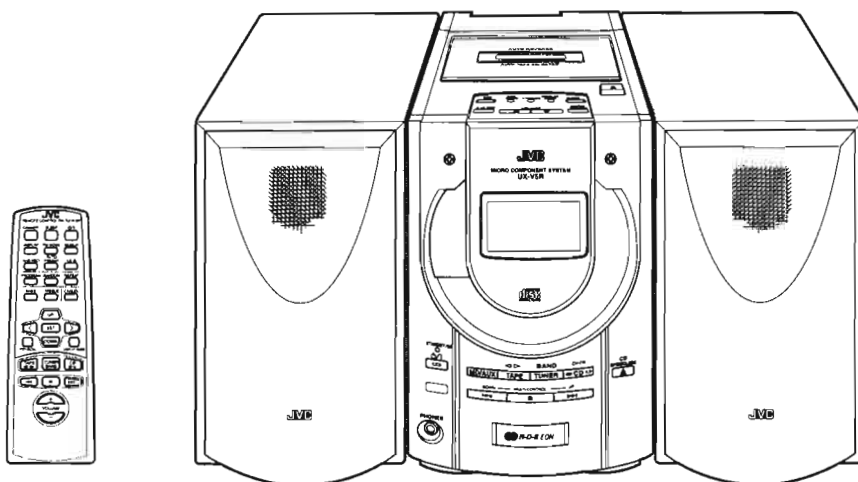

UX-V5R **CORDS EON**

**COMPACT
disc
DIGITAL AUDIO**

Area Suffix (UX-V3)

A Australia
B U.K.
E Continental Europe
EE --- Russian Federation
EN ---- Northern Europe
EV ---- Eastern Europe

UB Hong Kong
US Singapore
UT Taiwan
UX Saudi Arabia
UF China

Area Suffix (UX-V5)

A Australia
UB Hong Kong
US Singapore
UT Taiwan
UX Saudi Arabia

Area Suffix (UX-V5R)

B U.K.
E Continental Europe
EE -- Russian Federation
EN ---- Northern Europe
EV ---- Eastern Europe

Areas Suffix (FS-V5)

J U.S.A.

Contents

Safety Precautions	1-2	Description of major ICs	2-17
Important for Laser Products	1-3	Block Diagrams	2-29
Instructions	1-5~41	Schematic Diagrams	2-31
Disassembly Method	2-1	Printed Circuit Boards	2-39
Main Adjustment	2-11	Parts List	3-1~30
Flow of Functional Operation		Parts List (U version)	4-1~29
Until TOC read	2-15		

Safety precautions

1. This design of this product contains special hardware and many circuits and components specially for safety purposes. For continued protection, no changes should be made to the original design unless authorized in writing by the manufacturer. Replacement parts must be identical to those used in the original circuits. Services should be performed by qualified personnel only.
2. Alterations of the design or circuitry of the product should not be made. Any design alterations of the product should not be made. Any design alterations or additions will void the manufacturer's warranty and will further relieve the manufacture of responsibility for personal injury or property damage resulting therefrom.
3. Many electrical and mechanical parts in the products have special safety-related characteristics. These characteristics are often not evident from visual inspection nor can the protection afforded by them necessarily be obtained by using replacement components rated for higher voltage, wattage, etc. Replacement parts which have these special safety characteristics are identified in the Parts List of Service Manual. Electrical components having such features are identified by shading on the schematics and by (\triangle) on the Parts List in the Service Manual. The use of a substitute replacement which does not have the same safety characteristics as the recommended replacement parts shown in the Parts List of Service Manual may create shock, fire, or other hazards.
4. The leads in the products are routed and dressed with ties, clamps, tubings, barriers and the like to be separated from live parts, high temperature parts, moving parts and/or sharp edges for the prevention of electric shock and fire hazard. When service is required, the original lead routing and dress should be observed, and it should be confirmed that they have been returned to normal, after re-assembling.
5. Leakage current check (Electrical shock hazard testing)
After re-assembling the product, always perform an isolation check on the exposed metal parts of the product (antenna terminals, knobs, metal cabinet, screw heads, headphone jack, control shafts, etc.) to be sure the product is safe to operate without danger of electrical shock. Do not use a line isolation transformer during this check.
 - Plug the AC line cord directly into the AC outlet. Using a "Leakage Current Tester", measure the leakage current from each exposed metal parts of the cabinet, particularly any exposed metal part having a return path to the chassis, to a known good earth ground. Any leakage current must not exceed 0.5mA AC (r.m.s.)
 - Alternate check method
Plug the AC line cord directly into the AC outlet. Use an AC voltmeter having, 1,000 ohms per volt or more sensitivity in the following manner. Connect a 1,500 Ω 10W resistor paralleled by a 0.15 μ F AC-type capacitor between an exposed metal part and a known good earth ground. Measure the AC voltage across the resistor with the AC voltmeter.
Move the resistor connection to each exposed metal part, particularly any exposed metal part having a return path to the chassis, and measure the AC voltage across the resistor. Now reverse the plug in the AC outlet and repeat each measurement voltage measured any must not exceed 0.75 V AC (r.m.s.). This corresponds to 0.5 mA AC (r.m.s.).

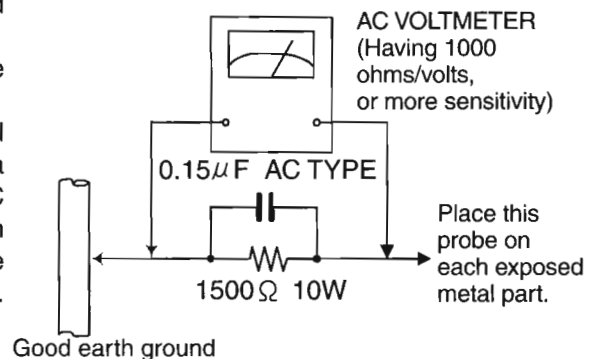

Warning

1. This equipment has been designed and manufactured to meet international safety standards.
2. It is the legal responsibility of the repairer to ensure that these safety standards are maintained.
3. Repairs must be made in accordance with the relevant safety standards.
4. It is essential that safety critical components are replaced by approved parts.
5. If mains voltage selector is provided, check setting for local voltage.

CAUTION Burrs formed during molding may be left over on some parts of the chassis. Therefore, pay attention to such burrs in the case of performing repair of this system.

Important for laser products

1. CLASS 1 LASER PRODUCT

2. DANGER : Invisible laser radiation when open and interlock failed or defeated. Avoid direct exposure to beam.

3. CAUTION : There are no serviceable parts inside the Laser Unit. Do not disassemble the Laser Unit. Replace the complete Laser Unit if it malfunctions.

4. CAUTION : The compact disc player uses invisible laser radiation and is equipped with safety switches which prevent emission of radiation when the drawer is open and the safety interlocks have failed or are defeated. It is dangerous to defeat the safety switches.

5. CAUTION : If safety switches malfunction, the laser is able to function.

6. CAUTION : Use of controls, adjustments or performance of procedures other than those specified herein may result in hazardous radiation exposure.

⚠ CAUTION Please use enough caution not to see the beam directly or touch it in case of an adjustment or operation check.

VARNING : Osynlig laserstrålning är denna del är öppnad och spårren är urkopplad. Betrakta ej strålen.

VARO : Avattaessa ja suojalukitus ohitettaessa olet alttiina näkymättömälle lasersäteilylle. Älä katso säteeseen.

ADVARSEL : Usynlig laserstrålning ved åbning , når sikkerhedsafbrydere er ude af funktion. Undgå udsættelse for stråling.

ADVARSEL : Usynlig laserstrålning ved åbning, når sikkerhedsbryteren er avslott. unngå utsettelse for stråling.

REPRODUCTION AND POSITION OF LABELS

WARNING LABEL

CLASS 1
LASER PRODUCT

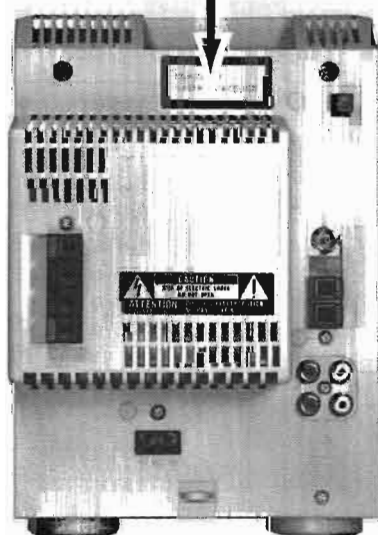

■ Importance Admistering point on the Safety

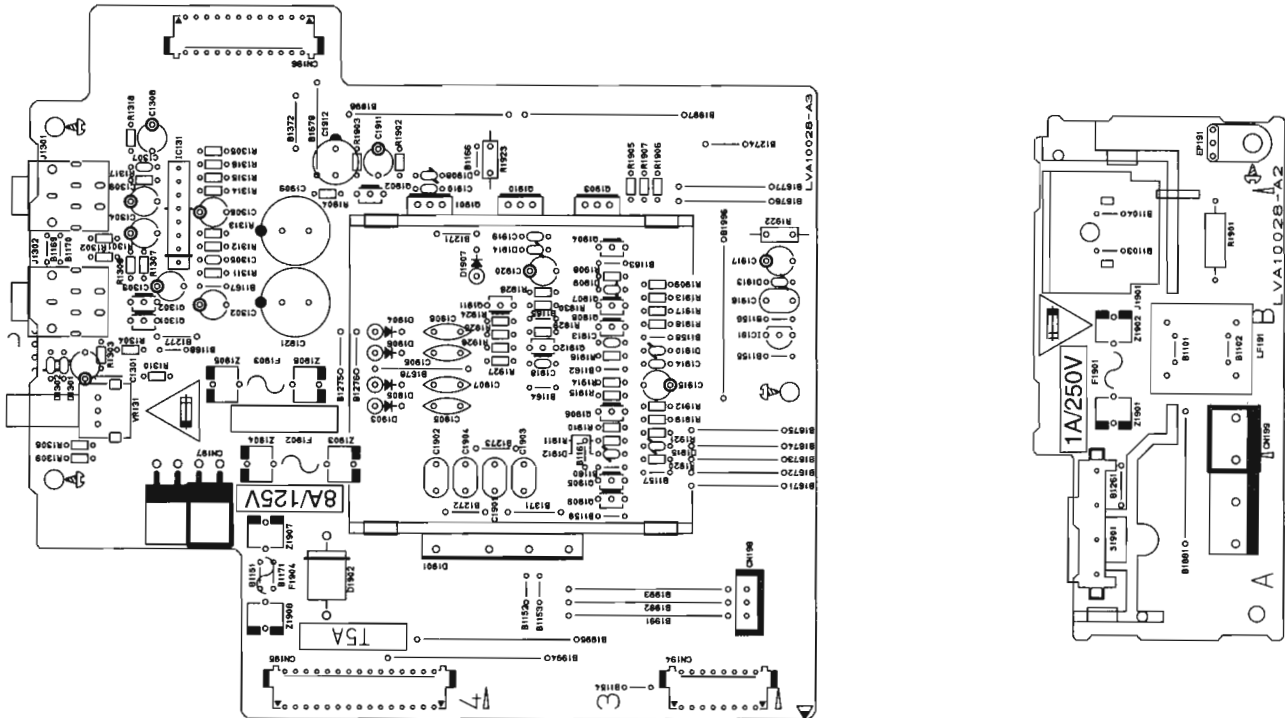

Note : It's means "J" for U.S.A. market model and "C" for canada market model.

UX-V3/UX-V5 C/J ONLY
Full Fuse Replacement Marking
Graphic symbol mark (This symbol means fast blow type fuse.)
should be read as follows ;
FUSE CAUTION
FOR CONTINUED PROTECTION AGAINST RISK OF FIRE, REPLACE ONLY WITH SAME TYPE AND RATING OF FUSES ;
F1901 : 1 A / 250 V F1902 : 8 A / 125 V

UX-V3/UX-V5 C/J SEULEMENT
Marquage Pour Le Remplacement Complet De Fusible
Le symbole graphique (Ce symbole signifie fusible de type à fusion rapide.)
doit être interprété comme suit ;
PRECAUTIONS SUR LES FUSIBLES
POUR UNE PROTECTION CONTINUE CONTRE DES RISQUES D'INCENDIE, REMPLACER SEULEMENT PAR UN FUSIBLE DU MEME TYPE ;
F1901 : 1 A / 250 V F1902 : 8 A / 125 V

JVC

**MICRO COMPONENT SYSTEM
MIKRO-KOMPONENTEN-SYSTEM
SYSTEME DE MICROCOMPONENTS
MIKRO KOMPONENTEN-SYSTEEM
SISTEMAS DE MICROCOMPONENTES
SISTEMA A MICROCOMPONENTI**

UX-V3

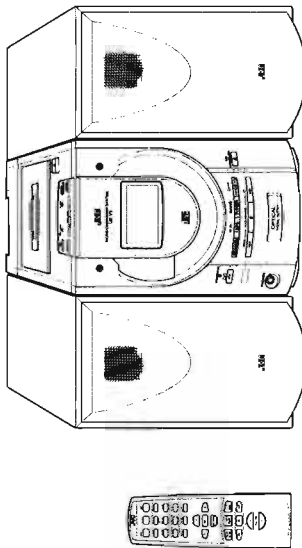

compact disc
DIGITAL AUDIO

**INSTRUCTIONS
BEDIENUNGSANLEITUNG
MANUEL D'INSTRUCTIONS
GEBRUIKSAANWIJZING
MANUAL DE INSTRUCCIONES
ISTRUZIONI**

For Customer Use:
Enter below the Model No. and Serial No.
which are located either on the rear panel
of the main unit or on the bottom of the
main unit. Retain this information for future reference.

Model No.
Serial No.

LVT0215-001A [E]

Instructions

UX-V3/UX-V5
UX-V5R/FS-V5

Warnings, Cautions and Others / Warnung, Achtung und sonstige Hinweise / Mises en garde, précautions et indications diverses / Waarschuwingen, voorzorgen en andere mededelingen/Avisos, precauciones y otras notas / Avvertenze e precauzioni da osservare

Per l'Italia:
Si dichiara che il questo prodotto di marca JVC è conforme alle norme CE e alla direttiva CEE n. 546 del 28/09/85, emessa dal Parlamento Europeo e approvata dal Consiglio della Repubblica Italiana n. 301 del 28/12/95.

Caution — ϕ 1 switch!
Disconnect the mains plug to shut the power off completely. The ϕ 1 switch in any position does not disconnect the mains line. The power can be remote controlled.

Achtung — ϕ 1 Schalter!
Den Netzstecker aus der Steckdose ziehen, um die Stromversorgung vollständig zu unterbrechen. Der Schalter ϕ 1 unterbricht in keiner Stellung die Stromversorgung vollkommen. Die Stromversorgung kann mit der Fernbedienung ein- und ausgeschaltet werden.

Attention — Commutateur ϕ 1!
Déconnecter la fiche de secteur pour couper complètement le courant. Le commutateur ϕ 1 ne coupe jamais complètement la ligne de secteur, quelle que soit sa position. Le courant peut être télécommandé.

Voorzichtig — ϕ 1 schakelaar!
Omschakel het netstekker uit te schakelen, trek u de stekker uit het stopcontact. Anders zal er altijd een geringe hoeveelheid stroom naar het apparaat lopen, ongeacht de stand van de ϕ 1 schakelaar. U kunt het apparaat ook met de afstandsbediening aan- en uitschakelen.

Precaución — Interruptor ϕ 1!
Desconectar el cable de alimentación para desactivar la alimentación totalmente. Cualquier que sea la posición de ajuste del interruptor ϕ 1, la alimentación no es cortada completamente. La alimentación puede ser controlada remotamente.

Attenzione — L'interruttore ϕ 1!
Disinnescare la spina del cavo di alimentazione dalla presa della rete elettricamente. In qualsiasi posizione di regolazione dell'interruttore ϕ 1, in nessuna posizione salta la linea di alimentazione elettrica principale. È possibile il controllo remoto dell'alimentazione.

CAUTION
To reduce the risk of electrical shocks, fire, etc.:
1. Do not remove screws, covers or cabinet.
2. Do not expose this appliance to rain or moisture.

ACHTUNG
Zur Vermeidung von elektrischen Schlägen, Brandgefahr, usw.:
1. Keine Schrauben, Klappen oder Abdeckungen entfernen und das Gehäuse nicht öffnen.
2. Dieses Gerät weder Regen noch Feuchtigkeit aussetzen.

ATTENTION
Afin d'éviter tout risque d'électrocution, d'incendie, etc.:
1. Ne pas enlever les vis ni les panneaux et ne pas ouvrir le coffret de l'appareil.
2. Ne pas exposer l'appareil à la pluie ni à l'humidité.

VOORZICHTIG
Ter vermindering van gevaar voor brand, elektrische schokken, enz.:
1. Verwijder geen schroeven, panelen of de behuizing.
2. Stel het toestel niet bloot aan regen of vocht.

PRECAUCIÓN
Para reducir riesgos de choques eléctricos, incendio, etc.:
1. No arranque los tornillos, las cubiertas ni la caja.
2. No exponga este aparato a la lluvia o a la humedad.

ATTENZIONE
Per ridurre il rischio di shock elettrici, incendi, ecc.:
1. Non togliete viti, coperchi o la scatola.
2. Non esponete l'apparecchio alla pioggia e all'umidità.

Caution: Proper Ventilation
To prevent fire, shock, and fire, and to prevent damage, locate the apparatus as follows:

1. Front:
No obstructions and open spacing.
2. Sides/ Top/ Back:
No obstructions should be placed in the areas shown by the dimensions below.
3. Bottom:
The Stencil should be placed on the level surface. Maintain an adequate air path for ventilation by placing on a stand with a height of 10 cm or more.

Vorsicht: Ausreichende Belüftung

- Zur Vermeidung von elektrischen Schlägen, Feuer und sonstigen Schäden, muss das Gerät unter folgenden Bedingungen aufgestellt werden:
1. Vorderseite:
Hindernisse sind gut zugänglich.
 2. Seiten- und Rückwände:
Hindernisse in allen gegebenen Abständen (s. Abbildung).
 3. Unterseite:
Die Stellfläche muß absolut eben sein. Sorgen Sie für ausreichende Belüftung durch Aufstellung auf einem Stand mit mindestens 10 cm Höhe.

Attention: Aération correcte

- Pour prévenir tout risque de décharge électrique ou d'incendie et éviter toute détérioration, installez l'appareil de la manière suivante:
1. Avant:
Bien dégagé de tout objet.
 2. Côtés/dessus/dessous:
Assurez-vous que rien ne bloque les espaces indiqués sur le schéma ci-dessous.
 3. Dessous:
Posez l'appareil sur une surface plane et horizontale. Veillez à ce qu'il y ait une libre circulation d'air en le plaçant sur un support d'au moins dix centimètres de hauteur.

Voorzichtig: Goede ventilatie vereist

- Om brand, elektrische schokken en beschadiging te voorkomen, moet het apparaat als volgt opgesteld zijn:
1. Voorkant:
Geen belemmeringen in voldoende ruimte.
 2. Zijkant/boven-/onderkant:
Geen belemmeringen plaatsen in de hieronder aangegeven zones.
 3. Onderkant:
Op een vlakke ondergrond plaatsen. Voldoende ventilatieruimte voorzorgen door het toestel op een onderstel met een hoogte van 10 cm of meer te plaatsen.

Precaución: ventilación correcta

- Para evitar el riesgo de descargas eléctricas e incendio y prevenir posibles daños, instale el equipo en un lugar que cumpla los siguientes requisitos:
1. Parte frontal:
Sin obstrucciones, espacio abierto.
 2. Lados/parte superior/parte posterior:
No debe haber ninguna obstrucción en las áreas mostradas por las dimensiones de la siguiente figura.
 3. Parte inferior:
Situe el equipo sobre una superficie nivelada. Mantenga un espacio adecuado para la circulación de aire colocando el equipo sobre un soporte de 10 o más cm de altura.

Attenzione: Per una corretta ventilazione

- Per prevenire il rischio di scosse elettriche e di incendio ed evitare possibili danni, collocare le apparecchiature nel modo seguente:
1. Parte anteriore:
Nessun ostacolo e spazio libero.
 2. Lateri/Parte superiore/Posteriore:
Lasciare libere le zone indicate dalle dimensioni di seguito.
 3. Base:
Collocare su una superficie piana. Consentire un'adeguata ventilazione dell'impianto appoggiandolo su un tavolino alto almeno 10 cm.

**Front view
Vorderansicht
Vorneansicht
Vista frontal
Vista frontale**

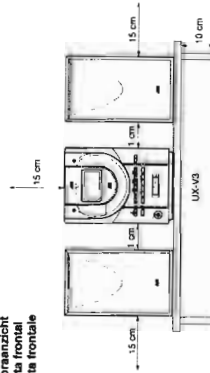

**Side view
Seitenansicht
Côté
Zijaanzicht
Vista lateral
Vista laterale**

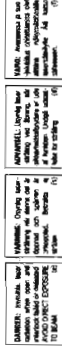
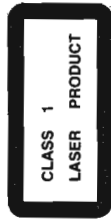

IMPORTANT FOR LASER PRODUCTS / WICHTIGER HINWEIS FÜR LASER-PRODUKTE / IMPORTANT POUR LES PRODUITS LASER / BELANGRIJKE INFORMATIE VOOR LASERPRODUCTEN / IMPORTANTE PARA LOS PRODUCTOS LASER / IMPORTANTE PER I PRODOTTI LASER

REPRODUCTION OF LABELS/ANBRINGINGSORTE FÜR LASER-PRODUKTE/REPRODUCTION DES ÉTIQUETTES/VERKLARING VAN DE LABELS/REPRODUZIONE DE ETIQUETAS/RIPRODUZIONE DELLE ETICHETTE

- ① CLASSIFICATION LABEL, PLACED ON EXTERIOR SURFACE
- ② CLASSIFICAZIONE ETICHETTA SULLA SUPERFICIE ESTERIORE
- ③ ETIQUETTE DE CLASSIFICATION, PLACÉE SUR LA SURFACE EXTÉRIEURE
- ④ WAARSCHUWINGSLABEL, IN HET APPARAAT
- ⑤ ETIQUETA DE ADVERTENCIA, PEGADA EN EL INTERIOR DE LA UNIDAD
- ⑥ ETICHETTA DI AVVERTENZA, SITUATA ALL'INTERNO DELL'APPARECCHIO

1. CLASS 1 LASER PRODUCT

DANGER: Invisible laser radiation when open and interlock failed or defeated. Avoid direct exposure to beam.

CAUTION: Do not open the top cover. There are no user serviceable parts inside the Unit. Leave all servicing to qualified service personnel.

1. **GEFAHR:** Unsichtbare Laserstrahlung bei Öffnung und fehlerhafter oder beschädigter Sperr. Direkten Kontakt mit dem Strahl vermeiden!
2. **ACHTUNG:** Das Gehäuse nicht öffnen. Das Gerät enthält keine für den Benutzer gewartet werden können. Überlassen Sie Wartungsarbeiten bitte qualifizierten Kundendienst-Fachleuten.

1. KLAS 1 LASERPRODUKT

GEVAARLIJK: Onzichtbare laserstraling wanneer open en de beveiliging faalt of uitgeschakeld is. Voorkom het direct blootstaan aan de straal.

VOORZICHTIG: De boventop niet openen. Binnenin het toestel bevinden zich geen door de gebruiker te repareren onderdelen. Laat onderhoud over aan bekwaam vakpersoneel.

1. **PERICOLO:** Radiazione laser invisibile quando l'apparecchio è aperto ed il dispositivo di sicurezza è guasto o disattivato. Evitare l'esposizione diretta ai raggi.
2. **ATTENZIONE:** Non aprire il coperchio superiore. Non vi sono parti riparabili dall'utente all'interno di questo apparecchio. Lasciare tutti i controlli a personale qualificato.

Getting Started

Accessories

Make sure that you have all of the following items, which are supplied with the System.

- Power Cord (1)
- AM Loop Antenna (1)
- Remote Control (1)
- Batteries (2)
- FM Wire Antenna (1)

If any of these items are missing, contact your dealer immediately.

How To Put Batteries In the Remote Control

Match the polarity (+ and -) on the batteries with the + and - markings in the battery compartment.

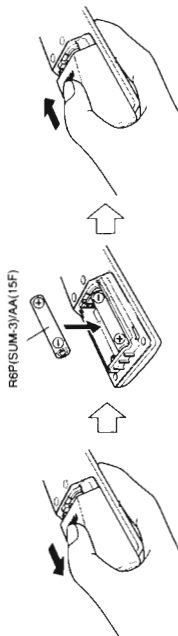

CAUTION: Handle batteries properly.

- To avoid battery leakage or explosion:
 - Remove batteries when the Remote Control will not be used for a long time.
 - When you need to replace the batteries, replace both batteries at the same time with new ones.
 - Don't use an old battery with a new one.
 - Don't use different types of batteries together.

Using the Remote Control

The Remote Control makes it easy to use many of the functions of the System from a distance of up to 7m (23 feet) away. You need to point the Remote Control at the remote sensor on the System's front panel.

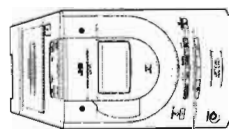

Remote sensor

English
English

Features

Here are some of the things that make your System both powerful and simple to use.

- The controls and operations have been redesigned to make them very easy to use. Freeing you to just enjoy the music.
 - With JVC's **COMPU PLAY** you can turn on the System and automatically start the Radio, Cassette deck or CD Player with a single touch.
- The System incorporates Active Hyper Bass PRO circuitry to faithfully reproduce low frequency sounds.
- A 45-station preset capability (30 FM and 15 AM (MW/LW)) in addition to auto-tune and manual tuning.
- Versatile CD options include repeat, random and program play.
- Timer functions: Daily Timer and Sleep Timer.
- Auto-reverse tape function.
- You can connect various external units, such as an MD recorder.

How This Manual Is Organized

- Basic information that is the same for many different functions - e.g. setting the volume - is given in the section 'Common Operations', and not repeated under each function.
 - The names of buttons/controls and display messages are written in all capital letters: e.g. TUNER BAND, "NO DISC".
 - System functions are written with an initial capital letter only: e.g. Normal Play.
- Use the table of contents to look up specific information you require. We've enjoyed making this manual for you, and hope it serves you in enjoying the many features built into your System.

IMPORTANT CAUTIONS

Installation of the System

- Select a place which is level, dry and neither too hot nor too cold. (Between 5°C and 35°C or 41°F and 95°F.)
- Leave sufficient distance between the System and a TV.
- Do not use the System in a place subject to vibrations.

Power cord

- Do not handle the power cord with wet hands.
- Some power is always consumed as long as the power cord is connected to the wall outlet.
- When unplugging the System from the wall outlet, always pull the plug, not the power cord.

Malfunctions, etc.

- There are no user-serviceable parts inside. In case of system failure, unplug the power cord and consult your dealer.
- Do not insert any metallic object into the System.

Table of Contents

Features	1
How This Manual Is Organized	1
IMPORTANT CAUTIONS	1
Getting Started	2
Common Operations	6
Using the Tuner	8
Using the CD Player	10
Using the Cassette Deck (Listening to a Tape)	12
Using the Cassette Deck (Recording)	13
Using External Equipments	15
Using the Timers	16
Care And Maintenance	18
Troubleshooting	19
Specifications	20

CAUTION: Make all connections before plugging the System into an AC power outlet.

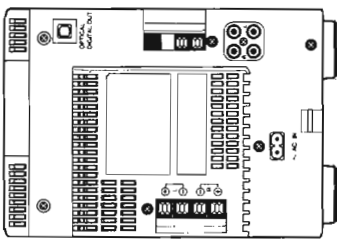

Using the Supplied Wire Antenna



Using the Coaxial Type Connector (Not Supplied)

A 75-ohm antenna with coaxial type connector (IEC or DIN45 325) should be connected to the FM 75-ohm COAXIAL terminal.



If reception is poor, connect the outside antenna.



Note: Before attaching a 75 ohm coaxial lead (the kind with a round wire going to an outside antenna), disconnect the supplied FM Wire Antenna.

Connecting the AM Loop Antenna

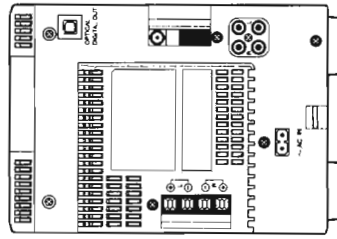

AM loop antenna (Supplied)

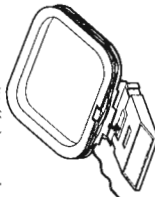

Attach the AM loop to its base by snapping the tabs on the loop into the slot in the base.

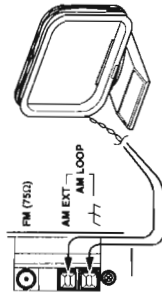

Turn the loop until you have the best reception.

CAUTION: To avoid noise, keep antennas away from the System, the connecting cord and the AC power cord.

English

CAUTION: Make all connections before plugging the System into an AC power outlet.

For each speaker, connect one end of the speaker wire to the speaker terminals on the back of the System.

1. Open each of the terminals and insert the speaker wires firmly, then close the terminals.
2. Connect the red (+) and black (-) wires of the right side speaker to the red (+) and black (-) terminals marked R on the System. Connect the red (+) and black (-) wires of the left side speaker to the red (+) and black (-) terminals marked L on the System.

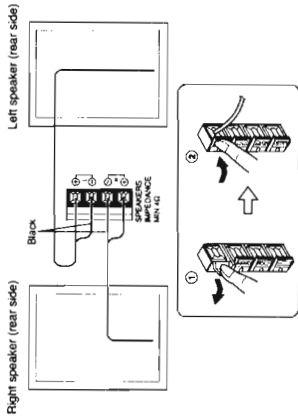

CAUTION: A TV may display irregular colors if located near the speakers. If this happens, set the speakers away from the TV.

Connecting External Equipment

Connect signal cords (not supplied) between the System's LINE IN (AUX)LINE OUT terminals and the output/input terminals of the external MD recorder, tape deck, etc.

You can then listen to the external source through the System, or record the System's CD player, cassette tape, or tuner to the external unit.

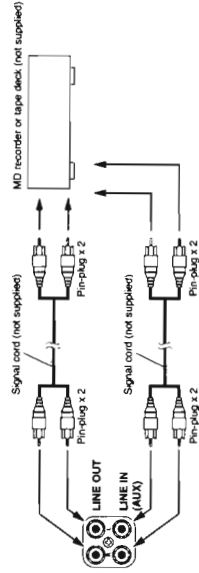

Connecting an MD Recorder, etc. (Digital Output)

Unplug the cap and connect an optical digital cord (not supplied) between the System's OPTICAL DIGITAL OUT terminal and the input terminal of the MD recorder, etc.

You can record the digital output signal from the System's CD Player to the MD recorder, etc.

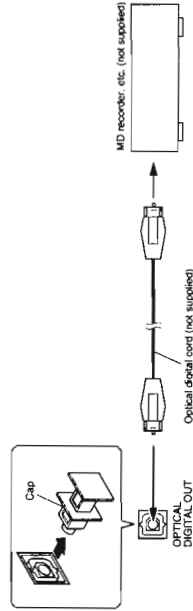

English

English

Connecting the AC Power Cord

Firmly insert the supplied AC power cord into the AC inlet on the back of the Unit.

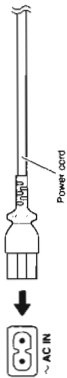

CAUTIONS:

- **ONLY USE THE JVC POWER CORD PROVIDED WITH THIS SYSTEM TO AVOID MALFUNCTION OR DAMAGE TO THE SYSTEM.**
 - **BE SURE TO UNPLUG THE POWER CORD FROM THE OUTLET WHEN GOING OUT OR WHEN THE SYSTEM IS NOT IN USE FOR AN EXTENDED PERIOD OF TIME.**
- Now you can plug the AC power cord into the wall outlet, and your System is at your command!**

COMPU PLAY

JVC's COMPU PLAY feature lets you control the most frequently used System functions with a single touch. With One Touch Operation you can play a CD, a tape, turn on the radio, or listen to an external equipment with a single press of the play button for that function. One Touch Operation turns the power on for you, then starts the function you have specified. If the System is not ready (no CD in place), the System still powers on so you can insert a CD. How One Touch Operation works in each case is explained in the section dealing with that function. The COMPU PLAY buttons are:

On the Unit

CD >|< button
TUNER BAND button
TAPE <|> button
MD/AUX button

On the Remote Control

CD >|< button
TUNER BAND button
TAPE <|> button
MD/AUX button

AUTOMATIC POWER ON

The System automatically turns on with the following operation.

- When you press the CD button, the System automatically turns on and the CD cover opens to allow CD insertion. However, this operation does not change the function to CD.
- When you press the CD button to turn off the System, the CD cover will automatically close if it is opened.

Common Operations

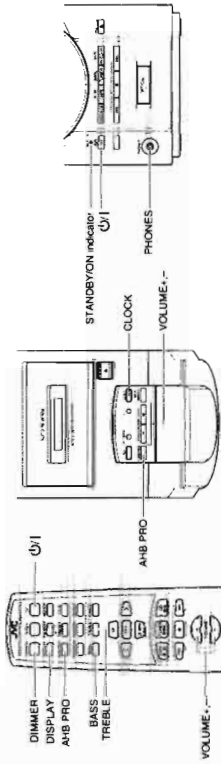

Turning the Power On and Off

Turning the System On

The display comes on and "HELLO" is displayed once. The STANDBY/ON indicator lights in green. The System comes on ready to continue in the mode it was in when the power was last turned off.

- For example, if the last thing you were doing was listening to a CD, you are now ready to listen to a CD again. If you wish, you can change to another source.
- If you were listening to the Tuner last, the Tuner comes on playing the station it was last set to.

Turning the System Off

Press the OFF button again.

- "GOOD BYE" is displayed and the display goes out, except for the clock display. The STANDBY/ON indicator lights in red.
- Some power is always consumed even though power is turned off (called Standby Mode).
- To switch off the System completely, unplug the AC power cord from the wall outlet. When you unplug the AC power cord, the clock will be reset to 0:00 after about 20 minutes.

Adjusting the Volume

Press the VOLUME + button to increase the volume or press the VOLUME - button to decrease it.



You can adjust the volume level between 0 and 50.

CAUTION: DO NOT turn on the System and/or start playing any source without first setting the VOLUME control to minimum, as a sudden blast of sound could damage your hearing, speakers and/or headphones.

For private listening

Connect a pair of headphones to the PHONES jack. No sound comes out of the speakers. Be sure to turn down the volume before connecting or putting on headphones.

Adjusting the Brightness (DIMMER)

You can adjust the brightness of the backlighting for the display.

When the System is Turned On

To make the brightness of the backlighting darker, press the DIMMER button on the Remote Control.

To make the brightness brighter, press the DIMMER button on the Remote Control again.

When the System is Turned Off (STANDBY MODE)

To turn on the backlighting, press the DIMMER button on the Remote Control. The brightness is the same as for darker one mentioned above.

To turn off the backlighting, press the DIMMER button on the Remote Control again.

English
English

Showing the Time (DISPLAY)

In Standby mode, the digital clock and analog clock appear on the display at the same time. Meanwhile, only the analog clock is displayed when a music source is selected. Namely, you can see the analog clock at all times.

When the System is turned on, you can display the digital clock at any time.

To display the digital clock, press the CLOCK button on the Unit or DISPLAY button on the Remote Control.

To return to the previous mode, press the same button again.

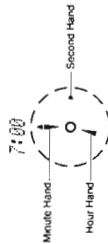

Note: To let work the clock, you need to set the clock beforehand. (See "Setting the Clock" on page 16.)

Reinforcing the Bass Sound (AHB PRO)

You can reinforce the bass sound to maintain rich, full bass at low volume (you can use this effect only for playback).

To get the effect, press the AHB (Active Hyper Bass) PRO button.

The "BASS" indicator lights up on the display.

To cancel the effect, press the button again.

The "BASS" indicator goes out.

Tone Control (BASS/TREBLE)

You can control the tone by changing the bass and treble.

The analog clock acts to display the bass and treble settings.

By pressing either the BASS or TREBLE button on the Remote Control, you can visually see the current tone control settings.



BASS Control
You can adjust the bass level (low frequency range level) between -6 and +6. (0: Flat)

TREBLE Control
You can adjust the treble level (high frequency range level) between -6 and +6. (0: Flat)



BASS Control
You can adjust the bass level (low frequency range level) between -6 and +6. (0: Flat)

TREBLE Control
You can adjust the treble level (high frequency range level) between -6 and +6. (0: Flat)

BASS Control
Press the UP or DOWN button on the Remote Control to adjust the bass level.



Using the Tuner

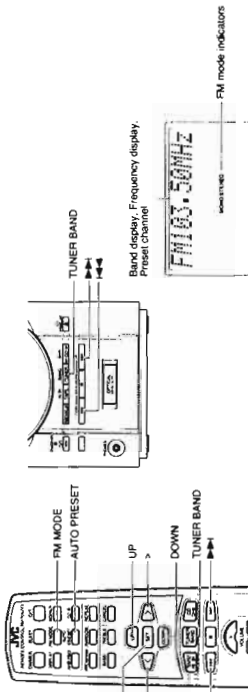

When the System is in use, the display shows other items as well. For simplicity, we show here only the items described in this section.

Preset Tuning using the Remote Control (Possible only after presetting stations)
Select the desired preset number using the Up, Down, > and < button on the Remote Control. After 1 second the display will show the preset number's band and frequency.
Example: Press the UP button until the preset number 12 "P12" appears.

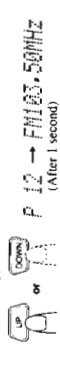

One Touch Radio

Just press the TUNER BAND button to turn on the System and start playing the station you were last tuned to.

You can switch from any other sound source to the radio by pressing the TUNER BAND button.

Tuning in a Station

Press the TUNER BAND button.

The Band and Frequency you were last tuned to appear on the display. (If the last station was selected using the preset number, the preset number appears first.)

Each time you press the button, the band alternates between FM and AM (MW/LW).

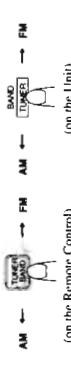

Select a station using one of the following methods.

Manual Tuning
Press the < or > button on the Unit or the Remote Control repeatedly to move from frequency to frequency until you find the station you want.

Auto Tuning
If you press and hold the < or > button on the Unit or the Remote Control for one second or more, the frequency changes down, or up, automatically until a station is found.

Presetting Stations

You can preset up to 30 FM stations and up to 15 AM (MW/LW) stations using the Remote Control.

Note: Preset numbers may have been set to factory test frequencies prior to shipment. This is not a malfunction. You can preset the stations you want into memory by following one of the presetting methods below.

Manual Presetting



Select a band by pressing the TUNER BAND button.

Press the < or > button to tune in a station.

Press the SET button.
"SET" will blink for 5 seconds. Within 5 seconds, proceed to the next step. When the display returns to the one set in STEP2 after 5 seconds, press the SET button again.

- Press the UP, DOWN, >, or < button within 5 seconds to select the preset number.**
- UP or > button: Increases the preset number by 1.
 - DOWN or < button: Decreases the preset number by 1.
 - When the > or < button is kept pressed, the preset number changes rapidly.

- Press the SET button within 5 seconds.**
- "STORED" appears and after 2 seconds, the display returns to the broadcast frequency display.

- Repeat above steps 1 to 5 for each station you want to store in memory with a preset number.**
- To change the preset stations, repeat the same steps as above.

Auto Presetting

In each band, you can automatically preset FM:30, AM (MWLW), IS stations. Preset numbers will be allocated as stations are found, starting from the lowest frequency and moving up the frequency.



- Select a band by pressing the TUNER BAND button.**

- Press the AUTO PRESET button on the Remote Control for more than two seconds.**

- Repeat steps 1-2 for the other band.**

- If you want to change the preset stations, carry out the Manual Presetting for the desired preset numbers.**

CAUTION: Even if the system is unplugged or if the power failure occurs, the preset stations will be stored for about 24 hours. However, in case the preset stations are erased, you will need to preset the stations again.

To Change the FM Reception Mode

When you are tuned into an FM stereo broadcast, the "STEREO" indicator lights up and you can hear stereo effects. If an FM stereo broadcast is hard to receive or noisy, you can select Monaural mode. Reception improves, but you lose any stereo effect.

Press the FM MODE button on the Remote Control so that the "MONO" indicator lights up on the display.



To restore the stereo effect, press the FM MODE button on the Remote Control so that the "MONO" indicator goes off.

Using the CD Player

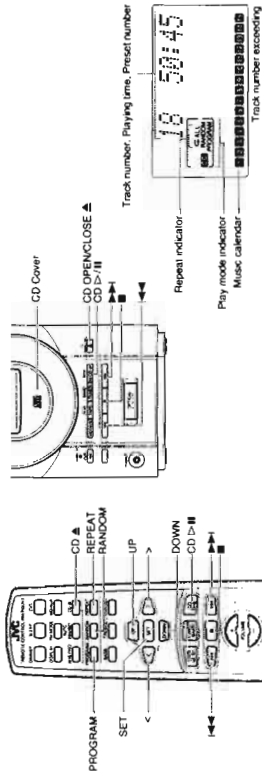

When the System is in use, the display shows other items as well. For simplicity, we show here only the items described in this section.

- When you place or take out a CD, do not let it fall. Also, be careful not to scratch your fingers with a CD cover.

To Unload a CD

Take out the CD as shown below.



- To unload an 8 cm (3") CD, use the concavity to make removal easier.

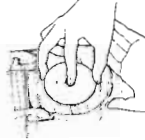

Basics of Using the CD Player-Normal Play

To Play a CD

- Insert a CD.
 - Press the CD EJECT button.
- The first track of the CD begins playing.

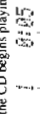

- The track number that has already played disappears from the music calendar.
- The CD Player automatically stops when the last track of the CD has finished playing.

You can use Normal, Random, Program or Repeat Play. Repeat Play can repeat all the tracks or just one of the tracks on the CD. Here are the basic things you need to know to play a CD and locate the different tracks on it.

The Quickest Way To Start a CD Is With the One Touch Operation

- Press the CD EJECT button on the Unit or the Remote Control. The power is automatically turned on. If a CD is already inserted, it will start playing from the first track.
- If no CD is inserted, "NO DISC" appears on the display and the CD Player remains in Stop mode.

To Insert a CD

- Press the CD OPEN/CLOSE button on the Unit (or the CD EJECT button on the Remote Control).

The CD cover opens.

- Place a CD, with its label side out as shown below. Press down on the CD's center until you hear a click.

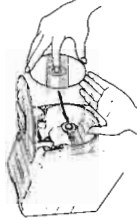

- Press the CD OPEN/CLOSE button (or CD EJECT button) again to close the CD cover.

To close the CD cover and play the CD, you can just press the CD EJECT button.

- You can place an 8 cm (3") CD without an adaptor.
- If the CD cannot be read correctly (because it is scratched, for example), "0:00" appears on the display.
- You can insert a CD while listening to the other source.

CAUTIONS:

- DO NOT try to open or close the CD cover by hands as it will be damaged.

Using the Cassette Deck (Listening to a Tape)

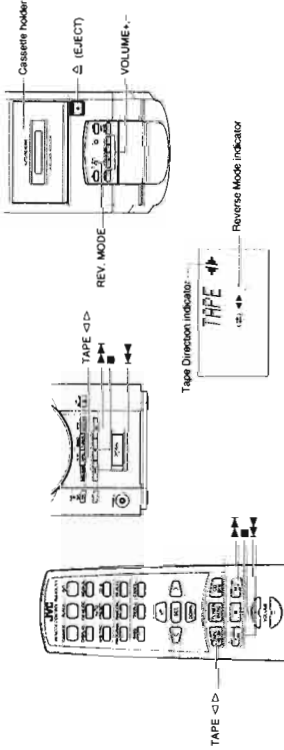

When the System is in use, the display shows other items as well. For simplicity, we show here only the items described in this section.

If you need to change the playback direction, press the TAPE <D> button again.
The opposite side Tape Direction indicator lights up and the tape playback direction changes.

To stop playing, press the (EJECT) button.
To remove the tape, stop the tape, and press the (EJECT) button.

To Fast-Wind A Tape
Press the >>> or <<<< button on the Unit or the Remote Control to fast-wind the tape >>> or <<<< indicator of the tape fast-wind direction appears on the display.
The Cassette Deck automatically stops when the tape reaches its end.

Reverse Mode
You can set a tape to play just one side, both sides in succession, or both sides continuously.

Press the REV. MODE button on the Unit.
The indicator changes with each press of the button as shown.

- ⏪ : The Cassette Deck automatically stops after playing one side of the tape.
- ⏩ : The Cassette Deck automatically stops after playing both sides of the tape. (Stops when playback in the <D> direction is finished.)
- ⏪ : The Cassette Deck continues to play both sides of the tape until the (EJECT) button is pressed.

You can see the total playback time of programmed tracks on the display. Also, you can see the programmed tracks on the music calendar.

Press the CD >II button.
The System plays the tracks in the order you have programmed them.

or >>> button during Program Play.

To stop playing, press the (EJECT) button once.
To confirm the programmed tracks while the CD player is stopped, each time press the <<<< or >>>> button; the tracks making up the program will successively be displayed in the programmed order.

To delete all the tracks in the program, in stop mode, press the (EJECT) button. Pressing the CD >II button to open the CD cover will also clear the programmed tracks.

To exit the program mode once, while the CD Player is stopped, press the PROGRAM button to light off the "CD PROGRAM" indicator.

Notes:
• If the total playback time of the programmed tracks exceeds 99 minutes 59 seconds, the total playback time will go on to the display.

• If you try to program the 21st track, "MEMORY FULL" appears on the display for about 2 seconds.

To Modify the Program
Modify the contents of the program while the CD Player is stopped. Each time you press the CANCEL button, the last track in the program is deleted. To add new tracks to the end of the program, repeat above steps 5 to 7.

Random Play
The tracks will play in no special order when you use this mode.

Press the RANDOM button on the Remote Control.
The "CD RANDOM" indicator lights up on the display.

Press the CD >II button.
The tracks are played in random order.

To skip a track during playback, press the >>> button to jump to the next track in the random sequence. Press the <<<< button to jump back to the start of a track being played.

To exit Random Play mode, while the CD Player is stopped, press the RANDOM button to light off the "CD RANDOM" indicator and carry out Normal Play, or press the CD >II button to open the CD cover.

Repeating Tracks
You can set the program or individual track playing to repeat as many times as you like.

Press the REPEAT button on the Remote Control.
The Repeat indicator changes with each press of the button, as shown below.

⏪ : Repeat one track.
⏩ : Repeat all tracks.

⏪ : In Normal Play mode, repeats all the tracks in the Program.
⏩ : In Program Play mode, repeats all the tracks in the random order.

To exit Repeat mode, press the REPEAT button until the Repeat indicator on the display goes out.

• In Random Play, as a matter of course, ⏪ cannot be selected.
• Repeat mode remains in effect even when you change the play mode.

To stop playing the CD, press the (EJECT) button.
The following information for the CD is displayed.

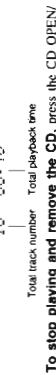

To stop playing and remove the CD, press the CD OPEN/CLOSE button on the Unit or CD >II button on the Remote Control to open the CD cover.

To pause, press the CD >II button. The playback time blinks on the display.

To cancel pause, press the same button again. Play continues from the point where it was paused.

To Select a Track or Passage within a Track
During playback, press the <<<< or >>>> (< or >) button to select the track you want.

The selected track starts playing.

• Press the >>>> or <<<< button once to skip to the beginning of the next track.

• Press the <<<< or >>>> button to skip to the beginning of the track being played. Press twice quickly to skip to the beginning of the previous track.

• When the > or < button on the Remote Control is kept pressed, the track continuously skips.

Search Play
Holding down the <<<< or >>>> button during playback will fast forward/backward the CD so you can quickly find a particular passage in the track you are listening to.

Programming the Playing Order of the Tracks
You can program the playing order of the tracks using the Remote Control.

• You can program up to 20 tracks in any desired order including the same tracks.

• You can only make a program when the CD Player is stopped.

• **Insert a CD.**

• **Press the CD >II button.**

• **Press the (EJECT) button to stop the CD.**

• **Press the PROGRAM button.**
The System enters the programming mode and the "CD PROGRAM" indicator lights up.

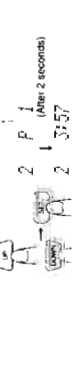

• **Press the UP, DOWN, >, or < button to select the track to program.**
UP or > button: Increases the track number by 1.
DOWN or < button: Decreases the track number by 1.
When the > or < button is kept pressed, the track number changes rapidly.

• **Press the SET button.**

• **Repeat steps 5 and 6 to select the other tracks for the program.**

Using the Cassette Deck (Recording)

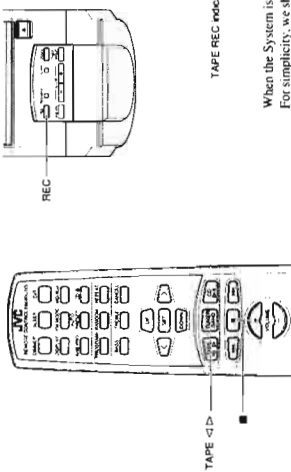

Recording onto a tape from any of the sound sources is simple. Just place a tape in the Cassette Deck, have the source ready, make one or two settings, and you're ready to record. For each source the procedure is a little bit different so we explain each separately. But first, here are a few things to make your recordings better.

Things To Know Before You Start Recording

- It may be unlawful to record or play back copyrighted material without the consent of the copyright owner.
- When you want to record onto both sides of a tape, you can set Reverse mode to do so. Recording automatically stops after recording is in the reverse direction. Therefore, make sure that the tape direction is in the reverse direction when recording with Reverse mode on.
- The recording level, which is the volume at which the new tape is being made, is automatically set correctly, so it is not affected by the VOLUME control on the System. Nor is it affected by adjusting the sound effects. Thus, during recording you can adjust the sound you are actually listening to without affecting the recording level.
- Two small tabs on the back of the cassette tape, one for side A and one for side B, can be removed to prevent accidental erasure or recording.

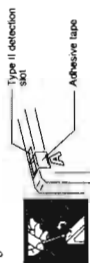

- To record on a cassette with the tabs removed, you must cover the holes with adhesive tape first. However, when a Type II tape is used, only cover part of the hole as shown, since the outer part of the hole (Type II detection slot) is used to detect the tape type.
- Type I and Type II tapes can be used for recording.

Note: At the start and end of cassette tapes, there is leader tape which cannot be recorded onto. Thus, when recording CDs or radio broadcasts, wind on the leader tape first to ensure getting the beginning of the recording.

English
English

Notes for using Reverse mode for recording

When recording in Reverse mode, the System automatically stops when it reaches the end of the reverse direction. To record on both sides of a tape, make sure that the recording direction for the tape inserted is forwards, and that the Tape Direction indicator is also forwards, before you start recording.

To Stop at Any Time During the Recording Process

Press the **REC** button.

CD Direct Recording

Everything on the CD goes onto the tape in the order it is on the CD, or according to the order you have set in a program.

Insert a cassette into the Cassette Deck and wind past the tape leader.

Insert a CD.

Press the CD >/II button on the Unit or on the Remote Control.

Press the **REC** button.

If you want to record specific tracks only, program the tracks beforehand. You can check their total playback time on the display during programming. (See page 11.)

If you want to record on both sides of a tape, press the REV. MODE button on the Unit until the "D" indicator is lit. Make sure that the recording direction for the tape and the Tape Direction indicator is correct. (See "Notes for using Reverse mode for recording".)

Choose whether to have pauses between recorded selections.

- If nothing is done, a non-recorded pause of about four seconds will be automatically left between selections.
- If you do not want pauses between selections, do the following before proceeding to the next step.

Press the CD >/II button on the Unit or the Remote Control twice.

The CD player enters Pause mode.

Press the REC button on the Unit.

The "TAPE REC" indicator lights up and the System begins recording.

- If you make a recording with Reverse mode on, the Unit will record the last song at the end of the first side onto the next side from its beginning when the song has been recorded more than 12 seconds on the first side.
- If the last song has been recorded less than 12 seconds, then the previous song will again be recorded on the next side as it will not be completely recorded on the first side because of leader tape.
- After the CD player has played the entire CD, or all the programmed tracks, the tape automatically stops.

To stop at any time during the recording process, press the **REC** button. The tape stops after four seconds.

Note: When making SLEEP timer settings, while doing CD Direct recording, set enough time to allow for the CD to finish playing, otherwise the power will go off before recording is completed.

Standard Recording

You can record any sound source to tape as follows:

Insert a blank or erasable tape into the Cassette Deck and wind past the tape leader.

Press the REV. MODE button on the Unit if you want to record on both sides of the tape.

When using Reverse mode, insert the tape so that it will be recorded in the forwards direction.

Make sure that the Tape Direction indicator is the same as that for the tape in the Cassette Deck. If the directions are different, press the TAPE <D> button to correct the tape direction and then press the **REC** button to stop the tape.

Prepare the source, by, for example, tuning in a radio station or turning on connected auxiliary equipment.

Note: For CD recording, refer to "CD Direct Recording" mentioned below.

Press the REC button on the Unit.

The "TAPE REC" indicator lights up and the System begins recording.

If the tab of the cassette tape is removed to prevent erasure or recording, "NO REC" will appear on the display.

One Track Recording

Insert a cassette into the Cassette Deck and wind past the tape leader.

Play the track on the CD you wish to record.

Press the REC button on the Unit.

The CD player returns to the beginning of that track and the track is recorded on the tape. After recording, the CD player and Cassette Deck automatically stop.

Using the Timers

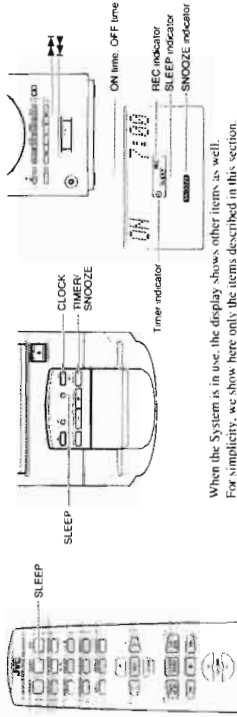

When the System is in use, the display shows other items, as well. For simplicity, we show here only the items described in this section.

The timers let you control listening and recording functions automatically.

Setting the Clock

When you plug the AC power cord into the wall outlet, the time indication blinks on the display.

- You can set the clock whether the System is on or off. In addition to the digital clock, the analog clock also shows the time.
- Notes:**
- The clock must be correctly set for the timers to work.
 - The procedure must be completed within two minutes. Otherwise, the setting is cleared and must be repeated from the beginning.



Press the CLOCK button on the Unit for more than two seconds.

The time indication rapidly blinks on the display.

Press the <right> or <left> button on the Unit to set the time.

Pressing the <right> button moves the time forwards and pressing the <left> button moves it backwards. Hold down the button to move the time rapidly.

Press the CLOCK button.

The selected time is set and the seconds start counting from 0.

CAUTION: If there is a power failure, the clock loses its setting after about 20 minutes. "0:00" blinks on the display and the clock must be reset.

Note: The clock may gain or lose one to two minutes per month.

Setting the Daily Timer

Once you have set the Daily Timer, the timer will be activated at the same time every day. It can be cancelled and re-activated whenever you wish.

The Timer indicator on the display shows when the Daily Timer you have set is in effect.

Note: Perform each setting within 30 seconds. Otherwise, setting is cleared and the procedure must be repeated from the beginning.

Using External Equipments

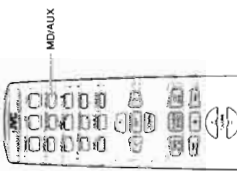

Listening to External Equipment

You can listen to external equipment such as MD recorder, turntable or other auxiliary.

- First make sure that the external equipment is properly connected to the System. (See page 4).

Set the VOLUME control to the minimum position.

Press the MD/AUX button.

"AUX" appears on the display.

Start playing the external equipment.

Adjust the VOLUME control to the desired listening level.

Apply sound effects, if you wish.

Press the AHB PRO button to reinforce the bass sound.

Press the BASS/TREBLE button on the Remote Control to control the tone. (See "Tone Control" on page 7.)

To exit MD/AUX mode, you will automatically switch out of MD/AUX mode when you select another source.

Note: For operation of the external equipment, refer to its instructions.

Recording the System's source to External Equipment

You can record the System's source to external equipment which is connected to the LINE OUT or OPTICAL, DIGITAL, OUT terminals of the System, such as cassette deck or MD recorder, etc.

- First make sure that the external equipment is properly connected to the System. (See page 4).

Play the System's CD Player, Cassette Deck, or tune into a station.

The recording level is not affected by the VOLUME level set by the System. Also it is not affected by the sound effects.

Note: For operation of the external equipment, refer to its instructions.

Press the <power> button to turn on the System.

Setting the ON time (Example: 12:15).

- Press the TIMER/SNOOZE button on the Unit. The Timer indicator lights up and the current ON time blinks on the display. When the clock is not set, the "CLOCK" indicator and the "ADJUST" indicator appear alternately on the display. Set the clock at first.

Press the <right> or <left> button on the Unit to set the time you want the Unit to come on.

Pressing the <right> button moves the time forwards and pressing the <left> button moves it backwards. Hold down the button to move the time rapidly.

Press the CLOCK button on the Unit to set the time you want the Unit to be turned off.

Pressing the <right> button moves the time forwards and pressing the <left> button moves it backwards. Hold down the button to move the time rapidly.

Setting the OFF time (Example: 13:15).

- Press the TIMER/SNOOZE button on the Unit. The current OFF time blinks on the display.

Press the <right> or <left> button on the Unit to set the time you want the Unit to be turned off.

Pressing the <right> button moves the time forwards and pressing the <left> button moves it backwards. Hold down the button to move the time rapidly.

Press the CLOCK button.

The selected time is set and the seconds start counting from 0.

CAUTION: If there is a power failure, the clock loses its setting after about 20 minutes. "0:00" blinks on the display and the clock must be reset.

Note: The clock may gain or lose one to two minutes per month.

Selecting the music source.

- Press the TIMER/SNOOZE button on the Unit. The "TUNER" blinks on the display.
- Press the <right> or <left> button to select the music source you want to listen to.

The display changes as shown below.

TUNER-->TUNER REC-->CD-->TAPE--> back to the beginning

When you select the "TUNER REC", the "REC" indicator appears on the display.

Setting the SLEEP Timer

- **Setting the volume level.**
 1. Press the **TIMER/SNOOZE** button on the Unit.
 2. The current volume setting blinks on the display.
 3. Press the **+** or **-** button to select the volume level.
 4. The current volume level will be used.
- 0 to 50: When the timer is turned on, the Volume will be automatically set to the selected level.

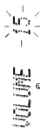

- **Press the **TIMER/SNOOZE** button on the Unit.**

The timer setting is completed and the display returns to the display before you set the timer. The timer indicator remains lit.

- **Before turning off the System, prepare the music source selected in step 4.**

TUNER: Tune in to the desired station.
TUNER REC: Tune in to the desired station and insert a cassette tape for recording the station.
CD: Insert a CD.
TAPE: Insert a tape.

- **Press the **OFF** button to turn off the System.**

To cancel the timer, press the **TIMER/SNOOZE** button. The timer indicator goes out on the display.

To reactivate the cancelled timer, press the **TIMER/SNOOZE** button to light the timer indicator. Then, press the **TIMER/SNOOZE** button until the display returns to the original display. The timer indicator should remain lit.

To confirm the timer settings, cancel the timer once by pressing the **TIMER/SNOOZE** button. Then, press the **TIMER/SNOOZE** button repeatedly, to see the current timer settings (ON time, OFF time, source, and volume).

To change the timer setting, repeat the setting procedure from the beginning.

- When the timer turns on, the timer indicator starts blinking.

CAUTION: If the System is unplugged, or a power failure occurs, the timer setting will be lost. You will need to reset the clock first, then the timer.

5-Minute Snoozing

When the timer turns on the music source you can, if you wish, activate the 5-minute snoozing function to temporarily stop playback.

Press the **TIMER/SNOOZE** button on the Unit.

The "SNOOZE" indicator lights up on the display and the power is turned off for five minutes for snoozing.

English
English

Care And Maintenance

- Handle your CDs carefully, and they will last a long time.
- If there are fingerprints, etc. on the lens, gently wipe clean with a cotton swab.

Compact Discs

Only CDs bearing this mark can be used with this System. However, continued use of irregular-shaped CDs (heart-shaped, octagonal, etc.) can damage the System.



Remove the CD from its case by holding it at the edges while pressing the case's center hole lightly. Do not touch the shiny surface of the CD, or bend the CD.



Put the CD back in its case after use to prevent warping. Be careful not to scratch the surface of the CD when placing it back in the case. Avoid exposure to direct sunlight, temperature extremes, and moisture.



A dirty CD may not play correctly. If a CD does become dirty, wipe it with a soft cloth in a straight line from center to edge.

In general, you will have the best performance by keeping your CDs and the mechanism clean.

- Store CDs in their cases, and keep them in cabinets or on shelves.
- Keep the system's CD cover closed when not in use.

General Notes

If the lens in the CD pickup is dirty, dropout, etc., could degrade sound.

Open the CD cover and clean the lens as shown.

- Use a blower (available from a camera store) to blow dust off the lens.

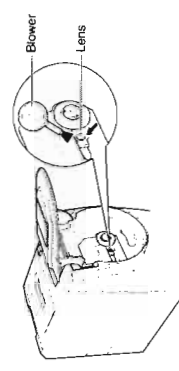

Moisture Condensation

Moisture may condense on the lens inside the System in the following cases.

- After turning on hearing in the room.
 - In a damp room.
 - If the System is brought directly from a cold to a warm place.
- Should this occur, the System may malfunction. In this case, leave the System turned on for a few hours until the moisture evaporates, unplug the AC power cord, and then plug it in again.

Cassette Tapes

If the tape is loose, it may get stretched, cut, or caught in the cassette. Take up the slack by inserting a pencil in one of the reels and rotating.

- Do not touch the tape surface.

Cassette Deck

Do not store the tape:

- In dusty places
- In direct sunlight or heat
- In moist areas
- On a TV or speaker
- Near a magnet

Cassette Deck

If the heads, capstans, or pinch-rollers of the Cassette Deck become dirty, the following may occur:

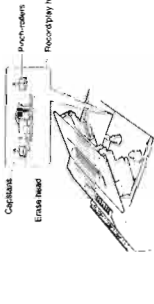

- Loss of sound quality
 - Discontinuous sound
 - Fading
 - Incomplete erasure
 - Difficulty recording
- Clear the heads, capstans, and pinch-rollers using a cotton swab moistened with alcohol.



- If the heads become magnetized, the Unit will produce noise or low-high frequency notes.
- To demagnetize the heads, turn off the Unit, and use a head demagnetizer (available at electronics and record shops).

Troubleshooting

- If you are having a problem with your System, check this list for a possible solution before calling for service.
- If you cannot solve the problem from the hints given here, or the System has been physically damaged, call a qualified person, such as your dealer, for service.

Symptom	Possible Cause	Action
No sound is heard.	<ul style="list-style-type: none"> • Connections are incorrect, or loose. • Headphones are connected. 	<ul style="list-style-type: none"> • Check all connections and make corrections. (See pages 4-5.) • Disconnect the headphones.
Unable to record.	Cassette record protect tabs are removed.	Cover the holes on the back edge of the cassette with tape.
Poor radio reception	<ul style="list-style-type: none"> • The antenna is disconnected. • The AM Loop Antenna is too close to the System. • The FM Wire Antenna is not properly extended and positioned. 	<ul style="list-style-type: none"> • Reconnect the antenna securely. • Change the position and direction of the AM Loop Antenna. • Extend FM Wire Antenna to the best reception position.
The CD skips.	The CD is dirty or scratched.	Clean or replace the CD.
The CD does not play.	The CD is upside down.	Put the CD in with the label side up.
Unable to operate the Remote Control.	<ul style="list-style-type: none"> • The path between the Remote Control and the sensor on the Unit is blocked. • The batteries have lost their charge. 	<ul style="list-style-type: none"> • Remove the obstruction. • Replace the batteries.
Operations are disabled.	The built-in microprocessor has malfunctioned due to external electrical interference.	Unplug the System then plug it back in.
The cassette holder cannot be opened.	During tape playing, the power cord was unplugged.	Plug in the power cord, press the  button, and then press the  button.

English

Specifications

- Amplifier**
Output Power 34 W (17 W + 17 W) at 4 ohms (Max.)
24 W (12 W + 12 W) at 4 ohms (10% THD)

Input Sensitivity/Impedance (1 kHz)
LINE IN (AUX) 500 mV/65 kohms
Output Sensitivity/Impedance (1 kHz)
LINE OUT 500 mV/4.3 kohms
Optical out -21 dBm -15 dBm
Speaker terminals 4 - 16 ohms
Phones 16 ohms, 1 kohms
0 - 15 mW/ch output into 32 ohms

Cassette Deck

Frequency Response
TypeII (CrO2) 50 Hz - 15 kHz
Wow and Flutter 0.15 % (WRMS)

CD Player

Signal-To-Noise Ratio 90 dB
Wow And Flutter Unmeasurable

Tuner

FM Tuner
Tuning Range 87.5 - 108.0 MHz
AM Tuner
Tuning Range (MW) 522 - 1,629 kHz
(LW) 144 - 288 kHz

Speaker Specifications

(each unit)
Speakers 8 cm cone
Impedance 4 ohms
Dimensions 140 X 230 X 217 mm (W/H/D)
Mass Approx. 1.8 kg

General

Dimensions 438 X 232 X 310.5 mm (W/H/D)
Mass Approx. 7.2 kg

Accessories

Power Cord (1)
AM Loop Antenna (1)
Remote Control (1)
Batteries R6P (SUM-3 VAA (15F)) (2)
FM Wire Antenna (1)

Power Specifications

Power Requirements AC 230 V ~, 50 Hz
Power Consumption 38 watts (power on mode)
3.3 watts (in Standby mode)

Design and specifications are subject to change without notice.

JVC

**MICRO COMPONENT SYSTEM
MIKRO-KOMPONENTEN-SYSTEM
SYSTEME DE MICROCOMPONENTS
SISTEMAS DE MICROCOMPONENTES
SISTEMA A MICROCOMPONENTI**

UX-V5R

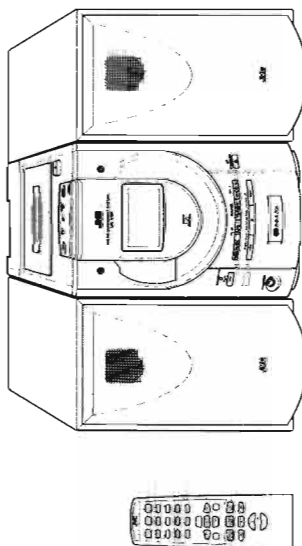

COMPACT DISC DIGITAL AUDIO

COMPACT DISC DIGITAL AUDIO

**INSTRUCTIONS
BEDIENUNGSANLEITUNG
MANUEL D'INSTRUCTIONS
GEBRUIKSAANWIJZING
MANUAL DE INSTRUCCIONES
ISTRUZIONI**

For Customer Use:
Enter below the Model No. and Serial No. which are located either on the rear, bottom or inside of the cabinet. Retain this information for future reference.

Model No.
Serial No.

LV70211-001A (E)

Warnings, Cautions and Others / Warnung, Achtung und sonstige Hinweise / Mises en garde, précautions et indications diverses / Waarschuwingen, voorzorgen en andere mededelingen/ Avisos, precauciones y otras notas / Avvertenze e precauzioni da osservare

Caution — \odot | switch!
Disconnect the mains plug to shut the power off completely. The \odot | switch in any position does not disconnect the mains line. The power can be remote controlled.

Achtung — \odot | Schalter!
Den Netzstecker aus der Steckdose ziehen, um die Stromversorgung vollkommen zu unterbrechen. Der Schalter \odot | unterbricht in keiner Stellung die Stromversorgung vollkommen. Die Stromversorgung kann mit der Fernbedienung ein- und ausgeschaltet werden.

Attention — Commutateur \odot |!
Déconnecter la fiche de secteur pour couper complètement le courant. Le commutateur \odot | ne coupe jamais complètement la ligne de secteur, quelle que soit sa position. Le courant peut être télécommandé.

Voorzichtig — \odot | schakelaar!
Om de stroomvoorziening geheel uit te schakelen, trek u de stekker uit het stopcontact. Anders zal er altijd een geringe hoeveelheid stroom naar het apparaat lopen, ongeacht de stand van de \odot | schakelaar. U kunt het apparaat ook met de afstandsbediening aan- en uitschakelen.

Precaución — Interruptor \odot |!
Desconectar el cable de alimentación para desactivar la alimentación totalmente. Cualquiera que sea la posición de ajuste del interruptor \odot |, la alimentación no es cortada completamente. La alimentación puede ser controlada remotamente.

Avvertenze — Interruttore \odot |!
Disinserire la spina di alimentazione dalla presa della rete elettrica per staccare completamente l'alimentazione. L'interruttore \odot | in nessuna posizione stacca la linea di alimentazione elettrica principale. È possibile il controllo remoto dell'alimentazione.

Per l'Italia:
Si dichiara che il questo prodotto di marca JVC è conforme alle prescrizioni del Decreto Ministeriale n. 548 del 28/08/95 pubblicato sulla Gazzetta Ufficiale della Repubblica Italiana n. 301 del 28/12/95.

CAUTION
To reduce the risk of electrical shocks, fire, etc.:

1. Do not remove screws, covers or cabinet.
2. Do not expose this appliance to rain or moisture.

ACHTUNG
Zur Vermeidung von elektrischen Schlägen, Brandgefahr, usw.:

1. Keine Schrauben, Linsen oder Abdeckungen entfernen und das Gehäuse nicht öffnen.
2. Dieses Gerät weder Regen noch Feuchtigkeit aussetzen.

ATTENTION
Afin d'éviter tout risque d'électrocution, d'incendie, etc.:

1. Ne pas enlever les vis ni les panneaux et ne pas ouvrir le boîtier.
2. Ne pas exposer l'appareil à la pluie ni à l'humidité.

VOORZICHTIG
Ter vermindering van gevaar voor brand, elektrische schokken, enz.:

1. Verwijder geen schroeven, panelen of de behuizing.
2. Stel het toestel niet bloot aan regen of vocht.

PRECAUCIÓN
Para reducir el riesgo de choques eléctricos, incendios, etc.:

1. No extraiga los tornillos, las cubiertas ni la caja.
2. No exponga este aparato a la lluvia o a la humedad.

ATTENZIONE
Per ridurre il rischio di shock elettrici, incendi, ecc.:

1. Non togliere viti, copercchi o la scatola.
2. Non esporre l'apparecchio alla pioggia e all'umidità.

Caution: Proper Ventilation
To avoid risk of electric shock and fire, and to prevent damage, locate the apparatus as follows:

1. Front: No obstructions and open spacing.
2. Sides/ Top/ Back: No obstructions should be placed in the areas shown by the dimensions below.
3. Bottom: Place on the level surface. Maintain an adequate air path for ventilation by placing on a stand with a height of 10 cm or more.

Vorsicht: Ausreichende Belüftung
Zur Vermeidung von elektrischen Schlägen, Feuer und sonstigen Schäden sollte das Gerät unter folgenden Bedingungen aufgestellt werden:

1. Vorderseite: Hindernisse sind gut zugänglich.
2. Seiten- und Rückwände: Hindernisse in allen gegebenen Abständen (s. Abbildung).
3. Unterseite: Die Stieflöcher muß absolut eben sein. Sorgen Sie für ausreichende Luftzufuhr durch Aufstellung auf einem Stand mit mindestens 10 cm Höhe.

Attenzion: Aération correcte
Pour prévenir tout risque de décharge électrique ou d'incendie et éviter toute détérioration, installez l'appareil de la manière suivante:

1. Avant: Aucun objet ne doit bloquer le tout objet.
2. Côtés/dessus/dessous: Assurez-vous que rien ne bloque les espaces indiqués sur le schéma ci-dessous.
3. Dessous: Posez l'appareil sur une surface plane et horizontale. Veillez à ce que sa ventilation correcte puisse se faire en le plaçant sur un support d'au moins dix centimètres de hauteur.

Front view
Vorderansicht
Face
Vooransicht
Vista frontal
Vista frontale

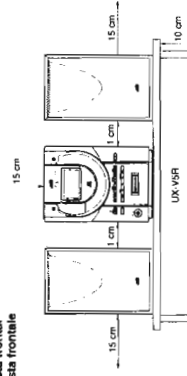

Side view
Seitenansicht
Côté
Zijaanzicht
Vista lateral
Vista laterale

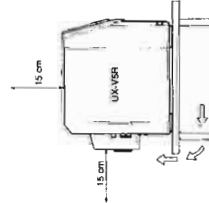

Voorzichtig: Goede ventilatie vereist
Om brand, elektrische schokken en beschadiging te voorkomen, moet u het toestel als volgt opstellen:

1. Voorkant: Geen belemmeringen en voldoende ruimte.
2. Zijkenen/boven/onderkant: Geen belemmeringen plaatsen in de hieronder aangegeven zones.
3. Onderkant: Op vlakke ondergrond plaatsen. Voldoende ventilatieruimte voorzien door het toestel op een onderstel met een hoogte van 10 cm of meer te plaatsen.

Precaucion: ventilación correcta
Para evitar el riesgo de descargas eléctricas e incendio y prevenir posibles daños, instale el equipo en un lugar que cumpla los siguientes requisitos:

1. Parte delantera: Sin obstrucciones, espacio abierto.
2. Lados/parte superior/inferior: No debe haber ninguna obstrucción en las áreas mostradas por las dimensiones de la siguiente figura.
3. Parte inferior: Situe el equipo sobre una superficie nivelada. Mantenga un espacio adecuado para permitir el paso del aire y una correcta ventilación, situando el equipo sobre un soporte de 10 ó más cm de altura.

Attenzione: Per una corretta ventilazione
Per prevenire il rischio di scosse elettriche e di incendio ed evitare possibili danni, collocare le apparecchiature nel modo seguente:

1. Parte anteriore: Nessun ostacolo e spazio libero.
2. Lati/Parte superiore/Inferiore: Lasciare libere le zone indicate dalle dimensioni di seguito.
3. Base: Collocare su una superficie piana. Consentire un'adeguata ventilazione dell'impianto appoggiandolo su un tavolino alto almeno 10 cm.

IMPORTANT FOR LASER PRODUCTS/ WICHTIGER HINWEIS FÜR LASER-PRODUKTE / IMPORTANT POUR LES PRODUITS LASER / BELANGRIJKE INFORMATIE VOOR LASER-PRODUCTEN / IMPORTANTE PER I PRODOTTI LASER

REPRODUCTION OF LABELS/ AANHANGINGSORTE FÜR LASER-PRODUKTE/ REPRODUCTION DES ÉTIQUETTES/ VERKLARING VAN DE LABELS/ REPRODUCCION DE ETIQUETAS/ REPRODUZIONE DELLE ETICHETTE

1. CLASSIFICATION LABEL, PLACED ON EXTERIOR SURFACE
2. CLASSIFICAZIONE LABEL, PLACED ON EXTERIOR SURFACE
3. WARNETIKETTE IM GERÄTEINNEREN
4. ÉTIQUETTE D'AVERTISSEMENT PLACÉE À L'INTÉRIEUR DE L'APPAREIL
5. WAARSCHUWINGSLABEL, IN HET APPARAAT
6. ETIQUETA DE ADVERTENCIA, PEGADA EN EL INTERIOR DE LA UNIDAD
7. ETICHETTA DI AVVERTENZA, SITUATA ALL'INTERNO DELL'APPARECCHIO

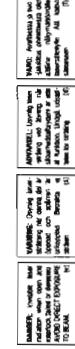
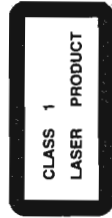

1. CLASS 1 LASER PRODUCT
2. DANGER: Invisible laser radiation when open and interlock failed or defeated. Avoid direct exposure to beam.
3. CAUTION: Do not open the top cover. There are no user serviceable parts inside the Unit. Leave all servicing to qualified service personnel.
4. LASER-PRODUKT DER KLASSE 1
5. GEFAHR: Unsichtbare Laserstrahlung bei Öffnung und fehlerhafter oder beschädigter Sperr. Direkten Kontakt mit dem Strahl vermeiden!
6. ACHTUNG: Das Gehäuse nicht öffnen. Das Gerät enthält keine für den Benutzer gewarteten Teile. Überlassen Sie Wartungsarbeiten bitte qualifiziertem Kundendienstpersonal.
7. PRODOTTO LASER CLASSE 1
8. PERICOLO: Radiazione laser invisibile quando l'apparecchio è aperto ed il dispositivo di sicurezza è guasto o disattivato. Evitare esposizione diretta al raggio laser.
9. ATTENZIONE: Non aprire la copertura superiore. Non vi sono parti adoperabili dall'utente all'interno di questo apparecchio, lasciare tutti i controlli a personale qualificato.

1. KLAS 1 LASERPRODUCT
2. GEVAARLIJK: Onzichtbare laserstraling wanneer open en de beveiliging faalt of uitgeschakeld is. Voorkom het direct blootstaan aan de straal.
3. VOORZICHTIG: De boventrap niet openen. Binnenin het toestel vinden zich geen voor het gebruik te repareren onderdelen.
4. PRODUCTO LASER CLASE 1
5. PELIGRO: En el interior hay radiación láser invisible. Evite el contacto directo con el haz.
6. PRECAUCIÓN: No abra la tapa superior. En el interior de la unidad no existen piezas reparables por el usuario, deje todo servicio técnico en manos de personal cualificado.
7. PRODOTTO LASER CLASSE 1
8. PERICOLO: Radiazione laser invisibile quando l'apparecchio è aperto ed il dispositivo di sicurezza è guasto o disattivato. Evitare esposizione diretta al raggio laser.
9. ATTENZIONE: Non aprire la copertura superiore. Non vi sono parti adoperabili dall'utente all'interno di questo apparecchio, lasciare tutti i controlli a personale qualificato.

Getting Started

English
English

Accessories

Make sure that you have all of the following items, which are supplied with the System.

- Power Cord (1)
- AM Loop Antenna (1)
- Remote Control (1)
- Batteries (2)
- FM Wire Antenna (1)

If any of these items are missing, contact your dealer immediately.

How To Put Batteries in the Remote Control

Match the polarity (+ and -) on the batteries with the + and - markings in the battery compartment.

REF(SUM-3)/AA(15F)

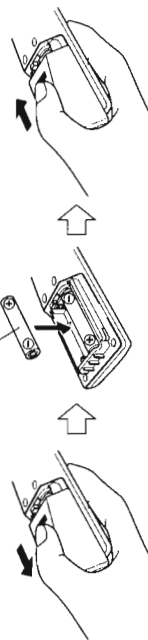

CAUTION: Handle batteries properly.

To avoid battery leakage or explosion:

- Remove batteries when the Remote Control will not be used for a long time.
- When you need to replace the batteries, replace both batteries at the same time with new ones.
- Don't use an old battery with a new one.
- Don't use different types of batteries together.

Using the Remote Control

The Remote Control makes it easy to use many of the functions of the System from a distance of up to 7m (23 feet) away. You need to point the Remote Control at the remote sensor on the System's front panel.

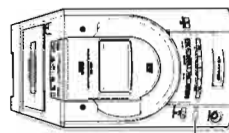

Remote sensor

Features

Here are some of the things that make your System both powerful and simple to use.

- The controls and operations have been redesigned to make them very easy to use, freeing you to just enjoy the music.
- With JVC's **COMPU PLAY**, you can turn on the System and automatically start the Radio, Cassette deck or CD Player with a single touch.
- The System incorporates Active Hyper Bass PRO circuitry to faithfully reproduce low frequency sounds.
- A 45-station preset capability (30 FM and 15 AM (MW/L, W)) in addition to auto seek and manual tuning.
- Versatile CD options include repeat, random and program play.
- Timer functions, Daily Timer and Sleep Timer.
- Auto-reverse tape function.
- The System is compatible with RDS (Radio Data System) broadcasting.
 - The EON data enables you to standby for desired information.
 - The PTY Search function searches for programmes in the category you wish.
- In addition, Radio Text can be displayed using data sent by station.
- You can connect various external units, such as an MD recorder.



How This Manual Is Organized

- Basic information that is the same for many different functions - e.g. setting the volume - is given in the section 'Common Operations' and not repeated under each function.
- The names of buttons/controls and display messages are written in all capital letters: e.g. TUNER BAND, "NO DISC".
- System functions are written with an initial capital letter only: e.g. Normal Play.

Use the table of contents to look up specific information you require.

We've enjoyed making this manual for you, and hope it serves you in enjoying the many features built into your System.

IMPORTANT CAUTIONS

Installation of the System

- Select a place which is level, dry and neither too hot nor too cold. (Between 5°C and 35°C or 41°F and 95°F.)
- Leave sufficient distance between the System and a TV.
- Do not use the System in a place subject to vibrations.

Power cord

- Do not handle the power cord with wet hands!
- Some power is always consumed as long as the power cord is connected to the wall outlet.
- When unplugging the System from the wall outlet, always pull the plug, not the power cord.

Maintenances, etc.

- There are no user serviceable parts inside. In case of system failure, unplug the power cord and consult your dealer.
- Do not insert any metallic object into the System.

Table of Contents

Features	1
How This Manual Is Organized	1
IMPORTANT CAUTIONS	1
Getting Started	2
Common Operations	6
Using the Tuner	8
Using the CD Player	12
Using the Cassette Deck (Listening to a Tape)	14
Using the Cassette Deck (Recording)	15
Using External Equipments	17
Using the Timers	18
Care And Maintenance	20
Troubleshooting	21
Specifications	22

CAUTION: Make all connections before plugging the System into an AC power outlet.

Connecting the FM Antenna

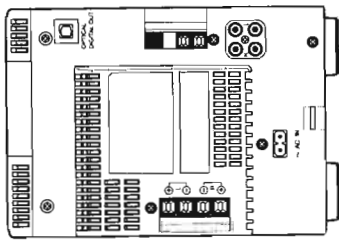

Using the Supplied Wire Antenna



Using the Coaxial Type Connector (Not Supplied)

A 75-ohm antenna with coaxial type connector (IEC or DIN45 325) should be connected to the FM 75-ohm COAXIAL terminal.



If reception is poor, connect the outside antenna.
FM outdoor antenna (Not supplied)
Coaxial cable

Note: Before attaching a 75-ohm coaxial lead (the kind with a round wire going to an outside antenna), disconnect the supplied FM Wire Antenna.

English
English

CAUTION: Make all connections before plugging the System into an AC power outlet.

Connecting the Speakers

For each speaker, connect one end of the speaker wire to the speaker terminals on the back of the System.

1. Open each of the terminals and insert the speaker wires firmly, then close the terminals.
2. Connect the red (+) and black (-) wires of the right side speaker to the red (+) and black (-) terminals marked R on the System. Connect the red (+) and black (-) wires of the left side speaker to the red (+) and black (-) terminals marked L on the System.

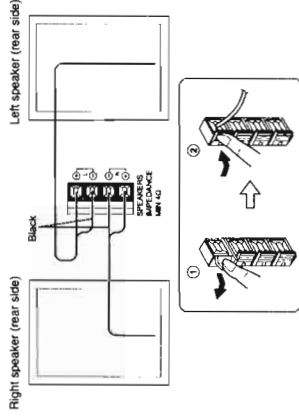

CAUTION: A TV may display irregular colors if located near the speakers. If this happens, set the speakers away from the TV.

Connecting External Equipment

Connect signal cords (not supplied) between the System's LINE IN (AUX) / LINE OUT terminals and the output/input terminals of the external MD recorder, tape deck, etc.

You can then listen to the external source through the System's CD player, cassette tape, or tuner to the external unit.

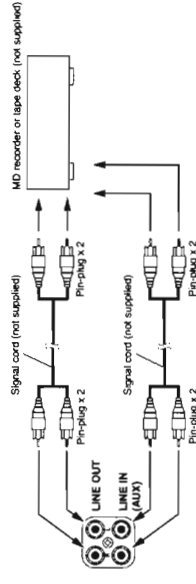

Connecting an MD Recorder, etc. (Digital Output)

Unplug the cap and connect an optical digital cord (not supplied) between the System's OPTICAL DIGITAL OUT terminal and the input terminal of the MD recorder, etc.

You can record the digital output signal from the System's CD Player to the MD recorder, etc.

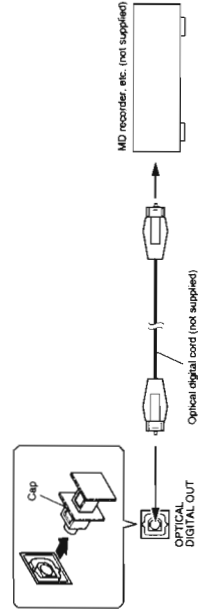

English
English

CAUTION: Make all connections before plugging the System into an AC power outlet.

Connecting the AM (FM/LW) Antenna

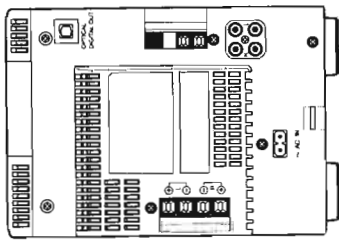

Using the Supplied Wire Antenna



Using the Coaxial Type Connector (Not Supplied)

A 75-ohm antenna with coaxial type connector (IEC or DIN45 325) should be connected to the FM 75-ohm COAXIAL terminal.



If reception is poor, connect the outside antenna.
FM outdoor antenna (Not supplied)
Coaxial cable

Note: Before attaching a 75-ohm coaxial lead (the kind with a round wire going to an outside antenna), disconnect the supplied FM Wire Antenna.

English
English

CAUTION: Make all connections before plugging the System into an AC power outlet.

Connecting the AM (FM/LW) Antenna

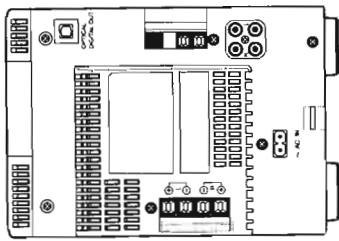

Using the Supplied Wire Antenna



Using the Coaxial Type Connector (Not Supplied)

A 75-ohm antenna with coaxial type connector (IEC or DIN45 325) should be connected to the FM 75-ohm COAXIAL terminal.



If reception is poor, connect the outside antenna.
FM outdoor antenna (Not supplied)
Coaxial cable

Note: Before attaching a 75-ohm coaxial lead (the kind with a round wire going to an outside antenna), disconnect the supplied FM Wire Antenna.

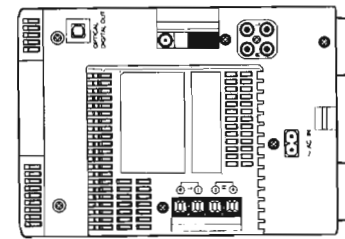

AM loop antenna (Supplied)

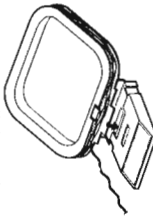

Attach the AM loop to its base by snapping the tabs on the loop into the slot in the base.

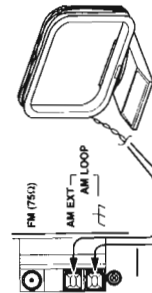

Turn the loop until you have the best reception.

CAUTION: To avoid noise, keep antennas away from the System, the connecting cord and the AC power cord.

Common Operations

English

English

Connecting the AC Power Cord

Firmly insert the supplied AC power cord into the AC inlet on the back of the Unit.

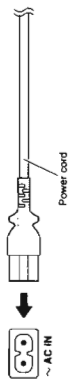

CAUTIONS:

- ONLY USE THE JVC POWER CORD PROVIDED WITH THIS SYSTEM TO AVOID MALFUNCTION OR DAMAGE TO THE SYSTEM.
- BE SURE TO UNPLUG THE POWER CORD FROM THE OUTLET WHEN GOING OUT OR WHEN THE SYSTEM IS NOT IN USE FOR AN EXTENDED PERIOD OF TIME.

Now you can plug the AC power cord into the wall outlet, and your System is at your command!

COMPU PLAY

JVC's COMPU PLAY feature lets you control the most frequently used System functions with a single touch. With One Touch Operation you can play a CD, a tape, turn on the radio, or listen to an external equipment with a single press of the play button for that function. One Touch Operation turns the power on for you, then starts the function you have specified. If the System is not ready (no CD in place), the System still powers on so you can insert a CD.

How One Touch Operation works in each case is explained in the section dealing with that function. The COMPU PLAY buttons are:

On the Unit

- CD >|< button
- TUNER BAND button
- TAPE <|> button
- MD/AUX button

On the Remote Control

- CD >|< button
- TUNER BAND button
- TAPE <|> button
- MD/AUX button

AUTOMATIC POWER ON

The System automatically turns on with the following operation.

- When you press the CD button, the System automatically turns on and the CD cover opens to allow CD insertion. However, this operation does not change the function to CD.

When you press the OVI button to turn off the System, the CD cover will automatically close if it is opened.

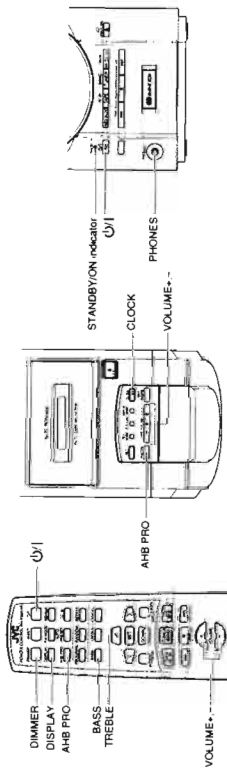

Turning the Power On and Off

Turning the System On

Press the OVI button.

The display comes on and "HELLO" is displayed once. The STANDBY/ON indicator lights in green. The System comes on ready to continue in the mode it was in when the power was last turned off.

- For example, if the last thing you were doing was listening to a CD, you are now ready to listen to a CD again. If you wish, you can change to another source.
- If you were listening to the Tuner last, the Tuner comes on playing the station it was last set to.

Turning the System Off

Press the OVI button again.

- "GOOD BYE" is displayed and the display goes out, except for the clock display. The STANDBY/ON indicator lights in red.
- Some power is always consumed even though power is turned off (called Standby Mode).
- To switch off the System completely, unplug the AC power cord from the wall outlet. When you unplug the AC power cord, the clock will be reset to 0:00 after about 20 minutes.

Adjusting the Volume

Press the VOLUME + button to increase the volume or press the VOLUME - button to decrease it.



You can adjust the volume level between 0 and 50.

CAUTION: DO NOT turn on the System and/or start playing any source without first setting the VOLUME control to minimum, as a sudden blast of sound could damage your hearing, speakers and/or headphones.

For private listening

Connect a pair of headphones to the PHONES jack. No sound comes out of the Speakers.

Be sure to turn down the volume before connecting or putting on headphones.

Adjusting the Brightness (DIMMER)

You can adjust the brightness of the backlighting for the display.

When the System is Turned On

To make the brightness of the backlighting darker, press the DIMMER button on the Remote Control.

To make the brightness brighter, press the DIMMER button on the Remote Control again.

When the System is Turned Off (STANDBY MODE)

To turn on the backlighting, press the DIMMER button on the Remote Control. The brightness is the same as for darker one mentioned above.

To turn off the backlighting, press the DIMMER button on the Remote Control again.

English
English

Showing the Time (DISPLAY)

In Standby mode, the digital clock and analog clock appear on the display at the same time. Meanwhile, only the analog clock is displayed when a music source is selected. Namely, you can see the analog clock at all times.

When the System is turned on, you can display the digital clock at any time.

To display the digital clock, press the CLOCK button on the Unit or DISPLAY button on the Remote Control.

To return to the previous mode, press the same button again.

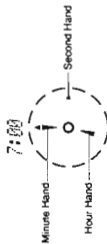

Note: To let work the clock, you need to set the clock beforehand. (See "Setting the Clock" on page 18.)

Reinforcing the Bass Sound (AMB PRO)

You can reinforce the bass sound to maintain rich, full bass at low volume (you can use this effect only for playback).

To get the effect, press the AMB (Active Hyper Bass) PRO button.

The "BASS" indicator lights up on the display.

To cancel the effect, press the button again.

The "BASS" indicator goes out.

Tone Control (BASS/TREBLE)

You can control the tone by changing the bass and treble. The analog clock acts to display the bass and treble settings.

By pressing either the BASS or TREBLE button on the Remote Control, you can visually see the current tone control settings.

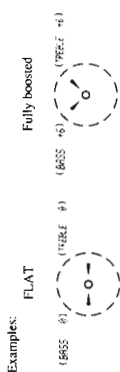

BASS Control
You can adjust the bass level (low frequency range level) between -6 and +6. (0: Flat)

Press the BASS button on the Remote Control.

Press the UP or DOWN button on the Remote Control to adjust the bass level.



TREBLE Control
You can adjust the treble level (high frequency range level) between -6 and +6. (0: Flat)

Press the TREBLE button on the Remote Control.

Press the UP or DOWN button on the Remote Control to adjust the treble level.



Using the Tuner

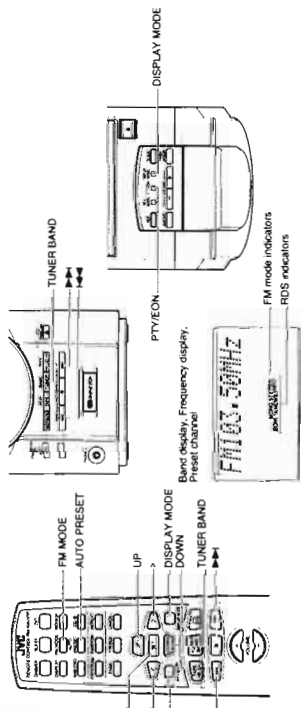

When the System is in use, the display shows other items as well. For simplicity, we show here only the items described in this section.

Select the desired preset number using the Up, Down, > and < button on the Remote Control. After 1 second the display will show the preset number, band and frequency.
Example: Press the UP button until the preset number "12" "P12" appears.



Presetting Stations
You can preset up to 30 FM stations and up to 15 AM (MW/LW) stations using the Remote Control.

Note: Preset numbers may have been set to factory test frequencies prior to shipment. This is not a malfunction. You can preset the stations you want into memory by following one of the presetting methods below.

Manual Presetting

Select a band by pressing the TUNER BAND button.

Press the < or > button to tune in a station.

Press the SET button.

"SET" will blink for 5 seconds.

Within 5 seconds, proceed to the next step.

When the display returns to the one set in STEP2 after 5 seconds, press the SET button again.



You can listen to FM and AM (MW/LW) stations. Stations can be tuned in manually, automatically, or from preset memory storage.

Before listening to the radio:

- Make sure that both the FM and AM (MW/LW) antennas are correctly connected. (See page 3).

One Touch Radio
Just press the TUNER BAND button to turn on the System and start playing the station you were last tuned to.

You can switch from any other sound source to the radio by pressing the TUNER BAND button.

Tuning in a Station

Press the TUNER BAND button.

The Band and Frequency you were last tuned to appear on the display.

If the last station was selected using the preset number, the preset number appears first.

Each time you press the button, the band alternates between FM and AM (MW/LW).



Select a station using one of the following methods.

Manual Tuning
Press the < or > button on the Unit or the Remote Control repeatedly to move from frequency to frequency until you find the station you want.

OR

Auto Tuning
If you press and hold the < or > button on the Unit or the Remote Control for one second or more, the frequency changes down, or up, automatically until a station is found.

OR

Preset Tuning using the Remote Control (Possible only after presetting stations)

Receiving FM Stations with RDS

You can use the RDS (Radio Data System) by using the buttons on the Unit or the Remote Control.

RDS allows FM stations to send additional signals with their regular programme signals. For example, the stations send their station names, and information about what type of programmes they broadcast, such as sports or music, etc. This unit can receive the following types of RDS signals:

- PS (Programme Service): Shows commonly known station names.
- PTY (Programme Type): Shows types of broadcast programmes.
- RT (Radio Text): Shows a text message, the station sends.

What information can RDS signals provide?
The display shows RDS signal information that the station sends.

To show the RDS signals on the display
Press the **DISPLAY MODE** button while listening to an FM station.

Each time you press the button, the display changes to show information in the following order:

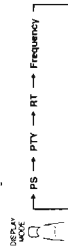

- PS (Programme Service):** While searching, "PS" appears, then station name is displayed. "NO PS" appears if no signal is sent.
- PTY (Programme Type):** While searching, "PTY" appears, then broadcast programme type is displayed. "NO PTY" appears if no signal is sent.
- RT (Radio Text):** While searching, "RT" appears, then a text message sent by the station is displayed. "NO RT" appears if no signal is sent.

Station Frequency: Station frequency (non-RDS service)

- Notes:**
- If searching finishes at once, "PS", "PTY" and "RT" will not appear on the display.
 - If you press the **DISPLAY MODE** button while listening to an AM (MW/LW) station, the display only shows station frequency.
 - RDS is not available for AM (MW/LW) broadcasts.

Press the UP, DOWN, >, or < button within 5 seconds to select the preset number.
UP or > button: Increases the preset number by 1.
DOWN or < button: Decreases the preset number by 1.
When the > or < button is kept pressed, the preset number changes rapidly.

Press the SET button within 5 seconds.
"STORED" appears and after 2 seconds, the display returns to the broadcast frequency display.

Repeat above steps 1 to 5 for each station you want to store in memory with a preset number.
To change the preset stations, repeat the same steps as above.

Auto Presetting

In each band, you can automatically preset FM30, AM (MW/LW) 15 stations. Preset numbers will be allocated as stations are found, starting from the lowest frequency and moving up the frequency.



Select a band by pressing the TUNER BAND button.

Press the AUTO PRESET button on the Remote Control for more than two seconds.

Repeat steps 1-2 for the other band.

If you want to change the preset stations, carry out the Manual Presetting for the desired preset numbers.

CAUTION: Even if the system is unplugged or if the power failure occurs, the preset stations will be stored for about 24 hours. However, in case the preset stations are erased, you will need to preset the stations again.

To Change the FM Reception Mode

When you are tuned into an FM stereo broadcast, the "STEREO" indicator lights up and you can hear stereo effects. If an FM stereo broadcast is hard to receive or noisy, you can select Manual mode. Reception improves, but you lose any stereo effect.

Press the FM MODE button on the Remote Control so that the "MONO" indicator lights up on the display.



To restore the stereo effect, press the FM MODE button on the Remote Control so that the "MONO" indicator goes off.

On characters displayed

When the display shows PS, PTY or RT signals:

- The display shows upper case letters only.
- The display cannot show accented letters. For example, "A" may represent accented "Á" as like "A, Á, A, A, and Á".

To search for a programme by PTY codes

One of the advantages of the RDS service is that you can locate a particular kind of programme by specifying the PTY codes. To search for a programme using PTY or TA codes:



Press the PTY button once while listening to an FM station.
"PTY SELECT" appears on the display.

Select the PTY code using the ← or → button (or UP or DOWN button on the Remote Control) within 10 seconds.

Each time you press the button, the display shows a category in the following order:

- NEWS → AFFAIRS → INFO → SPORT → EDUCATE → DRAMA → CULTURE → SCIENCE → VARIETY → OTHER M → ROCK M → LIGHT M → CLASSICS → OTHER M → WEATHER → FINANCE → CHILDREN → SOCIAL A → RELIGION → PHONE IN → TRAVEL → SOLEISURE → JAZZ → COUNTRY → NATIONAL → OLDIES → FOLK M → DOCUMENT → TEST → ALARM → NEWS

Press the PTY button within 10 seconds again.

While searching, the display alternates between "SEARCH" and the selected PTY code. The unit searched 30 preset stations and stops when it finds a station of the category you have selected, then tunes into that station.

To continue searching after the first stop, press the PTY button again while the display indications blink. If no programme is found, "NOT FOUND" appears on the display. To stop searching at any time during the process, press the PTY button to stop search operation.

Descriptions of the PTY Codes

NEWS: News programmes expanding on the current news or affairs
AFFAIRS: Programmes on medical service, weather forecasts, etc.
INFO: Sports events

EDUCATE: Educational programmes
SPORT: Radio plays

DRAMA: Programmes on national or regional culture
CULTURE: Programmes on natural sciences and technology

SCIENCE: Other programmes like comedies or ceremonies
VARIETY: Pop music

OTHER M: Rock music
ROCK M: Middle-of-the-road music (usually called "easy listening")

POP M: Light music
SOLEISURE: Classical music

CLASSICS: Other music
OTHER M: Weather information

WEATHER: Reports on commerce, trading, the Stock Market, etc.
FINANCE: Entertainment programmes for children

CHILDREN: Programmes on social activities
SOCIAL A: Programmes dealing with any aspect of belief or faith, or the nature of existence or ethics

RELIGION: Programmes where people can express their views either by phone or in a public forum

PHONE IN: Programmes about travel destinations, package tours, and travel ideas and opportunities

TRAVEL: Programmes concerned with recreational activities such as gardening, cooking, fishing, etc.

LEISURE: Country music
JAZZ: Jazz music

OTHER M: Current popular music from another nation region, in that country's language
COUNTRY: Classic pop music

NATIONAL: Folk music
OLDIES: Folk music

FOLK M: Folk music
OTHER M: Programmes dealing with factual matters, presented in an investigative style

DOCUMENT: Test broadcasts
TEST: Emergency broadcasts

ALARM: To temporarily switch to a broadcast programme of your choice

To temporarily switch to a broadcast programme of your choice

EON (Enhanced Other Networks) is another convenient RDS service that allows this unit to switch temporarily to a broadcast programme of your choice (NEWS, TA or INFO) from the currently selected station, except if you are listening to a non-RDS station (all AM (MW/LW) stations or some FM stations).

- If an FM station does broadcast EON information, EON cannot be activated.

[Example]

A	A	A	A	K	U	U	0	0	0	0	0	0	0	0	0	0	0	0	0	0	0	0
B	B	B	B	L	L	L	L	V	V	V	V	V	V	V	V	V	V	V	V	V	V	V
C	C	C	C	M	M	M	M	W	W	W	W	W	W	W	W	W	W	W	W	W	W	W
D	D	D	D	N	N	N	N	X	X	X	X	X	X	X	X	X	X	X	X	X	X	X
E	E	E	E	O	O	O	O	Y	Y	Y	Y	Y	Y	Y	Y	Y	Y	Y	Y	Y	Y	Y
F	F	F	F	P	P	P	P	Z	Z	Z	Z	Z	Z	Z	Z	Z	Z	Z	Z	Z	Z	Z
G	G	G	G	Q	Q	Q	Q	R	R	R	R	R	R	R	R	R	R	R	R	R	R	R
H	H	H	H	R	R	R	R	S	S	S	S	S	S	S	S	S	S	S	S	S	S	S
I	I	I	I	S	S	S	S	T	T	T	T	T	T	T	T	T	T	T	T	T	T	T
J	J	J	J	T	T	T	T	9	9	9	9	9	9	9	9	9	9	9	9	9	9	9

To select a programme type



Press the EON button twice while listening to an FM station.
"EON SELECT" appears on the display.

Select the programme type with the UP or DOWN button on the Remote Control within 10 seconds.

The display shows a programme type in the following order:



- TA: Traffic Announcement
- NEWS: News
- INFO: Programmes on medical service, weather forecast, etc.
- OFF: EON off

Press the EON button within 10 seconds again to set the selected programme type.

The selected programme type indicator lights up on the display, and the unit enters EON Standby mode.

- The EON indicator lights up when tuned to a station which provides EON information.

Case 1: If there is no station broadcasting the type of programme you have selected

The broadcast station being currently heard will continue to be heard.

When a station starts broadcasting the programme you have selected, this unit automatically switches to the station. The programme type (TA, NEWS or INFO) indicator starts blinking.

Case 2: If there is a station broadcasting the type of programme you have selected

This unit tunes to the station broadcasting the programme. The programme type (TA, NEWS or INFO) indicator starts blinking.

When the programme is over, this unit goes back to the currently selected station, but still remains in EON Standby mode.

Notes:

- If the EON is in standby mode and the function (CD, TAPE, MD/AUX) switch is changed or the power is switched off, then the EON mode will be released. When the band is set to AM (MW/LW), the EON is not activated. When the band is set to FM again, the EON will be set to standby mode.
- When the EON is being operated (i.e. the selected programme type is being received from the broadcast station) and if the DISPLAY MODE or UP/DOWN button is operated, the station will not switch back to the current selected station even after the programme ends. The programme type indicator remains in the display, indicating that the EON is in standby mode.
- When the EON is in standby mode and a radio broadcast is being recorded, be careful because the EON may be activated and a different programme than the intended one may be recorded.
- When the EON mode is not required, release the EON mode.
- When the alarm signal is detected by EON, the station broadcasting the alarm is received with priority. "ALARM" is not displayed.

English

Using the CD Player

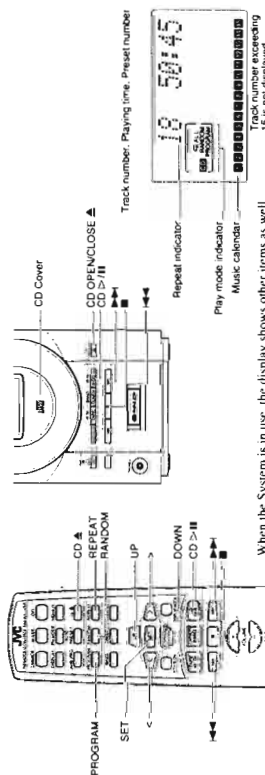

When the System is in use, the display shows other items as well. For simplicity, we show here only the items described in this section.

You can use Normal, Random, Program or Repeat Play. Repeat Play can repeat all the tracks or just one of the tracks on the CD. Here are the basic things you need to know to play a CD and locate the different tracks on it.

The Quickest Way To Start a CD is With the One Touch Operation

- Press the CD >|| button on the Unit or the Remote Control.
- The power is automatically turned on. If a CD is already inserted, it will start playing from the first track.
- If no CD is inserted, "NO DISC" appears on the display, and the CD Player remains in Stop mode.

To Insert a CD

Place the CD OPEN/CLOSE button on the Remote Unit (or the CD button on the Remote Control.)

The CD cover opens.

Place a CD, with its label side out as shown below. Press down on the CD's center until you hear a click.

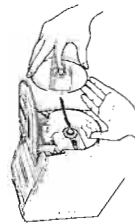

Press the CD OPEN/CLOSE button (or CD button) again to close the CD cover.

- To close the CD cover and play the CD, you can just press the CD >|| button.
- You can place an 8 cm (3") CD without an adaptor.
- If the CD cannot be read correctly (because it is scratched, for example), "0 0:00" appears on the display.
- You can insert a CD while listening to the other source.

CAUTIONS:

- DO NOT try to open or close the CD cover by hands as it will be damaged.

English

Caution: When the sound alternated intermittently between the station tuned in by the EON function and the current selected station, cancel the EON mode. This does not constitute malfunction of the unit.

- When you place or take out a CD, do not let it fall. Also, be careful not to scratch your fingers with a CD cover.

To Unload a CD

Take out the CD as shown below.



- To unload an 8 cm (3") CD, use the concavity to make removal easier.



Basics of Using the CD Player-Normal Play

To Play a CD

Insert a CD.

Press the CD >|| button.

The first track of the CD begins playing.



Track number

Playback time

- The track number that has already played disappears from the music calendar.
- The CD Player automatically stops when the last track of the CD has finished playing.

Using the Cassette Deck (Listening to a Tape)

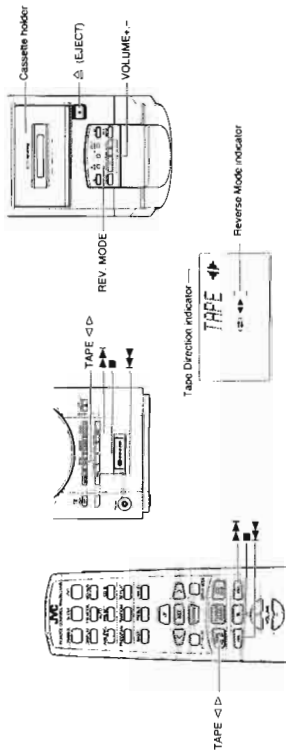

When the System is in use, the display shows other items as well. For simplicity, we show here only the items described in this section.

If you need to change the playback direction, press the TAPE <D> again.

The opposite side Tape Direction indicator lights up and the tape playback direction changes.

To stop playing, press the **■** button.

To remove the tape, stop the tape, and press the **(EJECT)** button.

To Fast-Wind A Tape

Press the **▶▶** or **◀◀** button on the Unit or the Remote Control to fast-wind the tape **▶▶** or **◀◀** indicator of the tape fast-wind direction appears on the display.

The Cassette Deck automatically stops when the tape reaches its end.

Reverse Mode

You can set a tape to play just one side, both sides in succession, or both sides continuously.

Press the REV. MODE button on the Unit.

The indicator changes with each press of the button as shown.

▶▶ : The Cassette Deck automatically stops after playing one side of the tape.

◀▶ : The Cassette Deck automatically stops after playing both sides of the tape. (Stops when playback in the ◀ direction is finished.)

◀◀ : The Cassette Deck continues to play both sides of the tape until the **■** button is pressed.

The Cassette Deck allows you to play and record audio tapes.

With Automatic Tape Detection, you can listen to type I, II or IV tapes without having to change any settings.

The use of tapes longer than 120 minutes is not recommended, since characteristic deterioration may occur and these tapes easily jam in the pinch-rollers and the capstans.

One Touch Play

By pressing the TAPE <D> button on the Unit or the Remote Control, the Unit will come on. "TAPE" appears in the display, and if a tape is in the deck, it will start to play. If no tape is loaded, "NO TAPE" appears on the display, the Unit will come on and wait for you to insert a tape, or select another function.

Regular Play

When the power is already on, you can use this basic procedure:

Press the (EJECT) button.

When the cassette holder opens, put the cassette in, with the side you want to listen facing up.

If the cassette holder does not open, turn the Unit off, then back on and press the (EJECT) button again.



Close the holder gently until it clicks.

Press the TAPE <D> button.
The tape is played in the direction shown by the Tape Direction indicator.

You can see the total playback time of programmed tracks on the display. Also, you can see the programmed tracks on the music calendar.

Press the CD >II button.

The System plays the tracks in the order you have programmed them.

You can skip to a particular program track by pressing the ◀▶ or ▶▶ button during Program Play.

To confirm the programmed tracks while the CD player is stopped, each time press the ◀▶ or ▶▶ button; the tracks making up the program will successively be displayed in the programmed order.

To delete all the tracks in the program, in stop mode, press the **■** button. Pressing the CD >II button to open the CD cover will also clear the programmed tracks.

To exit the program mode once, while the CD Player is stopped, press the PROGRAM button to light off the "CD PROGRAM" indicator.

Notes:

- If the total playback time of the programmed tracks exceeds 99 minutes 59 seconds, the total playback time will go out on the display.
- If you try to program the 21th track, "MEMORY FULL" appears on the display for about 2 seconds.

To Modify the Program

Modify the contents of the program while the CD Player is stopped. Each time you press the CANCEL button, the last track in the program is deleted. To add new tracks to the end of the program, repeat above steps 5 to 7.

Random Play

The tracks will play in no special order when you use this mode.

Press the RANDOM button on the Remote Control.

The "CD RANDOM" indicator lights up on the display.

Press the CD >II button.

The tracks are played in random order.

To skip a track during playback, press the ▶▶ button to jump to the next track in the random sequence. Press the ◀▶ button to jump back to the start of a track being played.

To exit Random Play mode, while the CD Player is stopped, press the RANDOM button to light off the "CD RANDOM" indicator and carry out Normal Play, or press the CD >II button to open the CD cover.

Repeating Tracks

You can set the program or individual track playing to repeat as many times as you like.

Press the REPEAT button on the Remote Control.

The Repeat indicator changes with each press of the button, as shown below.

◀▶ ALL → blank display → back to the beginning

◀▶ : Repeats one track.

◀▶ ALL : In Normal Play mode, repeats all the tracks. In Program Play mode, repeats all the tracks in the program.

In Random Play mode, repeats all the tracks in random order.

To exit Repeat mode, press the REPEAT button until the Repeat indicator on the display goes out.

In Random Play, as a matter of course, ◀ cannot be selected. Repeat mode remains in effect even when you change the play mode.

To stop playing the CD, press the **■** button. The following information for the CD is displayed.

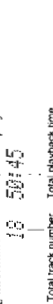

To stop playing and remove the CD, press the CD OPEN/CLOSE > button on the Unit or CD > button on the Remote Control to open the CD cover.

To cancel pause, press the same button again. Play continues from the point where it was paused.

To Select a Track or Passage within a Track

During playback, press the ◀◀ or ▶▶ (< or >) button to select the track you want.

The selected track starts playing.

- Press the ▶▶ or > button once to skip to the beginning of the next track.
- Press the ◀◀ or < button to skip to the beginning of the track being played. Press twice quickly to skip to the beginning of the previous track.
- When the > or < button on the Remote Control is kept pressed, the track continuously skips.

Search Play

Holding down the ◀◀ or ▶▶ button, during playback, will fast forward/backwards the CD so you can quickly find a particular passage in the track you are listening to.

Programming the Playing Order of the Tracks

You can program the playing order of the tracks using the Remote Control.

You can program up to 20 tracks in any desired order including the same tracks.

You can only make a program when the CD Player is stopped.

Insert a CD.

Press the CD >II button.

Press the **■ button to stop the CD.**

Press the PROGRAM button.

The System enters the programming mode and the "CD PROGRAM" indicator lights up.

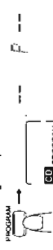

Press the UP, DOWN, >, or < button to select the track to program.

UP or > button: Increases the track number by 1.

DOWN or < button: Decreases the track number by 1.

When the > or < button is kept pressed, the track number changes rapidly.

Press the SET button.

Program order number

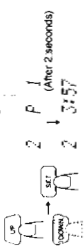

Total playback time of the programmed tracks

Repeat steps 5 and 6 to select the other tracks for the program.

Using the Cassette Deck (Recording)

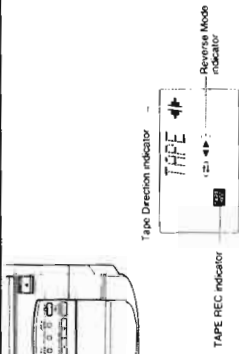
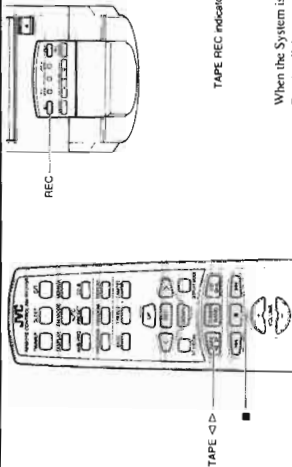

When the System is in use, the display shows other items as well. For simplicity, we show here only the items described in this section.

Recording onto a tape from any of the sound sources is simple. Just place a tape in the Cassette Deck, have the source ready, make one or two settings, and you're ready to record. For each source the procedure is a little bit different so we explain each separately. But first, here are a few things to make your recordings better.

Things To Know Before You Start Recording

- It may be unlawful to record or play back copyrighted material without the consent of the copyright owner.
- When you want to record onto both sides of a tape, you can set Reverse mode to do so. Recording automatically stops after recording in the ◀ direction. Therefore, make sure that the tape direction is ▶ when recording with Reverse mode on.
- The recording level, which is the volume at which the new tape is being made, is automatically set correctly, so it is not affected by the VOLUME control on the System. Nor is it affected by adjusting the sound effects. Thus, during recording you can adjust the sound you are actually listening to without affecting the recording level.
- Two small tabs on the back of the cassette tape, one for side A and one for side B, can be removed to prevent accidental erasure or recording.

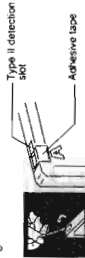

- To record on a cassette with the tabs removed, you must cover the holes with adhesive tape first. However, when a Type II tape is used, only cover part of the hole as shown, since the other part of the hole (Type II detection slot) is used to detect the tape type.
- Type I and Type II tapes can be used for recording.

Note: At the start and end of cassette tapes, there is leader tape which cannot be recorded onto. Thus, when recording CDs or radio broadcasts, wind on the leader tape first to ensure getting the beginning of the recording.

English
English

Notes for using Reverse mode for recording
When recording in Reverse mode, the System automatically stops when it reaches the end of the reverse ◀ direction. To record on both sides of a tape, make sure that the recording direction for the tape inserted is forwards ▶, and that the Tape Direction indicator is also forwards ▶, before you start recording.

To Stop at Any Time During the Recording Process
Press the ■ button.

CD Direct Recording

Everything on the CD goes onto the tape in the order it is on the CD, or according to the order you have set in a program.

■ **Insert a cassette into the Cassette Deck and wind past the tape leader.**

■ **Press the CD ▷/II button on the Unit or on the Remote Control.**

■ **Press the ■ button.**

- If you want to record specific tracks only, program the tracks beforehand. You can check their total play-back time on the display during programming. (See page 13.)

■ **If you want to record on both sides of a tape, press the REV, MODE button on the Unit until the "◀ ▶" indicator is lit. Make sure that the recording direction for the tape and the Tape Direction indicator is correct. (See "Notes for using Reverse mode for recording".)**

■ **Choose whether to have pauses between recorded selections.**

- If nothing is done, a non-recorded pause of about four seconds will be automatically left between selections.
 - If you do not want pauses between selections, do the following before proceeding to the next step.
- **Press the CD ▷/II button on the Unit or the Remote Control twice.**
The CD player enters Pause mode.

■ **Press the REC button on the Unit.**

The "TAPE REC" indicator lights up and the System begins recording.

- If you make a recording with Reverse mode on, the Unit will record the last song at the end of the first side onto the next side from its beginning when the song has been recorded more than 12 seconds on the first side. If the last song has been recorded less than 12 seconds, then the previous song will again be recorded on the next side as it will not be completely recorded on the first side because of leader tape.
- After the CD player has played the entire CD, or all the programmed tracks, the tape automatically stops.

■ **To stop at any time during the recording process, press the ■ button.** The tape stops after four seconds.

Note: When making SLEEP timer settings while using CD Direct recording, set enough time to allow for the CD to finish playing, otherwise the power will go off before recording is completed.

Standard Recording

You can record any sound source to tape as follows:

■ **Insert a blank or erasable tape into the Cassette Deck and wind past the tape leader.**

■ **Press the REV, MODE button on the Unit if you want to record on both sides of the tape.**

- Press the button until the ◀ ▶ indicator is lit.
- When using Reverse mode, insert the tape so that it will be recorded in the forwards ▶ direction.

■ **Check the recording direction for the tape.**

Make sure that the Tape Direction indicator is the same as that for the tape in the Cassette Deck. If the directions are different, press the TAPE ◀ ▶ button to correct the tape direction and then press the ■ button to stop the tape.

■ **Prepare the source, by, for example, tuning in a radio station or turning on connected auxiliary equipment.**

Note: For CD recording, refer to "CD Direct Recording" mentioned below.

■ **Press the REC button on the Unit.**

The "TAPE REC" indicator lights up and the System begins recording.

- If the tab of the cassette tape is removed to prevent erasure or recording, "NO REC" will appear on the display.

Using External Equipments

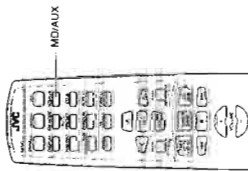

Listening to External Equipment

You can listen to external equipment such as MD recorder, turntable or other auxiliary.

- First make sure that the external equipment is properly connected to the System. (See page 4).

Set the **VOLUME** control to the minimum position.

Press the **MD/AUX** button.

"AUX" appears on the display.



Start playing the external equipment.

Adjust the **VOLUME** control to the desired listening level.

Apply sound effects, if you wish.

- Press the **AHB PRO** button to reinforce the bass sound.
- Press the **BASS/TREBLE** button on the Remote Control to control the tone. (See "Tone Control" on page 7).

To exit **MD/AUX** mode, you will automatically switch out of MD/AUX mode when you select another source.

Note: For operation of the external equipment, refer to its instructions.

Recording the System's source to External Equipment

You can record the System's source to external equipment which is connected to the **LINE OUT** or **OPTICAL DIGITAL OUT** terminals of the System, such as cassette deck or MD recorder, etc.

- First make sure that the external equipment is properly connected to the System. (See page 4).

Play the System's **CD Player, Cassette Deck, or tune into a station.**

- The recording level is not affected by the **VOLUME** level set by the System. Also it is not affected by the sound effects.

Note: For operation of the external equipment, refer to its instructions.

Using the Timers

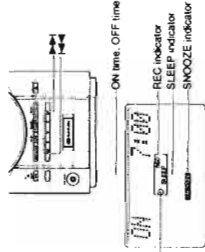
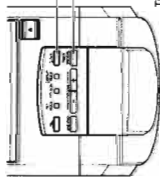
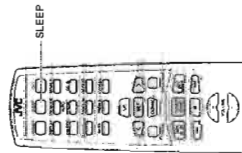

When the System is in use, the display shows other items as well. For simplicity, we show here only the items described in this section.

The timers let you control listening and recording functions automatically.

Setting the Clock

- When you plug the AC power cord into the wall outlet, the time indication blinks on the display.

You can set the clock whether the System is on or off.

In addition to the digital clock, the analog clock also shows the time.

Notes:

- The clock must be correctly set for the timers to work.
- The procedure must be completed within two minutes. Otherwise, the setting is cleared and must be repeated from the beginning.



(for 2 seconds)

Press the **CLOCK** button on the Unit for more than two seconds.

The time indication rapidly blinks on the display.

Press the **→** or **←** button on the Unit to set the time.

Pressing the **→** button moves the time forwards and pressing the **←** button moves it backwards. Hold down the button to move the time rapidly.

Press the **CLOCK** button.

The selected time is set and the seconds start counting from 0.

CAUTION: If there is a power failure, the clock loses its setting after about 20 minutes. "0:00" blinks on the display and the clock must be reset.

Note: The clock may gain or lose one to two minutes per month.

Setting the Daily Timer

Once you have set the Daily Timer, the timer will be activated at the same time every day. It can be cancelled and re-activate whenever you wish.

The Timer indicator on the display shows when the Daily Timer you have set is in effect.

Note: Perform each setting within 30 seconds. Otherwise, setting is cleared and the procedure must be repeated from the beginning.

Press the **⏻** button to turn on the System.

Setting the **ON time (Example: 12:15).**

- Press the **TIMER/SNOOZE** button on the Unit. The Timer indicator lights up and the current ON time blinks on the display.

- When the clock is not set, the "CLOCK" indicator and the "ADJUST" indicator appear alternately on the display. Set the clock at first.



- Press the **→** or **←** button on the Unit to set the time you want the Unit to come on.

Pressing the **→** button moves the time forwards and pressing the **←** button moves it backwards. Hold down the button to move the time rapidly.

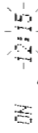

Setting the **OFF time (Example: 13:15).**

- Press the **TIMER/SNOOZE** button on the Unit. The current OFF time blinks on the display.



- Press the **→** or **←** button on the Unit to set the time you want the Unit to be turned off.

Pressing the **→** button moves the time forwards and pressing the **←** button moves it backwards. Hold down the button to move the time rapidly.

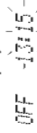

Selecting the music source.

- Press the **TIMER/SNOOZE** button on the Unit. The "TUNER" blinks on the display.
- Press the **→** or **←** button to select the music source you want to listen to.

The display changes as shown below. **TUNER → TUNER REC → CD → TAPE →** (back to the beginning)

- When you select the "TUNER REC", the "REC" indicator appears on the display.

Setting the SLEEP Timer

Use the Sleep Timer to turn the System off after a certain number of minutes when it is playing. By setting the Sleep Timer, you can fall asleep to music and know that your System will turn off by itself rather than play all night.

- You can only set the Sleep Timer when the System is on and a source is playing.

■ **Play a CD, a cassette tape, or tune in to the desired station.**

■ **Press the SLEEP button on the Remote Control.**

The "SLEEP" indicator lights up. When the clock is not set, the "CLOCK" indicator and the "ADJUST" indicator appear alternately on the display. Set the clock at first.

■ **Set the length of time you want the source to play before shutting off.**

Each time you press the SLEEP button, it changes the number of minutes shown on the display in this sequence: 10 → 20 → 30 → 60 → 90 → 120 → Cancelled → (back to the beginning). After setting the number of minutes for the Sleep Timer, the display will stop blinking and return to the display as before setting the Sleep Timer. (The display is dimmed.) The System is now set to turn off after the number of minutes you set.

To Confirm the Sleep Time
When the SLEEP button is pressed, the remaining sleep time is displayed. Wait until the display returns to the original display.

To Cancel the SLEEP Timer Setting
Press the SLEEP button until the "SLEEP" indicator goes out on the display.

Turning off the System also cancels the SLEEP Timer. If you are setting the Daily Timer, the System will be turned on at the set time to wake you up.

Setting the volume level.

- Press the TIMER/SNOOZE button on the Unit.
- The current volume setting blinks on the display.
- Press the \blacktriangle or \blacktriangleright button to select the volume level.
- The current volume level will be used.
- When the timer is turned on, the Volume will be automatically set to the selected level.



■ **Press the TIMER/SNOOZE button on the Unit.**

The timer setting is completed and the display returns to the display before you set the timer. The timer indicator remains lit.

■ **Before turning off the System, prepare the music source selected in step 4.**

TUNER: Tune in to the desired station.
TUNER REC: Tune in to the desired station and insert a cassette tape for recording the station.
CD: Insert a CD.
TAPE: Insert a tape.

■ **Press the \square button to turn off the System.**
To cancel the timer, press the TIMER/SNOOZE button. The timer indicator goes out on the display.

To re-activate the cancelled timer, press the TIMER/SNOOZE button to light the Timer indicator. Then, press the TIMER/SNOOZE button until the display returns to the original display. The Timer indicator should remain lit.

To confirm the timer settings, cancel the timer once by pressing the TIMER/SNOOZE button. Then, press the TIMER/SNOOZE button repeatedly, to see the current timer settings (ON time, OFF time, source, and volume).

To change the timer setting, repeat the setting procedure from the beginning.

When the timer turns on, the Timer indicator starts blinking.

CAUTION: If the System is unplugged, or a power failure occurs, the timer setting will be lost. You will need to reset the clock first, then the timer.

5-Minute Snoozing

When the timer turns on the music source you can, if you wish, activate the 5-minute snoozing function to temporarily stop playback.

Press the TIMER/SNOOZE button on the Unit.
The "SNOOZE" indicator lights up on the display and the power is turned off for five minutes for snoozing.

Care And Maintenance

Handle your CDs carefully, and they will last a long time.

Only CDs bearing this mark can be used with this System. However, continued use of irregular shape CDs (heart-shaped, octagonal, etc.) can damage the System.

Remove the CD from its case by holding it at the edges while pressing the case's center hole lightly. Do not touch the shiny surface of the CD, or bend the CD.

Put the CD back in its case after use to prevent warping. Be careful not to scratch the surface of the CD when placing it back in the case. Avoid exposure to direct sunlight, temperature extremes, and moisture.

A dirty CD may not play correctly. If a CD does become dirty, wipe it with a soft cloth in a straight line from center to edge.

CAUTION: Do not use any solvent (for example, conventional record cleaner, spray thinner, benziner, etc.) to clean a CD.

In general, you will have the best performance by keeping your CDs and the mechanism clean.

Store CDs in their cases, and keep them in cabinets or on shelves.

Keep the system's CD cover closed when not in use.

Cleaning the lens

If the lens in the CD pickup is dirty, dropout, etc., could degrade sound.

Open the CD cover and clean the lens as shown.

Use a blower (available from a camera store) to blow dust off the lens.

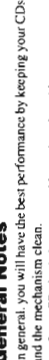

If there are fingerprints, etc. on the lens, gently wipe clean with a cotton swab.



Moisture may condense on the lens inside the System in the following cases:

- After turning on heating in the room.
- In a damp room.
- If the System is brought directly from a cold to a warm place.

Should this occur, the System may malfunction. In this case, leave the System turned on for a few hours until the moisture evaporates, unplug the AC power cord, and then plug it in again.

Moisture Condensation

Cassette Tapes

If the tape is loose, it may get stretched, cut, or caught in the cassette. Take up the slack by inserting a pencil in one of the reels and rotating.

Do not touch the tape surface.

Do not store the tape:

- In dusty places
- In direct sunlight or heat
- In moist areas
- On a TV or speaker
- Near a magnet

Cassette Deck

If the heads, capstans, or pinch-rollers of the Cassette Deck become dirty, the following may occur:

- Loss of sound quality
- Fading
- Incomplete erasure
- Difficulty recording

Clean the heads, capstans, and pinch-rollers using a cotton swab moistened with alcohol.



If the heads become magnetized, the Unit will produce noise or lose high frequency notes.

To demagnetize the heads, turn off the Unit, and use a head demagnetizer (available at electronics and record shops).

Troubleshooting

- If you are having a problem with your System, check this list for a possible solution before calling for service.
- If you cannot solve the problem from the hints given here, or the System has been physically damaged, call a qualified person, such as your dealer, for service.

Symptom	Possible Cause	Action
No sound is heard.	<ul style="list-style-type: none"> • Connections are incorrect, or loose. • Headphones are connected. 	<ul style="list-style-type: none"> • Check all connections and make corrections. (See pages 4-5.) • Disconnect the headphones.
Unable to record.	Cassette record protect tabs are removed.	Cover the holes on the back edge of the cassette with tape.
Poor radio reception	<ul style="list-style-type: none"> • The antenna is disconnected. • The AM Loop Antenna is too close to the System. • The FM Wire Antenna is not properly extended and positioned. 	<ul style="list-style-type: none"> • Reconnect the antenna securely. • Change the position and direction of the AM Loop Antenna. • Extend FM Wire Antenna to the best reception position.
The CD skips.	The CD is dirty or scratched.	Clean or replace the CD.
The CD does not play.	The CD is upside down.	Put the CD in with the label side up.
Unable to operate the Remote Control.	<ul style="list-style-type: none"> • The path between the Remote Control and the sensor on the Unit is blocked. • The batteries have lost their charge. 	<ul style="list-style-type: none"> • Remove the obstruction. • Replace the batteries.
Operations are disabled.	The built-in microprocessor has malfunctioned due to external electrical interference.	Unplug the System then plug it back in.
The cassette holder cannot be opened.	During tape playing, the power cord was unplugged.	Plug in the power cord, press the CD button, and then press the ▶ button.

English

English

Specifications

- Amplifier**
Output Power 34 W (17 W + 17 W) at 4 ohms (Max.)
32 W (12 W + 12 W) at 4 ohms (10% THD)

Input Sensitivity/Impedance (1 kHz)
LINE IN (ALUX) 500 mV/65 kohms
Output Sensitivity/Impedance (1 kHz)
LINE OUT 500 mV/4.3 kohms
Optical out -21 dBm, -15 dBm
Speaker terminals 4 - 16 ohms
Phones 16 ohms - 1 kohms
0 - 15 mW/ch output into 32 ohms

Cassette Deck

Frequency Response
Type II (C/O) 50 Hz - 15 kHz
Wow and Flutter 0.15 % (WRMS)

CD Player

Signal-To-Noise Ratio 90 dB
Wow And Flutter Unmeasurable

Tuner

FM Tuner
Tuning Range 87.5 - 108.0 MHz
AM Tuner
Tuning Range (MW) 522 - 1,629 kHz
(LW) 144 - 288 kHz

Speaker Specifications

Speakers 8 cm cone
Impedance 4 ohms
Dimensions 140 × 230 × 217 mm (W/H/D)
Mass Approx. 1.8 kg

General

Dimensions 438 × 233 × 310.5 mm (W/H/D)
Mass Approx. 7.2 kg

Accessories

Power Cord (1)
AM Loop Antenna (1)
Remote Control (1)
Batteries R6P (SUM-3)/AA (15F) (2)
FM Wire Antenna (1)

Power Specifications

Power Requirements AC 230 V ~, 50 Hz
Power Consumption 38 watts (power on mode)
3.5 watts (in Standby mode)

Design and specifications are subject to change without notice.

**Warnings, Cautions and Others /
Mises en garde, précautions et indications diverses**

(For U.S.A)

CAUTION
RISK OF ELECTRIC SHOCK



CAUTION TO REDUCE THE RISK OF ELECTRIC SHOCK
DO NOT REMOVE COVER OR PANELS.
NO USER SERVICEABLE PARTS INSIDE.
REFER SERVICING TO QUALIFIED SERVICE PERSONNEL.

The lightning flash with arrowhead symbol, within an equilateral triangle is intended to alert the user to the presence of unshielded dangerous voltage within the products. Caution must be taken to avoid contact with the exposed parts, which may be of sufficient magnitude to constitute a risk of electric shock to persons.



The exclamation point within an equilateral triangle is intended to alert the user to the presence of important operating and maintenance (servicing) instructions in the literature accompanying the appliance.

WARNING: TO REDUCE THE RISK OF FIRE OR ELECTRIC SHOCK, DO NOT EXPOSE THIS APPLIANCE TO RAIN OR MOISTURE.

INFORMATION

This equipment has been tested and found to comply with the limits for a Class B digital device, pursuant to Part 15 of the FCC Rules. These limits are designed to provide reasonable protection against harmful interference in a residential installation. This equipment generates, uses, and can radiate radio frequency energy and, if not installed and used in accordance with the instructions, may cause harmful interference to radio communications. However, there is no guarantee that interference will not occur in a particular installation. If this equipment does cause harmful interference to radio or television reception, which can be determined by turning the equipment off and on, the user is encouraged to try to correct the interference by one or more of the following measures.

- Reorient or relocate the receiving antenna.
- Increase the separation between the equipment and receiver.
- Connect the equipment into an outlet on a circuit different from that to which the receiver is connected.
- Consult the dealer or an experienced radio/TV technician for help.

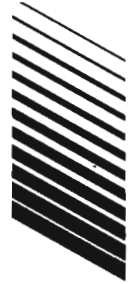

JVC

**COMPACT COMPONENT SYSTEM
SISTEMAS DE COMPONENTES COMPACTOS
SYSTEME DE COMPOSANTS COMPACT**

FS-V5

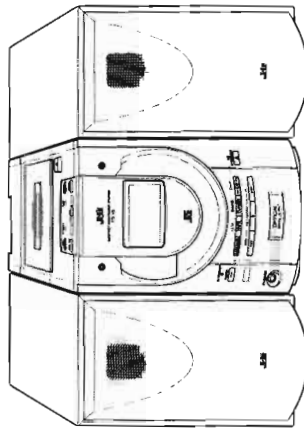

**COMPACT
disc
DIGITAL AUDIO**

**INSTRUCTIONS
MANUAL DE INSTRUCCIONES
MANUEL D'INSTRUCTIONS**

For Customer Use:
Enter below the Model No. and Serial No. which are located either on the rear, bottom or side of the cabinet. Retain this information for future reference.

Model No. _____
Serial No. _____

LVT0214-001A [J]

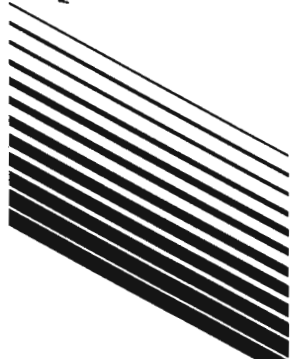

Thank you for purchasing the JVC Compact Component System. We hope it will be a valued addition to your home, giving you years of enjoyment. Be sure to read this instruction manual carefully before operating your new stereo system. In it you will find all the information you need to set up and use the system. If you have a query that is not answered by the manual, please contact your dealer.

Features

Here are some of the things that make your System both powerful and simple to use.

- The controls and operations have been redesigned to make them very easy to use, freeing you to just enjoy the music.
- With JVC's **COMPU PLAY** you can turn on the System and automatically start the Radio, Cassette deck or CD Player with a single touch.
- The System incorporates Active Hyper Bass PRO circuitry to faithfully reproduce low-frequency sounds.
- A 45-station preset capability (30 FM and 15 AM) in addition to auto-tune and manual tuning.
- Versatile CD options include repeat, random and program play.
- Tuner functions: Daily Tuner and Sleep Timer.
- Auto-reverse tape function.
- You can connect various external units, such as an MD recorder.



COMPU PLAY

How This Manual Is Organized

- Basic information that is the same for many different functions - e.g. setting the volume - is given in the section 'Common Operations', and not repeated under each function.
- The names of buttons/controls and display messages are written in all capital letters: e.g. TUNER BAND, "NO DISC".
- System functions are written with an initial capital letter only: e.g. Normal Play.

Use the table of contents to look up specific information you require. We've enjoyed making this manual for you, and hope it serves you in enjoying the many features built into your System.

IMPORTANT CAUTIONS

Installation of the System

- Select a place which is level, dry and neither too hot nor too cold. (Between 5°C and 35°C or 41°F and 95°F.)
- Leave sufficient distance between the System and a TV.
- Do not use the System in a place subject to vibrations.

Power cord

- Do not handle the power cord with wet hands!
- Some power is always consumed as long as the power cord is connected to the wall outlet.
- When unplugging the System from the wall outlet, always pull the plug, not the power cord.

Malfunctions, etc.

- There are no user serviceable parts inside. In case of system failure, unplug the power cord and consult your dealer.
- Do not insert any metallic object into the System.

Table of Contents

Features	1	Using the Timers	16
How This Manual Is Organized	1	Care And Maintenance	18
IMPORTANT CAUTIONS	1	Troubleshooting	19
Getting Started	2	Specifications	20
Common Operations	6		
Using the Tuner	8		
Using the CD Player	10		
Using the Cassette Deck (Listening to a Tape) ...	12		
Using the Cassette Deck (Recording)	13		
Using External Equipments	15		

For Canada/pour le Canada

CAUTION: TO PREVENT ELECTRIC SHOCK, MATCH WIDE BLADE OF PLUG TO WIDE SLOT, FULLY INSERT.
PRECAUTION: POUR EVITER LES CHOCs ELECTRIQUES, INTRODUIRE LA LAME LA PLUS LARGE DE LA FICHE DANS LA BORNE CORRESPONDANTE DE LA PRISE ET POUSSER JUSQU'AU FOND.

For Canada/pour le Canada

THIS DIGITAL APPARATUS DOES NOT EXCEED THE CLASS B LIMITS FOR RADIO NOISE EMISSIONS FROM DIGITAL APPARATUS AS SET OUT IN THE INTERFERENCE-CAUSING EQUIPMENT STANDARD ENTITLED "DIGITAL APPARATUS," ICES-003 OF THE DEPARTMENT OF COMMUNICATIONS.
CET APPAREIL NUMERIQUE RESPECTE LES LIMITES DE BRUITS RADIOELECTRIQUES APPLICABLES AUX APPAREILS NUMERIQUES DE CLASSE B PRESCRITES DANS LA NORME SUR LE MATERIEL BROUILLEUR: "APPAREILS NUMERIQUES," NMB-003 EDICTEE PAR LE MINISTRE DES COMMUNICATIONS.

1. CLASS 1 LASER PRODUCT

DANGER: Invisible laser radiation when open and interlock failed or deleted. Avoid direct exposure to beam.

CAUTION: Do not open the top cover. There are no user serviceable parts inside the unit; leave all servicing to qualified service personnel.

1. PRODUIT LASER CLASSE 1

ATTENTION: Radiation laser invisible quand l'appareil est ouvert ou que le verrouillage est en panne ou désactivé. Eviter une exposition directe au rayon.

ATTENTION: Ne pas ouvrir le couvercle du dessus. Il n'y a aucune pièce utilisable à l'intérieur. Laisser à un personnel qualifié le soin de réparer votre appareil.

CAUTION

To reduce the risk of electrical shocks, fire, etc.:

1. Do not remove screws, covers or cabinet.
2. Do not expose this appliance to rain or moisture.

ATTENTION

Afin d'éviter tout risque d'électrocution, d'incendie, etc.:

1. Ne pas enlever les vis ni les panneaux et ne pas ouvrir le coffret de l'appareil.
2. Ne pas exposer l'appareil à la pluie ni à l'humidité.

Caution — POWER switch:

Disconnected the mains plug to shut the power off completely. The POWER switch in any position does not disconnect the mains line. The power can be remote controlled.

Attention — Commutateur POWER!

Déconnecter la fiche de secteur pour couper complètement le courant. Le commutateur POWER ne coupe jamais complètement la ligne de secteur, quelle que soit sa position. Le courant peut être télécommandé.

Getting Started

Accessories

Make sure that you have all of the following items, which are supplied with the System.

- Power Cord (1)
- AM Loop Antenna (1)
- Remote Control (1)
- Batteries (2)
- FM Wire Antenna (1)

If any of these items are missing, contact your dealer immediately.

How To Put Batteries In the Remote Control

Match the polarity (+ and -) on the batteries with the + and - markings in the battery compartment.

R6P(SUM-3)/AA(15F)

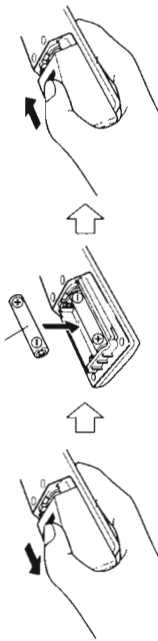

CAUTION: Handle batteries properly.

- To avoid battery leakage or explosion:
 - Remove batteries when the Remote Control will not be used for a long time.
 - When you need to replace the batteries, replace both batteries at the same time with new ones.
 - Don't use an old battery with a new one.
 - Don't use different types of batteries together.

Using the Remote Control

The Remote Control makes it easy to use many of the functions of the System from a distance of up to 7m (23 feet) away. You need to point the Remote Control at the remote sensor on the System's front panel.

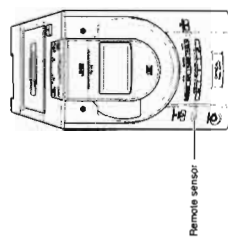

Remote sensor

CAUTION: Make all connections before plugging the System into an AC power outlet.

Connecting the FM Antenna

Using the Supplied Wire Antenna



Using the Coaxial Type Connector (Not Supplied)

A 75-ohm antenna with coaxial type connector should be connected to the FM 75-ohm COAXIAL terminal.



If reception is poor, connect the outdoor antenna.



Note: Before attaching a 75 ohm coaxial lead (the kind with a round wire going to an outdoor antenna), disconnect the supplied FM Wire Antenna.

Connecting the AM Antenna

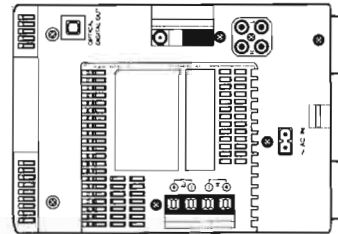

AM loop antenna (Supplied)

Attach the AM loop to its base by snapping the tabs on the loop into the slot in the base.

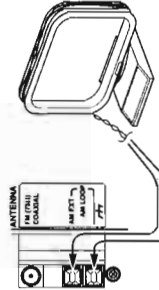

Turn the loop until you have the best reception.

CAUTION: To avoid noise, keep antennas away from the System, the connecting card and the AC power cord.

English
English

English
English

CAUTION: Make all connections before plugging the System into an AC power outlet.

Connecting the Speakers

For each speaker, connect one end of the speaker wire to the speaker terminals on the back of the System.

1. Open each of the terminals and insert the speaker wires. Finally, then, close the terminals.
2. Connect the red (+) and black (-) wires of the right side speaker to the red (+) and black (-) terminals marked R on the System.
Connect the red (+) and black (-) wires of the left side speaker to the red (+) and black (-) terminals marked L on the System.

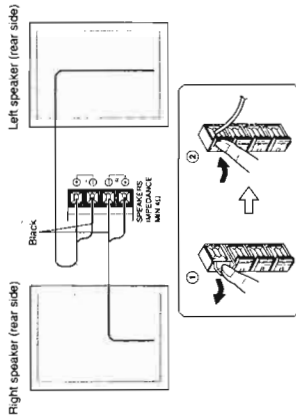

CAUTION: A TV may display irregular colors if located near the speakers. If this happens, set the speakers away from the TV.

Connecting External Equipment

Connect signal cords (not supplied) between the System's LINE IN (AUX)/LINE OUT terminals and the output/input terminals of the MD recorder, tape deck, etc.

You can then listen to the external source through the System, or record the System's CD player, cassette tape, or tuner to the external unit.

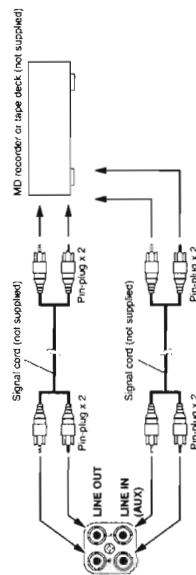

Connecting an MD Recorder, etc (Digital Output)

Unplug the cap and connect an optical digital cord (not supplied) between the System's OPTICAL DIGITAL OUT terminal and the input terminal of the MD recorder, etc.

You can record the digital output signal from the System's CD Player to the MD recorder, etc.

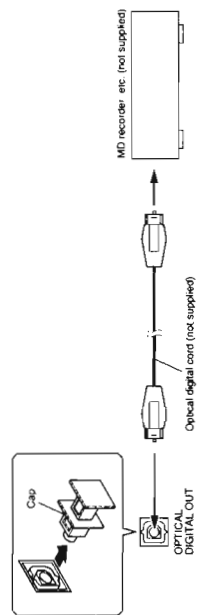

Connecting the AC Power Cord

Firmly insert the supplied AC power cord into the AC inlet on the back of the Unit.

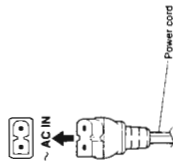

CAUTIONS:

- **ONLY USE THE JVC POWER CORD PROVIDED WITH THIS SYSTEM TO AVOID MALFUNCTION OR DAMAGE TO THE SYSTEM.**
 - **BE SURE TO UNPLUG THE POWER CORD FROM THE OUTLET WHEN GOING OUT OR WHEN THE SYSTEM IS NOT IN USE FOR AN EXTENDED PERIOD OF TIME.**
- Now you can plug the AC power cord into the wall outlet, and your System is at your command!**

COMPU PLAY

JVC's COMPU PLAY feature lets you control the most frequently used System functions with a single touch.

With One Touch Operation you can play a CD, a tape, turn on the radio, or listen to an external equipment with a single press of the play button for that function. One Touch Operation turns the power on for you, then starts the function you have specified. If the System is not ready (no CD in place), the System still powers on so you can insert a CD.

How One Touch Operation works in each case is explained in the section dealing with that function.

The COMPU PLAY buttons are:

On the Unit

- CD >|H button
- TUNER BAND button
- TAPE <|> button
- MD/AUX button

On the Remote Control

- CD >|H button
- TUNER BAND button
- TAPE <|> button
- MD/AUX button

AUTOMATIC POWER ON

The System automatically turns on with the following operation.

- When you press the CD >|H button, the System automatically turns on and the CD cover opens to allow CD insertion. However, this operation does not change the function to CD.
- When you press the POWER button to turn off the System, the CD cover will automatically closed if it is opened.

Common Operations

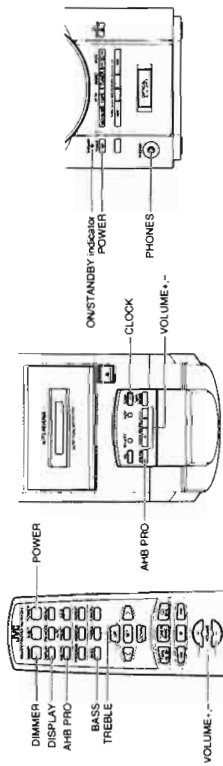

Turning the Power On and Off

Turning the System On

- Press the **POWER** button. The display comes on and "HELLO" is displayed once. The ON/STANDBY indicator lights in green.
- The System comes on ready to continue in the mode it was in when the power was last turned off.
- For example, if the last thing you were doing was listening to a CD, you are now ready to listen to a CD again. If you wish, you can change to another source.
- If you were listening to the Tuner last, the Tuner comes on playing the station it was last set to.

Turning the System Off

- Press the **POWER** button again. "GOOD BYE" is displayed and the display goes out, except for the clock display. The ONSTANDBY indicator lights in red.
- Some power is always consumed even though power is turned off (called Standby Mode).
- To switch off the System completely, unplug the AC power cord from the wall outlet. When you unplug the AC power cord, the clock will be reset to AM 12:00 after about 20 minutes.

Adjusting the Brightness (DIMMER)

- You can adjust the brightness of the backlighting for the display.
- When the System is Turned On** — To make the brightness of the backlighting darker, press the DIMMER button on the Remote Control.
- To make the brightness brighter**, press the DIMMER button on the Remote Control again.
- When the System is Turned Off (STANDBY MODE)** — To turn on the backlighting, press the DIMMER button on the Remote Control. The brightness is the same as for darker one mentioned above.
- To turn off the backlighting**, press the DIMMER button on the Remote Control again.

Adjusting the Volume

Press the **VOLUME +** button to increase the volume or press the **VOLUME -** button to decrease it.



You can adjust the volume level between 0 and 50.

CAUTION: DO NOT turn on the System and/or start playing any source without first setting the VOLUME control to minimum, as a sudden blast of sound could damage your hearing, speakers and/or headphones.

For private listening

Connect a pair of headphones to the PHONES jack. No sound comes out of the speakers. Be sure to turn down the volume before connecting or putting on headphones.

English
English

Reinforcing the Bass Sound (AHB PRO)

You can reinforce the bass sound to maintain rich, full bass at low volume (you can use this effect only for playback).

- To get the effect**, press the AHB (Active Hyper Bass) PRO button.
- The "BASS" indicator lights up on the display.
- To cancel the effect**, press the button again.
- The "BASS" indicator goes out.

Tone Control (BASS/TREBLE)

You can control the tone by changing the bass and treble. The analog clock acts to display the bass and treble settings. By pressing either the BASS or TREBLE button on the Remote Control, you can visually see the current tone control settings.

Examples:

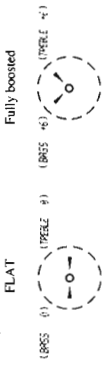

BASS Control

You can adjust the bass level (low frequency range level) between -6 and +6. (0: Flat)

- Press the **BASS** button on the Remote Control.

Press the **UP** or **DOWN** button on the Remote Control to adjust the bass level.

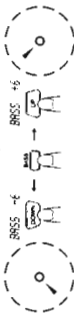

TREBLE Control

You can adjust the treble level (high frequency range level) between -6 and +6. (0: Flat)

- Press the **TREBLE** button on the Remote Control.

Press the **UP** or **DOWN** button on the Remote Control to adjust the treble level.



Showing the Time (DISPLAY)

In Standby mode, the digital clock and analog clock appear on the display at the same time. Meanwhile, only the analog clock is displayed when a music source is selected. Namely, you can see the analog clock at all times.

When the System is turned on, you can display the digital clock at any time.

- To display the digital clock**, press the **CLOCK** button on the Unit or **DISPLAY** button on the Remote Control.
- To return to the previous mode**, press the same button again.

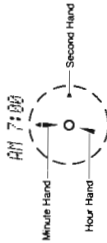

Note: To let the clock work, you need to set the clock beforehand. (See "Setting the Clock" on page 16.)

Using the Tuner

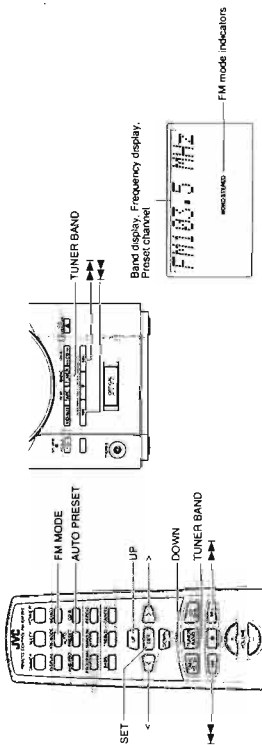

When the System is in use, the display shows other items as well. For simplicity, we show here only the items described in this section.

- You can listen to FM and AM stations. Stations can be tuned in manually, automatically, or from preset memory storage.
- Before listening to the radio:
 - Make sure that both the FM and AM antennas are correctly connected. (See page 33).

One Touch Radio

Just press the TUNER BAND button to turn on the System and start playing the station you were last tuned to.

- You can switch from any other sound source to the radio by pressing the TUNER BAND button.

Tuning in a Station

Press the TUNER BAND button.

The Band and Frequency you were last tuned to appear on the display. (If the last station was selected using the preset number, the preset number appears first.) Each time you press the button, the band alternates between FM and AM.

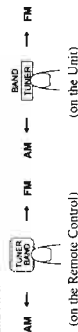

Select a station using one of the following methods.

- Manual Tuning**
If you press the **←** or **→** button on the Unit or the Remote Control repeatedly to move from frequency to frequency until you find the station you want.
- OR**
- Auto Tuning**
If you press and hold the **←** or **→** button on the Unit or the Remote Control for one second or more, the frequency changes down, or up, automatically until a station is found.
- OR**

English
English

- Press the UP, DOWN, >, or < button within 5 seconds to select the preset number.**
UP or > button: Increases the preset number by 1.
DOWN or < button: Decreases the preset number by 1.
When the > or < button is kept pressing, the preset number changes rapidly.

Press the SET button within 5 seconds.

"STORED" appears and after 2 seconds, the display returns to the broadcast frequency display.

Repeat above steps 1 to 5 for each station you want to store in memory with a preset number.

To change the preset stations, repeat the same steps as above.

Auto Presetting

In each band, you can automatically preset FM-30, AM-15 stations. Preset numbers will be allocated as stations are found, starting from the lowest frequency and moving up the frequency.

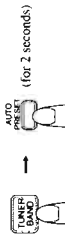

Select a band by pressing the TUNER BAND button.

Press the AUTO PRESET button on the Remote Control for more than two seconds.

Repeat steps 1-2 for the other band.

- If you want to change the preset stations, carry out the Manual Presetting for the desired preset numbers.

CAUTION: Even if the system is unplugged or if the power failure occurs, the preset stations will be stored for about 24 hours. However, in case the preset stations are erased, you will need to preset the stations again.

To Change the FM Reception Mode

When you are tuned into an FM stereo broadcast, the "STEREO" indicator lights up and you can hear stereo effects. If an FM stereo broadcast is hard to receive or noisy, you can select Monaural mode. Reception improves, but you lose stereo effect.

Press the FM MODE button on the Remote Control so that the "MONO" indicator lights up on the display.



To restore the stereo effect, press the FM MODE button on the Remote Control so that the "MONO" indicator goes off.

Presetting Stations

You can preset up to 30 FM stations and up to 15 AM stations using the Remote Control.

Note: Preset numbers may have been set to factory test frequencies prior to shipment. This is not a malfunction. You can preset the stations you want into memory by following one of the presetting methods below.

Manual Presetting

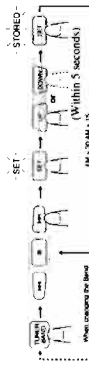

Select a band by pressing the TUNER BAND button.

Press the **←** or **→** button to tune in a station.

Press the SET button.

"SET" will blink for 5 seconds. Within 5 seconds, proceed to the next step. When the display returns to the one set in STEP 2 after 5 seconds, press the SET button again.

Using the CD Player

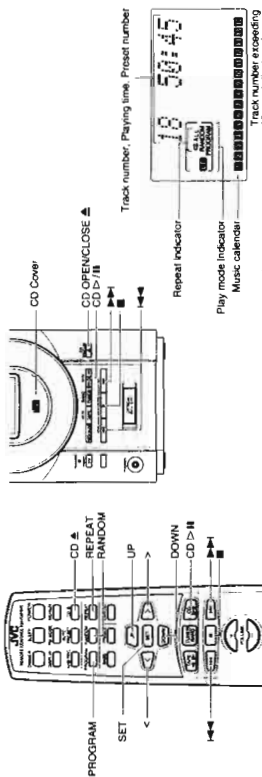

When the System is in use, the display shows other items as well. For simplicity, we show here only the items described in this section.

You can use Normal, Random, Program or Repeat Play. Repeat Play can repeat all the tracks or just one of the tracks on the CD. Here are the basic things you need to know to play a CD and locate the different tracks on it.

The Quickest Way To Start a CD is With the One Touch Operation

- Press the CD >/II button on the Unit or the Remote Control.
- The power is automatically turned on. If a CD is already inserted, it will start playing from the first track.
- If no CD is inserted, "NO DISC" appears on the display and the CD Player remains in Stop mode.

To Insert a CD

Press the CD OPEN/CLOSE button on the Unit (or the CD button on the Remote Control.)

The CD cover opens.

Place a CD, with its label side out as shown below. Press down on the CD's center until you hear a click.

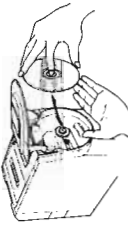

Press the CD OPEN/CLOSE button (or CD button) again to close the CD cover.

- To close the CD cover and play the CD, you can just press the CD >/II button.
- You can place an 8 cm (3") CD without an adaptor.
- If the CD cannot be read correctly (because it is scratched, for example), "0:00" appears on the display.
- You can insert a CD while listening to the other source.

CAUTIONS:

- DO NOT try to open or close the CD cover by hands as it will be damaged.

English
English

To stop playing the CD, press the button. The following information for CD is displayed.

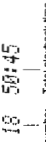

Total track number Total playback time

To stop playing and remove the CD, press the CD OPEN/CLOSE button on the Unit or CD button on the Remote Control to open the CD cover.

To pause, press the CD >/II button. The playback time blinks on the display.

To cancel pause, press the same button again. Play continues from the point where it was paused.

To Select a Track or Passage within a Track

During playback, press the button to select the track you want.

- The selected track starts playing.
- Press the button once to skip to the beginning of the next track.
- Press the button or button to skip to the beginning of the track being played. Press twice quickly to skip to the beginning of the previous track.
- When the > or < button on the Remote Control is kept pressing, the track continuously skips.

Search Play

Holding down the button during playback, will fast forward/backwards the CD so you can quickly find a particular passage in the track you are listening to.

Programming the Playing Order of the Tracks

You can program the playing order of the tracks using the Remote Control.

- You can program up to 20 tracks in any desired order including the same tracks.
- You can only make a program when the CD Player is stopped.

Insert a CD.

Press the CD >/II button.

Press the button to stop the CD.

Press the PROGRAM button.

The System enters the programming mode and the "CD PROGRAM" indicator lights up.



Press the UP, DOWN, >, or < button to select the track to program.

- UP or > button: Increases the track number by 1.
- DOWN or < button: Decreases the track number by 1.
- When the > or < button is kept pressing, the track number changes rapidly.

Press the SET button.

Program order number

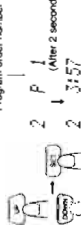

Total playback time of the programmed tracks

Repeat steps 5 and 6 to select the other tracks for the program.

11

You can see the total playback time of programmed tracks on the display. Also, you can see the programmed tracks on the music calendar.

Press the CD >/II button.

The System plays the tracks in the order you have programmed them.

You can skip to a particular program track by pressing the button during Program Play.

To confirm the programmed tracks while the CD player is stopped, each time press the button; the tracks making up the program will successively be displayed in the programmed order.

To delete all the tracks in the program, in stop mode, press the button. Pressing the CD button to open the CD cover will also clear the programmed tracks.

To exit the program mode once, while the CD Player is stopped, press the PROGRAM button to light off the "CD PROGRAM" indicator.

Notes:

- If the total playback time of the programmed tracks exceeds 99 minutes 59 seconds, the total playback time will go out on the display.
- If you try to program the 21th track, "MEMORY FULL" appears on the display for about 2 seconds.

To Modify the Program

Modify the contents of the program while the CD Player is stopped. Each time you press the CANCEL button, the last track in the program is deleted. To add new tracks to the end of the program, repeat above steps 5 to 7.

Random Play

The tracks will play in no special order when you use this mode.

Press the RANDOM button on the Remote Control.

The "CD RANDOM" indicator lights up on the display.

Press the CD >/II button.

The tracks are played in random order.

To skip a track during playback, press the button to jump to the next track in the random sequence. Press the button to jump back to the start of a track being played.

To exit Random Play mode, while the CD Player is stopped, press the RANDOM button to light off the "CD RANDOM" indicator and carry out Normal Play, or press the CD button to open the CD cover.

Repeating Tracks

You can set the program or individual track playing to repeat as many times as you like.

Press the REPEAT button on the Remote Control.

The Repeat indicator changes with each press of the button, as shown below.

- Repeats one track.
- ALL-blank display (back to the beginning)
- ALL: In Normal Play mode, repeats all the tracks in the program.
- ALL: In Random Play mode, repeats all the tracks in random order.

To exit Repeat mode, press the REPEAT button until the Repeat indicator on the display goes out.

- In Random Play, as a matter of course, cannot be selected.
- Repeat mode remains in effect even when you change the play mode.

10

Using the Cassette Deck (Listening to a Tape)

English

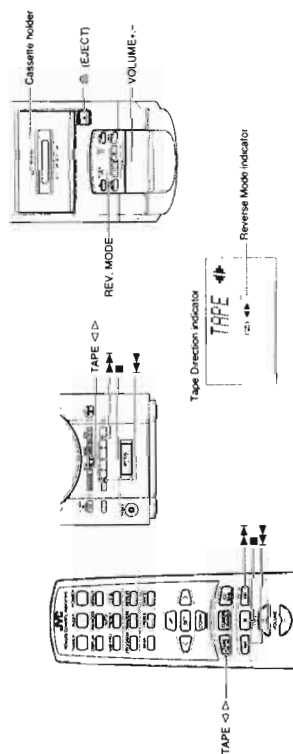

When the System is in use, the display shows other items as well. For simplicity, we show here only the items described in this section.

The Cassette Deck allows you to play and record audio tapes.

- With Automatic Tape Detection, you can listen to type I, II, or IV tapes without having to change any settings.

One Touch Play

By pressing the TAPE <D> button on the Unit or the Remote Control, the Unit will come on, "TAPE" appears in the display, and if a tape is in the deck, it will start to play. If no tape is loaded, "NO TAPE" appears on the display, the Unit will come on and wait for you to insert a tape, or select another function.

Regular Play

When the power is already on, you can use this basic procedure:

- Press the **△ (EJECT)** button.
- When the cassette holder opens, put the cassette in, with the side you want to listen facing up.
 - If the cassette holder does not open, turn the Unit off, then back on and press the **△ (EJECT)** button again.



Close the holder gently until it clicks.

Press the TAPE <D> button.

The tape is played in the direction shown by the Tape Direction indicator.

Using the Cassette Deck (Recording)

English

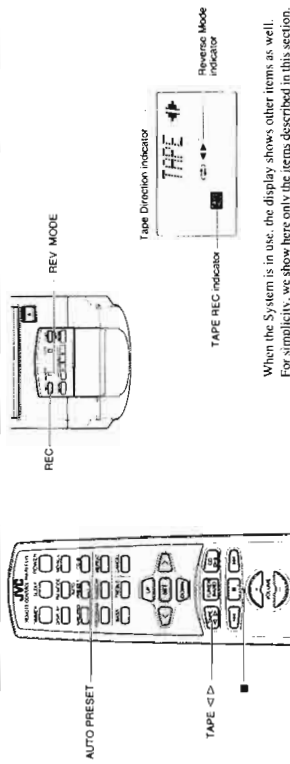

When the System is in use, the display shows other items as well. For simplicity, we show here only the items described in this section.

Recording onto a tape from any of the sound sources is simple. Just place a tape in the Cassette Deck, have the source ready, make one or two settings, and you're ready to record. For each source the procedure is a little bit different so we explain each separately. But first, here are a few things to make your recordings better.

Things To Know Before You Start Recording

- It should be noted that it may be unlawful to re-record pre-recorded tapes, records, or discs without the consent of the owner or copyright in the sound or video recording, broadcast or cable programme and in any literary, dramatic, musical, or artistic work embodied therein.
 - When you want to record onto both sides of a tape, you can set Reverse mode to do so. Recording automatically stops after recording is **▶** when recording with Reverse mode on.
 - The recording level, which is the volume at which the new tape is being made, is automatically set correctly, so it is not affected by the VOLUME control on the System. Nor is it affected by adjusting the sound effects. Thus, during recording you can adjust the sound you are actually listening to without affecting the recording level.
 - Two small tabs on the back of the cassette tape, one for side A and one for side B, can be removed to prevent accidental erasure or recording.

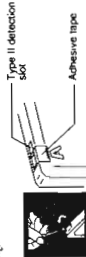

To record on a cassette with the tabs removed, you must cover the holes with adhesive tape first. However, when a type II tape is used, only cover part of the hole as shown, since the other part of the hole (Type II detection slot) is used to detect the tape type.

Type I and Type II tapes can be used for recording.

Note: At the start and end of cassette tapes, there is leader tape which cannot be recorded onto. Thus, when recording CDs or radio broadcasts, wind on the leader tape first to ensure getting the beginning of the recording.

CAUTION: If a recording you make has excessive noise or static, the Unit may have been too close to a TV which was on during the recording. Either turn off the TV or increase the distance between the TV and the System.

Standard Recording

You can record any sound source to tape as follows:

- Insert a blank or erasable tape into the Cassette Deck and wind past the tape leader.
- Press the REV. MODE button on the Unit if you want to record on both sides of the tape.

Press the button until the **▶** indicator is lit.

- When using Reverse mode, insert the tape so that it will be recorded in the forwards **▶** direction.

Check the recording direction for the tape.

Make sure that the Tape Direction indicator is the same as that for the tape in the Cassette Deck. If the directions are different, press the TAPE <D> button to correct the tape direction and then press the **▶** button to stop the tape.

Prepare the source, by, for example, tuning in a radio station or turning on connected auxiliary equipment.

Note: For CD recording, refer to "CD Direct Recording" mentioned below.

Press the REC button on the Unit.

- The "TAPE REC" indicator lights up and the System begins recording.
- If the tab of the cassette tape is removed to prevent erasure or recording, "NO REC" will appear on the display.

English
English

Using External Equipments

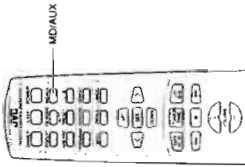

Notes for using Reverse mode for recording
When recording in Reverse mode, the System automatically stops when it reaches the end of the reverse direction. To record on both sides of a tape, make sure that the recording direction for the tape inserted is forwards, and that the Tape Direction indicator is also forwards before you start recording.

To Stop at Any Time During the Recording Process
Press the **■** button.

Recording an AM station to tape

When recording an AM broadcast, beats may be produced which are not heard when listening to the broadcast. If this happens, press the AUTO PRESET button on the Remote Control to eliminate the beats.

1. Set to AM station and start recording.
2. Press the AUTO PRESET button to eliminate the beats. Each time you press the button, the display changes as shown below:
CUT-1 → CUT-2 → CUT-3 → (back to the beginning)

CD Direct Recording

Everything on the CD goes onto the tape in the order it is on the CD, or according to the order you have set in a program.

Insert a cassette into the Cassette Deck and wind past the tape leader.

Insert a CD.

Press the CD > II button on the Unit or on the Remote Control.

Press the ■ button.

- If you want to record specific tracks only, program the tracks beforehand. You can check their total Playback time on the display during programming. (See page 11.)

If you want to record on both sides of a tape, press the REV. MODE button on the Unit until the "→" indicator is lit. Make sure that the recording direction for the tape and the Tape Direction indicator is correct. (See "Notes for using Reverse mode for recording".)

Choose whether to have pauses between recorded selections.

- If nothing is done, a non-recorded pause of about four seconds will be automatically left between selections.
- If you do not want pauses between selections, do the following before proceeding to the next step.

Press the CD > II button on the Unit or the Remote Control twice.

The CD player enters Pause mode.

Press the REC button on the Unit.

The "TAPE REC" indicator lights up and the System begins recording.

- If you make a recording with Reverse mode on, the Unit will record the last song at the end of the first side onto the next side from its beginning when the song has been recorded more than 12 seconds on the first side. If the last song has been recorded less than 12 seconds, then the previous song will again be recorded on the next side as it will not be completely recorded on the first side because of leader tape.

- After the CD player has played the entire CD, or all the programmed tracks, the tape automatically stops.

To stop at any time during the recording process, press the ■ button. The tape stops after four seconds.

Note: When making SLEEP timer settings while doing CD Direct recording, set enough time to allow for the CD to finish playing, otherwise the power will go off before recording is completed.

One Track Recording

Insert a cassette into the Cassette Deck and wind past the tape leader.

Play the track on the CD you wish to record.

Press the REC button on the Unit.

The CD player returns to the beginning of that track and the track is recorded on the tape. After recording, the CD player and Cassette Deck automatically stop.

Listening to External Equipment

You can listen to external equipment such as MD recorder, turntable or other auxiliary.

- First make sure that the external equipment is properly connected to the System. (See page 4).

Set the VOLUME control to the minimum position.

Press the MD/AUX button.

"AUX" appears on the display.



Start playing the external equipment.

Adjust the VOLUME control to the desired listening level.

Apply sound effects, if you wish.

- Press the AHB PRO button to reinforce the bass sound.
- Press the BASS/TREBLE button on the Remote Control to control the tone. (See "Tone Control" on page 7.)

To exit MD/AUX mode, you will automatically switch out of MD/AUX mode when you select another source.

Note: For operation of the external equipment, refer to its instructions.

Recording the System's source to External Equipment

You can record the System's source to external equipment which is connected to the LINE OUT or OPTICAL DIGITAL OUT terminals of the System, such as cassette deck or MD recorder, etc.

- First make sure that the external equipment is properly connected to the System. (See page 4).

Play the System's CD Player, Cassette Deck, or tune into a station.

- The recording level is not affected by the VOLUME level set by the System. Also it is not affected by the sound effects.

Note: For operation of the external equipment, refer to its instructions.

Using the Timers

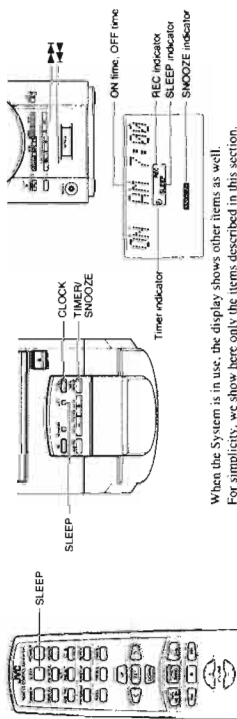

When the System is in use, the display shows other items as well. For simplicity, we show here only the items described in this section.

The timers let you control listening and recording functions automatically.

Setting the Clock

- When you plug the AC power cord into the wall outlet, the time indication blinks on the display.
- You can set the clock, whether the System is on or off. In addition to the digital clock, the analog clock also shows the time.

Notes:

- The clock must be correctly set for the timers to work.
- The procedure must be completed within two minutes. Otherwise, the setting is cleared and must be repeated from the beginning.

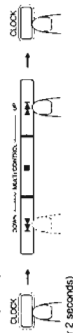

(for 2 seconds)

Press the CLOCK button on the Unit for more than two seconds.

The time indication rapidly blinks on the display.

Press the <=> or <-> button on the Unit to set the time.

Pressing the <=> button moves the time forwards and pressing the <-> button moves it backwards. Hold down the button to move the time rapidly.

Press the CLOCK button.

The selected time is set and the seconds start counting from 0.

CAUTION: If there is a power failure, the clock loses its setting after about 20 minutes. "AM 12:00" blinks on the display and the clock must be reset.

Note: The clock may gain or lose one to two minutes per month.

Setting the Daily Timer

Once you have set the Daily Timer, the timer will be activated at the same time every day. It can be cancelled and re-activate whenever you wish.

The Timer indicator on the display shows when the Daily Timer you have set is in effect.

Note: Perform each setting within 30 seconds. Otherwise, setting is cleared and the procedure must be repeated from the beginning.

English

Setting the volume level.

- Press the TIMERS/SNOOZE button on the Unit.
- The current volume setting blinks on the display.
- Press the <=> or <-> button to select the volume level.
- The current volume level will be used.
- When the timer is turned on, the Volume will be automatically set to the selected level.

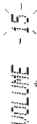

Press the TIMERS/SNOOZE button on the Unit.

The timer setting is completed and the display returns to the display before you set the timer. The timer indicator remains lit.

Before turning off the System, prepare the music source selected in step 4.

TUNER: Tune in to the desired station.

TUNER REC: Tune in to the desired station and insert a cassette tape for recording the station.

CD: Insert a CD.

TAPE: Insert a tape.

Press the POWER button to turn off the System.

To cancel the timer, press the TIMERS/SNOOZE button. The Timer indicator goes out on the display.

To re-activate the cancelled timer, press the TIMER/SNOOZE button to light the Timer indicator. Then, press the TIMERS/SNOOZE button until the display returns to the original display. The Timer indicator should remain lit.

To confirm the timer settings, cancel the timer once by pressing the TIMERS/SNOOZE button. Then, press the TIMER/SNOOZE button repeatedly to see the current timer settings (ON time, OFF time, source, and volume).

To change the timer setting, repeat the setting procedure from the beginning.

- When the timer turns on, the Timer indicator starts blinking.

CAUTION: If the System is unplugged, or a power failure occurs, the timer setting will be lost. You will need to reset the clock first, then the timer.

5-Minute Snoozing

When the timer turns on the music source you can, if you wish, activate the 5-minute snoozing function to temporarily stop playback.

Press the TIMERS/SNOOZE button on the Unit.

The "SNOOZE" indicator lights up on the display and the power is turned off for five minutes for snoozing.

Setting the SLEEP Timer

Use the Sleep Timer to turn the System off after a certain number of minutes when it is playing. By setting the Sleep Timer, you can fall asleep to music and know that your System will turn off by itself rather than play all night.

- You can only set the Sleep Timer when the System is on and a source is playing.

Play a CD, a cassette tape, or tune in to the desired station.

Press the SLEEP button.

The "SLEEP" indicator lights up.

When the clock is not set, the "CLOCK" indicator and the "ADJUST" indicator appear alternately on the display. Set the clock at first.

Set the length of time you want the source to play before shutting off.

- Each time you press the SLEEP button, it changes the number of minutes shown on the display in this sequence: 10 → 20 → 30 → 60 → 90 → 120 → Cancelled → (back to the beginning)

After setting the number of minutes for the Sleep Timer, the display will stop blinking and return to the display as before setting the Sleep Timer. (The display is dimmed.)

The System is now set to turn off after the number of minutes you set.

To Confirm the Sleep Time

When the SLEEP button is pressed, the remaining sleep time is displayed. Wait until the display returns to the original display.

To Cancel the SLEEP Timer Setting

Press the SLEEP button until the "SLEEP" indicator goes out on the display.

- Turning off the System also cancels the SLEEP Timer.
- If you are setting the Daily Timer, the System will be turned on at the set time to wake you up.

Care And Maintenance

Handle your CDs carefully, and they will last a long time.

Compact Discs

- Only CDs bearing this mark can be used with this System. However, continued use of irregular shape CDs (heart-shape, octagonal, etc.) can damage the System.

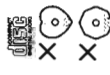

- Remove the CD from its case by holding it at the edges while pressing the case's center hole lightly.
- Do not touch the shiny surface of the CD, or bend the CD.
- Put the CD back in its case after use to prevent warping.
- Be careful not to scratch the surface of the CD when placing it back in the case.
- Avoid exposure to direct sunlight, temperature extremes, and moisture.
- A dirty CD may not play correctly. If a CD does become dirty, wipe it with a soft cloth in a straight line from center to edge.



CAUTION: Do not use any solvent (for example, conventional record cleaner, spray thinner, benzine, etc.) to clean a CD.

General Notes

- In general, you will have the best performance by keeping your CDs and the mechanism clean.
- Store CDs in their cases, and keep them in cabinets, or on shelves.
- Keep the system's CD cover closed when not in use.

Cleaning the lens

- If the lens in the CD pickup is dirty, dropout, etc., could degrade sound.
- Open the CD cover and clean the lens as shown.
- Use a blower (available from a camera store) to blow dust off the lens.

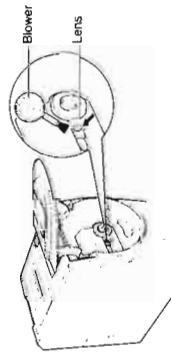

- If there are fingerprints, etc. on the lens, gently wipe clean with a cotton swab.



Moisture Condensation

- Moisture may condense on the lens inside the System in the following cases:
 - After turning on heating in the room.
 - In a damp room.
 - If the System is brought directly from a cold to a warm place.
- Should this occur, the System may malfunction. In this case, leave the System turned on for a few hours until the moisture evaporates, unplug the AC power cord, and then plug it in again.



Cassette Tapes

- If the tape is loose, it may get stretched, cut, or caught in the cassette. Take up the slack by inserting a pencil in one of the reels and rotating.
- Do not touch the tape surface.
- Do not store the tape:
 - In dusty places
 - In direct sunlight or heat
 - In moist areas
 - On a TV or speaker
 - Near a magnet



Cassette Deck

- If the heads, capstans, or pinch-rollers of the Cassette Deck become dirty, the following may occur:
 - Loss of sound quality
 - Discontinuous sound
 - Fading
 - Incomplete erasure
 - Difficulty recording
- Clean the heads, capstans, and pinch-rollers using a cotton swab moistened with alcohol.

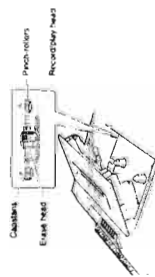

- If the heads become magnetized, the Unit will produce noise or lose high frequency notes.
- To demagnetize the heads, turn off the Unit, and use a head demagnetizer (available at electronics and record shops).

Troubleshooting

- If you are having a problem with your System, check this list for a possible solution before calling for service.
- If you cannot solve the problem from the hints given here, or the System has been physically damaged, call a qualified person, such as your dealer, for service.

Symptom	Possible Cause	Action
No sound is heard.	<ul style="list-style-type: none"> Connections are incorrect, or loose. Headphones are connected. 	<ul style="list-style-type: none"> Check all connections and make corrections. (See pages 4 - 5.) Disconnect the headphones.
Unable to record.	Cassette record protect tabs are removed.	Cover the holes on the back edge of the cassette with tape.
Poor radio reception	<ul style="list-style-type: none"> The antenna is disconnected. The AM Loop Antenna is too close to the System. The FM Wire Antenna is not properly extended and positioned. 	<ul style="list-style-type: none"> Reconnect the antenna securely. Change the position and direction of the AM Loop Antenna. Extend FM Wire Antenna to the best reception position.
The CD skips.	The CD is dirty or scratched.	Clean or replace the CD.
The CD does not play.	The CD is upside down.	Put the CD in with the label side up.
Unable to operate the Remote Control.	<ul style="list-style-type: none"> The path between the Remote Control and the sensor on the Unit is blocked. The batteries have lost their charge. 	<ul style="list-style-type: none"> Remove the obstruction. Replace the batteries.
Operations are disabled.	The built-in microprocessor has malfunctioned due to external electrical interference.	Unplug the System then plug it back in.
The cassette holder cannot be opened.	During tape playing, the power cord was unplugged.	Plug in the power cord, press the POWER button, and then press the ▲ button.

Specifications

English

Amplifier

Output Power 16 watts per channel, min. RMS, at 4 ohms from 80 Hz to 15 kHz, with no more than 10% total harmonic distortion (for U.S.A.)
34 W (17 W + 17 W) at 4 ohms (Max.) (for Canada)

Input Sensitivity/Impedance (1 kHz)
LINE IN (AUX) 500 mV/65 kohms

Output Sensitivity/Impedance (1 kHz)
LINE OUT 500 mV/4.3 kohms

Optical out -21 dBm -15 dBm

Speaker terminals 4 - 16 ohms

Phones 16 ohms - 1 kohm

0 - 15 mW/1ch output into 32 ohms

Cassette Deck

Frequency Response

Type II (CRO) 50 Hz - 15 kHz

Wow and Flutter 0.15 % (WRMS)

CD Player

Signal-To-Noise Ratio 90 dB

Wow And Flutter Unmeasurable

Tuner

FM Tuner

Tuning Range 87.5 - 108.0 MHz

AM Tuner

Tuning Range 530 - 1,710 kHz

Speaker Specifications

(each unit)

Speakers 8 cm cone

Impedance 4 ohms

Dimensions 140 X 230 X 217 mm (W/H/D)

(5 - 9/16" X 9 - 1/16" X 8 - 9/16")

Mass Approx. 1.8 kg (4.0 lbs)

General

Dimensions 438 X 232 X 310.5 mm (W/H/D)

(17 - 1/4" X 9 - 3/16" X 12 - 1/4")

Mass Approx. 7.2 kg (15.9 lbs)

Accessories

Power Cord (1)

AM Loop Antenna (1)

Remote Control (1)

Batteries R6P (SUM-3/AAA (1.5F) (2)

FM Wire Antenna (1)

Power Specifications

Power Requirements AC 120 V ~, 60 Hz

Power Consumption 37 watts (power on mode)

3 watts (in Standby mode)

Design and specifications are subject to change without notice.

JVC

VICTOR COMPANY OF JAPAN, LIMITED

UX-V3/UX-V5
UX-V5R/FS-V5

<<MEMO>>

Disassembly Method

<Main body>

■ Rear cover (Refer to Fig. 1 and 2.)

1. Remove the six screws A and one screw B fastening the rear cover from the back of the main frame.
2. Remove the two screws C fastening the rear cover from the bottom of the main frame.
3. Unlock both the speaker terminal and antenna terminal. As the lock pawls are held raised, remove the rear cover from the main frame rearwards.

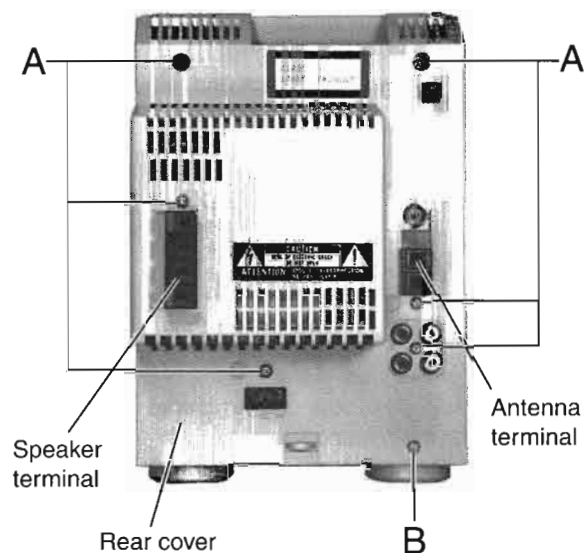

Fig. 1

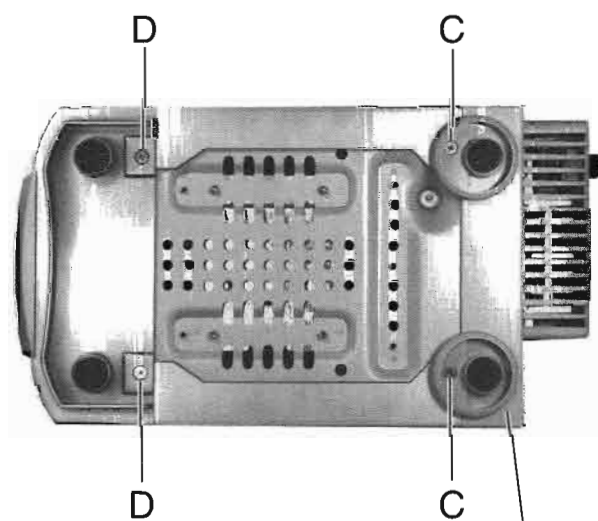

Fig. 2

■ Side panels (right, left)

(Refer to Fig. 2)

1. Remove the two screws D fastening the side panels (right and left) from the bottom of the main frame.
2. Slide the respective side panels (right and left) rearwards to remove them as indicated by the arrows in Fig. 3 and 4.

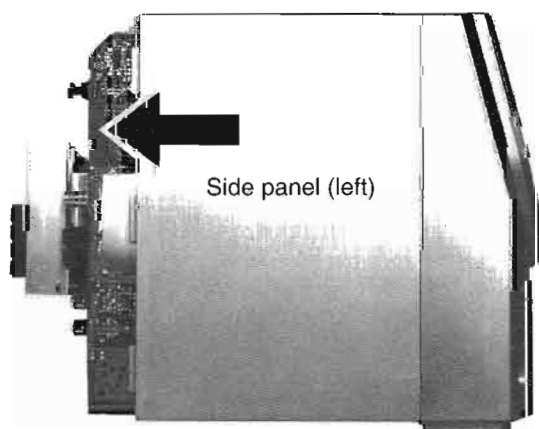

Fig. 3

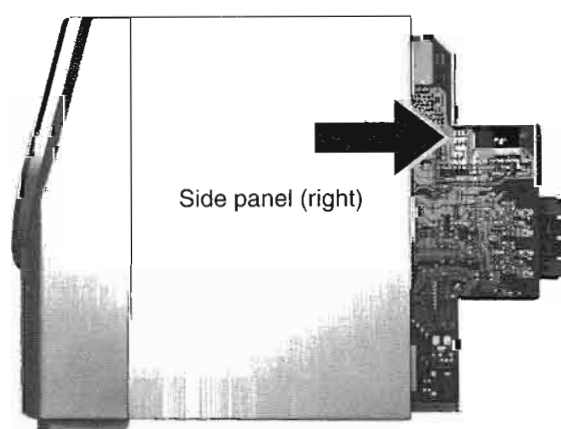

Fig. 4

■ Cassette mechanism assembly (Refer to Fig. 5 to 7.)

- Remove the rear cover from the main frame.
 - Remove the side panels (right and left) from the main frame.
1. Disconnect the card wire and 2-pin harness respectively from the connectors CN43, CN44 and CN508 of the TUNER & FUNCTION board located in the left side of the main frame.
 2. Remove the two screws E fastening the cassette mechanism assembly from the right and left sides of the main frame.
 3. Remove the two screws F fastening the REGULATOR board and the cassette mechanism assembly from the back of the main frame.
 4. Disjoin the two joints a on the right and left sides of the main frame so that the cassette mechanism assembly is released from fitting with the main frame. Then, move the cassette mechanism assembly upper rearwards to remove it.

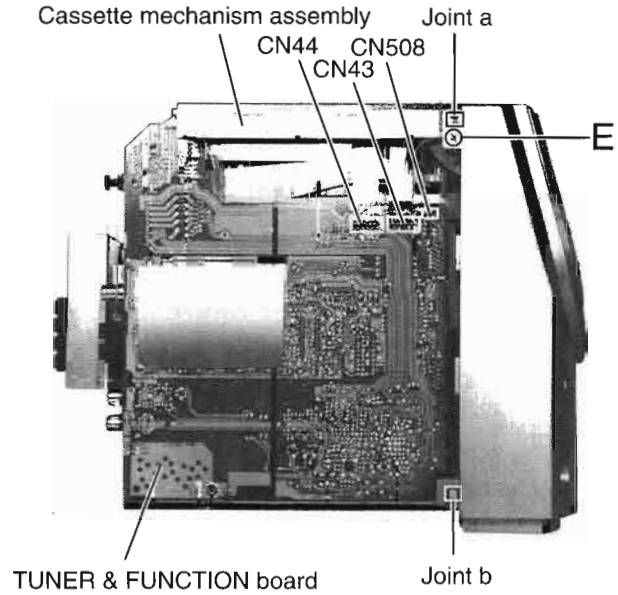

Fig. 5

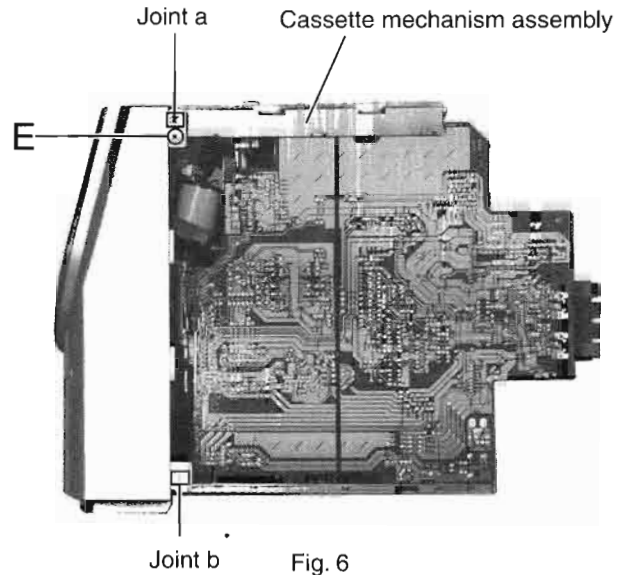

Fig. 6

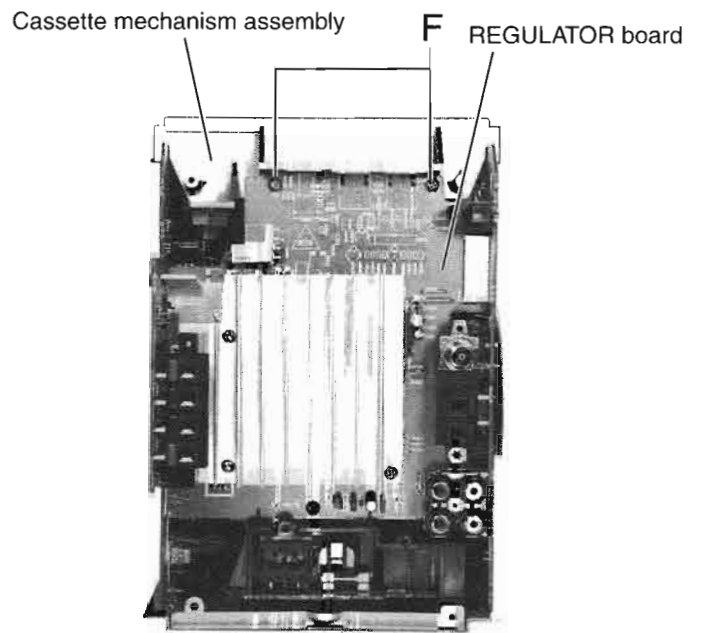

Fig. 7

■ TUNER & FUNCTION board, REGULATOR board, MAIN board

(Refer to Fig. 8 to 12.)

- Remove the rear cover from the main frame.
- Remove the side panels (right and left) from the main frame.
- Remove the cassette mechanism assembly from the main frame.

Note: The TUNER & FUNCTION board, REGULATOR board and MAIN board can be removed as the front panel assembly remains being fitted to the main frame.

● TUNER & FUNCTION board

1. Disconnect the 4-pin harness card wire, 3-pin harness respectively from the connectors CN501, CN502 and CN504 of the TUNER & FUNCTION board located in the left side of the main frame.
2. Remove the one screw G fastening the TUNER & FUNCTION board, and disconnect the connector CN503 from connection with the REGULATOR board as well as the connector CN506 and CN507 from connection with the front panel assembly. Then, remove the TUNER & FUNCTION board by drawing it out upwards from the chassis base.

● MAIN board

3. Disconnect the 5-pin harness and 2-pin harness respectively from the connectors CN304 and CN308 of the MAIN board located in the right side of the main frame.
 4. Disconnect the 4-pin harness from the connector CN501 of the TUNER & FUNCTION board located in the left side of the main frame.
 5. Remove the one screw H fastening the MAIN board and one screw I fastening the REGULATOR board and heat sink in the rear of the main frame.
- Disconnect the connector CN301 from connection with the REGULATOR board and the connectors CN371 and CN372 from connection with the front panel assembly. Then, draw out the MAIN board upwards from the chassis base.

● REGULATOR board

7. Disconnect the connector CN197 of the REGULATOR board located in the rear of the main frame, and remove one screw I fastening the REGULATOR board together with the heat sink and one screw J fastening the REGULATOR board independently.
8. Disconnect the connector CN196 (CN503) from connection with the TUNER & FUNCTION board and the connector CN195 (CN301) from connection with the MAIN board while spreading the respective boards outside. Then, remove the REGULATOR board upwards from the main frame.

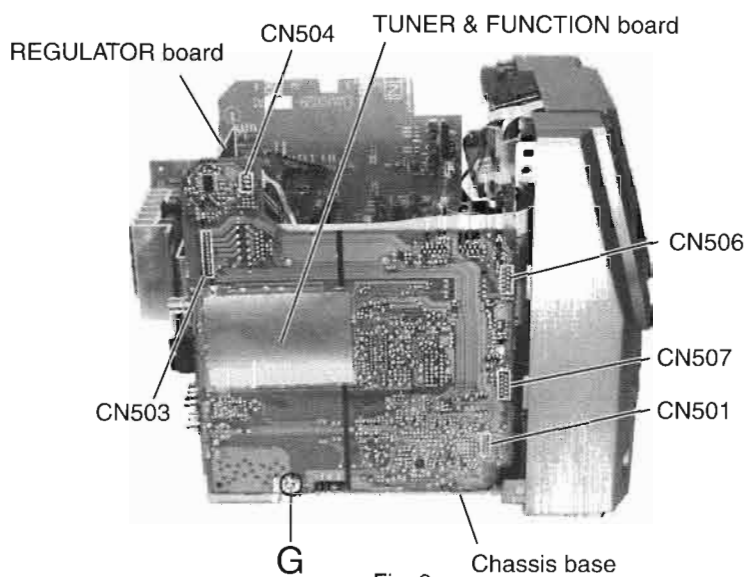

Fig. 8

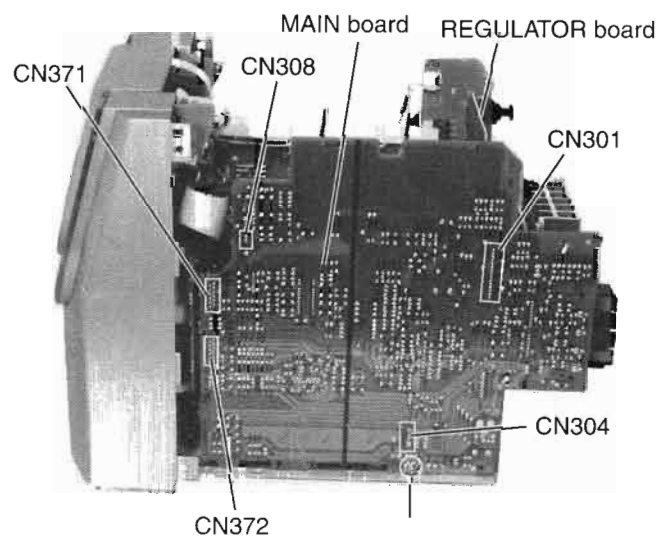

Fig. 9

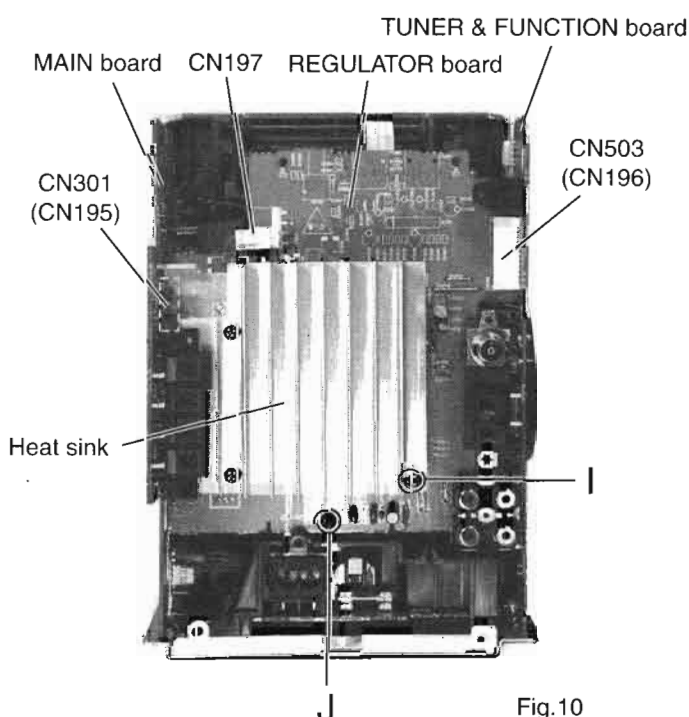

Fig.10

■ Front panel assembly

(Refer to Fig. 11 and 12.)

- Remove the rear cover from the main frame.
- Remove the side panels (right and left) from the main frame.
- Remove the cassette mechanism assembly from the main frame.

1. Disconnect the card wire and 3-pin harness respectively from the connectors CN502 and CN504 of the TUNER and FUNCTION board located in the left side of the main frame.
2. Disconnect the 5-pin harness from the connectors CN304 and CN308 of the MAIN board located in the right side of the main frame, and unclamp the wire clamp at the midpoint of the 5-pin harness so that the harness is released from it.
3. Disjoin the two joints b on the right and left sides of the main frame so that the front panel assembly is released from fitting with the main frame. (Refer to Fig. 5 and 6.)

Disconnect the front panel assembly from the connectors CN506 and CN507 of the TUNER & FUNCTION board and connectors CN371 and CN372 of the MAIN board, and then draw out the front panel assembly frontwards to remove it from the main frame.

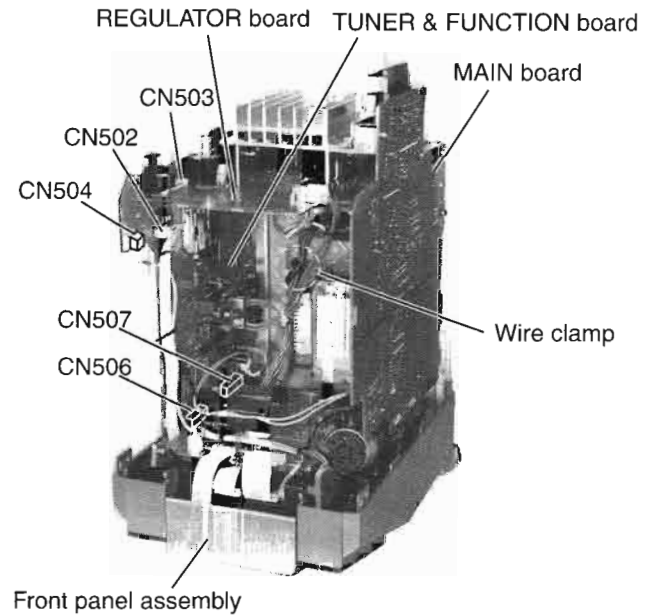

Fig.11

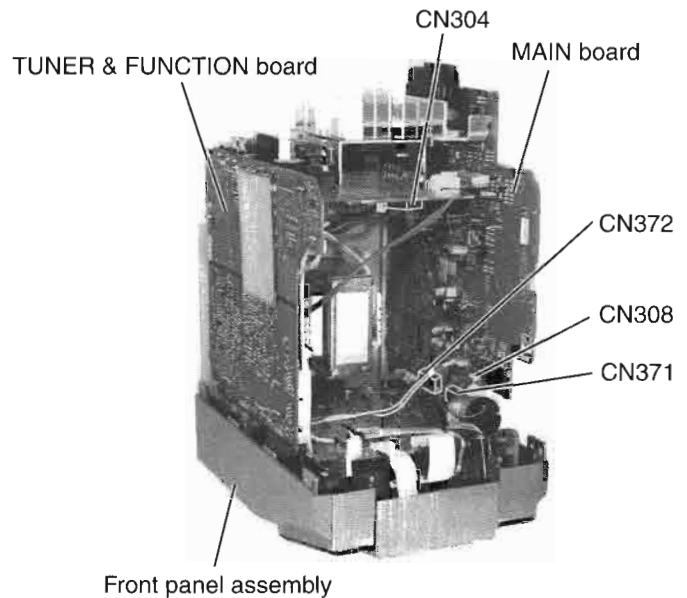

Fig.12

■ Power transformer assembly (Refer to Fig. 13.)

- Remove the rear cover from the main frame.
 - Remove the side panels (right and left) from the main frame.
 - Remove the cassette mechanism assembly from the main frame.
1. Disconnect the 2-pin harness from the connector CN197 of the REGULATOR board located in the rear of the main frame and the 2-pin harness from the connector CN199 of the POWER TERMINAL board.
 2. Remove the four screws K fastening the power transformer assembly to remove it.

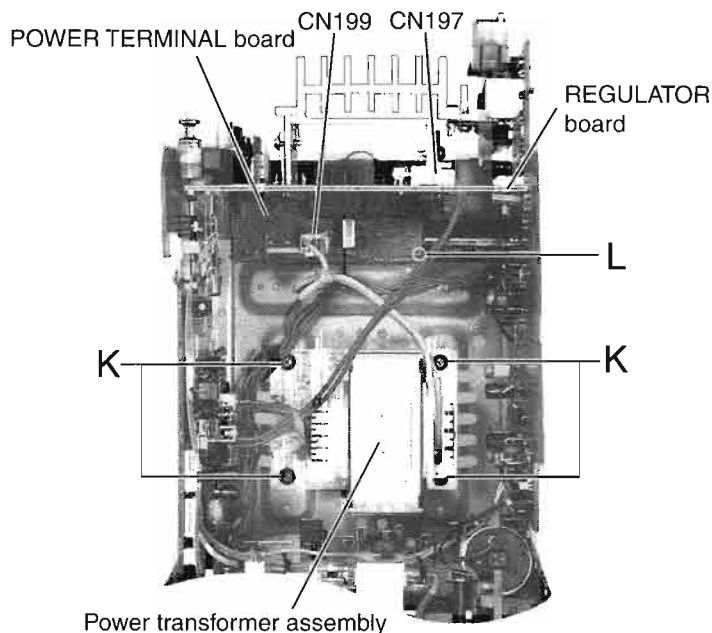

Fig.13

■ POWER TERMINAL board (Refer to Fig. 13.)

- Remove the rear cover from the main frame.
- Remove the side panels (right and left) from the main frame.
- Remove the cassette mechanism assembly from the main frame.
- Remove the REGULATOR board from the main frame.

1. Disconnect the 2-pin harness from the connector CN199 of the POWER TERMINAL board and remove one screw fastening the POWER TERMINAL board to remove the board.

<Cassette mechanism assembly>

- Remove the rear cover from the main frame.
- Remove the side panels (right and left) from the main frame.
- Remove the cassette mechanism assembly from the main frame.

■ FUNCTION board (Refer to Fig. 14.)

1. Remove the four screws M fastening the FUNCTION KEY board to remove the board.

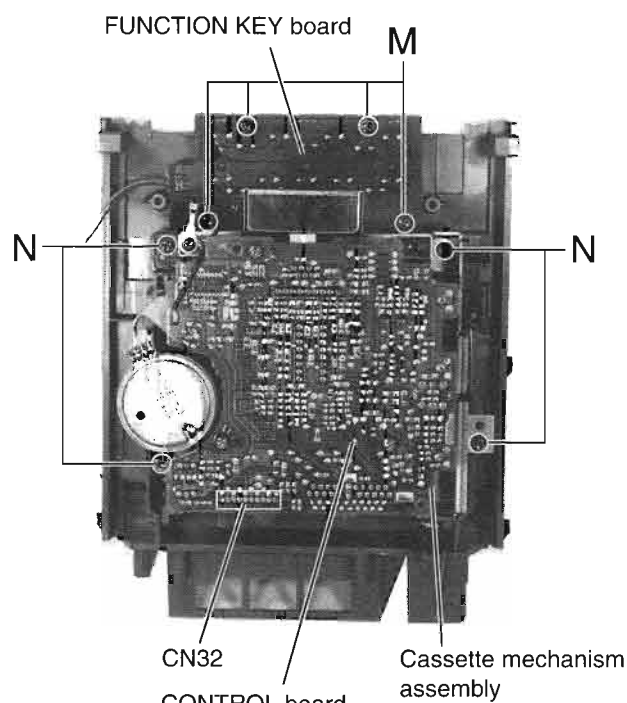

Fig.14

■ Cassette mechanism assembly (Refer to Fig. 14 and 15.)

1. First remove the four screws N fastening the cassette mechanism assembly. Next press the EJECT button on the front panel to open the cassette door, and then remove the cassette mechanism assembly.

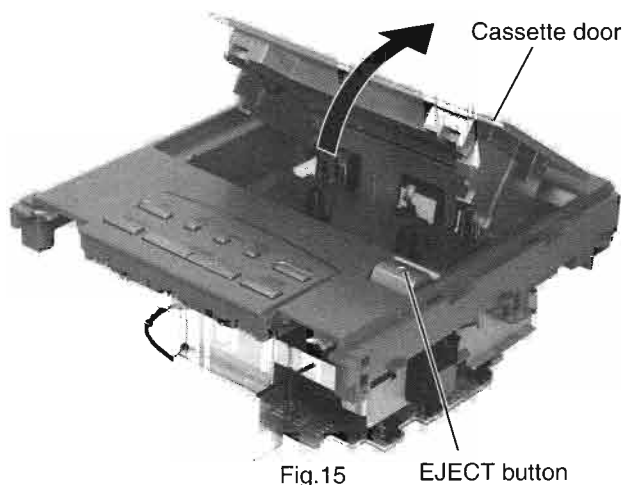

Fig.15

<Front panel assembly>

- Remove the rear cover from the main frame.
- Remove the side panels (right and left) from the main frame.
- Remove the cassette mechanism assembly from the main frame.
- Remove the front panel assembly from the main frame.

■ FRONT board (Refer to Fig. 16.)

1. Disconnect the card wires from the connectors CN701, CN712 and CN711 and the 3-pin harness from the connector CN714 of the FRONT board located in the back of the front panel assembly.
2. Remove the four screws O fastening the FRONT

■ HEADPHONE TERMINAL board (Refer to Fig. 16.)

1. Remove the one screw Q fastening the CD DOOR SW (Switch) board from the back side of the front panel assembly.

■ CD DOOR SW board (Refer to Fig. 16.)

1. Remove the one screw Q fastening the CD DOOR SW (Switch) board from the back side of the front panel assembly.

■ OPERATION SW board (Refer to Fig. 17.)

- Remove the FRONT board from the back side of the front panel assembly.
1. Remove the five screws R fastening the OPERATION SW board.

■ CD mechanism assembly (Refer to Fig. 17 and 18.)

- Remove the FRONT board and CD DOOR SW board from the back side of the front panel assembly.
1. Remove the four screws S fastening the CD mechanism assembly. Open the CD door in the front side of the front panel assembly and remove the CD mechanism assembly
 Note: When the screws S are removed, the CD SERVO CONTROL board is also unfastened together with the CD mechanism assembly. Pay careful attention to the CD SERVO CONTROL assembly not to get it falling down when loosening and removing the screws S.
 2. Disconnect the flexible wire from the connector CN603 of the CD SERVO CONTROL board and the 2-pin harness from the connectors CN605, CN606 and CN607 respectively. Then remove the CD mechanism assembly and the CD SERVO CONTROL board together.

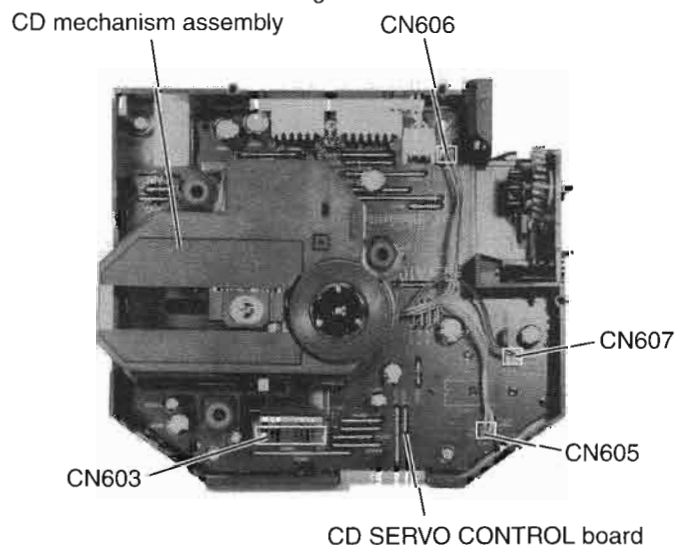
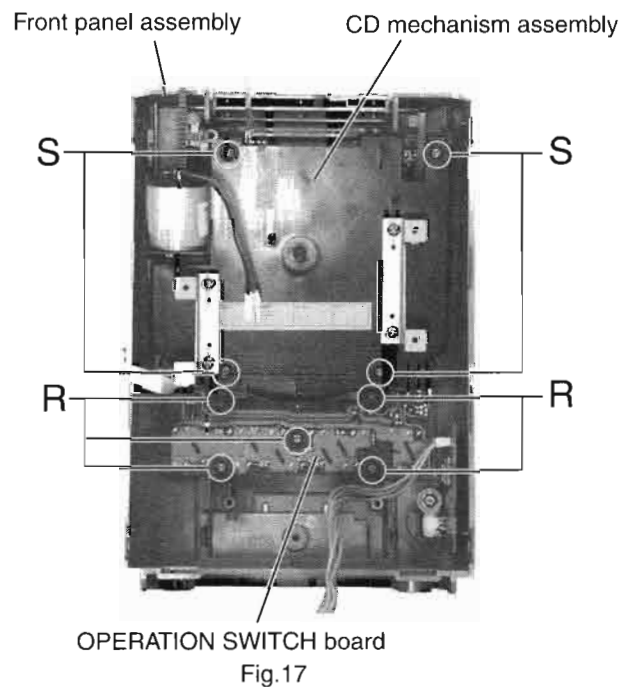
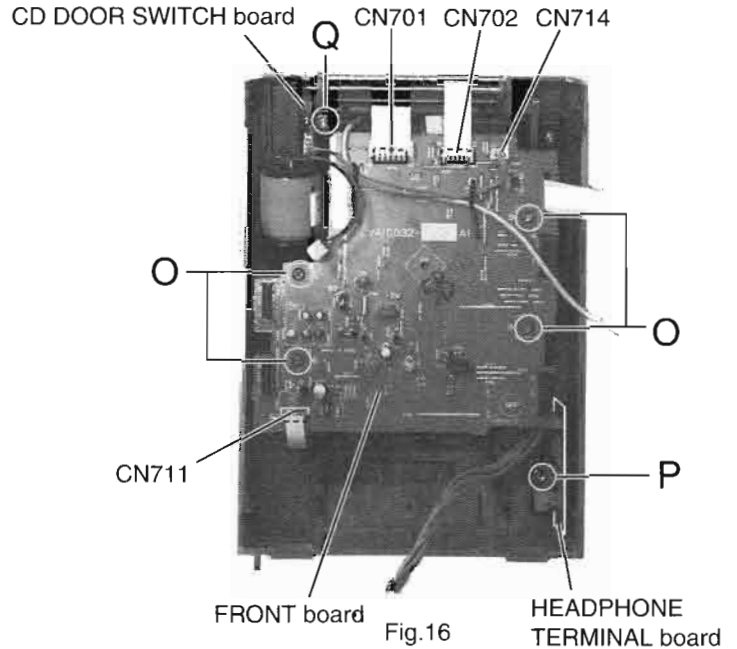

■ Loading motor (Refer to Fig. 19.)

- Remove the FRONT board, CD DOOR SW board and CD player assembly from the front panel assembly.
1. Disengage the belt from the loading motor and then remove it and two screws T from the CD player assembly.

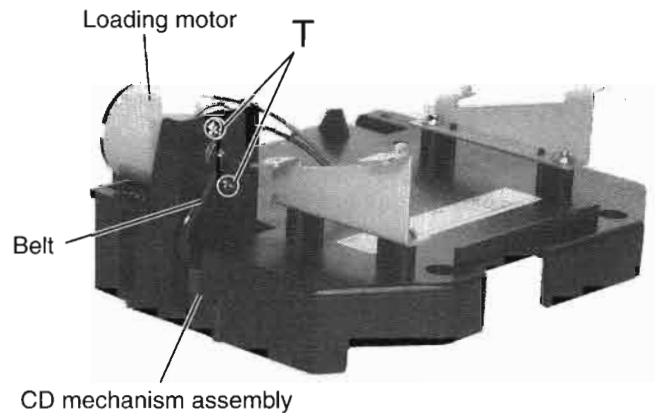

Fig.19

■ CD door assembly (Refer to Fig. 20.)

1. Remove the two screws U fastening the CD door assembly.
2. Remove the two lock keys c for unhooking the CD door assembly, and then remove the CD door assembly from the front panel while moving it in the direction of the arrow.
3. Draw out the shaft and remove the CD door base.

Note: For reassembling the CD door assembly to the main frame, insert the CD door assembly into the two slits d on the front panel and fasten it with the two lock keys c.

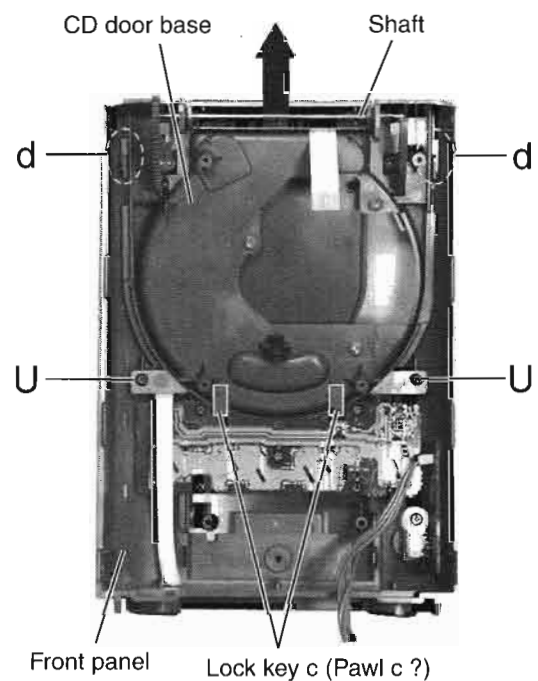

Fig.20

■ LCD board assembly

(Refer to Fig. 21 and 22.)

1. Open the CD door and remove three screws V fastening the LCD (cover) inside the CD door. Unhook the LCD board assembly from four pawls d of the board case.

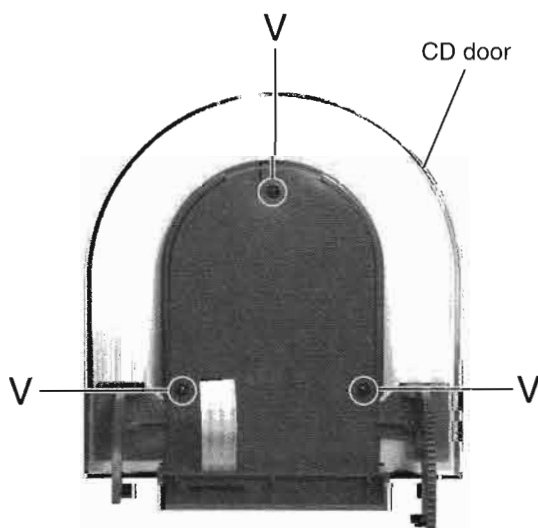

Fig.21

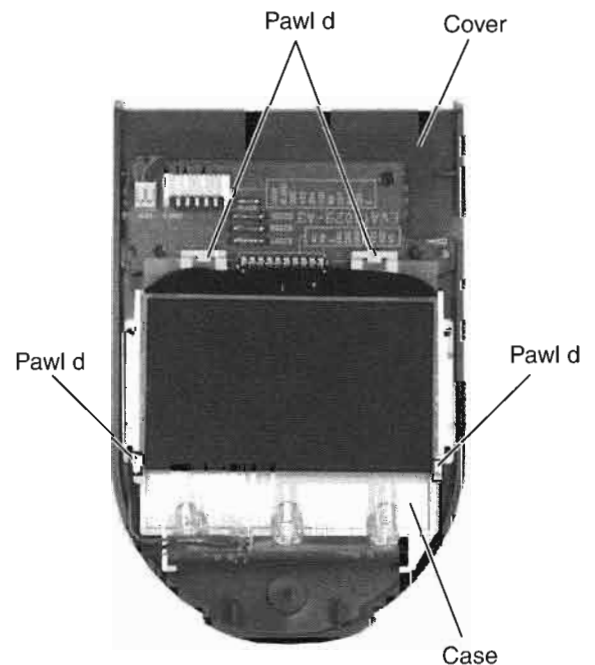

Fig.22

<<Cassette Mechanism Section>>

■ Removing the Playback/Recording & Eraser Head (See Figs. 1 and 2)

1. While shifting the trigger arms seen on the right side of the head mount in the arrow direction, turn the flywheel R in counterclockwise direction until the head mount has gone out with a click (See Fig. 1).
2. When the flywheel R is rotated in counterclockwise direction, the Playback/Recording & Eraser head will be turned in counterclockwise direction from the position in Fig. 2 to that in Fig. 3.
3. At this position, disconnect the flexible P.C. board (outgoing from the Playback/Recording & Eraser head) from the connector CN31 on the head amplifier & mechanism control P.C. board.
4. After dismantling the FPC holder, remove the flexible P.C. board.
5. Remove the flexible P.C. board from the chassis base.
6. Remove the spring Afro behind the Playback/Recording & Eraser head.
7. Loosen the reversing azimuth screw retaining the Playback /Recording & Eraser head.
8. Take out the Playback/Recording & Eraser head from the front of the head mount.
9. The Playback/Recording & Eraser head should also be removed similarly according to Steps 1 ~ 8 above.

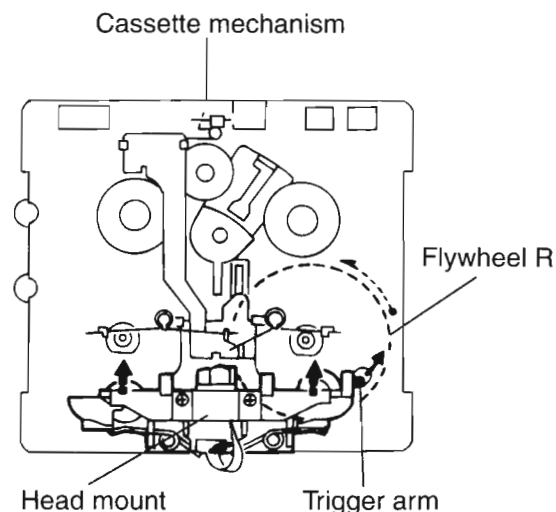

Fig. 1

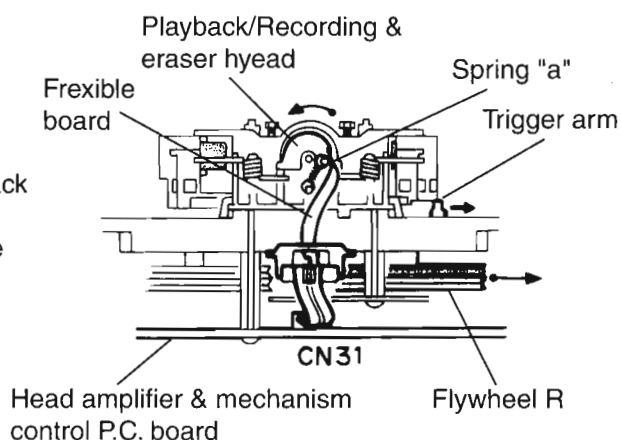

Fig. 2

■ Reassembling the Playback/Recording & Eraser Head

1. Reassemble the playback head from the front of the head mount to the position as shown in Fig. 3.
2. Fix the reversing azimuth screw.
3. Set the spring "a" from behind the Playback/Recording & Eraser head.
4. Attach the flexible P.C. board to the chassis base, and fix it with the FPC holder as shown in Fig. 3.
5. The Playback/Recording & Eraser head should also be reassembled similarly to Step 1 ~ 4 above.

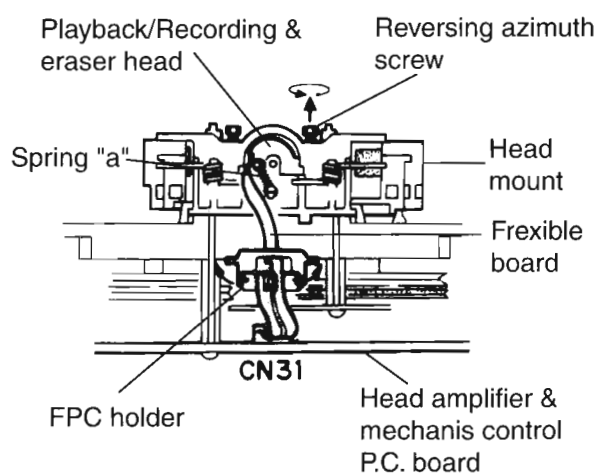
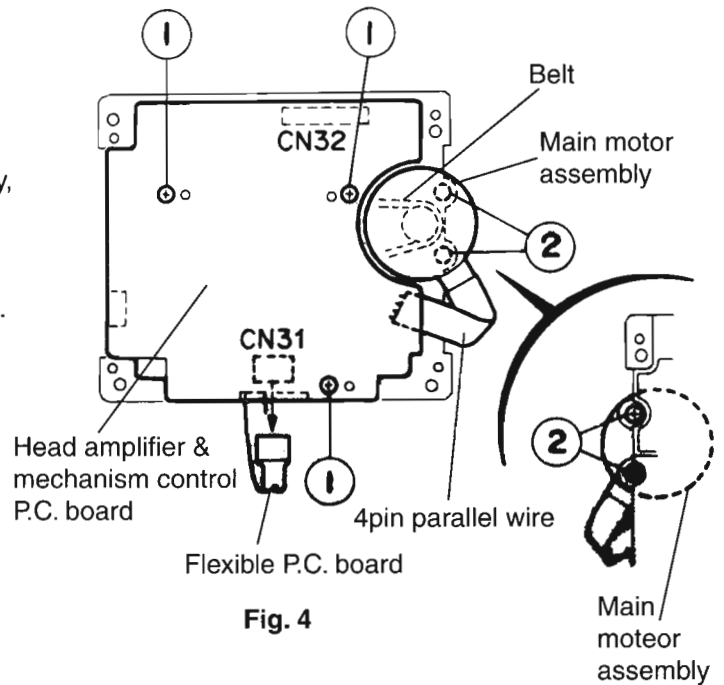

Fig. 3

■ **Removing the Head amplifier & Mechanism control P.C. board**
(See Fig. 4)

1. Remove the cassette mechanism assembly.
2. After turning over the cassette mechanism assembly, remove the three screws "1" retaining the head amplifier & mechanism control P.C. board.
3. Disconnect the connector CN32 on the P.C. board including the connector CN 1 on the reel pulse P.C. board.
4. When necessary, remove the 4 pin parallel wire soldered to the main motor.



■ **Removing the Main Motor Assembly**
(See Fig. 4~6)

1. Remove the two screws "2" retaining the main motor assembly (See Fig. 4, 4a).
2. While raising the main motor, remove the capstan belt from the motor pulley (See Fig. 4a).

Caution 1: Be sure to handle the capstan belt so carefully that this belt will not be stained by grease and other foreign matter. Moreover, this belt should be hanged while referring to the capstan belt hanging method in Fig. 5, 6.

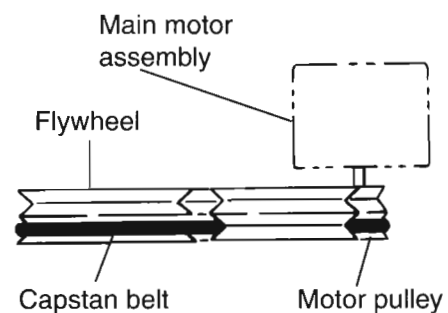
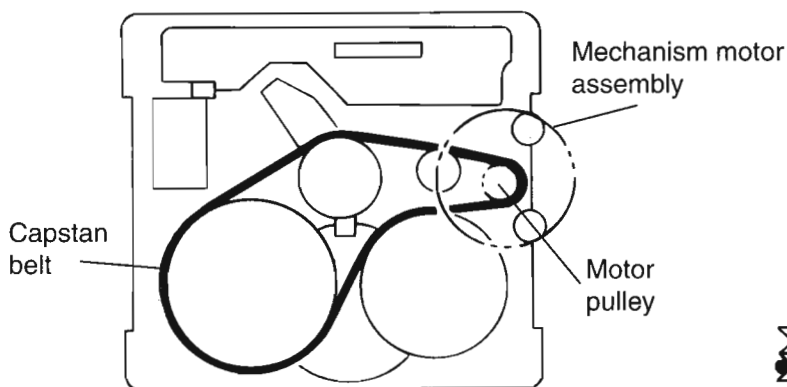
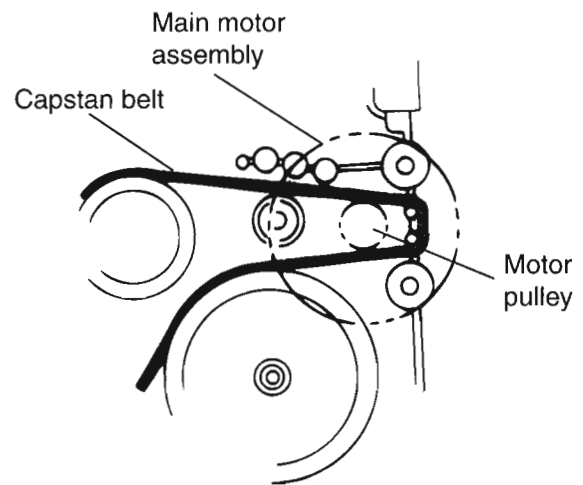

■ **Removing the Flywheel**

(See Figs. 7 and 8)

1. Remove the head amplifier & mechanism control P.C. board.
2. Remove the main motor assembly.
3. After turning over the cassette mechanism, remove the slit washers "b" and "c" fixing the capstan shafts R and L, and pull out the flywheel R and L respectively from behind the cassette mechanism.

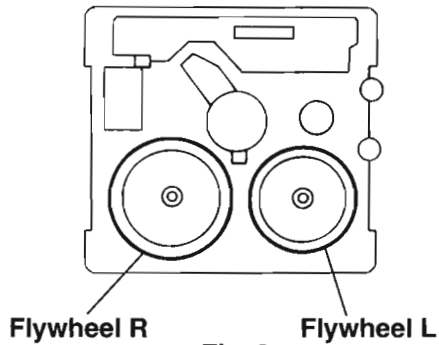

Fig. 8

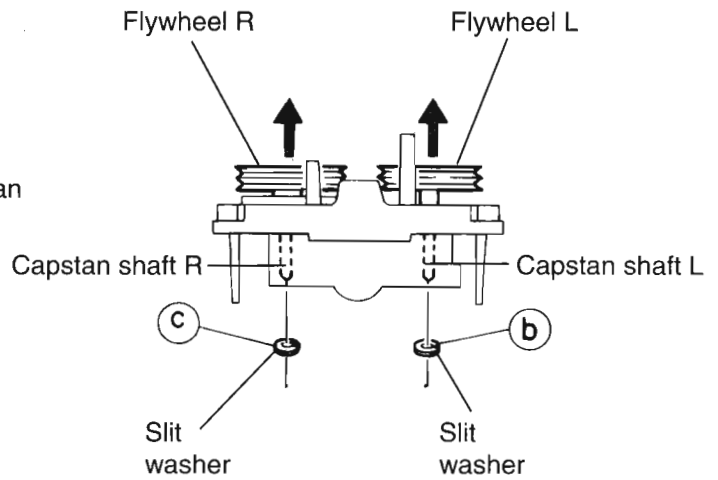

Fig.7

■ **Removing the Reel Pulse P.C. board and Solenoid**

(See Fig. 9)

1. Remove the five pails "d"~"h" retaining the reel pulse P.C. board.
2. From the surface of the reel pulse P.C. board parts, remove the two pawls "i" and "j" retaining the solenoid.

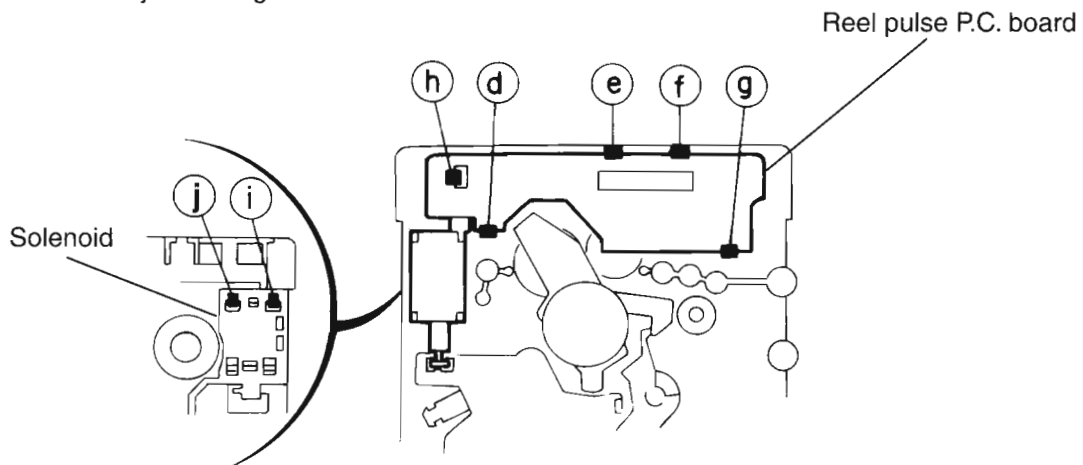

Fig. 9

Main Adjustment

■ Measurement Instruments Required for Adjustment

1. Low frequency oscillator
This oscillator should have a capacity to output 0dBs to 600 Ω at an oscillation frequency of 50Hz-20kHz.
2. Attenuator impedance : 600 Ω
3. Electronic voltmeter
4. Distortion meter
5. Frequency counter
6. Wow & flutter meter
7. Test tape
VTT703L : Head azimuth
VT712 : Tape speed and running unevenness (3kHz)
VT724 : Reference level (1kHz)
8. Blank tape
TYPE I : AC-225
TYPE II : AC-514
9. Torque gauge : For play and back tension
FWD(TW2111A), REV(TW2121a) and
FF/REW(TW2231A)
10. Test disc: CTS-1000

■ Measurement conditions

Power supply voltage
: AC230V (50Hz)----B/E/EE/EN
: AC110/127V/230V(50/60Hz)
: UB/UF/US/UX/U

Reference output : Speaker : 0.775V/4Ω
: Headphone : 0.077V/32Ω

Reference frequency and
input level ----- 1kHz, AUX : -8dBs
MIX MIC: -54dBs (UB/UF/US/UX/U)
Input for confirming recording and playback
characteristics ----- AUX : -28dBs
Measurement output terminal ----- at Speaker J3002
※ Load resistance ----- 4Ω

● Radio Input signal

AM frequency ----- 400Hz
AM modulation ----- 30%
FM frequency ----- 400Hz
FM frequency deviation ----- 22.5kHz

● Tuner section

B/E/EN version

FM Band cover: 87.5~108MHz

MW Band cover: 522~1,629kHz

LW Band cover: 144~288kHz

EE version

FM Band cover: 65~74MHz, 87.5~108MHz

MW Band cover: 522~1,629kHz

LW Band cover: 144~288kHz

UB/UF/US/UX/U version

FM Band cover: 87.5~108MHz

MW Band cover: 531~1,602kHz, 530~1,710kHz

SW Band cover: SW1 2.3~6.995MHz

: SW2 7~21.85MHz

Voltage applied to tuner ----- +B : DC5.7V
VT : DC 12V

Reference measurement

output ----- 26.1mV(0.28V)/3Ω

Input positions ----- AM : Standard loop antenna
FM : TP1 (hot) and TP2 (GND)

● Standard measurement position of volume

Function switch ----- to Tape
Beat cut switch ----- to Cut
Super Bass/Active hyper Bass ----- to OFF
Bass Treble ----- to Center
Adjustment of main volume to reference output
VOL : 28

Precautions for measurement

1. Apply 30pF and 33kΩ to the IF sweeper output side and 0.082 μ F and 100kΩ in series to the sweeper input side.
2. The IF sweeper output level should be made as low as possible within the adjustable range.
3. Since the IF sweeper is a fixed device, there is no need to adjust this sweeper.
4. Since a ceramic oscillator is used, there is no need to perform any MIX adjustment.
5. Since a fixed coil is used, there is no need to adjust the FM tracking.
6. The input and output earth systems are separated. In case of simultaneously measuring the voltage in both of the input and output systems with an electronic voltmeter for two channels, therefore, the earth should be connected particularly carefully.
7. In the case of BTL connection amp., the minus terminal of speaker is not for earthing. Therefore, be sure not to connect any other earth terminal to this terminal. This system is of an BTL system.
8. For connecting a dummy resistor when measuring the output, use the wire with a greater code size.
9. Whenever any mixed tape is used, use the band pass filter (DV-12).

<<Arrangement of Adjusting Position>>

Cassette mechanism section

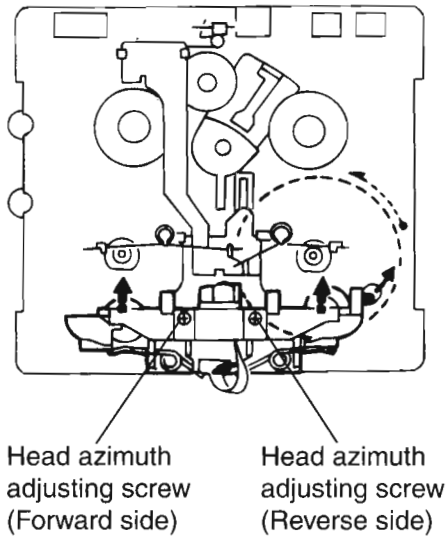

Cassette mechanism section (Back side)

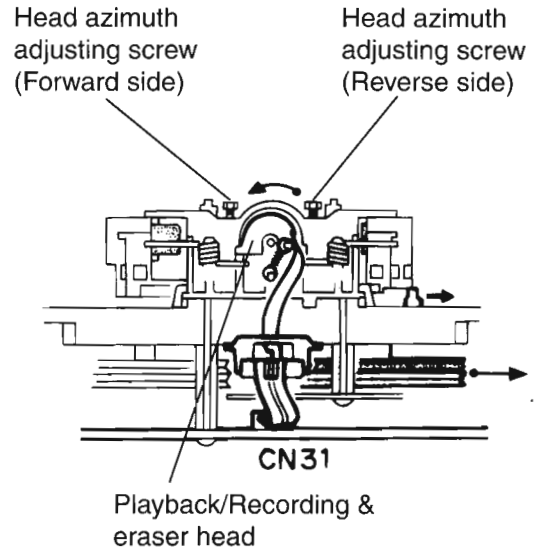

Front panel assembly section

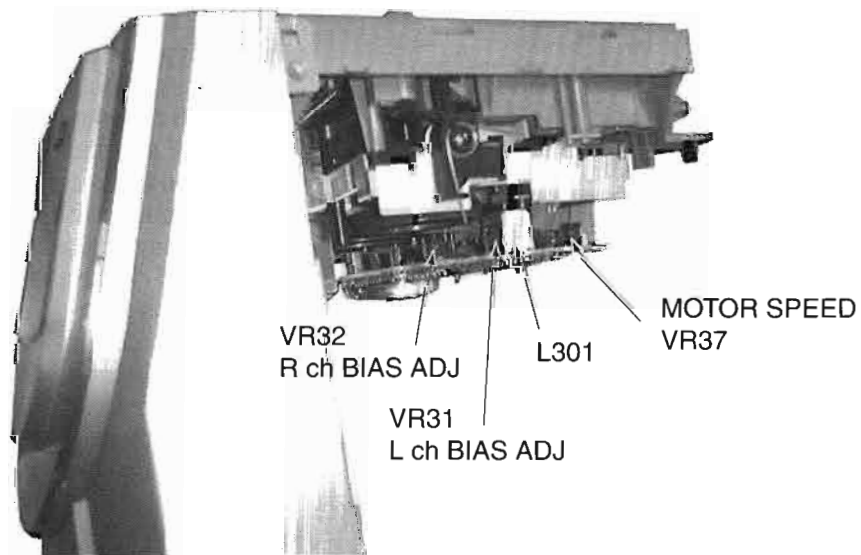

■ Tape Recorder Section

Items	Measurement conditions	Measurement method	Standard Values	Adjusting positions
Confirmation of head angle	Test tape : VTT703L (8kHz) Measurement output terminal : Speaker terminal Speaker R (Load resistance: 4Ω) : Headphone terminal	1 Playback the test tape VTT703L (8kHz) 2 With the recording & playback mechanism, adjust the head azimuth screw so that the forward and reverse output levels become maximum. After adjustment, lock the head azimuth at least by half turn. 3 In either case, this adjustment should be performed in both the forward and reverse directions with the head azimuth screw.	Maximum output	Adjust the head azimuth screw only when the head has been changed.
Confirmation of tape speed	Test tape : VT712 (3kHz) Measurement output terminal : Headphone terminal	Adjust VR37 so that the frequency counter reading becomes 2,940~3,090Hz ± when playing back the test tape VT712 (3kHz) with playback and recording mechanism after ending forward winding of the tape.	Tape speed of deck : 2,940 ~ 3,090Hz	VR37

■ Reference Values for Confirmation Items

Items	Measurement conditions	Measurement method	Standard Values	Adjusting positions
Difference between the forward and reverse speed	Test tape : VT712 (3kHz) Measurement output terminal : Speaker terminal Speaker R (Load resistance: 4Ω) Measurement output terminal : Headphone	When the test tape VT712 (3kHz) has been played back with the recording and playback mechanism at the beginning of forward winding, the frequency counter reading of the difference between both of the mechanism should be 6.0Hz or less.	6.0Hz or less	Head azimuth screw
Wow & flutter	Test tape : VT712 (3kHz) Measurement output terminal : Headphone terminal	When the test tape VT712 (3kHz) has been played back with the recording and playback mechanism at the beginning of forward winding, the frequency counter reading of wow & flutter should be 0.25% or less (WRMS).	0.25% or less (WRMS)	

■ Electrical Performance

Items	Measurement conditions	Measurement method	Standard Values	Adjusting positions
Adjustment of recording bias current (Reference Value)	<ul style="list-style-type: none"> • Mode: Forward or reverse mode • Recording mode • Test tape : AC-514 to TYPE II and AC-225 to TYPE I Measurement output terminal : Both recording and headphone terminals	<ol style="list-style-type: none"> 1 With the recording and playback mechanism, load the test tapes (AC-514 to TYPE II and AC-225 to TYPE I), and set the mechanism to the recording and pausing condition in advance. 2 After connecting 100 Ω in series to the recorder head, measure the bias current with a valve voltmeter at both of the terminals. 3 After resetting the [PAUSE] mode, start recording. At this time, adjust VR31 for Lch and VR32 for Rch so that the recording bias current values become 4.0 μ A (TYPE I) and 4.20 μ A (TYPE II). 	AC-225 : 4.20 μ A AC-514 : 4.0 μ A	L ch : VR31 R ch : VR32
Adjustment of recording and playback frequency characteristics	Reference frequency : 1kHz and 10kHz (REF.: -20dB) Test tape : AC-514 to TYPE II Measurement input terminal : OSC IN	<ol style="list-style-type: none"> 1 With the recording and playback mechanism, load the test tapes (AC-514 to TYPE II), and set the mechanism to the recording and pausing condition in advance. 2 While repetitively inputting the reference frequency signal of 1kHz and 10kHz from OSC IN, record and playback the tape. 3 While recording and playback the test tape in TYPE II , adjust VR31 for Lch and VR32 for Rch so that the output deviation between 1kHz and 10kHz becomes -1dB±2dB. 	Output deviation between 1kHz and 10kHz : -1dB±2dB	L ch : VR31 R ch : VR32

■ Reference Values for Electrical Function Confirmation Items

Items	Measurement conditions	Measurement method	Standard Values	Adjusting positions
Recording bias frequency	Forward or reverse <ul style="list-style-type: none"> • Test tape : TYPE II (AC-514) • Measurement terminal : BIAS TP on P.C. board 	<ol style="list-style-type: none"> 1 While changing over to and from BIAS 1 and 2, confirm that the frequency is changed. 2 With the recording and playback mechanism, load the test tape. (AC-514 to TYPE II), and set the mechanism to the recording and pausing condition in advance. 3 Confirm that the BIAS TP frequency on the P.C. board is 100kHz ± 6kHz. 	100 kHz ± 6 kHz	
Eraser current (Reference value)	Forward or reverse <ul style="list-style-type: none"> • Recording mode • Test tape : AC-514 to TYPE II and AC-225 to TYPE I Measurement terminal : Both of the eraser head terminals	<ol style="list-style-type: none"> 1 While recording and playback mechanism, load the test tapes (AC-514 to TYPE II and AC-225 to TYPE I), and set the mechanism to the recording and pausing conditions in advance. 2 After setting to the recording conditions, connect 1W in series to the eraser head on the recording and playback mechanism side, and measure the eraser current from both of the eraser terminals. 	TYPE II : 120 mA TYPE I : 75 mA	

Flow of Functional Operation Until TOC Read

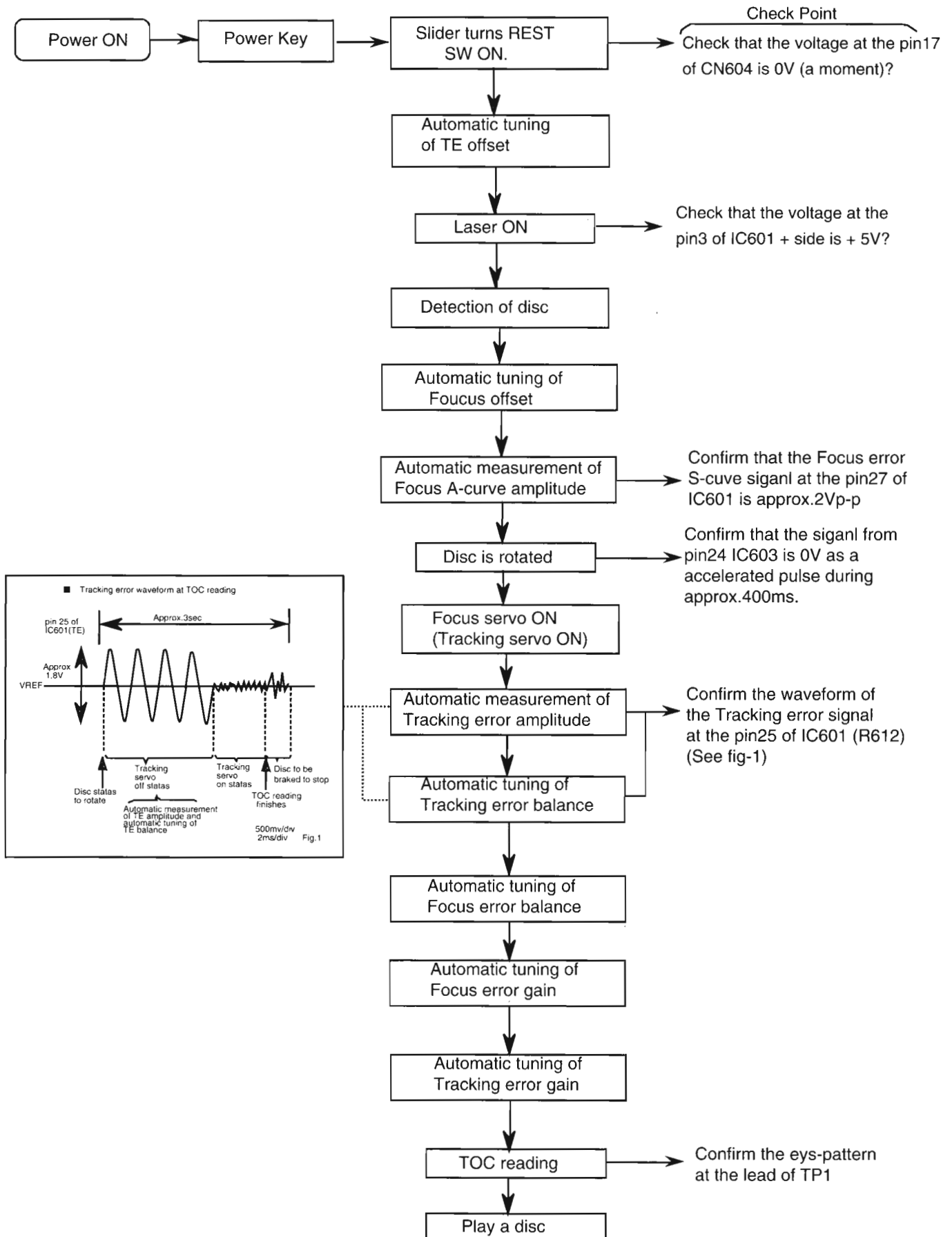

Maintenance of Laser Pickup Replacement of Laser Pickup

(1) Cleaning the pick up lens
Before you replace the pick up, please try to clean the lens with a alcohol soaked cotton swab.

(2) Life of the laser diode (Fig.1)
When the life of the laser diode has expired, the following symptoms wil appear.

(1) The level of RF output (EFM output:ampli tude of eye pattern) will below.

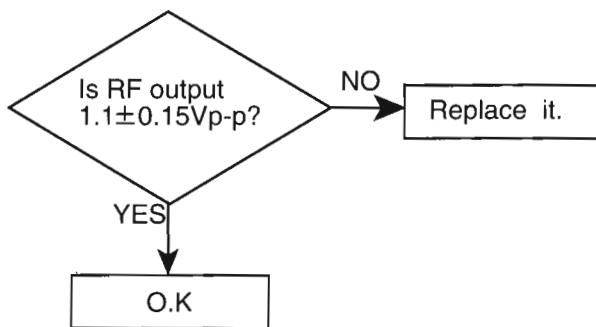

(Fig.1)

(3) Semi-fixed resistor on the APC PC board
The semi-fixed resistor on the APC printed circuit board which is attached to the pickup is used to adjust the laser power. Since this adjustment should be performed to match the characteristics of the whole optical block, do not touch the semi-fixed resistor.
If the laser power is lower than the specified value, the laser diode is almost worn out, and the laser pickup should be replaced.
If the semi-fixed resistor is adjusted while the pickup is functioning normally, the laser pickup may be damaged due to excessive current.

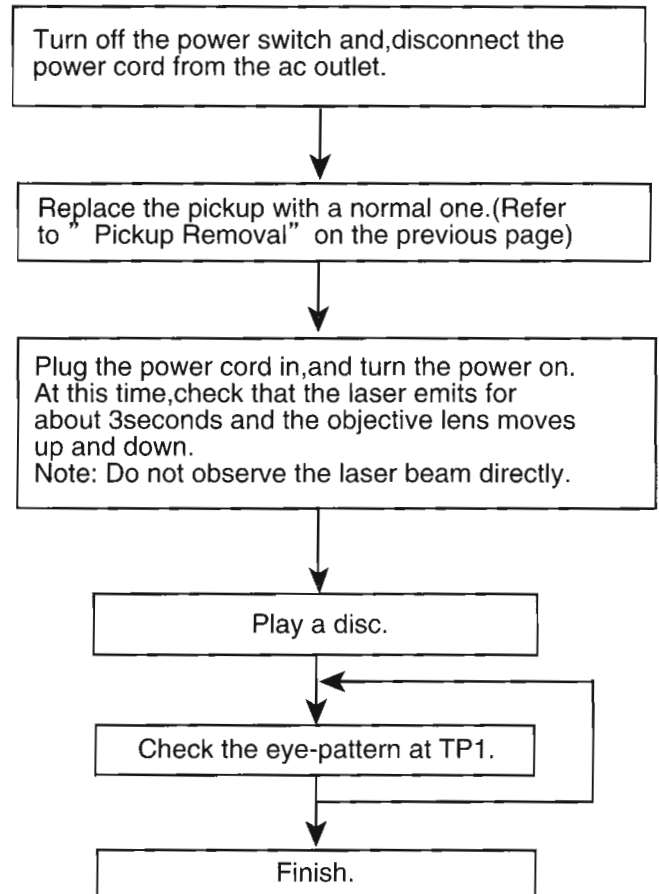

Description of major ICs

■ MN35510 (IC603) : DIGITAL SERVO&DIGITAL SIGNAL PROCESSOR

1. Terminal Layout

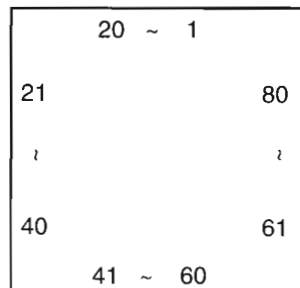

2. Block Diagram

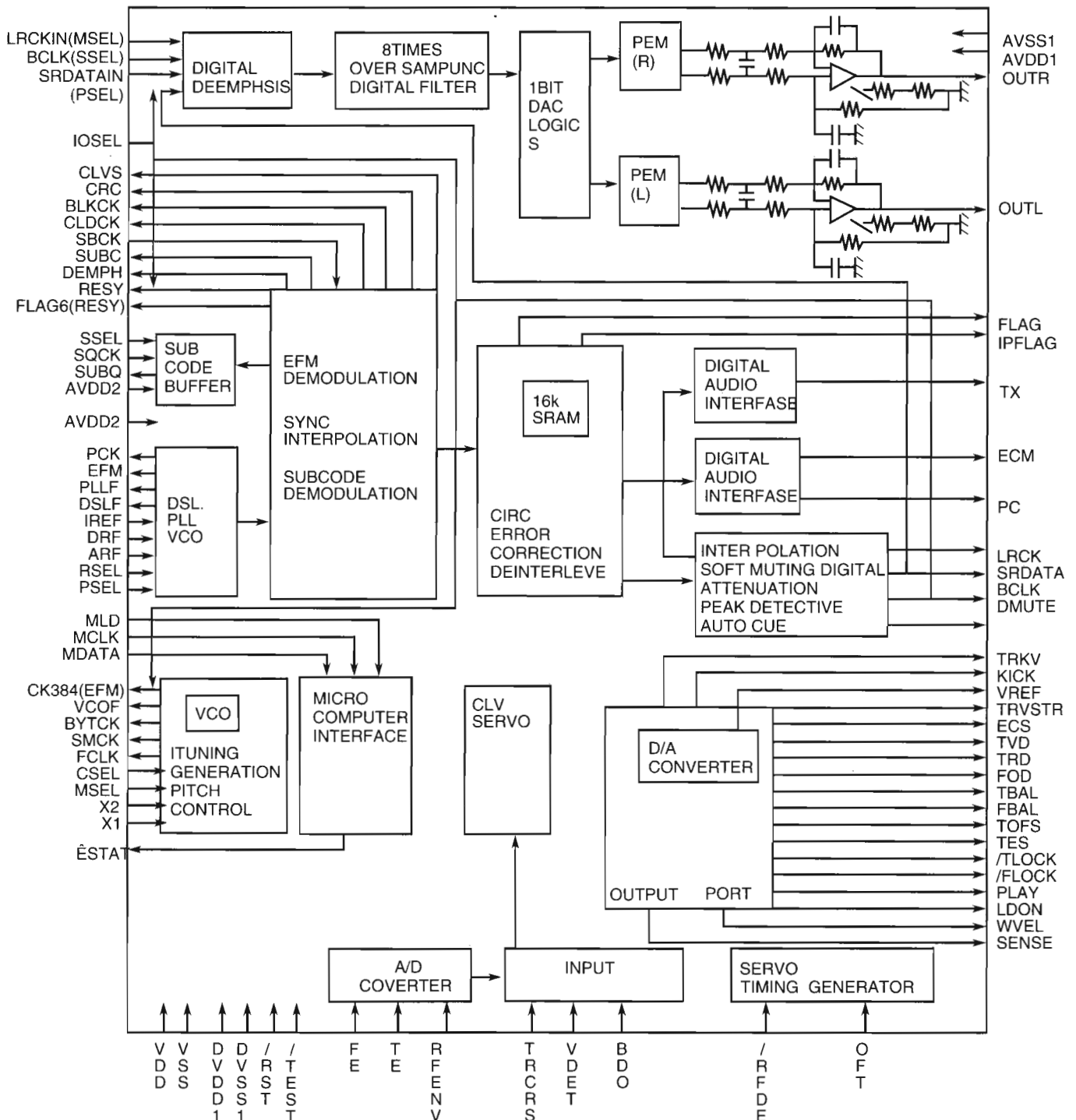

UX-V3/UX-V5
UX-V5R/FS-V5

3. Description

Pin No.	symbol	I/O	Description	Pin No.	symbol	I/O	Description
1	BCLK	O	Not used	41	TES	O	Tracking error shunt signal output(H:shunt)
2	LRCK	O	Not used	42	PLAY	-	Not used
3	SRDATA	O	Not used	43	WVEL	-	Not used
4	DVDD1	-	Power supply (Digital)	44	ARF	I	RF signal input
5	DVSS1	-	Connected to GND	45	IREF	I	Reference current input pin
6	TX	O	Digital audio interface output	46	DRF	I	Bias pin for DSL
7	MCLK	I	μ com command clock signal input (Data is latched at signal's rising point)	47	DSLIF	I/O	Loop filter pin for DSL
8	MDATA	I	μ com command data input	48	PLLIF	I/O	Loop filter pin for PLL
9	MLD	I	μ com command load signal input	49	VCOF	-	Not used
10	SENSE	O	Sence signal output	50	AVDD2	-	Power supply(Analog)
11	FLOCK	O	Focus lock signal output Active :Low	51	AVSS2	-	Connected to GND(Analog)
12	TLOCK	O	Tracking lock signal output Active :Low	52	EFM	-	Not used
13	BLKCK	O	sub-code/block/clock signal output	53	PCK	-	Not used
14	SQCK	I	Outside clock for sub-code Q resister input	54	PDO	-	Not used
15	SUBQ	O	Sub-code Q -code output	55	SUBC	-	Not used
16	DMUTE	-	Connected to GND	56	SBCK	-	Not used
17	STATUS	O	Status signal (CRC,CUE,CLVS,TTSTOP,ECLV,SQOK)	57	VSS	-	Connected to GND(for X'tal oscillation circuit)
18	RST	I	Reset signal input (L:Reset)	58	XI	I	Input of 16.9344MHz X'tal oscillation circuit
19	SMCK	-	Not used	59	X2	O	Output of X'tal oscillation circuit
20	PMCK	-	Not used	60	VDD	-	Power supply(for X'tal cscillation circuit)
21	TRV	O	Traverse enforced output	61	BYTCK	-	Not used
22	TVD	O	Traverse drive output	62	CLDCK	-	Not used
23	PC	-	Not used	63	FLAG	-	Not used
24	ECM	O	Spindle motor drive signal (Enforced mode output) 3-State	64	IPPLAG	-	Not used
25	ECS	O	Spindle motor drive signal (Servo error signal output)	65	FLAG	-	Not used
26	KICK	O	Kick pulse output	66	CLVS	-	Not used
27	TRD	O	Tracking drive output	67	CRC	-	Not used
28	FOD	O	Focus drive output	68	DEMPH	-	Not used
29	VREF	I	Reference voltage input pin for D/A output block (TVD,FOD,FBA,TBAL)	69	RESY	-	Not used
30	FBAL	O	Focus Balance adjust signal output	70	IOSEL	-	pull up
31	TBAL	O	Tracking Balance adjust signal output	71	TEST	-	pull up
32	FE	I	Focus error signal input(Analog input)	72	AVDD1	-	Power supply(Digital)
33	TE	I	Tracking error signal input(Analog input)	73	OUT L	O	Lch audio output
34	RF ENV	I	RF envelope signal input(Analog input)	74	AVSS1	-	Connected to GND
35	VDET	I	Vibration detect signal input(H:detect)	75	OUT R	O	Rch audio output
36	OFT	I	Off track signal input(H:off track)	76	RSEL	-	pull up
37	TRCRS	I	Track cross signal input	77	CSEL	-	Connected to GND
38	RFDET	I	RF detect signal input(L:detect)	78	PSEL	-	Connected to GND
39	BDO	I	BDO input pin(L:detect)	79	MSEL	-	Connected to GND
40	LDON	O	Laser ON signal output(H:on)	80	SSEL	-	Pull up

■ UPD78056GC-A29(IC701)System controller

	VERSION	80	79	78	77	76	75	74	73	72	71	70	69	68	67	66	65	64	63	62	61		
KEY	FKEY																					60	RESET
KEY1	LOCK	○																				59	BUP
NC	SAFTY1																					58	MT0
AVSS	SAFTY2																					57	MT1
SCD	AVREF0																					56	MTS
REST	AVDD																					55	AHB
AVREF1	XT1																					54	VOL
MLD	XT2																					53	BASS
MDATA	IC																					52	TRE
MCLK	X1																					51	POUT
SUBQ	X2																					50	BLCTL
NC	VDD																					49	DIMMER
SQCK	XKILL																					48	SMUTE
XRST	BEAT																					47	LEDCTL
STAT	+BCTL																					46	PIN
TUDATA(I)	PHOTO1																					45	PBMUTE
TUDATA(O)	BLKCK																					44	LDMUTE
TUCK	RDSCK																					43	FCD
NC	REM																					42	FTU
NC																						41	FAUX
		21	22	23	24	25	26	27	28	29	30	31	32	33	34	35	36	37	38	39	40		
		NC	NC	LCDDB4	LCDDB5	LCDDB6	LCDDB7	E	RS	R/W	NC CDLED	SDATA	SCK	VSS	STTA	PLAY	OPEN	CLOSE	RSDI	MPX	TUST		

UX-V3/UX-V5
UX-V5R/FS-V5

2. Description

Pin No.	symbol	I/O	Description	Pin No.	symbol	I/O	Description
1	KEY	I	Operation key input	41	FAUX	I/O	Tracking error shunt signal output(H:shunt)
2	KEY1	I	Operation key input	42	FTU	I/O	Not used
3	NC	I	Digital GND	43	FCD	I/O	Not used
4	AVSS	I	Digital GND	44	LDMUTE	I/O	RF signal input
5	SCD	I/O		45	PBMUTE	I/O	Reference current input pin
6	REST	I	Rest switch input	46	PIN	I/O	Bias pin for DSL
7	AVREF1	I	Power supply input +5v	47	LEDCTL	I/O	Loop filter pin for DSL
8	MLD	O	μ com command data output				
9	MDATA	O	μ com command data output	48	SMUTE	I/O	Loop filter pin for PLL
10	MCLK	O	μ com command clock signal output (Data is latched at signal's rising point)	49	DIMMER	I/O	Not used
				50	BLCTL	I/O	Power supply(Analog)
11	SUBQ	I	Sub-code Q -code input	51	POUT	I/O	Connected to GND(Analog)
12	NC	-	Not used	52	TRE	I/O	Not used
13	SQCK	O	Outside clock for sub-code Q resister output	53	BASS	I/O	Not used
14	XRST	O	Reset signal output (L:Reset)	54	VOL	I/O	Not used
15	STAT	I	Status signal (CRC,CUE,CLVS,TTSTOP,ECLV,SQOK)	55	AHB	I/O	Not used
				56	MTS	I/O	Not used
16	TUDATA(1)	I	μ com command data input for tunner				
17	TUDATA(O)	O	μ com command data output for tunner	57	MT1	I/O	Connected to GND(for X'tal oscillation circuit)
18	TUCK	O	μ com command clock signal output for tunner	58	MT0	I/O	Input of 16.9344MHz X'tal oscillation circuit
19	NC	-	Not used	59	BUV	I/O	Output of X'tal oscillation circuit
20	NC	-	Not used	60	RESET	I	Power supply(for X'tal cscillation circuit)
21	NC	-	Not used	61	REM	I	Not used
22	NC	-	Not used	62	RDSCK	I/O	Not used
23	LCDDB4	O	LCD driver output signal	63	BLKCK	I/O	Not used
24	LCDDB5	O	LCD driver output signal	64	PHOTO1	I/O	Not used
25	LCDDB6	O	LCD driver output signal				
26	LCDDB7	O	LCD driver output signal	65	+BCTL	I/O	Not used
27	E	O					
28	RS	O		66	BEAT	I/O	Not used
29	R/W	O		67	XKILL	I/O	Not used
30	NC CDLED	I	μ com command data input for cassette	68	VDD	I	Not used
31	SDATA	O	μ com command data output for cassette	69	X2	I	Not used
32	SCK	O	μ com command clock signal output for cassette				
33	VSS	I	Digital GND	70	X1	I	pull up
34	STTA	O	μ com command data output for cassette	71	IC	I	pull up
35	PLAY	I/O	Focus error signal input(Analog input)	72	XT2	I	Power supply(Digital)
36	OPEN	I/O	Tracking error signal input(Analog input)	73	XT1	I	Lch audio output
		I/O	RF envelope signal input(Analog input)	74	AVDD	I	Connected to GND
		I/O	Vibration detect signal input(H:detect)	75	AVREF0	I	Rch audio output
		I/O	Off track signal input(H:off track)	76	SAFTY2	I/O	pull up
37	CLOSE	I/O	Track cross signal input	77	SAFTY1	I/O	Connected to GND
38	RDSDI	I/O	RF detect signal input(L:detect)	78	LOCK	I/O	Connected to GND
39	MPX	I/O	BDO input pin(L:detect)	79	FKEY	I/O	Connected to GND
40	TUST	I/O	Laser ON signal output(H:on)	80	VERSION	I/O	Pull up

■ AN8806SB (IC601) : RF&Servo AMP

1. Terminal Layout

PD	1	36	PDAC
LD	2	35	PDBD
LDON	3	34	PDF
LDP	4	33	PDE
VCC	5	32	PDER
RF-	6	31	PDFR
RF OUT	7	30	TBAL
RF IN	8	29	FBAL
C.AGC	9	28	EF-
ARF	10	27	EF OUT
C.ENV	11	26	TE-
C.EA	12	25	TE OUT
CS BDO	13	24	CROSS
BDO	14	23	TE BPF
CS BRT	15	22	VDET
OFTR	16	21	LD OFF
/NRFDDET	17	20	VREF
GND	18	19	ENV

2. Block Diagram

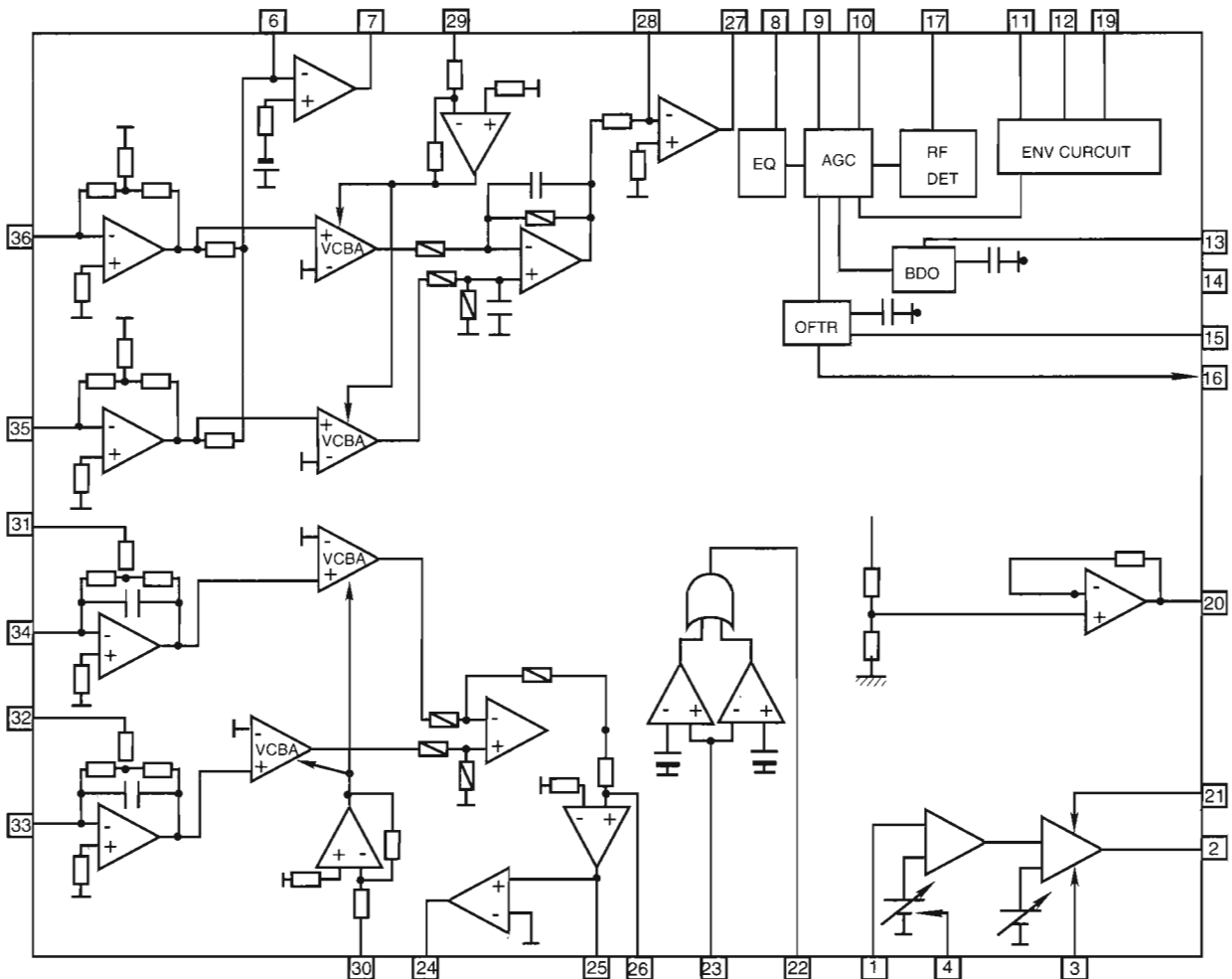

UX-V3/UX-V5
UX-V5R/FS-V5

3. Functions

Pin No.	Symbol	I/O	Functions and operations
1	PD	I	APC amp input terminal
2	LD	O	APC amp output terminal
3	LD ON	I	APC ON/OFF control terminal
4	LDP	--	Connect to ground
5	VCC	--	Power supply
6	RF-	I	Inverse input pin for RF amp
7	RF OUT	O	RFamp output
8	RF IN	I	RF input
9	C.AGC	I/O	Connecting pin of AGC loop filter
10	ARF	O	RF output
11	C.ENV	I/O	A capacitor is connected to this terminal to detect the envelope of RF signal
12	C.EA	I/O	A capacitor is connected to this terminal to detect the envelope of RF signal
13	CS BDO	I/O	A capacitor is connected to detect the lower envelope of RF signal
14	BDO	O	BDO output pin
15	CS BRT	I/O	A capacitor is connected to detect the lower envelope of RF signal
16	OFTR	O	Of-track status signal output
17	/NRFDDET	O	RF detection signal output
18	GND	--	Ground
19	ENV	O	Envelope output
20	VREF	O	Reference voltage output
21	LD OFF	--	Connect to ground
22	VDET	O	Vibration detection signal output
23	TE BPF	I	Input pin of tracking error through BPF
24	CROSS	O	Tracking error cross output
25	TE OUT	O	Tracking error signal output
26	TE-	I	Inverse input pin for tracking error amp
27	FE OUT	O	Output pin of focus error
28	FE-	I	Inverse input pin for focus error amp
29	FBAL	I	Focus balance control
30	TBAL	I	Tracking balance control
31	PDFR	I/O	F I-V amp gain control
32	PDER	I/O	E I-V amp gain control
33	PDF	I	I-V amp input
34	PDE	I	I-V amp input
35	PD BD	I	I-V amp input
36	PD AC	I	I-V amp input

■ BA6897FPW(IC602):4channel driver

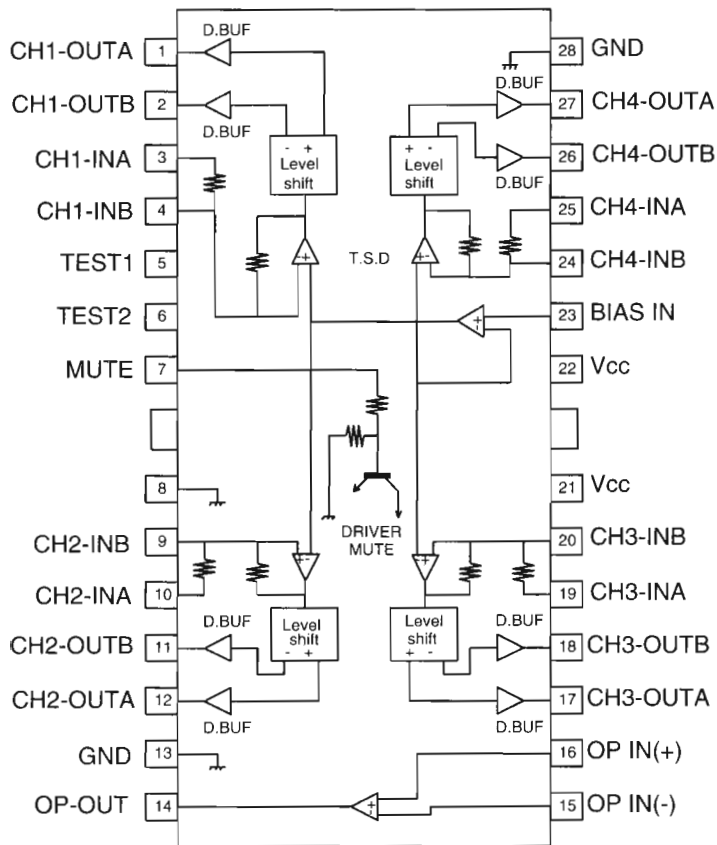

■ BH3852S (IC305) : E.VOLUME

1. Block Diagrams

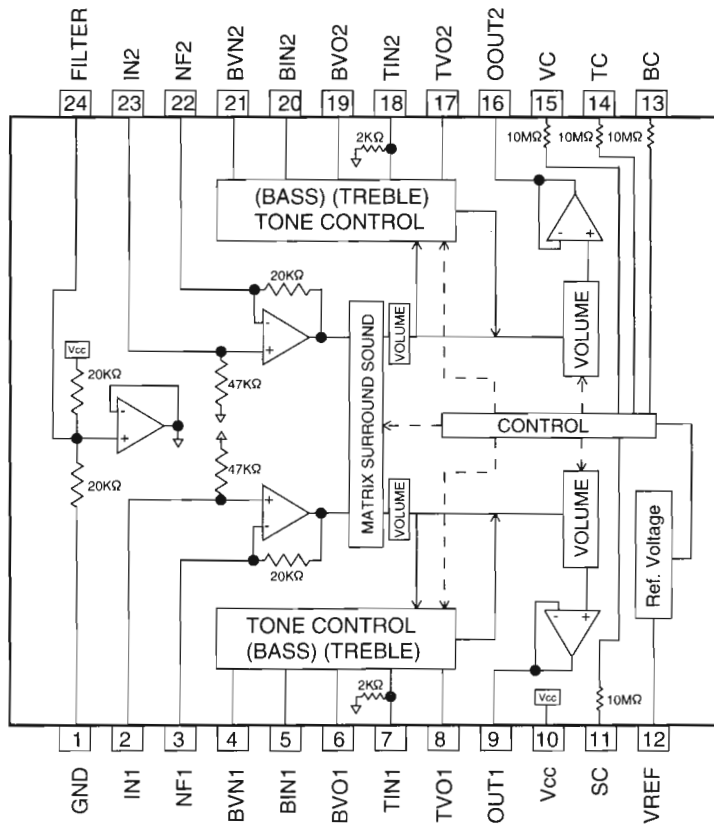

2. Pin Function

Pin No.	Symbol	I/O	Function	Pin No.	Symbol	I/O	Function
1	GND	-	Connect to GND.	13	BASS	I	Terminal for bass control.
2	IN1	I	Terminal for 1ch volume input.	14	TRE	I	Terminal for treble control.
3	NF1	I	Terminal for gain adjustment of input step AMP.	15	VOL	I	Terminal for volume control.
4~6	BASS1	-	Terminal for connection of 1ch low-frequency filter.	16	OUT2	O	Terminal for 2ch volume output.
7.8	TRE1	-	Terminal for connection of 1ch high-frequency filter.	17.18	TRE2	-	Terminal for connection of 2ch high-frequency filter.
9	OUT1	O	Terminal for 1ch volume output.	19~21	BASS2	-	Terminal for connection of 2ch low-frequency filter.
10	VCC	-	Terminal for power supply.	22	NF2	I	Terminal for gain adjustment of input step AMP.
11	LIVE	-	Terminal for surround control.	23	IN2	I	Terminal for 2ch volume input.
12	VREF	O	Terminal for reference voltage output.	24	VSET	-	Terminal for filter.

■ LA4705NA (IC301) : 2ch BTL power IC

1. Pin layout

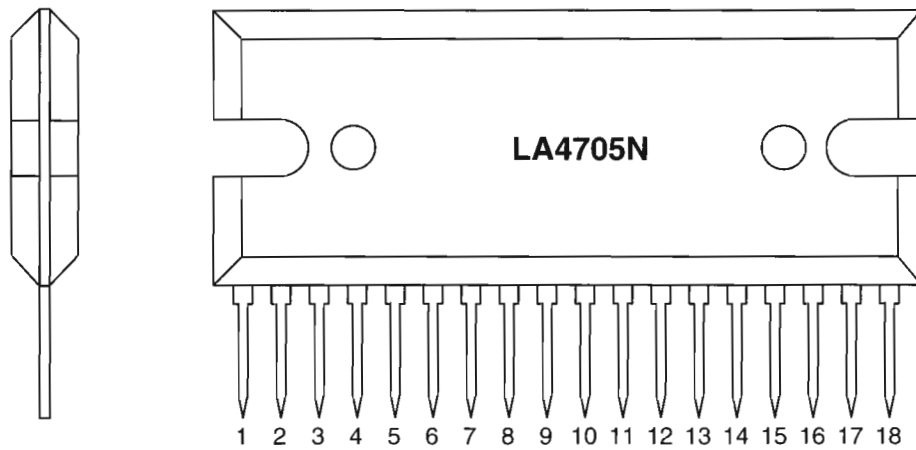

2. Block diagram

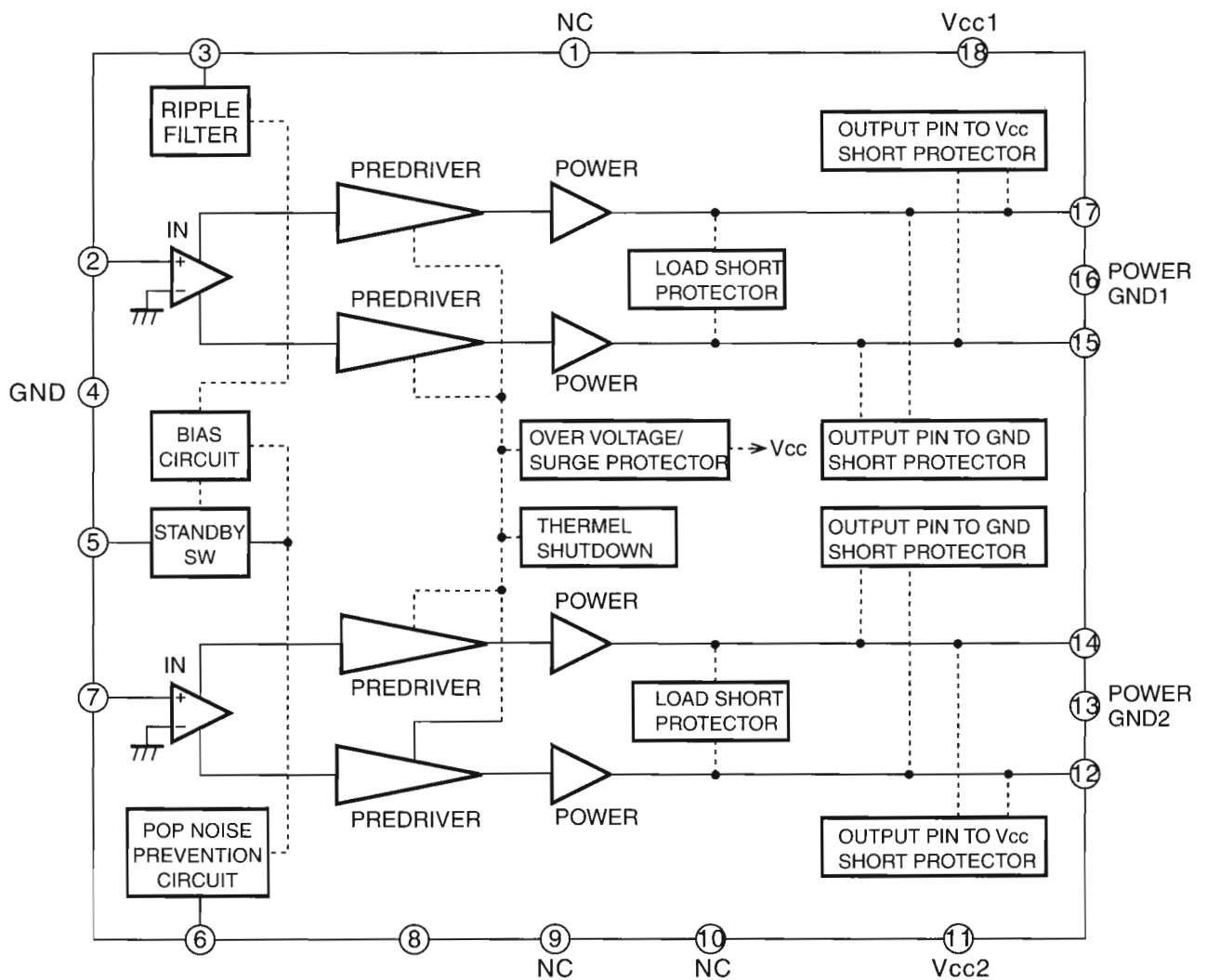

■ NJM4580L (IC302) : BASS Boost Amp.

1. Terminal Layout

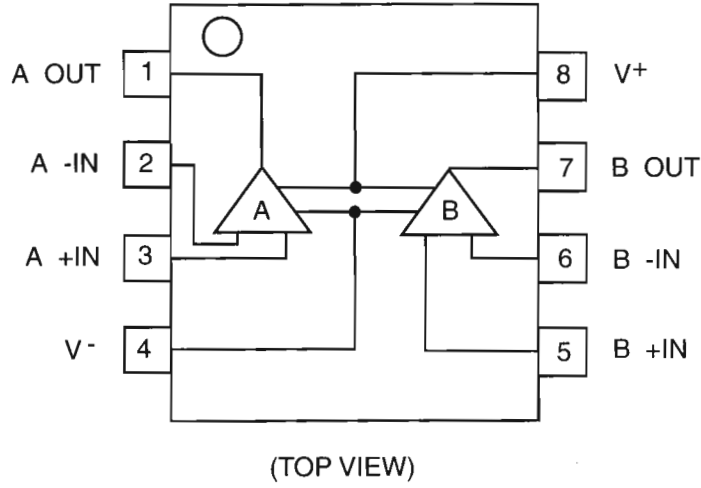

CONNECTION INFORMATION

2. Block Diagram

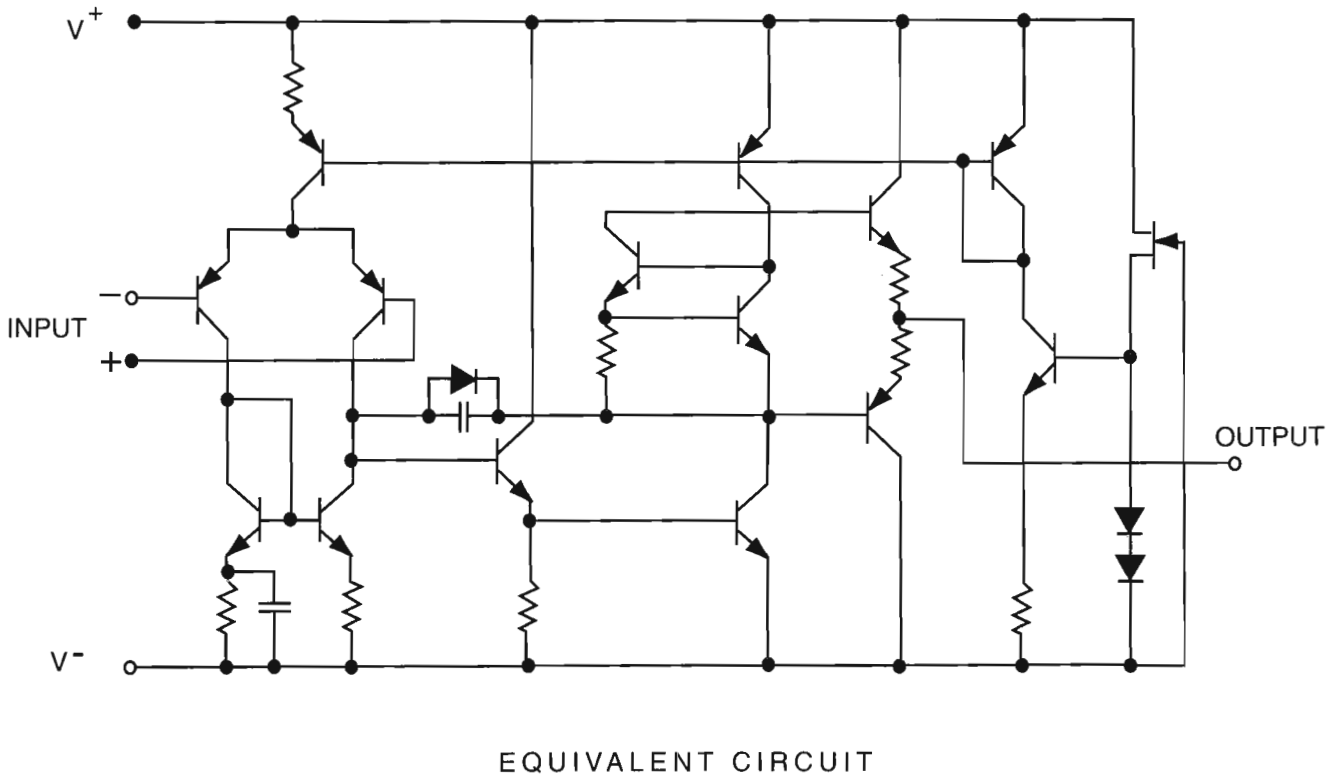

INPUT NOISE VOLTAGE MEASUREMENT CIRCUIT

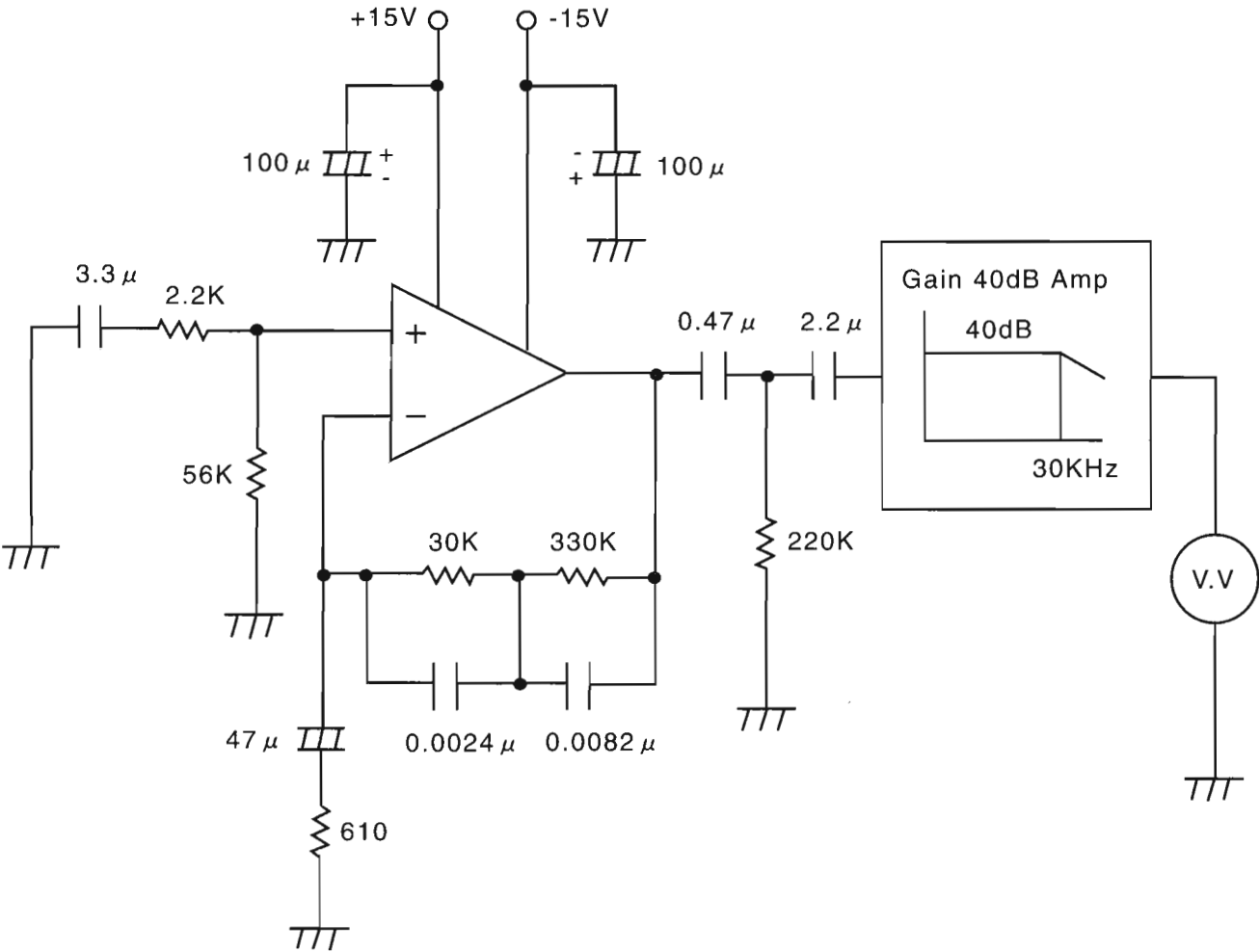

■ TA8409S (IC308) : Motor Driver

1. Block Diagram

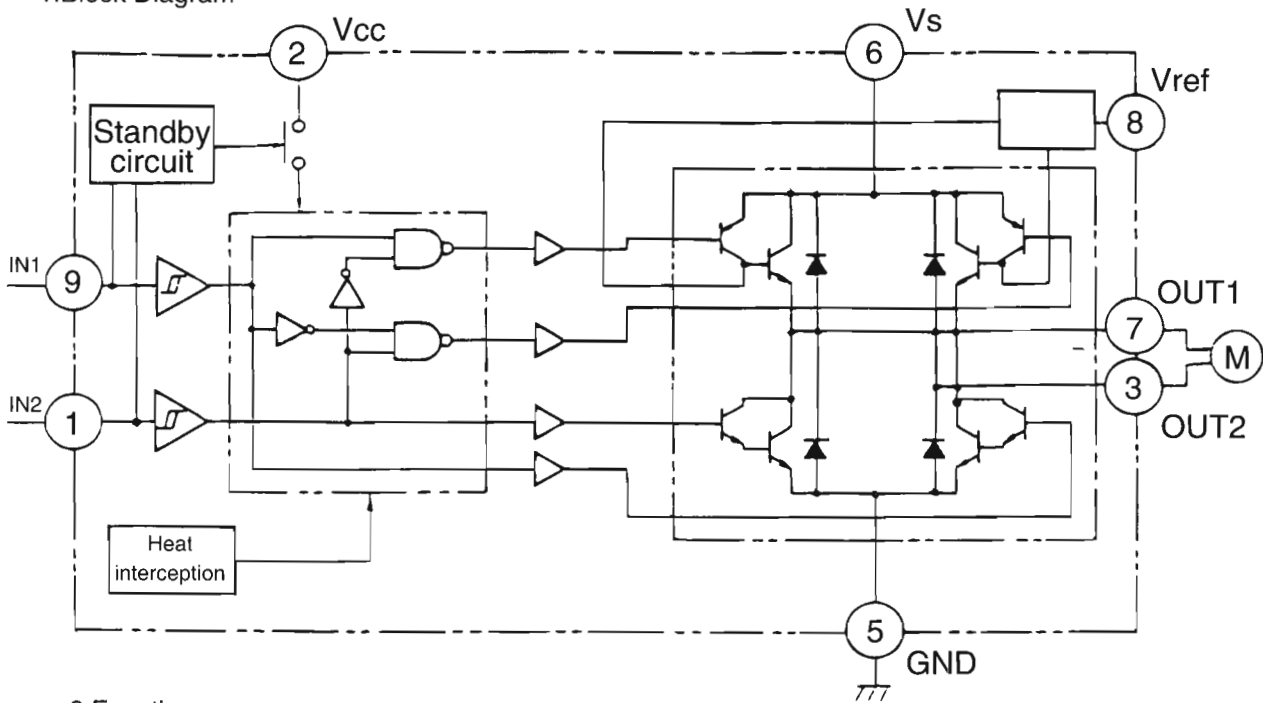

2. Function

INPUT		OUTPUT		MODE
IN1	IN2	OUT1	OUT2	MOTOR
0	0	∞	∞	STOP
1	0	H	L	CW/CCW
0	1	L	H	CCW/CW
1	1	L	L	BRAKE

Block Diagram

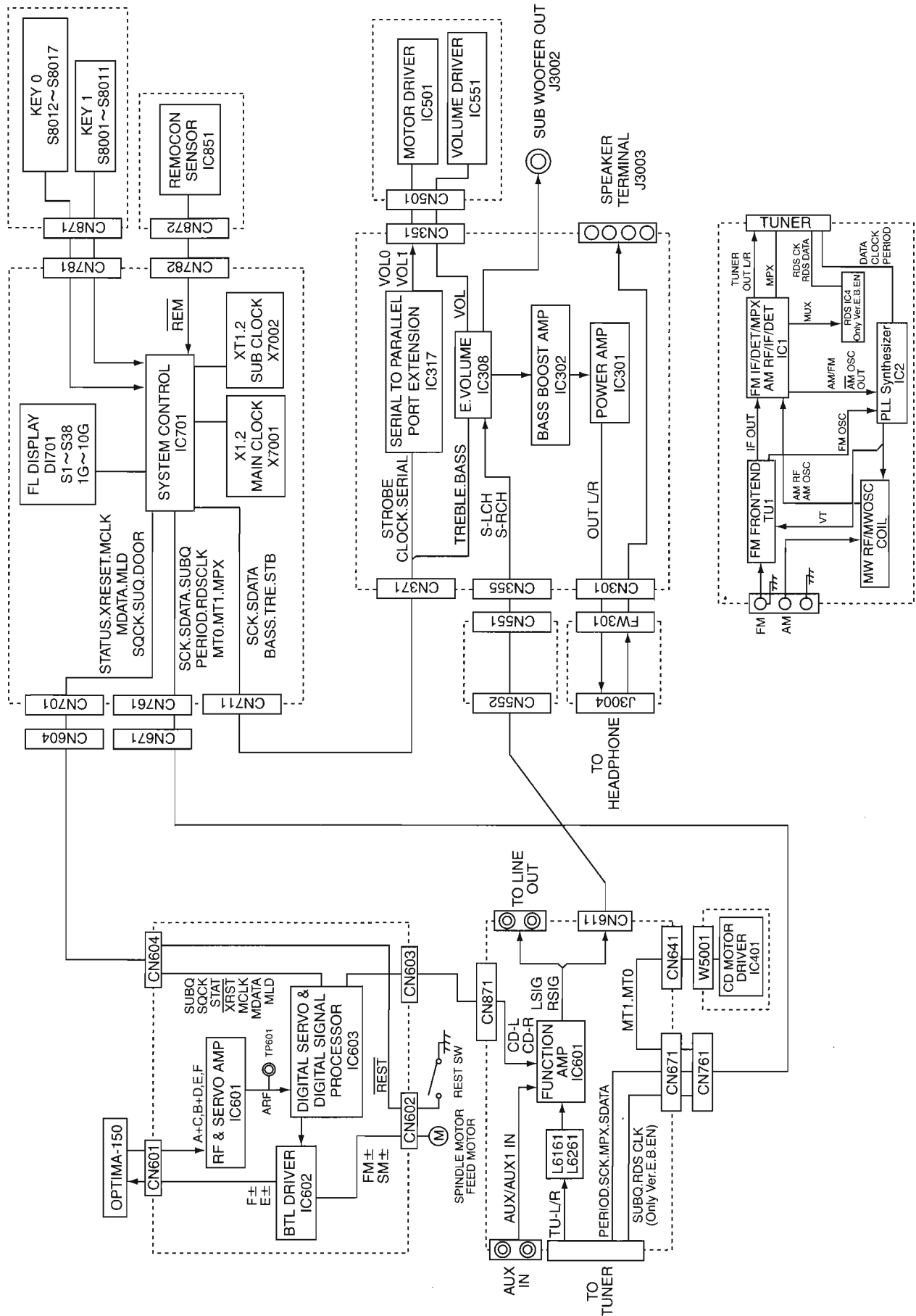

UX-V3/UX-V5
UX-V5R/FS-V5

<<MEMO>>

Standard Schematic Diagrams

■ Display Circuit for UX-V3/V5/V5R/FS-V5

6

5

4

3

2

1

A

B

C

D

E

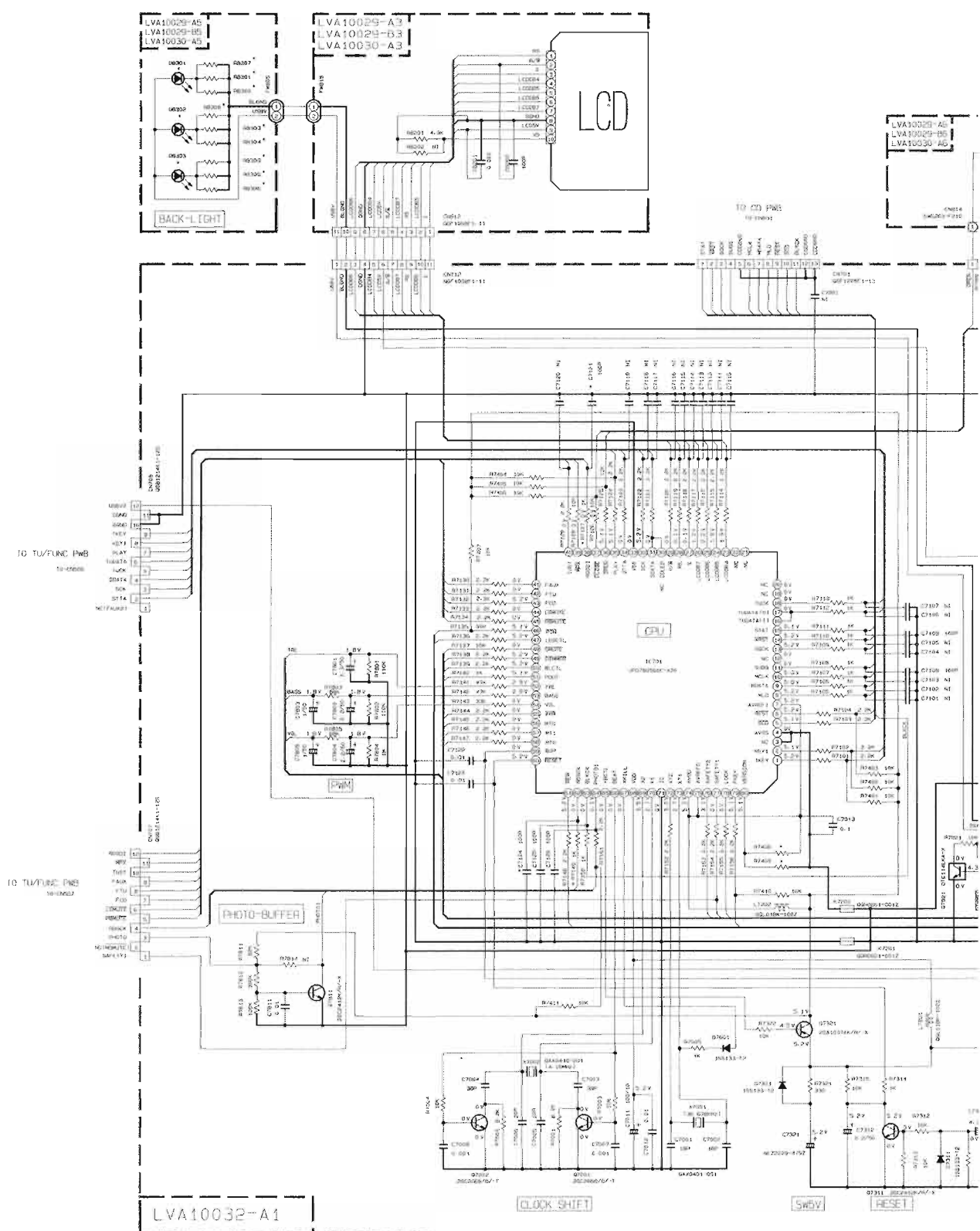

- NOTES
1. VOLTAGES ARE (CH) MEASURED WITH A DIGITAL VOLT METER OR OSCILLOSCOPE WITHOUT DATA SIGNAL.
CONDITION: IC3011, IC3012, IC3013
 2. UNLESS OTHERWISE SPECIFIED:
ALL RESISTORS ARE 1/10W 40X METAL GLAZE RESISTOR.
ALL CAPACITORS ARE CERAMIC CAPACITOR (EXCEPT MYLAR CAPACITOR).
ALL RESISTANCE VALUES ARE IN OHMS(Ω).
ALL CAPACITANCE VALUES ARE IN nF(NP-F).
ALL INDUCTANCE VALUES ARE IN mH(MHMMH).
ALL 5.6 CAPACITORS ARE 500VDC IN THE FORM OF CAPACITANCE(47) RATED VOLTAGE (47).

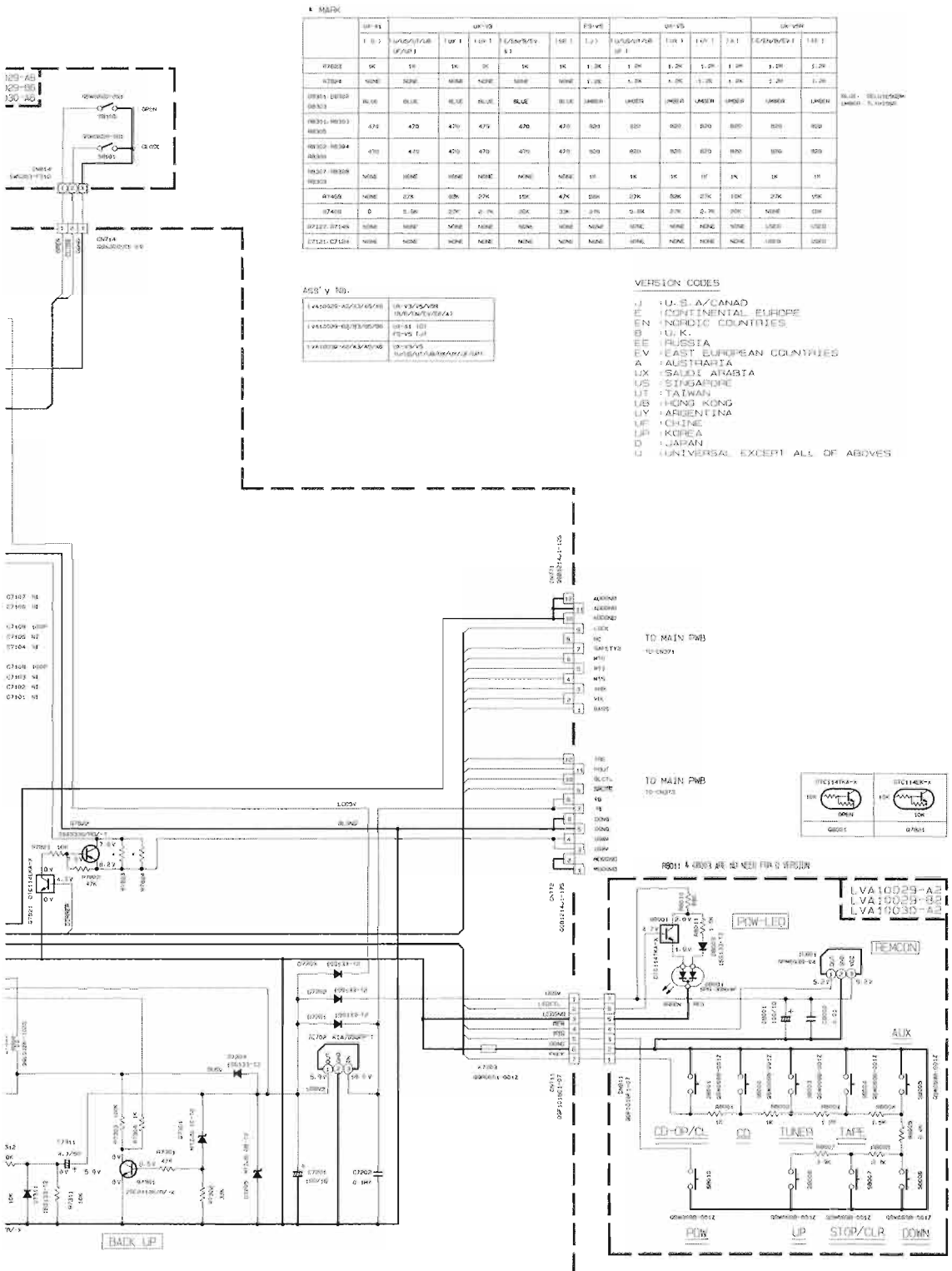
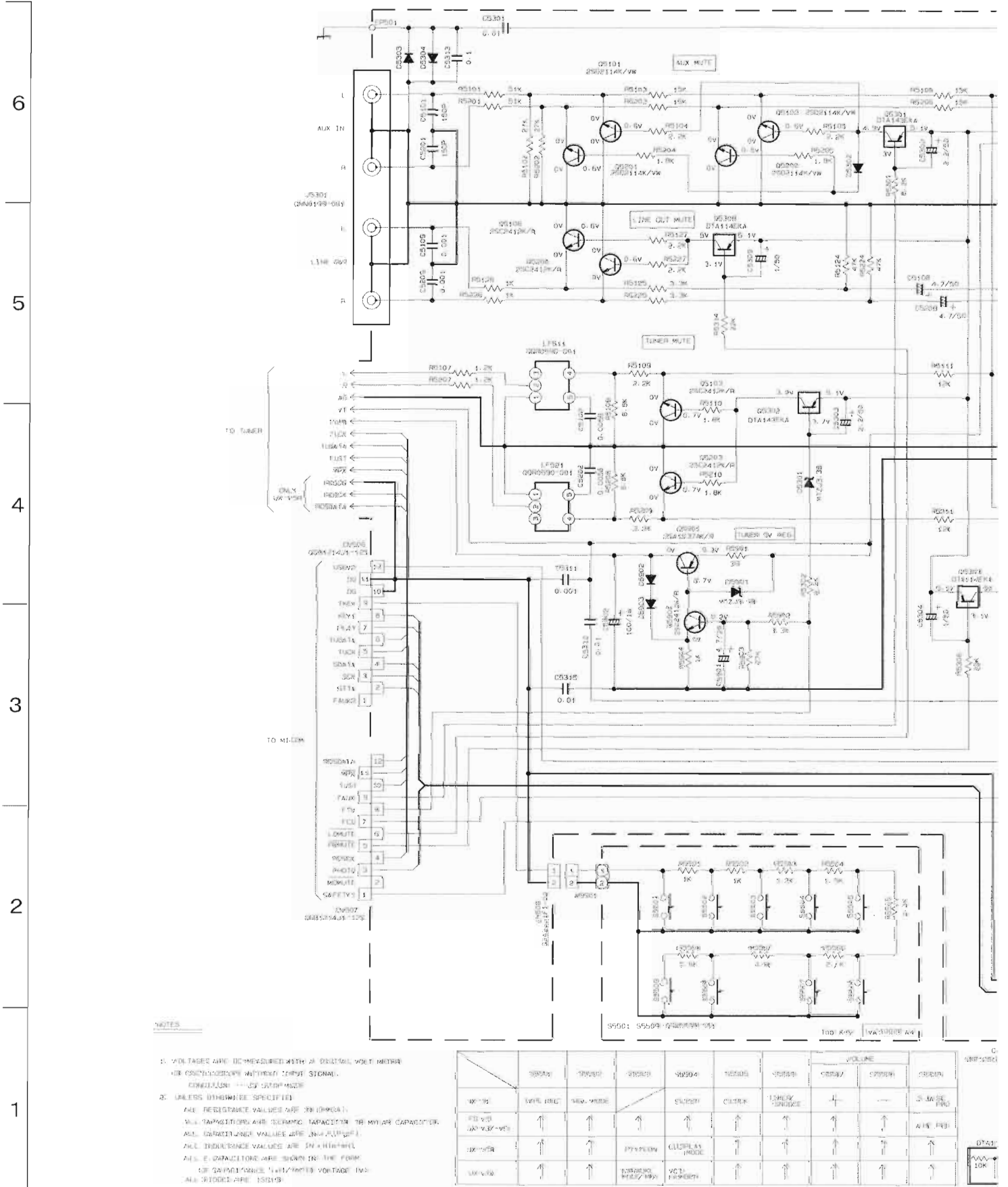
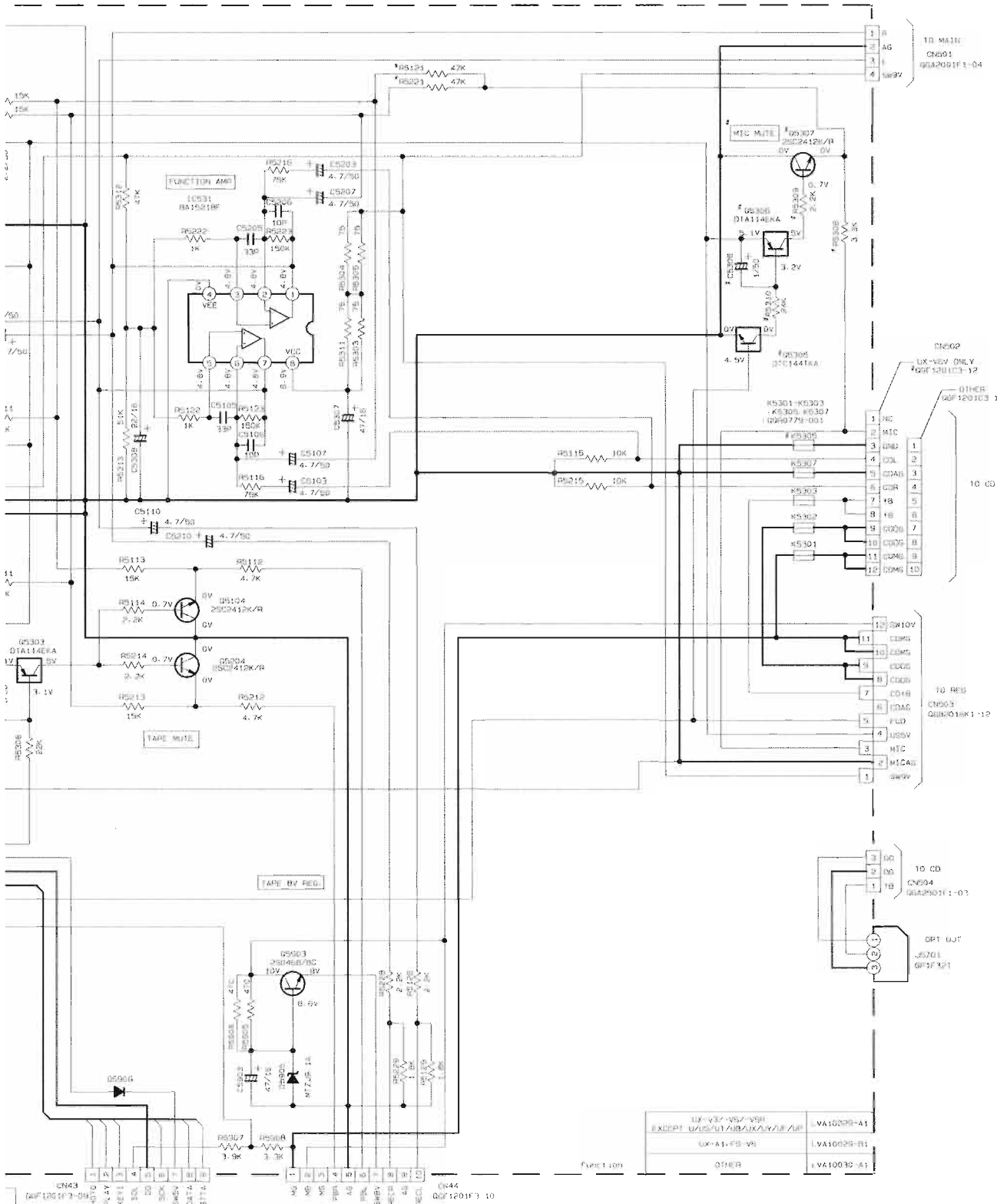

TABLE IV.1. THIS DRAWING HAS BEEN P

■ Analog input Circuit for UX-V3/V5/V5R/FS-V5



UX-V3/UX-V5
UX-V5R/FS-V5



* : ONLY U/US/UT/UB/UX/UY/UF/UP
: ONLY UX-V6V

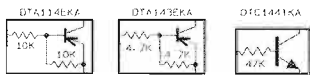

UX-V3~V5~V5R	VA10029-A1
EXCEPT U/US/UT/UB/UX/UY/UF/UP	
UX-V1~FS-V6	VA10029-B1
OTHER	VA10030-A1

CD Servo Circuit

6

5

4

3

2

1

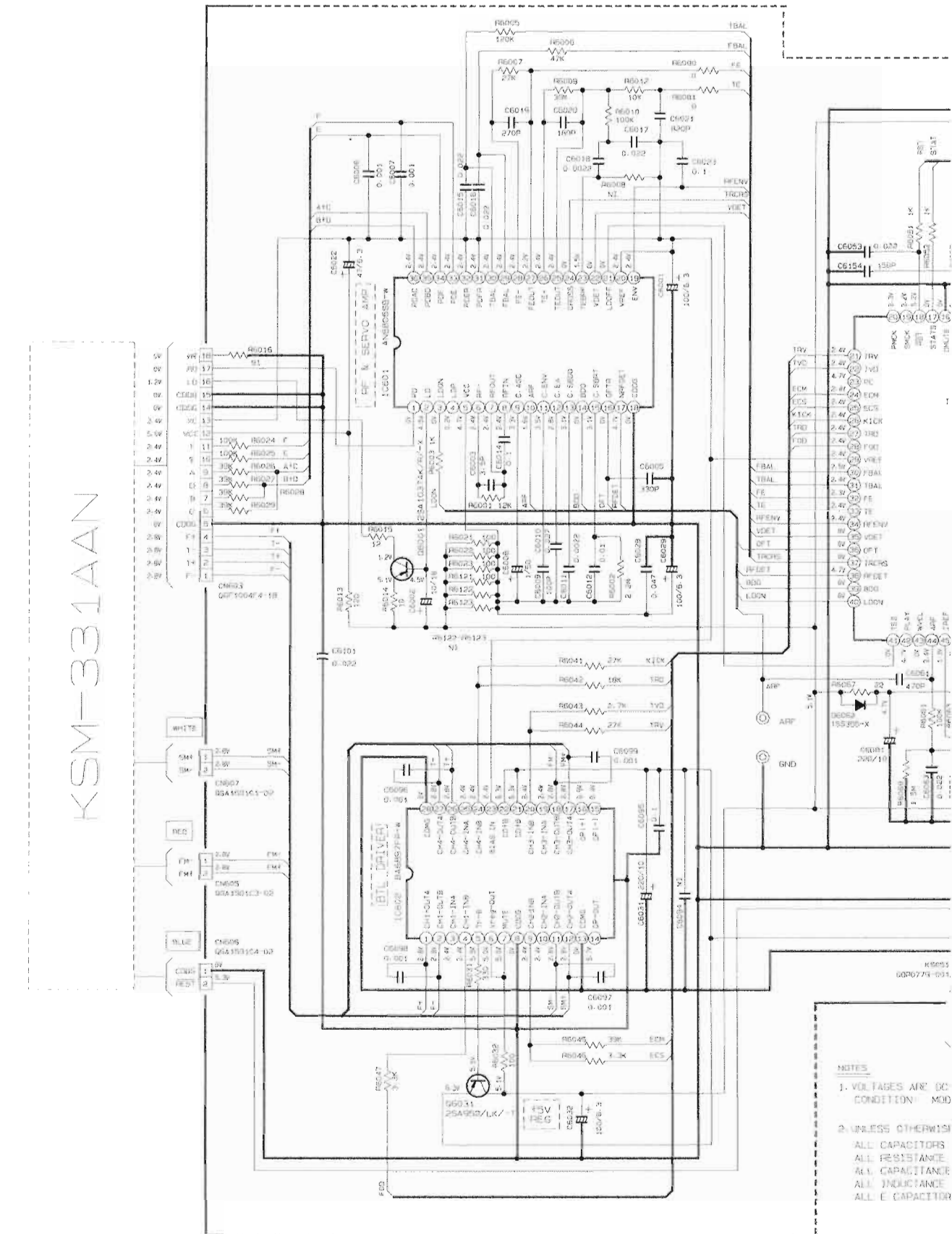

KSM-331AAN

- NOTES**
1. VOLTAGES ARE DC CONDITION MOD
 2. UNLESS OTHERWISE ALL CAPACITORS ALL RESISTANCE ALL CAPACITANCE ALL INDUCTANCE ALL E CAPACITOR

A B C D E

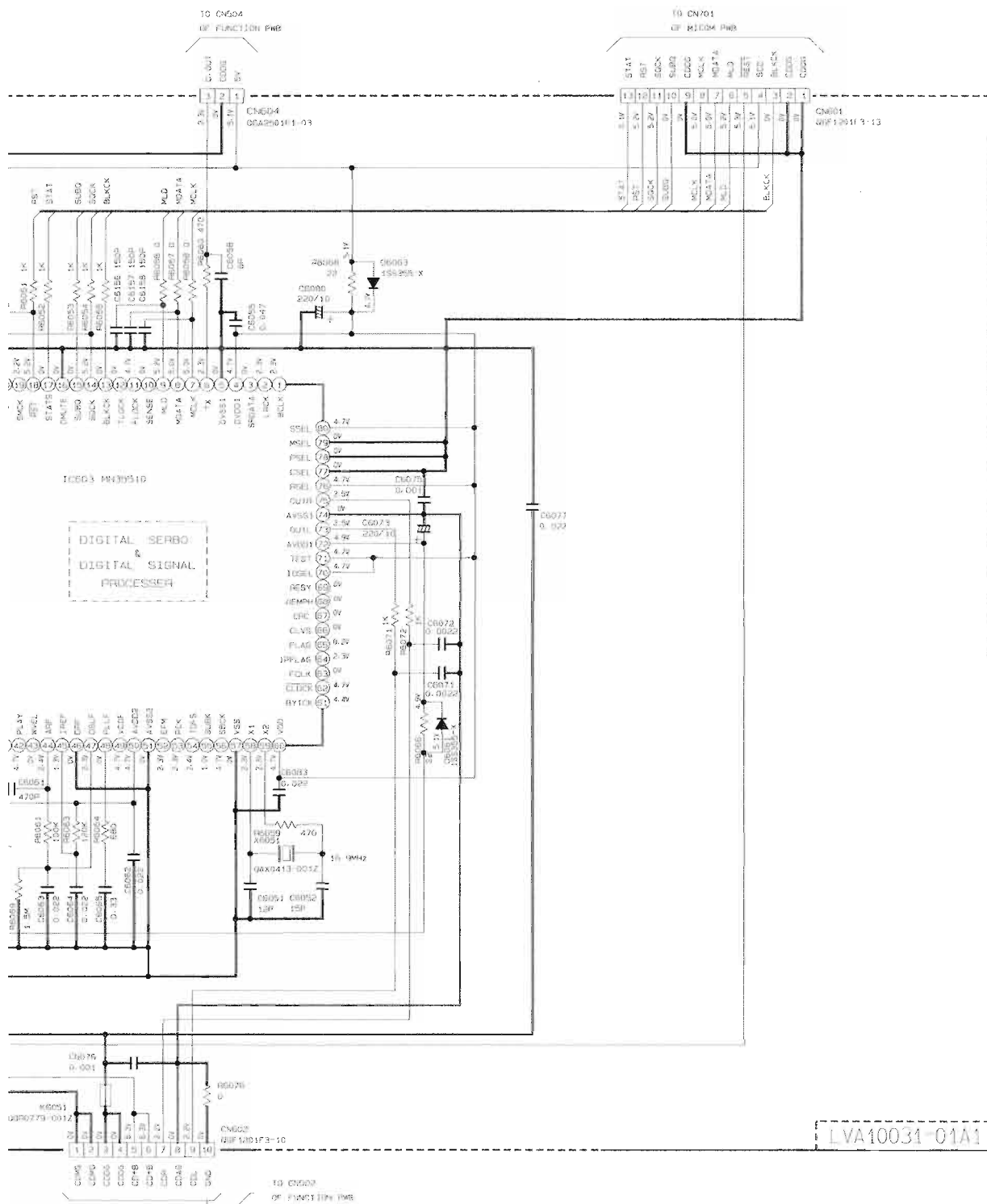

S ARE DC-MEASURED WITH A DIGITAL VOLT METER
ON: MODE STOP
OTHERWISE SPECIFIED.
CAPACITORS ARE 50V CERAMIC CAPACITOR OR 50V MYLAR CAPACITOR.
RESISTANCE VALUES ARE IN OHM (Ω).
CAPACITANCE VALUES ARE IN MICROFARAD (μF).
INDUCTANCE VALUES ARE IN HENRY (H).
CAPACITORS ARE SHOWN IN THE FORM OF CAPACITANCE (μF)/RATED VOLTAGE (V).

■ Power Amplifier Circuit for UX-V3/V5/V5R/FS-V5

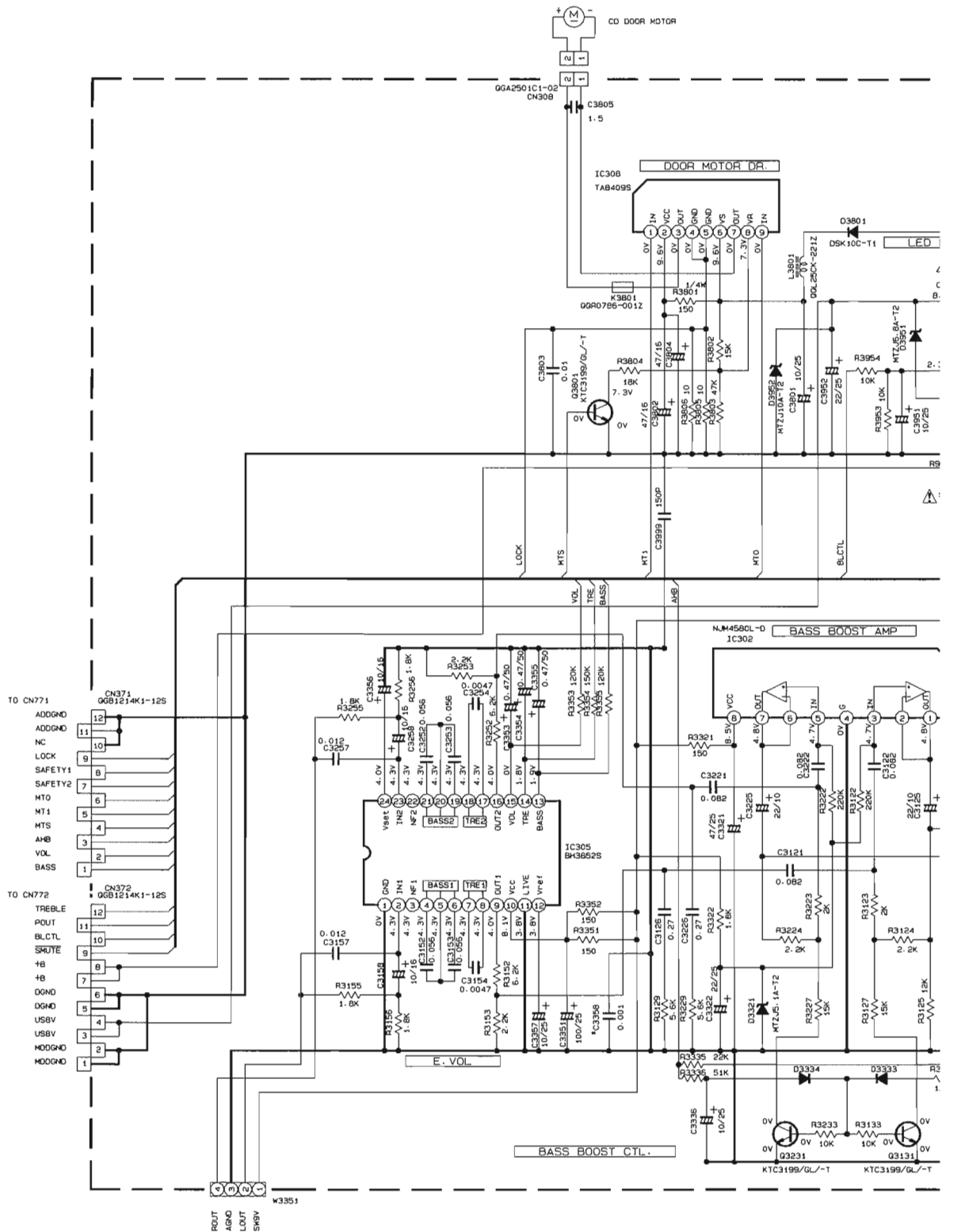

NOTES

1. VOLTAGES ARE DC-MEASURED WITH A DIGITAL VOLT METER OR OSCILLOSCOPE WITHOUT INPUT SIGNAL. CONDITION --- FUNC. CD STOP MODE

2. UNLESS OTHERWISE SPECIFIED
ALL RESISTANCE VALUES ARE IN OHM(Ω).
ALL CAPACITORS ARE CERAMIC CAPACITOR OR MYLAR CAP
ALL CAPACITANCE VALUES ARE IN μ F(μ P=F).
ALL INDUCTANCE VALUES ARE IN μ H(μ M=MH).
ALL E. CAPACITORS ARE SHOWN IN THE FORM OF CAPACIT
ALL DIODES ARE 1SS133

6
5
4
3
2
1

A B C D E

UX-V3/UX-V5
UX-V5R/FS-V5

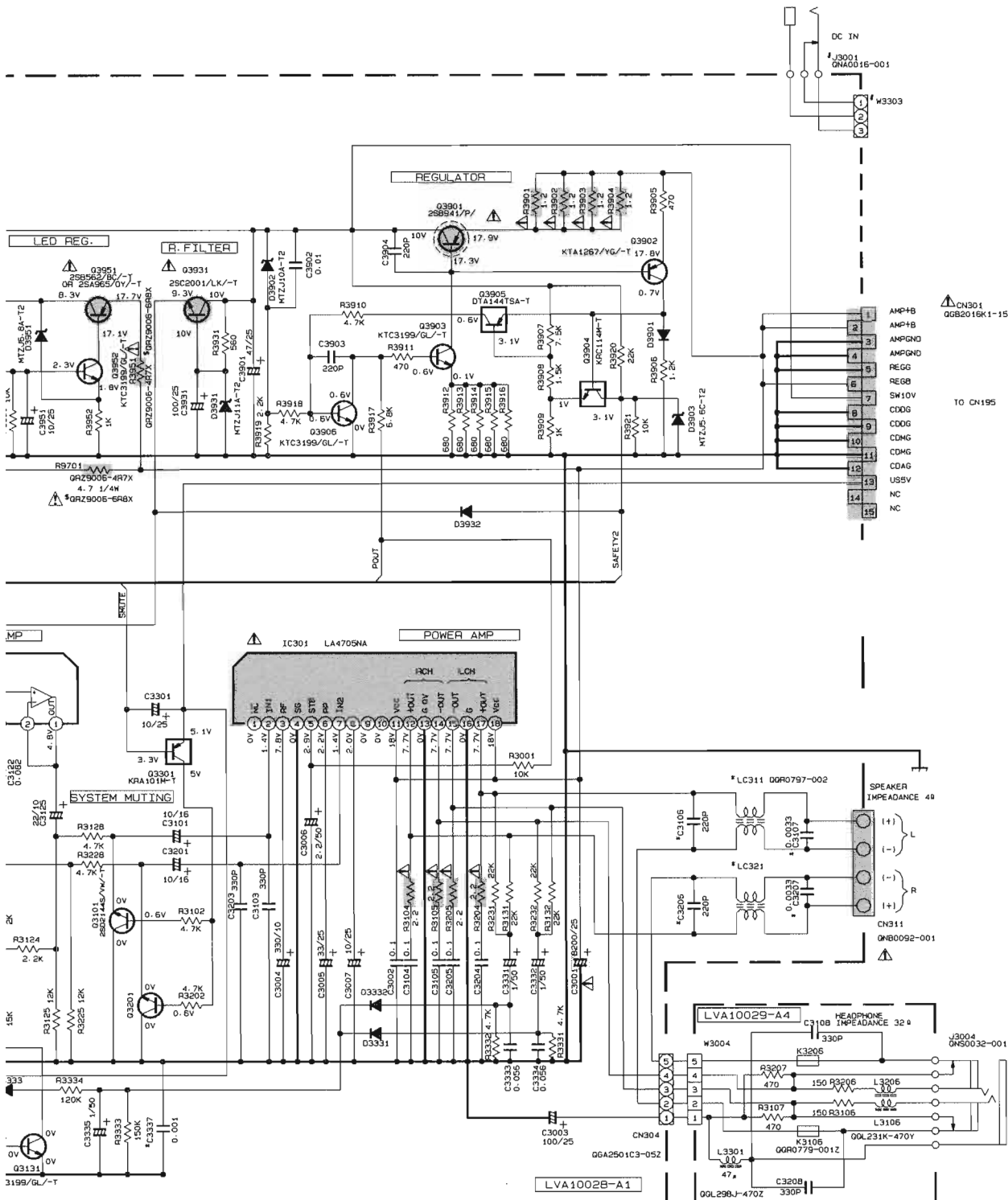

* : E/EN/B/EE/EV/A ONLY
: EN ONLY

\$: FS-V5 ONLY

MYLAR CAPACITOR.

F CAPACITANCE (μF)/RATED VOLTAGE (V).



Parts are safety assurance parts.
When replacing those parts make
sure to use the specified one.

Tuner Circuit for UX-V3/V5/FS-V5

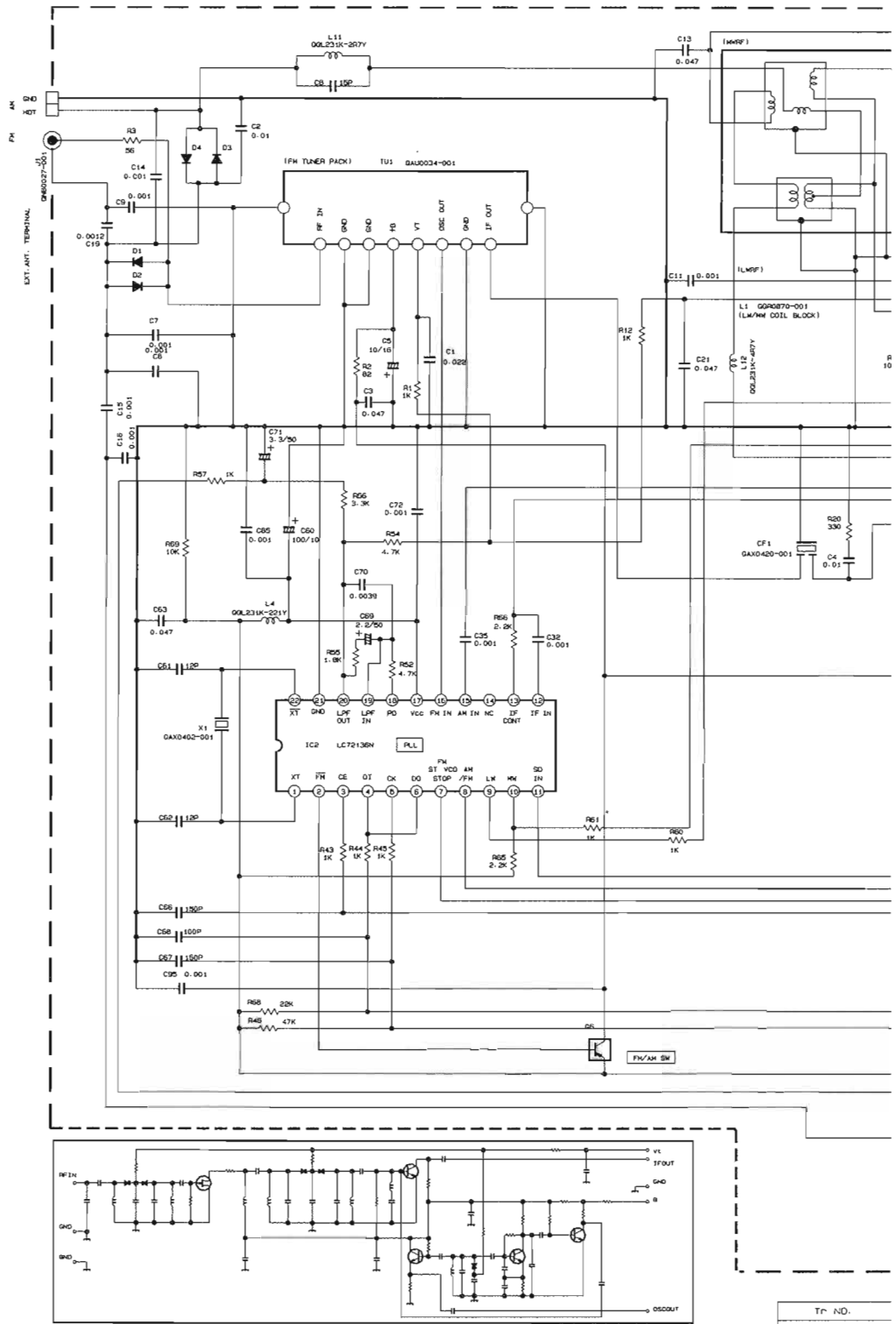

CONDITION	PIN NO.	1	2	3	4	5	6	7	8	9	10	11	12	13	14	15	16	17	18	19	20	21	22	23	24
IC1	FM NO SIGNAL	2.0	0.5	0	2.0	5.1	5.1	0	0	0.3	5.1	5.1	1.1	1.1	4.4	3.7	3.7	1.4	0	1.3	1.1	2.0	2.0	5.1	2.0
IC1	FM 600B STEREO	2.0	0.5	0	2.0	5.1	5.1	1.1	0	0.3	0	0	1.1	1.1	4.3	4.1	3.7	1.4	0	1.4	1.1	2.0	2.0	5.1	2.0
IC1	AM NO SIGNAL	2.0	0.5	0	2.0	5.0	5.1	0	0	0.3	5.1	5.1	1.1	1.1	4.5	0.1	0	1.4	1.4	1.5	1.6	2.0	2.0	5.1	2.0
IC2	FM NO SIGNAL	2.4	0	0	5.1	5.0	5.1	3.7	3.7	2.0	3.8	5.1	0	0	0	0	2.6	5.1	1.0	1.0	3.7	0	2.7		
IC4	FM NO SIGNAL	2.0	2.5	2.5	2.5	5.0	0	2.5	2.5	0	0	0	5.0	2.4	2.4	2.5	2.5								

Tr. NO.	PIN NO.
FM 87.5KHZ NO SIGNAL	
AM 522KHZ NO SIGNAL	
Tr. NO.	
PIN NO.	
AM 522KHZ NO SIGNAL	
AM 144KHZ NO SIGNAL	

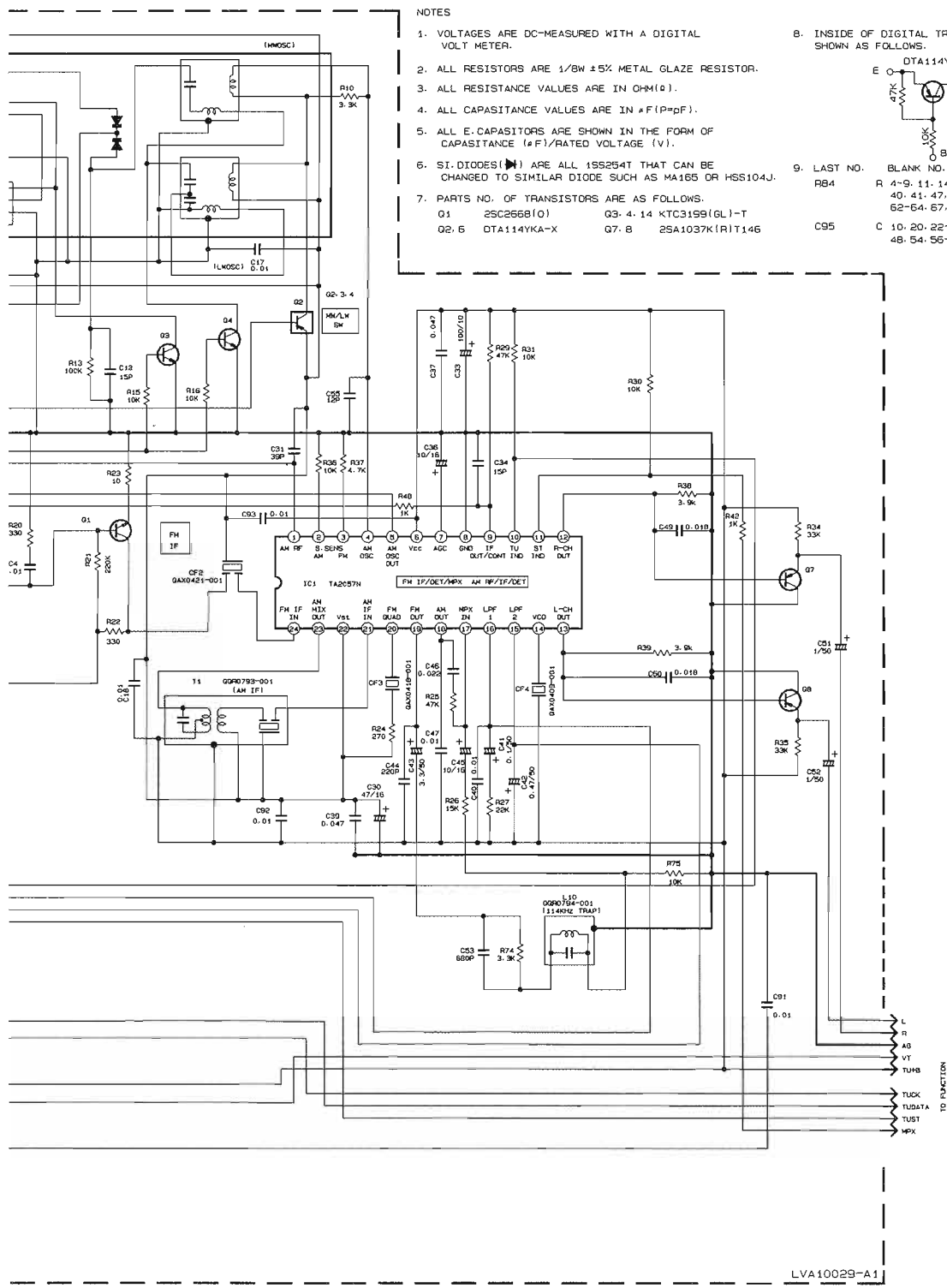

NOTES

1. VOLTAGES ARE DC-MEASURED WITH A DIGITAL VOLT METER.
2. ALL RESISTORS ARE 1/8W ±5% METAL GLAZE RESISTOR.
3. ALL RESISTANCE VALUES ARE IN OHM(Ω).
4. ALL CAPACITANCE VALUES ARE IN P(P=pF).
5. ALL E. CAPACITORS ARE SHOWN IN THE FORM OF CAPACITANCE (pF)/RATED VOLTAGE (V).
6. SI. DIODES(▷) ARE ALL 1S9254T THAT CAN BE CHANGED TO SIMILAR DIODE SUCH AS MA165 OR HSS104J.
7. PARTS NO. OF TRANSISTORS ARE AS FOLLOWS:
Q1 25C2668(O) Q3-4-14 KTC3199(GL)-T
Q2-6 DTA114YKA-X Q7-8 2SA1037K(R)T146
8. INSIDE OF DIGITAL TRANSISTORS ARE SHOWN AS FOLLOWS:
E O C
47K 10K
O B
9. LAST NO. BLANK NO.
R 4-9, 11, 14, 17-19, 26, 32, 33
40, 41, 47, 49-51, 53, 58, 59
62-64, 67, 70-73, 77-79, 81
C 10, 20, 22-29, 38
48, 54, 56-59, 64, 73-79, 87, 88

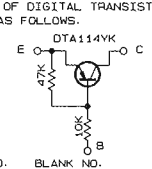

LVA10029-A1

NO.	Q1			Q2			Q3			Q4		
	E	C	B	E	C	B	E	C	B	E	C	B
IZ NO SIGNAL	0	7.5	0.7	B. B	B. 7	0	1.6	0	1.1	1.6	0	1.1
NO SIGNAL	0	0	0	B. B	0	B. 7	1.6	0	1.1	1.6	0	1.1
NO.	Q2			Q3			Q4					
NO.	E	C	B	E	C	B	E	C	B			
NO SIGNAL	2.0	2.0	0.1	0	0	0.7	0	0	0.7			
NO SIGNAL	2.0	2.0	2.0	0	0	0.1	0	0	0.1			

E/B/EN/EV/A

■ Tuner Circuit for UX-V5R

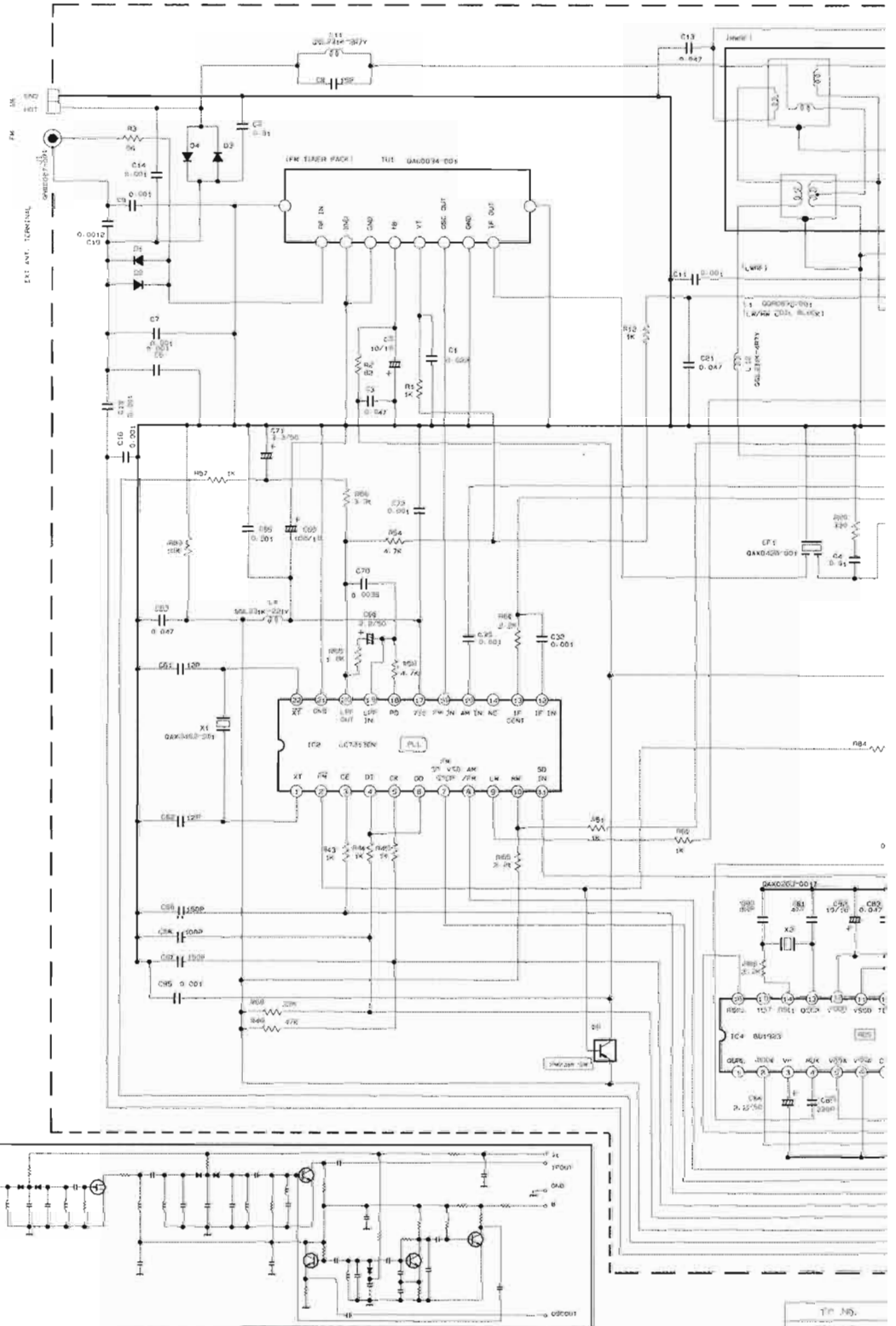

CONSTITUTION PIN NO.		1	2	3	4	5	6	7	8	9	10	11	12	13	14	15	16	17	18	19	20	21	22	23	24
IC1	FM NO SIGNAL	0.0	0.0	0.0	2.0	5.1	5.1	0	0	0.3	5.1	5.1	1.1	3.1	4.4	3.7	2.7	1.4	0	1.3	1.3	2.0	2.0	5.1	2.0
	FM GOOD SYRRE	2.0	3.0	0	2.0	5.1	5.1	1.1	0	0.3	0	0	1.1	1.1	4.3	4.1	3.7	1.4	0	1.4	1.3	2.0	2.0	5.1	2.0
	AM NO SIGNAL	2.0	1.5	0	2.0	5.0	5.1	0	0	0.3	5.1	5.1	1.1	1.1	4.5	0.1	0	1.4	1.4	1.3	1.3	2.0	2.0	5.1	2.0
IC2	FM NO SIGNAL	0.0	0	0	0	0	0	0	0	0	0	0	0	0	0	0	0	0	0	0	0	0	0	0	0
	FM NO SIGNAL	0.0	0	0	0	0	0	0	0	0	0	0	0	0	0	0	0	0	0	0	0	0	0	0	0
	FM NO SIGNAL	0.0	0	0	0	0	0	0	0	0	0	0	0	0	0	0	0	0	0	0	0	0	0	0	0

PIN NO.		1	2	3	4	5	6	7	8	9	10	11	12	13	14	15	16	17	18	19	20	21	22	23	24
IC3	FM NO SIGNAL	0.0	0.0	0.0	2.0	5.1	5.1	0	0	0.3	5.1	5.1	1.1	3.1	4.4	3.7	2.7	1.4	0	1.3	1.3	2.0	2.0	5.1	2.0
	FM GOOD SYRRE	2.0	3.0	0	2.0	5.1	5.1	1.1	0	0.3	0	0	1.1	1.1	4.3	4.1	3.7	1.4	0	1.4	1.3	2.0	2.0	5.1	2.0
	AM NO SIGNAL	2.0	1.5	0	2.0	5.0	5.1	0	0	0.3	5.1	5.1	1.1	1.1	4.5	0.1	0	1.4	1.4	1.3	1.3	2.0	2.0	5.1	2.0
IC4	FM NO SIGNAL	0.0	0	0	0	0	0	0	0	0	0	0	0	0	0	0	0	0	0	0	0	0	0	0	0
	FM NO SIGNAL	0.0	0	0	0	0	0	0	0	0	0	0	0	0	0	0	0	0	0	0	0	0	0	0	0
	FM NO SIGNAL	0.0	0	0	0	0	0	0	0	0	0	0	0	0	0	0	0	0	0	0	0	0	0	0	0

A

B

C

D

E

UX-V3/UX-V5
UX-V5R/FS-V5

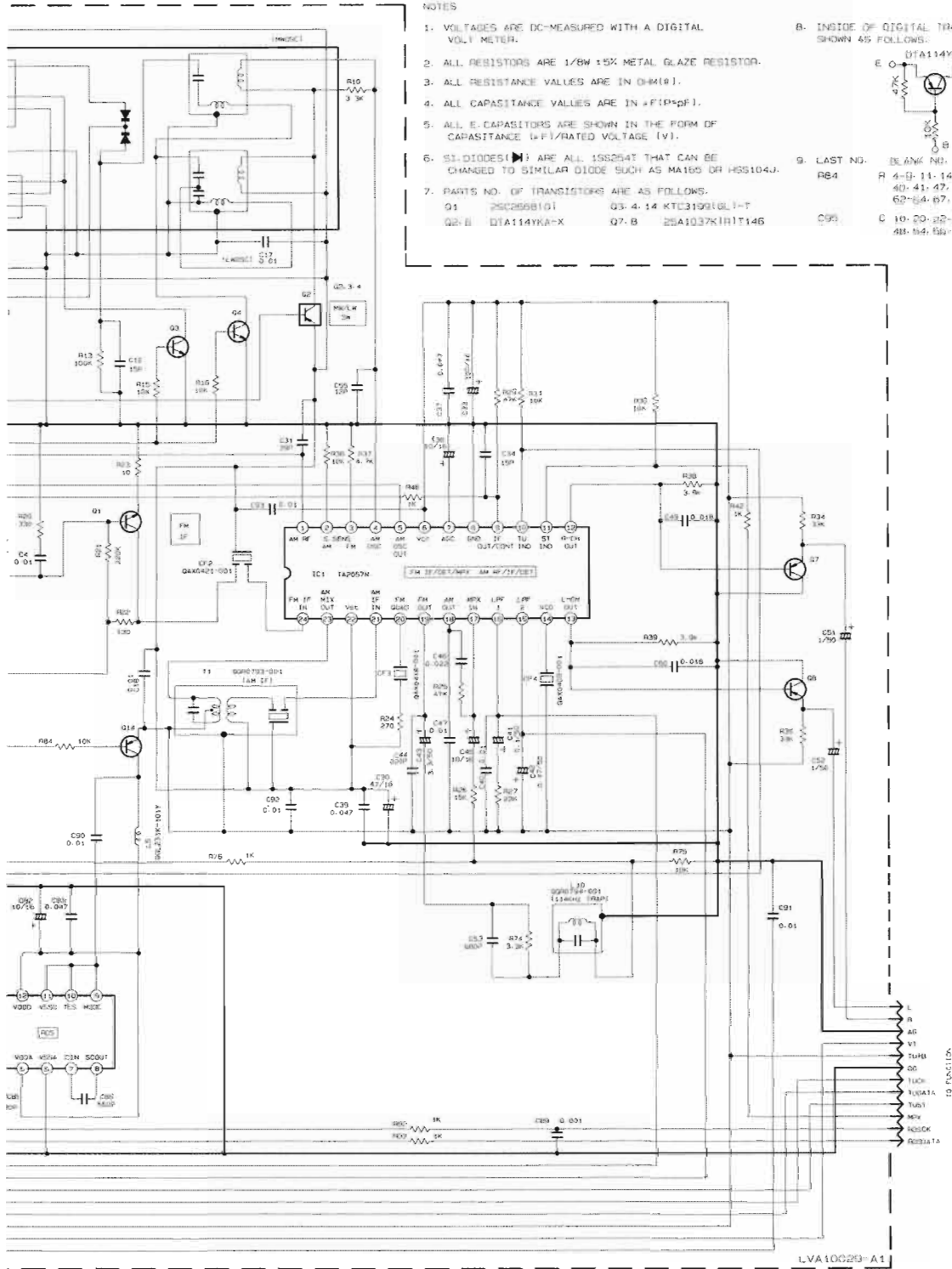

NOTES

1. VOLTAGES ARE DC-MEASURED WITH A DIGITAL VOLT METER.
2. ALL RESISTORS ARE 1/8W ±5% METAL GLAZE RESISTOR.
3. ALL RESISTANCE VALUES ARE IN OHMS (Ω).
4. ALL CAPACITANCE VALUES ARE IN PICO (pF).
5. ALL E-CAPACITORS ARE SHOWN IN THE FORM OF CAPACITANCE (μF)/RATED VOLTAGE (V).
6. SI-DIODES (▶) ARE ALL 1SS254T THAT CAN BE CHANGED TO SIMILAR DIODE SUCH AS MA160 OR H5S104J.
7. PARTS NO. OF TRANSISTORS ARE AS FOLLOWS:
Q1 2SC2658G1 Q3: 4-14 KTC31991G1-T
Q2: B DTA114YKA-X Q7: B 2SA1037KH1T146

B. INSIDE OF DIGITAL TRANSISTORS ARE SHOWN AS FOLLOWS:

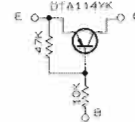

9. LAST NO. BLANK NO.
R 4-11-14-17-19-28-32-33
40-41-47-49-51-53-58-59
62-64-67-70-73-77-79-81
C 10-20-22-29-38
48-54-59-63-64-73-79-87-88

LVA10G29-A1

Tr. No.	Q1	Q2	Q3	Q4	Q5	Q6	Q7	Q8	Q9	Q10	Q11	Q12	Q13	Q14
EN IN:	E	C	B	E	C	B	E	C	B	E	C	B	E	C
MHz NO SIGNAL	0	7.5	0.7	0.8	0.7	0	5.0	0	5.0	0	5.0	0	5.0	0
MHz NO SIGNAL	0	0	0	0	0	0	0	0	0	0	0	0	0	0
Tr. No.	Q1	Q2	Q3	Q4	Q5	Q6	Q7	Q8	Q9	Q10	Q11	Q12	Q13	Q14
EN IN:	E	C	B	E	C	B	E	C	B	E	C	B	E	C
MHz NO SIGNAL	0	0	0	0	0	0	0	0	0	0	0	0	0	0
MHz NO SIGNAL	0	0	0	0	0	0	0	0	0	0	0	0	0	0

E/B/EN/EV/A

■ Cassette Amplifier Circuit

6
5
4
3
2
1

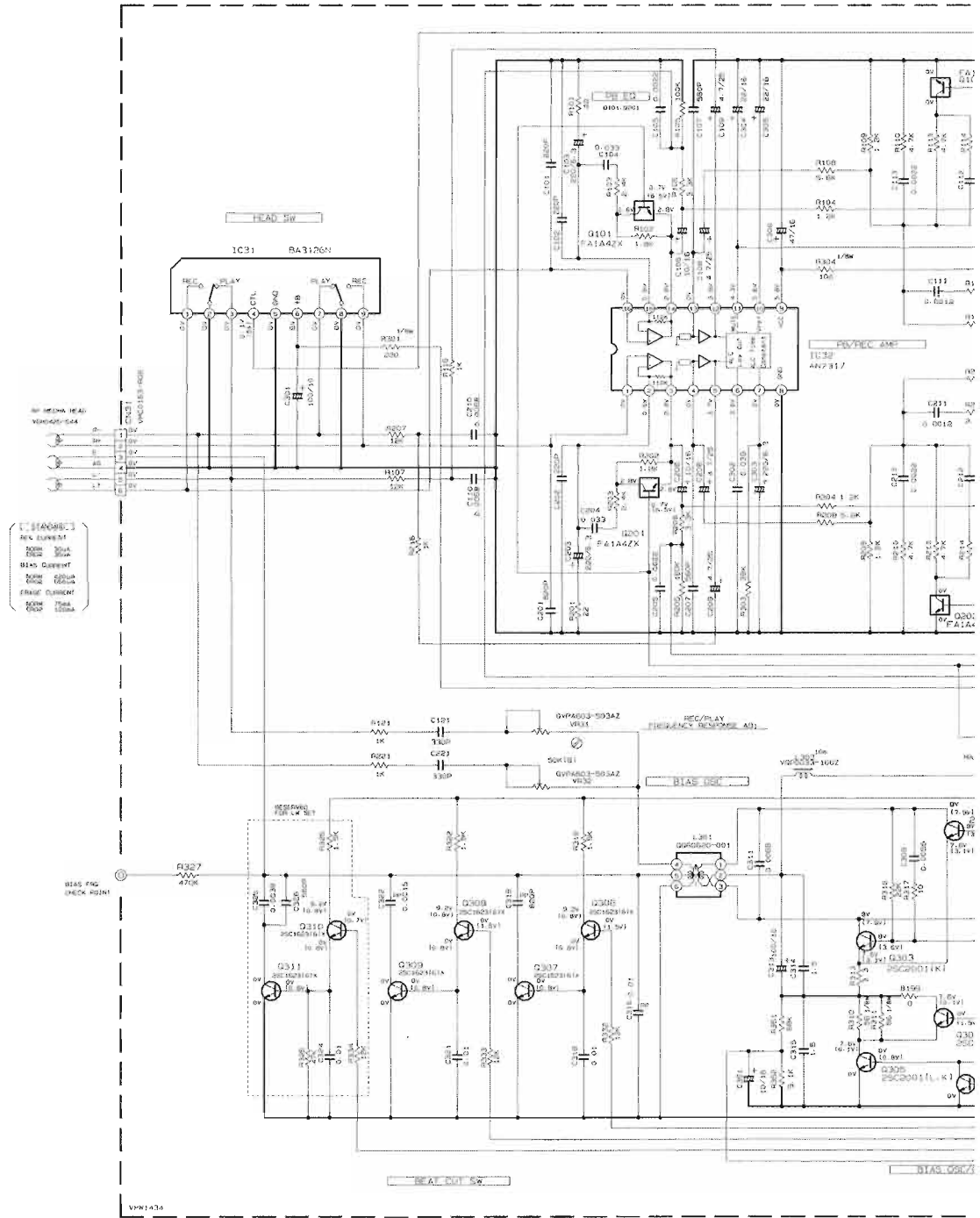

STANDARD
REC ELEMENT
PAUSE ELEMENT
PLAY ELEMENT
REW ELEMENT
FF ELEMENT

NOTES

1. VOLTAGES ARE DC MEASURED WITH A DIGITAL VOLT METER OR OSCILLOSCOPE WITHOUT INPUT SIGNAL CONDITION-MEDIA STOP MODE

2. UNLESS OTHERWISE SPECIFIED, RESISTORS ARE 1/16W 5% METAL GLAZE ALL RESISTANCE VALUES ARE IN OHMS.
ALL CAPACITORS ARE CERAMIC CAPACITOR OR MYLAR CAPACITOR ALL CAPACITANCE VALUES ARE IN PICO(F)
ALL INDUCTANCE VALUES ARE IN MILLI(H)
ALL CAPACITORS ARE SHOWN IN THE FORM OF CAPACITANCE (UF/PF)

A B C D E

■ Power Supply Circuit for UX-V3/V5/V5R

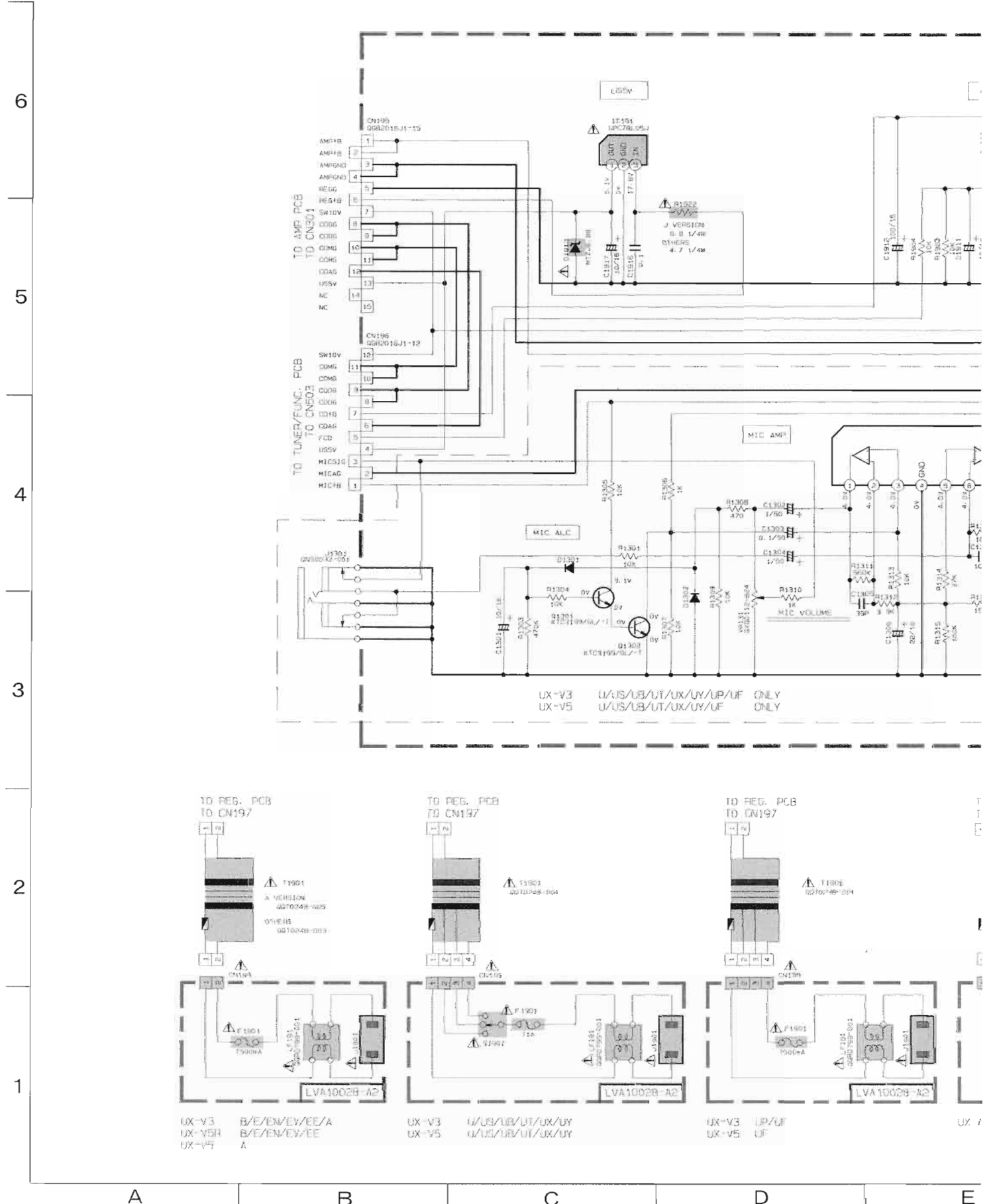

UX-V3/UX-V5
UX-V5R/FS-V5

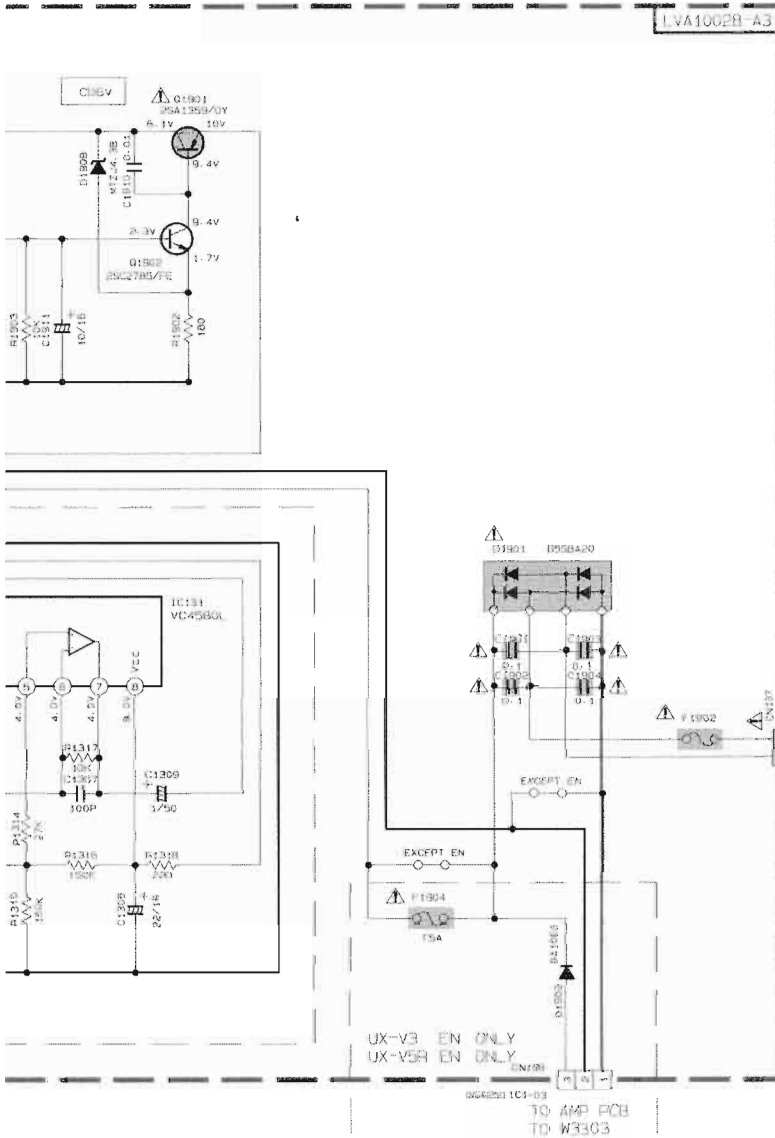

MODEL	VERSION	F1902
UX-V3	B/E/EN/EV/EE U/US/UB/UT/UX/UY/UP/UF	T6-3A
UX-V5R	B/E/EN/EV/EE	
UX-V5	U/US/UB/UT/UX/UY/UF	
UX-V3	A	18A
UX-V5	A	
UX-A1	D	8A/125V
FS-V5	J	

VERSION CODES

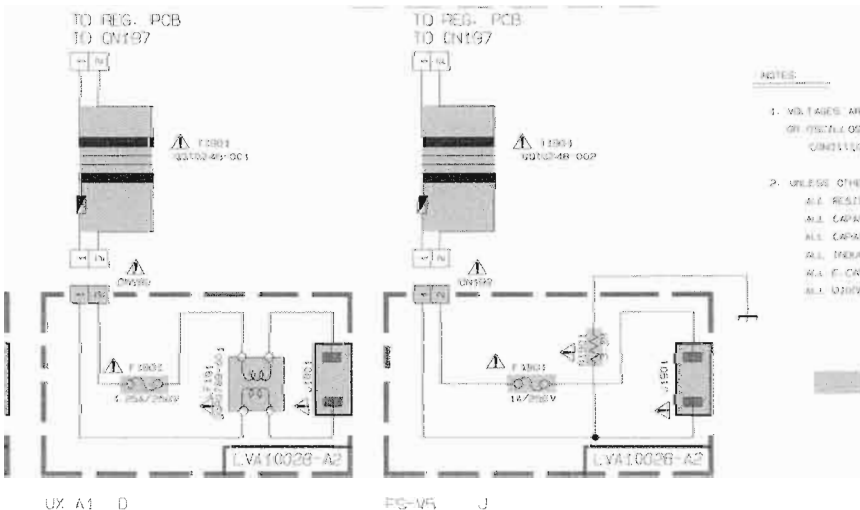

NOTES

1. VOLTAGES ARE TO BE MEASURED WITH A DIGITAL VOLTMETER OR OSCILLOSCOPE WITHOUT INPUT STIMULUS. CONTINUOUS - GD SAMP MEAS.
2. UNLESS OTHERWISE SPECIFIED, RESISTORS ARE 1/8W 5% CARBON RESISTOR. ALL RESISTANCE VALUES ARE IN OHMS.
ALL CAPACITORS ARE CERAMIC CAPACITORS OR MYLAR CAPACITOR.
ALL CAPACITANCE VALUES ARE IN MICROFARADS.
ALL INDUCTANCE VALUES ARE IN MILLIHENRYS.
ALL CAPACITORS ARE SHOWN IN THE FORM OF CAPACITANCE VALUE/WORKING VOLTAGE.
ALL DIMENSIONS ARE IN MILLIMETERS.

⚠ Parts are safety assurance parts. When replacing those parts make sure to use the specified one.

UX-A1 D

FS-V5 J

Printed Circuit Boards

■ Main Board

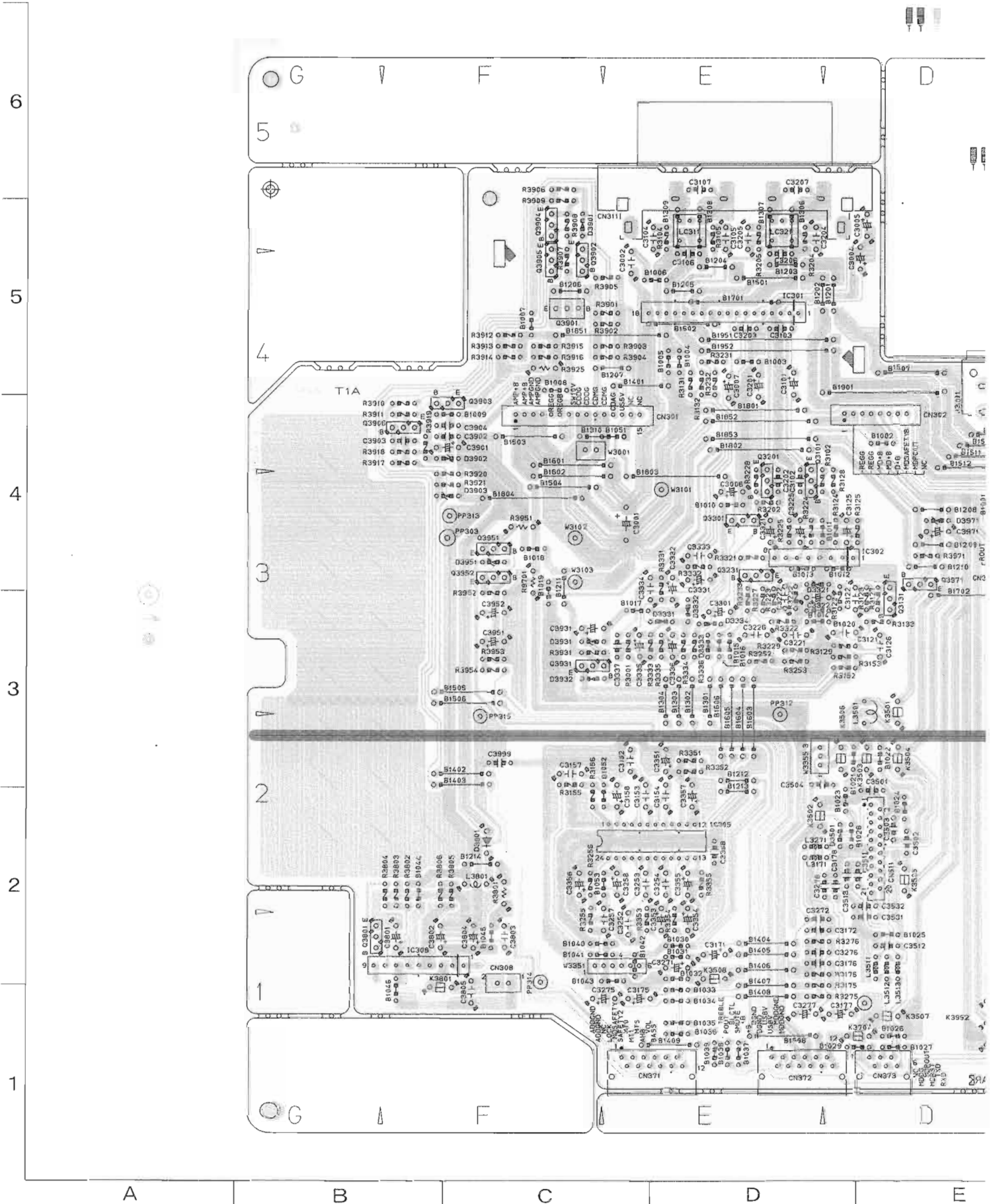

Bサービス

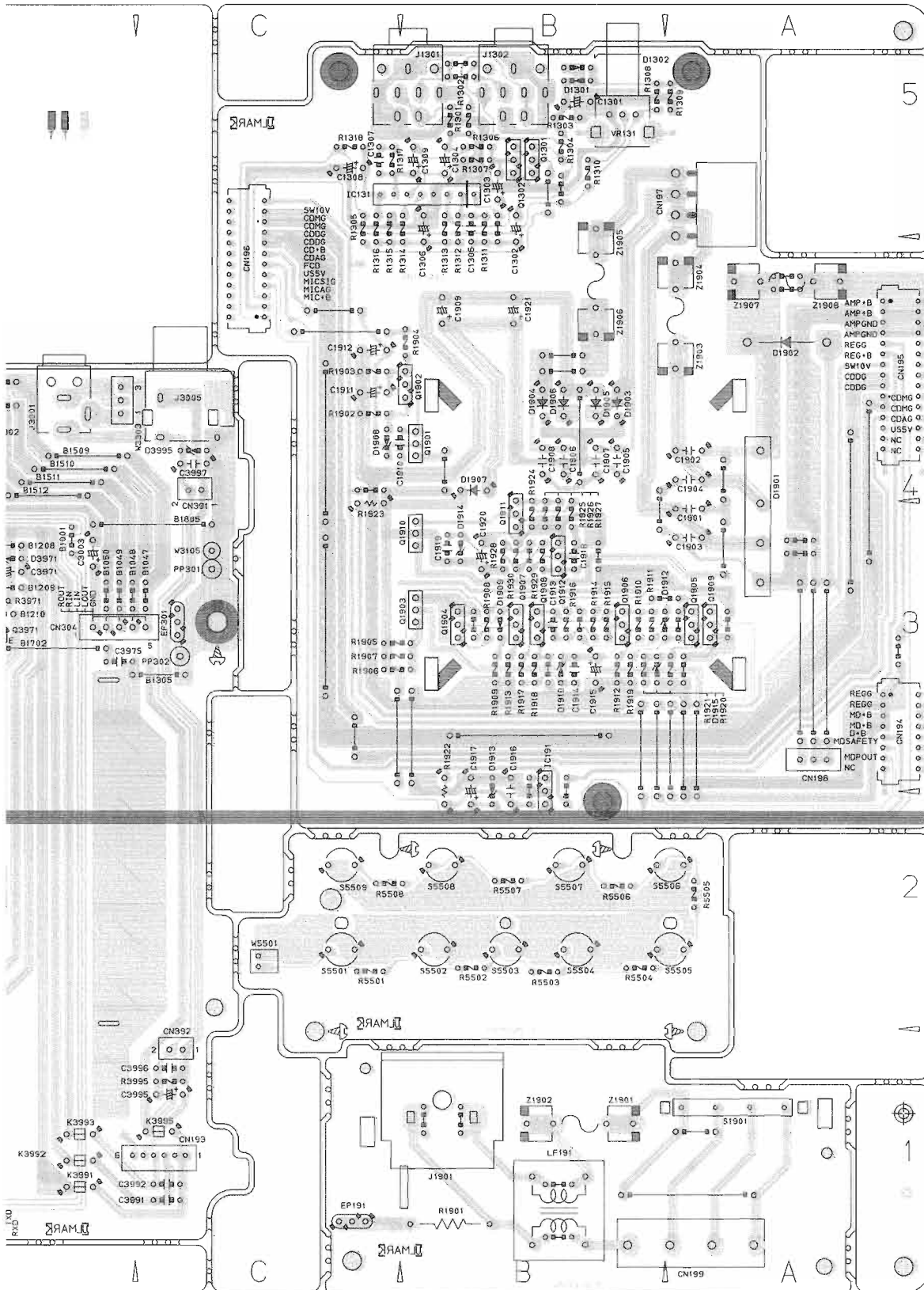

UX-V3/UX-V5
UX-V5R/FS-V5

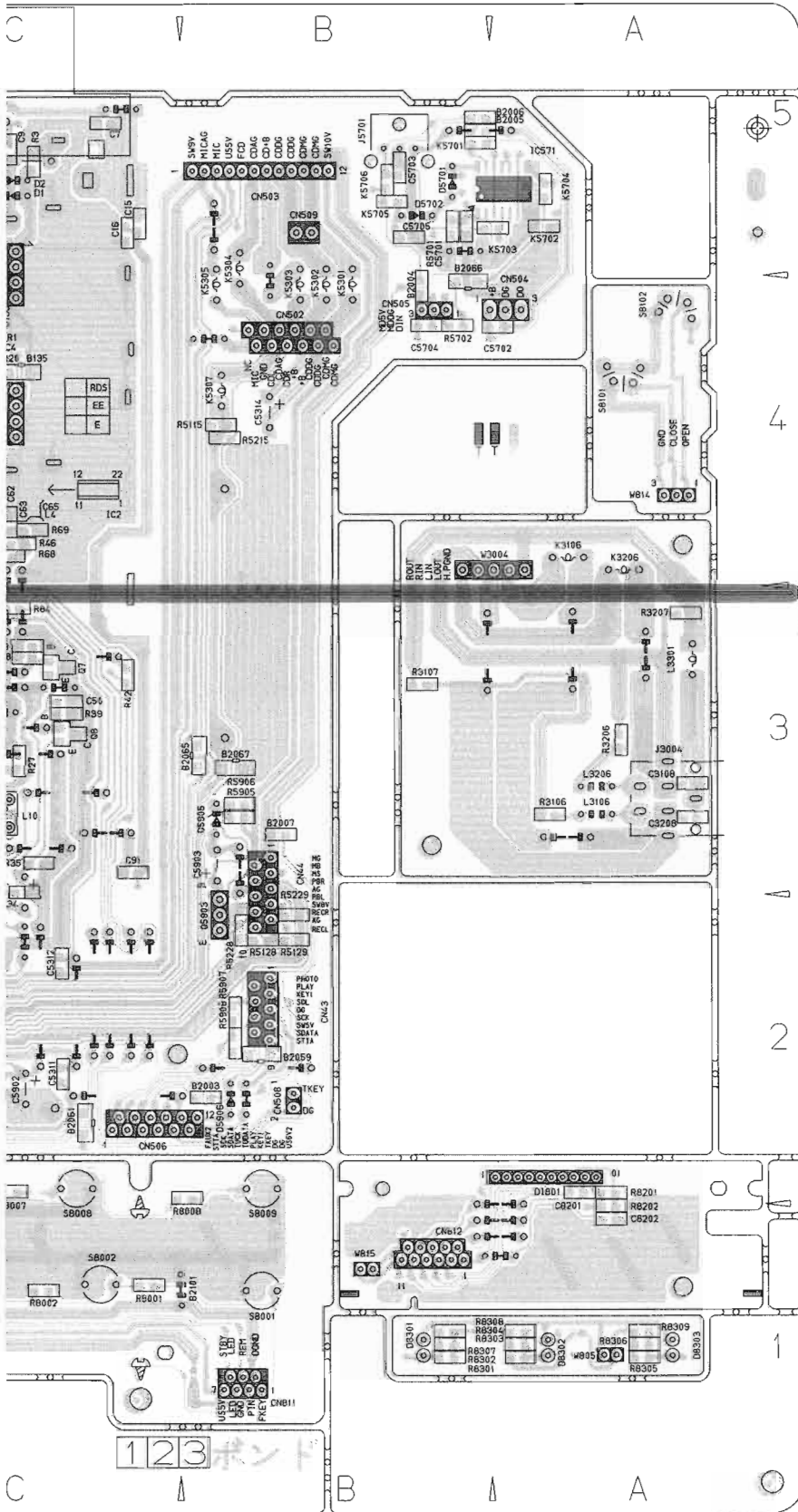

E

F

G

H

I

■ CD Servo P. W. B

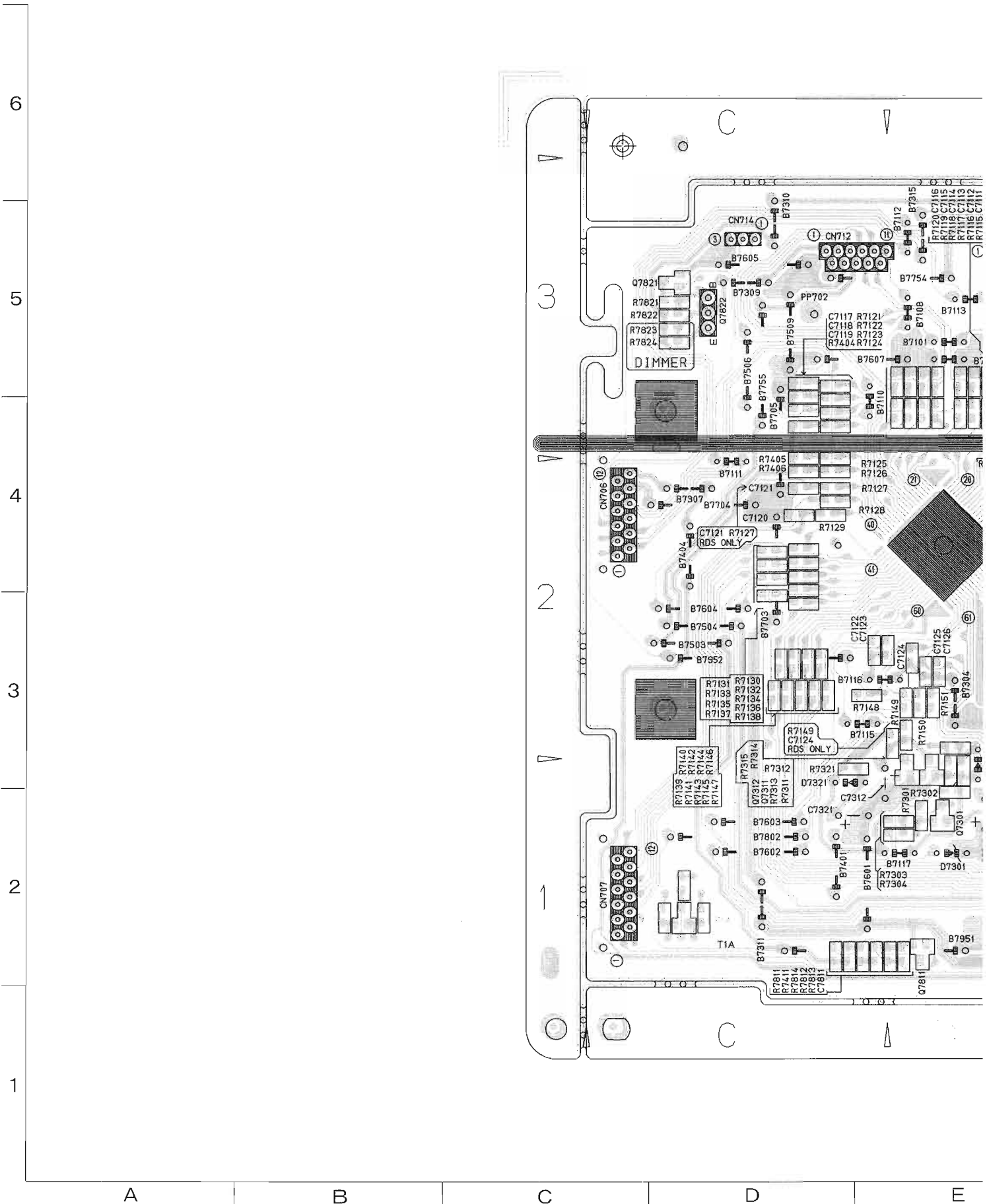

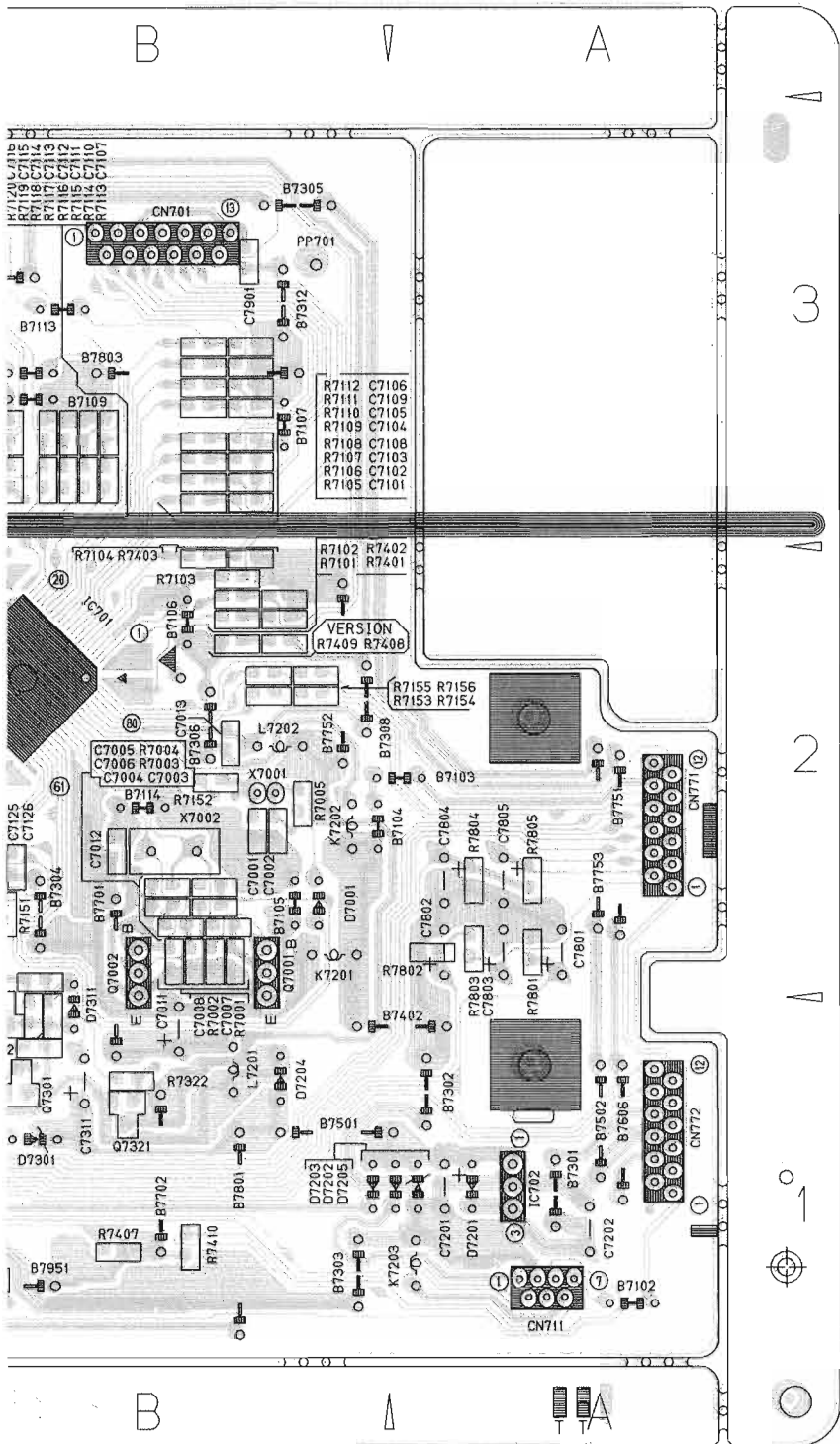

■ Head Amp. & Mechanism Control P. W. B

6
5
4
3
2
1

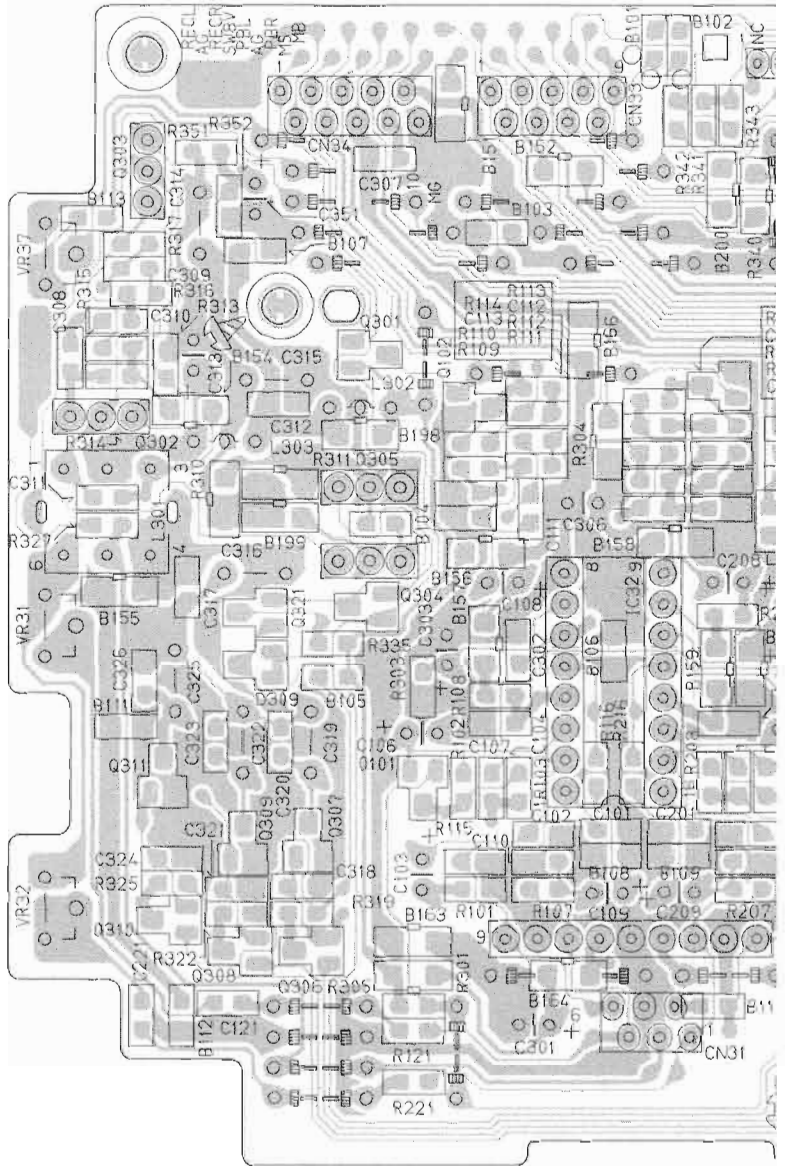

■ Cassette Switch P. W. B

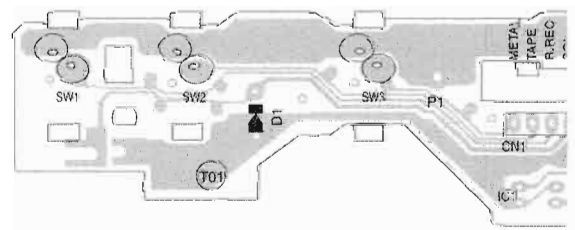

A B C D E

UX-V3/UX-V5
UX-V5R/FS-V5

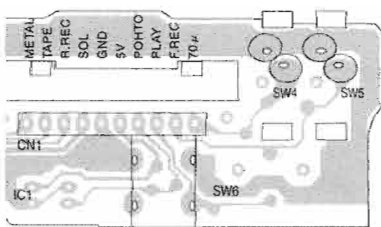

E

F

G

H

I

PARTS LIST

[UX-V5R
UX-V5
UX-V3]

* All printed circuit boards and its assemblies are not available as service parts.

UX-V5R	
Areas Suffix	
B	U.K.
E	Continental Europe
EN	Northern Europe
EV	Eastern Europe
EE	Russian Federation

UX-V3	
Areas Suffix	
A	Australia
B	U.K.
E	Continental Europe
EN	Northern Europe
EV	Eastern Europe
EE	Russian Federation

UX-V5	
Areas Suffix	
A	Australia

- Contents -

Exploded view of general assembly and parts List-----	3-2
CD mechanism ass'y and parts list-----	3-6
Cassette mechanism ass'y and partsList-----	3-6
Electrical parts list -----	3-8
Packing materials and accessories parts list -----	3-29

■ Parts List (General Assembly)

BLOCK NO. M1111111							
REF.	PARTS NO.	PARTS NAME	REMARKS	QTY	SUFFIX	CLR	
1	LV10170-004A	FRONT PANEL	V5R V5	1			
	LV10170-001A	FRONT PANEL	V3	1			
2	LV40735-001A	REMOTE LENS		1			
3	LV20303-001A	FRONT BUTTON	V3	1			
	LV20303-004A	FRONT BUTTON	V5R V5	1			
4	QYSBSF3008Z	SCREW		5			
5	LV20305-001A	FRONT PLATE	V3	1			
	LV20305-003A	FRONT PLATE	V5R V5	1			
6	QYSBSF3008Z	SCREW		1			
7	E65923-003	TAPPING SCREW		1			
8	LV40954-001A	FOOT		2			
9	QYSBSF3008Z	SCREW	CHASSIS+PWB BKT	4			
10	LV30064-042A	SPACER		1			
11	QYSBST3006Z	TH TAP SCREW	PWB BKT+PWB	4			
12	LV20306-003A	CD DOOR	V5R	1			
	LV20306-001A	CD DOOR	V3	1			
	LV20306-002A	CD DOOR	V5	1			
13	LV41105-001A	BLIND		1			
14	PQ42376-001	JVC MARK		1			
15	LV40743-002A	LCD LENS	V5R V5	1			
	LV40743-001A	LCD LENS	V3	1			
16	LV30860-001A	LCD HOLDER		1			
17	LV30064-043A	SPACER		1			
18	LV40737-001A	LENS	LCD BACKLIGHT	1			
19	LV40739-001A	SHEET		1			
20	LV20307-001A	DOOR COVER		1			
21	LV20308-001A	CD DOOR LENS	V3	1			
	LV20308-002A	CD DOOR LENS	V5R V5	1			
22	QYSDSF2008M	SCREW	DOOR+COVER	3			
23	LV40744-001A	SOCKET BOLT	DOOR+LENS	2			
24	LV30858-001A	PWB BRACKET(L)	FOR MAICOM PWB	1			
25	LV30859-001A	PWB BRACKET(R)	FOR MAICOM PWB	1			
26	LV41002-001A	SHAFT	DOOR+CASE	1			
27	LV41003-001A	DOOR SUPPORTER		1			
28	QYSBSF3008Z	SCREW	F.PANEL+CD UNIT	2			
29	LV10173-001A	BOTTOM CHASSIS		1			
30	VKZ4001-016	WIRE HOLDER		1			
31	QYSBST4006Z	SCREW	B.CHASI+TRANS	4			
32	QZW0004-001	WIRE CLAMP		1			
33	LV30861-002A	JACK HOLDER		1			
34	QYSBST3006Z	TH TAP SCREW	J.HOL.+BTM.CHAS	1			
35	-----	CASSETTE MECHA		1			
36	VKL7850-203	EJECT SAFTY(R)		1			
37	VKW5258-002	TORSION SPRING		1			
38	VYH3965-001	SIDE BRACKET(R)		1			
39	QYSDST3008Z	SCREW	MECHA+S.BKT.	1			
40	VYH8146-012	EJECT ARM(R)		1			
41	VKW3006-230	TORSION SPRING		1			
42	VKZ4341-004	SPECIAL SCREW	E.ARM+S.BKT.	1			
43	LV31009-001A	HEAD SHIELD		1			
44	QYSBSF2606Z	SCREW		2			
45	LV10174-002A	TOP COVER(TD)	V3	1			
	LV10174-006A	TOP COVER(TD)	V5R	1			
	LV10174-005A	TOP COVER(TD)	V5	1			
46	LV20311-002A	CASSETTE DOOR	V5R V5	1			

BLOCK NO. M1MM

REF.	PARTS NO.	PARTS NAME	REMARKS	QTY	SUFFIX	CLR
47	LV20311-001A	CASSETTE DOOR	V3	1		
	LV40851-002A	CASS.DOOR LENS	V5R V5	1		
	LV40851-001A	CASS.DOOR LENS	V3	1		
48	VKY4180-001	CASSETTE SPRING		2		
49	VYH7366-001MM	GEAR		1		
50	VKW5277-001	DOOR SPRING (R)		1		
51	LV40745-001A	EJECT KNOB	V3	1		
	LV40745-002A	EJECT KNOB	V5R V5	1		
52	LV30863-003A	TOP BUTTON	V5	1		
	LV30863-001A	TOP BUTTON	V3	1		
	LV30863-004A	TOP BUTTON	V5R	1		
53	QYSBSF3008Z	SCREW	T.PANEL+T.BUTTO	4		
54	VYSA1R4-056	SPACER		1		
55	QYSBSF3012Z	SCREW		4		
58	PU59915-105	SPACER	V5R/E EN EV B	1		
	PU59915-105	SPACER	V3/E EN EV B A	1		
	PU59915-105	SPACER	V5/A	1		
59	QYSSSF3008Z	SCREW	T.PANEL+F.PANEL	2		
60	LV30864-001A	IC HOLDER		1		
61	QYSBSF3010Z	SCREW	IC+IC HOLDER	3		
62	LV30865-001A	HEAT SINK 1		1		
63	QYSBSF3010Z	SCREW	IC HOL.+H.SINK1	2		
64	QYSBST3006Z	TH TAP SCREW	B.CHASI+AMP PWB	1		
65	LV30866-001A	HEAT SINK 2		1		
66	QYSBSF3010Z	SCREW	IC+HEAT SINK 2	2		
67	QYSBSF3010Z	SCREW		3		
69	QYSBSF3010Z	SCREW		1		
70	LV40746-001A	EARTH PLATE		1		
71	QYSBST3006Z	TH TAP SCREW	B.CHASI+TU/FUN	1		
72	LV10176-002A	SIDE PANEL(L)	V5R V5	1		
	LV10176-001A	SIDE PANEL(L)	V3	1		
73	LV10177-001A	SIDE PANEL(R)	V3	1		
	LV10177-002A	SIDE PANEL(R)	V5R V5	1		
74	LV10178-006A	REAR PANEL	V3	1		
	LV10178-002A	REAR PANEL	V5R EN	1		
	LV10178-001A	REAR PANEL	V5R V5	1		
	LV10178-007A	REAR PANEL	V3 EN	1		
75	LV40954-001A	FOOT		2		
76	QYSBSF3010N	TAP SCREW	R.PANEL+JACK	6		
77	QYSBST3006N	T.SCREW		1		
78	QYSSST3010Z	SCREW	BTM.+SIDE+PANEL	4		
79	LV30920-003A	NAME PLATE	V5R EE	1		
	LV30920-004A	NAME PLATE	V5R EN	1		
	LV30913-001A	NAME PLATE	V3 E	1		
	LV30913-004A	NAME PLATE	V3 EE	1		
	LV30920-001A	NAME PLATE	V5R E	1		
	LV30913-003A	NAME PLATE	V3 EV	1		
	LV30920-002A	NAME PLATE	V5R EV	1		
	LV30919-003A	NAME PLATE	V5 A	1		
	LV30913-013A	NAME PLATE	V3 EN	1		
	LV30913-005A	NAME PLATE	V3 A	1		
80	VND4118-004	CAUTION LABEL		1		
81	E70891-001	CLASS 1 LABEL		1		
82	LV40231-001A	CAUTION LABEL	FOR CD	1		

BLOCK NO. M1MM

REF.	PARTS NO.	PARTS NAME	REMARKS	QTY	SUFFIX	CLR
83	QMF51E2-6R3-J1	FUSE (F1902)	B/E/EE/EN/EV	1		
	QMF2031-8R1-J1	FUSE (F1902)	V5/A V3/A	1		
84	QMF51E2-R50	FUSE (F1901)		1		
85	QMF51E2-5R0-J1	FUSE (F1904)	V5R/V3 EN ONLY	1		
86	LV40736-003A	BADGE	V5R	1		
	LV40736-001A	BADGE	V3	1		
	LV40736-002A	BADGE	V5	1		
92	QUQB10-0712AJ	FFC WIRE		1		
93	QUQB12-1026CJ	FFC WIRE	CD - FUNC	1		
94	QUQB12-1306CJ	CARD WIRE	CD - MICOM	1		
95	QUQB10-1109AJ	FFC WIRE	LCD - MICOM	1		
96	QUQB12-1024CJ	FFC WIRE	SLC - FUNC	1		
97	QUQB12-0924CJ	FFC WIRE	SLC - FUNC	1		
98	QJN004-033001	WIRE		1		
100	WJM0079-001A	WIRE		1		
101	VYH8064-001	WEIGHT		1		
102	LV40770-002A	INSULATOR		3		
103	LV30064-038A	SPACER		1		
104	LV30064-045A	SPACER		1		
105	LV10171-002A	CD CASE	V5R V5	1		
	LV10171-001A	CD CASE	V3	1		
106	E75609-002	INSULATOR	FOR CD CASE	1		
107	LV10172-001A	CD CHASSIS		1		
108	LV30064-044A	SPACER		1		
109	LV40738-001A	GEAR1		1		
110	LV40740-002A	GEAR 2		1		
111	VKB3000-183	BELT		1		
112	VYH7699-001SS	PULLEY		1		
113	QARO100-001	DC MOTOR		1		
114	QYSPSP3004Z	SCREW	CHASSIS+MOTOR	2		
115	QYSBSF3010Z	SCREW	CHASSIS+CASE	4		
116	E65923-003	TAPPING SCREW	CHASI+O/C SW.PW	1		
117	-----	CD MECHA		1		
118	LV40987-001A	SHIELD PLATE		1		
119	LV40988-001A	TUNER SHIELD		1		
T1901	QQT0248-003	POWER TRANS	B.E.EE.EN.EV	1		
	QQT0248-005	POWER TRANS	V5/A V3/A	1		

Exploded View of General Assembly and Parts List

Block No. M 1 M M

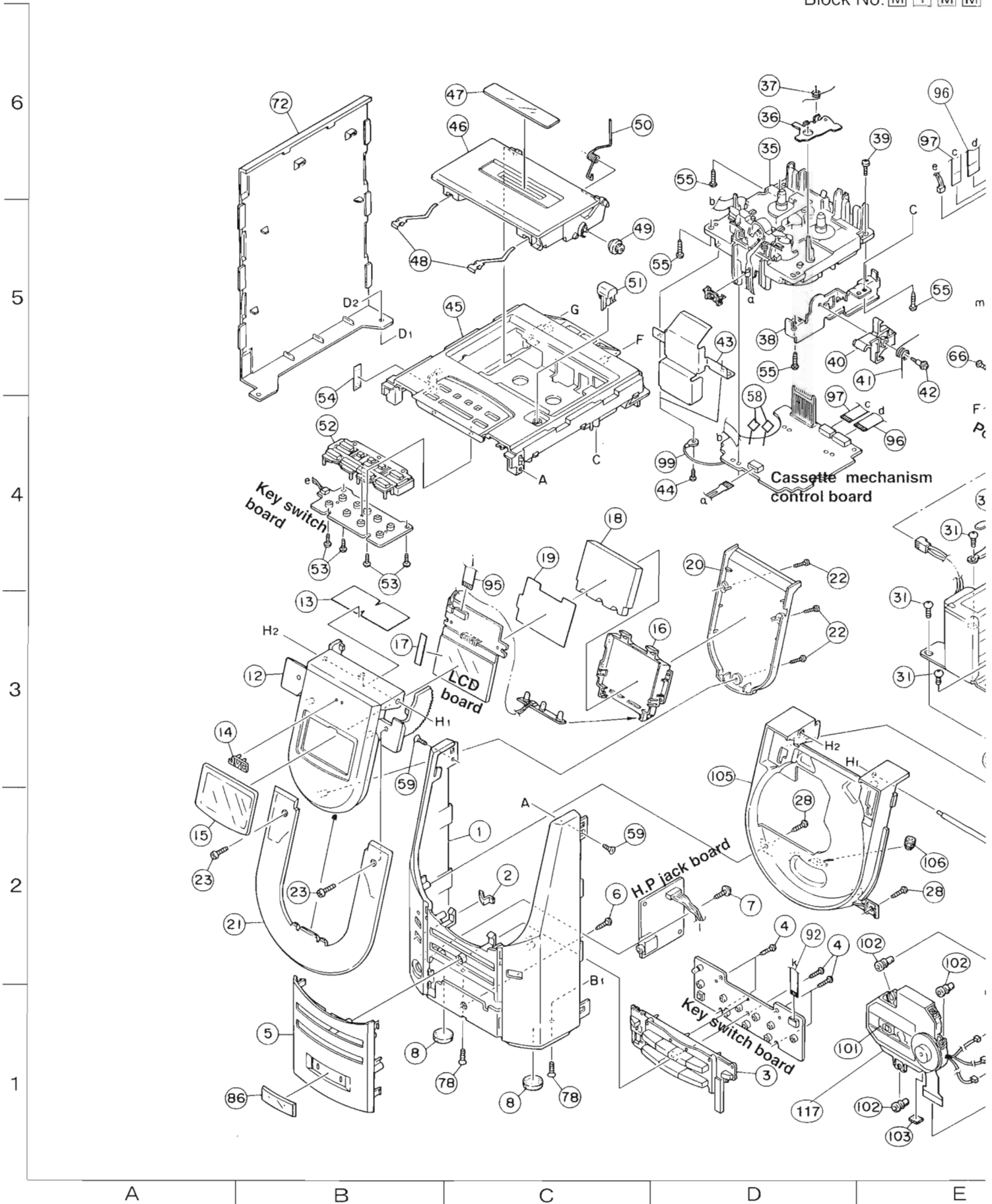

M M

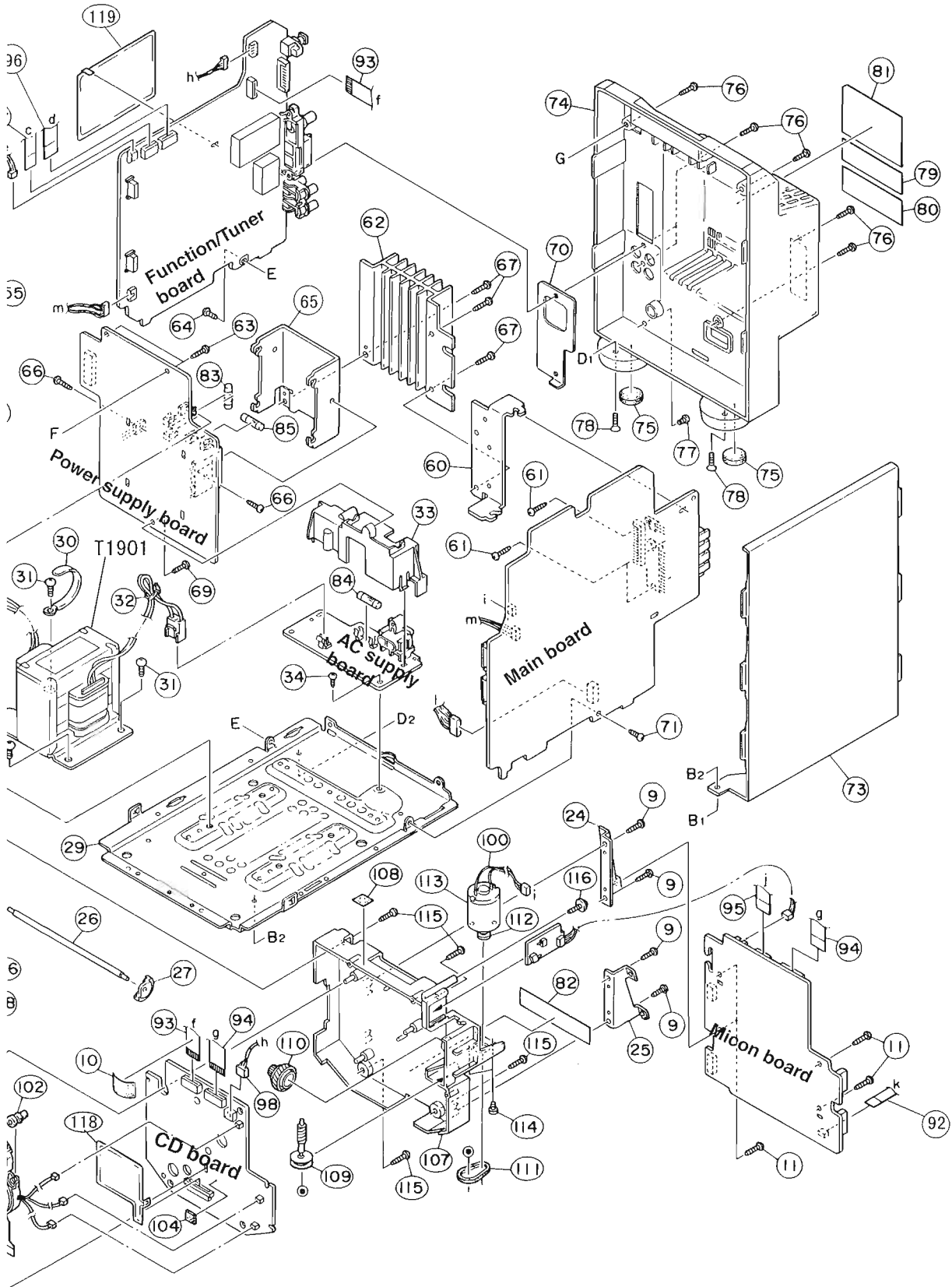

E F G H I

CD Mechanism Assembly and Parts List

Block No. M 2 M M

KSM-33AAN

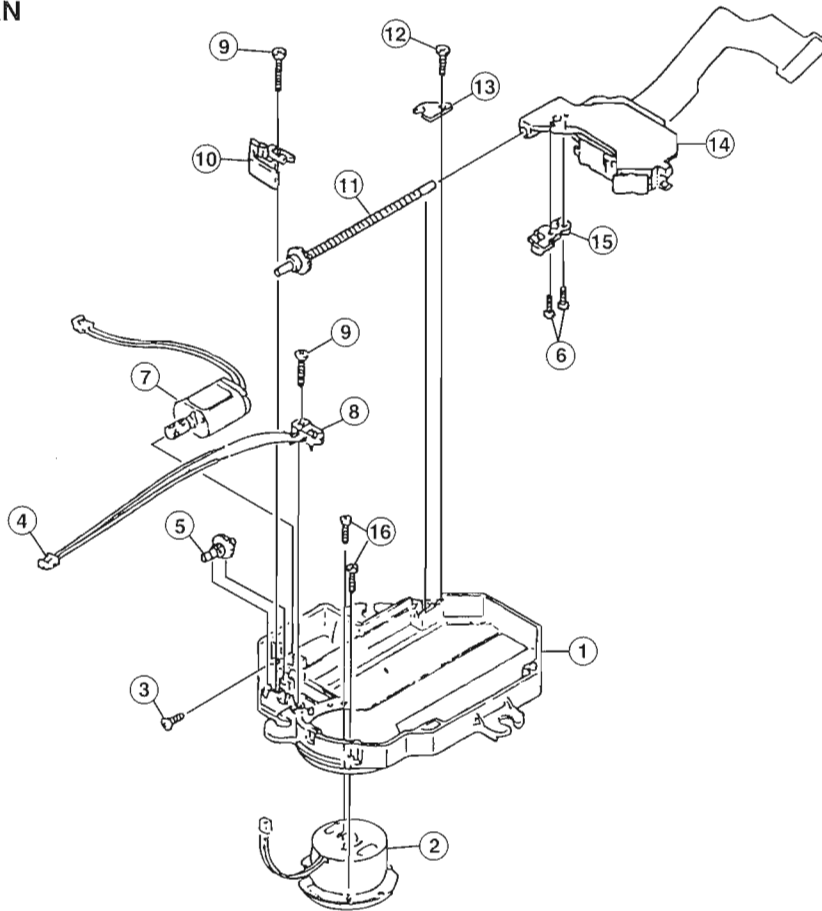

CD Mechanism Assembly Parts List

	Item	Parts Number	Parts Name	Q'ty	Description	Area
	1	2-625-415-05	CHASSIS	1		
	2	X-2625-485-1SA	MOTOR ASS'Y	1		
	3	3-732-988-01	SCREW	1		
	4	1-948-418-21	HARNESS	1		
	5	2-625-410-01	GEAR(B)	1		
	6	7-627-852-17	SCREW	2	FOR RACK	
	7	X-2625-171-2	FEED MOTOR ASS'Y	1		
	8	1-570-771-11	SWITCH	1		
	9	2-625-623-11	SCREW	2	FOR SWITCH	
	10	2-625-412-02	LEAF SPRING	1		
	11	X-2625-483-1	SHAFT GEAR	1		
	12	2-625-623-01	SCREW	1	SHAFT GEAR	
	13	2-625-411-01	GEAR GUIDE	1		
	14	8-848-289-31SA	OPTICAL PICK UP	1		
	15	2-625-414-02	RACK	1		
	16	7-627-852-18	SCREW	2	FOR MOTOR	

A

B

C

D

E

Cassette Mechanism Assembly and Parts List

Block No. M 3 M M

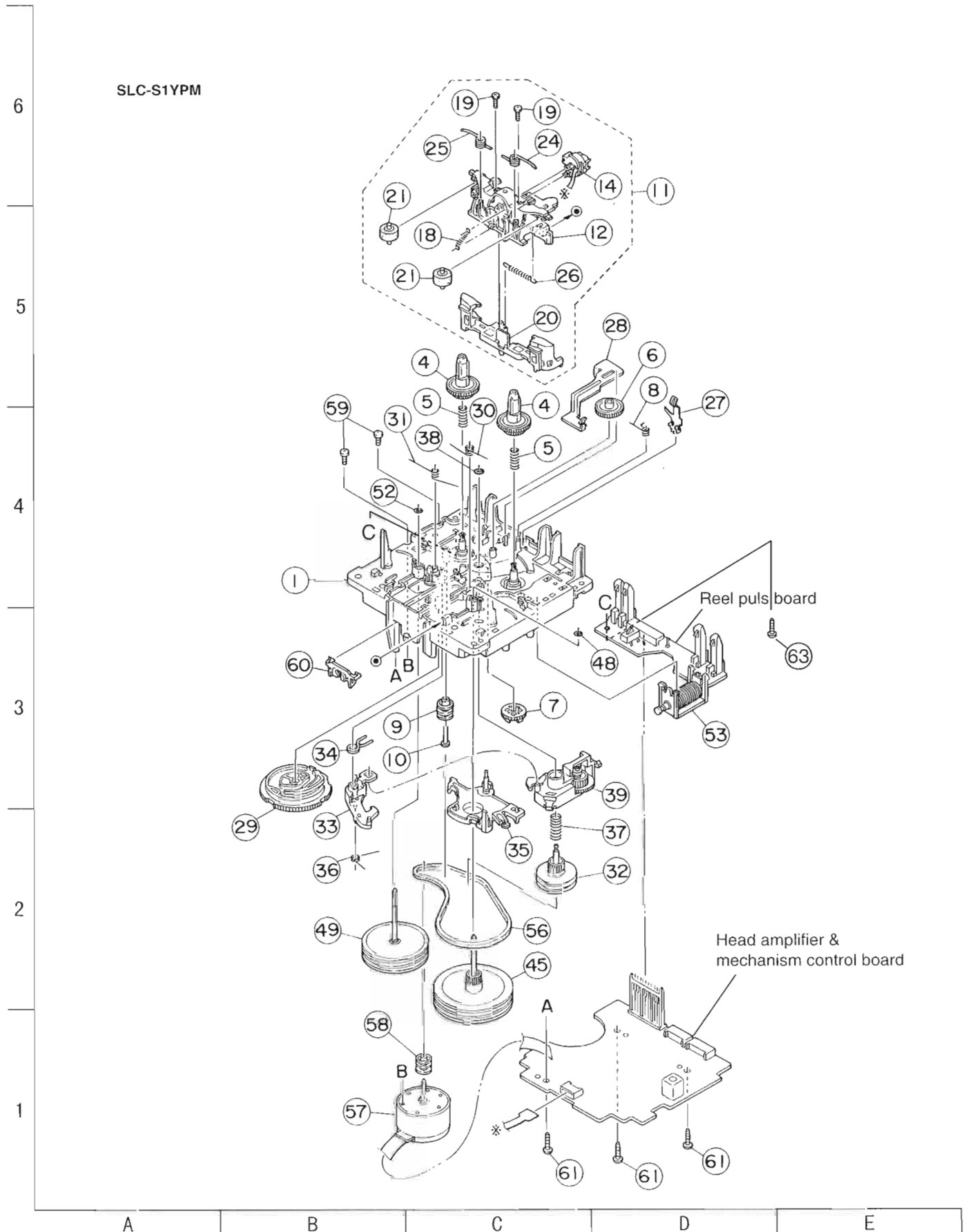

■ Parts List (Cassette Mechanism)

BLOCK NO. **M3MM** | | | |

△ REF.	PARTS NO.	PARTS NAME	REMARKS	QTY	SUFFIX	CLR
1	VKS1165-00G	CHASSIS B.ASS'Y		1		
4	VKS2274-002	REEL GEAR		2		
5	VKW5286-002	B.T. SPRING		2		
6	VKS5559-001	PLAY IDLE GEAR		1		
7	VKS5597-00A	FR GEAR ASS'Y		1		
8	VKW5296-001	EARTH SPRING		1		
9	VKR4749-002	IDLE PULLEY		1		
10	VKH5786-002	SHAFT		1		
11	VKS2275-00C	HEAD MOUNT ASSY		1		
12	VKS1167-001	HEAD MOUNT BASE		1		
14	VGH0425-544	R/P&E HEAD	VKS2275-00B	1		
18	VKW5302-001	HEAD SPRING		1		
19	VKZ4730-001	SPECIAL SCREW		2		
20	VKS2277-005	DIRECTION LEVER		1		
21	VKP4233-00A	PINCH ROL. ASSY		2		
24	VKW5299-002	PIN ROL.SP.(R)		1		
25	VKW5300-002	PIN ROL.SP.(L)		1		
26	VKW5285-001	RETURN SPRING		1		
27	VKY3149-002	CASSETTE SP.		1		
28	VKM3906-002	PLAY SW LEVER		1		
29	VKS1166-003	CONTROL CAM		1		
30	VKW5279-001	HEAD BASE SP(R)		1		
31	VKW5280-001	HEAD BASE SP(L)		1		
32	VKS5603-00D	MAIN PULLEY ASY		1		
33	VKS3785-001MM	FR ARM		1		
34	VKW5284-002	SWING SPRING		1		
35	VKS2278-003	TRIGGER ARM		1		
36	VKW5301-001	FR SPRING		1		
37	VKW5266-001	ELEVATOR SPRING		1		
38	WDL214025	WASHER		1		
39	VKS3786-00G	CLUTCH ASS'Y		1		
45	VKF3205-00B	F.WHEEL ASSY(R)		1		
48	WDL183425	SLIT WASHER		1		
49	VKF3207-00B	F.WHEEL ASSY(L)		1		
52	WDL173525-6	SLIT WASHER		1		
53	VKZ3174-00A	DC SOLENOID		1		
56	VKB3000-181	CAPSTAN BELT		1		
57	MSI-5U2LWA	D.C.MOTOR ASS'Y		1		
58	VKR4761-001	MOTOR PULLEY		1		
59	QYSPSP2604Z	SCREW		2		
60	VKS5577-001	FPC HOLDER		1		
61	QYSBSF2608Z	T.SCREW	FOR P.W.B.	3		
63	QYSBSF2006Z	SCREW		1		

Tuner/Function Board

BLOCK NO. 01111111			BLOCK NO. 02111111						
A. REF.	PARTS NO.	PARTS NAME	REMARKS	SUFFIX	A. REF.	PARTS NO.	PARTS NAME	REMARKS	SUFFIX
R3917	QRE141J-682Y	C RESISTOR	6.8K 5% 1/4W		C	1	NCB21HK-223X	.022MF 10X 50V	
R3918	QRE141J-472Y	C RESISTOR	4.7K 5% 1/4W		C	2	NCB21HK-103X	.010MF 10X 50V	
R3919	QRE141J-222Y	C RESISTOR	2.2K 5% 1/4W		C	3	NCB21EK-473X	.047MF 10X 25V	
R3920	QRE141J-223Y	C RESISTOR	2.2K 5% 1/4W		C	4	NCB21HK-103X	.010MF 10X 50V	
R3921	QRE141J-103Y	C RESISTOR	10K 5% 1/4W		C	5	QEK41CM-106	10MF 20X 16V	
R3931	QRE141J-561Y	C RESISTOR	560 5% 1/4W		C	6	NCB21HK-102X	1000PF 10X 50V	
R3952	QRE2906-4R7X	F RESISTOR	4.7 1/0W		C	7	NCB21HK-102X	1000PF 5X 50V	
R3952	QRE141J-102Y	C RESISTOR	1.0K 5% 1/4W		C	8	NCB21HK-150X	15PF 5X 50V	
R3953	QRE141J-103Y	C RESISTOR	10K 5% 1/4W		C	9	NCB21HK-102X	1000PF 10X 50V	
R3954	QRE141J-103Y	C RESISTOR	10K 5% 1/4W		C	11	NCB21HK-102X	1000PF 10X 50V	
R5501	QRE141J-102Y	C RESISTOR	1.0K 5% 1/4W		C	12	NCB21HK-150X		
R5502	QRE141J-102Y	C RESISTOR	1.0K 5% 1/4W		C	13	NCB21EK-473X	.047MF 10X 25V	
R5503	QRE141J-122Y	C RESISTOR	1.2K 5% 1/4W		C	14	NCB21HK-102X	1000PF 10X 50V	
R5504	QRE141J-152Y	C RESISTOR	1.5K 5% 1/4W		C	15	NCB21HK-102X	1000PF 10X 50V	
R5505	QRE141J-222Y	C RESISTOR	2.2K 5% 1/4W		C	16	NCB21HK-102X	1000PF 10X 50V	
R5506	QRE141J-272Y	C RESISTOR	2.7K 5% 1/4W		C	17	NCB21HK-103X	.010MF 10X 50V	
R5507	QRE141J-392Y	C RESISTOR	3.9K 5% 1/4W		C	18	NCB21HK-103X	.010MF 10X 50V	
R5508	QRE141J-562Y	C RESISTOR	5.6K 5% 1/4W		C	19	NCB21HK-122X	1200PF 10X 50V	
R9701	QRZ906-4R7X	F RESISTOR	4.7 1/0W		C	21	NCB21EK-473X	.047MF 10X 25V	
S5501	QSW0698-001Z	TACT SWITCH	REC		C	30	QEK61CM-476Z-JB	47MF 20X 16V	
S5502	QSW0698-001Z	TACT SWITCH	REV. MODE		C	31	NCB21HK-390X	39PF 5X 50V	
S5503	QSW0698-001Z	TACT SWITCH	PTY/EDN		C	32	NCB21HK-102X	1000PF 10X 50V	
S5504	QSW0698-001Z	TACT SWITCH	DISPLAY MODE		C	33	QEK61AM-107Z-JB	100MF 20X 10V	
S5505	QSW0698-001Z	TACT SWITCH	CLOCK		C	34	NCB21HK-150X	15PF 5X 50V	
S5506	QSW0698-001Z	TACT SWITCH	TIMER		C	35	NCB21HK-102X	1000PF 10X 50V	
S5507	QSW0698-001Z	TACT SWITCH	VOL UP		C	36	QEK41CM-106	V5R7E EN EV B	
S5508	QSW0698-001Z	TACT SWITCH	VOL DOWN		C	36	QEK61CM-106Z	V5R7EE	
S5509	QSW0698-001Z	TACT SWITCH	AHB		C	36	QEK41CM-106	V5/A	
W3303	QJK019-030793	SIN CR C-B WIRE	V5R/EN ONLY		C	37	NCB21EK-473X	.047MF 10X 25V	
A 21901	QNG0020-001Z	FUSE CLIP	FOR F1901		C	39	NCB21EK-473X	.047MF 10X 25V	
A 21902	QNG0020-001Z	FUSE CLIP	FOR F1902		C	40	NCB21HK-103X	.010MF 10X 50V	
A 21903	QNG0020-001Z	FUSE CLIP	FOR F1902		C	41	QEK61HM-104Z-JB	.10MF 20X 50V	
A 21904	QNG0020-001Z	FUSE CLIP	FOR F1902		C	42	QEK61HM-474Z-JB	.47MF 20X 50V	
A 21907	QNG0020-001Z	FUSE CLIP	V5R/EN ONLY		C	43	QEK61HM-335Z-JB	3.3MF 20X 50V	
A 21908	QNG0020-001Z	FUSE CLIP	V5R/EN ONLY		C	44	NCB21HK-221X	220PF 5X 50V	
					C	45	QEK41CM-106	V5R7E EN EV B	
					C	45	QEK41CM-106	V5/A	
					C	45	QEK61CM-106Z	V5R7EE	
					C	46	NCB21HK-223X	.022MF 10X 50V	
					C	47	NCB21HK-103X	.010MF 10X 50V	
					C	49	NCB21HK-183X	.018MF 10X 50V	
					C	50	NCB21HK-183X	.018MF 10X 50V	
					C	51	QEK41HM-105	V5/A	
					C	51	QEK61HM-105Z-JB	V5R7EE	
					C	51	QEK41HM-105	V5R7E EN EV B	
					C	52	QEK41HM-105	V5R7E EN EV B	
					C	52	QEK61HM-105Z-JB	V5R7EE	
					C	52	QEK41HM-105	V5/A	
					C	53	NCB21HK-681X	680PF 10X 50V	
					C	55	NCB21HK-120X	12PF 5X 50V	
					C	60	QEK61AM-107Z-JB	100MF 20X 10V	
					C	61	NCB21HK-120X	12PF 5X 50V	
					C	62	NCB21HK-120X	12PF 5X 50V	
					C	63	NCB21EK-473X	.047MF 10X 25V	
					C	65	NCB21HK-102X	1000PF 10X 50V	

BLOCK NO. 02111111					BLOCK NO. 02111111				
REF.	PARTS NO.	PARTS NAME	REMARKS	SUFFIX	REF.	PARTS NO.	PARTS NAME	REMARKS	SUFFIX
J1801	RPM693B-V4	RM. RECEIVER			Q8001	DT114TMA-X	TRANSISTOR		
J	QNR0014-001	ANT TERMINAL	AM/FM ANT COAX		R 1	NRSA02J-102X	RES. C-M	1.0K 5% 1/10W	
J3004	QNS0032-001	JACK			R 2	NRSA02J-820X	MG RESISTOR	82 5% 1/10W	
J5301	QNR0306-001	4PIN JACK ASSY	VSR/E EN EV B		R 3	NRSA02J-121X	MG RESISTOR	VSR/EE	
J5301	QNR0199-001	4PIN JACK ASSY	VSR/EE		R 3	NRSA02J-560X	MG RESISTOR	V5/A	
J5301	QNR0306-001	4PIN JACK ASSY	V5/A		R 5	NRSA02J-560X	MG RESISTOR	VSR/E EN EV B	
J5701	GP1F32T	OPTICAL JACK			R 3	NRSA02J-532X	MG RESISTOR	3.3K 5% 1/10W	
K3106	QGR0779-0012	INDUCTOR			R 10	NRSA02J-102X	RES. C-M	1.0K 5% 1/10W	
K3206	QGR0779-0012	INDUCTOR			R 13	NRSA02J-104X	MG RESISTOR	100K 5% 1/10W	
K5301	QGR0779-0012	INDUCTOR			R 15	NRSA02J-103X	RES. C-M	10K 5% 1/10W	
K5302	QGR0779-0012	INDUCTOR			R 16	NRSA02J-103X	RES. C-M	10K 5% 1/10W	
K5303	QGR0779-0012	INDUCTOR			R 20	NRSA02J-331X	MG RESISTOR	330 5% 1/10W	
K5307	QGR0779-0012	INDUCTOR			R 21	NRSA02J-224X	RES. C-M	220K 5% 1/10W	
L 1	QGR0870-001	COIL BLOCK	MW/LW RF/OSC		R 22	NRSA02J-331X	MG RESISTOR	330 5% 1/10W	
L 4	QGL231K-221Y	INDUCTOR			R 23	NRSA02J-100X	MG RESISTOR	10 5% 1/10W	
L 5	QGL231K-101Y	INDUCTOR	VSR/E EE EN EV		R 24	NRSA02J-271X	MG RESISTOR	270 5% 1/10W	
L 5	QGL231K-101Y	INDUCTOR	VSR/B		R 25	NRSA02J-473X	MG RESISTOR	47K 5% 1/10W	
L 10	QGR0794-001	TRAP COIL	VSR/E EN EV B		R 26	NRSA02J-153X	MG RESISTOR	15K 5% 1/10W	
L 10	QGR0794-001	TRAP COIL	V5/A		R 27	NRSA02J-223X	RES. C-M	22K 5% 1/10W	
L 11	QGL231K-2R7Y	INDUCTOR			R 29	NRSA02J-473X	MG RESISTOR	47K 5% 1/10W	
L 12	QGL231K-4R7Y	INDUCTOR	V5/A		R 30	NRSA02J-103X	RES. C-M	10K 5% 1/10W	
L 12	QGL231K-4R7Y	INDUCTOR	VSR/E EN EV B		R 31	NRSA02J-103X	RES. C-M	10K 5% 1/10W	
LF511	QGR0590-001	FILTER			R 34	NRSA02J-333X	MG RESISTOR	33K 5% 1/10W	
LF521	QGR0590-001	FILTER			R 35	NRSA02J-333X	MG RESISTOR	33K 5% 1/10W	
L3106	QGL231K-470Y	INDUCTOR			R 36	NRSA02J-103X	RES. C-M	10K 5% 1/10W	
L3206	QGL231K-470Y	INDUCTOR	FTZ		R 37	NRSA02J-472X	RES. C-M	4.7K 5% 1/10W	
L3301	QGL298J-470Z	INDUCTOR			R 38	NRSA02J-392X	MG RESISTOR	3.9K 5% 1/10W	
PP531	QZM0007-001	POST PIN			R 39	NRSA02J-392X	MG RESISTOR	3.9K 5% 1/10W	
PP532	QZM0007-001	POST PIN			R 42	NRSA02J-102X	RES. C-M	1.0K 5% 1/10W	
PP533	QZM0007-001	POST PIN			R 43	NRSA02J-102X	RES. C-M	1.0K 5% 1/10W	
Q 1	2SC2688/0/-T	TRANSISTOR			R 44	NRSA02J-102X	RES. C-M	1.0K 5% 1/10W	
Q 2	DTA114YKA-X	TRANSISTOR			R 45	NRSA02J-102X	RES. C-M	1.0K 5% 1/10W	
Q 3	KTC3199/7GL/-T	TR I/M			R 46	NRSA02J-473X	MG RESISTOR	47K 5% 1/10W	
Q 4	KTC3199/7GL/-T	TR I/M			R 48	NRSA02J-102X	RES. C-M	1.0K 5% 1/10W	
Q 6	DTA114YKA-X	TRANSISTOR			R 52	NRSA02J-472X	RES. C-M	4.7K 5% 1/10W	
Q 7	2SA1037AK/R/-X	CHIP TR. C-M			R 55	NRSA02J-472X	RES. C-M	4.7K 5% 1/10W	
Q 8	2SA1037AK/R/-X	CHIP TR. C-M			R 55	NRSA02J-182X	MG RESISTOR	1.8K 5% 1/10W	
Q 14	2SA1037AK/R/-X	CHIP TR. C-M			R 56	NRSA02J-332X	MG RESISTOR	3.3K 5% 1/10W	
Q5101	2SD2114K/VW/-X	CHIP TR. C-M			R 57	NRSA02J-102X	RES. C-M	1.0K 5% 1/10W	
Q5102	2SD2114K/VW/-X	CHIP TR. C-M			R 60	NRSA02J-102X	RES. C-M	1.0K 5% 1/10W	
Q5103	2SC2412K/R/-X	TRANSISTOR	CT		R 61	NRSA02J-102X	RES. C-M	1.0K 5% 1/10W	
Q5104	2SC2412K/R/-X	TRANSISTOR	W/O ASMD		R 65	NRSA02J-222X	MG RESISTOR	2.2K 5% 1/10W	
Q5106	2SC2412K/R/-X	TRANSISTOR			R 66	NRSA02J-222X	MG RESISTOR	2.2K 5% 1/10W	
Q5201	2SD2114K/VW/-X	CHIP TR. C-M			R 68	NRSA02J-473X	MG RESISTOR	47K 5% 1/10W	
Q5202	2SD2114K/VW/-X	CHIP TR. C-M			R 69	NRSA02J-222X	MG RESISTOR	2.2K 5% 1/10W	
Q5203	2SC2412K/R/-X	TRANSISTOR	CT		R 74	NRSA02J-332X	MG RESISTOR	3.3K 5% 1/10W	
Q5204	2SC2412K/R/-X	TRANSISTOR	W/O ASMD		R 75	NRSA02J-103X	RES. C-M	10K 5% 1/10W	
Q5206	2SC2412K/R/-X	TRANSISTOR			R 76	NRSA02J-102X	RES. C-M	VSR/E EE EN EV	
Q5301	DTA143EKA-X	TRANSISTOR			R 76	NRSA02J-102X	RES. C-M	VSR/B	
Q5302	DTA143EKA-X	TRANSISTOR			R 80	NRSA02J-222X	MG RESISTOR	VSR/B	
Q5303	DTA114EKA-X	DIGITAL-TR	CT		R 80	NRSA02J-222X	MG RESISTOR	VSR/E EE EN EV	
Q5308	DTA114EKA-X	DIGITAL-TR	W/O ASMD		R 82	NRSA02J-102X	RES. C-M	VSR/E EE EN EV	
Q5901	2SA1037AK/R/-X	CHIP TR. C-M			R 82	NRSA02J-102X	RES. C-M	VSR/B	
Q5902	2SC2412K/R/-X	TRANSISTOR			R 83	NRSA02J-102X	RES. C-M	VSR/B	
Q5903	2SD468/BC/-T	TRANSISTOR	CT		R 83	NRSA02J-102X	RES. C-M	VSR/E EE EN EV	

REF.	PARTS NO.	PARTS NAME	REMARKS	SUFFIX
A X7002	GAX0410-001	CERA LOCK	MAIN CK4.19MHZ	

REF.	PARTS NO.	PARTS NAME	REMARKS	SUFFIX
A R7139	NRSA02J-222X	MG RESISTOR	2.2K 5X 1/10W	
R7140	NRSA02J-102X	RES. C.M	1.0K 5X 1/10W	
R7141	NRSA02J-473X	MG RESISTOR	47K 5X 1/10W	
R7142	NRSA02J-473X	MG RESISTOR	47K 5X 1/10W	
R7143	NRSA02J-33X	MG RESISTOR	33K 5X 1/10W	
R7144	NRSA02J-252X	MG RESISTOR	2.2K 5X 1/10W	
R7145	NRSA02J-252X	MG RESISTOR	2.2K 5X 1/10W	
R7146	NRSA02J-222X	MG RESISTOR	2.2K 5X 1/10W	
R7147	NRSA02J-222X	MG RESISTOR	2.2K 5X 1/10W	
R7148	NRSA02J-222X	MG RESISTOR	2.2K 5X 1/10W	
R7149	NRSA02J-102X	RES. C.M	V5R7B	
R7149	NRSA02J-102X	RES. C.M	V5R7E EE EN EV	
R7150	NRSA02J-102X	RES. C.M	1.0K 5X 1/10W	
R7151	NRSA02J-222X	MG RESISTOR	2.2K 5X 1/10W	
R7152	NRSA02J-222X	MG RESISTOR	2.2K 5X 1/10W	
R7153	NRSA02J-222X	MG RESISTOR	2.2K 5X 1/10W	
R7154	NRSA02J-252X	MG RESISTOR	2.2K 5X 1/10W	
R7155	NRSA02J-252X	MG RESISTOR	2.2K 5X 1/10W	
R7156	NRSA02J-252X	MG RESISTOR	2.2K 5X 1/10W	
R7301	NRSA02J-473X	MG RESISTOR	47K 5X 1/10W	
R7302	NRSA02J-333X	MG RESISTOR	33K 5X 1/10W	
R7303	NRSA02J-104X	MG RESISTOR	100K 5X 1/10W	
R7304	NRSA02J-102X	RES. C.M	1.0K 5X 1/10W	
R7311	NRSA02J-103X	RES. C.M	10K 5X 1/10W	
R7312	NRSA02J-103X	RES. C.M	10K 5X 1/10W	
R7313	NRSA02J-103X	RES. C.M	10K 5X 1/10W	
R7314	NRSA02J-102X	RES. C.M	1.0K 5X 1/10W	
R7315	NRSA02J-103X	RES. C.M	10K 5X 1/10W	
R7321	NRSA02J-331X	MG RESISTOR	330 5X 1/10W	
R7322	NRSA02J-103X	RES. C.M	10K 5X 1/10W	
R7401	NRSA02J-103X	RES. C.M	10K 5X 1/10W	
R7402	NRSA02J-103X	RES. C.M	10K 5X 1/10W	
R7403	NRSA02J-103X	RES. C.M	10K 5X 1/10W	
R7404	NRSA02J-103X	RES. C.M	10K 5X 1/10W	
R7405	NRSA02J-103X	RES. C.M	10K 5X 1/10W	
R7406	NRSA02J-103X	RES. C.M	10K 5X 1/10W	
R7407	NRSA02J-103X	RES. C.M	10K 5X 1/10W	
R7408	NRSA02J-273X	MG RESISTOR	V5R7E EN EV B	
R7408	NRSA02J-153X	MG RESISTOR	V5R7EE V5/A	
R7409	NRSA02J-153X	MG RESISTOR	V5R7EE V5/A	
R7410	NRSA02J-103X	RES. C.M	10K 5X 1/10W	
R7411	NRSA02J-103X	RES. C.M	10K 5X 1/10W	
R7801	NRSA02J-114X	RES. C.M	110K 5X 1/10W	
R7802	NRSA02J-114X	RES. C.M	110K 5X 1/10W	
R7803	NRSA02J-683X	MG RESISTOR	68K 5X 1/10W	
R7804	NRSA02J-105X	MG RESISTOR	1.0M 5X 1/10W	
R7805	NRSA02J-683X	MG RESISTOR	68K 5X 1/10W	
R7811	NRSA02J-823X	MG RESISTOR	82K 5X 1/10W	
R7812	NRSA02J-394X	RES. C.M	390K 5X 1/10W	
R7813	NRSA02J-104X	MG RESISTOR	100K 5X 1/10W	
R7821	NRSA02J-103X	RES. C.M	10K 5X 1/10W	
R7822	NRSA02J-475X	MG RESISTOR	47K 5X 1/10W	
R7823	NRSA02J-152X	MG RESISTOR	1.2K 5X 1/10W	
R7824	NRSA02J-122X	MG RESISTOR	1.2K 5X 1/10W	
X7001	GAX0401-001	CRYSTAL	CLOCK(36.678KHZ)	

BLOCK NO. 04111111

REF.	PARTS NO.	PARTS NAME	REMARKS	SUFFIX
R6060	NRSA02J-471X	RES. C.M	470 5X 1/10W	
R6061	NRSA02J-104X	MG RESISTOR	100K 5X 1/10W	
R6063	NRSA02J-124X	MG RESISTOR	120K 5X 1/10W	
R6064	NRSA02J-681X	MG RESISTOR	680 5X 1/10W	
R6066	NRSA02J-220X	MG RESISTOR	22 5X 1/10W	
R6067	NRSA02J-220X	MG RESISTOR	22 5X 1/10W	
R6068	NRSA02J-220X	MG RESISTOR	22 5X 1/10W	
R6069	NRSA02J-155X	MG RESISTOR	1.5M 5X 1/10W	
R6071	NRSA02J-102X	RES. C.M	1.0K 5X 1/10W	
R6072	NRSA02J-102X	RES. C.M	1.0K 5X 1/10W	
R6076	NRSA02J-0R0X	RES. C.M	5X 1/10W	
R6080	NRSA02J-0R0X	RES. C.M	5X 1/10W	
R6081	NRSA02J-0R0X	RES. C.M	5X 1/10W	
R6121	NRSA02J-101X	MG RESISTOR	100 5X 1/10W	
W 814	GJK018-031203	SIN CR C-B WIRE		
W 815	GJL006-021302	SIN CR B-B WIRE		
W3004	GJK017-052600	SIN CR C-B WIRE		
W3351	GJP003-042401	SHI CR C-B WIRE		
W5501	GJK018-020802	SIN CR C-B WIRE		
X6051	QAX0413-001Z	CRYSTAL		

Function/Tuner Board

REF.	PARTS NO.	PARTS NAME	REMARKS	SUFFIX
R3951	QR79008-4R7X	F RESISTOR	4.7 1/0W	
R3952	QR1411-102Y	C RESISTOR	1.0K 5X 1/4W	
R3953	QR1411-103Y	C RESISTOR	10K 5X 1/4W	
R3954	QR1411-103Y	C RESISTOR	10K 5X 1/4W	
R5501	QR1411-102Y	C RESISTOR	1.0K 5X 1/4W	
R5502	QR1411-102Y	C RESISTOR	1.0K 5X 1/4W	
R5503	QR1411-122Y	C RESISTOR	1.2K 5X 1/4W	
R5504	QR1411-152Y	C RESISTOR	1.5K 5X 1/4W	
R5505	QR1411-222Y	C RESISTOR	2.2K 5X 1/4W	
R5506	QR1411-272Y	C RESISTOR	2.7K 5X 1/4W	
R5507	QR1411-392Y	C RESISTOR	3.9K 5X 1/4W	
R5508	QR1411-562Y	C RESISTOR	5.6K 5X 1/4W	
R9701	QR79008-4R7X	F RESISTOR	4.7 1/0W	
S5501	QSW0698-001Z	TACT SWITCH	REC	
S5502	QSW0698-001Z	TACT SWITCH	REV.MODE	
S5504	QSW0698-001Z	TACT SWITCH	SLEEP	
S5505	QSW0698-001Z	TACT SWITCH	CLOCK	
S5506	QSW0698-001Z	TACT SWITCH	TIMER	
S5507	QSW0698-001Z	TACT SWITCH	VOL.UP	
S5508	QSW0698-001Z	TACT SWITCH	VOL.DOWN	
S5509	QSW0698-001Z	TACT SWITCH	AHB	
W3303	GJK019-030703	SIN CR C-B WIRE	V3/EN ONLY	
Z1901	QNG0020-001Z	FUSE CLIP	FOR F1901	
Z1902	QNG0020-001Z	FUSE CLIP	FOR F1901	
Z1903	QNG0020-001Z	FUSE CLIP	FOR F1902	
Z1904	QNG0020-001Z	FUSE CLIP	FOR F1902	
Z1907	QNG0020-001Z	FUSE CLIP	V3/EN ONLY	
Z1908	QNG0020-001Z	FUSE CLIP	V3/EN ONLY	

REF.	PARTS NO.	PARTS NAME	REMARKS	SUFFIX
C 1	NCB21HK-223X	C CAPACITOR	.022MF 10X 50V	
C 2	NCB21HK-103X	C CAPACITOR	.010MF 10X 50V	
C 3	NCB21EK-473X	C CAPACITOR	.047MF 10X 25V	
C 4	NCB21HK-103X	C CAPACITOR	.010MF 10X 50V	
C 5	QEK41CM-106	E CAPACITOR	10MF 20X 16V	
C 6	NCB21HK-102X	C CAPACITOR	1000PF 10X 50V	
C 7	NCB21HK-102X	C CAPACITOR	1000PF 5X 50V	
C 8	NCB21HJ-150X	C CAPACITOR	1500PF 10X 50V	
C 9	NCB21HK-102X	C CAPACITOR	1000PF 10X 50V	
C 10	NCB21HK-102X	C CAPACITOR	1000PF 10X 50V	
C 11	NCB21HK-102X	C CAPACITOR	1000PF 10X 50V	
C 12	NCS21HJ-150X	C CAPACITOR	.047MF 10X 25V	
C 13	NCB21EK-473X	C CAPACITOR	1000PF 10X 50V	
C 14	NCB21HK-102X	C CAPACITOR	1000PF 10X 50V	
C 15	NCB21HK-103X	C CAPACITOR	1000PF 10X 50V	
C 16	NCB21HK-102X	C CAPACITOR	1000PF 10X 50V	
C 17	NCB21HK-103X	C CAPACITOR	.010MF 10X 50V	
C 18	NCB21HK-103X	C CAPACITOR	.010MF 10X 50V	
C 19	NCB21HK-122X	C CAPACITOR	1200PF 10X 50V	
C 20	NCB21EK-473X	C CAPACITOR	.047MF 10X 25V	
C 21	NCB21EK-473X	C CAPACITOR	.047MF 10X 25V	
C 22	QEK61CM-474Z-JB	E CAPACITOR	47MF 20X 16V	
C 23	NCS21HJ-390X	C CAPACITOR	39PF 5X 50V	
C 24	NCB21HK-102X	C CAPACITOR	1000PF 10X 50V	
C 25	QEK61AM-107Z-JB	E CAPACITOR	100MF 20X 10V	
C 26	NCS21HJ-150X	C CAPACITOR	15PF 5X 50V	
C 27	NCB21HK-102X	C CAPACITOR	1000PF 10X 50V	
C 28	QEK41CM-106	E CAPACITOR	V3/EV	
C 29	QEK41CM-106	E CAPACITOR	V3/EE EN B A	
C 30	NCB21EK-473X	C CAPACITOR	.047MF 10X 25V	
C 31	NCB21HK-103X	C CAPACITOR	.010MF 10X 50V	
C 32	NCB21HK-103X	C CAPACITOR	.010MF 10X 50V	
C 33	NCB21HK-103X	C CAPACITOR	.010MF 10X 50V	
C 34	NCB21HK-103X	C CAPACITOR	.010MF 10X 50V	
C 35	NCB21HK-103X	C CAPACITOR	.010MF 10X 50V	
C 36	QEK41CM-106	E CAPACITOR	V3/EE EN B A	
C 37	NCB21EK-473X	C CAPACITOR	.047MF 10X 25V	
C 38	NCB21EK-473X	C CAPACITOR	.047MF 10X 25V	
C 39	NCB21EK-473X	C CAPACITOR	.047MF 10X 25V	
C 40	NCB21HK-103X	C CAPACITOR	.010MF 10X 50V	
C 41	QEK61HM-104Z-JB	E CAPACITOR	.10MF 20X 50V	
C 42	QEK61HM-474Z-JB	E CAPACITOR	.47MF 20X 50V	
C 43	QEK61HM-335Z-JB	E CAPACITOR	3.3MF 20X 50V	
C 44	NCS21HJ-221X	C CAPACITOR	220PF 5X 50V	
C 45	QEK41CM-106	E CAPACITOR	V3/EE EN B A	
C 46	QEK41CM-106	E CAPACITOR	V3/EE EN B A	
C 47	NCB21HK-223X	C CAPACITOR	.022MF 10X 50V	
C 48	NCB21HK-103X	C CAPACITOR	.010MF 10X 50V	
C 49	NCB21HK-183X	C CAPACITOR	.018MF 10X 50V	
C 50	NCB21HK-183X	C CAPACITOR	.018MF 10X 50V	
C 51	QEK41HM-105	E CAPACITOR	V3/EE EN B A	
C 52	QEK41HM-105	E CAPACITOR	V3/EE EN B A	
C 53	QEK41HM-105	E CAPACITOR	V3/EE EN B A	
C 54	QEK41HM-105	E CAPACITOR	V3/EE EN B A	
C 55	NCB21HK-681X	C CAPACITOR	680PF 10X 50V	
C 56	NCS21HJ-120X	C CAPACITOR	12PF 5X 50V	
C 57	QEK61AM-107Z-JB	E CAPACITOR	100MF 20X 10V	
C 58	NCS21HJ-120X	C CAPACITOR	12PF 5X 50V	
C 59	NCS21HJ-120X	C CAPACITOR	12PF 5X 50V	
C 60	NCS21HJ-120X	C CAPACITOR	12PF 5X 50V	
C 61	NCS21HJ-120X	C CAPACITOR	12PF 5X 50V	
C 62	NCS21HJ-120X	C CAPACITOR	12PF 5X 50V	
C 63	NCB21EK-473X	C CAPACITOR	.047MF 10X 25V	
C 64	NCB21HK-102X	C CAPACITOR	1000PF 10X 50V	
C 65	NCB21HK-102X	C CAPACITOR	1000PF 10X 50V	
C 66	NCS21HJ-151X	C CAPACITOR	1500PF 5X 50V	
C 67	NCS21HJ-101X	C CAPACITOR	1000PF 5X 50V	
C 68	NCS21HJ-101X	C CAPACITOR	1000PF 5X 50V	
C 69	QEK61HM-225Z-JB	E CAPACITOR	2.2MF 20X 50V	

BLOCK NO. 0611111					BLOCK NO. 0611111						
A	REF.	PARTS NO.	PARTS NAME	REMARKS	SUFFIX	A	REF.	PARTS NO.	PARTS NAME	REMARKS	SUFFIX
C	70	NCB21HK-332X	C CAPACITOR	3900PF 10X 50V		C5902	GER61CM-107Z		E-CAPAC. I.M	100MF 20X 16V	
C	71	QEK61HM-335Z-JB	E CAPACITOR	3.3MF 20X 50V		C5903	QER41CM-476		E CAPACITOR	47MF 20X 16V	
C	72	NCB21HK-102X	C CAPACITOR	1000PF 10X 50V		C8001	QER41AM-107		E CAPACITOR	100MF 20X 10V	
C	91	NCB21HK-103X	C CAPACITOR	.010MF 10X 50V		C8002	NCB21HK-103X		C CAPACITOR	.010MF 10X 50V	
C	92	NCB21HK-103X	C CAPACITOR	.010MF 10X 50V		C8001	NCB21HK-223X		C CAPACITOR	.025MF 10X 50V	
C	93	NCB21HK-103X	C CAPACITOR	.010MF 10X 50V		C8002	NCB21HK-101X		C CAPACITOR	100PF 5X 50V	
C	95	NCB21HK-102X	C CAPACITOR	1000PF 10X 50V		D	1 1SS133-T2		DIODE		
CF	1	GAX0420-001	C FILTER	V3/E EN EV B A		D	2 1SS133-T2		DIODE		
CF	1	GAX0403-001	C FILTER	V3/EE		D	3 1SS133-T2		DIODE		
CF	2	GAX0403-001	C FILTER	V3/EE		D	4 1SS133-T2		DIODE		
CF	3	GAX0421-001	C FILTER	V3/EE							
CF	3	GAX0418-001Z	C FILTER	V3/EE		D1801	QLD0079-001		LCD MODULE		
CF	4	GAX0409-001	CERA LOCK			D5301	MTZJ3.5B-T2		ZENER DIODE I/M		
CN	43	GGF1201F3-09	CONNECTOR			D5302	1SS133-T2		DIODE		
CM	44	GGF1201F3-10	CONNECTOR			D5303	1SS133-T2		DIODE		
CS01		GGZ2001F1-04	4P PLUG ASSY			D5304	1SS133-T2		DIODE		
CS02		GGF1201C3-10	CONNECTOR	MD6P		D5901	MYZJ3.9B-T2		Z DIODE		
CS03		VNC00289-P12	CONNECTOR	VC012P		D5902	1SS133-T2		DIODE		
CS04		GGZ2001F1-03	CONNECTOR			D5903	1SS133-T2		DIODE		
CS06		GGB1214J1-12S	CONNECTOR			D5906	1SS133-T2		DIODE		
CS07		QGB1214J1-12S	CONNECTOR			D8001	SPR-39MVWF		LED	RED	
CS08		QGA2001F1-02	2P CONNECTOR			D8003	1SS133-T2		DIODE		
CS09		QGF1016F1-07	CONNECTOR			D8301	SELU1E56BM		LED		
CS10		QGF1008F1-11	CONNECTOR			D8302	SELU1E56BM		LED		
CS10B		NCB21HJ-331X	C CAPACITOR	330PF 5X 50V		D8303	SELU1E56BM		LED		
CS10B		NCB21HJ-331X	C CAPACITOR	330PF 5X 50V		EP501	QNZ0136-001Z		EARTH PLATE		
CS101		NCB21HJ-151X	C CAPACITOR	150PF 5X 50V		IC	1 TA2057N		IC		
CS102		QFM41HJ-562	M CAPACITOR	5600PF 5X 50V		IC	2 LC72136N		IC		
CS103		QTE1H06-475Z	C CAPACITOR	10PF 5X 50V		IC531	BA15218F-XE		RM. RECEIVER		
CS104		NCB21HJ-330X	C CAPACITOR	33PF 5X 50V		IC801	RFM6938-V4		ANTI TERMINAL		
CS104		NCB21HJ-100X	C CAPACITOR	10PF 5X 50V		J	1 QNB0014-001		JACK	AM/FM ANT COAX	
CS107		QER41HM-475	E CAPACITOR	4.7MF 20X 50V		J3004	QNS0032-001		4PIN JACK ASSY	A5MD 2P	
CS108		QER41HM-475	E CAPACITOR	4.7MF 20X 50V		J5701	GP1F32T		OPTICAL JACK	MD 32R	
CS109		NCB21HK-102X	C CAPACITOR	1000PF 10X 50V		K3106	QQR0779-001Z		INDUCTOR		
CS110		QER41HM-475	E CAPACITOR	4.7MF 20X 50V		K3206	QQR0779-001Z		INDUCTOR		
CS201		NCB21HJ-151X	C CAPACITOR	150PF 5X 50V		K5301	QQR0779-001Z		INDUCTOR		
CS202		QFN41HJ-562	M CAPACITOR	5600PF 5X 50V		K5302	QQR0779-001Z		INDUCTOR		
CS203		QTE1H06-475Z	E CAPACITOR	33PF 5X 50V		K5303	QQR0779-001Z		INDUCTOR		
CS205		NCB21HJ-330X	C CAPACITOR	10PF 5X 50V		K5307	QQR0779-001Z		INDUCTOR		
CS206		NCB21HJ-100X	C CAPACITOR	10PF 5X 50V		L	1 QGR0870-001		COIL BLOCK	MW/LW RF/O5C	
CS207		QER41HM-475	E CAPACITOR	4.7MF 20X 50V		L	4 QGL233K-221V		INDUCTOR		
CS208		QER41HM-475	E CAPACITOR	4.7MF 20X 50V		L	10 QGR0794-001		TRAP COIL	V3/E EN EV B A	
CS209		NCB21HK-102X	C CAPACITOR	1000PF 10X 50V		L	11 QGL233K-2R7Y		INDUCTOR		
CS210		QER41HM-475	E CAPACITOR	4.7MF 20X 50V		L	12 QGL233K-4R7Y		INDUCTOR		
CS301		NCB21HK-103X	C CAPACITOR	.010MF 10X 50V		LF511	QQR0590-001		FILTER		
CS302		QER41HM-225	E CAPACITOR	2.2MF 20X 50V		LF521	QQR0590-001		FILTER		
CS303		QER41HM-225	E CAPACITOR	2.2MF 20X 50V		L3106	QGL233K-470Y		INDUCTOR		
CS304		QER41HM-105	E CAPACITOR	1.0MF 20X 50V		L3206	QGL233K-470Y		INDUCTOR		
CS307		QER41CM-476	E CAPACITOR	47MF 20X 16V		L3301	QGL298J-470Z		INDUCTOR	FTZ	
CS308		QER41CM-226	E CAPACITOR	22MF 20X 16V		PP531	QZM0007-001		POST PIN		
CS309		QER41HM-105	E CAPACITOR	1.0MF 20X 50V		PP532	QZM0007-001		POST PIN		
CS311		NCB21HK-102X	C CAPACITOR	1000PF 10X 50V		PP533	QZM0007-001		POST PIN		
CS312		NCB21HK-103X	C CAPACITOR	.010MF 10X 50V		Q	1 25C2668/07-T		TRANSISTOR		
CS313		NCF21HZ-104X	C CAPACITOR	.10MF +80:-20X		q	2 DIA114YKA-X		TRANSISTOR		
CS301		QER41EM-475	E CAPACITOR	4.7MF 20X 25V							

BLOCK NO. 041111111

BLOCK NO. 041111111

REF.	PARTS NO.	PARTS NAME	REMARKS	SUFFIX
Q 4	KTC199/G1/-I	TR I/M		
Q 5	KTC3199/GL/-I	TR I/M		
Q 6	DTA114YKA-X	TRANSISTOR		
Q 7	2SA1037AK/R/-X	CHIP TR.C.M		
Q 8	2SA1037AK/R/-X	CHIP TR.C.M		
Q 14	2SA1037AK/R/-X	CHIP TR.C.M		
Q 15	2SD2114K/VW/-X	CHIP TR.C.M		
Q 5101	2SD2114K/VW/-X	CHIP TR.C.M		
Q 5102	2SD2114K/VW/-X	CHIP TR.C.M		
Q 5103	2SC2412K/R/-X	TRANSISTOR		
Q 5104	2SC2412K/R/-X	TRANSISTOR		
Q 5106	2SC2412K/R/-X	TRANSISTOR		
Q 5201	2SD2114K/VW/-X	CHIP TR.C.M		
Q 5202	2SD2114K/VW/-X	CHIP TR.C.M		
Q 5203	2SC2412K/R/-X	TRANSISTOR		
Q 5204	2SC2412K/R/-X	TRANSISTOR		
Q 5206	2SC2412K/R/-X	TRANSISTOR		
Q 5301	DTA143EKA-X	TRANSISTOR		
Q 5302	DTA143EKA-X	TRANSISTOR		
Q 5303	DTA114EKA-X	DIGITAL TR		
Q 5308	DTA114EKA-X	DIGITAL TR		
Q 5901	2SA1037AK/R/-X	CHIP TR.C.M		
Q 5902	2SC2412K/R/-X	TRANSISTOR		
Q 5903	2SD468/BG/-I	TRANSISTOR		
Q 8001	DTA114TKA-X	TRANSISTOR		
R 1	NRSA02J-102X	RES. C.M	1.0K 5% 1/10W	
R 2	NRSA02J-820X	MG RESISTOR	82 5% 1/10W	
R 3	NRSA02J-560X	MG RESISTOR	V3/E	
R 4	NRSA02J-121X	MG RESISTOR	V3/EE	
R 10	NRSA02J-532X	MG RESISTOR	3.3K 5% 1/10W	
R 12	NRSA02J-102X	RES. C.M	1.0K 5% 1/10W	
R 13	NRSA02J-104X	MG RESISTOR	100K 5% 1/10W	
R 15	NRSA02J-103X	RES. C.M	10K 5% 1/10W	
R 16	NRSA02J-103X	RES. C.M	10K 5% 1/10W	
R 20	NRSA02J-331X	MG RESISTOR	330 5% 1/10W	
R 21	NRSA02J-224X	RES. C.M	220K 5% 1/10W	
R 22	NRSA02J-331X	MG RESISTOR	330 5% 1/10W	
R 23	NRSA02J-100X	MG RESISTOR	10 5% 1/10W	
R 24	NRSA02J-271X	MG RESISTOR	270 5% 1/10W	
R 25	NRSA02J-673X	MG RESISTOR	47K 5% 1/10W	
R 26	NRSA02J-153X	MG RESISTOR	15K 5% 1/10W	
R 27	NRSA02J-223X	RES. C.M	22K 5% 1/10W	
R 29	NRSA02J-473X	MG RESISTOR	47K 5% 1/10W	
R 30	NRSA02J-103X	RES. C.M	10K 5% 1/10W	
R 31	NRSA02J-103X	RES. C.M	10K 5% 1/10W	
R 34	NRSA02J-333X	MG RESISTOR	33K 5% 1/10W	
R 35	NRSA02J-333X	MG RESISTOR	33K 5% 1/10W	
R 36	NRSA02J-103X	RES. C.M	10K 5% 1/10W	
R 37	NRSA02J-472X	RES. C.M	4.7K 5% 1/10W	
R 38	NRSA02J-392X	MG RESISTOR	3.9K 5% 1/10W	
R 39	NRSA02J-392X	MG RESISTOR	3.9K 5% 1/10W	
R 42	NRSA02J-102X	RES. C.M	1.0K 5% 1/10W	
R 43	NRSA02J-102X	RES. C.M	1.0K 5% 1/10W	
R 44	NRSA02J-102X	RES. C.M	1.0K 5% 1/10W	
R 45	NRSA02J-102X	RES. C.M	1.0K 5% 1/10W	
R 46	NRSA02J-473X	MG RESISTOR	47K 5% 1/10W	
A 48	NRSA02J-102X	RES. C.M	1.0K 5% 1/10W	
R 52	NRSA02J-472X	RES. C.M	4.7K 5% 1/10W	
R 54	NRSA02J-472X	RES. C.M	4.7K 5% 1/10W	
R 55	NRSA02J-182X	MG RESISTOR	1.8K 5% 1/10W	
R 56	NRSA02J-332X	MG RESISTOR	3.3K 5% 1/10W	
R 57	NRSA02J-102X	RES. C.M	1.0K 5% 1/10W	
R 60	NRSA02J-102X	RES. C.M	1.0K 5% 1/10W	
R 61	NRSA02J-102X	RES. C.M	1.0K 5% 1/10W	
R 65	NRSA02J-222X	MG RESISTOR	2.2K 5% 1/10W	
R 66	NRSA02J-222X	MG RESISTOR	2.2K 5% 1/10W	
R 68	NRSA02J-473X	MG RESISTOR	47K 5% 1/10W	
R 69	NRSA02J-222X	MG RESISTOR	2.2K 5% 1/10W	
R 74	NRSA02J-332X	MG RESISTOR	3.3K 5% 1/10W	
R 75	NRSA02J-103X	RES. C.M	10K 5% 1/10W	
R 1106	NRSA02J-151X	MG RESISTOR	150 5% 1/10W	
R 3107	NRSA02J-471X	RES. C.M	470 5% 1/10W	
R 3206	NRSA02J-151X	MG RESISTOR	150 5% 1/10W	
R 3207	NRSA02J-471X	RES. C.M	470 5% 1/10W	
R 5101	NRSA02J-513X	MG RESISTOR	51K 5% 1/10W	
R 5102	NRSA02J-273X	MG RESISTOR	27K 5% 1/10W	
R 5103	NRSA02J-153X	MG RESISTOR	15K 5% 1/10W	
R 5104	NRSA02J-222X	MG RESISTOR	2.2K 5% 1/10W	
R 5105	NRSA02J-222X	MG RESISTOR	2.2K 5% 1/10W	
R 5106	NRSA02J-153X	MG RESISTOR	15K 5% 1/10W	
R 5107	NRSA02J-122X	MG RESISTOR	1.2K 5% 1/10W	
R 5108	NRSA02J-682X	MG RESISTOR	6.8K 5% 1/10W	
R 5109	NRSA02J-322X	MG RESISTOR	2.2K 5% 1/10W	
R 5110	NRSA02J-182X	MG RESISTOR	1.8K 5% 1/10W	
R 5111	NRSA02J-123X	RES. C.M	12K 5% 1/10W	
R 5112	NRSA02J-472X	RES. C.M	4.7K 5% 1/10W	
R 5113	NRSA02J-153X	MG RESISTOR	15K 5% 1/10W	
R 5114	NRSA02J-222X	MG RESISTOR	2.2K 5% 1/10W	
R 5115	NRSA02J-103X	RES. C.M	10K 5% 1/10W	
R 5116	NRSA02J-753X	MG RESISTOR	75K 5% 1/10W	
R 5122	NRSA02J-102X	RES. C.M	1.0K 5% 1/10W	
R 5123	NRSA02J-154X	RES. C.M	150K 5% 1/10W	
R 5124	NRSA02J-473X	MG RESISTOR	47K 5% 1/10W	
R 5125	NRSA02J-332X	MG RESISTOR	3.3K 5% 1/10W	
R 5126	NRSA02J-102X	RES. C.M	1.0K 5% 1/10W	
R 5127	NRSA02J-682X	MG RESISTOR	2.2K 5% 1/10W	
R 5128	NRSA02J-222X	MG RESISTOR	2.2K 5% 1/10W	
R 5129	NRSA02J-182X	MG RESISTOR	1.8K 5% 1/10W	
R 5201	NRSA02J-513X	MG RESISTOR	51K 5% 1/10W	
R 5202	NRSA02J-273X	MG RESISTOR	27K 5% 1/10W	
R 5203	NRSA02J-153X	MG RESISTOR	15K 5% 1/10W	
R 5204	NRSA02J-182X	MG RESISTOR	1.8K 5% 1/10W	
R 5205	NRSA02J-153X	MG RESISTOR	15K 5% 1/10W	
R 5206	NRSA02J-153X	MG RESISTOR	1.2K 5% 1/10W	
R 5207	NRSA02J-122X	MG RESISTOR	6.8K 5% 1/10W	
R 5208	NRSA02J-682X	MG RESISTOR	2.2K 5% 1/10W	
R 5209	NRSA02J-222X	MG RESISTOR	1.8K 5% 1/10W	
R 5210	NRSA02J-182X	MG RESISTOR	12K 5% 1/10W	
R 5211	NRSA02J-123X	RES. C.M	4.7K 5% 1/10W	
R 5212	NRSA02J-472X	RES. C.M	15K 5% 1/10W	
R 5213	NRSA02J-153X	MG RESISTOR	15K 5% 1/10W	

BLOCK NO. 06		BLOCK NO. 06		BLOCK NO. 06		BLOCK NO. 06			
REF.	PARTS NO.	PARTS NAME	REMARKS	SUFFIX	REF.	PARTS NO.	PARTS NAME	REMARKS	SUFFIX
R5214	NRSA02J-223X	MG RESISTOR	2.2K 5% 1/10W		S8102	QSM0620-001	SWITCH		
R5215	NRSA02J-103X	RES. C.M	10K 5% 1/10W		T	QQR0793-001	IFT		
R5216	NRSA02J-753X	MG RESISTOR	75K 5% 1/10W		TU	GAU0034-001	FRONT END	V3 /E EN EV B A	
R5222	NRSA02J-105X	RES. C.M	1.0K 5% 1/10W		TU	GAU0036-001	FRONT END	V3/EE	
R5223	NRSA02J-154X	RES. C.M	150K 5% 1/10W		X	QAX0402-001	CRYSTAL		
R5224	NRSA02J-473X	MG RESISTOR	47K 5% 1/10W						
R5225	NRSA02J-332X	MG RESISTOR	3.3K 5% 1/10W						
R5226	NRSA02J-102X	RES. C.M	1.0K 5% 1/10W						
R5227	NRSA02J-222X	MG RESISTOR	2.2K 5% 1/10W						
R5228	NRSA02J-222X	MG RESISTOR	2.2K 5% 1/10W						
R5230	NRSA02J-182X	MG RESISTOR	1.8K 5% 1/10W						
R5301	NRSA02J-822X	MG RESISTOR	8.2K 5% 1/10W						
R5302	NRSA02J-822X	MG RESISTOR	8.2K 5% 1/10W						
R5303	NRSA02J-750X	RES. C.M	75 5% 1/10W						
R5304	NRSA02J-750X	RES. C.M	75 5% 1/10W						
R5305	NRSA02J-750X	RES. C.M	75 5% 1/10W						
R5306	NRSA02J-223X	RES. C.M	22K 5% 1/10W						
R5311	NRSA02J-750X	RES. C.M	75 5% 1/10W						
R5312	NRSA02J-473X	MG RESISTOR	47K 5% 1/10W						
R5313	NRSA02J-513X	MG RESISTOR	51K 5% 1/10W						
R5314	NRSA02J-223X	RES. C.M	22K 5% 1/10W						
R5901	NRSA02J-390X	MG RESISTOR	39 5% 1/10W						
R5902	NRSA02J-332X	MG RESISTOR	3.3K 5% 1/10W						
R5903	NRSA02J-272X	MG RESISTOR	27K 5% 1/10W						
R5904	NRSA02J-102X	RES. C.M	1.0K 5% 1/10W						
R5905	NRSA02J-471X	RES. C.M	470 5% 1/10W						
R5906	NRSA02J-471X	RES. C.M	470 5% 1/10W						
R5907	NRSA02J-392X	MG RESISTOR	3.9K 5% 1/10W						
R5908	NRSA02J-332X	MG RESISTOR	3.3K 5% 1/10W						
R8001	NRSA02J-102X	RES. C.M	1.0K 5% 1/10W						
R8002	NRSA02J-102X	RES. C.M	1.0K 5% 1/10W						
R8003	NRSA02J-122X	MG RESISTOR	1.2K 5% 1/10W						
R8004	NRSA02J-152X	MG RESISTOR	1.5K 5% 1/10W						
R8005	NRSA02J-222X	MG RESISTOR	2.2K 5% 1/10W						
R8006	NRSA02J-222X	MG RESISTOR	2.2K 5% 1/10W						
R8007	NRSA02J-322X	MG RESISTOR	3.2K 5% 1/10W						
R8010	NRSA02J-681X	MG RESISTOR	680 5% 1/10W						
R8011	GRE141J-152Y	C RESISTOR	1.5K 5% 1/4W						
R8201	NRSA02J-432X	RES. C.M	4.3K 5% 1/10W						
R8301	NRSA02J-471X	RES. C.M	470 5% 1/10W						
R8302	NRSA02J-471X	RES. C.M	470 5% 1/10W						
R8303	NRSA02J-471X	RES. C.M	470 5% 1/10W						
R8304	NRSA02J-471X	RES. C.M	470 5% 1/10W						
R8305	NRSA02J-471X	RES. C.M	470 5% 1/10W						
R8306	NRSA02J-471X	RES. C.M	470 5% 1/10W						
S8001	QSM0698-001Z	TACT SWITCH	DOOR OP7/CL						
S8002	QSM0698-001Z	TACT SWITCH	CD						
S8003	QSM0698-001Z	TACT SWITCH	TUNER						
S8004	QSM0698-001Z	TACT SWITCH	TAPE						
S8005	QSM0698-001Z	TACT SWITCH	MD/AUX						
S8006	QSM0698-001Z	TACT SWITCH	B-SEARCH						
S8007	QSM0698-001Z	TACT SWITCH	STOP/CLR						
S8008	QSM0698-001Z	TACT SWITCH	F-SEARCH						
S8010	QSM0698-001Z	TACT SWITCH	POWER						
S8101	QSM0620-001	SWITCH							

■ Micon Board

BLOCK NO. 07			BLOCK NO. 07						
REF.	PARTS NO.	PARTS NAME	REMARKS	SUFFIX	REF.	PARTS NO.	PARTS NAME	REMARKS	SUFFIX
CN701	GGF201FJ3-13	CONNECTOR	TO CD PWB		Q7002	25C2668/07-T	TRANSISTOR	CLOCK SHIFT	
CN706	GGB1214K1-12S	CONNECTOR	TO FUNCTION PWB		Q7301	25C2412K/R/-X	TRANSISTOR	BACKUP CONT	
CN707	GGB1214K1-12S	CONNECTOR	TO FUNCTION PWB		Q7311	25C2412K/R/-X	TRANSISTOR	RESET	
CN711	GGF1016C1-07	CONNECTOR	TO FKEY PWB		Q7321	25A1037AK/R/-X	CHIP TR.C.M	PHOTO BUFFER	
CN712	GGF1008F1-11	CONNECTOR	TO LCD PWB		Q7811	25C2412K/R/-X	TRANSISTOR		
CN714	OGA2001C1-03	3P PLUG ASSY	TO DOOR-SW PWB		Q7821	DT116EKA-X	TR	BL DIMMER	
CN717	OGB1214J1-12S	CONNECTOR	TO MAIN PWB		Q7822	2SA935S/RS/-T	MG DIMMER		
CN772	OGB1214J1-12S	CONNECTOR	TO MAIN PWB		R7001	MRS002J-822X	MG RESISTOR	8.2K 5% 1/10W	
C7001	NCS214J-180X	C CAPACITOR	18PF 5% 50V		R7002	MRS005J-822X	MG RESISTOR	8.2K 5% 1/10W	
C7002	NCS214J-180X	C CAPACITOR	18PF 5% 50V		R7003	MRS005J-103X	RES. C.M	10K 5% 1/10W	
C7003	NCS214J-300X	C CAPACITOR	39PF 5% 50V		R7004	MRS002J-103X	RES. C.M	10K 5% 1/10W	
C7004	NCS214J-360X	C CAPACITOR	36PF 5% 50V		R7005	MRS002J-102X	RES. C.M	1.0K 5% 1/10W	
C7005	NCS214J-250X	C CAPACITOR	22PF 5% 50V		R7101	MRS002J-222X	MG RESISTOR	2.2K 5% 1/10W	
C7006	NCS214J-200X	C CAPACITOR	20PF 5% 50V		R7102	MRS002J-222X	MG RESISTOR	2.2K 5% 1/10W	
C7007	NCB214K-102X	C CAPACITOR	1000PF 10% 50V		R7103	MRS002J-222X	MG RESISTOR	2.2K 5% 1/10W	
C7008	NCB214K-102X	C CAPACITOR	1000PF 10% 50V		R7104	MRS002J-222X	MG RESISTOR	2.2K 5% 1/10W	
C7011	GER414M-107	E CAPACITOR	10MF 20% 10V		R7105	MRS002J-102X	RES. C.M	1.0K 5% 1/10W	
C7012	NCB214K-103X	C CAPACITOR	-010MF 10% 50V		R7106	MRS002J-102X	RES. C.M	1.0K 5% 1/10W	
C7013	NCF214H-104X	C CAPACITOR	-10MF +80% -20%		R7107	MRS002J-102X	RES. C.M	1.0K 5% 1/10W	
C7014	NCF214H-104X	C CAPACITOR	-10MF 5% 50V		R7108	MRS002J-102X	RES. C.M	1.0K 5% 1/10W	
C7109	NCS214J-101X	C CAPACITOR	100PF 5% 50V		R7109	MRS002J-102X	RES. C.M	1.0K 5% 1/10W	
C7122	NCB214K-103X	C CAPACITOR	-010MF 10% 50V		R7110	MRS002J-102X	RES. C.M	1.0K 5% 1/10W	
C7123	NCB214K-103X	C CAPACITOR	-010MF 10% 50V		R7111	MRS002J-102X	RES. C.M	1.0K 5% 1/10W	
C7125	NCS214J-101X	C CAPACITOR	100PF 5% 50V		R7112	MRS002J-102X	RES. C.M	1.0K 5% 1/10W	
C7126	NCS214J-101X	C CAPACITOR	100PF 5% 50V		R7113	MRS002J-102X	RES. C.M	1.0K 5% 1/10W	
C7201	GER61CM-107Z	E.CAPA. I.M	100MF 20% 16V		R7114	MRS002J-222X	MG RESISTOR	2.2K 5% 1/10W	
C7202	GFN414H-104	M CAPACITOR	.10MF 5% 50V		R7115	MRS002J-222X	MG RESISTOR	2.2K 5% 1/10W	
C7311	GER414M-475	E CAPACITOR	4.7MF 20% 50V		R7116	MRS002J-222X	MG RESISTOR	2.2K 5% 1/10W	
C7312	GER414M-225	E CAPACITOR	2.2MF 20% 50V		R7117	MRS002J-222X	MG RESISTOR	2.2K 5% 1/10W	
C7321	GEZ0229-479Z	EDL.CAPACITOR	47000MF		R7118	MRS002J-222X	MG RESISTOR	2.2K 5% 1/10W	
C7801	GER614M-335Z	E CAPACITOR	3.3MF 20% 50V		R7119	MRS002J-222X	MG RESISTOR	2.2K 5% 1/10W	
C7802	GER414M-235	E CAPACITOR	2.2MF 20% 50V		R7120	MRS002J-222X	MG RESISTOR	2.2K 5% 1/10W	
C7803	GER414M-105	E CAPACITOR	1.0MF 20% 50V		R7121	MRS002J-222X	MG RESISTOR	2.2K 5% 1/10W	
C7804	GER414M-225	E CAPACITOR	2.2MF 20% 50V		R7122	MRS002J-222X	MG RESISTOR	2.2K 5% 1/10W	
C7805	GER414M-105	E CAPACITOR	1.0MF 20% 50V		R7123	MRS002J-222X	MG RESISTOR	2.2K 5% 1/10W	
D7011	NCB214K-103X	C CAPACITOR	-010MF 10% 50V		R7124	MRS002J-222X	MG RESISTOR	2.2K 5% 1/10W	
D7001	1SS133-T2	DIODE	CLOCK		R7125	MRS002J-103X	RES. C.M	10K 5% 1/10W	
D7201	1SS133-T2	DIODE	US6V2		R7126	MRS002J-103X	RES. C.M	10K 5% 1/10W	
D7202	1SS133-T2	DIODE	US5V		R7128	MRS002J-103X	RES. C.M	10K 5% 1/10W	
D7203	1SS133-T2	DIODE	LCDSV		R7129	MRS002J-222X	MG RESISTOR	2.2K 5% 1/10W	
D7204	1SS133-T2	DIODE	BU5V		R7130	MRS002J-222X	MG RESISTOR	2.2K 5% 1/10W	
D7205	MTZJ8-2B-T2	DIODE	US6V2		R7131	MRS002J-222X	MG RESISTOR	2.2K 5% 1/10W	
D7301	MTZJ5-1C-T2	ZENER DIODE	BUCKUP		R7132	MRS002J-222X	MG RESISTOR	2.2K 5% 1/10W	
D7311	1SS133-T2	DIODE	RESET		R7133	MRS002J-222X	MG RESISTOR	2.2K 5% 1/10W	
D7321	1SS133-T2	DIODE	BU5V		R7134	MRS002J-222X	MG RESISTOR	2.2K 5% 1/10W	
IC701	UPD78056GG-A29	IC	SYSTEM MICON		R7135	MRS002J-103X	RES. C.M	10K 5% 1/10W	
IC702	KIAT8506P-T	IC	US6V REG		R7136	MRS002J-222X	MG RESISTOR	2.2K 5% 1/10W	
K7201	GR0601-0012	F-BEADS I.M	ICV5S		R7137	MRS002J-153X	MG RESISTOR	15K 5% 1/10W	
K7202	GR0601-0012	F-BEADS I.M	AVSS		R7138	MRS002J-222X	MG RESISTOR	2.2K 5% 1/10W	
K7203	GR0601-0012	F-BEADS I.M	F-BEADS I.M		R7139	MRS002J-222X	MG RESISTOR	2.2K 5% 1/10W	
L7201	QO01BK-100Z	INDUCTOR	VDD		R7140	MRS002J-102X	RES. C.M	1.0K 5% 1/10W	
L7202	QO01BK-100Z	INDUCTOR	AVDD		R7141	MRS002J-473X	MG RESISTOR	47K 5% 1/10W	
PP701	QZW0007-001	POST PIN			R7142	MRS002J-473X	MG RESISTOR	47K 5% 1/10W	
PP702	QZW0007-001	POST PIN			R7143	MRS002J-333X	MG RESISTOR	33K 5% 1/10W	
Q7001	25C2668/07-T	TRANSISTOR	CLOCK SHIFT		R7144	MRS002J-222X	MG RESISTOR	2.2K 5% 1/10W	

CD Board

BLOCK NO. 07111111

REF.	PARTS NO.	PARTS NAME	REMARKS	SUFFIX
R7145	NRSA02J-222X	MG RESISTOR	2-2K 5% 1/10W	
R7146	NRSA02J-222X	MG RESISTOR	2-2K 5% 1/10W	
R7147	NRSA02J-222X	MG RESISTOR	2-2K 5% 1/10W	
R7148	NRSA02J-222X	MG RESISTOR	2-2K 5% 1/10W	
R7150	NRSA02J-102X	RES. C.M	1-0K 5% 1/10W	
R7151	NRSA02J-222X	MG RESISTOR	2-2K 5% 1/10W	
R7152	NRSA02J-222X	MG RESISTOR	2-2K 5% 1/10W	
R7153	NRSA02J-222X	MG RESISTOR	2-2K 5% 1/10W	
R7154	NRSA02J-222X	MG RESISTOR	2-2K 5% 1/10W	
R7155	NRSA02J-222X	MG RESISTOR	2-2K 5% 1/10W	
R7156	NRSA02J-222X	MG RESISTOR	2-2K 5% 1/10W	
R7301	NRSA02J-473X	MG RESISTOR	47K 5% 1/10W	
R7302	NRSA02J-333X	MG RESISTOR	33K 5% 1/10W	
R7303	NRSA02J-104X	MG RESISTOR	100K 5% 1/10W	
R7304	NRSA02J-102X	RES. C.M	1-0K 5% 1/10W	
R7311	NRSA02J-103X	RES. C.M	10K 5% 1/10W	
R7312	NRSA02J-103X	RES. C.M	10K 5% 1/10W	
R7313	NRSA02J-103X	RES. C.M	10K 5% 1/10W	
R7314	NRSA02J-102X	RES. C.M	1-0K 5% 1/10W	
R7315	NRSA02J-103X	RES. C.M	10K 5% 1/10W	
R7321	NRSA02J-331X	MG RESISTOR	330 5% 1/10W	
R7322	NRSA02J-103X	RES. C.M	10K 5% 1/10W	
R7401	NRSA02J-103X	RES. C.M	10K 5% 1/10W	
R7402	NRSA02J-103X	RES. C.M	10K 5% 1/10W	
R7403	NRSA02J-103X	RES. C.M	10K 5% 1/10W	
R7404	NRSA02J-103X	RES. C.M	10K 5% 1/10W	
R7405	NRSA02J-103X	RES. C.M	10K 5% 1/10W	
R7406	NRSA02J-103X	RES. C.M	10K 5% 1/10W	
R7407	NRSA02J-103X	RES. C.M	10K 5% 1/10W	
R7408	NRSA02J-153X	MG RESISTOR	V37E EN EV B A	
R7409	NRSA02J-203X	MG RESISTOR	20K 5% 1/10W	
R7410	NRSA02J-103X	RES. C.M	10K 5% 1/10W	
R7411	NRSA02J-103X	RES. C.M	10K 5% 1/10W	
R7801	NRSA02J-114X	RES. C.M	110K 5% 1/10W	
R7802	NRSA02J-114X	RES. C.M	110K 5% 1/10W	
R7803	NRSA02J-683X	MG RESISTOR	68K 5% 1/10W	
R7804	NRSA02J-103X	MG RESISTOR	1-0M 5% 1/10W	
R7805	NRSA02J-683X	MG RESISTOR	68K 5% 1/10W	
R7811	NRSA02J-823X	MG RESISTOR	82K 5% 1/10W	
R7812	NRSA02J-344X	RES. C.M	390K 5% 1/10W	
R7813	NRSA02J-104X	MG RESISTOR	100K 5% 1/10W	
R7821	NRSA02J-103X	RES. C.M	10K 5% 1/10W	
R7822	NRSA02J-473X	MG RESISTOR	47K 5% 1/10W	
R7823	NRSA02J-102X	RES. C.M	1-0K 5% 1/10W	
X7001	GAX0401-001	CRYSTAL	CLOCK(36.-678KHZ	
X7002	GAX0410-001	CERA LOCK	MAIN CK(4.19MHZ	

REF.	PARTS NO.	PARTS NAME	REMARKS	SUFFIX
CN601	GGF1201F3-13	CONNECTOR		
CN602	GGF1201F3-10	CONNECTOR		
CN603	GGF1004F4-18	FPC CONNECTOR		
CN604	GG2501C1-03	3P CONNECTOR		
CN605	GA1501C3-02	W TO B CONNE	RED	
CN606	GA1501C4-02	W TO B CONNE	BLUE	
CN607	VMCO199-002V	CONNECTOR	WHITE	
C6001	GER40JM-107	E CAPACITOR	100MF 20% 6.3V	
C6002	GER41CM-106	E CAPACITOR	10MF 20% 16V	
C6003	NDC21HJ-3R5X	C CAPACITOR		
C6005	NCS21HJ-331X	C CAPACITOR	330PF 5% 50V	
C6006	NCB21HK-102X	C CAPACITOR	1000PF 10% 50V	
C6007	NCB21HK-102X	C CAPACITOR	1000PF 10% 50V	
C6008	GER41HM-105	E CAPACITOR	1.0MF 20% 50V	
C6009	NCS21HJ-101X	C CAPACITOR	100PF 5% 50V	
C6010	NCB21HK-273X	C CAPACITOR	.027MF 10% 50V	
C6011	NCB21HK-222X	C CAPACITOR	2200PF 10% 50V	
C6012	NCB21HK-103X	C CAPACITOR	.010MF 10% 50V	
C6014	NCB21EK-104X	C CAPACITOR	.10MF 10% 25V	
C6015	NCB21HK-223X	C CAPACITOR	.022MF 10% 50V	
C6016	NCB21HK-223X	C CAPACITOR	.022MF 10% 50V	
C6017	NCB21HK-223X	C CAPACITOR	.022MF 10% 50V	
C6018	NCB21HK-222X	C CAPACITOR	2200PF 10% 50V	
C6019	NCS21HJ-271X	C CAPACITOR	270PF 5% 50V	
C6020	NCS21HJ-181X	C CAPACITOR	180PF 5% 50V	
C6021	NCS21HJ-821X	C CAPACITOR	820PF 5% 50V	
C6022	GER60JM-476Z	E CAPACITOR	47MF 20% 6-3V	
C6023	NCB21EK-104X	C CAPACITOR	.10MF 10% 25V	
C6024	NCB21EK-473X	C CAPACITOR	.047MF 10% 25V	
C6029	GER40JM-107	E CAPACITOR	100MF 20% 6.3V	
C6031	GER41AM-227	E CAPA. I-M	220MF 20% 10V	
C6032	GER40JM-107	E CAPACITOR	100HF 20% 6.3V	
C6051	NDC21HJ-150X	C CAPACITOR		
C6052	NDC21HJ-150X	C CAPACITOR		
C6053	NCB21HK-223X	C CAPACITOR		
C6055	NCB21EK-473X	C CAPACITOR	.022MF 10% 25V	
C6058	NCS21HJ-6R0X	C CAPA. C-M	6.0PF 5% 50V	
C6061	NCS21HJ-471X	C CAPACITOR	470PF 5% 50V	
C6062	NCB21HK-223X	C CAPACITOR	.022MF 10% 50V	
C6063	NCB21HK-223X	C CAPACITOR	.022MF 10% 50V	
C6064	NCB21HK-223X	C CAPACITOR	.022MF 10% 50V	
C6065	NCB21EK-334X	C CAPA. C-M	.33MF 10% 16V	
C6071	NCB21HK-222X	C CAPACITOR	2200PF 10% 50V	
C6072	NCB21HK-222X	C CAPACITOR	2200PF 10% 50V	
C6073	GER41AM-227	E CAPA. I-M	220MF 20% 10V	
C6075	NCB21HK-102X	C CAPACITOR	1000PF 10% 50V	
C6076	NCB21HK-102X	C CAPACITOR	1000PF 10% 50V	
C6077	NCB21HK-223X	C CAPACITOR	.022MF 10% 50V	
C6080	GER41AM-227	E CAPA. I-M	220MF 20% 10V	
C6081	GER41AM-227	E CAPA. I-M	220MF 20% 10V	
C6083	NCB21HK-223X	C CAPACITOR	.022MF 10% 50V	
C6095	NCB21EK-104X	C CAPACITOR	.10MF 10% 25V	
C6096	NCB21HK-102X	C CAPACITOR	1000PF 10% 50V	
C6097	NCB21HK-102X	C CAPACITOR	1000PF 10% 50V	
C6098	NCB21HK-102X	C CAPACITOR	1000PF 10% 50V	

BLOCK NO. 08111111		BLOCK NO. 08111111			
REF.	PARTS NO.	PARTS NAME	REMARKS	SUFFIX	
R6059	NCB21HK-102X	C CAPACITOR	1000PF 10% 50V		
R6101	NCB21HK-223X	C CAPACITOR	.022MF 10% 50V		
C6154	NCB21HJ-151X	C CAPACITOR	150PF 5% 50V		
C6156	NCB21HJ-151X	C CAPACITOR	150PF 5% 50V		
C6157	NCB21HJ-151X	C CAPACITOR	150PF 5% 50V		
C6158	NCB21HJ-151X	C CAPACITOR	150PF 5% 50V		
D6061	1S3355-X	DIODE C-M			
D6062	1S3355-X	DIODE C-M			
D6063	1S3355-X	DIODE C-M			
IC601	AN880658-W	IC C-M			
IC602	BA6897FP-W	IC			
IC603	MM35510	IC			
K6001	QR0779-001Z	INDUCTOR			
Q6001	2SA1037AK/R/-X	CHIP TR.C-M			
Q6031	2SA952/LK/-T	TRANSISTOR			
R6001	NRSA02J-123X	RES. C-M	12K 5% 1/10W		
R6002	NRSA02J-225X	MG RESISTOR	2.2M 5% 1/10W		
R6003	NRSA02J-102X	RES. C-M	1.0K 5% 1/10W		
R6004	NRSA02J-124X	MG RESISTOR	120K 5% 1/10W		
R6006	NRSA02J-473X	MG RESISTOR	47K 5% 1/10W		
R6007	NRSA02J-273X	MG RESISTOR	27K 5% 1/10W		
R6009	NRSA02J-393X	MG RESISTOR	39K 5% 1/10W		
R6010	NRSA02J-104X	MG RESISTOR	100K 5% 1/10W		
R6012	NRSA02J-103X	RES. C-M	10K 5% 1/10W		
R6013	NRSA02J-121X	MG RESISTOR	120 5% 1/10W		
R6014	NRSA02J-100X	MG RESISTOR	10 5% 1/10W		
R6015	NRSA02J-120X	MG RESISTOR	12 5% 1/10W		
R6016	NRSA02J-910X	RES. C-M	91 5% 1/10W		
R6021	NRSA02J-101X	MG RESISTOR	100 5% 1/10W		
R6022	NRSA02J-101X	MG RESISTOR	100 5% 1/10W		
R6023	NRSA02J-101X	MG RESISTOR	100 5% 1/10W		
R6024	NRSA02J-104X	MG RESISTOR	100K 5% 1/10W		
R6025	NRSA02J-104X	MG RESISTOR	100K 5% 1/10W		
R6026	NRSA02J-393X	MG RESISTOR	39K 5% 1/10W		
R6027	NRSA02J-393X	MG RESISTOR	39K 5% 1/10W		
R6028	NRSA02J-393X	MG RESISTOR	39K 5% 1/10W		
R6029	NRSA02J-393X	MG RESISTOR	39K 5% 1/10W		
R6031	NRSA02J-331X	MG RESISTOR	330 5% 1/10W		
R6032	NRSA02J-101X	MG RESISTOR	100 5% 1/10W		
R6041	NRSA02J-273X	MG RESISTOR	27K 5% 1/10W		
R6042	NRSA02J-183X	MG RESISTOR	18K 5% 1/10W		
R6043	NRSA02J-272X	MG RESISTOR	2.7K 5% 1/10W		
R6044	NRSA02J-273X	MG RESISTOR	27K 5% 1/10W		
R6045	NRSA02J-393X	MG RESISTOR	39K 5% 1/10W		
R6046	NRSA02J-332X	MG RESISTOR	3.3K 5% 1/10W		
R6047	NRSA02J-332X	MG RESISTOR	3.3K 5% 1/10W		
R6051	NRSA02J-102X	RES. C-M	1.0K 5% 1/10W		
R6052	NRSA02J-102X	RES. C-M	1.0K 5% 1/10W		
R6053	NRSA02J-102X	RES. C-M	1.0K 5% 1/10W		
R6054	NRSA02J-102X	RES. C-M	1.0K 5% 1/10W		
R6055	NRSA02J-102X	RES. C-M	1.0K 5% 1/10W		
R6056	NRSA02J-OROX	RES. C-M	5% 1/10W		
R6057	NRSA02J-OROX	RES. C-M	5% 1/10W		
R6058	NRSA02J-OROX	RES. C-M	5% 1/10W		
R6059	NRSA02J-471X	RES. C-M	470 5% 1/10W		
A	REF.	PARTS NO.	PARTS NAME	REMARKS	SUFFIX
	R6060	NRSA02J-471X	RES. C-M	470 5% 1/10W	
	R6061	NRSA02J-104X	MG RESISTOR	100K 5% 1/10W	
	R6063	NRSA02J-124X	MG RESISTOR	120K 5% 1/10W	
	R6064	NRSA02J-681X	MG RESISTOR	680 5% 1/10W	
	R6066	NRSA02J-220X	MG RESISTOR	22 5% 1/10W	
	R6067	NRSA02J-220X	MG RESISTOR	22 5% 1/10W	
	R6068	NRSA02J-220X	MG RESISTOR	22 5% 1/10W	
	R6069	NRSA02J-155X	MG RESISTOR	1.5M 5% 1/10W	
	R6071	NRSA02J-102X	RES. C-M	1.0K 5% 1/10W	
	R6072	NRSA02J-102X	RES. C-M	1.0K 5% 1/10W	
	R6076	NRSA02J-OROX	RES. C-M	5% 1/10W	
	R6080	NRSA02J-OROX	RES. C-M	5% 1/10W	
	R6121	NRSA02J-101X	RES. C-M	5% 1/10W	
	W 805	QJL006-021302	MG RESISTOR	100 5% 1/10W	
	W 814	QJF018-031203	SIN CR C-B WIRE		
	W3004	QJF017-052600	SIN CR C-B WIRE		
	W3351	QJF003-042600	SIN CR C-B WIRE		
	W5501	QJK018-020802	SIN CR C-B WIRE		
	X6051	GAX0413-001Z	CRYSTAL		

■ Switch Board (UX-V5/UX-V5R/UX-V3)

A	REF.	PARTS NO.	PARTS NAME	REMARKS	SUFFIX
	CN	1	QGB2011L1-10		
	D	1	1SR139-100-T2		
	IC	1	SG-105F3-BB-C		
	P	1	GN20104-001		
	SW	2	MXS00220RVLO	CASSETTE SWITCH R.REC	
	SW	4	MXS00220RVLO	CASSETTE SWITCH TAPE	
	SW	5	MXS00220RVLO	CASSETTE SWITCH 70U	
	SW	6	QSW0507-001	CASSETTE SWITCH F.REC	

■ Preamp Board (UX-V5/UX-V5R/UX-V3)

A	REF.	PARTS NO.	PARTS NAME	REMARKS	SUFFIX
	C	101	NCS21HJ-821X	C CAPACITOR	820PF 5X 50V
	C	102	NCS21HJ-221X	C CAPACITOR	220PF 5X 50V
	C	103	QEK40JM-227	C CAPACITOR	220MF 20X 6.3V
	C	104	NCB21HK-333X	C CAPACITOR	-0.33MF 10X 50V
	C	105	NCB21HK-222X	C CAPACITOR	2200PF 10X 50V
	C	106	QEK41CM-106	E CAPACITOR	10MF 20X 16V
	C	107	NCS21HJ-561X	C CAPACITOR	560PF 5X 50V
	C	108	QEK41EM-475	E CAPACITOR	4.7MF 20X 25V
	C	109	QEK41EM-475	E CAPACITOR	4.7MF 20X 25V
	C	110	NCB21HK-682X	C.CAPA. C.M	6800PF 10X 50V
	C	111	NCB21HK-122X	C CAPACITOR	1200PF 10X 50V
	C	112	NCB21EK-683X	C CAPACITOR	-0.68MF 10X 25V
	C	113	NCB21HK-222X	C CAPACITOR	2200PF 10X 50V
	C	121	NCS21HJ-331X	C CAPACITOR	330PF 5X 50V
	C	201	NCS21HJ-821X	C CAPACITOR	820PF 5X 50V
	C	202	NCS21HJ-221X	C CAPACITOR	220PF 5X 50V
	C	203	QEK40JM-227	E CAPACITOR	220MF 20X 6.3V
	C	204	NCB21HK-333X	C CAPACITOR	-0.33MF 10X 50V
	C	205	NCB21HK-222X	C CAPACITOR	2200PF 10X 50V
	C	206	QEK41CM-106	E CAPACITOR	10MF 20X 16V
	C	207	NCS21HJ-561X	C CAPACITOR	560PF 5X 50V
	C	208	QEK41EM-475	E CAPACITOR	4.7MF 20X 25V
	C	209	QEK41EM-475	E CAPACITOR	4.7MF 20X 25V
	C	210	NCB21HK-682X	C.CAPA. C.M	6800PF 10X 50V
	C	211	NCB21HK-122X	C CAPACITOR	1200PF 10X 50V
	C	212	NCB21EK-683X	C CAPACITOR	-0.68MF 10X 25V
	C	213	NCB21HK-222X	C CAPACITOR	2200PF 10X 50V
	C	221	NCS21HJ-331X	C CAPACITOR	330PF 5X 50V
	C	301	QEKJ1AM-1072	E CAPACITOR	100MF 20X 10V
	C	302	NCB21HK-393X	C CAPACITOR	-0.39MF 10X 50V
	C	303	QEK40JM-227	E CAPACITOR	220MF 20X 6.3V
	C	304	QEK41CM-226	E CAPACITOR	22MF 20X 16V
	C	305	QEK41CM-226	E CAPACITOR	22MF 20X 16V
	C	306	QEK41CM-476	E CAPACITOR	47MF 20X 16V
	C	307	NCB21HK-103X	C CAPACITOR	-0.10MF 10X 50V
	C	308	NCB21HK-562X	C CAPACITOR	5600PF 10X 50V
	C	309	NCB21HK-562X	C CAPACITOR	5600PF 10X 50V
	C	310	NCB21HK-223X	C CAPACITOR	-0.22MF 10X 50V
	C	311	NCB21HK-682X	C.CAPA. C.M	6800PF 10X 50V
	C	313	QEKJ1AM-1072	E CAPACITOR	100MF 20X 10V
	C	314	QCZ0205-1552	ML C CAP I/M	1.5MF
	C	315	QCZ0205-1552	ML C CAP I/M	1.5MF
	C	316	QF32AJ-1032	PP CAPACITOR	-0.10MF 5X 100V
	C	318	NCB21HK-103X	C CAPACITOR	-0.10MF 10X 50V
	C	319	QF32AJ-8212	TF CAPACITOR	820PF 5X 100V
	C	321	NCB21HK-103X	C CAPACITOR	-0.10MF 10X 50V
	C	322	QF32AJ-1522	M CAPACITOR	1500PF 5X 100V
	C	331	QEK41CM-476	E CAPACITOR	47MF 20X 16V
	C	351	QEK41CM-106	E CAPACITOR	10MF 20X 16V
	C	371	QEK41EM-475	E CAPACITOR	4.7MF 20X 25V
	C	374	QEKJ1AM-1072	E CAPACITOR	MOTOR +B
	C	375	QEKJ1AM-1072	E CAPACITOR	100MF 20X 10V
	C	376	NCB21HK-103X	C CAPACITOR	-0.10MF 10X 50V
	CN	31	QGF1205F1-06	CONNECTOR	PRI/HEAD
	CN	32	QGB2011M1-10	PWB CONNECTOR	PRI/MECHA

BLOCK NO. 1011111111

REF	PARTS NO.	PARTS NAME	REMARKS	SUFFIX
R 210	NRSA02J-473X	RES. C.M		
R 211	NRSA02J-333X	MG RESISTOR		
R 212	NRSA02J-223X	MG RESISTOR		
R 213	NRSA02J-222X	RES. C.M		
R 214	NRSA02J-272X	MG RESISTOR		
R 216	NRSA02J-102X	RES. C.M		
R 221	NRSA02J-102X	RES. C.M		
R 301	NRS181J-221X	MG RESISTOR		
R 303	NRSA02J-393X	MG RESISTOR		
R 304	NRS181J-101X	MG RESISTOR		
R 305	NRSA02J-222X	MG RESISTOR		
R 306	NRSA02J-222X	MG RESISTOR		
R 310	NRS181J-560X	MG RESISTOR		
R 311	NRS181J-560X	MG RESISTOR		
R 313	NRSA02J-3R3NY	RES. C.M		
R 314	NRSA02J-223X	RES. C.M		
R 315	NRSA02J-100X	MG RESISTOR		
R 316	NRSA02J-223X	RES. C.M		
R 317	NRSA02J-100X	MG RESISTOR		
R 319	NRSA02J-152X	MG RESISTOR		
R 322	NRSA02J-152X	MG RESISTOR		
R 327	NRSA02J-474X	MG RESISTOR		
R 332	NRSA02J-123X	RES. C.M		
R 333	NRSA02J-123X	RES. C.M		
R 335	NRSA02J-152X	MG RESISTOR		
R 336	NRSA02J-472X	RES. C.M		
R 337	NRSA02J-332X	MG RESISTOR		
R 338	NRSA02J-392X	MG RESISTOR		
R 339	NRSA02J-222X	MG RESISTOR		
R 340	NRS181J-591X	MG RESISTOR		
R 341	NRSA02J-123X	RES. C.M		
R 342	NRSA02J-203X	MG RESISTOR		
R 343	NRSA02J-183X	MG RESISTOR		
R 351	NRSA02J-683X	MG RESISTOR		
R 352	NRSA02J-912X	RES. C.M		
R 371	NRSA02J-123X	RES. C.M		
R 372	NRSA02J-102X	RES. C.M		
R 375	NRSA02J-151X	MG RESISTOR		
R 376	NRSA02J-472X	RES. C.M		
VR 31	QUP0008-5032	SEMI V RESISTOR		
VR 32	QUP0008-5032	SEMI V RESISTOR		
VR 37	QUP0008-1032	SEMI V RESISTOR		

BLOCK NO. 1011111111

REF	PARTS NO.	PARTS NAME	REMARKS	SUFFIX
CN 33	GGF1205F1-09	CONNECTOR	PRI/MICON	
CN 34	GGF1205F1-10	CONNECTOR	PRI/AMP	
D 301	MA152MA-X	DIODE		
D 309	MA704A-X	S.K.DIODE		
D 375	MA3051/M/-X	ZENER DIODE		
FW 31	QUM024-06A2Z3	EF FLAT	HEAD SW	
IC 31	BA3126N	IC	PB&REC	
IC 32	AN7317	IC		
IC 33	BU409ABC-F-X	IC		
L 301	QR0420-001	OSC. COIL(CBIAS)		
L 303	QGL018K-100Z	INDUCTOR		
Q 101	DT1141KA-X	TRANSISTOR		
Q 102	DT1141KA-X	TRANSISTOR		
Q 201	DT1141KA-X	TRANSISTOR	REC EQ CONT.	
Q 202	DT1141KA-X	TRANSISTOR	REC EQ CONT.	
Q 301	DTA144EKA-X	TRANSISTOR	REC EQ CONT.	
Q 302	25C2001/K/-T	TR I/M		
Q 303	25C2001/K/-T	TR I/M		
Q 304	25C2001/LK/-T	TRANSISTOR		
Q 305	25C2001/LK/-T	TRANSISTOR		
Q 306	25C2412K/RS/-X	CHIP TR.C.M		
Q 307	25C2412K/RS/-X	CHIP TR.C.M		
Q 308	25C2412K/RS/-X	CHIP TR.C.M		
Q 309	25C2412K/RS/-X	CHIP TR.C.M		
Q 321	DT144EKA-X	TRANSISTOR		
Q 323	25C2412K/RS/-X	CHIP TR.C.M		
Q 371	25A952/LK/-T	TRANSISTOR	MOTER+8	
Q 372	DT124EKA-X	TRANSISTOR		
Q 375	25B5627C/-T	TRANSISTOR	SOLENOID DRIVE	
Q 376	25C2412K/RS/-X	CHIP TR.C.M		
R 101	NRSA02J-220X	MG RESISTOR	22 5X 1/10W	
R 102	NRSA02J-182X	MG RESISTOR	1.8K 5X 1/10W	
R 103	NRSA02J-242NY	MG RESISTOR	2.4K 5X 1/10W	
R 104	NRSA02J-122X	MG RESISTOR	1.2K 5X 1/10W	
R 105	NRSA02J-104X	MG RESISTOR	1.0K 5X 1/10W	
R 106	NRSA02J-332X	MG RESISTOR	3.3K 5X 1/10W	
R 107	NRSA02J-123X	RES. C.M	12K 5X 1/10W	
R 108	NRSA02J-562X	MG RESISTOR	5.6K 5X 1/10W	
R 109	NRSA02J-122X	MG RESISTOR	1.2K 5X 1/10W	
R 110	NRSA02J-472X	RES. C.M	4.7K 5X 1/10W	
R 111	NRSA02J-333X	MG RESISTOR	3.3K 5X 1/10W	
R 112	NRSA02J-222X	MG RESISTOR	2.2K 5X 1/10W	
R 113	NRSA02J-472X	RES. C.M	4.7K 5X 1/10W	
R 114	NRSA02J-272X	MG RESISTOR	2.7K 5X 1/10W	
R 116	NRSA02J-102X	RES. C.M	1.0K 5X 1/10W	
R 121	NRSA02J-102X	RES. C.M	1.0K 5X 1/10W	
R 201	NRSA02J-220X	MG RESISTOR	22 5X 1/10W	
R 202	NRSA02J-182X	MG RESISTOR	1.8K 5X 1/10W	
R 203	NRSA02J-242NY	MG RESISTOR	2.4K 5X 1/10W	
R 204	NRSA02J-122X	MG RESISTOR	1.2K 5X 1/10W	
R 205	NRSA02J-104X	MG RESISTOR	1.0K 5X 1/10W	
R 206	NRSA02J-332X	MG RESISTOR	3.3K 5X 1/10W	
R 207	NRSA02J-123X	RES. C.M	12K 5X 1/10W	
R 208	NRSA02J-562X	MG RESISTOR	5.6K 5X 1/10W	
R 209	NRSA02J-122X	MG RESISTOR	1.2K 5X 1/10W	

■ Packing List

BLOCK NO. M4MM							
REF.	PARTS NO.	PARTS NAME	REMARKS	QTY	SUFFIX	CLR	
P 1	QPA02503503P	POLY BAG	FOR INST	1			
P 2	QPA01202505	POLY BAG		1			
P 3	QPA01503503	POLY BAG	B ONLY	1			
P 4	QPA01702503P	POLY BAG	FOR AM ANT.	1			
P 5	QPC06005515P	POLY BAG		1			
P 5	LV30907-003A	CARTON	V5R	1			
	LV30907-001A	CARTON	V3	1			
	LV30907-002A	CARTON	V5	1			
P 6	LV10182-001A	CUSHION(TOP)		1			
P 7	LV10182-002A	CUSHION(BOTTOM)		1			
P 8	LV20328-001A	SP CUSHION	(TOP)	1			
P 9	LV20329-001A	SP CUSHION	(BOTTOM)	1			

■ Accessories List

BLOCK NO. M5MM							
REF.	PARTS NO.	PARTS NAME	REMARKS	QTY	SUFFIX	CLR	
A 1	LVT0215-003A	INSTBOOK V5/A	ENG.	1			
	LVT0215-002A	INSTBOOK V3R/EN	SWE.FIN.DAN	1			
	LVT0215-001A	INSTBOOK V3R/E	ENG.GER.FRE.	1			
	LVT0215-003A	INSTBOOK V3R/B	ENG.	1			
	LVT0215-002A	INSTBOOK V3R/EN	GER.FRE.DUT.	1			
	LVT0215-001A	INSTBOOK V3R/E	DUT.SPA.ITA	1			
	LVT0211-005A	INSTBOOK V5R/EV	ENG.POL.HUN.CZE	1			
	LVT0215-003A	INSTBOOK V3R/A	ENG.	1			
	LVT0211-001A	INSTBOOK V5R/E	DUT.SPA.ITA.	1			
	LVT0211-001A	INSTBOOK V5R/E	ENG.GER.FRE.	1			
	LVT0211-004A	INSTBOOK V5R/EE	RUS	1			
	LVT0211-003A	INSTBOOK V5R/B	ENG.	1			
	LVT0215-005A	INSTBOOK V3R/EV	ENG.POL.HUN.CZE	1			
	LVT0215-004A	INSTBOOK V3R/EE	UX-V3 EE	1			
	LVT0211-002A	INSTBOOK V5R/EN	SWE.FIN.DAN.	1			
A 2	LVT0211-002A	INSTBOOK V5R/EN	GER.FRE.DUT.	1			
A 2	QMP25D0-183	POWER CORD	A	1			
A 2	QMPL080-183-JC	POWER CORD	E.EE.EN.EV	1			
A 2	QMP5520-183E	POWER CORD	B	1			
A 3	EWP503-001C	ANT.WIRE	FM ANT	1			
A 4	QAL0014-001	AM LOOP ANT	AM ANT	1			
A 5	RM-RXUV3	REMOCON UNIT	V5	1			
	RM-RXUV5R	REMOCON UNIT	V5R	1			
	RM-RXUV3	REMOCON UNIT	V3	1			
A 6	R6SPTT/2STA	BATTERY		2			
A 7	BT-56001-2	W.CARD	V5/A V3/A	1			
	BT-54008-2	W.CARD	B.E.EN	1			
	BT-54012-1	W.CARD	EE EV ONLY	1			
A 8	LV41088-001A	CAUTION SHEET		1			
A 10	E43486-340B	SAFETY INST	B ONLY	1			
A 11	BT-56002-2	SVC SENTER LIST	V5/A V3/A	1			
A 12	VNA3000-202	REGISTER CARD	B ONLY	1			
A 13	UXV3K-SPBOX	SPEAKER BOX	UX-V3	2			
	UXV5RK-SPBOX	SPEAKER BOX	UX-V5R V5	2			

Packing Materials and Accessories Parts List

Block No.

M	4	M	M
---	---	---	---

Block No.

M	5	M	M
---	---	---	---

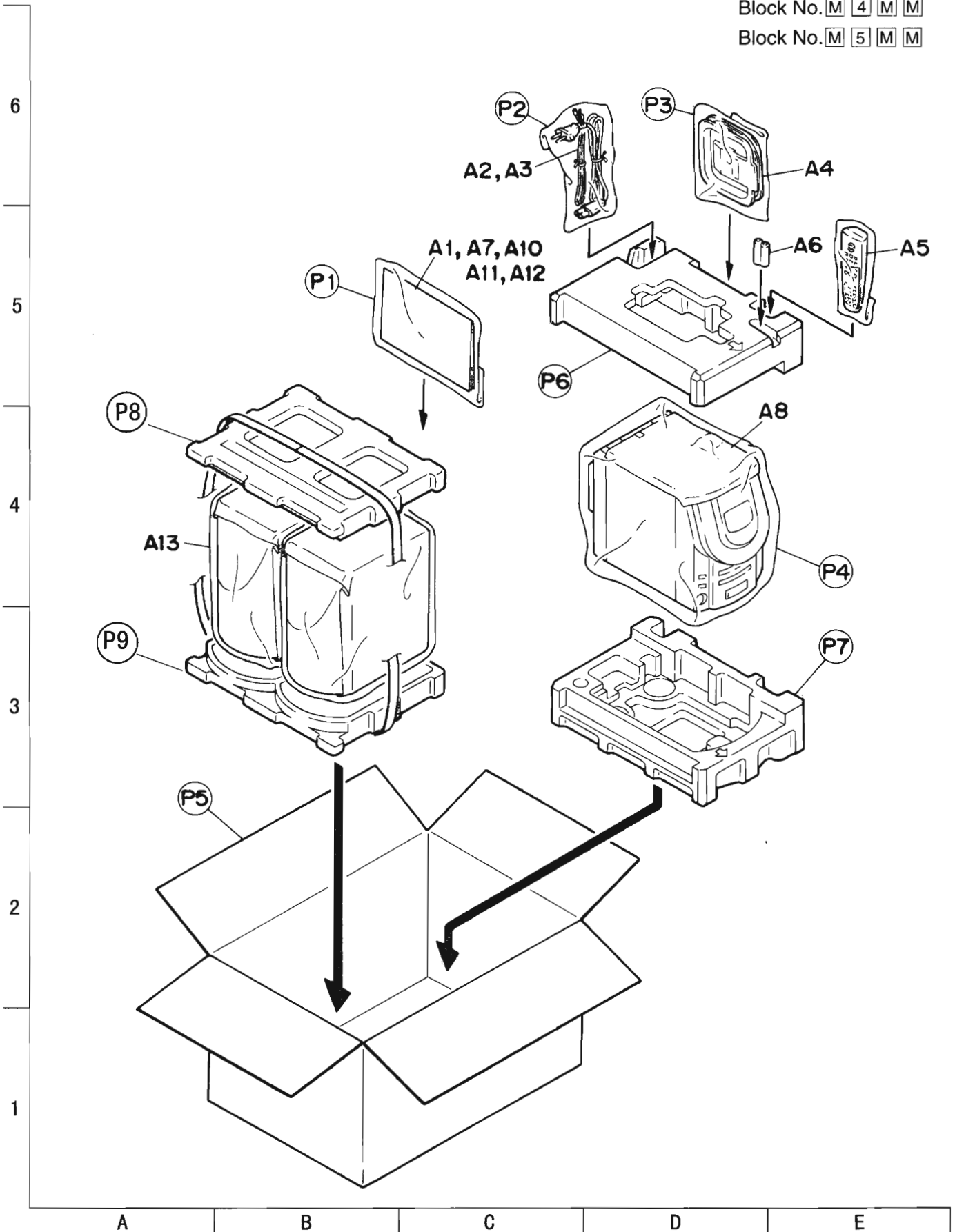

PARTS LIST

UX-V5
UX-V3
FS-V5

* All printed circuit boards and its assemblies are not available as service parts.

Areas suffix
UX-V5

UB ----- Hong Kong
US ----- Singapore
UT ----- Taiwan
UX ----- Saudi Arabia

Areas suffix
UX-V3

UB ----- Hong Kong
US ----- Singapore
UT ----- Taiwan
UX ----- Saudi Arabia
UF ----- China

Areas suffix
FS-V5

J ----- U.S.A.

- Contents -

Exploded view of general assembly and parts List-----	4-2
CD mechanism ass'y and parts list-----	4-6
Cassette mechanism ass'y and parts List-----	4-6
Electrical parts list -----	4-8
Packing materials and accessories parts list -----	4-28

■ Parts List (General Assembly)

BLOCK NO. M1MM1111

REF.	PARTS NO.	PARTS NAME	REMARKS	QTY	SUFFIX	CLR
1	LV10170-001A	FRONT PANEL	V3	1		
	LV10170-005A	FRONT PANEL	FS-V5	1		
	LV10170-004A	FRONT PANEL	V5	1		
2	LV40735-001A	REMOTE LENS		1		
3	LV20303-004A	FRONT BUTTON	V5 FS-V5	1		
	LV20303-001A	FRONT BUTTON	V3	1		
4	QYSBSF3008Z	SCREW	F.PANEL+BUTTON	5		
5	LV20305-001A	FRONT PLATE(MD)	V3	1		
	LV20305-003A	FRONT PLATE(MD)	V5 FS-V5	1		
6	QYSBSF3008Z	SCREW	F.PANEL+F.PLATE	1		
7	E65923-003	TAPPING SCREW	F.PANEL+HP JACK	1		
8	LV40954-001A	FOOT		2		
9	QYSBSF3008Z	SCREW	CHASSIS+PWB BKT	4		
10	LV30064-042A	SPACER	CHASSIS+PWB BKT	1		
11	QYSBST3006Z	TH TAP SCREW	PWB BKT+PWB	4		
12	LV20306-002A	CD DOOR	V5	1		
	LV20306-001A	CD DOOR	V3	1		
	LV20306-004A	CD DOOR	FS-V5	1		
13	LV41105-001A	BLIND		1		
14	PQ42376-001	JVC MARK		1		
15	LV40743-002A	LCD LENS	V5 FS-V5	1		
	LV40743-001A	LCD LENS	V3	1		
16	LV30860-001A	LCD HOLDER		1		
17	LV30064-043A	SPACER		1		
18	LV40737-001A	LENS	LCD BACKLIGHT	1		
19	LV40739-001A	SHEET		1		
20	LV20307-001A	DOOR COVER		1		
21	LV20308-002A	CD DOOR LENS	V5 FS-V5	1		
	LV20308-001A	CD DOOR LENS	V3	1		
22	QYSDSF2008M	SCREW	DOOR+COVER	3		
23	LV40744-001A	SOCKET BOLT	DOOR+LENS	2		
24	LV30858-001A	PWB BRACKET(L)	FOR MAICOM PWB	1		
25	LV30859-001A	PWB BRACKET(R)	FOR MAICOM PWB	1		
26	LV41002-001A	SHAFT	DOOR+CASE	1		
27	LV41003-001A	DOOR SUPPORTER		1		
28	QYSBSF3008Z	SCREW	F.PANEL+CD UNIT	2		
29	LV10173-001A	BOTTOM CHASSIS		1		
30	VKZ4001-016	WIRE HOLDER		1		
31	QYSBST4006Z	SCREW	B.CHASI+TRANS	4		
32	QHX5080-001	WIRE CLAMP		1		
33	LV30861-001A	JACK HOLDER	FS-V5	1		
	LV30861-002A	JACK HOLDER	V5/V3	1		
34	QYSBST3006Z	TH TAP SCREW	J.HOL.+BTM.CHAS	1		
35	-----	CASSETTE MECHA		1		
36	VKL7850-002	EJECT SAFTY(R)		1		
37	VKW5258-002	TORSION SPRING		1		
38	VYH3965-001	SIDE BRACKET(R)		1		
39	QYSDST3008Z	SCREW	MECHA+S.BKT.	1		
40	VYH8146-012	EJECT ARM(R)		1		
41	VKW3006-230	TORSION SPRING		1		
42	VKZ4341-004	SPECIAL SCREW	E.ARM+S.BKT.	1		
43	LV31009-001A	HEAD SHIELD		1		
44	QYSBSF2606Z	SCREW		2		
45	LV10174-005A	TOP COVER(TD)	V5	1		

BLOCK NO. MM

REF.	PARTS NO.	PARTS NAME	REMARKS	QTY	SUFFIX	CLR	
	LV10174-001A	TOP COVER(TD)	V3	1			
	LV10174-015A	TOP COVER(TD)	FS-V5	1			
46	LV20311-001A	CASSETTE DOOR	V3	1			
	LV20311-002A	CASSETTE DOOR	V5 FS-V5	1			
47	LV40851-001A	CASS.DOOR LENS	V3	1			
	LV40851-002A	CASS.DOOR LENS	V5 FS-V5	1			
48	VKY4180-001	CASSETTE SPRING		2			
49	VYH7366-001MM	GEAR		1			
50	VKW5277-001	DOOR SPRING (R)		1			
51	LV40745-002A	EJECT KNOB	V5 FS-V5	1			
	LV40745-001A	EJECT KNOB	V3	1			
52	LV30863-001A	TOP BUTTON	V3	1			
	LV30863-003A	TOP BUTTON	V5 FS-V5	1			
53	QYSBSF3008Z	SCREW	T.PANEL+T.BUTTO	4			
54	VYSA1R4-056	SPACER	T.PANEL+T.BUTTO	1			
	QYSBSF3012Z	SCREW	T.PANEL+C.MECHA	4			
59	QYSSSF3008Z	SCREW	T.PANEL+F.PANEL	2			
60	LV30864-001A	IC HOLDER		1			
61	QYSBSF3010Z	SCREW	IC+IC HOLDER	3			
62	LV30865-001A	HEAT SINK 1		1			
63	QYSBSF3010Z	SCREW	IC HOL.+H.SINK1	2			
64	QYSBST3006Z	TH TAP SCREW	B.CHASI+AMP PWB	1			
65	LV30866-001A	HEAT SINK 2		1			
66	QYSBSF3010Z	SCREW	IC+HEAT SINK 2	2			
67	QYSBSF3010Z	SCREW	H.SINK1+H.SINK2	3			
69	QYSBSF3010Z	SCREW	J.HOLDER+REG PW	1			
70	LV40746-001A	EARTH PLATE		1			
71	QYSBST3006Z	TH TAP SCREW	B.CHASI+TU/FUN	1			
72	LV10176-002A	SIDE PANEL(L)	V5 FS-V5	1			
	LV10176-001A	SIDE PANEL(L)	V3	1			
73	LV10177-002A	SIDE PANEL(R)	V3	1			
	LV10177-002A	SIDE PANEL(R)	V5 FS-V5	1			
74	LV10178-004A	REAR PANEL	V5/UB/UX/US/UT	1			
	LV10178-003A	REAR PANEL	FS-V5	1			
	LV10178-005A	REAR PANEL	UX-V5/UF	1			
	LV10178-008A	REAR PANEL	V3	1			
75	LV40954-001A	FOOT		2			
76	QYSBSF3010N	TAP SCREW		6			
77	QYSBST3006N	T.SCREW	B.CHASSIS+R.PAN	1			
78	QYSSST3010Z	SCREW	BTM.+SIDE+PANEL	4			
79	LV30913-006A	NAME PLATE	UX-V3/UB	1			
	LV30913-007A	NAME PLATE	UX-V3/UT	1			
	LV30913-008A	NAME PLATE	UX-V3/UX	1			
	LV30919-002A	NAME PLATE	FS-V5	1			
	LV30919-004A	NAME PLATE	UX-V5/UT	1			
	LV30919-005A	NAME PLATE	UX-V5/UX	1			
	LV30919-007A	NAME PLATE	UX-V5/UF	1			
	LV30919-001A	NAME PLATE	UX-V5/UB/US	1			
80	VND4118-004	CAUTION LABEL		1			
82	LV40231-001A	CAUTION LABEL	V5/V3	1			
△	83	QMF51E2-6R3-J1	FUSE	F1902	V5/V3	1	
△		QMF51U1-8R0-J1	FUSE	F1902	FS-V5	1	
△	84	QMF51N2-1R0-J1	FUSE	F1901	FS-V5	1	
△		QMF51E2-1R0-J1	FUSE	F1901	V5/V3	1	

BLOCK NO. M1111111

REF.	PARTS NO.	PARTS NAME	REMARKS	QTY	SUFFIX	CLR
86	LV40736-001A	BADGE	V3	1		
	LV40736-002A	BADGE	V5 FS-V5	1		
92	QUQ810-0712AJ	FFC WIRE	FRONT KEY - MIC	1		
93	QUQB12-1026CJ	FFC WIRE	CD - FUNC	1		
94	QUQB12-1306CJ	CARD WIRE	CD - MICOM	1		
95	QUQ810-1109AJ	FFC WIRE	LCD - MICOM	1		
96	QUQB12-1024CJ	FFC WIRE	SLC - FUNC	1		
97	QUQB12-0924CJ	FFC WIRE	SLC - FUNC	1		
98	QJN004-033001	SHI CR C-C WIRE	OPT-OUT SHIELD	1		
100	WJM0079-001A	E-SI C WIRE C-F	MOTOR WIRE	1		
101	VYH8064-001	WEIGHT		1		
102	LV40770-002A	INSULATOR		3		
103	LV30064-038A	SPACER		1		
104	LV30064-045A	SPACER		1		
105	LV10171-002A	CD CASE		1		
106	E75609-002	INSULATOR	FOR CD CASE	1		
107	LV10172-001A	CD CHASSIS		1		
108	LV30064-044A	SPACER		1		
109	LV40738-001A	GEAR1		1		
110	LV40740-002A	GEAR 2		1		
111	VKB3000-183	BELT		1		
112	VYH7699-001SS	PULLEY		1		
113	QAR0100-001	DC MOTOR		1		
114	QYSPSP3004Z	SCREW	CHASSIS+MOTOR	2		
115	QYSBSF3010Z	SCREW	CHASSIS+CASE	4		
116	E65923-003	TAPPING SCREW	CHASI+O/C SW.PW	1		
117	-----	CD MECHA		1		
118	LV40987-001A	SHIELD PLATE		1		
120	LV30064-046A	SPACER		1		
121	VXL4442-001	VOLUME KNOB	V5/V3	1		
122	QYSBSF3010N	TAP SCREW	UB/US/UX/UT	1		
T1901	QQT0248-004	POWER TRANS	V5/V3	1		
	QQT0248-002	POWER TRANS	FS-V5	1		

M M

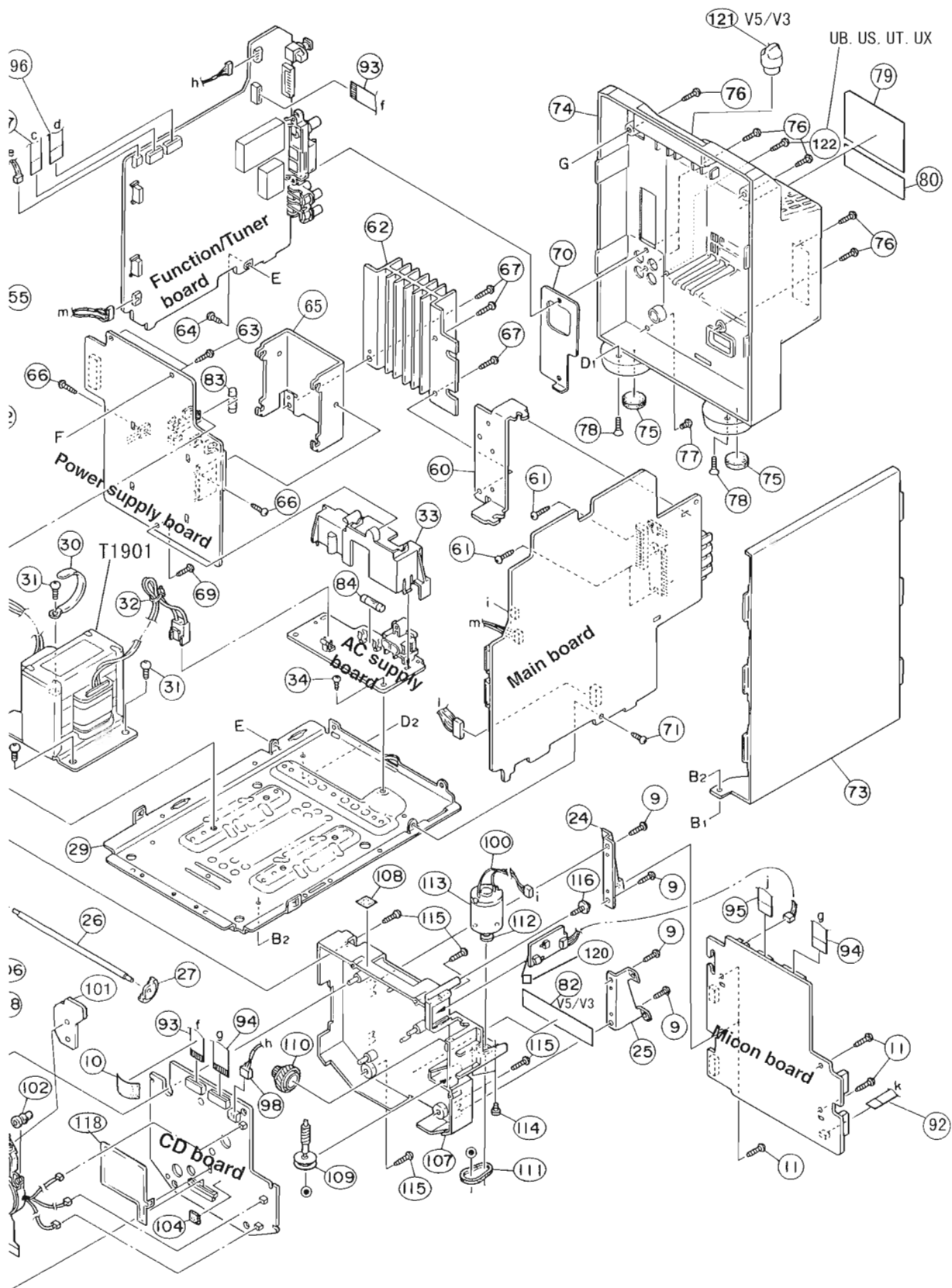

E F G H I

CD Mechanism Assembly and Parts List

Block No. M 2 M M

KSM-33AAN

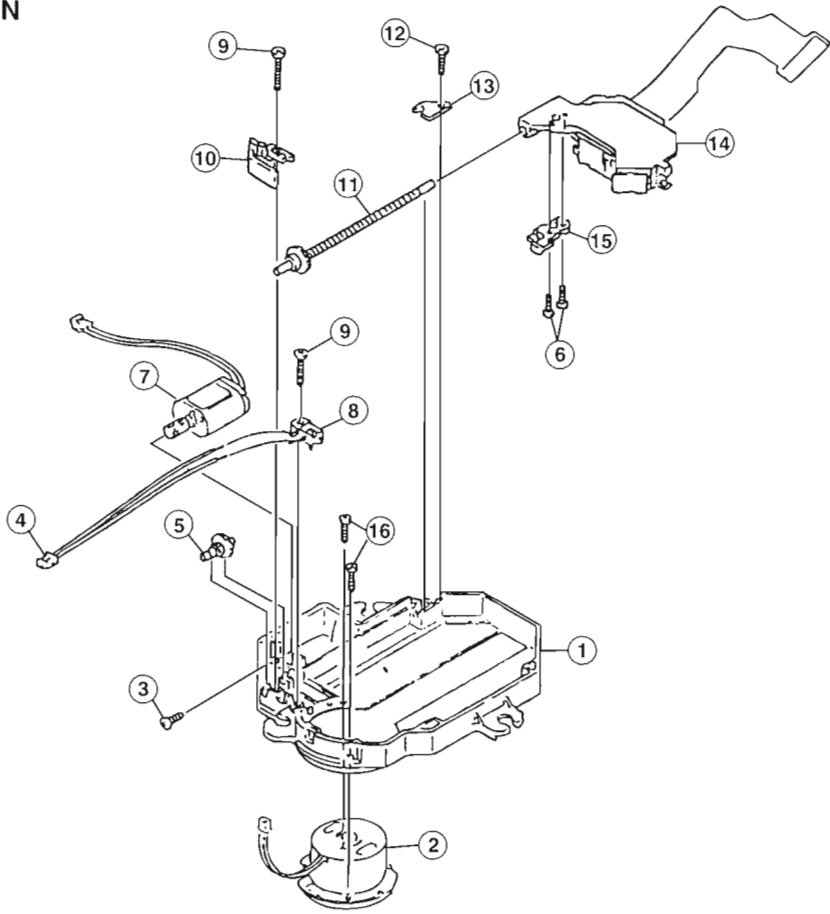

■ CD Mechanism Assembly Parts List

⚠	Item	Parts Number	Parts Name	Q'ty	Description	Area
	1	2-625-415-05	CHASSIS	1		
	2	X-2625-485-1SA	MOTOR ASS'Y	1		
	3	3-732-988-01	SCREW	1		
	4	1-948-418-21	HARNESS	1		
	5	2-625-410-01	GEAR(B)	1		
	6	7-627-852-17	SCREW	2	FOR RACK	
	7	X-2625-171-2	FEED MOTOR ASS'Y	1		
	8	1-570-771-11	SWITCH	1		
	9	2-625-623-11	SCREW	2	FOR SWITCH	
	10	2-625-412-02	LEAF SPRING	1		
	11	X-2625-483-1	SHAFT GEAR	1		
	12	2-625-623-01	SCREW	1	SHAFT GEAR	
	13	2-625-411-01	GEAR GUIDE	1		
	14	8-848-289-31SA	OPTICAL PICK UP	1		
	15	2-625-414-02	RACK	1		
	16	7-627-852-18	SCREW	2	FOR MOTOR	

A B C D E

Cassette Mechanism Assembly and Parts List

Block No. M 3 M M

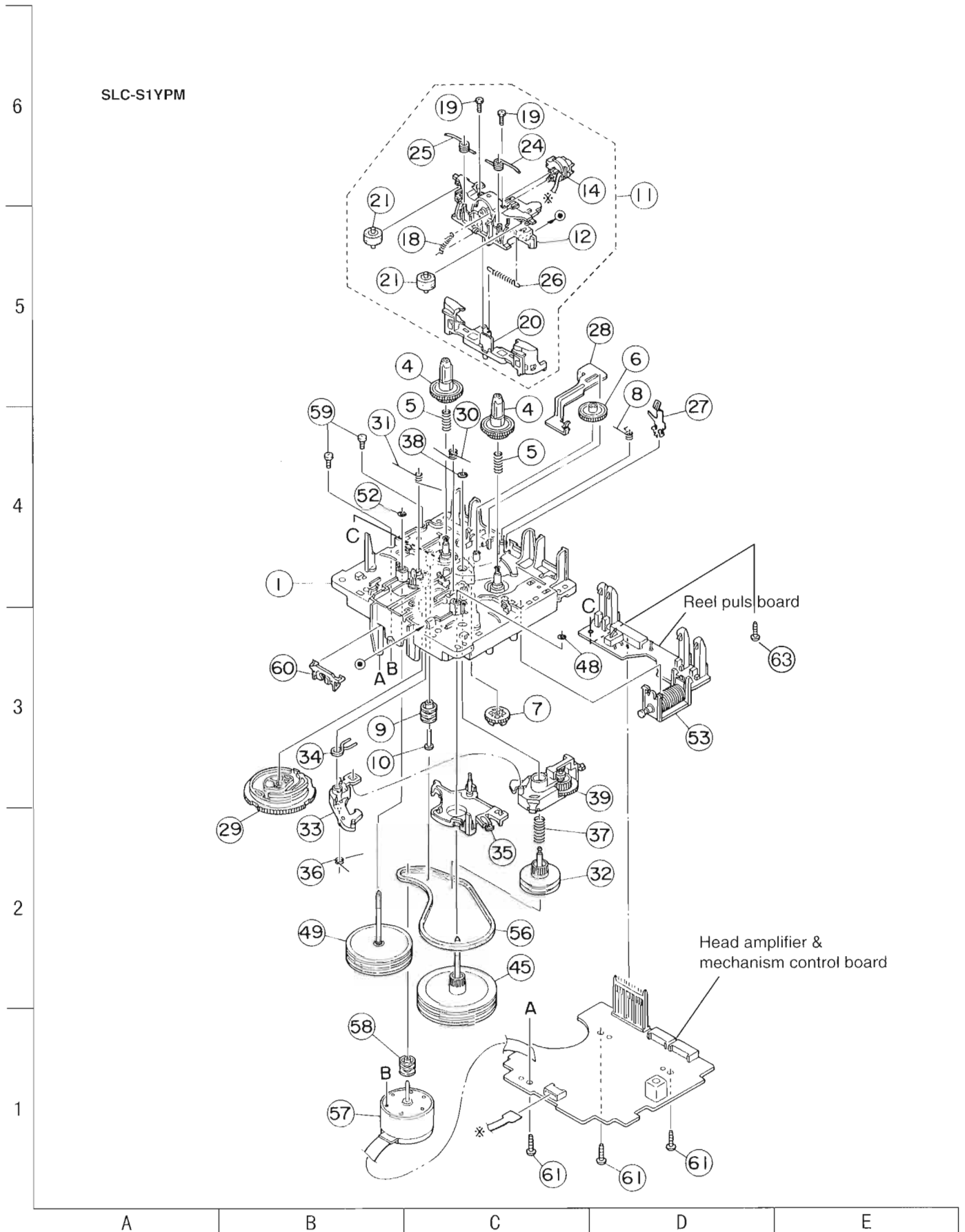

■ Parts List (Cassette Mechanism)

BLOCK NO.

△ REF.	PARTS NO.	PARTS NAME	REMARKS	QTY	SUFFIX	CLR
1	VKS1165-00G	CHASSIS B.ASS'Y		1		
4	VKS2274-002	REEL GEAR		2		
5	VKW5286-002	B.T. SPRING		2		
6	VKS5559-001	PLAY IDLE GEAR		1		
7	VKS5597-00A	FR GEAR ASS'Y		1		
8	VKW5296-001	EARTH SPRING		1		
9	VKR4749-002	IDLE PULLEY		1		
10	VKH5786-002	SHAFT		1		
11	VKS2275-00C	HEAD MOUNT ASSY		1		
12	VKS1167-001	HEAD MOUNT BASE		1		
14	VGH0425-544	R/P&E HEAD	VKS2275-00B	1		
18	VKW5302-001	HEAD SPRING		1		
19	VKZ4730-001	SPECIAL SCREW		2		
20	VKS2277-005	DIRECTION LEVER		1		
21	VKP4233-00A	PINCH ROL. ASSY		2		
24	VKW5299-002	PIN ROL.SP.(R)		1		
25	VKW5300-002	PIN ROL.SP.(L)		1		
26	VKW5285-001	RETURN SPRING		1		
27	VKY3149-002	CASSETTE SP.		1		
28	VKM3906-002	PLAY SW LEVER		1		
29	VKS1166-003	CONTROL CAM		1		
30	VKW5279-001	HEAD BASE SP(R)		1		
31	VKW5280-001	HEAD BASE SP(L)		1		
32	VKS5603-00D	MAIN PULLEY ASY		1		
33	VKS3785-001MM	FR ARM		1		
34	VKW5284-002	SWING SPRING		1		
35	VKS2278-003	TRIGGER ARM		1		
36	VKW5301-001	FR SPRING		1		
37	VKW5266-001	ELEVATOR SPRING		1		
38	WDL214025	WASHER		1		
39	VKS3786-00G	CLUTCH ASS'Y		1		
45	VKF3205-00B	F.WHEEL ASSY(R)		1		
48	WDL183425	SLIT WASHER		1		
49	VKF3207-00B	F.WHEEL ASSY(L)		1		
52	WDL173525-6	SLIT WASHER		1		
53	VKZ3174-00A	DC SOLENOID		1		
56	VKB3000-181	CAPSTAN BELT		1		
57	MSI-5U2LWA	D.C.MOTOR ASS'Y		1		
58	VKR4761-001	MOTOR PULLEY		1		
59	QYSPSP2604Z	SCREW		2		
60	VKS5577-001	FPC HOLDER		1		
61	QYSBSF2608Z	T.SCREW	FOR P.W.B.	3		
63	QYSBSF2006Z	SCREW		1		

Electrical Parts List

Main Board (UX-V5/UX-V3R)

BLOCK NO. 01111111		BLOCK NO. 01111111		
A REF.	PARTS NO.	PARTS NAME	REMARKS	SUFFIX
CN195	Q8B2016J1-15	CONNECTOR		
CN196	VMC0289-012	CONNECTOR		
CN197	VNZ0076-002	CONNECTOR		
CN199	Q6A7901C1-04	CONNECTOR	POWER PWB	
CN301	Q8B2016K1-15	B TO B CONNE	HEADPHONE	
CN304	QGA2501C3-05Z	CONNECTOR	CD DOOR	
CN308	ENV5111-002	2P CONNECTOR	SPEAKER	
CN311	QNB0092-001	SPK TERMINAL	MICOM TOP	
CN371	QGB1214K1-12S	CONNECTOR	MICOM BOT	
CN372	QGB1214K1-12S	CONNECTOR		
C1301	QET41CM-104	E CAPACITOR	10MF 20X 16V	
C1302	QET41HM-105	E CAPACITOR	1.0MF 20X 50V	
C1303	QETN1HM-104Z	E CAPACITOR	1.0MF 20X 50V	
C1304	QET41HM-105	E CAPACITOR	1.0MF 20X 50V	
C1305	QGS11HJ-390	C CAPACITOR	39PF 5X 50V	
C1306	QET41CM-226	E CAPACITOR	22MF 20X 16V	
C1307	QGBB1HK-101Y	C CAPACITOR	100PF 10X 50V	
C1308	QET41CM-226	E CAPACITOR	22MF 20X 16V	
C1309	QET41CM-226	E CAPACITOR	22MF 20X 16V	
C1901	QFV41HJ-104	TF CAPACITOR	.10MF 5X 50V	
C1902	QFV41HJ-104	TF CAPACITOR	.10MF 5X 50V	
C1903	QFV41HJ-104	TF CAPACITOR	.10MF 5X 50V	
C1904	QFV41HJ-104	TF CAPACITOR	.10MF 5X 50V	
C1910	QBY81CH-103Y	ABCAPACITOR		
C1911	QTE1C03-106Z	E CAPACITOR		
C1912	QTE1E06-476Z	E CAPACITOR		
C1916	QFV41HJ-104	TF CAPACITOR	.10MF 5X 50V	
C1917	QETC1CM-106Z	E CAPACITOR	10MF 20X 16V	
C3001	QETM1EM-828	E CAPACITOR	8200PF 20X 25V	
C3002	QFV41HJ-104	TF CAPACITOR	.10MF 5X 50V	
C3003	QETC1EM-107Z	E CAPACITOR	100MF 20X 25V	
C3004	QTE1A28-336Z	E CAPACITOR		
C3005	QETC1EM-336Z	E CAPACITOR	33MF 20X 25V	
C3006	QETC1HM-225Z	E CAPACITOR	2.2MF 20X 50V	
C3007	QETC1EM-104Z	E CAPACITOR	10MF 20X 25V	
C3101	QTE1C03-106Z	E CAPACITOR		
C3103	QGBB1HK-331Y	C CAPACITOR		
C3104	QDX31EM-104Z	C CAPACITOR	330PF 10X 50V	
C3105	QDX31EM-104Z	C CAPACITOR		
C3121	QFN41HJ-823	M CAPACITOR	.082MF 5X 50V	
C3122	QFN41HJ-823	M CAPACITOR	.082MF 5X 50V	
C3125	QTE1A03-226Z	E CAPACITOR		
C3126	QFVE1HJ-274Z	TF CAPACITOR	.27MF 5X 50V	
C3152	QFN31HJ-563Z	M.CAPA. I.M	.056MF 5X 50V	
C3153	QFN31HJ-563Z	M.CAPA. I.M	.056MF 5X 50V	
C3154	QFN41HJ-472	M CAPACITOR	4700PF 5X 50V	
C3157	QFN41HJ-123	M CAPACITOR	.012MF 5X 50V	
C3158	QTE1C03-106Z	E CAPACITOR		
C3201	QTE1C03-106Z	E CAPACITOR		
C3203	QGBB1HK-331Y	C CAPACITOR		
C3204	QDX31EM-104Z	C CAPACITOR	330PF 10X 50V	
C3205	QDX31EM-104Z	C CAPACITOR		
C3221	QFN41HJ-823	M CAPACITOR	.082MF 5X 50V	
C3222	QFN41HJ-823	M CAPACITOR	.082MF 5X 50V	
C3225	QTE1A03-226Z	E CAPACITOR		

BLOCK NO. 01111111		BLOCK NO. 01111111		
A REF.	PARTS NO.	PARTS NAME	REMARKS	SUFFIX
C3226	QFVE1HJ-274Z	TF CAPACITOR	.27MF 5X 50V	
C3232	QFN31HJ-563Z	M.CAPA. I.M	.056MF 5X 50V	
C3253	QFN31HJ-563Z	M.CAPA. I.M	.056MF 5X 50V	
C3254	QFN41HJ-472	M CAPACITOR	4700PF 5X 50V	
C3257	QFN41HJ-123	M CAPACITOR	.012MF 5X 50V	
C3258	QTE1C03-106Z	E CAPACITOR		
C3301	QETC1EM-106Z	E CAPACITOR	10MF 20X 25V	
C3321	QETC1EM-476Z	E CAPACITOR	47MF 20X 25V	
C3322	QTE1E03-226Z	E CAPACITOR		
C3331	QETC1HM-105Z	E CAPACITOR	1.0MF 20X 50V	
C3332	QETC1HM-105Z	E CAPACITOR	1.0MF 20X 50V	
C3333	QFVE1HJ-563Z	CAPACITOR	.056MF 5X 50V	
C3334	QFVE1HJ-563Z	CAPACITOR	.056MF 5X 50V	
C3335	QETC1HM-105Z	E CAPACITOR	1.0MF 20X 50V	
C3336	QETC1EM-106Z	E CAPACITOR	10MF 20X 25V	
C3351	QETC1EM-107Z	E CAPACITOR	100MF 20X 25V	
C3353	QETC1HM-474Z	E CAPACITOR	.47MF 20X 50V	
C3354	QETC1HM-474Z	E CAPACITOR	.47MF 20X 50V	
C3355	QETC1HM-474Z	E CAPACITOR	.47MF 20X 50V	
C3356	QTE1C28-106Z	E.CAPA. I.M		
C3357	QETC1EM-106Z	E CAPACITOR	10MF 20X 25V	
C3801	QER61EM-106Z	E.CAPA. I.M		
C3802	QER41CM-476	E CAPACITOR	47MF 20X 16V	
C3803	QFV41HJ-103	TF CAPACITOR	.010MF 5X 50V	
C3804	QER41CM-476	E CAPACITOR	47MF 20X 16V	
C3805	QC20205-155Z	M L C CAP. I/M	1.5MF	
C3901	QETC1EM-476Z	E CAPACITOR	47MF 20X 25V	
C3902	QDYB1CM-103Y	ABCAPACITOR		
C3903	QGBB1HK-221Y	C CAPACITOR	220PF 10X 50V	
C3904	QGBB1HK-221Y	C CAPACITOR	220PF 10X 50V	
C3931	QETC1EM-107Z	E CAPACITOR	100MF 20X 25V	
C3951	QER61EM-106Z	E.CAPA. I.M	10MF 20X 25V	
C3952	QER61EM-226Z	E.CAPA. I.M	22MF 20X 25V	
C3999	QGBB1HK-151Y	C CAPACITOR	FTZ	
D1301	1SS133-T2	DIODE	MIC	
D1302	1SS133-T2	DIODE	MIC	
A D1901	DSSBA20-S1	SI DIODE	ANALOG	
A D1908	MTJ24-3B-T2	ZENER DIODE	CD6V	
A D1913	MTJ16-8B-T2	DIODE	USSV	
D3321	MTJ15-1A-T2	ZENER DIODE		
D3331	1SS133-T2	DIODE		
D3332	1SS133-T2	DIODE		
D3333	1SS133-T2	DIODE		
D3334	1SS133-T2	DIODE		
D3801	DSK10C-T1	DIODE		
D3901	1SS133-T2	DIODE		
D3902	MTJ210A-T2	ZENER DIODE		
D3903	MTJ25-6C-T2	ZENER DIODE		
D3931	MTJ11A-T2	Z DIODE I.M		
D3932	1SS133-T2	DIODE		
D3951	MTJ36-8A-T2	ZENER DIODE		
D3952	MTJ10A-T2	ZENER DIODE		
EP301	GN20136-001Z	EARTH PLATE		
IC131	NJM4580L	IC	MIC	
A IC191	UPC78L05J-T	IC	USSV	

BLOCK NO. 01111111

A	REF.	PARTS NO.	PARTS NAME	REMARKS	SUFFIX
	R3122	GRE141J-221Y	C RESISTOR	220K 5X 1/4W	
	R3123	GRE141J-202Y	C RESISTOR	2.0K 5X 1/4W	
	R3124	GRE141J-222Y	C RESISTOR	2.2K 5X 1/4W	
	R3125	GRE141J-123Y	C RESISTOR	12K 5X 1/4W	
	R3127	GRE141J-153Y	C RESISTOR	15K 5X 1/4W	
	R3128	GRE141J-472Y	C RESISTOR	4.7K 5X 1/4W	
	R3129	GRE141J-562Y	C RESISTOR	5.6K 5X 1/4W	
	R3131	GRE141J-222Y	C RESISTOR	22K 5X 1/4W	
	R3132	GRE141J-223Y	C RESISTOR	22K 5X 1/4W	
	R3133	GRE141J-103Y	C RESISTOR	10K 5X 1/4W	
	R3152	GRE141J-622Y	C RESISTOR	6.2K 5X 1/4W	
	R3153	GRE141J-222Y	C RESISTOR	2.2K 5X 1/4W	
	R3154	GRE141J-182Y	C RESISTOR	1.8K 5X 1/4W	
	R3156	GRE141J-182Y	C RESISTOR	1.8K 5X 1/4W	
	R3202	GRE141J-472Y	C RESISTOR	4.7K 5X 1/4W	
A	R3204	GRE141J-2R2Y	C RESISTOR	2.2 5X 1/4W	
A	R3205	GRE141J-2R2Y	C RESISTOR	2.2 5X 1/4W	
	R3222	GRE141J-224Y	C RESISTOR	220K 5X 1/4W	
	R3223	GRE141J-202Y	C RESISTOR	2.0K 5X 1/4W	
	R3245	GRE141J-222Y	C RESISTOR	2.2K 5X 1/4W	
	R3255	GRE141J-123Y	C RESISTOR	12K 5X 1/4W	
	R3257	GRE141J-153Y	C RESISTOR	15K 5X 1/4W	
	R3258	GRE141J-472Y	C RESISTOR	4.7K 5X 1/4W	
	R3259	GRE141J-562Y	C RESISTOR	5.6K 5X 1/4W	
	R3261	GRE141J-223Y	C RESISTOR	22K 5X 1/4W	
	R3262	GRE141J-223Y	C RESISTOR	22K 5X 1/4W	
	R3263	GRE141J-103Y	C RESISTOR	10K 5X 1/4W	
	R3265	GRE141J-622Y	C RESISTOR	6.2K 5X 1/4W	
	R3266	GRE141J-222Y	C RESISTOR	2.2K 5X 1/4W	
	R3267	GRE141J-182Y	C RESISTOR	1.8K 5X 1/4W	
	R3268	GRE141J-182Y	C RESISTOR	1.8K 5X 1/4W	
	R3269	GRE141J-151Y	C RESISTOR	150 5X 1/4W	
	R3270	GRE141J-124Y	C RESISTOR	120K 5X 1/4W	
	R3271	GRE141J-154Y	C RESISTOR	150K 5X 1/4W	
	R3272	GRE141J-182Y	C RESISTOR	1.8K 5X 1/4W	
	R3273	GRE141J-182Y	C RESISTOR	1.8K 5X 1/4W	
	R3274	GRE141J-472Y	C RESISTOR	4.7K 5X 1/4W	
	R3275	GRE141J-472Y	C RESISTOR	4.7K 5X 1/4W	
	R3276	GRE141J-154Y	C RESISTOR	150K 5X 1/4W	
	R3277	GRE141J-154Y	C RESISTOR	150K 5X 1/4W	
	R3278	GRE141J-124Y	C RESISTOR	120K 5X 1/4W	
	R3279	GRE141J-124Y	C RESISTOR	120K 5X 1/4W	
	R3280	GRE141J-151Y	C RESISTOR	150 5X 1/4W	
	R3281	GRE141J-153Y	C RESISTOR	15K 5X 1/4W	
	R3282	GRE141J-472Y	C RESISTOR	4.7K 5X 1/4W	
	R3283	GRE141J-182Y	C RESISTOR	18K 5X 1/4W	
	R3284	GRE141J-182Y	C RESISTOR	18K 5X 1/4W	
	R3285	GRE141J-100Y	C RESISTOR	10 5X 1/4W	
	R3286	GRE141J-100Y	C RESISTOR	10 5X 1/4W	
A	R3287	GRE141J-1R2Y	C-RES I.M	1.2 5X 1/4W	
A	R3288	GRE141J-1R2Y	C-RES I.M	1.2 5X 1/4W	
A	R3289	GRE141J-1R2Y	C-RES I.M	1.2 5X 1/4W	
A	R3290	GRE141J-1R2Y	C-RES I.M	1.2 5X 1/4W	
A	R3291	GRE141J-471Y	C RESISTOR	4.70 5X 1/4W	

BLOCK NO. 01111111

A	REF.	PARTS NO.	PARTS NAME	REMARKS	SUFFIX
	IC301	LA4705NA	IC	POWER AMP	
	IC302	HJM4580L-D	IC	AHB AMP	
	IC303	BH3652S	IC	E VOL	
	IC308	TAB4095	IC	MIC	
	J1301	QNS0032-001	JACK		
A	J1901	QNS0006-001	AC SOCKET		
	K3801	QGR0779-001Z	INDUCTOR		
A	LF191	QGR0799-001	INDUCTOR		
	L3801	QGL250K-221Z	INDUCTOR		
	Q1301	2SC2785/FE/-T	TRANSISTOR	MIC	
	Q1302	2SC2785/FE/-T	TRANSISTOR	MIC	
	Q1303	2SA1589/OE/-T	TRANSISTOR	CD6V	
	Q1304	2SC2785/FE/-T	TRANSISTOR	CD6V	
	Q3101	2SD2144S/VM/-T	TRANSISTOR I/M		
	Q3131	2SC2785/FE/-T	TRANSISTOR		
	Q3201	2SD2144S/VM/-T	TRANSISTOR I/M		
	Q3251	2SC2785/FE/-T	TRANSISTOR		
	Q3301	DTA143ES-T	TR I/M		
	Q3801	2SC2785/FE/-T	TRANSISTOR		
	Q3901	2SB941/P/	TRANSISTOR		
A	Q3902	2SA1175/HFE/-T	TRANSISTOR		
	Q3903	2SC2785/FE/-T	TRANSISTOR		
	Q3904	KRC114M-T	TRANSISTOR		
	Q3905	DTA144TSA-T	D-TRANSISTOR		
	Q3906	2SC2785/FE/-T	TRANSISTOR		
A	Q3951	2SC2001/LK/-T	TRANSISTOR	UT	
	Q3951	2SA965/OY/-T	SI-TRANSISTOR		
A	Q3951	2SB562/BC/-T	TRANSISTOR		
	Q3952	KTC3199/GL/-T	TRANSISTOR		
	R1301	GRE141J-103Y	C RESISTOR	10K 5X 1/4W	
	R1303	GRE141J-474Y	C RESISTOR	470K 5X 1/4W	
	R1304	GRE141J-103Y	C RESISTOR	10K 5X 1/4W	
	R1305	GRE141J-103Y	C RESISTOR	10K 5X 1/4W	
	R1306	GRE141J-103Y	C RESISTOR	1.0K 5X 1/4W	
	R1307	GRE141J-103Y	C RESISTOR	1.0K 5X 1/4W	
	R1308	GRE141J-471Y	C RESISTOR	470 5X 1/4W	
	R1309	GRE141J-103Y	C RESISTOR	10K 5X 1/4W	
	R1310	GRE141J-102Y	C RESISTOR	1.0K 5X 1/4W	
	R1311	GRE141J-564Y	C RESISTOR	560K 5X 1/4W	
	R1312	GRE141J-392Y	C RESISTOR	3.9K 5X 1/4W	
	R1313	GRE141J-103Y	C RESISTOR	10K 5X 1/4W	
	R1314	GRE141J-273Y	C RESISTOR	27K 5X 1/4W	
	R1315	GRE141J-154Y	C RESISTOR	150K 5X 1/4W	
	R1316	GRE141J-154Y	C RESISTOR	150K 5X 1/4W	
	R1317	GRE141J-103Y	C RESISTOR	10K 5X 1/4W	
	R1318	GRE141J-221Y	C RESISTOR	220 5X 1/4W	
	R1902	GRE141J-181Y	C RESISTOR	180 5X 1/4W	
	R1903	GRE141J-103Y	C RESISTOR	10K 5X 1/4W	
	R1904	GRE141J-103Y	C RESISTOR	10K 5X 1/4W	
A	R1922	GRZ9006-4R7X	F RESISTOR	4.7 1/OW	
	R3001	GRE141J-103Y	C RESISTOR	10K 5X 1/4W	
	R3102	GRE141J-472Y	C RESISTOR	4.7K 5X 1/4W	
A	R3104	GRE141J-2R2Y	C RESISTOR	2.2 5X 1/4W	
A	R3105	GRE141J-2R2Y	C RESISTOR	2.2 5X 1/4W	

Function/Tuner Board (UX-V5/UX-V3R)

BLOCK NO. 01				BLOCK NO. 02			
REF.	PARTS NO.	PARTS NAME	REMARKS	REF.	PARTS NO.	PARTS NAME	REMARKS
R3906	GRE141J-122Y	C RESISTOR	1.2K 5% 1/4W	C	1	NCB21HK-223X	C CAPACITOR
R3907	GRE141J-752Y	C RESISTOR	7.5K 5% 1/4W	C	3	NCB21EK-473X	-0.47MF 10X 50V
R3908	GRE141J-152Y	C RESISTOR	1.5K 5% 1/4W	C	4	NCB21HK-103X	-0.10MF 10X 50V
R3909	GRE141J-102Y	C RESISTOR	1.0K 5% 1/4W	E	5	QEK41CM-106	10MF 20X 16V
R3910	GRE141J-472Y	C RESISTOR	4.7K 5% 1/4W	C	8	NCB21HK-103X	0.10MF 10X 50V
R3911	GRE141J-471Y	C RESISTOR	470 5% 1/4W	C	9	NCB21EK-103X	1000PF 10X 50V
R3912	GRE141J-681Y	C RESISTOR	680 5% 1/4W	C	21	NCB21EK-473X	0.47MF 10X 25V
R3913	GRE141J-681Y	C RESISTOR	680 5% 1/4W	C	23	NCS21HJ-380X	3.0PF 5X 50V
R3914	GRE141J-681Y	C RESISTOR	680 5% 1/4W	E	30	QEK61CM-476Z	47MF 20X 16V
R3915	GRE141J-681Y	C RESISTOR	680 5% 1/4W	C	31	NCS21HJ-800X	2.0PF 5X 50V
R3916	GRE141J-681Y	C RESISTOR	680 5% 1/4W	C	32	NCB21HK-102X	1000PF 10X 50V
R3917	GRE141J-682Y	C RESISTOR	6.8K 5% 1/4W	E	33	QEK61AM-107Z	100MF 20X 10V
R3918	GRE141J-472Y	C RESISTOR	4.7K 5% 1/4W	C	34	NCS21HJ-150X	15PF 5X 50V
R3919	GRE141J-222Y	C RESISTOR	2.2K 5% 1/4W	C	35	NCB21HK-102X	1000PF 10X 50V
R3920	GRE141J-223Y	C RESISTOR	22K 5% 1/4W	E	36	QEK61CM-106Z	10MF 20X 16V
R3921	GRE141J-103Y	C RESISTOR	10K 5% 1/4W	C	37	NCB21EK-473X	-0.47MF 10X 25V
R3931	GRE141J-561Y	C RESISTOR	560 5% 1/4W	C	39	NCB21EK-473X	-0.47MF 10X 25V
R3951	QRZ9006-6R8X	F RESISTOR	FS-V5	C	40	NCB21HK-103X	-0.10MF 10X 50V
R3952	GRE141J-102Y	C RESISTOR	1.0K 5% 1/4W	C	41	QEK61HM-104Z	-0.10MF 20X 50V
R3953	GRE141J-103Y	C RESISTOR	10K 5% 1/4W	C	42	QEK61HM-474Z	-4.7MF 20X 50V
R3954	GRE141J-103Y	C RESISTOR	10K 5% 1/4W	C	44	NCS21HJ-421X	220PF 5X 50V
R5501	GRE141J-102Y	C RESISTOR	1.0K 5% 1/4W	E	45	QEK61HM-355Z	3.3MF 20X 50V
R5502	GRE141J-102Y	C RESISTOR	1.0K 5% 1/4W	C	46	NCB21HK-223X	-0.22MF 10X 50V
R5503	GRE141J-122Y	C RESISTOR	1.2K 5% 1/4W	C	47	NCB21HK-103X	-0.10MF 10X 50V
R5504	GRE141J-152Y	C RESISTOR	1.5K 5% 1/4W	C	49	NCB21HK-153X	-0.15MF 10X 50V
R5505	GRE141J-222Y	C RESISTOR	2.2K 5% 1/4W	C	50	NCB21HK-153X	-0.15MF 10X 50V
R5506	GRE141J-272Y	C RESISTOR	2.7K 5% 1/4W	E	51	QEK61HM-105Z	1.0MF 20X 50V
R5507	GRE141J-392Y	C RESISTOR	3.9K 5% 1/4W	E	52	QEK61HM-105Z	1.0MF 20X 50V
R5508	GRE141J-562Y	C RESISTOR	5.6K 5% 1/4W	E	55	NCS21HJ-120X	12PF 5X 50V
R7701	GRZ9006-4R7X	F RESISTOR	US6V F RES #-V3	E	60	QEK61AM-107Z	100MF 20X 10V
S1901	VM20126-003	VOLTAGE SELECTOR	V57UB/US/UX/UT	C	61	NCS21HJ-120X	12PF 5X 50V
S5501	QSM0698-001Z	TACT SWITCH	REC	C	62	NCB21EK-473X	-0.47MF 10X 25V
S5502	QSM0698-001Z	TACT SWITCH	REV. MODE	C	65	NCB21HK-102X	1000PF 10X 50V
S5504	QSM0698-001Z	TACT SWITCH	SLEEP	C	66	NCS21HJ-151X	150PF 5X 50V
S5505	QSM0698-001Z	TACT SWITCH	CLOCK	C	67	NCS21HJ-101X	100PF 5X 50V
S5506	QSM0698-001Z	TACT SWITCH	TIMER	C	68	NCS21HJ-151X	150PF 5X 50V
S5507	QSM0698-001Z	TACT SWITCH	VOL. UP	E	69	QEK61HM-225Z	2.2MF 20X 50V
S5508	QSM0698-001Z	TACT SWITCH	VOL. DOWN	C	70	NCB21HK-592X	3900PF 10X 50V
S5509	QSM0698-001Z	TACT SWITCH	AHB	E	71	QEK61HM-355Z	3.3MF 20X 50V
VR131	GVG0112-824	V RESISTOR	MIC	C	72	NCB21HK-102X	1000PF 10X 50V
Z1901	NGG0020-001Z	FUSE CLIP	FOR F1901	C	80	NCS21HJ-800X	8.0PF 5X 50V
Z1902	NGG0020-001Z	FUSE CLIP	FOR F1901	C	81	NCB21HK-122X	1200PF 10X 25V
Z1903	NGG0020-001Z	FUSE CLIP	FOR F1902	C	82	NCB21EK-473X	-0.47MF 10X 25V
Z1904	NGG0020-001Z	FUSE CLIP	FOR F1902	C	83	NCB21HK-103X	-0.10MF 10X 50V
				C	84	NCB21HK-103X	-0.10MF 10X 50V
				C	85	NCB21HK-102X	1000PF 10X 50V
				C	86	NCB21HK-102X	1000PF 10X 50V
				C	90	NCB21HK-682X	6800PF 10X 50V
				C	91	NCB21EK-473X	-0.47MF 10X 25V
				C	92	NCS21HJ-101X	100PF 5X 50V
				C	93	NCS21HJ-120X	12PF 5X 50V
				C	94	NCS21HJ-120X	12PF 5X 50V
				C	95	NCS21HJ-102X	1000PF 5X 50V
				C	96	NCS21HJ-800X	8.0PF 5X 50V

BLOCK NO. 02111111

REF.	PARTS NO.	PARTS NAME	REMARKS	SUFFIX
D 1	1SS133-T2	DIODE		
D 2	1SS133-T2	DIODE		
D 3	1SS133-T2	DIODE		
D 4	1SS133-T2	DIODE		
D 5	1SS133-T2	DIODE		
D 6	1SS133-T2	DIODE		
D 20	SVC344-T	VARI CAP	V3/UT	
D 21	KV1555N-T	VARI CAP	V3/UT	
D 21	KV1555N-T	VARI CAP		
D 21	SVC344-T	VARI CAP		
D1801	4LD0079-001	LED MODULE		
D3501	MTZJ3.5B-T2	ZENER DIODE I/M	AUX MUTE	
D3502	1SS133-T2	DIODE	SEIDENKI	
D3503	1SS133-T2	DIODE		
D3504	1SS133-T2	DIODE		
D5901	MTZJ3.9B-T2	Z DIODE		
D5902	1SS133-T2	DIODE		
D5903	1SS133-T2	DIODE		
D5905	MTZJ9.1A-T2	ZENER DIODE	CT	
D5906	1SS133-T2	DIODE	CT	
D8001	SPR-39MVF	LED	RED	
D8003	1SS133-T2	DIODE		
D8301	SELU1E56BM	LED	V3	
D8301	TYH156P	LED	V5	
D8302	TYH156P	LED	V5	
D8302	SELU1E56BM	LED	V3	
D8303	SELU1E56BM	LED	V3	
EP501	GNZ0136-001Z	EARTH PLATE	V5	
IC 1	TA2057N	IC		
IC 2	LC72136N	IC		
IC531	BA15218F-W	IC		
IC801	PPM6938-V4	RM-RECEIVER	AM/FM ANT	
J 1	GNB0008-001	ANT TERMINAL		
J3004	GNB0032-001	JACK		
J3701	GNB0306-001	4PIN JACK ASSY	A5MD 2P	
J3701	GP1F32T	OPTICAL JACK	MD 32R	
K3106	GR0779-001Z	INDUCTOR		
K3206	GR0779-001Z	INDUCTOR		
K3301	GR0779-001Z	INDUCTOR		
K3302	GR0779-001Z	INDUCTOR		
K3303	GR0779-001Z	INDUCTOR		
K3307	GR0779-001Z	INDUCTOR	CD AG	
L 1	QGR0796-001	COIL BLOCK	MW RF/OSC	
L 4	QGL231K-221Y	INDUCTOR		
L 5	QGL231K-220Y	INDUCTOR		
L 6	QGR0792-001	OSC COIL	SW1 OSC	
L 7	QGR0791-001	RF COIL	SW2 RF	
L 8	QGR0791-001	RF COIL	SW2 OSC	
L 10	QGR0874-001	COIL		
L 11	QGR0874-001	COIL		
L 12	QGL231K-221Y	INDUCTOR		
LF511	GR0590-001	FILTER		
LF521	GR0590-001	FILTER		
L3106	QGL231K-470Y	INDUCTOR		

BLOCK NO. 02111111

REF.	PARTS NO.	PARTS NAME	REMARKS	SUFFIX
C 99	NCS21HJ-4R0X	C CAPACITOR	4.0PF 5X 50V	
C 99	NCB21EK-104X	C CAPACITOR	.10MF 10X 25V	
CF 1	QAX0419-001Z	C FILTER		
CF 2	QAX0419-001Z	C FILTER		
CF 3	QAX0418-001Z	C FILTER		
CF 4	QAX0409-001Z	C FILTER		
CN 43	GGF1201E3-09	CONNECTOR	CT	
CN 44	GGF1201E3-10	CONNECTOR	CT	
CN501	QGA2001E1-04	4P PLUG ASSY	M06P	
CN502	GGF1201C3-10	CONNECTOR	VCD12P	
CN503	VMCO289-F12	CONNECTOR		
CN504	QGA2501F1-03	CONNECTOR		
CN506	QGB1214J1-12S	CONNECTOR		
CN507	QGB1214J1-12S	CONNECTOR		
CN508	QGA2001E1-02	2P CONNECTOR		
CN811	GGF1016F1-07	CONNECTOR		
CN812	GGF1008F1-11	CONNECTOR		
C3108	NCS21HJ-331X	C CAPACITOR	330PF 5X 50V	
C3208	NCS21HJ-331X	C CAPACITOR	330PF 5X 50V	
C5101	NCS21HJ-151X	C CAPACITOR	150PF 5X 50V	
C5102	QFN41HJ-562	M CAPACITOR	5600PF 5X 50V	
C5103	GTE1H06-475Z	E CAPACITOR	33PF 5X 50V	
C5105	NCS21HJ-330X	C CAPACITOR	10PF 5X 50V	
C5106	NCS21HJ-100X	C CAPACITOR	4.7MF 20X 50V	
C5107	GER41HM-475	E CAPACITOR	4.7MF 20X 50V	
C5108	GER41HM-475	E CAPACITOR	4.7MF 20X 50V	
C5109	NCB21HK-102X	C CAPACITOR	1000PF 10X 50V	
C5110	GER41HM-475	E CAPACITOR	4.7MF 20X 50V	
C5201	NCS21HJ-151X	C CAPACITOR	150PF 5X 50V	
C5202	QFN41HJ-562	M CAPACITOR	5600PF 5X 50V	
C5203	GTE1H06-475Z	E CAPACITOR	33PF 5X 50V	
C5205	NCS21HJ-330X	C CAPACITOR	10PF 5X 50V	
C5207	GER41HM-475	E CAPACITOR	4.7MF 20X 50V	
C5208	GER41HM-475	E CAPACITOR	4.7MF 20X 50V	
C5209	NCB21HK-102X	C CAPACITOR	1000PF 10X 50V	
C5210	GER41HM-475	E CAPACITOR	4.7MF 20X 50V	
C5301	NCB21HK-103X	C CAPACITOR	.010MF 10X 50V	
C5302	GER41HM-225	E CAPACITOR	2.2MF 20X 50V	
C5303	GER41HM-225	E CAPACITOR	2.2MF 20X 50V	
C5304	GER41HM-105	E CAPACITOR	1.0MF 20X 50V	
C5307	GER41CM-474	E CAPACITOR	47MF 20X 16V	
C5308	GER41CM-224	E CAPACITOR	22MF 20X 16V	
C5309	GER41HM-105	E CAPACITOR	1.0MF 20X 50V	
C5311	NCB21HK-102X	C CAPACITOR	1000PF 10X 50V	
C5312	NCB21HK-103X	C CAPACITOR	.010MF 10X 50V	
C5313	NCB21HK-104X	C CAPACITOR	.10MF +80: -20X	
C5315	NCB21HK-103X	C CAPACITOR	.010MF 10X 50V	
C5901	GER41EM-475	E CAPACITOR	4.7MF 20X 25V	
C5902	GER61CM-107Z	E-CAPA. I-M	100MF 20X 16V	
C8001	GER41CM-476	E CAPACITOR	47MF 20X 16V	
C8002	GER41CM-107	E CAPACITOR	100MF 20X 10V	
C8003	NCB21HK-103X	C CAPACITOR	.010MF 10X 50V	
C8201	NCB21HK-223X	C CAPACITOR	.023MF 10X 50V	
C8202	NCS21HJ-101X	C CAPACITOR	100PF 5X 50V	

BLOCK NO. 021111		BLOCK NO. 021111		
REF.	PART'S NO.	PART'S NAME	REMARKS	SUFFIX
L3206	06L231K-470V	INDUCTOR	FTZ	
L3301	06L298J-470Z	INDUCTOR		
PP531	02W0007-001	POST PIN		
PP532	02W0007-001	POST PIN		
PP533	02W0007-001	POST PIN		
Q 1	25C2668/07-T	TRANSISTOR TAPE		
Q 2	DTA114TKA-X	DIGITAL TR	SW1 SWITCH	
Q 3	DTA114TKA-X	DIGITAL TR	MW SWITCH	
Q 6	DTA114TKA-X	TRANSISTOR		
Q 7	25A1037AK/R/-X	CHIP TR.C.M		
Q 8	25A1037AK/R/-X	CHIP TR.C.M		
Q 12	25D2144S/VW/-T	TRANSISTOR I/M	MW SWITCH	
Q 13	25C2668/07-T	TRANSISTOR TAPE		
Q 14	25A1037AK/R/-X	CHIP TR.C.M	MW SWITCH	
Q 15	25A1037AK/R/-X	CHIP TR.C.M	MW SWITCH	
Q 21	DTA114TKA-X	DIGITAL TR	SW2 SWITCH	
Q 22	25C2668/07-T	TRANSISTOR TAPE	SW2 SWITCH	
Q 24	25D2144S/VW/-T	TRANSISTOR I/M	SW1 SWITCH	
Q 25	25A1037AK/R/-X	CHIP TR.C.M	SW1 SWITCH	
Q 26	DTA114TKA-X	DIGITAL TR	SW1 SWITCH	
Q 27	25C2668/07-T	TRANSISTOR TAPE	SW1 SWITCH	
Q 28	25A1037AK/R/-X	CHIP TR.C.M	SW2 SWITCH	
Q5101	25D2114K/VW/-X	CHIP TR.C.M		
Q5102	25D2114K/VW/-X	CHIP TR.C.M		
Q5103	25C2412K/R/-X	TRANSISTOR		
Q5104	25D2114K/VW/-X	CHIP TR.C.M	CT	
Q5106	25C2412K/R/-X	TRANSISTOR	W/O ASMD	
Q5201	25D2114K/VW/-X	CHIP TR.C.M		
Q5202	25D2114K/VW/-X	CHIP TR.C.M		
Q5203	25C2412K/R/-X	TRANSISTOR		
Q5204	25D2114K/VW/-X	CHIP TR.C.M	CT	
Q5206	25C2412K/R/-X	TRANSISTOR	W/O ASMD	
Q5301	DTA143EKA-X	TRANSISTOR		
Q5302	DTA143EKA-X	TRANSISTOR		
Q5303	DTA144EKA-X	DIGITAL TR	CT	
Q5308	DTA144EKA-X	DIGITAL TR	W/O ASMD	
Q5901	25A1037AK/R/-X	CHIP TR.C.M		
Q5902	25C2412K/R/-X	TRANSISTOR	CT	
Q5903	25D4687BC/-T	TRANSISTOR		
Q8001	DT114TKA-X	TRANSISTOR		
R 1	NRSA02J-102X	MG RESISTOR	1.0K 5X 1/10W	
R 2	NRSA02J-821X	MG RESISTOR	820 5X 1/10W	
R 11	NRSA02J-104X	MG RESISTOR	100K 5X 1/10W	
R 12	NRSA02J-222X	MG RESISTOR	2.2K 5X 1/10W	
R 13	NRSA02J-103X	MG RESISTOR	10K 5X 1/10W	
R 14	NRSA02J-103X	MG RESISTOR	10K 5X 1/10W	
R 15	NRSA02J-103X	MG RESISTOR	1.0K 5X 1/10W	
R 18	NRSA02J-102X	MG RESISTOR	1.0K 5X 1/10W	
R 20	NRSA02J-331X	MG RESISTOR	330 5X 1/10W	
R 21	NRSA02J-224X	RES. C.M	220K 5X 1/10W	
R 22	NRSA02J-331X	MG RESISTOR	330 5X 1/10W	
R 23	NRSA02J-270X	MG RESISTOR	27 5X 1/10W	
R 24	NRSA02J-271X	MG RESISTOR	270 5X 1/10W	
R 25	NRSA02J-473X	MG RESISTOR	47K 5X 1/10W	
R 27	NRSA02J-223X	MG RESISTOR	22K 5X 1/10W	
A REF.	PART'S NO.	PART'S NAME	REMARKS	SUFFIX
R 28	NRSA02J-560X	MG RESISTOR	56 5X 1/10W	
R 29	NRSA02J-473X	MG RESISTOR	47K 5X 1/10W	
R 30	NRSA02J-103X	MG RESISTOR	10K 5X 1/10W	
R 31	NRSA02J-103X	MG RESISTOR	10K 5X 1/10W	
R 32	NRSA02J-473X	MG RESISTOR	47K 5X 1/10W	
R 34	NRSA02J-333X	MG RESISTOR	33K 5X 1/10W	
R 35	NRSA02J-333X	MG RESISTOR	33K 5X 1/10W	
R 36	NRSA02J-103X	MG RESISTOR	10K 5X 1/10W	
R 37	NRSA02J-472X	MG RESISTOR	4.7K 5X 1/10W	
R 38	NRSA02J-392X	MG RESISTOR	3.9K 5X 1/10W	
R 39	NRSA02J-392X	MG RESISTOR	3.9K 5X 1/10W	
R 42	NRSA02J-102X	MG RESISTOR	1.0K 5X 1/10W	
R 43	NRSA02J-102X	MG RESISTOR	1.0K 5X 1/10W	
R 44	NRSA02J-102X	MG RESISTOR	1.0K 5X 1/10W	
R 45	NRSA02J-102X	MG RESISTOR	1.0K 5X 1/10W	
R 46	NRSA02J-473X	MG RESISTOR	47K 5X 1/10W	
R 48	NRSA02J-102X	MG RESISTOR	1.0K 5X 1/10W	
R 52	NRSA02J-473X	MG RESISTOR	4.7K 5X 1/10W	
R 54	NRSA02J-47X	MG RESISTOR	4.7K 5X 1/10W	
R 55	NRSA02J-18X	MG RESISTOR	1.8K 5X 1/10W	
R 56	NRSA02J-332X	MG RESISTOR	3.3K 5X 1/10W	
R 57	NRSA02J-102X	MG RESISTOR	1.0K 5X 1/10W	
R 62	NRSA02J-103X	MG RESISTOR	10K 5X 1/10W	
R 63	NRSA02J-103X	MG RESISTOR	10K 5X 1/10W	
R 65	NRSA02J-222X	MG RESISTOR	2.2K 5X 1/10W	
R 66	NRSA02J-222X	MG RESISTOR	2.2K 5X 1/10W	
R 68	NRSA02J-473X	MG RESISTOR	47K 5X 1/10W	
R 69	NRSA02J-222X	MG RESISTOR	2.2K 5X 1/10W	
R 81	NRSA02J-104X	MG RESISTOR	100K 5X 1/10W	
R 82	NRSA02J-104X	MG RESISTOR	100K 5X 1/10W	
R 83	NRSA02J-222X	MG RESISTOR	2.2K 5X 1/10W	
R 84	NRSA02J-223X	MG RESISTOR	22K 5X 1/10W	
R 85	NRSA02J-103X	MG RESISTOR	10K 5X 1/10W	
R 86	NRSA02J-102X	MG RESISTOR	1.0K 5X 1/10W	
R 90	NRSA02J-332X	MG RESISTOR	3.3K 5X 1/10W	
R 91	NRSA02J-104X	MG RESISTOR	100K 5X 1/10W	
R 92	NRSA02J-102X	MG RESISTOR	1.0K 5X 1/10W	
R 96	NRSA02J-104X	MG RESISTOR	1.0K 5X 1/10W	
R 97	NRSA02J-104X	MG RESISTOR	100K 5X 1/10W	
R 98	NRSA02J-103X	MG RESISTOR	10K 5X 1/10W	
R3106	NRSA02J-151X	MG RESISTOR	150 5X 1/10W	
R3107	NRSA02J-471X	MG RESISTOR	470 5X 1/10W	
R3206	NRSA02J-151X	MG RESISTOR	150 5X 1/10W	
R3207	NRSA02J-471X	MG RESISTOR	470 5X 1/10W	
R5101	NRSA02J-513X	MG RESISTOR	51K 5X 1/10W	
R5102	NRSA02J-273X	MG RESISTOR	27K 5X 1/10W	
R5103	NRSA02J-153X	MG RESISTOR	15K 5X 1/10W	
R5104	NRSA02J-222X	MG RESISTOR	2.2K 5X 1/10W	
R5105	NRSA02J-222X	MG RESISTOR	2.2K 5X 1/10W	
R5106	NRSA02J-153X	MG RESISTOR	15K 5X 1/10W	
R5107	NRSA02J-122X	MG RESISTOR	1.2K 5X 1/10W	
R5108	NRSA02J-682X	MG RESISTOR	6.8K 5X 1/10W	
R5109	NRSA02J-222X	MG RESISTOR	2.2K 5X 1/10W	
R5110	NRSA02J-188X	MG RESISTOR	1.8K 5X 1/10W	
R5111	NRSA02J-123X	RES. C.M	12K 5X 1/10W	

BLOCK NO. 02111111		BLOCK NO. 02111111			
REF.	PARTS NO.	PARTS NAME	REMARKS	SUFFIX	
R5112	NRSA02J-472X	MG RESISTOR	4.7K 5X 1/10W		
R5113	NRSA02J-153X	MG RESISTOR	15K 5X 1/10W		
R5114	NRSA02J-222X	MG RESISTOR	2.2K 5X 1/10W		
R5115	NRSA02J-103X	MG RESISTOR	10K 5X 1/10W		
R5116	NRSA02J-753X	MG RESISTOR	7.5K 5X 1/10W		
R5121	NRSA02J-393X	MG RESISTOR	39K 5X 1/10W		
R5122	NRSA02J-102X	MG RESISTOR	1.0K 5X 1/10W		
R5123	NRSA02J-154X	RES - C.M	150K 5X 1/10W		
R5124	NRSA02J-473X	MG RESISTOR	47K 5X 1/10W		
R5125	NRSA02J-332X	MG RESISTOR	3.3K 5X 1/10W		
R5126	NRSA02J-102X	MG RESISTOR	1.0K 5X 1/10W		
R5127	NRSA02J-222X	MG RESISTOR	2.2K 5X 1/10W		
R5128	NRSA02J-182X	MG RESISTOR	1.8K 5X 1/10W		
R5201	NRSA02J-513X	MG RESISTOR	51K 5X 1/10W		
R5202	NRSA02J-273X	MG RESISTOR	27K 5X 1/10W		
R5203	NRSA02J-153X	MG RESISTOR	15K 5X 1/10W		
R5204	NRSA02J-182X	MG RESISTOR	1.8K 5X 1/10W		
R5205	NRSA02J-182X	MG RESISTOR	1.8K 5X 1/10W		
R5206	NRSA02J-153X	MG RESISTOR	15K 5X 1/10W		
R5207	NRSA02J-122X	MG RESISTOR	1.2K 5X 1/10W		
R5208	NRSA02J-682X	MG RESISTOR	6.8K 5X 1/10W		
R5209	NRSA02J-222X	MG RESISTOR	2.2K 5X 1/10W		
R5210	NRSA02J-182X	MG RESISTOR	1.8K 5X 1/10W		
R5211	NRSA02J-123X	RES - C.M	12K 5X 1/10W		
R5212	NRSA02J-472X	MG RESISTOR	4.7K 5X 1/10W		
R5213	NRSA02J-153X	MG RESISTOR	15K 5X 1/10W		
R5214	NRSA02J-622X	MG RESISTOR	2.2K 5X 1/10W		
R5215	NRSA02J-103X	MG RESISTOR	10K 5X 1/10W		
R5216	NRSA02J-753X	MG RESISTOR	7.5K 5X 1/10W		
R5221	NRSA02J-393X	MG RESISTOR	39K 5X 1/10W		
R5222	NRSA02J-102X	MG RESISTOR	1.0K 5X 1/10W		
R5223	NRSA02J-154X	RES - C.M	150K 5X 1/10W		
R5224	NRSA02J-473X	MG RESISTOR	47K 5X 1/10W		
R5225	NRSA02J-332X	MG RESISTOR	3.3K 5X 1/10W		
R5226	NRSA02J-102X	MG RESISTOR	1.0K 5X 1/10W		
R5227	NRSA02J-222X	MG RESISTOR	2.2K 5X 1/10W		
R5228	NRSA02J-222X	MG RESISTOR	2.2K 5X 1/10W		
R5229	NRSA02J-182X	MG RESISTOR	1.8K 5X 1/10W		
R5301	NRSA02J-822X	MG RESISTOR	8.2K 5X 1/10W		
R5302	NRSA02J-822X	MG RESISTOR	8.2K 5X 1/10W		
R5303	NRSA02J-750X	RES - C.M	75 5X 1/10W		
R5304	NRSA02J-750X	RES - C.M	75 5X 1/10W		
R5305	NRSA02J-750X	RES - C.M	75 5X 1/10W		
R5306	NRSA02J-223X	MG RESISTOR	22K 5X 1/10W		
R5308	NRSA02J-332X	MG RESISTOR	3.3K 5X 1/10W		
R5311	NRSA02J-750X	RES - C.M	75 5X 1/10W		
R5312	NRSA02J-473X	MG RESISTOR	47K 5X 1/10W		
R5313	NRSA02J-513X	MG RESISTOR	51K 5X 1/10W		
R5314	NRSA02J-223X	MG RESISTOR	22K 5X 1/10W		
R5901	NRSA02J-390X	MG RESISTOR	39 5X 1/10W		
R5902	NRSA02J-352X	MG RESISTOR	3.5K 5X 1/10W		
R5903	NRSA02J-273X	MG RESISTOR	27K 5X 1/10W		
R5904	NRSA02J-102X	MG RESISTOR	1.0K 5X 1/10W		
R5905	NRSA02J-471X	MG RESISTOR	470 5X 1/10W		
A	REF.	PARTS NO.	PARTS NAME	REMARKS	SUFFIX
	R5906	NRSA02J-471X	MG RESISTOR	470 5X 1/10W	
	R5907	NRSA02J-192X	MG RESISTOR	3.9K 5X 1/10W	
	R5908	NRSA02J-332X	MG RESISTOR	3.3K 5X 1/10W	
	R8001	NRSA02J-102X	MG RESISTOR	1.0K 5X 1/10W	
	R8002	NRSA02J-102X	MG RESISTOR	1.0K 5X 1/10W	
	R8003	NRSA02J-122X	MG RESISTOR	1.2K 5X 1/10W	
	R8004	NRSA02J-152X	MG RESISTOR	1.5K 5X 1/10W	
	R8006	NRSA02J-222X	MG RESISTOR	2.2K 5X 1/10W	
	R8007	NRSA02J-272X	MG RESISTOR	2.7K 5X 1/10W	
	R8010	NRSA02J-681X	MG RESISTOR	3.9K 5X 1/10W	
	R8011	GRE141J-152Y	C RESISTOR	680 5X 1/10W	
	R8201	NRSA02J-432X	RES - C.M	4.3K 5X 1/10W	
	R8301	NRSA02J-471X	MG RESISTOR	V3	
	R8302	NRSA02J-821X	MG RESISTOR	V5	
	R8302	NRSA02J-821X	MG RESISTOR	V5	
	R8303	NRSA02J-471X	MG RESISTOR	V3	
	R8303	NRSA02J-821X	MG RESISTOR	V5	
	R8304	NRSA02J-821X	MG RESISTOR	V5	
	R8304	NRSA02J-821X	MG RESISTOR	V5	
	R8305	NRSA02J-471X	MG RESISTOR	V3	
	R8305	NRSA02J-821X	MG RESISTOR	V5	
	R8306	NRSA02J-821X	MG RESISTOR	V5	
	R8306	NRSA02J-471X	MG RESISTOR	V3	
	R8307	NRSA02J-102X	MG RESISTOR	V5	
	R8308	NRSA02J-102X	MG RESISTOR	V5	
	R8309	NRSA02J-102X	MG RESISTOR	V5	
	S8001	QSM0698-001Z	TACT SWITCH	DOOR OP/CL	
	S8002	QSM0698-001Z	TACT SWITCH	CD	
	S8003	QSM0698-001Z	TACT SWITCH	TUNER	
	S8004	QSM0698-001Z	TACT SWITCH	TAPE	
	S8005	QSM0698-001Z	TACT SWITCH	MD/AUX	
	S8006	QSM0698-001Z	TACT SWITCH	B-SEARCH	
	S8007	QSM0698-001Z	TACT SWITCH	STOP/CLR	
	S8008	QSM0698-001Z	TACT SWITCH	F-SEARCH	
	S8010	QSM0698-001Z	TACT SWITCH	POWER	
	S8101	QSM0620-001	SWITCH		
	S8102	QSM0620-001	SWITCH		
	T 1	QQR0793-001	LIFT		
	TU 1	GAU0037-001	FRONT_END		
	X 1	QAX0402-001	CRYSTAL		

Micon Board (UX-V5/UX-V3R)

BLOCK NO. 03111111				BLOCK NO. 03111111					
REF.	PARTS NO.	PARTS NAME	REMARKS	SUFFIX	REF.	PARTS NO.	PARTS NAME	REMARKS	SUFFIX
CN701	GGF1201F3-13	CONNECTOR	TO CD PWB		G7002	25C266B/0/-T	TRANSISTOR TAPE	CLOCK SHIFT	
CN706	GB1214K1-12S	CONNECTOR	TO FUNCTION PWB		G7301	25C2412K/R/-X	TRANSISTOR	BACKUP CONT	
CN707	GB1214K1-12S	CONNECTOR	TO FUNCTION PWB		G7311	25C2412K/R/-X	TRANSISTOR	RESET	
CN711	GGF1016C1-07	CONNECTOR	TO FREY PWB		G7321	25A1037AK/R/-X	CHIP TR.C.M	SM5V	
CN712	GGF1008F1-11	CONNECTOR	TO LCD PWB		G7811	25C2412K/R/-X	TRANSISTOR	PHOTO BUFFER	
CN714	GG2001C1-03	3P PLUG ASSY	TO DOOR-SW PWB		G7821	DTG114EKA-X	TR	BL DIMMER	
CN771	GGB1214J1-12S	CONNECTOR	TO MAIN PWB		G7822	25A933S/R/S/-T	TRANSISTOR	BL DIMMER	
CN772	GGB1214J1-12S	CONNECTOR	TO MAIN PWB		R7001	NRSA02J-822X	MG RESISTOR	8.2K 5% 1/10W	
C7001	NCS21HJ-180X	C CAPACITOR	18PF 5% 50V		R7002	NRSA02J-822X	MG RESISTOR	8.2K 5% 1/10W	
C7002	NCS21HJ-180X	C CAPACITOR	18PF 5% 50V		R7003	NRSA02J-103X	MG RESISTOR	10K 5% 1/10W	
C7003	NCS21HJ-390X	C CAPACITOR	39PF 5% 50V		R7004	NRSA02J-103X	MG RESISTOR	10K 5% 1/10W	
C7004	NCS21HJ-360X	C CAPACITOR	36PF 5% 50V		R7005	NRSA02J-102X	MG RESISTOR	1.0K 5% 1/10W	
C7005	NCS21HJ-220X	C CAPACITOR	22PF 5% 50V		R7101	NRSA02J-222X	MG RESISTOR	2.2K 5% 1/10W	
C7006	NCS21HJ-200X	C CAPACITOR	20PF 5% 50V		R7102	NRSA02J-222X	MG RESISTOR	2.2K 5% 1/10W	
C7007	NCS21HJ-102X	C CAPACITOR	1000PF 10% 50V		R7103	NRSA02J-222X	MG RESISTOR	2.2K 5% 1/10W	
C7008	NCS21HJ-102X	C CAPACITOR	1000PF 10% 50V		R7104	NRSA02J-222X	MG RESISTOR	2.2K 5% 1/10W	
C7011	GER41HM-107	E CAPACITOR	100MF 20% 10V		R7105	NRSA02J-102X	MG RESISTOR	1.0K 5% 1/10W	
C7012	NCR21HK-103X	C CAPACITOR	-0.10MF 10% 50V		R7106	NRSA02J-102X	MG RESISTOR	1.0K 5% 1/10W	
C7013	NCF21H2-104X	C CAPACITOR	-1.0MF +80%-20%		R7107	NRSA02J-102X	MG RESISTOR	1.0K 5% 1/10W	
C7108	NCS21HJ-101X	C CAPACITOR	100PF 5% 50V		R7108	NRSA02J-102X	MG RESISTOR	1.0K 5% 1/10W	
C7109	NCS21HJ-101X	C CAPACITOR	100PF 5% 50V		R7109	NRSA02J-102X	MG RESISTOR	1.0K 5% 1/10W	
C7122	NCR21HK-103X	C CAPACITOR	-0.10MF 10% 50V		R7110	NRSA02J-102X	MG RESISTOR	1.0K 5% 1/10W	
C7123	NCR21HK-103X	C CAPACITOR	-0.10MF 10% 50V		R7111	NRSA02J-102X	MG RESISTOR	1.0K 5% 1/10W	
C7125	NCS21HJ-101X	C CAPACITOR	100PF 5% 50V		R7112	NRSA02J-102X	MG RESISTOR	1.0K 5% 1/10W	
C7126	NCS21HJ-101X	C CAPACITOR	100PF 5% 50V		R7113	NRSA02J-102X	MG RESISTOR	1.0K 5% 1/10W	
C7201	GER61CH-107Z	E-CAPA. I.M	100MF 20% 16V		R7114	NRSA02J-222X	MG RESISTOR	2.2K 5% 1/10W	
C7202	GER41HJ-104	M CAPACITOR	1.0MF 5% 50V		R7115	NRSA02J-222X	MG RESISTOR	2.2K 5% 1/10W	
C7311	GER41HM-475	E CAPACITOR	4.7MF 20% 50V		R7116	NRSA02J-222X	MG RESISTOR	2.2K 5% 1/10W	
C7312	GER41HM-225	E CAPACITOR	2.2MF 20% 50V		R7117	NRSA02J-222X	MG RESISTOR	2.2K 5% 1/10W	
C7321	GE20229-479Z	EDL-CAPACITOR	47000MF		R7118	NRSA02J-222X	MG RESISTOR	2.2K 5% 1/10W	
C7801	GER61HM-335Z	E CAPACITOR	3.3MF 20% 50V		R7119	NRSA02J-222X	MG RESISTOR	2.2K 5% 1/10W	
C7802	GER41HM-225	E CAPACITOR	2.2MF 20% 50V		R7120	NRSA02J-222X	MG RESISTOR	2.2K 5% 1/10W	
C7803	GER41HM-105	E CAPACITOR	1.0MF 20% 50V		R7121	NRSA02J-222X	MG RESISTOR	2.2K 5% 1/10W	
C7804	GER41HM-225	E CAPACITOR	2.2MF 20% 50V		R7122	NRSA02J-222X	MG RESISTOR	2.2K 5% 1/10W	
C7805	GER41HM-105	E CAPACITOR	1.0MF 20% 50V		R7123	NRSA02J-222X	MG RESISTOR	2.2K 5% 1/10W	
C7811	NCR21HK-103X	C CAPACITOR	-0.10MF 10% 50V		R7124	NRSA02J-222X	MG RESISTOR	2.2K 5% 1/10W	
D7001	1S5133-T2	DIODE	CLOCK		R7125	NRSA02J-103X	MG RESISTOR	10K 5% 1/10W	
D7201	1S5133-T2	DIODE	US6V2		R7126	NRSA02J-103X	MG RESISTOR	10K 5% 1/10W	
D7202	1S5133-T2	DIODE	US5V		R7128	NRSA02J-103X	MG RESISTOR	10K 5% 1/10W	
D7203	1S5133-T2	DIODE	LC05V		R7129	NRSA02J-222X	MG RESISTOR	2.2K 5% 1/10W	
D7204	1S5133-T2	DIODE	BU5V		R7130	NRSA02J-222X	MG RESISTOR	2.2K 5% 1/10W	
D7205	MTJ28-2B-T2	DIODE	US6V2		R7131	NRSA02J-222X	MG RESISTOR	2.2K 5% 1/10W	
D7301	MTJ25-1C-T2	ZENER DIODE	BUCKUP		R7132	NRSA02J-222X	MG RESISTOR	2.2K 5% 1/10W	
D7311	1S5133-T2	DIODE	RESET		R7133	NRSA02J-222X	MG RESISTOR	2.2K 5% 1/10W	
D7321	1S5133-T2	DIODE	BU5V		R7134	NRSA02J-222X	MG RESISTOR	2.2K 5% 1/10W	
IC701	UPD78056GC-A29	IC	SYSTEM MICON		R7135	NRSA02J-103X	MG RESISTOR	10K 5% 1/10W	
IC702	KIA78S06P-T	IC	US6V REG		R7136	NRSA02J-222X	MG RESISTOR	2.2K 5% 1/10W	
K7201	QGR0601-001Z	F-BEADS I.M	ICVSS		R7137	NRSA02J-153X	MG RESISTOR	15K 5% 1/10W	
K7202	QGR0601-001Z	F-BEADS I.M	AVSS		R7138	NRSA02J-222X	MG RESISTOR	2.2K 5% 1/10W	
K7203	QGR0601-001Z	F-BEADS I.M	FREY		R7139	NRSA02J-222X	MG RESISTOR	2.2K 5% 1/10W	
L7201	QGL01BK-100Z	INDUCTOR	VDD		R7140	NRSA02J-102X	MG RESISTOR	1.0K 5% 1/10W	
L7202	QGL01BK-100Z	INDUCTOR	AVDD		R7141	NRSA02J-473X	MG RESISTOR	47K 5% 1/10W	
PP701	QZM0007-001	POST PIN			R7142	NRSA02J-473X	MG RESISTOR	47K 5% 1/10W	
PP702	QZM0007-001	POST PIN			R7143	NRSA02J-333X	MG RESISTOR	33K 5% 1/10W	
G7001	25C266B/0/-T	TRANSISTOR TAPE	CLOCK SHIFT		R7144	NRSA02J-222X	MG RESISTOR	2.2K 5% 1/10W	

CD Board (UX-V5/UX-V3R)

BLOCK NO. 03				BLOCK NO. 04			
REF.	PARTS NO.	PARTS NAME	REMARKS	REF.	PARTS NO.	PARTS NAME	REMARKS
R7145	NRSA02J-222X	MG RESISTOR	2.2K 5% 1/10W	CN601	GGF1201F3-13	CONNECTOR	V3/V5/V97/A1/A5
R7146	NRSA02J-222X	MG RESISTOR	2.2K 5% 1/10W	CN602	GGF1201F3-10	CONNECTOR	V3/V5/V97/A1/A5
R7147	NRSA02J-222X	MG RESISTOR	2.2K 5% 1/10W	CN603	GGF1004F4-18	FPC CONNECTOR	
R7148	NRSA02J-222X	MG RESISTOR	2.2K 5% 1/10W	CN604	GGA2501C1-03	3P CONNECTOR	
R7150	NRSA02J-102X	MG RESISTOR	1.0K 5% 1/10W	CN605	GGA1501C3-02	W TO B CONNE	RED
R7151	NRSA02J-222X	MG RESISTOR	2.2K 5% 1/10W	CN606	GGA1501C4-02	W TO B CONNE	BLUE
R7152	NRSA02J-222X	MG RESISTOR	2.2K 5% 1/10W	CN607	VMC0199-902V	CONNECTOR	WHITE
R7153	NRSA02J-222X	MG RESISTOR	2.2K 5% 1/10W	C6001	GER40JM-107	E CAPACITOR	100MF 20X 6.3V
R7154	NRSA02J-222X	MG RESISTOR	2.2K 5% 1/10W	C6002	GER41CM-106	E CAPACITOR	10MF 20X 16V
R7155	NRSA02J-222X	MG RESISTOR	2.2K 5% 1/10W	C6003	NGC21HJ-3R5X	C CAPACITOR	
R7156	NRSA02J-222X	MG RESISTOR	2.2K 5% 1/10W	C6005	NCB21HK-331X	C CAPACITOR	330PF 5X 50V
R7301	NRSA02J-473X	MG RESISTOR	47K 5% 1/10W	C6006	NCB21HK-102X	C CAPACITOR	1000PF 10X 50V
R7302	NRSA02J-333X	MG RESISTOR	33K 5% 1/10W	C6007	NCB21HK-102X	C CAPACITOR	1000PF 10X 50V
R7303	NRSA02J-104X	MG RESISTOR	100K 5% 1/10W	C6008	GER41HM-105	E CAPACITOR	1.0MF 20X 50V
R7304	NRSA02J-102X	MG RESISTOR	1.0K 5% 1/10W	C6009	NCB21HJ-101X	C CAPACITOR	100PF 5X 50V
R7311	NRSA02J-103X	MG RESISTOR	10K 5% 1/10W	C6010	NCB21HK-273X	C CAPACITOR	0.27MF 10X 50V
R7312	NRSA02J-103X	MG RESISTOR	10K 5% 1/10W	C6011	NCB21HK-273X	C CAPACITOR	2200PF 10X 50V
R7313	NRSA02J-103X	MG RESISTOR	10K 5% 1/10W	C6012	NCB21HK-103X	C CAPACITOR	0.10MF 10X 50V
R7314	NRSA02J-102X	MG RESISTOR	1.0K 5% 1/10W	C6014	NCB21EK-104X	C CAPACITOR	0.10MF 10X 25V
R7315	NRSA02J-103X	MG RESISTOR	10K 5% 1/10W	C6015	NCB21HK-223X	C CAPACITOR	0.22MF 10X 50V
R7321	NRSA02J-331X	MG RESISTOR	330 5% 1/10W	C6016	NCB21HK-223X	C CAPACITOR	0.22MF 10X 50V
R7322	NRSA02J-103X	MG RESISTOR	10K 5% 1/10W	C6017	NCB21HK-222X	C CAPACITOR	0.22MF 10X 50V
R7401	NRSA02J-103X	MG RESISTOR	10K 5% 1/10W	C6018	NCB21HK-222X	C CAPACITOR	2200PF 10X 50V
R7402	NRSA02J-103X	MG RESISTOR	10K 5% 1/10W	C6019	NCB21HJ-271X	C CAPACITOR	270PF 5X 50V
R7403	NRSA02J-103X	MG RESISTOR	10K 5% 1/10W	C6020	NCB21HJ-181X	C CAPACITOR	180PF 5X 50V
R7404	NRSA02J-103X	MG RESISTOR	10K 5% 1/10W	C6021	NCB21HJ-821X	C CAPACITOR	850PF 5X 50V
R7406	NRSA02J-103X	MG RESISTOR	10K 5% 1/10W	C6022	GER60JM-476Z	E.CAPA. 1.M	4.7MF 20X 6.3V
R7407	NRSA02J-103X	MG RESISTOR	10K 5% 1/10W	C6023	NCB21EK-104X	C CAPACITOR	0.10MF 10X 25V
R7408	NRSA02J-273X	MG RESISTOR	UB/UF/UT	C6028	NCB21EK-473X	C CAPACITOR	0.47MF 10X 25V
R7408	NRSA02J-273X	MG RESISTOR	UB/UF/UT	C6029	GER40JM-107	E CAPACITOR	100MF 20X 6.3V
R7409	NRSA02J-562X	MG RESISTOR	56K 5% 1/10W	C6031	GER41AM-227	E.CAPA. 1.M	220MF 20X 10V
R7409	NRSA02J-273X	MG RESISTOR	UB/UF/UT	C6032	GER40JM-107	E CAPACITOR	100MF 20X 6.3V
R7410	NRSA02J-103X	MG RESISTOR	10K 5% 1/10W	C6051	NDG21HJ-120X	C CAPACITOR	
R7411	NRSA02J-823X	MG RESISTOR	82K 5% 1/10W	C6052	NDG21HJ-150X	C CAPACITOR	
R7801	NRSA02J-114X	RES. C-M	110K 5% 1/10W	C6053	NCB21HK-223X	C CAPACITOR	0.22MF 10X 50V
R7802	NRSA02J-114X	RES. C-M	110K 5% 1/10W	C6058	NCB21EK-473X	C CAPACITOR	0.47MF 10X 25V
R7803	NRSA02J-683X	MG RESISTOR	68K 5% 1/10W	C6058	NCB21HJ-6R0X	C.CAPA. C.M	6.0PF 5X 50V
R7804	NRSA02J-105X	MG RESISTOR	1.0M 5% 1/10W	C6061	NCB21HJ-471X	C CAPACITOR	4.70PF 5X 50V
R7805	NRSA02J-683X	MG RESISTOR	68K 5% 1/10W	C6062	NCB21HK-223X	C CAPACITOR	0.22MF 10X 50V
R7811	NRSA02J-823X	MG RESISTOR	82K 5% 1/10W	C6063	NCB21HK-223X	C CAPACITOR	0.22MF 10X 50V
R7812	NRSA02J-394X	RES. C-M	390K 5% 1/10W	C6064	NCB21HK-223X	C CAPACITOR	0.22MF 10X 50V
R7813	NRSA02J-104X	MG RESISTOR	100K 5% 1/10W	C6065	NCB21CK-334X	C.CAPA. C-M	0.33MF 10X 16V
R7821	NRSA02J-103X	MG RESISTOR	10K 5% 1/10W	C6071	NCB21HK-222X	C CAPACITOR	2200PF 10X 50V
R7822	NRSA02J-473X	MG RESISTOR	47K 5% 1/10W	C6072	NCB21HK-222X	C CAPACITOR	2200PF 10X 50V
R7823	NRSA02J-122X	MG RESISTOR	V5	C6073	GER41AM-227	E.CAPA. 1.M	220MF 20X 10V
R7824	NRSA02J-122X	MG RESISTOR	V3	C6075	NCB21HK-102X	C CAPACITOR	1000PF 10X 50V
X7001	GA0401-001	CRYSTAL	CLOCK(36.678KHZ	C6076	NCB21HK-102X	C CAPACITOR	1000PF 10X 50V
X7002	GA0401-001	CERA LOCK	MAIN CK(4.19MHZ	C6077	NCB21HK-223X	C CAPACITOR	0.22MF 10X 50V
				C6081	GER41AM-227	E.CAPA. 1.M	220MF 20X 10V
				C6083	NCB21HK-223X	C CAPACITOR	0.22MF 10X 50V
				C6095	NCB21EK-104X	C CAPACITOR	0.10MF 10X 25V
				C6096	NCB21HK-102X	C CAPACITOR	1000PF 10X 50V
				C6097	NCB21HK-102X	C CAPACITOR	1000PF 10X 50V
				C6098	NCB21HK-102X	C CAPACITOR	1000PF 10X 50V

BLOCK NO. 04

BLOCK NO. 04

REF.	PARTS NO.	PARTS NAME	REMARKS	SUFFIX
R6099	NCB21HK-102X	C CAPACITOR	1000PF 10X 50V	
R6101	NCB21HK-223X	C CAPACITOR	0.22MF 10X 50V	
R6154	NCB21HJ-151X	C CAPACITOR	150PF 5X 50V	
R6156	NCB21HJ-151X	C CAPACITOR	150PF 5X 50V	
R6157	NCB21HJ-151X	C CAPACITOR	150PF 5X 50V	
R6158	NCB21HJ-151X	C CAPACITOR	150PF 5X 50V	
D6061	1SS355-X	DIODE C.M		
D6062	1SS355-X	DIODE C.M		
D6063	1SS355-X	DIODE C.M		
IC601	AN8806SB-W	IC C.M		
IC602	BA2897FP-W	IC		
IC603	MN35510	IC		
Q6001	QRO779-0012	INDUCTOR		
Q6001	2SA1037AK/R/-X	CHIP TR-C.M		
Q6031	2SA952/LK/-I	TRANSISTOR		
R6001	NRS02J-123X	RES C.M	12X 5X 1/10W	
R6002	NRS02J-223X	MG RESISTOR	2.2M 5X 1/10W	
R6003	NRS02J-102X	MG RESISTOR	1.0K 5X 1/10W	
R6005	NRS02J-124X	MG RESISTOR	1.20K 5X 1/10W	
R6006	NRS02J-473X	MG RESISTOR	47K 5X 1/10W	
R6007	NRS02J-273X	MG RESISTOR	27K 5X 1/10W	
R6009	NRS02J-393X	MG RESISTOR	39K 5X 1/10W	
R6010	NRS02J-104X	MG RESISTOR	100K 5X 1/10W	
R6012	NRS02J-103X	MG RESISTOR	10K 5X 1/10W	
R6013	NRS02J-121X	MG RESISTOR	120 5X 1/10W	
R6014	NRS02J-100X	MG RESISTOR	10 5X 1/10W	
R6015	NRS02J-120X	MG RESISTOR	12 5X 1/10W	
R6016	NRS02J-910X	RES. C.M	91 5X 1/10W	
R6021	NRS02J-101X	MG RESISTOR	100 5X 1/10W	
R6022	NRS02J-101X	MG RESISTOR	100 5X 1/10W	
R6023	NRS02J-101X	MG RESISTOR	100 5X 1/10W	
R6024	NRS02J-104X	MG RESISTOR	100K 5X 1/10W	
R6025	NRS02J-104X	MG RESISTOR	100K 5X 1/10W	
R6026	NRS02J-393X	MG RESISTOR	39K 5X 1/10W	
R6027	NRS02J-393X	MG RESISTOR	39K 5X 1/10W	
R6028	NRS02J-393X	MG RESISTOR	39K 5X 1/10W	
R6029	NRS02J-393X	MG RESISTOR	39K 5X 1/10W	
R6031	NRS02J-331X	MG RESISTOR	330 5X 1/10W	
R6032	NRS02J-101X	MG RESISTOR	100 5X 1/10W	
R6041	NRS02J-273X	MG RESISTOR	27K 5X 1/10W	
R6042	NRS02J-183X	MG RESISTOR	18K 5X 1/10W	
R6043	NRS02J-272X	MG RESISTOR	2.7K 5X 1/10W	
R6044	NRS02J-273X	MG RESISTOR	27K 5X 1/10W	
R6045	NRS02J-393X	MG RESISTOR	39K 5X 1/10W	
R6046	NRS02J-332X	MG RESISTOR	3.3K 5X 1/10W	
R6047	NRS02J-332X	MG RESISTOR	3.3K 5X 1/10W	
R6051	NRS02J-102X	MG RESISTOR	1.0K 5X 1/10W	
R6052	NRS02J-102X	MG RESISTOR	1.0K 5X 1/10W	
R6053	NRS02J-102X	MG RESISTOR	1.0K 5X 1/10W	
R6054	NRS02J-102X	MG RESISTOR	1.0K 5X 1/10W	
R6055	NRS02J-102X	MG RESISTOR	1.0K 5X 1/10W	
R6056	NRS02J-OROX	MG RESISTOR	5X 1/10W	
R6057	NRS02J-OROX	MG RESISTOR	5X 1/10W	
R6058	NRS02J-OROX	MG RESISTOR	5X 1/10W	
R6059	NRS02J-471X	MG RESISTOR	470 5X 1/10W	

BLOCK NO. 04

BLOCK NO. 04

REF.	PARTS NO.	PARTS NAME	REMARKS	SUFFIX
R6060	NRS02J-471X	MG RESISTOR	470 5X 1/10W	
R6061	NRS02J-104X	MG RESISTOR	100K 5X 1/10W	
R6063	NRS02J-124X	MG RESISTOR	120K 5X 1/10W	
R6064	NRS02J-681X	MG RESISTOR	680 5X 1/10W	
R6066	NRS02J-220X	MG RESISTOR	22 5X 1/10W	
R6067	NRS02J-220X	MG RESISTOR	22 5X 1/10W	
R6068	NRS02J-220X	MG RESISTOR	22 5X 1/10W	
R6069	NRS02J-155X	MG RESISTOR	1.5M 5X 1/10W	
R6071	NRS02J-102X	MG RESISTOR	1.0K 5X 1/10W	
R6072	NRS02J-102X	MG RESISTOR	1.0K 5X 1/10W	
R6076	NRS02J-OROX	MG RESISTOR	5X 1/10W	
R6080	NRS02J-OROX	MG RESISTOR	5X 1/10W	
R6121	NRS02J-101X	MG RESISTOR	100 5X 1/10W	
W.805	6JL006-021302	SIN CR B-B WIRE	-W815 LED-LCD	
W.814	GJK018-031203	SIN CR C-B WIRE	DOOR SW WIRE	
W3004	GJK017-052600	SIN CR C-B WIRE	H.P WIRE	
W3351	GJPO03-042401	SHI CR C-B WIRE	MAIN-FUNC SHIEL	
W5501	GJK018-020802	SIN CR C-B WIRE	TOP KEY WIRE	
X6051	GAX0413-0012	CRYSTAL		

■ Main Board (FS-V5)

REF.	PARTS NO.	PARTS NAME	REMARKS	SUFFIX
B2053	NRS181J-OROX	MG RESISTOR	MIC	
CN195	QGB2016J1-15	CONNECTOR		
CN196	VMC0289-S12	CONNECTOR		
CN197	VMZ0076-002	W TO B CONNE		
CN199	QGA7901C1-02	W TO B CONNE		
CN301	QGB2016K1-15	B TO B CONNE	POWER PWB	
CN304	QGA2501C3-03Z	CONNECTOR	HEADPHONE	
CN308	EMV5111-002	2P CONNECTOR	CD DOOR	
CN311	QNB0092-001	SPK TERMINAL	SPEAKER	
CN317	QGB1214K1-12S	CONNECTOR	MICOM TOP	
CN322	QGB1214K1-12S	CONNECTOR	MICOM BOT	
C1901	QFV41HJ-104	TF CAPACITOR	.10MF 5X 50V	
C1902	QFV41HJ-104	TF CAPACITOR	.10MF 5X 50V	
C1903	QFV41HJ-104	TF CAPACITOR	.10MF 5X 50V	
C1904	QFV41HJ-104	TF CAPACITOR	.10MF 5X 50V	
C1910	QDYB1CM-103Y	ABCAPACITOR		
C1911	QTE1C03-106Z	E CAPACITOR		
C1912	QTE1E06-476Z	E CAPACITOR		
C1916	QFV41HJ-104	TF CAPACITOR	.10MF 5X 50V	
C1917	QETC1CM-106Z-JB	E CAPACITOR	10MF 20X 16V	
C3001	QETM1EM-82B	E CAPACITOR	8200PF 20X 25V	
C3002	QFV41HJ-104	TF CAPACITOR	10MF 5X 50V	
C3003	QETC1EM-107Z-JB	E CAPACITOR	100MF 20X 25V	
C3004	QTE1A2B-337Z	E-CAPAC. I.M		
C3005	QETC1EM-336Z-JB	E CAPACITOR	33MF 20X 25V	
C3006	QETC1HM-225Z-JB	E CAPACITOR	2.2MF 20X 50V	
C3007	QETC1EM-106Z-JB	E CAPACITOR	10MF 20X 25V	
C3101	QTE1C03-106Z	E CAPACITOR		
C3103	QCB1HK-331Y	C CAPACITOR	330PF 10X 50V	
C3104	QDX31EM-104Z	C CAPACITOR		
C3105	QDX31EM-104Z	C CAPACITOR		
C3121	QFN41HJ-823	M CAPACITOR	.082MF 5X 50V	
C3122	QFN41HJ-823	M CAPACITOR	.082MF 5X 50V	
C3123	QTE1A03-226Z	E CAPACITOR		
C3126	QFV1HJ-574Z	TF CAPACITOR	.27MF 5X 50V	
C3152	QFN51HJ-563Z	M.CAPA. I.M	.056MF 5X 50V	
C3153	QFN51HJ-563Z	M.CAPA. I.M	.056MF 5X 50V	
C3154	QFN41HJ-47Z	M CAPACITOR	4.700PF 5X 50V	
C3157	QFN41HJ-123	M CAPACITOR	.012MF 5X 50V	
C3158	QTE1C03-106Z	E CAPACITOR		
C3201	QTE1C03-106Z	E CAPACITOR		
C3203	QCB1HK-331Y	C CAPACITOR	330PF 10X 50V	
C3204	QDX31EM-104Z	C CAPACITOR		
C3205	QDX31EM-104Z	C CAPACITOR		
C3221	QFN41HJ-823	M CAPACITOR	.082MF 5X 50V	
C3223	QFN41HJ-823	M CAPACITOR	.082MF 5X 50V	
C3225	QTEA03-226Z	E CAPACITOR		
C3226	QFV1HJ-274Z	TF CAPACITOR	.27MF 5X 50V	
C3252	QFN31HJ-563Z	M.CAPA. I.M	.056MF 5X 50V	
C3253	QFN31HJ-563Z	M.CAPA. I.M	.056MF 5X 50V	
C3254	QFN41HJ-47Z	M CAPACITOR	4.700PF 5X 50V	
C3257	QFN41HJ-123	M CAPACITOR	.012MF 5X 50V	
C3258	QTE1C03-106Z	E CAPACITOR		
C3301	QETC1EM-106Z-JB	E CAPACITOR	10MF 20X 25V	
C3321	QETC1EM-476Z-JB	E CAPACITOR	4.7MF 20X 25V	

REF.	PARTS NO.	PARTS NAME	REMARKS	SUFFIX
C3322	QETE03-226Z	E CAPACITOR		
C3331	QETC1HM-105Z-JB	E CAPACITOR	1.0MF 20X 50V	
C3332	QETC1HM-105Z-JB	E CAPACITOR	1.0MF 20X 50V	
C3333	QFV1HJ-563Z	CAPACITOR	.056MF 5X 50V	
C3334	QFV1HJ-563Z	CAPACITOR	.056MF 5X 50V	
C3335	QETC1HM-105Z-JB	E CAPACITOR	1.0MF 20X 50V	
C3336	QETC1EM-106Z-JB	E CAPACITOR	10MF 20X 25V	
C3351	QETC1EM-107Z-JB	E CAPACITOR	100MF 20X 25V	
C3353	QETC1HM-474Z-JB	E CAPACITOR	.47MF 20X 50V	
C3354	QETC1HM-474Z-JB	E CAPACITOR	.47MF 20X 50V	
C3355	QETC1HM-474Z-JB	E CAPACITOR	.47MF 20X 50V	
C3356	QETC1EM-106Z-JB	E-CAPA. I.M	10MF 20X 25V	
C3357	QETC1EM-106Z-JB	E CAPACITOR	10MF 20X 25V	
C3801	QER61EM-106Z	E-CAPA. I.M	4.7MF 20X 16V	
C3802	QER41CM-476	E-CAPACITOR		
C3803	QFV41HJ-103	TF CAPACITOR	.010MF 5X 50V	
C3804	QER41CM-476	E CAPACITOR	4.7MF 20X 16V	
C3805	QEZ0205-155Z	ML C CAP I/M	1.5MF	
C3901	QETC1EM-476Z-JB	E CAPACITOR	4.7MF 20X 25V	
C3902	QDYB1CM-103Y	ABCAPACITOR		
C3903	QCB1HK-221Y	C CAPACITOR	220PF 10X 50V	
C3904	QCB1HK-221Y	C CAPACITOR	220PF 10X 50V	
C3931	QETC1EM-107Z-JB	E CAPACITOR	100MF 20X 25V	
C3951	QER61EM-106Z	E-CAPA. I.M	10MF 20X 25V	
C3952	QER61EM-226Z	E-CAPA. I.M	22MF 20X 25V	
C3999	QCB1HK-151Y	C CAPACITOR	150PF 10X 50V	
D1901	D5SBA20-S1	SI DIODE	ANALOG	
D1908	MTZJ4.3B-T2	ZENER DIODE	CD4V	
D1913	MTZJ4.8B-T2	DIODE	AD4V	
D3321	MTZJ5.1A-T2	ZENER DIODE	US5V	
D3331	1SS133-T2	DIODE		
D3332	1SS133-T2	DIODE		
D3333	1SS133-T2	DIODE		
D3334	1SS133-T2	DIODE		
D3801	DSK10C-T1	DIODE		
D3901	1SS133-T2	DIODE		
D3902	MTZJ10A-T2	ZENER DIODE		
D3903	MTZJ5.6C-T2	ZENER DIODE		
D3931	MTZJ11A-T2	Z.DIODE I.M		
D3932	1SS133-T2	DIODE		
D3951	MTZJ6.8A-T2	ZENER DIODE		
D3952	MTZJ10A-T2	ZENER DIODE		
EP191	QNZ0136-001Z	EARTH PLATE		
EP301	QNZ0136-001Z	EARTH PLATE		
IC191	UPC78L05J-T	I.C	USSV	
IC301	LA4705NA	IC	POWER AMP	
IC302	NJM4580L-D	IC	AMB AMP	
IC305	BH3852S	IC	E VOL	
IC308	TAB409S	IC		
J1901	QMCB250-V02	AC SOCKET		
K3801	QGR0779-001Z	INDUCTOR		
L3801	QQL25CK-221Z	INDUCTOR		
Q1901	2SA1359/OY/	TRANSISTOR	CD6V	
Q1902	2SC2785/FE/-T	TRANSISTOR	CD6V	
Q3101	2SD2144S/VW/-T	TRANSISTOR I/M		

BLOCK NO. 05000000

REF.	PARTS NO.	PARTS NAME	REMARKS	SUFFIX
A R3322	GRE141J-182Y	C RESISTOR	1.8K 5X 1/4W	
R3331	GRE141J-472Y	C RESISTOR	4.7K 5X 1/4W	
R3332	GRE141J-472Y	C RESISTOR	4.7K 5X 1/4W	
R3333	GRE141J-154Y	C RESISTOR	150K 5X 1/4W	
R3334	GRE141J-124Y	C RESISTOR	120K 5X 1/4W	
R3335	GRE141J-223Y	C RESISTOR	22K 5X 1/4W	
R3336	GRE141J-513Y	C RESISTOR	51K 5X 1/4W	
R3351	GRE141J-151Y	C RESISTOR	150 5X 1/4W	
R3352	GRE141J-151Y	C RESISTOR	150 5X 1/4W	
R3353	GRE141J-124Y	C RESISTOR	120K 5X 1/4W	
R3354	GRE141J-154Y	C RESISTOR	150K 5X 1/4W	
R3355	GRE141J-124Y	C RESISTOR	120K 5X 1/4W	
R3801	GR1146J-151X	C RESISTOR	150 5X 1/4W	
R3802	GRE141J-153Y	C RESISTOR	15K 5X 1/4W	
R3803	GRE141J-473Y	C RESISTOR	47K 5X 1/4W	
R3804	GRE141J-183Y	C RESISTOR	18K 5X 1/4W	
R3805	GRE141J-100Y	C RESISTOR	10 5X 1/4W	
R3806	GRE141J-100Y	C RESISTOR	10 5X 1/4W	
A R3901	GRE141J-182Y	C.RES I.M	1.2 5X 1/4W	
A R3902	GRE141J-182Y	C.RES I.M	1.2 5X 1/4W	
A R3903	GRE141J-182Y	C.RES I.M	1.2 5X 1/4W	
A R3904	GRE141J-182Y	C.RES I.M	1.2 5X 1/4W	
A R3905	GRE141J-471Y	C RESISTOR	470 5X 1/4W	
R3906	GRE141J-122Y	C RESISTOR	1.2K 5X 1/4W	
R3907	GRE141J-752Y	C RESISTOR	7.5K 5X 1/4W	
R3908	GRE141J-152Y	C RESISTOR	1.5K 5X 1/4W	
R3909	GRE141J-102Y	C RESISTOR	1.0K 5X 1/4W	
R3910	GRE141J-472Y	C RESISTOR	4.7K 5X 1/4W	
R3911	GRE141J-471Y	C RESISTOR	4.70 5X 1/4W	
R3912	GRE141J-681Y	C RESISTOR	680 5X 1/4W	
R3913	GRE141J-681Y	C RESISTOR	680 5X 1/4W	
R3914	GRE141J-681Y	C RESISTOR	680 5X 1/4W	
R3915	GRE141J-681Y	C RESISTOR	680 5X 1/4W	
R3916	GRE141J-681Y	C RESISTOR	680 5X 1/4W	
R3917	GRE141J-682Y	C RESISTOR	6.8K 5X 1/4W	
R3918	GRE141J-472Y	C RESISTOR	4.7K 5X 1/4W	
R3919	GRE141J-223Y	C RESISTOR	2.2K 5X 1/4W	
R3920	GRE141J-223Y	C RESISTOR	2.2K 5X 1/4W	
R3921	GRE141J-103Y	C RESISTOR	10K 5X 1/4W	
R3931	GRE141J-561Y	C RESISTOR	560 5X 1/4W	
A R3951	GR29006-688X	F.RES. I.M	6-8 1/0W	
R3952	GRE141J-102Y	C RESISTOR	1.0K 5X 1/4W	
R3953	GRE141J-103Y	C RESISTOR	10K 5X 1/4W	
R3954	GRE141J-103Y	C RESISTOR	10K 5X 1/4W	
R5501	GRE141J-102Y	C RESISTOR	1.0K 5X 1/4W	
R5502	GRE141J-102Y	C RESISTOR	1.0K 5X 1/4W	
R5503	GRE141J-122Y	C RESISTOR	1.2K 5X 1/4W	
R5504	GRE141J-152Y	C RESISTOR	1.5K 5X 1/4W	
R5505	GRE141J-222Y	C RESISTOR	2.2K 5X 1/4W	
R5506	GRE141J-272Y	C RESISTOR	2.7K 5X 1/4W	
R5507	GRE141J-592Y	C RESISTOR	5.9K 5X 1/4W	
R5508	GRE141J-562Y	C RESISTOR	5.6K 5X 1/4W	
R9701	GR29006-688X	F.RES. I.M	6-8 1/0W	
S5501	GSW0698-001Z	TACT SWITCH	REV. MODE	
S5502	GSW0698-001Z	TACT SWITCH	REV. MODE	

BLOCK NO. 05000000

REF.	PARTS NO.	PARTS NAME	REMARKS	SUFFIX
A Q3131	2SC2785/FE/-T	TRANSISTOR		
Q3201	2SD2144S/VW/-T	TRANSISTOR I/M		
Q3231	2SC2785/FE/-T	TRANSISTOR		
Q3301	KRA101M-T	TR I/M		
Q3801	2SC2785/FE/-T	TRANSISTOR		
A Q3901	2SB941/7	TRANSISTOR		
Q3902	2SA1175/HFE/-T	TRANSISTOR		
Q3903	2SC2785/FE/-T	TRANSISTOR		
Q3904	KRC114M-T	TR I.M		
Q3905	DTA144TSA-T	D. TRANSISTOR		
Q3906	2SC2785/FE/-T	TRANSISTOR		
A Q3931	2SC2001/LK/-T	TRANSISTOR		
A Q3951	2SC562/BC/-T	TRANSISTOR		
Q3952	2SC2785/FE/-T	TRANSISTOR		
A R1901	GR29037-335	COMP RESISTOR	3.3M 1/0W	
R1902	GRE141J-181Y	C RESISTOR	180 5X 1/4W	
R1903	GRE141J-103Y	C RESISTOR	10K 5X 1/4W	
R1904	GRE141J-103Y	C RESISTOR	10K 5X 1/4W	
A R1922	GR29006-688X	F.RES. I.M	6-8 1/0W	
A R3001	GRE141J-103Y	C RESISTOR	10K 5X 1/4W	
R3102	GRE141J-472Y	C RESISTOR	4.7K 5X 1/4W	
A R3104	GRE141J-2R2Y	C RESISTOR	2.2 5X 1/4W	
A R3105	GRE141J-2R2Y	C RESISTOR	2.2 5X 1/4W	
R3122	GRE141J-224Y	C RESISTOR	220K 5X 1/4W	
R3123	GRE141J-202Y	C RESISTOR	2.0K 5X 1/4W	
R3124	GRE141J-222Y	C RESISTOR	2.2K 5X 1/4W	
R3125	GRE141J-123Y	C RESISTOR	1.2K 5X 1/4W	
R3127	GRE141J-153Y	C RESISTOR	1.5K 5X 1/4W	
R3128	GRE141J-472Y	C RESISTOR	4.7K 5X 1/4W	
R3129	GRE141J-562Y	C RESISTOR	5.6K 5X 1/4W	
R3131	GRE141J-223Y	C RESISTOR	22K 5X 1/4W	
R3132	GRE141J-223Y	C RESISTOR	22K 5X 1/4W	
R3133	GRE141J-103Y	C RESISTOR	10K 5X 1/4W	
R3152	GRE141J-622Y	C RESISTOR	6.2K 5X 1/4W	
R3153	GRE141J-222Y	C RESISTOR	2.2K 5X 1/4W	
R3155	GRE141J-182Y	C RESISTOR	1.8K 5X 1/4W	
R3156	GRE141J-182Y	C RESISTOR	1.8K 5X 1/4W	
R3202	GRE141J-472Y	C RESISTOR	4.7K 5X 1/4W	
A R3204	GRE141J-2R2Y	C RESISTOR	2.2 5X 1/4W	
A R3205	GRE141J-2R2Y	C RESISTOR	2.2 5X 1/4W	
R3223	GRE141J-223Y	C RESISTOR	22K 5X 1/4W	
R3224	GRE141J-223Y	C RESISTOR	22K 5X 1/4W	
R3225	GRE141J-123Y	C RESISTOR	1.2K 5X 1/4W	
R3227	GRE141J-153Y	C RESISTOR	1.5K 5X 1/4W	
R3228	GRE141J-472Y	C RESISTOR	4.7K 5X 1/4W	
R3229	GRE141J-562Y	C RESISTOR	5.6K 5X 1/4W	
R3231	GRE141J-223Y	C RESISTOR	22K 5X 1/4W	
R3232	GRE141J-223Y	C RESISTOR	22K 5X 1/4W	
R3233	GRE141J-103Y	C RESISTOR	10K 5X 1/4W	
R3252	GRE141J-622Y	C RESISTOR	6.2K 5X 1/4W	
R3253	GRE141J-222Y	C RESISTOR	2.2K 5X 1/4W	
R3255	GRE141J-182Y	C RESISTOR	1.8K 5X 1/4W	
R3256	GRE141J-182Y	C RESISTOR	1.8K 5X 1/4W	
R3321	GRE141J-151Y	C RESISTOR	150 5X 1/4W	

■ Function/Tuner Board (FS-V5)

BLOCK NO. 05		BLOCK NO. 06		
REF.	PARTS NO.	PARTS NAME	REMARKS	SUFFIX
A 1	NCB21HK-223X	C CAPACITOR		
C 2	NCB21HK-102X	C CAPACITOR		
C 3	NCB21EK-473X	C CAPACITOR		
C 4	NCB21EK-103X	C CAPACITOR		
C 5	GEK41CM-106	E CAPACITOR		
C 6	NCB21HK-102X	C CAPACITOR		
C 9	NCB21HK-102X	C CAPACITOR		
C 12	NDU21HJ-100X	C CAPACITOR		
C 13	NCB21EK-473X	C CAPACITOR		
C 14	NCB21HK-103X	C CAPACITOR		
C 21	NCB21EK-473X	C CAPACITOR		
C 30	GEK61CM-476Z-JB	E CAPACITOR		
C 32	NCB21HK-102X	C CAPACITOR		
C 33	GEK61AM-107Z-JB	E CAPACITOR		
C 34	NCB21NJ-150X	C CAPACITOR		
C 35	NCB21HK-102X	C CAPACITOR		
C 36	GEK61CM-106Z-JB	E CAPACITOR		
C 37	NCB21EK-473X	C CAPACITOR		
C 39	NCB21EK-473X	C CAPACITOR		
C 40	NCB21HK-103X	C CAPACITOR		
C 41	GEK61HM-104Z-JB	E CAPACITOR		
C 42	GEK61HM-474Z-JB	E CAPACITOR		
C 44	NCS21HJ-221X	C CAPACITOR		
C 45	GEK61HM-335Z-JB	E CAPACITOR		
C 46	NCB21HK-223X	C CAPACITOR		
C 47	NCB21HK-103X	C CAPACITOR		
C 49	NCB21HK-223X	C CAPACITOR		
C 50	NCB21HK-223X	C CAPACITOR		
C 51	GEK61HM-105Z-JB	E CAPACITOR		
C 52	GEK61HM-105Z-JB	E CAPACITOR		
C 60	GEK61AM-107Z-JB	E CAPACITOR		
C 61	NCS21HJ-120X	C CAPACITOR		
C 62	NCS21HJ-120X	C CAPACITOR		
C 63	NCB21EK-473X	C CAPACITOR		
C 65	NCB21HK-102X	C CAPACITOR		
C 66	NCS21HJ-151X	C CAPACITOR		
C 67	NCS21HJ-101X	C CAPACITOR		
C 68	NCS21HJ-151X	C CAPACITOR		
C 69	GEK61HM-225Z-JB	E CAPACITOR		
C 70	NCB21HK-392X	C CAPACITOR		
C 71	GEK61HM-335Z-JB	E CAPACITOR		
C 72	NCB21HK-102X	C CAPACITOR		
C 91	NCB21HK-103X	C CAPACITOR		
CF 1	GAX0419-001Z	C FILTER		
CF 2	GAX0419-001Z	C FILTER		
CF 3	GAX0418-001Z	C FILTER		
CF 4	GAX0409-001Z	CERA LOCK		
CN 43	GGF1201E-09	CONNECTOR		
CN 44	GGF1201F5-10	CONNECTOR		
CN501	GGAZ001F1-04	4P PLUG ASSY		
CN502	GGF1201C3-10	CONNECTOR		
CN503	VMC02B9-F12	CONNECTOR		
CN504	GGAZ501F1-03	CONNECTOR		
CN506	QGB1214J1-12S	CONNECTOR		
CN507	QGB1214J1-12S	CONNECTOR		

BLOCK NO. 05		BLOCK NO. 06		
REF.	PARTS NO.	PARTS NAME	REMARKS	SUFFIX
A 1	QSW0698-001Z	TACT SWITCH	SLEEP	
S5504	QSW0698-001Z	TACT SWITCH	CLOCK	
S5505	QSW0698-001Z	TACT SWITCH	TIMER	
S5506	QSW0698-001Z	TACT SWITCH	VOL. UP	
S5507	QSW0698-001Z	TACT SWITCH	VOL. DOWN	
S5508	QSW0698-001Z	TACT SWITCH	AHB	
S5509	QSW0698-001Z	TACT SWITCH	FOR F1901	
A 21901	QNG0020-001Z	FUSE CLIP	FOR F1901	
A 21902	QNG0020-001Z	FUSE CLIP	FOR F1902	
A 21903	QNG0020-001Z	FUSE CLIP	FOR F1902	
A 21904	QNG0020-001Z	FUSE CLIP	FOR F1902	

BLOCK NO. 0961111111

REF.	PARTS NO.	PARTS NAME	REMARKS	SUFFIX
08003	1S5133-T2	DIODE		
D8301	LYH156P	LED		
D8302	LYH156P	LED		
D8303	LYH156P	LED		
EP501	GNZ0136-001Z	EARTH PLATE		
IC 1	TA2057N	IC		
IC 2	LC72136N	IC		
IC531	BA15218F-XE	IC		
IC801	RP6938-V4	RM RECEIVER		
J 1	GN80014-001	ANT TERMINAL	AM/FM ANT COAX	
J3004	GN50033-001	JACK		
J5301	GNH0306-001	4PIN JACK ASSY	A5MD 2P	
J5701	GPIF321	OPTICAL JACK	MD 32R	
K3106	QR0779-001Z	INDUCTOR		
K3206	QR0779-001Z	INDUCTOR		
K5301	QR0779-001Z	INDUCTOR		
K5302	QR0779-001Z	INDUCTOR		
K5303	QR0779-001Z	INDUCTOR		
K5307	QR0779-001Z	INDUCTOR		
L 1	QR0796-001	COIL BLOCK	CD AG	
L 4	QGL231K-221V	INDUCTOR	MW RF/OSC	
LF511	QR0590-001	FILTER		
LF521	QR0590-001	FILTER		
L3106	QGL231K-470Y	INDUCTOR		
L3206	QGL231K-470Y	INDUCTOR		
L3301	QGL298J-470Z	INDUCTOR		
PP531	QZM0007-001	POST PIN		
PP532	QZM0007-001	POST PIN		
PP533	QZM0007-001	POST PIN		
Q 1	25C2668/0/-T	TRANSISTOR TAPE		
Q 6	DTA114YKA-X	TRANSISTOR		
Q 7	2SA1037AK/R/-X	CHIP TR.C-M		
Q 8	2SA1037AK/R/-X	CHIP TR.C-M		
Q5101	2SD2114K/VW/-X	CHIP TR.C-M		
Q5102	2SD2114K/VW/-X	CHIP TR.C-M		
Q5103	2SD2114K/VW/-X	CHIP TR.C-M		
Q5104	2SC2412K/R/-X	TRANSISTOR	CT	
Q5106	2SC2412K/R/-X	TRANSISTOR	W/O A5MD	
Q5201	2SD2114K/VW/-X	CHIP TR.C-M		
Q5202	2SD2114K/VW/-X	CHIP TR.C-M		
Q5203	2SC2412K/R/-X	TRANSISTOR	CT	
Q5204	2SC2412K/R/-X	TRANSISTOR	W/O A5MD	
Q5206	2SC2412K/R/-X	TRANSISTOR		
Q5301	DTA143EKA-X	TRANSISTOR		
Q5302	DTA143EKA-X	TRANSISTOR		
Q5303	DTA114EKA-X	TRANSISTOR		
Q5308	DTA114EKA-X	DIGITAL-TR		
Q5901	2SA1037AK/R/-X	CHIP TR.C-M		
Q5902	2SC2412K/R/-X	TRANSISTOR		
Q5903	2SD468/BC/-T	TRANSISTOR		
Q8001	DTC114TKA-X	TRANSISTOR		
R 1	NRSA02J-102X	MG RESISTOR	1.0K 5X 1/10W	
R 2	NRSA02J-820X	MG RESISTOR	82 5X 1/10W	
R 12	NRSA02J-102X	MG RESISTOR	1.0K 5X 1/10W	
R 13	NRSA02J-104X	MG RESISTOR	100K 5X 1/10W	

BLOCK NO. 0961111111

REF.	PARTS NO.	PARTS NAME	REMARKS	SUFFIX
CN508	GGZ2001F1-02	2P CONNECTOR		
CN811	GGF1016F1-07	CONNECTOR		
CN812	GGF1008F1-11	CONNECTOR		
C3108	NCS21HJ-331X	C CAPACITOR	330PF 5X 50V	
C3208	NCS21HJ-331X	C CAPACITOR	330PF 5X 50V	
C5101	NCS21HJ-151X	C CAPACITOR	150PF 5X 50V	
C5102	GFN41HJ-562	M CAPACITOR	5600PF 5X 50V	
C5103	GTE1H06-475Z	SILMIC		
C5105	NCS21HJ-330X	C CAPACITOR	33PF 5X 50V	
C5106	NCS21HJ-100X	C CAPACITOR	10PF 5X 50V	
C5107	GER41HM-475	E CAPACITOR	4.7MF 20X 50V	
C5109	NER21HM-475	E CAPACITOR	4.7MF 20X 50V	
C5110	NER21HM-475	E CAPACITOR	1000PF 10X 50V	
C5201	NCS21HJ-151X	C CAPACITOR	150PF 5X 50V	
C5202	GFN41HJ-562	M CAPACITOR	5600PF 5X 50V	
C5203	GTE1H06-475Z	SILMIC		
C5205	NCS21HJ-330X	C CAPACITOR	33PF 5X 50V	
C5206	NCS21HJ-100X	C CAPACITOR	10PF 5X 50V	
C5207	GER41HM-475	E CAPACITOR	4.7MF 20X 50V	
C5208	GER41HM-475	E CAPACITOR	4.7MF 20X 50V	
C5209	NER21HM-102X	E CAPACITOR	1000PF 10X 50V	
C5210	NER21HM-475	E CAPACITOR	4.7MF 20X 50V	
C5301	NCS21HK-103X	C CAPACITOR	0.10MF 10X 50V	
C5302	GER41HM-225	E CAPACITOR	2.2MF 20X 50V	
C5303	GER41HM-225	E CAPACITOR	2.2MF 20X 50V	
C5304	GER41HM-105	E CAPACITOR	1.0MF 20X 50V	
C5307	GER41CM-476	E CAPACITOR	4.7MF 20X 16V	
C5308	GER41CM-226	E CAPACITOR	22MF 20X 16V	
C5309	GER41HM-105	E CAPACITOR	1.0MF 20X 50V	
C5311	NCS21HK-102X	C CAPACITOR	1000PF 10X 50V	
C5312	NCS21HK-103X	C CAPACITOR	-0.10MF 10X 50V	
C5313	NCF21H2-104X	C CAPACITOR	-10MF +80%-20X	
C5901	GER41EM-475	E CAPACITOR	4.7MF 20X 25V	
C5902	GER61CM-107Z	E-CAPA. I.M	100MF 20X 16V	
C5903	GER41CM-476	E CAPACITOR	4.7MF 20X 16V	
C8001	GER41AM-107	E CAPACITOR	100MF 20X 10V	
C8002	NCS21HK-103X	C CAPACITOR	-0.10MF 10X 50V	
C8201	NCS21HJ-225X	C CAPACITOR	.022MF 10X 50V	
C8202	NCS21HJ-101X	C CAPACITOR	100PF 5X 50V	
D 1	1S5133-T2	DIODE		
D 2	1S5133-T2	DIODE		
D 3	1S5133-T2	DIODE		
D 4	1S5133-T2	DIODE		
D1801	QLD0079-001	LCD MODULE		
D5301	MTJ33-3B-T2	ZENER DIODE 1/M		
D5302	1S5133-T2	DIODE		
D5303	1S5133-T2	DIODE	AUX MUTE	
D5304	1S5133-T2	DIODE	SEIDENKI	
D5304	1S5133-T2	DIODE	SEIDENKI	
D5901	MTJ33-3B-T2	Z DIODE		
D5902	1S5133-T2	DIODE		
D5903	1S5133-T2	DIODE		
D5905	MTJ39-1A-T2	ZENER DIODE	CT	
D5906	1S5133-T2	DIODE	RED	
D8001	SPR-39MWF	LED		

BLOCK NO. 096				BLOCK NO. 096					
REF.	PARTS NO.	PARTS NAME	REMARKS	SUFFIX	REF.	PARTS NO.	PARTS NAME	REMARKS	SUFFIX
R 20	NRSA02J-331X	MG RESISTOR	330 5X 1/10W		R5124	NRSA02J-473X	MG RESISTOR	47K 5X 1/10W	
R 21	NRSA02J-224X	RES. C.M	220K 5X 1/10W		R5125	NRSA02J-332X	MG RESISTOR	3.3K 5X 1/10W	
R 22	NRSA02J-331X	MG RESISTOR	330 5X 1/10W		R5126	NRSA02J-102X	MG RESISTOR	1.0K 5X 1/10W	
R 23	NRSA02J-270X	MG RESISTOR	270 5X 1/10W		R5127	NRSA02J-222X	MG RESISTOR	2.2K 5X 1/10W	
R 24	NRSA02J-271X	MG RESISTOR	270 5X 1/10W		R5128	NRSA02J-222X	MG RESISTOR	2.2K 5X 1/10W	
R 25	NRSA02J-473X	MG RESISTOR	47K 5X 1/10W		R5129	NRSA02J-182X	MG RESISTOR	1.8K 5X 1/10W	
R 27	NRSA02J-223X	MG RESISTOR	22K 5X 1/10W		R5201	NRSA02J-513X	MG RESISTOR	51K 5X 1/10W	
R 29	NRSA02J-473X	MG RESISTOR	47K 5X 1/10W		R5202	NRSA02J-273X	MG RESISTOR	27K 5X 1/10W	
R 30	NRSA02J-103X	MG RESISTOR	10K 5X 1/10W		R5203	NRSA02J-153X	MG RESISTOR	15K 5X 1/10W	
R 31	NRSA02J-103X	MG RESISTOR	10K 5X 1/10W		R5204	NRSA02J-182X	MG RESISTOR	1.8K 5X 1/10W	
R 32	NRSA02J-473X	MG RESISTOR	47K 5X 1/10W		R5205	NRSA02J-182X	MG RESISTOR	1.8K 5X 1/10W	
R 34	NRSA02J-333X	MG RESISTOR	33K 5X 1/10W		R5206	NRSA02J-153X	MG RESISTOR	15K 5X 1/10W	
R 35	NRSA02J-333X	MG RESISTOR	33K 5X 1/10W		R5207	NRSA02J-122X	MG RESISTOR	1.2K 5X 1/10W	
R 36	NRSA02J-103X	MG RESISTOR	10K 5X 1/10W		R5208	NRSA02J-682X	MG RESISTOR	6.8K 5X 1/10W	
R 37	NRSA02J-472X	MG RESISTOR	47K 5X 1/10W		R5209	NRSA02J-222X	MG RESISTOR	2.2K 5X 1/10W	
R 38	NRSA02J-392X	MG RESISTOR	3.9K 5X 1/10W		R5210	NRSA02J-182X	MG RESISTOR	1.8K 5X 1/10W	
R 39	NRSA02J-392X	MG RESISTOR	3.9K 5X 1/10W		R5211	NRSA02J-123X	RES. C.M	12K 5X 1/10W	
R 42	NRSA02J-102X	MG RESISTOR	1.0K 5X 1/10W		R5212	NRSA02J-472X	MG RESISTOR	4.7K 5X 1/10W	
R 43	NRSA02J-102X	MG RESISTOR	1.0K 5X 1/10W		R5213	NRSA02J-153X	MG RESISTOR	15K 5X 1/10W	
R 44	NRSA02J-102X	MG RESISTOR	1.0K 5X 1/10W		R5214	NRSA02J-222X	MG RESISTOR	2.2K 5X 1/10W	
R 45	NRSA02J-102X	MG RESISTOR	1.0K 5X 1/10W		R5215	NRSA02J-103X	MG RESISTOR	10K 5X 1/10W	
R 46	NRSA02J-473X	MG RESISTOR	47K 5X 1/10W		R5216	NRSA02J-753X	MG RESISTOR	75K 5X 1/10W	
R 48	NRSA02J-103X	MG RESISTOR	1.0K 5X 1/10W		R5222	NRSA02J-102X	MG RESISTOR	1.0K 5X 1/10W	
R 52	NRSA02J-472X	MG RESISTOR	4.7K 5X 1/10W		R5223	NRSA02J-154X	RES. C.M	150K 5X 1/10W	
R 54	NRSA02J-472X	MG RESISTOR	4.7K 5X 1/10W		R5224	NRSA02J-473X	MG RESISTOR	47K 5X 1/10W	
R 55	NRSA02J-182X	MG RESISTOR	1.8K 5X 1/10W		R5225	NRSA02J-332X	MG RESISTOR	3.3K 5X 1/10W	
R 56	NRSA02J-332X	MG RESISTOR	3.3K 5X 1/10W		R5226	NRSA02J-102X	MG RESISTOR	1.0K 5X 1/10W	
R 57	NRSA02J-102X	MG RESISTOR	1.0K 5X 1/10W		R5227	NRSA02J-222X	MG RESISTOR	2.2K 5X 1/10W	
R 66	NRSA02J-222X	MG RESISTOR	2.2K 5X 1/10W		R5228	NRSA02J-222X	MG RESISTOR	2.2K 5X 1/10W	
R 68	NRSA02J-473X	MG RESISTOR	47K 5X 1/10W		R5229	NRSA02J-182X	MG RESISTOR	1.8K 5X 1/10W	
R 69	NRSA02J-222X	MG RESISTOR	2.2K 5X 1/10W		R5301	NRSA02J-825X	MG RESISTOR	8.2K 5X 1/10W	
R 99	QRZ9037-335	COMP RESISTOR	3.3M 1/0W		R5302	NRSA02J-825X	MG RESISTOR	8.2K 5X 1/10W	
R 99	QRZ9037-335	COMP RESISTOR	3.3M 1/0W		R5303	NRSA02J-750X	RES. C.M	75 5X 1/10W	
R104	NRSA02J-151X	MG RESISTOR	150 5X 1/10W		R5304	NRSA02J-750X	RES. C.M	75 5X 1/10W	
R107	NRSA02J-471X	MG RESISTOR	470 5X 1/10W		R5305	NRSA02J-750X	RES. C.M	75 5X 1/10W	
R206	NRSA02J-151X	MG RESISTOR	150 5X 1/10W		R5306	NRSA02J-223X	MG RESISTOR	22K 5X 1/10W	
R207	NRSA02J-471X	MG RESISTOR	470 5X 1/10W		R5311	NRSA02J-750X	RES. C.M	75 5X 1/10W	
R3101	NRSA02J-513X	MG RESISTOR	51K 5X 1/10W		R5312	NRSA02J-473X	MG RESISTOR	47K 5X 1/10W	
R5102	NRSA02J-273X	MG RESISTOR	27K 5X 1/10W		R5313	NRSA02J-513X	MG RESISTOR	51K 5X 1/10W	
R5103	NRSA02J-153X	MG RESISTOR	15K 5X 1/10W		R5314	NRSA02J-223X	MG RESISTOR	W/O A5MD	
R5104	NRSA02J-222X	MG RESISTOR	2.2K 5X 1/10W		R5901	NRSA02J-392X	MG RESISTOR	39 5X 1/10W	
R5105	NRSA02J-222X	MG RESISTOR	2.2K 5X 1/10W		R5902	NRSA02J-332X	MG RESISTOR	3.3K 5X 1/10W	
R5106	NRSA02J-153X	MG RESISTOR	15K 5X 1/10W		R5903	NRSA02J-273X	MG RESISTOR	27K 5X 1/10W	
R5107	NRSA02J-122X	MG RESISTOR	1.2K 5X 1/10W		R5904	NRSA02J-102X	MG RESISTOR	1.0K 5X 1/10W	
R5108	NRSA02J-682X	MG RESISTOR	6.8K 5X 1/10W		R5905	NRSA02J-471X	MG RESISTOR	470 5X 1/10W	
R5109	NRSA02J-222X	MG RESISTOR	2.2K 5X 1/10W		R5906	NRSA02J-471X	MG RESISTOR	470 5X 1/10W	
R5110	NRSA02J-182X	MG RESISTOR	1.8K 5X 1/10W		R5907	NRSA02J-392X	MG RESISTOR	3.9K 5X 1/10W	
R5111	NRSA02J-122X	RES. C.M	12K 5X 1/10W		R5908	NRSA02J-332X	MG RESISTOR	3.3K 5X 1/10W	
R5112	NRSA02J-472X	MG RESISTOR	4.7K 5X 1/10W		R8001	NRSA02J-102X	MG RESISTOR	1.0K 5X 1/10W	
R5113	NRSA02J-153X	MG RESISTOR	15K 5X 1/10W		R8002	NRSA02J-102X	MG RESISTOR	1.0K 5X 1/10W	
R5114	NRSA02J-222X	MG RESISTOR	2.2K 5X 1/10W		R8003	NRSA02J-123X	MG RESISTOR	1.2K 5X 1/10W	
R5115	NRSA02J-103X	MG RESISTOR	10K 5X 1/10W		R8004	NRSA02J-153X	MG RESISTOR	1.5K 5X 1/10W	
R5116	NRSA02J-753X	MG RESISTOR	75K 5X 1/10W		R8005	NRSA02J-222X	MG RESISTOR	2.2K 5X 1/10W	
R5122	NRSA02J-102X	MG RESISTOR	1.0K 5X 1/10W		R8006	NRSA02J-222X	MG RESISTOR	2.2K 5X 1/10W	
R5123	NRSA02J-154X	RES. C.M	150K 5X 1/10W		R8007	NRSA02J-392X	MG RESISTOR	3.9K 5X 1/10W	

■ Micon Board (FS-V5)

BLOCK NO. 07				BLOCK NO. 07					
REF.	PARTS NO.	PARTS NAME	REMARKS	SUFFIX	REF.	PARTS NO.	PARTS NAME	REMARKS	SUFFIX
R8010	NRSA02J-681X	MG RESISTOR	680 5X 1/10W		CN701	GGF1201F3-13	CONNECTOR	TO CD PWB	
R8011	GRE141J-152Y	C RESISTOR	1.5K 5X 1/4W		CN706	GBB1214K1-12S	CONNECTOR	TO FUNCTION PWB	
R8201	NRSA02J-432X	RES. C.M	4.3K 5X 1/10W		CN707	GBB1214K1-12S	CONNECTOR	TO FUNCTION PWB	
R8301	NRSA02J-821X	MG RESISTOR	820 5X 1/10W		CN711	GGF1016C1-07	CONNECTOR	TO FKEY PWB	
R8302	NRSA02J-821X	MG RESISTOR	820 5X 1/10W		CN712	GGF1008F1-11	CONNECTOR	TO LCD PWB	
R8303	NRSA02J-821X	MG RESISTOR	820 5X 1/10W		CN714	OGA2001C1-03	3P PLUG ASSY	TO DOOR-SW PWB	
R8304	NRSA02J-821X	MG RESISTOR	820 5X 1/10W		CN721	GBB1214J1-12S	CONNECTOR	TO MAIN PWB	
R8305	NRSA02J-821X	MG RESISTOR	820 5X 1/10W		CN772	GBB1214J1-12S	CONNECTOR	TO MAIN PWB	
R8306	NRSA02J-821X	MG RESISTOR	820 5X 1/10W		C7001	NCS21HJ-180X	C CAPACITOR	18PF 5X 50V	
R8307	NRSA02J-102X	MG RESISTOR	1.0K 5X 1/10W		C7002	NCS21HJ-180X	C CAPACITOR	18PF 5X 50V	
R8308	NRSA02J-102X	MG RESISTOR	1.0K 5X 1/10W		C7003	NCS21HJ-390X	C CAPACITOR	39PF 5X 50V	
R8309	NRSA02J-102X	MG RESISTOR	1.0K 5X 1/10W		C7004	NCS21HJ-360X	C CAPACITOR	36PF 5X 50V	
S8001	OSW0698-001Z	TACT SWITCH	DOOR OP/CL		C7005	NCS21HJ-220X	C CAPACITOR	22PF 5X 50V	
S8002	OSW0698-001Z	TACT SWITCH	CD		C7006	NCS21HJ-200X	C CAPACITOR	20PF 5X 50V	
S8003	OSW0698-001Z	TACT SWITCH	TUNER		C7007	NCB21HK-102X	C CAPACITOR	1000PF 10X 50V	
S8004	OSW0698-001Z	TACT SWITCH	TAPE		C7008	NCB21HK-102X	C CAPACITOR	1000PF 10X 50V	
S8005	OSW0698-001Z	TACT SWITCH	MD/AUX		C7011	QER41AM-107	E CAPACITOR	100MF 20X 10V	
S8006	OSW0698-001Z	TACT SWITCH	B-SEARCH		C7012	NCB21HK-103X	C CAPACITOR	-010MF 10X 50V	
S8007	OSW0698-001Z	TACT SWITCH	STOP/CLR		C7013	NCB21HK-104X	C CAPACITOR	-10MF +80:-20X	
S8008	OSW0698-001Z	TACT SWITCH	F-SEARCH		C7108	NCS21HJ-101X	C CAPACITOR	100PF 5X 50V	
S8010	OSW0698-001Z	TACT SWITCH	POWER		C7109	NCS21HJ-101X	C CAPACITOR	100PF 5X 50V	
S8101	OSW0650-001	SWITCH			C7116	NCS21HJ-101X	C CAPACITOR	100PF 5X 50V	
S8102	OSW0650-001	SWITCH			C7122	NCB21HK-103X	C CAPACITOR	-010MF 10X 50V	
T 1	GR0795-001	IFT			C7123	NCB21HK-103X	C CAPACITOR	-010MF 10X 50V	
TU 1	GAX0097-001	FRONT END	FM TU		C7125	NCS21HJ-101X	C CAPACITOR	100PF 5X 50V	
X 1	GAX0402-001	CRYSTAL			C7126	NCS21HJ-101X	C CAPACITOR	100PF 5X 50V	
					C7201	QER61CM-107Z	E.CAPA. I.M	100MF 20X 16V	
					C7202	QFN41HJ-104	M CAPACITOR	.10MF 5X 50V	
					C7311	QER41HM-475	E CAPACITOR	4.7MF 20X 50V	
					C7312	QER41HM-225	E CAPACITOR	2.2MF 20X 50V	
					C7321	QE2029-679Z	EDL CAPACITOR	67000UF	
					C7801	QER61HM-35Z	E CAPACITOR	3.3MF 20X 50V	
					C7802	QER41HM-225	E CAPACITOR	2.2MF 20X 50V	
					C7803	QER41HM-105	E CAPACITOR	1.0MF 20X 50V	
					C7804	QER41HM-225	E CAPACITOR	2.2MF 20X 50V	
					C7805	QER41HM-105	E CAPACITOR	1.0MF 20X 50V	
					C7811	NCB21HK-103X	C CAPACITOR	.010MF 10X 50V	
					D7001	1S5133-T2	DIODE	CLOCK	
					D7201	1S5133-T2	DIODE	US6V2	
					D7202	1S5133-T2	DIODE	US5V	
					D7203	1S5133-T2	DIODE	LCD5V	
					D7204	1S5133-T2	DIODE	BU5V	
					D7205	MTJ8-2B-T2	DIODE	US6V2	
					D7301	MTJ5-1C-T2	ZENER DIODE	BUCKUP	
					D7311	1S5133-T2	DIODE	RESET	
					D7321	1S5133-T2	DIODE	LCD5V	
					IC701	UPD78056GC-A29	IC	BU5V	
					IC702	KIA78S06P-T	IC	SYSTEM MICON	
					K7201	QGR0601-001Z	F.BEADS I.M	US6V REG	
					K7202	QGR0601-001Z	F.BEADS I.M	ICVSS	
					K7203	QGR0601-001Z	F.BEADS I.M	AVSS	
					L7201	QGL01BK-100Z	F.INDUCTOR	FKEY	
					L7202	QGL01BK-100Z	INDUCTOR	VDD	
					PP701	Q240007-001	POST PIN	AVDD	
					PP702	Q240007-001	POST PIN	AVDD	

BLOCK NO. 07					BLOCK NO. 07				
REF.	PARTS NO.	PARTS NAME	REMARKS	SUFFIX	REF.	PARTS NO.	PARTS NAME	REMARKS	SUFFIX
G7001	25C2668/01-T	TRANSISTOR TAPE	CLOCK SHIFT		R7144	NRSA02J-222X	MG RESISTOR	2.2K 5X 1/10W	
G7002	25C2668/01-T	TRANSISTOR TAPE	CLOCK SHIFT		R7145	NRSA02J-222X	MG RESISTOR	2.2K 5X 1/10W	
G7301	25C2412K/R/-X	TRANSISTOR	BACKUP CONT		R7146	NRSA02J-222X	MG RESISTOR	2.2K 5X 1/10W	
G7311	25C2412K/R/-X	TRANSISTOR	RESET		R7147	NRSA02J-222X	MG RESISTOR	2.2K 5X 1/10W	
G7321	25A1037AK/R/-X	CHIP TR.C.M	SWSV		R7148	NRSA02J-222X	MG RESISTOR	2.2K 5X 1/10W	
G7811	35C212K/R/-X	TRANSISTOR	PHOTO BUFFER		R7150	NRSA02J-102X	MG RESISTOR	1.0K 5X 1/10W	
G7821	07C114EKA-X	TR	BL DIMMER		R7151	NRSA02J-222X	MG RESISTOR	2.2K 5X 1/10W	
G7822	25A935S/RS/-T	TRANSISTOR	BL DIMMER		R7152	NRSA02J-222X	MG RESISTOR	2.2K 5X 1/10W	
R7001	NRSA02J-B52X	MG RESISTOR	8.2K 5X 1/10W		R7153	NRSA02J-222X	MG RESISTOR	2.2K 5X 1/10W	
R7002	NRSA02J-B52X	MG RESISTOR	8.2K 5X 1/10W		R7154	NRSA02J-222X	MG RESISTOR	2.2K 5X 1/10W	
R7003	NRSA02J-103X	MG RESISTOR	10K 5X 1/10W		R7155	NRSA02J-222X	MG RESISTOR	2.2K 5X 1/10W	
R7004	NRSA02J-103X	MG RESISTOR	10K 5X 1/10W		R7156	NRSA02J-222X	MG RESISTOR	2.2K 5X 1/10W	
R7005	NRSA02J-102X	MG RESISTOR	1.0K 5X 1/10W		R7301	NRSA02J-473X	MG RESISTOR	47K 5X 1/10W	
R7101	NRSA02J-222X	MG RESISTOR	2.2K 5X 1/10W		R7302	NRSA02J-333X	MG RESISTOR	33K 5X 1/10W	
R7102	NRSA02J-222X	MG RESISTOR	2.2K 5X 1/10W		R7303	NRSA02J-104X	MG RESISTOR	100K 5X 1/10W	
R7103	NRSA02J-222X	MG RESISTOR	2.2K 5X 1/10W		R7304	NRSA02J-102X	MG RESISTOR	1.0K 5X 1/10W	
R7104	NRSA02J-222X	MG RESISTOR	2.2K 5X 1/10W		R7311	NRSA02J-103X	MG RESISTOR	10K 5X 1/10W	
R7105	NRSA02J-102X	MG RESISTOR	1.0K 5X 1/10W		R7312	NRSA02J-103X	MG RESISTOR	10K 5X 1/10W	
R7106	NRSA02J-102X	MG RESISTOR	1.0K 5X 1/10W		R7313	NRSA02J-103X	MG RESISTOR	10K 5X 1/10W	
R7107	NRSA02J-102X	MG RESISTOR	1.0K 5X 1/10W		R7314	NRSA02J-102X	MG RESISTOR	1.0K 5X 1/10W	
R7108	NRSA02J-102X	MG RESISTOR	1.0K 5X 1/10W		R7315	NRSA02J-103X	MG RESISTOR	10K 5X 1/10W	
R7109	NRSA02J-102X	MG RESISTOR	1.0K 5X 1/10W		R7321	NRSA02J-331X	MG RESISTOR	330 5X 1/10W	
R7110	NRSA02J-102X	MG RESISTOR	1.0K 5X 1/10W		R7322	NRSA02J-103X	MG RESISTOR	10K 5X 1/10W	
R7111	NRSA02J-102X	MG RESISTOR	1.0K 5X 1/10W		R7401	NRSA02J-103X	MG RESISTOR	10K 5X 1/10W	
R7112	NRSA02J-102X	MG RESISTOR	1.0K 5X 1/10W		R7402	NRSA02J-103X	MG RESISTOR	10K 5X 1/10W	
R7113	NRSA02J-102X	MG RESISTOR	1.0K 5X 1/10W		R7403	NRSA02J-103X	MG RESISTOR	10K 5X 1/10W	
R7114	NRSA02J-222X	MG RESISTOR	2.2K 5X 1/10W		R7404	NRSA02J-103X	MG RESISTOR	10K 5X 1/10W	
R7115	NRSA02J-222X	MG RESISTOR	2.2K 5X 1/10W		R7405	NRSA02J-103X	MG RESISTOR	10K 5X 1/10W	
R7116	NRSA02J-222X	MG RESISTOR	2.2K 5X 1/10W		R7406	NRSA02J-103X	MG RESISTOR	10K 5X 1/10W	
R7117	NRSA02J-222X	MG RESISTOR	2.2K 5X 1/10W		R7407	NRSA02J-103X	MG RESISTOR	10K 5X 1/10W	
R7118	NRSA02J-222X	MG RESISTOR	2.2K 5X 1/10W		R7408	NRSA02J-563X	RES. C.M	56K 5X 1/10W	
R7119	NRSA02J-222X	MG RESISTOR	2.2K 5X 1/10W		R7409	NRSA02J-273X	MG RESISTOR	27K 5X 1/10W	
R7120	NRSA02J-222X	MG RESISTOR	2.2K 5X 1/10W		R7410	NRSA02J-103X	MG RESISTOR	10K 5X 1/10W	
R7121	NRSA02J-222X	MG RESISTOR	2.2K 5X 1/10W		R7411	NRSA02J-823X	MG RESISTOR	82K 5X 1/10W	
R7122	NRSA02J-222X	MG RESISTOR	2.2K 5X 1/10W		R7801	NRSA02J-114X	RES. C.M	110K 5X 1/10W	
R7123	NRSA02J-222X	MG RESISTOR	2.2K 5X 1/10W		R7802	NRSA02J-114X	RES. C.M	110K 5X 1/10W	
R7124	NRSA02J-222X	MG RESISTOR	2.2K 5X 1/10W		R7803	NRSA02J-683X	MG RESISTOR	68K 5X 1/10W	
R7125	NRSA02J-103X	MG RESISTOR	10K 5X 1/10W		R7804	NRSA02J-105X	MG RESISTOR	10M 5X 1/10W	
R7126	NRSA02J-103X	MG RESISTOR	10K 5X 1/10W		R7805	NRSA02J-683X	MG RESISTOR	68K 5X 1/10W	
R7128	NRSA02J-103X	MG RESISTOR	10K 5X 1/10W		R7811	NRSA02J-823X	MG RESISTOR	82K 5X 1/10W	
R7129	NRSA02J-222X	MG RESISTOR	2.2K 5X 1/10W		R7812	NRSA02J-594X	RES. C.M	390K 5X 1/10W	
R7130	NRSA02J-222X	MG RESISTOR	2.2K 5X 1/10W		R7813	NRSA02J-104X	MG RESISTOR	100K 5X 1/10W	
R7131	NRSA02J-222X	MG RESISTOR	2.2K 5X 1/10W		R7821	NRSA02J-103X	MG RESISTOR	10K 5X 1/10W	
R7132	NRSA02J-222X	MG RESISTOR	2.2K 5X 1/10W		R7822	NRSA02J-473X	MG RESISTOR	47K 5X 1/10W	
R7133	NRSA02J-222X	MG RESISTOR	2.2K 5X 1/10W		R7823	NRSA02J-122X	MG RESISTOR	1.2K 5X 1/10W	
R7134	NRSA02J-222X	MG RESISTOR	2.2K 5X 1/10W		R7824	NRSA02J-122X	MG RESISTOR	1.2K 5X 1/10W	
R7135	NRSA02J-103X	MG RESISTOR	10K 5X 1/10W		X7001	GAXO401-001	CRYSTAL	CLOCK (36.678KHZ	
R7136	NRSA02J-222X	MG RESISTOR	2.2K 5X 1/10W		X7002	GAXO410-001	CERA LOCK	MAIN CK(4.19MHZ	
R7137	NRSA02J-153X	MG RESISTOR	15K 5X 1/10W						
R7138	NRSA02J-222X	MG RESISTOR	2.2K 5X 1/10W						
R7139	NRSA02J-222X	MG RESISTOR	2.2K 5X 1/10W						
R7140	NRSA02J-102X	MG RESISTOR	1.0K 5X 1/10W						
R7141	NRSA02J-473X	MG RESISTOR	47K 5X 1/10W						
R7142	NRSA02J-473X	MG RESISTOR	47K 5X 1/10W						
R7143	NRSA02J-333X	MG RESISTOR	33K 5X 1/10W						

CD Board (FS-V5)

BLOCK NO. 00111111				BLOCK NO. 00111111					
REF.	PARTS NO.	PARTS NAME	REMARKS	SUFFIX	REF.	PARTS NO.	PARTS NAME	REMARKS	SUFFIX
C601	GG1201F3-13	CONNECTOR	V3/V5/V9/A1/A5		C6099	NCB21HK-102X	C CAPACITOR	1000PF 10X 50V	
C602	GG1201F3-10	CONNECTOR	V3/V5/V9/A1/A5		C6101	NCB21HK-223X	C CAPACITOR	0.22MF 10X 50V	
C603	GG1004F4-10	FPC CONNECTOR			C6156	NC521HJ-151X	C CAPACITOR	150PF 5X 50V	
C604	GG2501C1-05	3P CONNECTOR			C6157	NC521HJ-151X	C CAPACITOR	150PF 5X 50V	
C605	GG1501C3-02	W TO B CONN	RED		C6158	NC521HJ-151X	C CAPACITOR	150PF 5X 50V	
C606	GG1501C4-02	W TO B CONN	BLUE		D6061	1S8355-X	DIODE C-M		
C607	VMCO199-902V	CONNECTOR	WHITE		D6062	1S8355-X	DIODE C-M		
C6001	GER40JM-107	E CAPACITOR	10MF 20X 6.3V		D6063	1S8355-X	DIODE C-M		
C6002	GER41CM-106	E CAPACITOR	10MF 20X 16V		IC601	AN8906SB-W	IC		
C6003	NC521HJ-3R5X	C CAPACITOR			IC602	BA6897FP-W	IC		
C6005	NC521HJ-331X	C CAPACITOR	330PF 5X 50V		IC603	MN35510	IC		
C6004	NCB21HK-102X	C CAPACITOR	1000PF 10X 50V		K6051	GR0779-001Z	INDUCTOR		
C6007	NCB21HK-102X	C CAPACITOR	1000PF 10X 50V		Q6001	2SA1037AK/R/-X	CHIP TR-C-M		
C6008	GER41HM-105	E CAPACITOR	1.0MF 20X 50V		Q6031	2SA952/LK/-I	TRANSISTOR		
C6009	NC521HJ-101X	C CAPACITOR	100PF 5X 50V		R6001	NRS402J-123X	RES-C-M	12K 5X 1/10W	
C6010	NCB21HK-223X	C CAPACITOR	0.22MF 10X 50V		R6002	NRS402J-225X	MG RESISTOR	2.2M 5X 1/10W	
C6011	NCB21HK-222X	C CAPACITOR	2500PF 10X 50V		R6003	NRS402J-102X	MG RESISTOR	1.0K 5X 1/10W	
C6012	NCB21HK-103X	C CAPACITOR	0.10MF 10X 25V		R6005	NRS402J-124X	MG RESISTOR	120K 5X 1/10W	
C6014	NCB21HK-104X	C CAPACITOR	1.0MF 10X 25V		R6006	NRS402J-473X	MG RESISTOR	47K 5X 1/10W	
C6015	NCB21HK-223X	C CAPACITOR	0.22MF 10X 50V		R6007	NRS402J-273X	MG RESISTOR	27K 5X 1/10W	
C6016	NCB21HK-223X	C CAPACITOR	0.22MF 10X 50V		R6009	NRS402J-393X	MG RESISTOR	39K 5X 1/10W	
C6017	NCB21HK-223X	C CAPACITOR	0.22MF 10X 50V		R6010	NRS402J-104X	MG RESISTOR	100K 5X 1/10W	
C6018	NCB21HK-222X	C CAPACITOR	2200PF 10X 50V		R6012	NRS402J-103X	MG RESISTOR	10K 5X 1/10W	
C6019	NC521HJ-271X	C CAPACITOR	270PF 5X 50V		R6013	NRS402J-121X	MG RESISTOR	120 5X 1/10W	
C6020	NC521HJ-181X	C CAPACITOR	180PF 5X 50V		R6014	NRS402J-100X	MG RESISTOR	10 5X 1/10W	
C6021	NC521HJ-821X	C CAPACITOR	820PF 5X 50V		R6015	NRS402J-120X	MG RESISTOR	12 5X 1/10W	
C6022	GER60JM-476Z	E.CAPA. I-M	4.7MF 20X 6.3V		R6016	NRS402J-910X	RES-C-M	91 5X 1/10W	
C6023	NCB21EK-104X	C CAPACITOR	1.0MF 10X 25V		R6021	NRS402J-101X	MG RESISTOR	100 5X 1/10W	
C6028	NCB21EK-473X	C CAPACITOR	0.47MF 10X 25V		R6022	NRS402J-101X	MG RESISTOR	100 5X 1/10W	
C6029	GER40JM-107	E CAPACITOR	100MF 20X 6.3V		R6023	NRS402J-101X	MG RESISTOR	100 5X 1/10W	
C6031	GER41AM-227	E.CAPA. I-M	220MF 20X 10V		R6024	NRS402J-104X	MG RESISTOR	100K 5X 1/10W	
C6032	GER40JM-107	E CAPACITOR	100MF 20X 6.3V		R6025	NRS402J-104X	MG RESISTOR	100K 5X 1/10W	
C6051	NDC21HJ-120X	C CAPACITOR			R6026	NRS402J-393X	MG RESISTOR	39K 5X 1/10W	
C6052	NDC21HJ-150X	C CAPACITOR			R6027	NRS402J-393X	MG RESISTOR	39K 5X 1/10W	
C6053	NCB21HK-223X	C CAPACITOR			R6028	NRS402J-393X	MG RESISTOR	39K 5X 1/10W	
C6055	NCB21EK-473X	C CAPACITOR	0.22MF 10X 50V		R6029	NRS402J-393X	MG RESISTOR	39K 5X 1/10W	
C6058	NC521HJ-6R0X	C.CAPA. C-M	0.67MF 10X 25V		R6031	NRS402J-331X	MG RESISTOR	330 5X 1/10W	
C6061	NC521HJ-471X	C CAPACITOR	470PF 5X 50V		R6032	NRS402J-101X	MG RESISTOR	100 5X 1/10W	
C6062	NCB21HK-223X	C CAPACITOR	0.22MF 10X 50V		R6041	NRS402J-273X	MG RESISTOR	27K 5X 1/10W	
C6063	NCB21HK-223X	C CAPACITOR	0.22MF 10X 50V		R6042	NRS402J-183X	MG RESISTOR	18K 5X 1/10W	
C6064	NCB21HK-223X	C CAPACITOR	0.22MF 10X 50V		R6043	NRS402J-272X	MG RESISTOR	2.7K 5X 1/10W	
C6065	NCB21CK-334X	C.CAPA. C-M	0.33MF 10X 16V		R6044	NRS402J-273X	MG RESISTOR	27K 5X 1/10W	
C6071	NCB21HK-222X	C CAPACITOR	2200PF 10X 50V		R6045	NRS402J-393X	MG RESISTOR	39K 5X 1/10W	
C6072	NCB21HK-222X	C CAPACITOR	2200PF 10X 50V		R6046	NRS402J-332X	MG RESISTOR	3.3K 5X 1/10W	
C6073	GER41AM-227	E.CAPA. I-M	220MF 20X 10V		R6047	NRS402J-332X	MG RESISTOR	3.3K 5X 1/10W	
C6075	NCB21HK-102X	C CAPACITOR	1000PF 10X 50V		R6051	NRS402J-102X	MG RESISTOR	1.0K 5X 1/10W	
C6076	NCB21HK-102X	C CAPACITOR	1000PF 10X 50V		R6052	NRS402J-102X	MG RESISTOR	1.0K 5X 1/10W	
C6077	NCB21HK-223X	C CAPACITOR	0.22MF 10X 50V		R6053	NRS402J-102X	MG RESISTOR	1.0K 5X 1/10W	
C6080	GER41AM-227	E.CAPA. I-M	220MF 20X 10V		R6054	NRS402J-102X	MG RESISTOR	1.0K 5X 1/10W	
C6081	GER41AM-227	E.CAPA. I-M	220MF 20X 10V		R6055	NRS402J-102X	MG RESISTOR	1.0K 5X 1/10W	
C6083	NCB21HK-223X	C CAPACITOR	0.22MF 10X 50V		R6056	NRS402J-OR0X	MG RESISTOR	5X 1/10W	
C6095	NCB21EK-104X	C CAPACITOR	1.0MF 10X 25V		R6057	NRS402J-OR0X	MG RESISTOR	5X 1/10W	
C6096	NCB21HK-102X	C CAPACITOR	1000PF 10X 50V		R6058	NRS402J-OR0X	MG RESISTOR	5X 1/10W	
C6097	NCB21HK-102X	C CAPACITOR	1000PF 10X 50V		R6059	NRS402J-471X	MG RESISTOR	470 5X 1/10W	
C6098	NCB21HK-102X	C CAPACITOR	1000PF 10X 50V						

Switch Board (UX-V5/UX-V3/FS-V5)

BLOCK NO. 09				BLOCK NO. 09					
REF.	PARTS NO.	PARTS NAME	REMARKS	SUFFIX	REF.	PARTS NO.	PARTS NAME	REMARKS	SUFFIX
R6060	NRSA02J-071X	MG RESISTOR	470 5X 1/10W		CN	1	GGB201LI-10	TOP PLUG ASSY	
R6061	NRSA02J-104X	MG RESISTOR	100K 5X 1/10W		D	1	1SR139-100-T2	SI DIODE	
R6063	NRSA02J-124X	MG RESISTOR	120K 5X 1/10W		IC	1	SG-105F3-BB-C	PHOTO SENSER	
R6064	NRSA02J-681X	MG RESISTOR	680 5X 1/10W		P	1	QNZ0104-001	POST PIN	
R6066	NRSA02J-220X	MG RESISTOR	22 5X 1/10W		SW	1	MXS00220HVLO	CASSETTE SWITCH R.REC	
R6067	NRSA02J-220X	MG RESISTOR	22 5X 1/10W		SW	2	MXS00220HVLO	CASSETTE SWITCH TAPE	
R6068	NRSA02J-220X	MG RESISTOR	22 5X 1/10W		SW	4	MXS00220HVLO	CASSETTE SWITCH 70U	
R6069	NRSA02J-155X	MG RESISTOR	1.5M 5X 1/10W		SW	5	MXS00220HVLO	CASSETTE SWITCH F.REC	
R6071	NRSA02J-102X	MG RESISTOR	1.0K 5X 1/10W		SW	5	MXS00220HVLO	CASSETTE SWITCH F.REC	
R6072	NRSA02J-102X	MG RESISTOR	1.0K 5X 1/10W		SW	6	GSW0507-001	SWITCH	
R6076	NRSA02J-0R0X	MG RESISTOR	5X 1/10W						
R6080	NRSA02J-0R0X	MG RESISTOR	5X 1/10W						
R6081	NRSA02J-0R0X	MG RESISTOR	5X 1/10W						
R6121	NRSA02J-101X	MG RESISTOR	100 5X 1/10W						
W 805	QJL006-021302	SIN CR B-B WIRE	-WB15 LED-LCD						
W 814	QJK018-031203	SIN CR C-B WIRE	DOOR SW WIRE						
W3004	QJK017-052600	SIN CR C-B WIRE	H-P WIRE						
W3351	QJPO03-042401	SIN CR C-B WIRE	MAIN-FUNC SHTEL						
W5501	QJK018-020802	SIN CR C-B WIRE	TOP KEY WIRE						
X6051	QAX0413-001Z	CRYSTAL							

■ Preamp Board (UX-V5/UX-V3/FS-V5)

BLOCK NO. 15			BLOCK NO. 16		
REF.	PARTS NO.	PARTS NAME	REMARKS	SUFFIX	
C 101	NCS21HJ-821X	C CAPACITOR	820PF 5X 50V		
C 102	NCS21HJ-221X	C CAPACITOR	220PF 5X 50V		
C 103	QK40JEM-227	E CAPACITOR	220MF 20X 6.3V		
C 104	NCS21HJ-333X	C CAPACITOR	-033MF 10X 50V		
C 105	NCS21HK-222X	C CAPACITOR	220PF 10X 50V		
C 106	QK41CM-106	E CAPACITOR	10MF 20X 10V		
C 107	NCS21HJ-561X	C CAPACITOR	560PF 5X 50V		
C 108	QK41EM-475	E CAPACITOR	4.7MF 20X 25V		
C 109	QK41EM-475	E CAPACITOR	4.7MF 20X 25V		
C 110	NCS21HK-682X	C CAPACITOR	6800PF 10X 50V		
C 111	NCS21HK-122X	C CAPACITOR	1200PF 10X 50V		
C 112	NCS21EK-683X	C CAPACITOR	-068MF 10X 25V		
C 113	NCS21HK-222X	C CAPACITOR	2200PF 10X 50V		
C 121	NCS21HJ-331X	C CAPACITOR	330PF 5X 50V		
C 201	NCS21HJ-821X	C CAPACITOR	820PF 5X 50V		
C 202	NCS21HJ-221X	C CAPACITOR	220PF 5X 50V		
C 203	QK60JM-227	E CAPACITOR	220MF 20X 6.3V		
C 204	NCS21HK-333X	C CAPACITOR	-033MF 10X 50V		
C 205	NCS21HK-222X	C CAPACITOR	2200PF 10X 50V		
C 206	QK41CM-106	E CAPACITOR	10MF 20X 10V		
C 207	NCS21HJ-561X	C CAPACITOR	560PF 5X 50V		
C 208	QK41EM-475	E CAPACITOR	4.7MF 20X 25V		
C 209	QK41EM-475	E CAPACITOR	4.7MF 20X 25V		
C 210	NCS21HK-682X	C CAPACITOR	6800PF 10X 50V		
C 211	NCS21HK-122X	C CAPACITOR	1200PF 10X 50V		
C 212	NCS21EK-683X	C CAPACITOR	-068MF 10X 25V		
C 221	NCS21HJ-331X	C CAPACITOR	330PF 5X 50V		
C 301	QK41AM-107Z	E CAPACITOR	100MF 20X 10V		
C 302	NCS21HK-393X	C CAPACITOR	-039MF 10X 50V		
C 303	QK60JM-227	E CAPACITOR	220MF 20X 6.3V		
C 304	QK41CM-226	E CAPACITOR	22MF 20X 16V		
C 305	QK41CM-226	E CAPACITOR	22MF 20X 16V		
C 306	QK41CM-476	E CAPACITOR	4.7MF 20X 16V		
C 307	NCS21HK-103X	C CAPACITOR	-010MF 10X 50V		
C 308	NCS21HK-562X	C CAPACITOR	5600PF 10X 50V		
C 309	NCS21HK-562X	C CAPACITOR	5600PF 10X 50V		
C 310	NCS21HK-223X	C CAPACITOR	-022MF 10X 50V		
C 311	NCS21HK-682X	C CAPACITOR	6800PF 10X 50V		
C 313	QK41AM-107Z	E CAPACITOR	100MF 20X 10V		
C 314	QK2025-155Z	ML C CAP I/M	1.5MF		
C 315	QK2025-155Z	ML C CAP I/M	1.5MF		
C 316	QK32AJ-103Z	PP CAPACITOR	0.010MF 5X 100V		
C 318	NCS21HK-103X	C CAPACITOR	0.010MF 10X 50V		
C 319	QK32AJ-821Z	TF CAPACITOR	820PF 5X 100V		
C 321	NCS21HK-103X	C CAPACITOR	-010MF 10X 50V		
C 322	QK32AJ-152Z	M CAPACITOR	1500PF 5X 100V		
C 331	QK41CM-476	E CAPACITOR	4.7MF 20X 16V		
C 351	QK41CM-106	E CAPACITOR	10MF 20X 10V		
C 371	QK41EM-475	E CAPACITOR	4.7MF 20X 25V		
C 374	QK41AM-107Z	E CAPACITOR	MOTOR 48		
C 375	QK41AM-107Z	E CAPACITOR	100MF 20X 10V		
C 376	NCS21HK-103X	C CAPACITOR	0.010MF 10X 50V		
CN 31	GGF120SF1-06	CONNECTOR	PRI/HEAD		
CN 32	QK60JM1-10	PWB CONNECTOR	PRI/MECHA		

BLOCK NO. 17			BLOCK NO. 18		
REF.	PARTS NO.	PARTS NAME	REMARKS	SUFFIX	
CN 33	GGF120SF1-09	CONNECTOR	PRI/MICON		
CN 34	GGF120SF1-10	CONNECTOR	PRI/AMP		
D 301	MA152WA-X	DIODE	S K DIODE		
D 302	MA706A-X	ZENER DIODE	ZENER DIODE		
D 375	MA3051/M-X	EF FLAT	HEAD SW		
FW 51	QUM024-06A2Z3	IC	PB&REC		
IC 31	BA3126N	IC			
IC 32	AN7517	IC			
IC 33	BU4094BCF-X	IC			
L 301	QGR0620-001	OSC COIL(BIAS)			
L 303	QGL01BK-100Z	INDUCTOR			
Q 101	DTG114TKA-X	TRANSISTOR	REC EQ CONT.		
Q 102	DTG114TKA-X	TRANSISTOR	REC EQ CONT.		
Q 201	DTG114TKA-X	TRANSISTOR	REC EQ CONT.		
Q 202	DTG114TKA-X	TRANSISTOR	REC EQ CONT.		
Q 301	DTG144EKA-X	TRANSISTOR			
Q 302	2SC2001/K/-T	TR I/M			
Q 303	2SC2001/K/-T	TR I/M			
Q 304	2SC2001/LK/-T	TRANSISTOR			
Q 305	2SC2001/LK/-T	TRANSISTOR			
Q 306	2SC2412K/RS/-X	CHIP TR.C.M			
Q 307	2SC2412K/RS/-X	CHIP TR.C.M			
Q 308	2SC2412K/RS/-X	CHIP TR.C.M			
Q 309	2SC2412K/RS/-X	CHIP TR.C.M			
Q 321	DTG144EKA-X	TRANSISTOR			
Q 371	2SC2412K/RS/-X	CHIP TR.C.M	MOTER+8		
Q 372	DTG124EKA-X	TRANSISTOR	SOLENOID DRIVE		
Q 375	2SB562/C/-T	TRANSISTOR			
Q 376	2SC2412K/RS/-X	CHIP TR.C.M			
R 101	NRS02J-220X	MG RESISTOR	22 5X 1/10W		
R 102	NRS02J-182X	MG RESISTOR	1.8K 5X 1/10W		
R 103	NRS02J-242NY	MG RESISTOR	2.4K 5X 1/10W		
R 104	NRS02J-122X	MG RESISTOR	1.2K 5X 1/10W		
R 105	NRS02J-104X	MG RESISTOR	100K 5X 1/10W		
R 106	NRS02J-332X	MG RESISTOR	3.3K 5X 1/10W		
R 107	NRS02J-123X	MG RESISTOR	12K 5X 1/10W		
R 108	NRS02J-562X	MG RESISTOR	5.6K 5X 1/10W		
R 109	NRS02J-122X	MG RESISTOR	1.2K 5X 1/10W		
R 110	NRS02J-472X	RES. C.M	4.7K 5X 1/10W		
R 111	NRS02J-333X	MG RESISTOR	33K 5X 1/10W		
R 112	NRS02J-222X	MG RESISTOR	2.2K 5X 1/10W		
R 113	NRS02J-472X	RES. C.M	4.7K 5X 1/10W		
R 114	NRS02J-272X	MG RESISTOR	2.7K 5X 1/10W		
R 116	NRS02J-102X	RES. C.M	1.0K 5X 1/10W		
R 121	NRS02J-102X	RES. C.M	1.0K 5X 1/10W		
R 201	NRS02J-220X	MG RESISTOR	22 5X 1/10W		
R 202	NRS02J-182X	MG RESISTOR	1.8K 5X 1/10W		
R 203	NRS02J-242NY	MG RESISTOR	2.4K 5X 1/10W		
R 204	NRS02J-122X	MG RESISTOR	1.2K 5X 1/10W		
R 205	NRS02J-104X	MG RESISTOR	100K 5X 1/10W		
R 206	NRS02J-332X	MG RESISTOR	3.3K 5X 1/10W		
R 207	NRS02J-123X	MG RESISTOR	12K 5X 1/10W		
R 208	NRS02J-562X	MG RESISTOR	5.6K 5X 1/10W		
R 209	NRS02J-122X	MG RESISTOR	1.2K 5X 1/10W		

BLOCK NO. 10000000

REF.	PARTS NO.	PARTS NAME	REMARKS	SUFFIX
R 210	NRS02J-472X	RES. C.M	4.7K 5X 1/10W	
R 211	NRS02J-333X	MG RESISTOR	33K 5X 1/10W	
R 212	NRS02J-222X	MG RESISTOR	2.2K 5X 1/10W	
R 213	NRS02J-472X	RES. C.M	4.7K 5X 1/10W	
R 214	NRS02J-272X	MG RESISTOR	2.7K 5X 1/10W	
R 216	NRS02J-102X	RES. C.M	1.0K 5X 1/10W	
R 221	NRS02J-102X	RES. C.M	1.0K 5X 1/10W	
R 301	NRS181J-221X	MG RESISTOR	220 5X 1/8W	
R 303	NRS02J-393X	MG RESISTOR	39K 5X 1/10W	
R 304	NRS181J-101X	MG RESISTOR	100 5X 1/8W	
R 305	NRS02J-222X	MG RESISTOR	2.2K 5X 1/10W	
R 306	NRS02J-222X	MG RESISTOR	2.2K 5X 1/10W	
R 310	NRS181J-560X	MG RESISTOR	56 5X 1/8W	
R 311	NRS181J-560X	MG RESISTOR	56 5X 1/8W	
R 313	NRS02J-3R3NY	RES. C.M	3.3 5X 1/10W	
R 314	NRS02J-223X	RES. C.M	22K 5X 1/10W	
R 315	NRS02J-100X	MG RESISTOR	10 5X 1/10W	
R 316	NRS02J-223X	RES. C.M	22K 5X 1/10W	
R 317	NRS02J-100X	MG RESISTOR	10 5X 1/10W	
R 319	NRS02J-152X	MG RESISTOR	1.5K 5X 1/10W	
R 322	NRS02J-152X	MG RESISTOR	1.5K 5X 1/10W	
R 327	NRS02J-474X	MG RESISTOR	470K 5X 1/10W	
R 332	NRS02J-123X	RES. C.M	12K 5X 1/10W	
R 333	NRS02J-123X	RES. C.M	12K 5X 1/10W	
R 335	NRS02J-152X	MG RESISTOR	1.5K 5X 1/10W	
R 336	NRS02J-472X	RES. C.M	4.7K 5X 1/10W	
R 337	NRS02J-332X	MG RESISTOR	3.3K 5X 1/10W	
R 338	NRS02J-392X	MG RESISTOR	3.9K 5X 1/10W	
R 339	NRS02J-222X	MG RESISTOR	2.2K 5X 1/10W	
R 340	NRS181J-391X	MG RESISTOR	390 5X 1/8W	
R 341	NRS02J-123X	RES. C.M	12K 5X 1/10W	
R 342	NRS02J-203X	MG RESISTOR	20K 5X 1/10W	
R 343	NRS02J-183X	MG RESISTOR	18K 5X 1/10W	
R 351	NRS02J-683X	MG RESISTOR	68K 5X 1/10W	
R 352	NRS02J-912X	RES. C.M	9.1K 5X 1/10W	
R 371	NRS02J-123X	RES. C.M	12K 5X 1/10W	
R 372	NRS02J-102X	RES. C.M	1.0K 5X 1/10W	
R 375	NRS02J-151X	MG RESISTOR	150 5X 1/10W	
R 376	NRS02J-472X	RES. C.M	4.7K 5X 1/10W	
VR 31	QVPO008-503Z	SEMI V RESISTOR	BIAS ADJ	
VR 32	QVPO008-503Z	SEMI V RESISTOR	BIAS ADJ	
VR 37	QVPO008-103Z	SEMI V RESISTOR	TAPE SPEED ADJ	

Packing Materials and Accessories Parts List

Block No. M 4 M M

Block No. M 5 M M

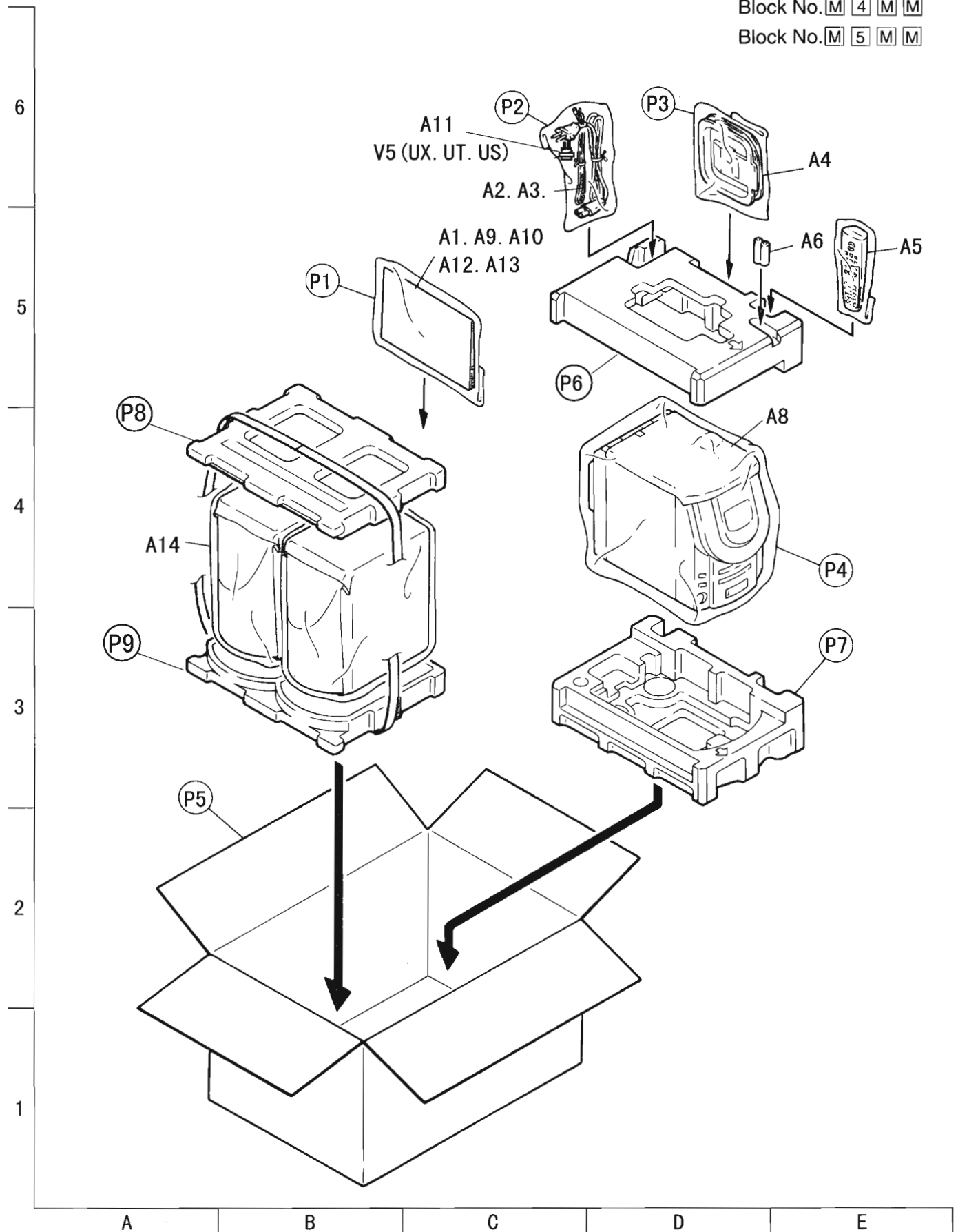

■ Packing Parts List

BLOCK NO.

△	REF.	PARTS NO.	PARTS NAME	REMARKS	QTY	SUFFIX	CLR
	P 1	QPA02503503P	POLY BAG	FOR INST	1		
	P 2	QPA01503503	POLY BAG	UB	1		
		QPA01202505	POLY BAG	FS-V5	1		
		QPA01202505	POLY BAG	UX/US/UF/UT	1		
	P 3	QPA01702503P	POLY BAG	FOR AM ANT	1		
	P 4	QPC05005015P	POLY BAG		1		
	P 5	LV30907-002A	CARTON	V5	1		
		LV30907-001A	CARTON	V3	1		
		LV30907-011A	CARTON	FS-V5	1		
	P 6	LV10182-001A	CUSHION(TOP)		1		
	P 7	LV10182-002A	CUSHION(BOTTOM)		1		
	P 8	LV20328-001A	SP CUSHION(TOP)		1		
	P 9	LV20329-001A	SP CUSHION(BOTT)		1		

■ Accessories Parts List

BLOCK NO.

△	REF.	PARTS NO.	PARTS NAME	REMARKS	QTY	SUFFIX	CLR
	A 1	LVT0212-001A	INST V5/V3 UB	CHI	1		
		LVT0212-001A	INST V5/V3 UX	ARA	1		
		LVT0212-001A	INST V5/V3 UT	CHI	1		
		LVT0212-001A	INST V5/V3 US	CHI	1		
		LVT0212-002A	INST V5/V3 UX	ARA	1		
		LVT0212-003A	INST V5 UF	CHI	1		
	A 2	LVT0214-001A	INST FS-V5 J	ENG SPA FRE	1		
		QMPE090-183-JD	POWER CORD	FS-V5	1		
		QMPL080-183-JC	POWER CORD	V5/V3 US	1		
		QMPS020-183-JC	POWER CORD	V5/UF	1		
	A 3	QMPS060-160-E2	POWER CORD	V5/V3 UX/UT	1		
		QMPP060-183-JD	POWER CORD	V5/V3 UB	1		
	A 4	EWP201-011	ANT WIRE	V5/V3	1		
	A 5	GAL0014-001	AM LOOP ANT		1		
		RM-RXUV3	REMOCON UNIT	V5/V3	1		
		RM-RXFSV5	REMOCON UNIT	FS-V5	1		
	A 6	-----	BATTERY		2		
	A 8	LV41088-001A	CAUTION SHEET		1		
	A 9	BT-52004-1	WARRANTY CARD	FS-V5	1		
		BT-59007-2	WARRANTY CARD	V3/UF	1		
		BT-51018-1	WARRANTY CARD	FS-V5	1		
	A 10	BT-20071B	SERVICE NETWORK	FS-V5	1		
		BT-59009-1	SERVICE NETWORK	V5/UF	1		
	A 11	V04062-001	AC PLUG	V5 UX/UT	1		
		V04062-002	AC PLUG	V5 US	1		
	A 12	BT-20044G	SAFETY SHEET	FS-V5	1		
	A 13	BT-51020-2	REGISTER CARD	FS-V5	1		
	A 14	UXV3K-SPBOX	SPEAKER BOX	V3	2		
		UXV5RK-SPBOX	SPEAKER BOX	V5 FS-V5	2		

UX-V3/UX-V5
UX-V5R/FS-V5

<<MEMO>>

<<MEMO>>

**UX-V3/UX-V5
UX-V5R/FS-V5**

JVC

VICTOR COMPANY OF JAPAN, LIMITED

AUDIO DIVISION, 10-1, 1Chome, Ohwatari-machi, Maebashi-city, 371-8543, Japan

(No.20752)

 Printed in Japan
9906 (O)