

Block diagram

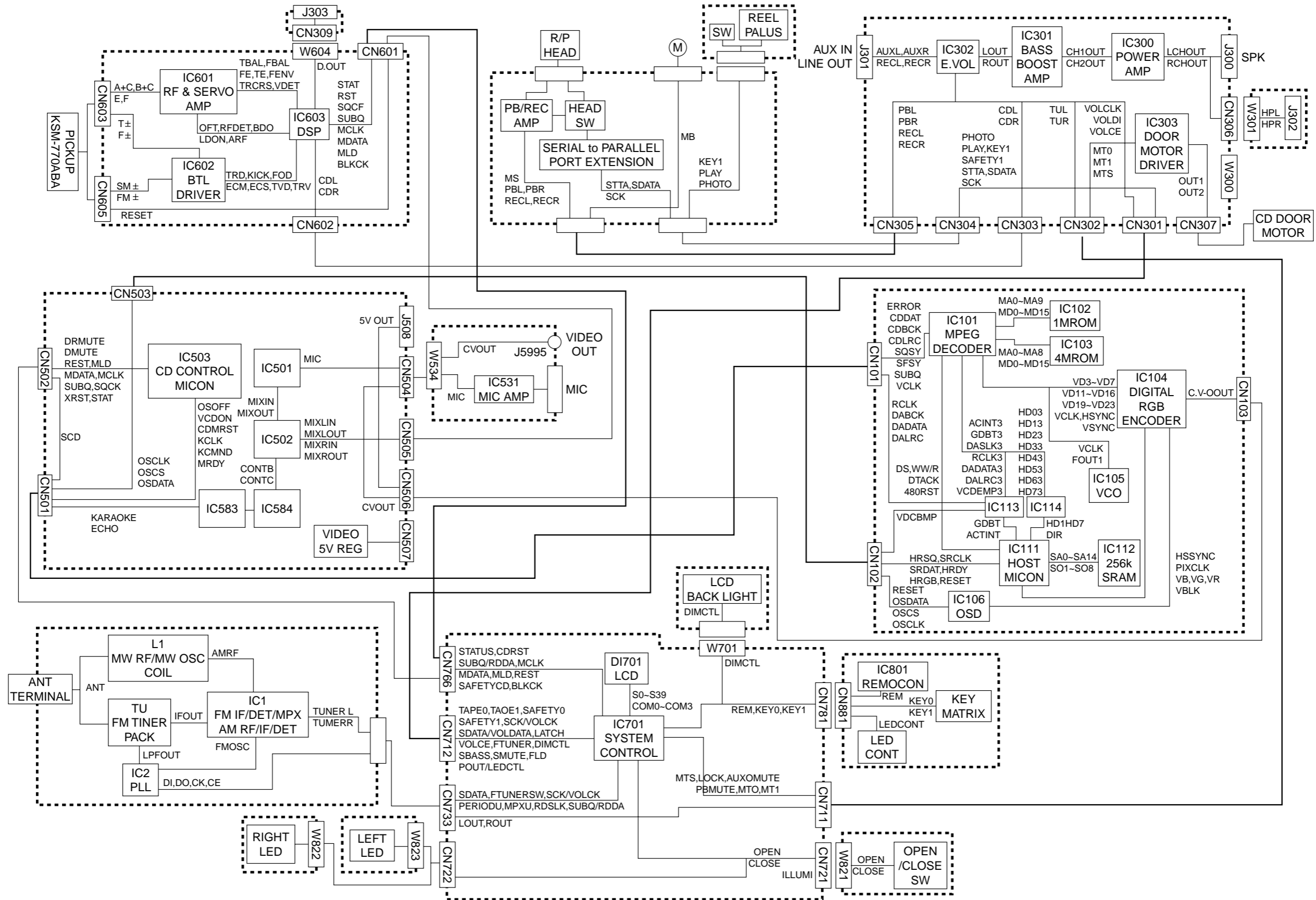

Standard schematic diagrams

■ CPU & LCD driver circuit

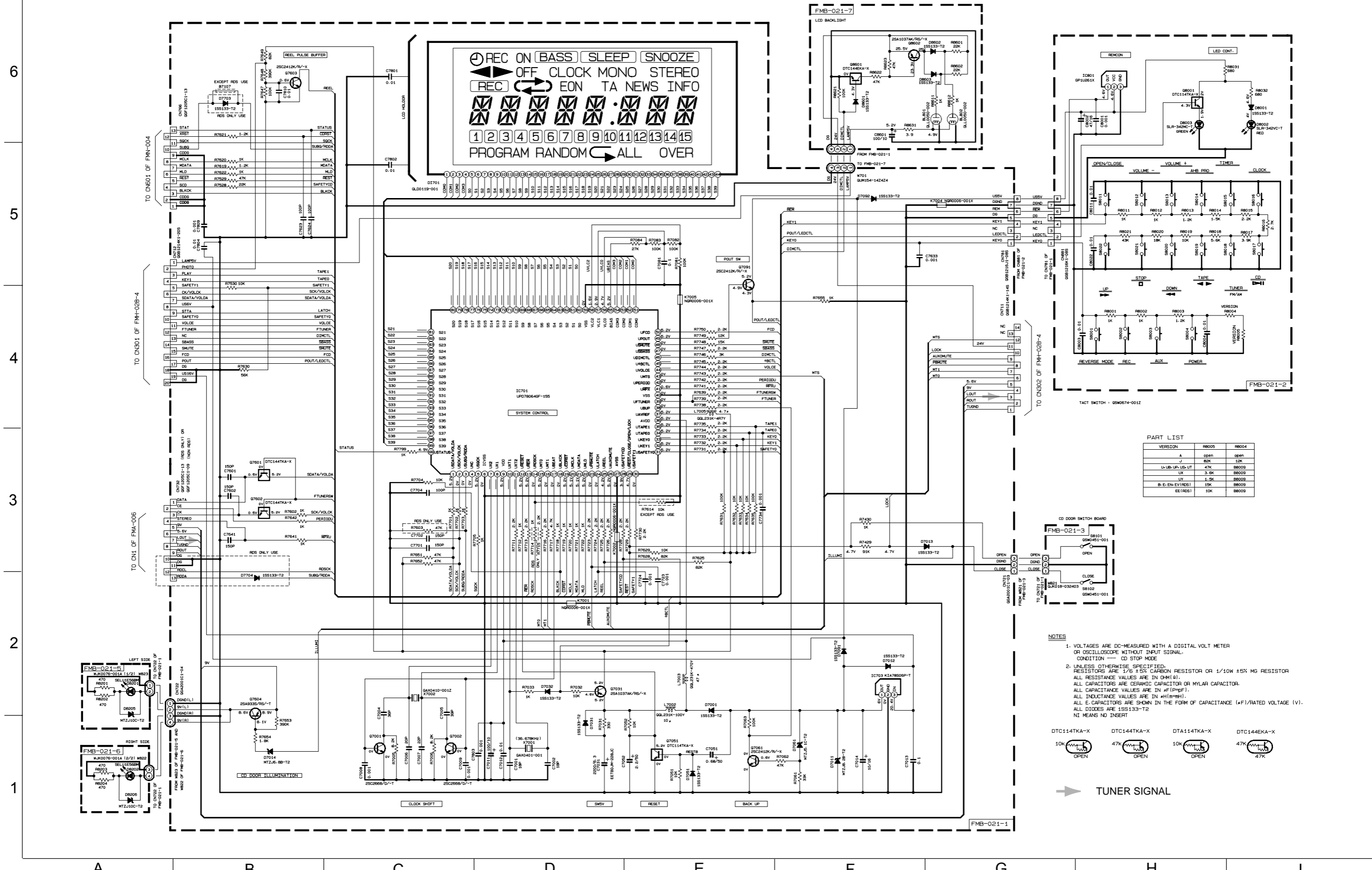

PART LIST

VERSION	R8005	R8004
A	open	open
J	80K	10K
U-LB, LB, LB-UT	47K	88009
U	3.3K	88009
UV	1.5K	88009
B-E, EN, EV, RDS1	15K	88009
EE (RDS)	10K	88009

- NOTES**
1. VOLTAGES ARE DC-MEASURED WITH A DIGITAL VOLT METER OR OSCILLOSCOPE WITHOUT INPUT SIGNAL. CONDITION — CD STOP MODE
 2. UNLESS OTHERWISE SPECIFIED, RESISTORS ARE 1/6 ± 5% CARBON RESISTOR OR 1/10W ± 5% MG RESISTOR. ALL RESISTANCE VALUES ARE IN OHM (Ω). ALL CAPACITORS ARE CERAMIC CAPACITOR OR MYLAR CAPACITOR. ALL CAPACITANCE VALUES ARE IN pF (pF). ALL INDUCTANCE VALUES ARE IN mH (mH). ALL E-CAPACITORS ARE SHOWN IN THE FORM OF CAPACITANCE (μF)/RATED VOLTAGE (V). ALL DIODES ARE 1SS133-T2. NI MEANS NO INSERT

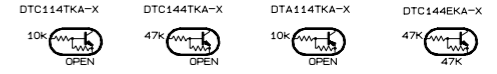

TUNER SIGNAL

■ CD servo circuit

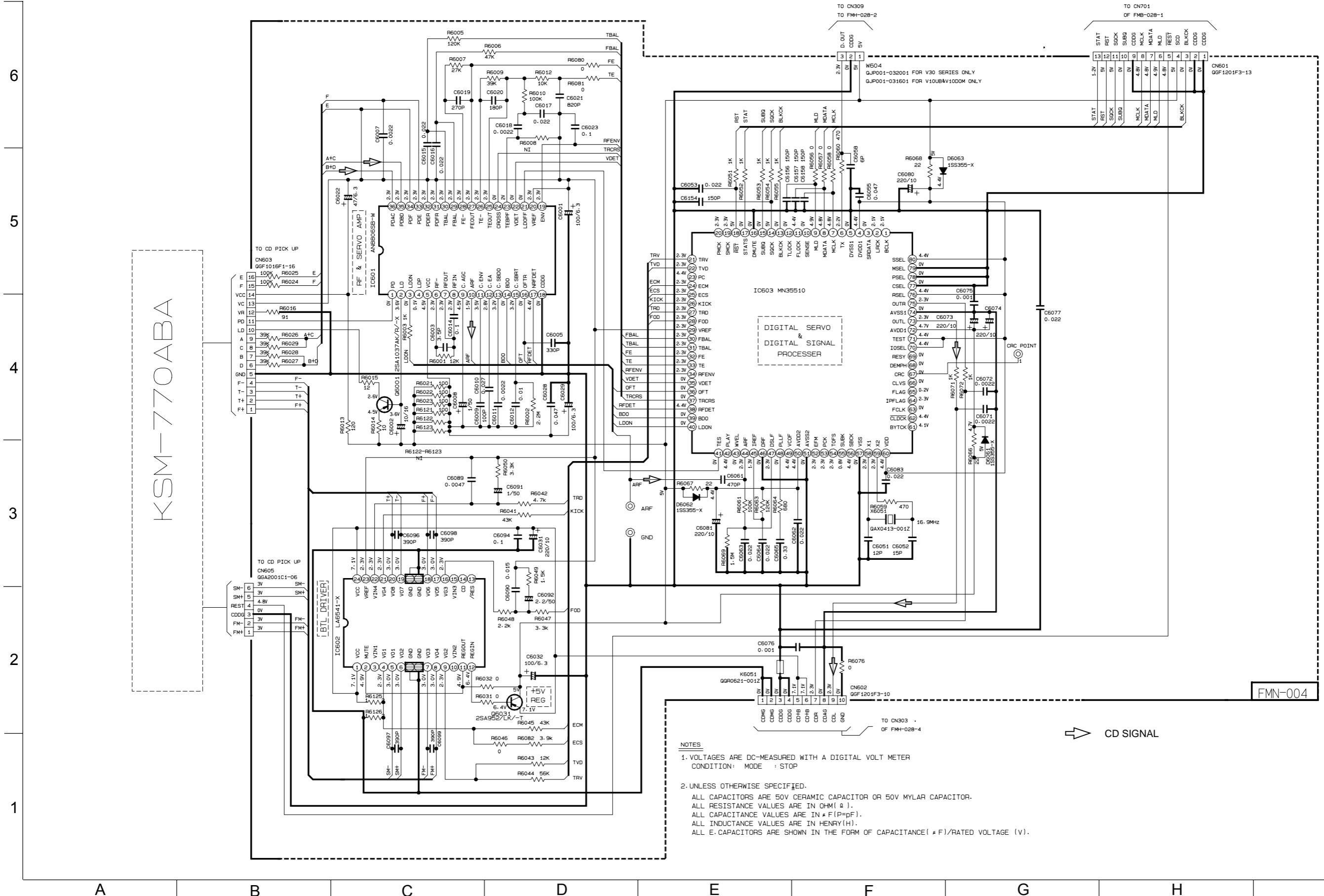

- NOTES**
1. VOLTAGES ARE DC-MEASURED WITH A DIGITAL VOLT METER
CONDITION: MODE : STOP
 2. UNLESS OTHERWISE SPECIFIED.
ALL CAPACITORS ARE 50V CERAMIC CAPACITOR OR 50V MYLAR CAPACITOR.
ALL RESISTANCE VALUES ARE IN OHM (Ω).
ALL CAPACITANCE VALUES ARE IN PICO (pF).
ALL INDUCTANCE VALUES ARE IN HENRY (H).
ALL E-CAPACITORS ARE SHOWN IN THE FORM OF CAPACITANCE (μF)/RATED VOLTAGE (V).

Power amplifier circuit

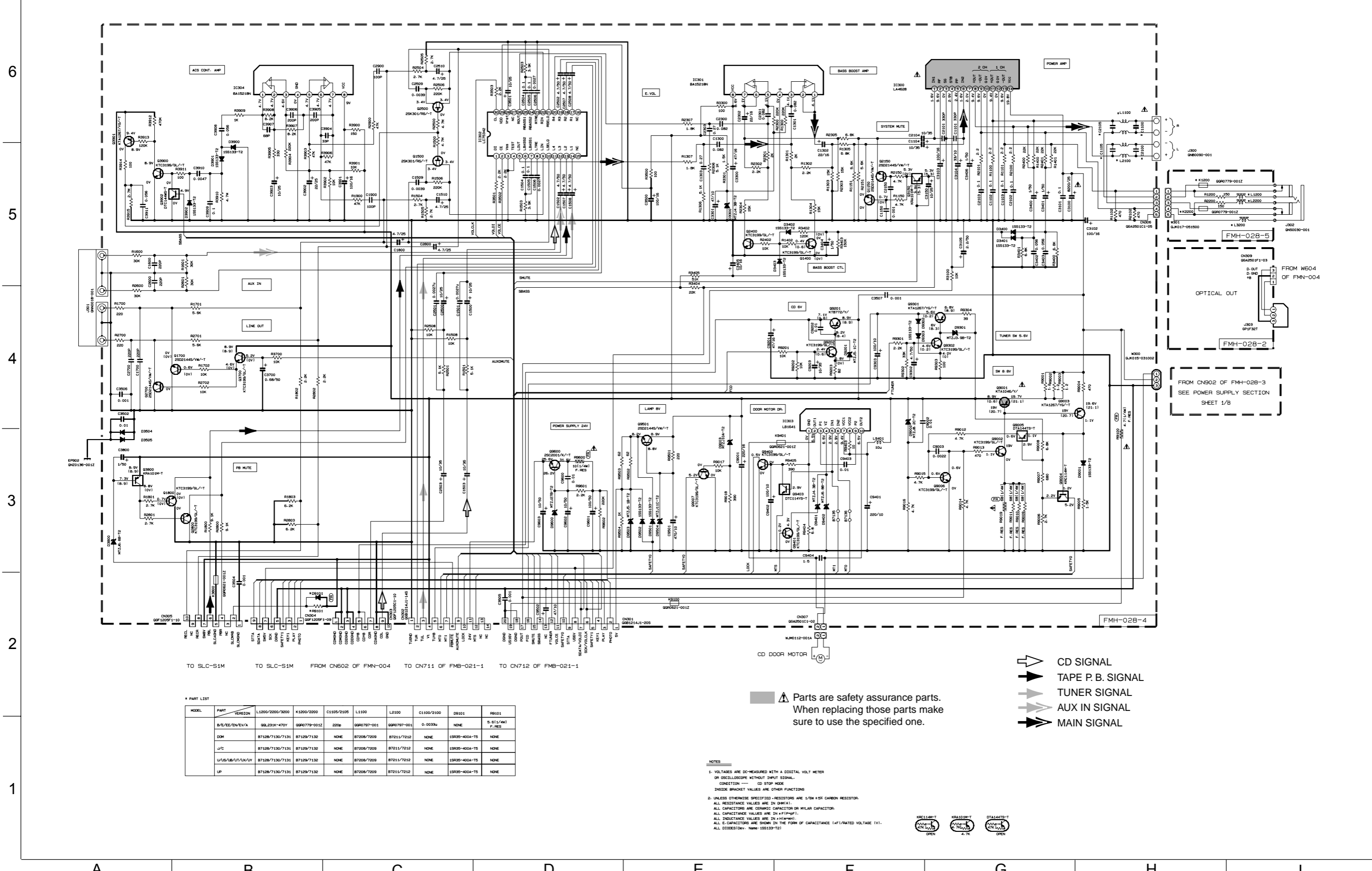

TO SLC-S1M TO SLC-S1M FROM CN602 OF FMN-004 TO CN711 OF FMB-021-1 TO CN712 OF FMB-021-1

* PART LIST

MODEL	PART	VERSION	L1800/2000/3000	K1200/200	C1105/2105	L1100	L2100	C1100/2100	D9101	R9101
B/E/IE/EN/EA/VA	Q9L231K-470Y	Q9P779-001Z	2206	Q9P797-001	Q9P797-001	0-0033v	NONE	5.011/4M F.HES		
DM	87128/7130/7131	87129/7132	NONE	87208/7209	87211/7212	NONE	15R35-400A-T5	NONE		
J/C	87128/7130/7131	87129/7132	NONE	87208/7209	87211/7212	NONE	15R35-400A-T5	NONE		
U/S/UB/UT/AU/UV	87128/7130/7131	87129/7132	NONE	87208/7209	87211/7212	NONE	15R35-400A-T5	NONE		
LP	87128/7130/7131	87129/7132	NONE	87208/7209	87211/7212	NONE	15R35-400A-T5	NONE		

NOTES
 1. VOLTAGES ARE DC-MEASURED WITH A DIGITAL VOLT METER OR OSCILLOSCOPE WITHOUT INPUT SIGNAL.
 CONDITION — CD STOP MODE
 INSIDE BRACKET VALUES ARE OTHER FUNCTIONS
 2. UNLESS OTHERWISE SPECIFIED, RESISTORS ARE 1/8W ±5% CARBON RESISTOR.
 ALL RESISTANCE VALUES ARE IN OHMS (Ω).
 ALL CAPACITANCE VALUES ARE IN pF (pF).
 ALL INDUCTANCE VALUES ARE IN mH (mH).
 ALL E-CAPACITORS ARE SHOWN IN THE FORM OF CAPACITANCE (μF)/RATED VOLTAGE (V).
 ALL DIODES (Dev. Name: 15S133-T2)



- ➡ CD SIGNAL
- ➡ TAPE P. B. SIGNAL
- ➡ TUNER SIGNAL
- ➡ AUX IN SIGNAL
- ➡ MAIN SIGNAL

⚠ Parts are safety assurance parts.
 When replacing those parts make sure to use the specified one.

■ Tuner circuit

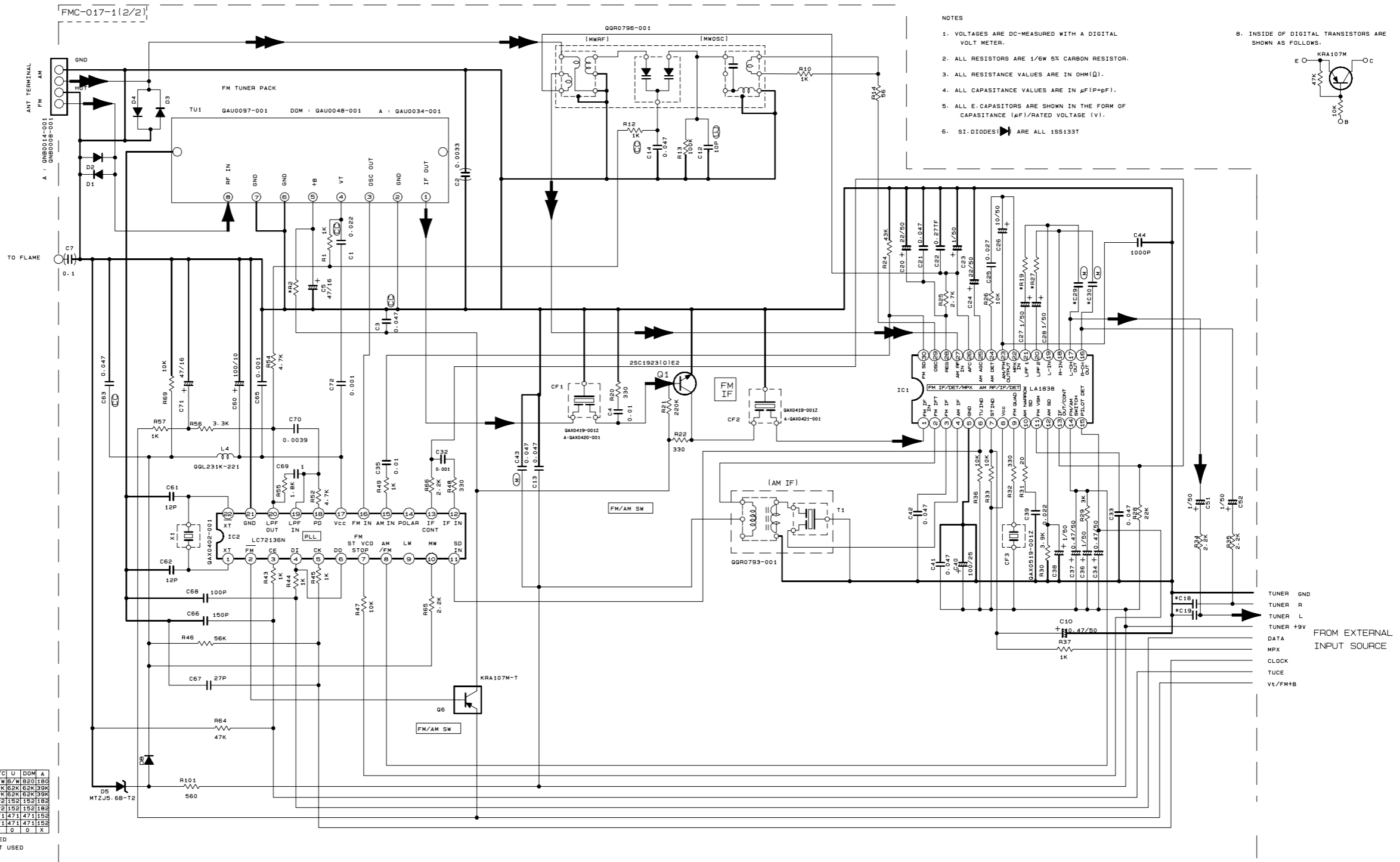

CONDITION	PIN NO.	1	2	3	4	5	6	7	8	9	10	11	12	13	14	15	16	17	18	19	20	21	22	23	24	25	26	27	28	29	30
IC1	FM NO SIGNAL	3.5	9.1	3.5	3.5	0.4	7.0	6.4	9.1	0	1.3	0.3	0.5	0.8	B	B	4.3	4.3	4.3	4.3	3.2	3.2	2.8	3.5	0	0	3.4	3.4	3.6	3.6	2.3
	FM 60dB STEREO	3.5	9.1	3.5	3.5	0	0	0.2	9.1	2.3	1.3	4.3	0	0.8	B	B	4.3	4.3	4.3	4.3	3.2	3.2	2.8	3.1	0	0	3.6	3.6	3.6	3.6	2.3
IC2	FM NO SIGNAL	3.5	9.1	3.5	3.5	0	9.1	6.4	9.1	2.7	1.3	0	0	0.8	0.1	5.6	4.2	4.2	4.2	4.2	3.2	3.2	2.8	2.9	0.6	0.5	3.5	3.5	3.5	2.1	
	AM NO SIGNAL	2.4	0	0	5.6	4.9	5.6	B	B	3.6	3.8	B.4	0	0	0	0	2.4	4.9	0.7	0.7	7.2	0	2.6								

Tr NO.	Q1	Q6
PIN NO.	E C B E C B	
FM 87.5MHz NO SIGNAL	0 7.4 0.8 8.4 8.3 0	
AM 522kHz NO SIGNAL	0 0 0 8.5 0 8.4	

Tr NO.	Q2	Q3	Q4
PIN NO.	E C B E C B E C B		
AM 522kHz NO SIGNAL	3.5 3.5 0.3 0 0 0.7 0 0 0.7		
AM 144kHz NO SIGNAL	3.5 3.5 3.5 0 0 0.1 0 0 0.1		

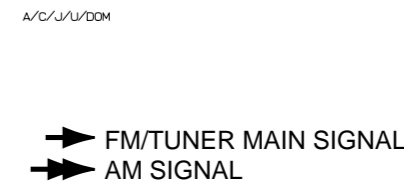

A B C D E F G H I

■ Cassette mecha control circuit

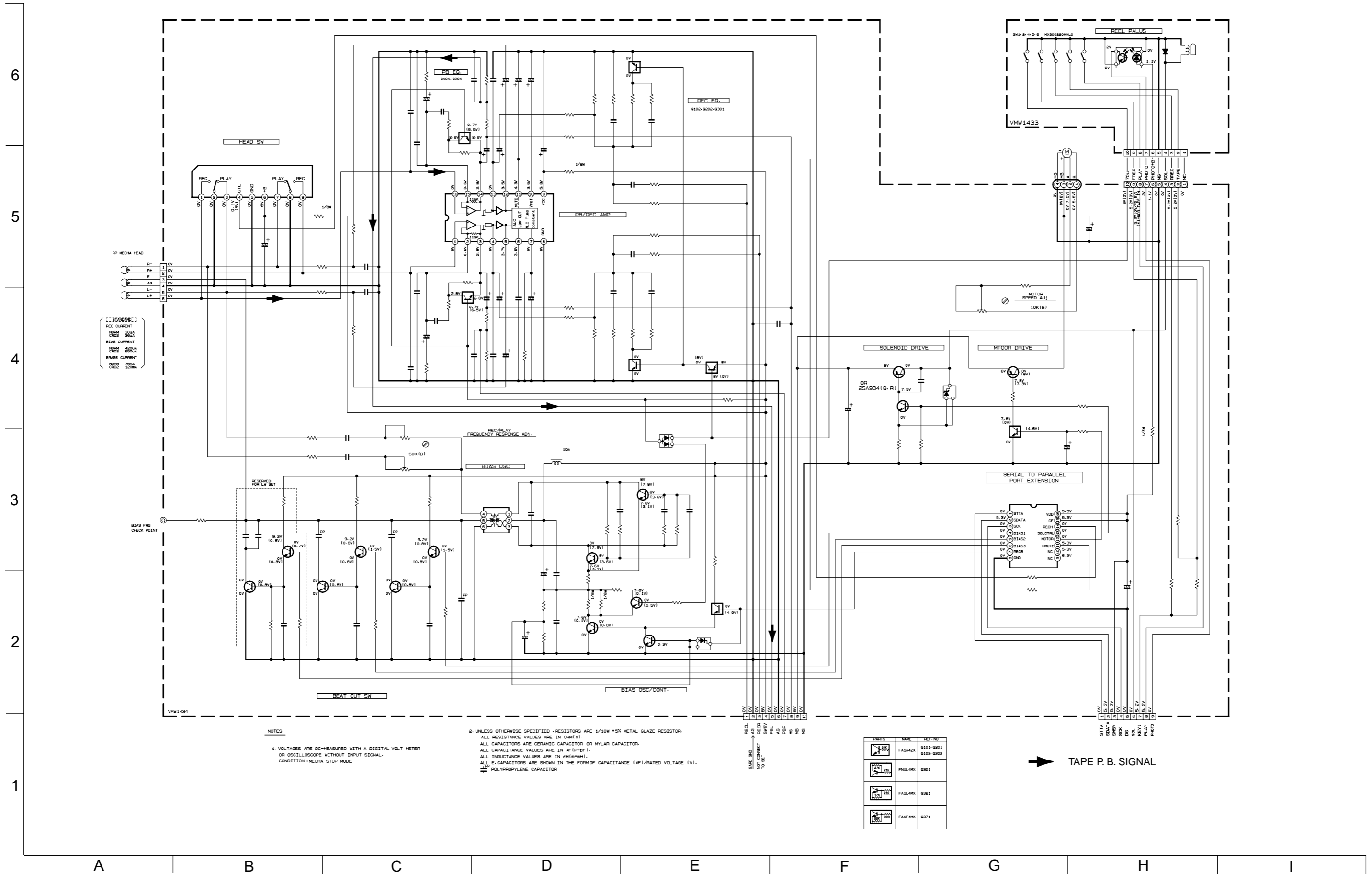

[[STANDARD]]
REC CURRENT
NOM 100mA
DC22 500A
BIAS CURRENT
NOM 400mA
DC22 2500A
ERASE CURRENT
NOM 100mA
DC22 1200A

NOTES
1. VOLTAGES ARE DC-MEASURED WITH A DIGITAL VOLT METER OR OSCILLOSCOPE WITHOUT INPUT SIGNAL. CONDITION: MECHA STOP MODE

2. UNLESS OTHERWISE SPECIFIED, RESISTORS ARE 1/10W ±5% METAL GLAZE RESISTOR. ALL RESISTANCE VALUES ARE IN OHM(Ω). ALL CAPACITORS ARE CERAMIC CAPACITOR OR MYLAR CAPACITOR. ALL CAPACITANCE VALUES ARE IN #F(#P#PF). ALL INDUCTANCE VALUES ARE IN #H(#MH#H). ALL E-CAPACITORS ARE SHOWN IN THE FORM OF CAPACITANCE (#F)/RATED VOLTAGE (V). POLYPROPYLENE CAPACITOR

PARTS	NAME	REF. NO
	FA1A4Z	0101-0201 0102-0202
	FN1L4K	0301
	FA1L4K	0302
	FA1F4K	0301

➔ TAPE P. B. SIGNAL

■ Power supply circuit

■ Video control circuit

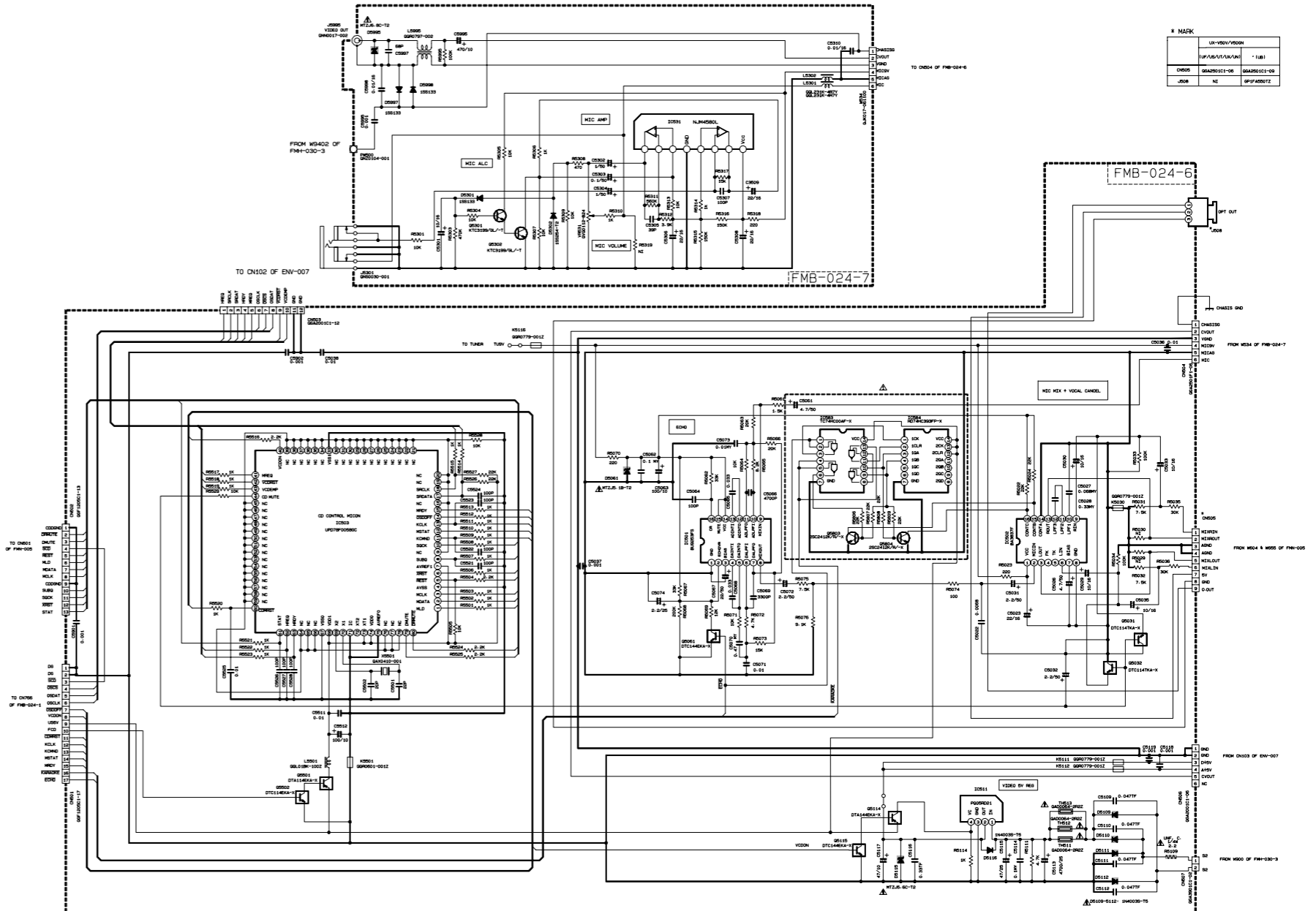
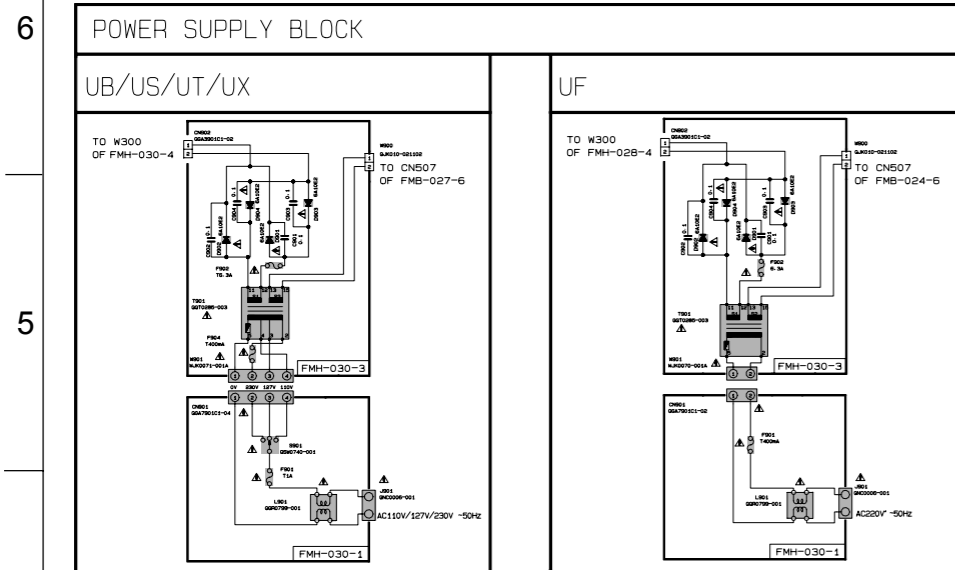

EXPLANATION OF OVERALL OF SCHEMATIC

MODEL : UX-V50GN/UX-V50V

MARK NUMBER	MODEL NUMBER TO BE APPLIED	CIRCUITS DESCRIPTION
1/8	UX-V50GN/UX-V50V	PRIMARY WITH MAINS TRANSFORMER
2/8	UX-V50GN/UX-V50V	DC REGULATORS/AUDIO OUTPUT EXTERNAL INPUT, SOURCE SELECTOR SWITCH
3/8	UX-V50GN/UX-V50V	LCD DISPLAY/SYSTEM CONTROL/USERS KEY CONTROL
4/8	UX-V50GN/UX-V50V	CD SERVO AND CD SYSTEM CONTROL, CD CHANGER MECHANISM CONTROL
5/8	UX-V50GN/UX-V50V	TAPE DECK MECHANISM CONTROL, TAPE CIRCUITS SUCH AS PRE-AMP AND BIAS
6/8	UX-V50GN/UX-V50V	TUNER RF/IF/PM MULTIPLEX
7/8	UX-V50GN/UX-V50V	MIC AMP, ECHO, MIC MIX CIRCUIT, CD CONTROL MICOM CIRCUIT
8/8	UX-V50GN/UX-V50V	VIDEO CONTROL CIRCUIT

NOTE : MARK(1) IS TO SHOW DEVIATION IN VERSIONS. DETAILS ARE EXPLAINED NEAR MARK.

VERSION CODES

UT	TAIWAN
UX	SARAJEVO
UF	CHINA
US	HONG KONG
UB	SINGAPORE AND UNIVERSAL EXCEPT ALL OF ABOVE

▲ Parts are safety assurance parts. When replacing those parts make sure to use the specified one.

NOTES 1: VOLTAGES ARE DC-MEASURED WITH A DIGITAL VOLT METER OR OSCILLOSCOPE WITHOUT INPUT SIGNAL. CONDITION — CD STOP MODE.

2: UNLESS OTHERWISE SPECIFIED, ALL RESISTORS ARE 1/10W 5%K METAL GLAZE RESISTOR. ALL CAPACITORS ARE CERAMIC CAPACITOR OR NYLON CAPACITOR. ALL RESISTANCE VALUES ARE IN OHM(S). ALL CAPACITANCE VALUES ARE IN P(F) OR μ(F). ALL INDUCTANCE VALUES ARE IN MH(MH). ALL E-CAPACITORS ARE SHOWN IN THE FORM OF CAPACITANCE(μF)/RATED VOLTAGE (V).

▲ Parts are safety assurance parts. When replacing those parts make sure to use the specified one.

Video CD control circuit

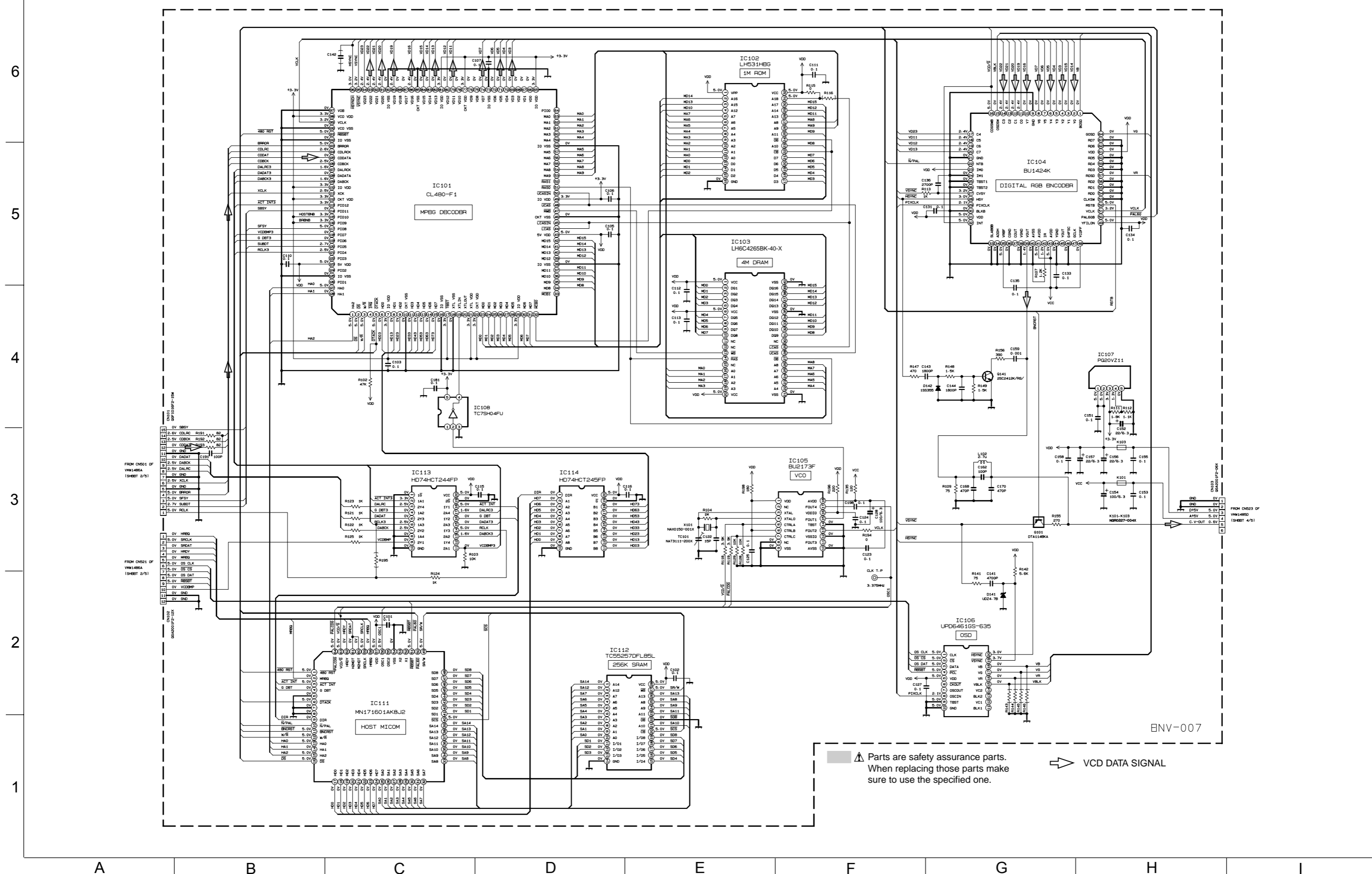

▲ Parts are safety assurance parts. When replacing those parts make sure to use the specified one. ➡ VCD DATA SIGNAL

ENV-007

Printed circuit boards

■ Main board

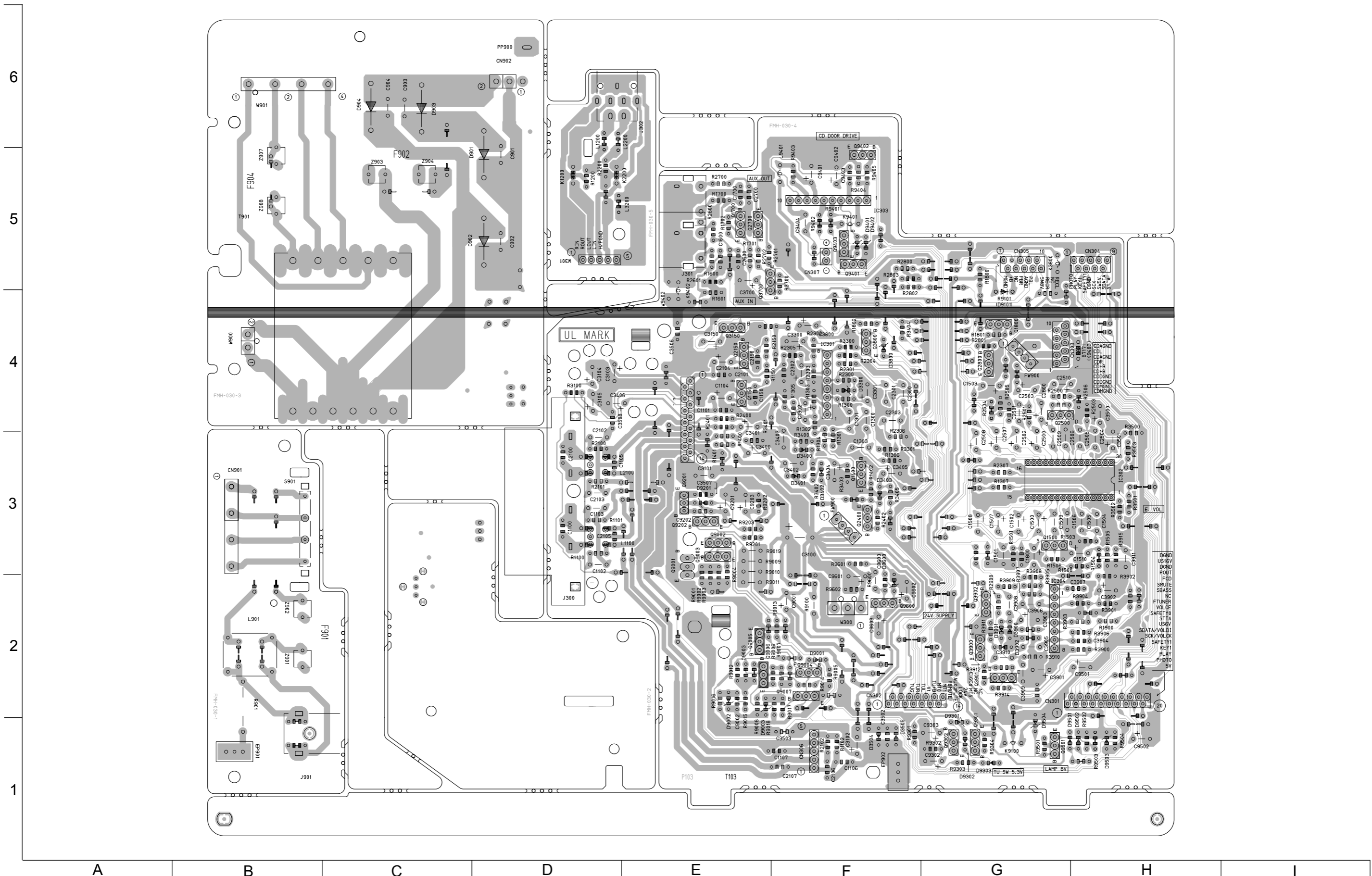

■ Micon P. C. board

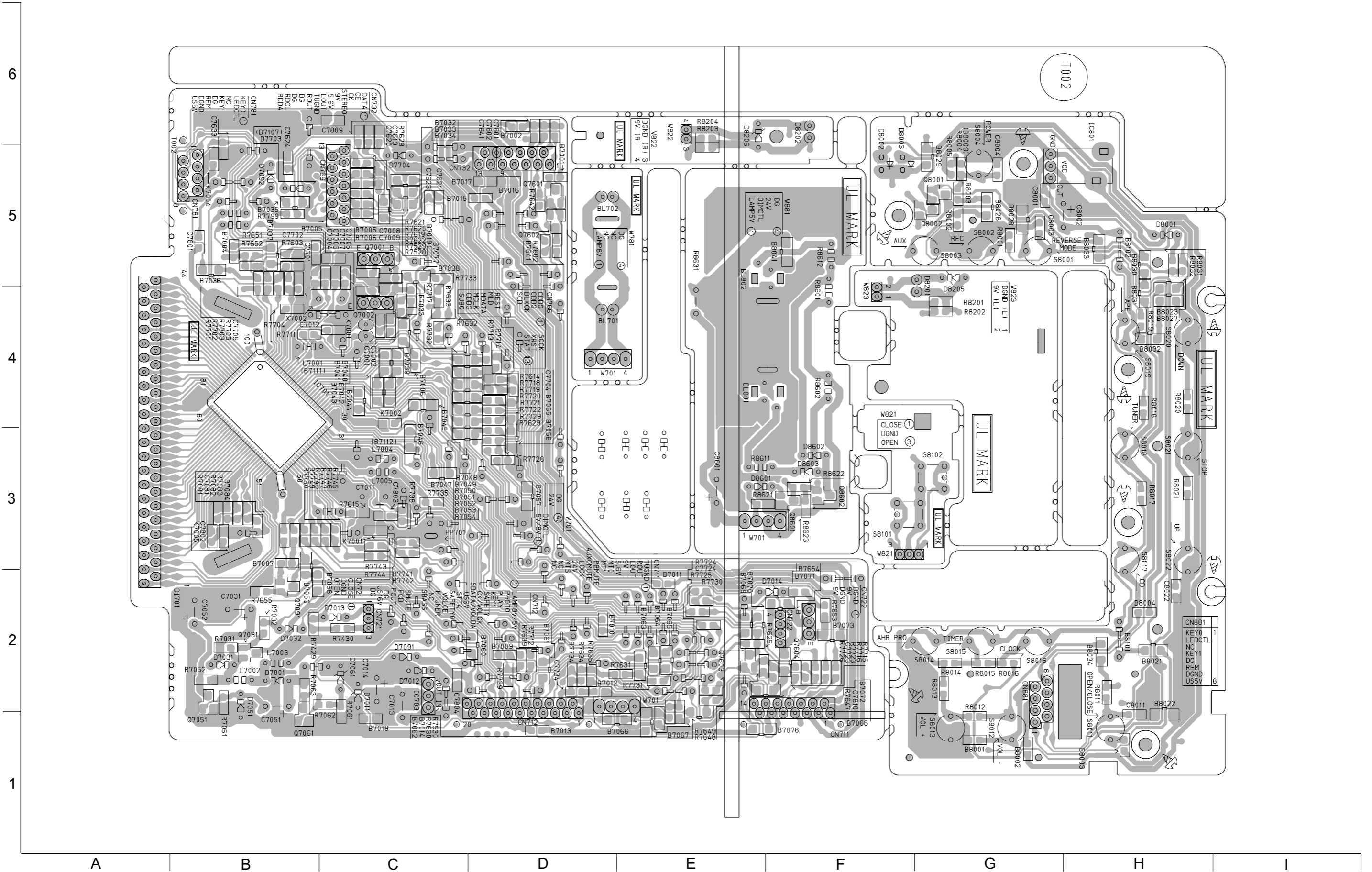

■ CD board

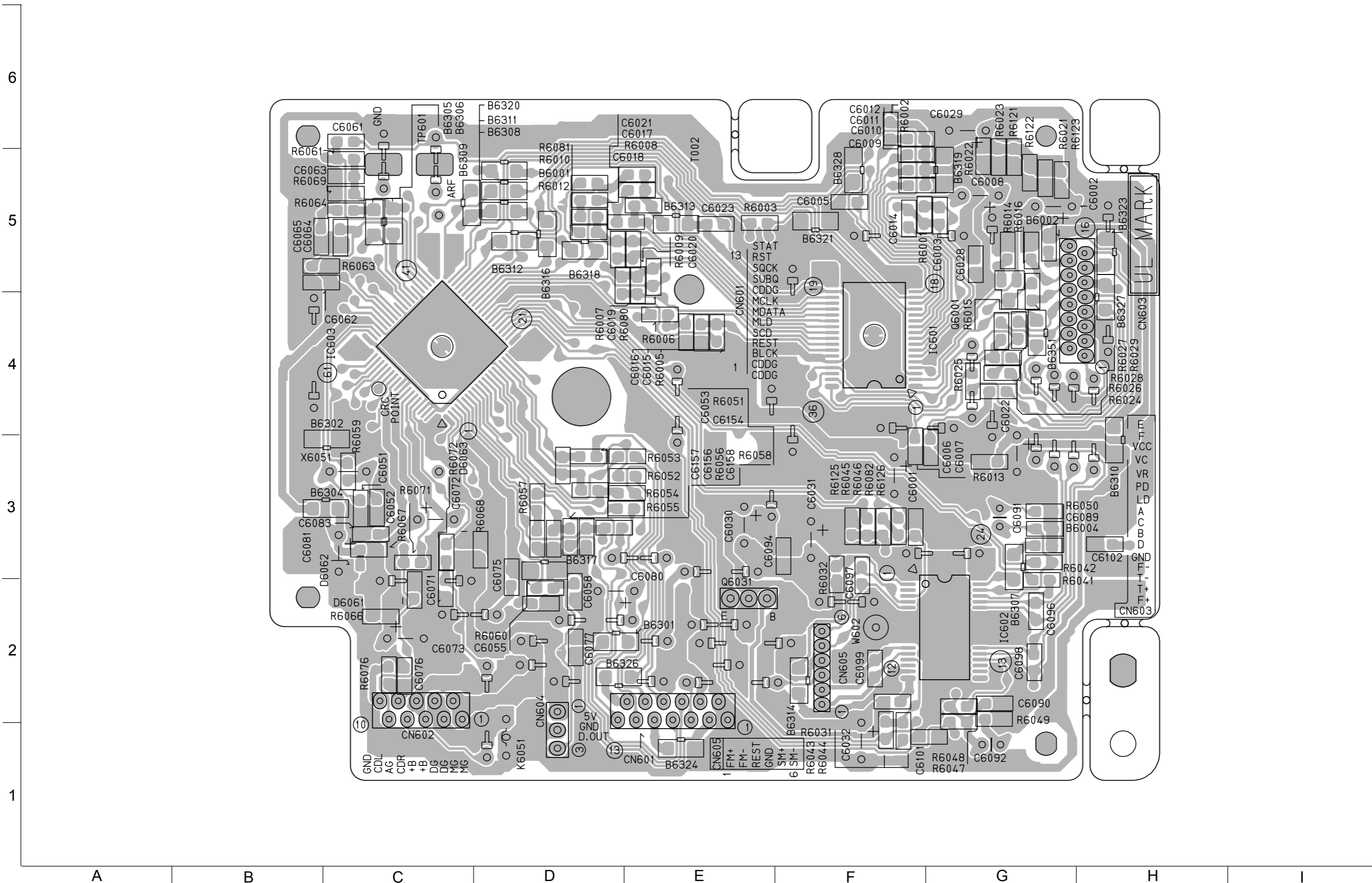

■ Tuner P. W. B

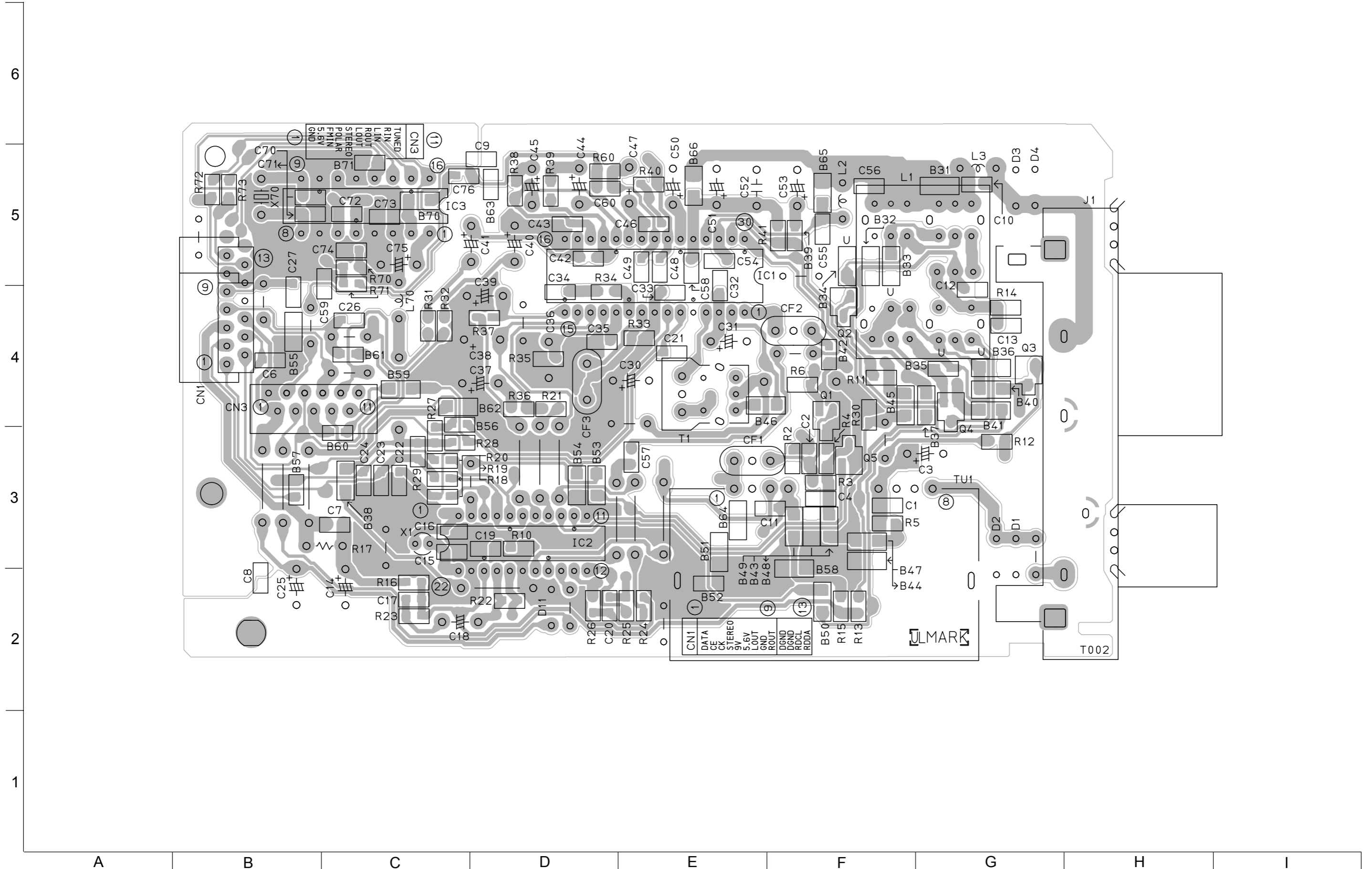

■ VCD board (reverse side)

■ VCD board (forward side)

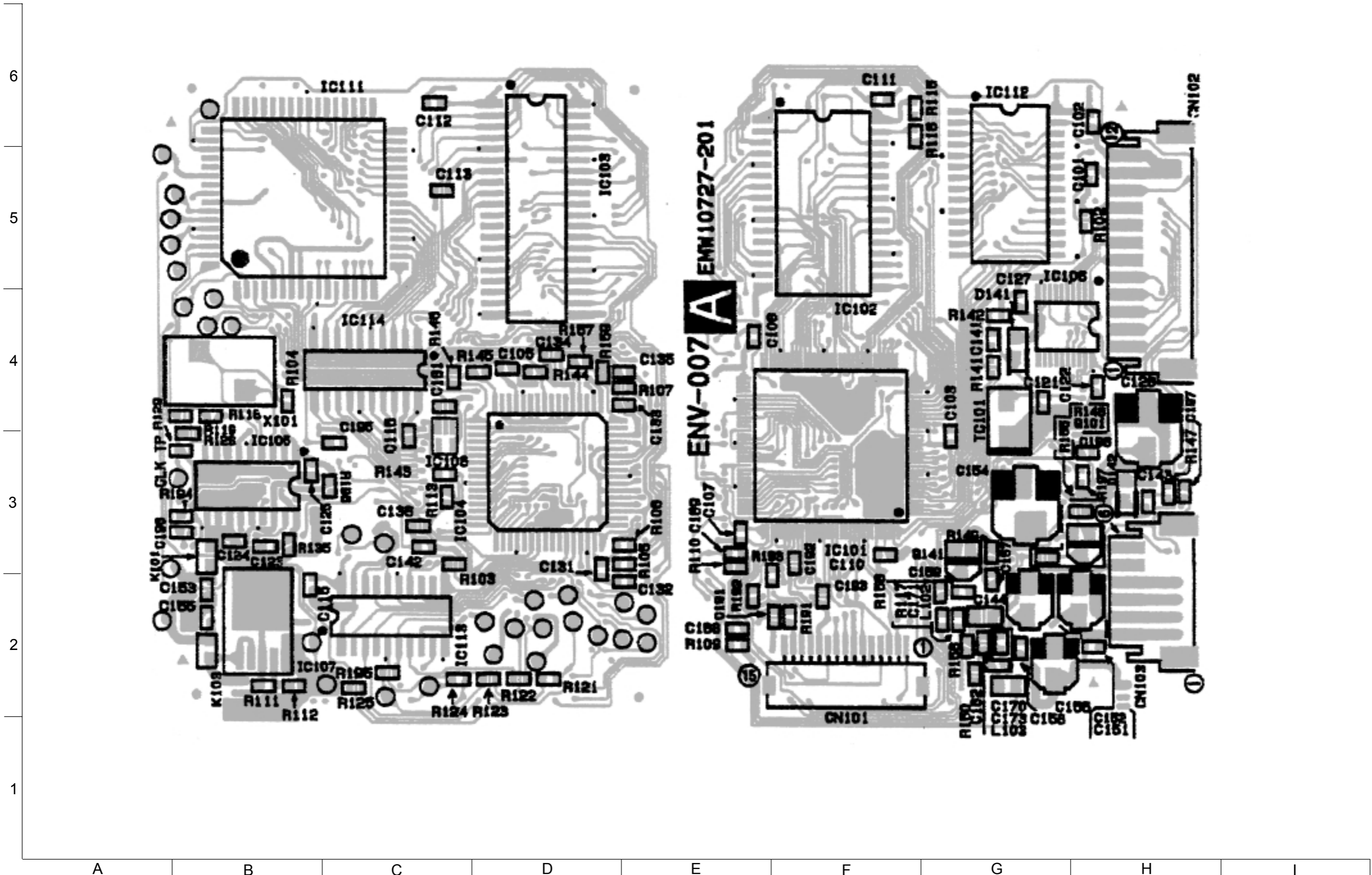

UX-V50V
UX-V50GN

UX-V50V
UX-V50GN

<<MEMO>>