

AR-404/KRF-A4030/ A4030E/A4030-S SERVICE MANUAL

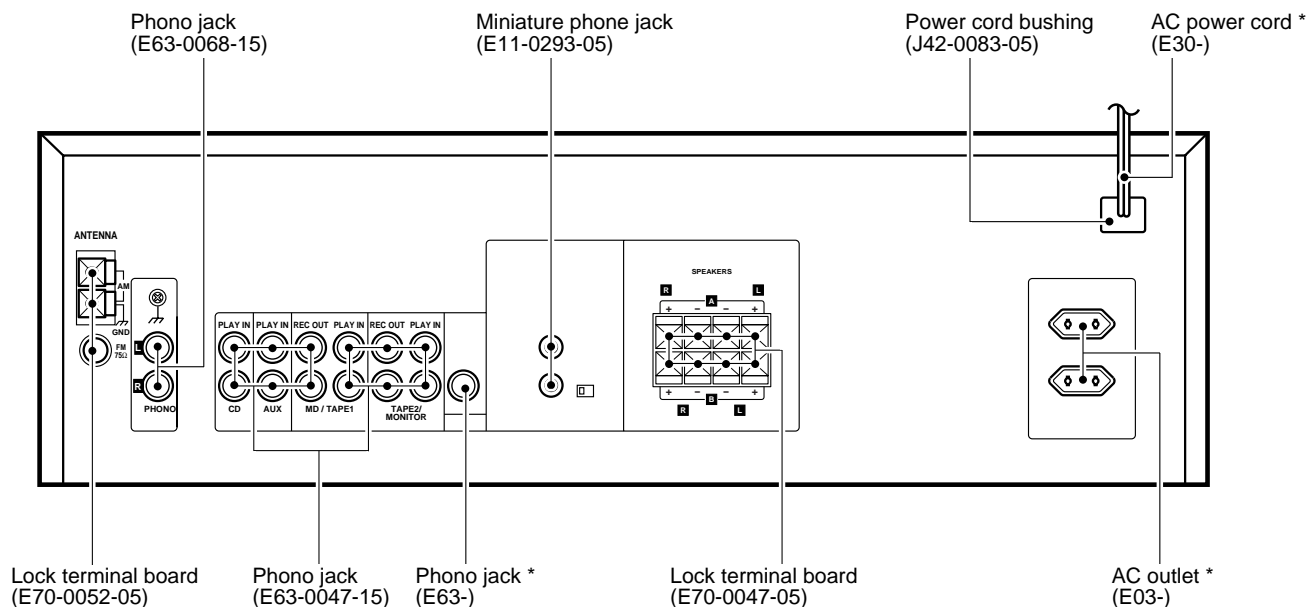

* Refer to parts list on page 21 .

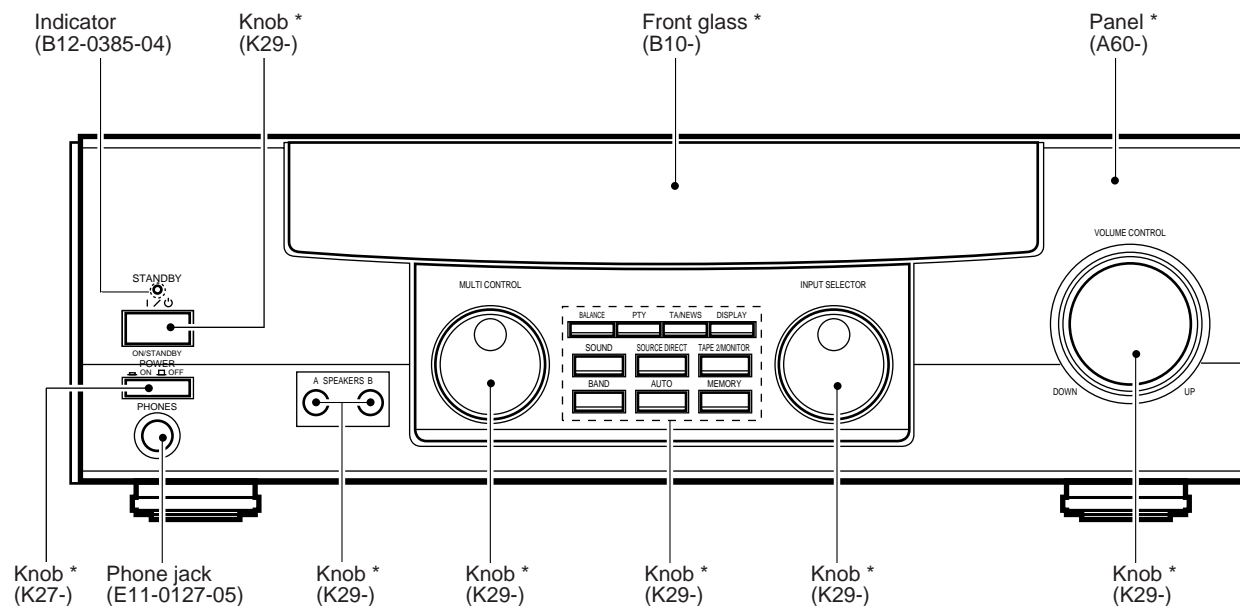

AR-404/KRF-A4030/A4030E/A4030-S

CONTENTS / ACCESSORIES / CAUTIONS

Contents

CONTENTS / ACCESSORIES / CAUTIONS.....	2	SCHEMATIC DIAGRAM	11
CIRCUIT DESCRIPTION	3	EXPLODED VIEW	20
ADJUSTMENT	6	PARTS LIST.....	21
PC BOARD	7	SPECIFICATIONS	27

Accessories

FM indoor antenna (1)
(T90-0836-05)

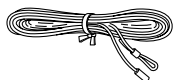

AM loop antenna (1)
(T90-0852-05)

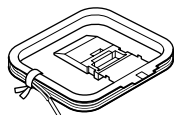

Batteries (R06/AA) (2)

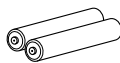

AC plug adaptor (1)
(E03-0115-05)

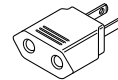

*Use to adapt the plug on the power cord to the shape of the wall outlet. (Accessory only for regions where use is necessary.)

Remote control unit (1)
(A70-1266-05): RC-R0709.....KPMX
(A70-1267-05): RC-R0708.....E1E2E3

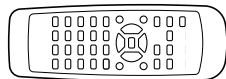

Cautions

Resetting the Microcomputer

If the microcomputer may malfunction (unit cannot be operated, or shows an erroneous display) if the power cord is unplugged while the power is ON, or due to some other external factor. If this happens, execute the following procedure to reset the microcomputer and return the unit to its normal operating condition.

For U.S.A. and Canada

Unplug the power cord from the wall outlet, then plug it back in while holding down the POWER key.

Except for U.S.A. and Canada

With the power cord plugged in, turn the POWER key OFF. Then, while holding down the ON/STANDBY key, press the POWER key.

- Please note that resetting the microcomputer will clear the contents of the memory and returns the unit to the state it was in when it left the factory.

CIRCUIT DESCRIPTION

1. BACK UP DATA AND INITIAL STATE

1-1 BACK UP

(1) AMP

- POWER.....STANDBY
- INPUT SELECTORTUNER
- BALANCECENTER
- SPEAKER A RELAYON
- SPEAKER B RELAYOFF
- VOLUME LEVEL..... -66dB
- BASS LEVEL.....0dB
- TREBLE LEVEL.....0dB
- INPUT LEVEL.....0dB
- SOURCE DIRECT.....OFF
- TAPE2/MONITOR.....OFF

(2) TUNER

- BANDFM
- PRESET CHANNEL....."--"
- FREQUENCY.....LOWER LIMIT VALUE
 - K1.....FM:87.50MHz
AM:530kHz
 - E1/E3.....FM:87.50MHz
AM:531kHz
- AUTO/MANUALAUTO
- DISPLAY MODEFREQUENCY
- E ON THRUST RECEIVINGOFF
MODE
- T1 VOLUME.....OFF(-66dB)

1-2 INITIAL SETTING

The initial setting is performed when the AC power cord is plugged into the AC power wall out let while pressing the power (STANDBY) key.

2. DESTINATION LIST OF TUNER

DESTINATION	TUNER TYPE	BAND	RECEIVING FREQUENCY RANGE	CHANNEL SPACE	IF	PLL REFERENCE FREQUENCY	DSW3 (D507)	DSW2 (D505)	DSW1 (D504)	DSW0 (D510)
K,P	K1(1700)	FM AM	87.5MHz~108.0MHz 530kHz~1700kHz	100kHz 10kHz	+10.7MHz +450kHz	25kHz 10kHz	0	0	0	0
M,X	E1	FM AM	87.5MHz~108.0MHz 531kHz~1602kHz	50kHz 9kHz	+10.7MHz +450kHz	25kHz 9kHz	0	0	1	1
M	K2(1600)	FM AM	87.5MHz~108.0MHz 530kHz~1610kHz	100kHz 10kHz	+10.7MHz +450kHz	25kHz 10kHz	0	0	0	1
E	E3 RDS	FM AM	87.5MHz~108.0MHz 531kHz~1602kHz	50kHz 9kHz	+10.7MHz +450kHz	25kHz 9kHz	0	1	0	1

DSW0-DSW3(DIODE SW) * 0: NONE DIODE,1:ADD DIODE

3. TEST MODE

3-1 SETTING

Turn the power ON while pressing the [BAND] key.

3-2 CANCELLATION

Unplug the AC power cord from an AC power wall outlet.

3-3 STARTING ACTIVE CONTENTS

- The power on state is entered whenever the power is trued on while pressing the [BAND] key.
- All functions are initialized and activated in the all lighting mode.
- All lighting mode is canceled when any main unit's keys are pressed. The normal display obtained when the selector is set to TUNER then appears.
- E2PROM check(Etype only).

Check the reading data and the writing data of the E2PROM after setting the test mode.

Display shows blank if the reading data and writing data are the same. Display shows "LW" if the different data will be written to E2PROM.

3-4 ACTIVE CONTENTS

- The mute control is not activated when the mode is switched.
- The test mode will be terminated by plugging it off the power source or by initializing it when all the settings will be initialized.

- During the test mode, it can be operated in a special manner that is deferent from an ordinary operation by using the keys on the remote control or the main body ,specifically as shown in the following table (3-5 CONTENTS).
- Channel space will be no changed in the test mode.

3-5 CONTENTS

3-5-1 TUNER FUNCTION

WITH THE SELECTOR ON TUNER (E TYPE ONLY)

OPERATION KEY	FUNCTION	FL DISPLAY	REMARKS
PTY	S LEVEL RF ATT	(EX.) (1)(SLEVEL), (RF ATT)OFF (2)(SLEVEL), (RF ATT)ON (3)(NORMAL), (RF)ATT OFF	(1) ↙ ↘ (2) ← (3) CYCLE
DISPLAY	P.CALL UP	P.CALL FREQUENCY	-
TA/NEWS	PI CODE	PI 0000	PI CODE ON/OFF

3-5-2 AMP FUNCTION

WITH THE SELECTOR ON SOMETHING OTHER THAN TUNER

- One touch max,min setting for Audio level.

KEY	MASTER VR.	SOUND KEY	
		BASS	TREBLE
BAND	-89dB	0dB	+10dB
AUTO	0dB	0dB	+10dB
MEMORY	-10dB	0dB	+10dB

Bass and treble are selected while the sound key is pressed.

AR-404/KRF-A4030/A4030E/A4030-S

CIRCUIT DESCRIPTION

4. Microprocessor CXP82840-163Q, CXP82832-162Q (X09, IC51)

4-1 Microprocessor periphery block diagram diagram

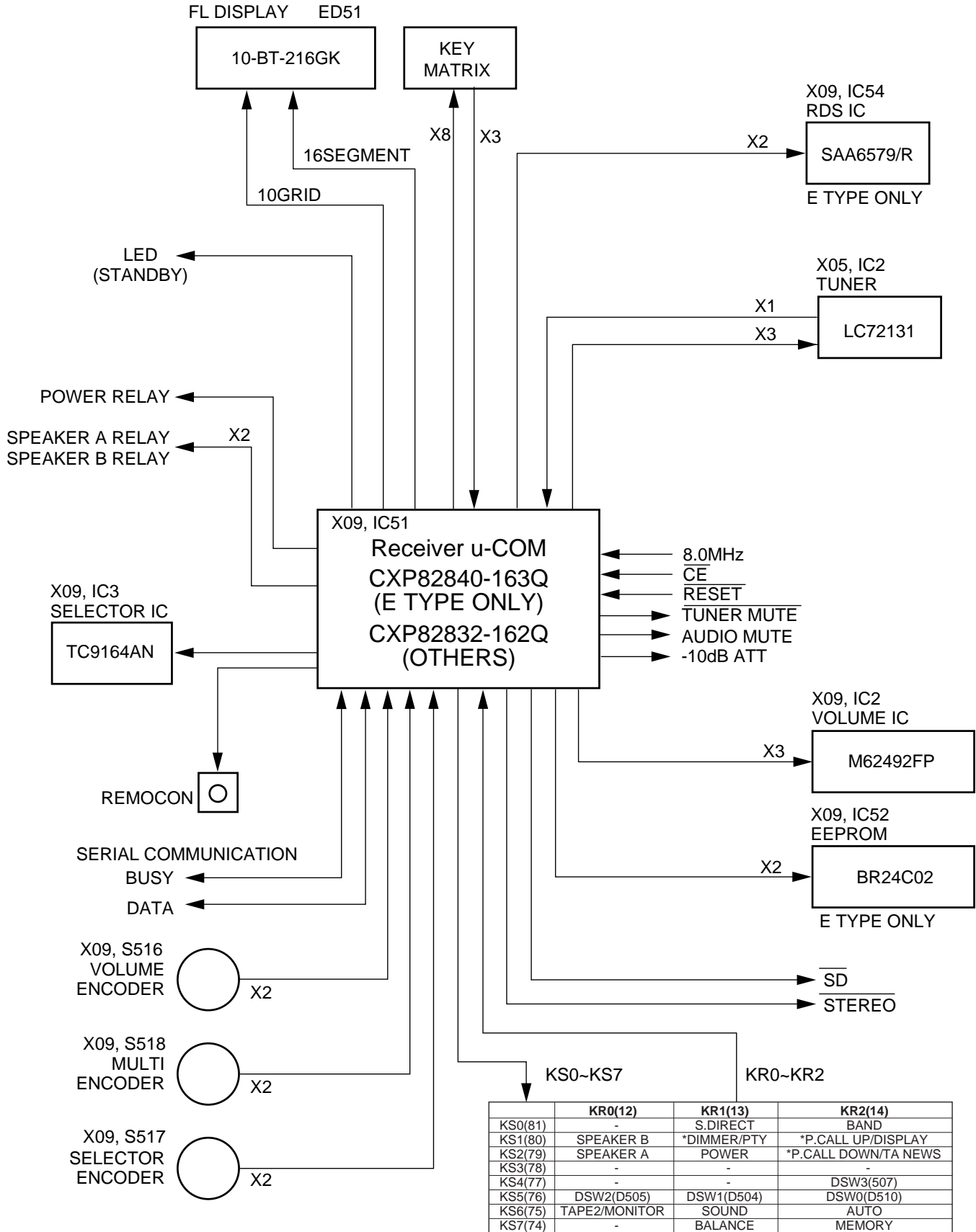

PTY, DISPLAY and TA/NEWS keys are only RDS version(E type).

AR-404/KRF-A4030/A4030E/A4030-S

CIRCUIT DESCRIPTION

4.2 Microprocessor pin descriptions: X09,IC51

Pin No.	Pin name	I/O	Description	Active
1,2	G9,G10	O	FL grid control (9,10).	
3	NC	-	u-Com +5V power supply.	
4	RDS,CK	I	RDS IC clock input control. (E type only)	
5	RDS,DT	I	RDS IC data input control. (E type only)	
6	NC	I	u-Com +5V power supply.	
7	VOL.ENC.A	I	Volume encoder A (CW) signal.	
8	REMOCON	I	Remote control signal input.	
9	VOL.ENC.B	I	Volume encoder B (CCW) signal.	
10,11	NC	-	Unused.	
12~14	KR0~KR2	I	Key return (0~2).	
15	PROTECT	I	Protection detection signal input.	H: Protection ON
16	S.DATA	I/O	Serial communication data.	
17	S.BUSY	I/O	Serial communication busy.	
18	E2.DATA	I/O	E2 PROM data.	
19	E2.CLK	O	E2 PROM clock.	
20	SEL.ENC2 CW	I	Selector encoder A(CW) input.	
21	SEL.ENC2 CCW2	I	Selector encoder B(CCW) input.	
22	MLT. ENC3 CW3	I	Multi control encoder A(CW).	
23	MLT. ENC3 CCW3	I	Multi control encoder B(CCW).	
24	8/16	I	Serial communication 8bit/16bit changeover.	
25~27	NC	-	Unused.	
28	AV REF	-	Analog reference voltage (+5V).	
29	S.LEVEL	I	Signal level A/D input. (E type only)	
30~32	NC	-	Unused.	
33	PLL.DO	I	PLL IC DO signal input. (E type only)	
34	PLL.STEREO	I	TUNER stereo signal input.	L: STEREO
35	PLL.SD	I	TUNER SD signal input.	L: TUNED
36	RCV.CE	I	Receiver chip enable signal input.	L: ENABLE
37	AVSS	-	Analog ground.	
38	RESET	I	u-Com reset.	
39	EXTAL	I	Main clock(8MHZ).	
40	XTAL	-	Main clock(8MHZ).	
41	VSS	-	u-Com ground.	
42	TX	-	Unused.	
43	TEX	I	Ground.	
44	VDD	-	Analog power supply (+5V).	
45	VFDP	-	FL power supply(-33V).	
46	SEL.STB	O	TC9164AF strobe.	H: LATCH
47	SEL/PLL.DT	O	Selector/PLL IC data signal output.	
48	SEL/PLL.CK	O	Selector/PLL IC clock signal output.	
49	PLL.CE	O	PLL IC CE signal output.	
50	T.MUTE	O	Tuner mute control.	L: MUTE ON
51	A.MUTE	O	Audio mute control.	L: MUTE ON
52	NC	-	Unused.	
53	10dB.ATT	O	Volume 10dB attenuator control.	L: ATT ON
54	VOL.DT	O	Volume IC(M62492FP) data control.	
55	VOL.CK	O	Volume IC(M62492FP) clock control.	
56	VOL.STB	O	Volume IC(M62492FP) strobe control.	
57~59	NC	-	Unused.	
60	RELAY.A	O	SP. relay A control.	H: RELAY ON
61	RELAY.B	O	SP. relay B control.	H: RELAY ON
62,63	NC	-	Unused.	
64	POWER.RLY	O	Power relay control.	H: RELAY ON
65	STANDBY.LED	O	STANDBY LED control.	H: LED ON
66~71	NC	-	Unused.	
72	LIMITER	O	Output power control at SP. (A+B). K/M/X only.	
73	S.W MUTE	-	Unused.	
74,75	KS6/KS7	O	Key scan 6,7.	
76~81	P1/KS5~P6/KS0	O	FL segment 1~6/key scan 5~0.	
82~88	P7~P13	O	FL segment 7~13.	
89	VDD	O	u-Com +5V power supply.	
90~92	P14~P16	O	FL segment 14~16.	
93~100	G1~G8	O	FL GRID 1~8.	

ADJUSTMENT

No.	ITEM	INPUT SETTINGS	OUTPUT SETTINGS	RECEIVER SETTINGS	ALIGNMENT POINTS	ALIGN FOR	FIG.
FM SECTION : EXCEPT E type SELECTOR : FM							
1	DISTORTION (STEREO)	(C) 98.0MHz 1kHz, ±68.25kHz dev. Selector : L or R Pilot : ±6.75kHz dev. 70dBf (ANT. input)	(B)	98.0MHz	IFT (TUNER UNIT : A1)	Minimum distortion (L or R)	(a)
2	TUNING LEVEL	(A) 98.0MHz MONO 1kHz, ±75kHz dev. 25dBf (ANT. input)	(B)	MONO 98.0MHz	VR1 (TUNER UNIT)	Adjust VR1 and stop at the point where ED51 (TUNED) goes on.	(a)
FM SECTION : E type only SELECTOR : FM ※ Adjust NO.1 and NO.2 repeat.							
1	DISCRIMINATOR	(A) 98.0MHz 1kHz, ±40kHz dev. 70dBf (ANT. input)	Connect a DC voltmeter between CN2 ① and CN2 ② (TUNER UNIT)	MONO 98.0MHz	L4 (TUNER UNIT)	0V	(a)
2	DISTORTION (MONO)	(A) 98.0MHz 1kHz, ±40kHz dev. MONO 70dBf (ANT. input)	(B)	MONO 98.0MHz	L5 (TUNER UNIT)	Minimum distortion	(a)
3	DISTORTION (STEREO)	(C) 98.0MHz 1kHz, ±40kHz dev. Selector : L or R Pilot : ±6kHz dev. 70dBf (ANT. input)	(B)	AUTO 98.0MHz	IFT (TUNER UNIT : A1)	Minimum distortion (L or R)	(a)
4	TUNING LEVEL	(A) 98.0MHz MONO 1kHz, ±40kHz dev. 25dBf (ANT. input)	(B)	MONO 98.0MHz	VR1 (TUNER UNIT)	Adjust VR1 and stop at the point where ED51 (TUNED) goes on.	(a)
AUDIO SECTION							
1	IDLE CURRENT	—	Connect a DC Volumeter across CN11 (L) CN12 (R)	Volume: 0	VR1 (L) VR2 (R)	11 mV	(b)

SYSTEM CONNECTIONS

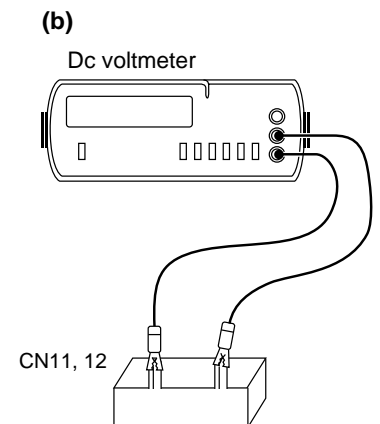
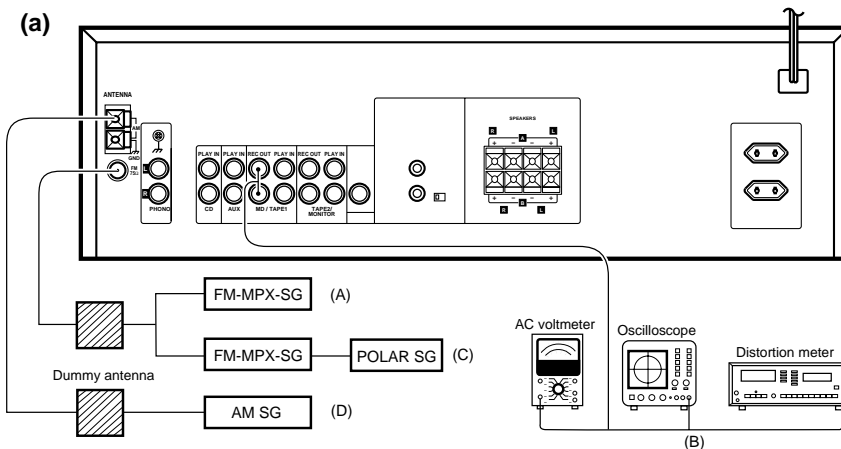

PC BOARD (Component side view)

TUNER UNIT X05-498X-XX

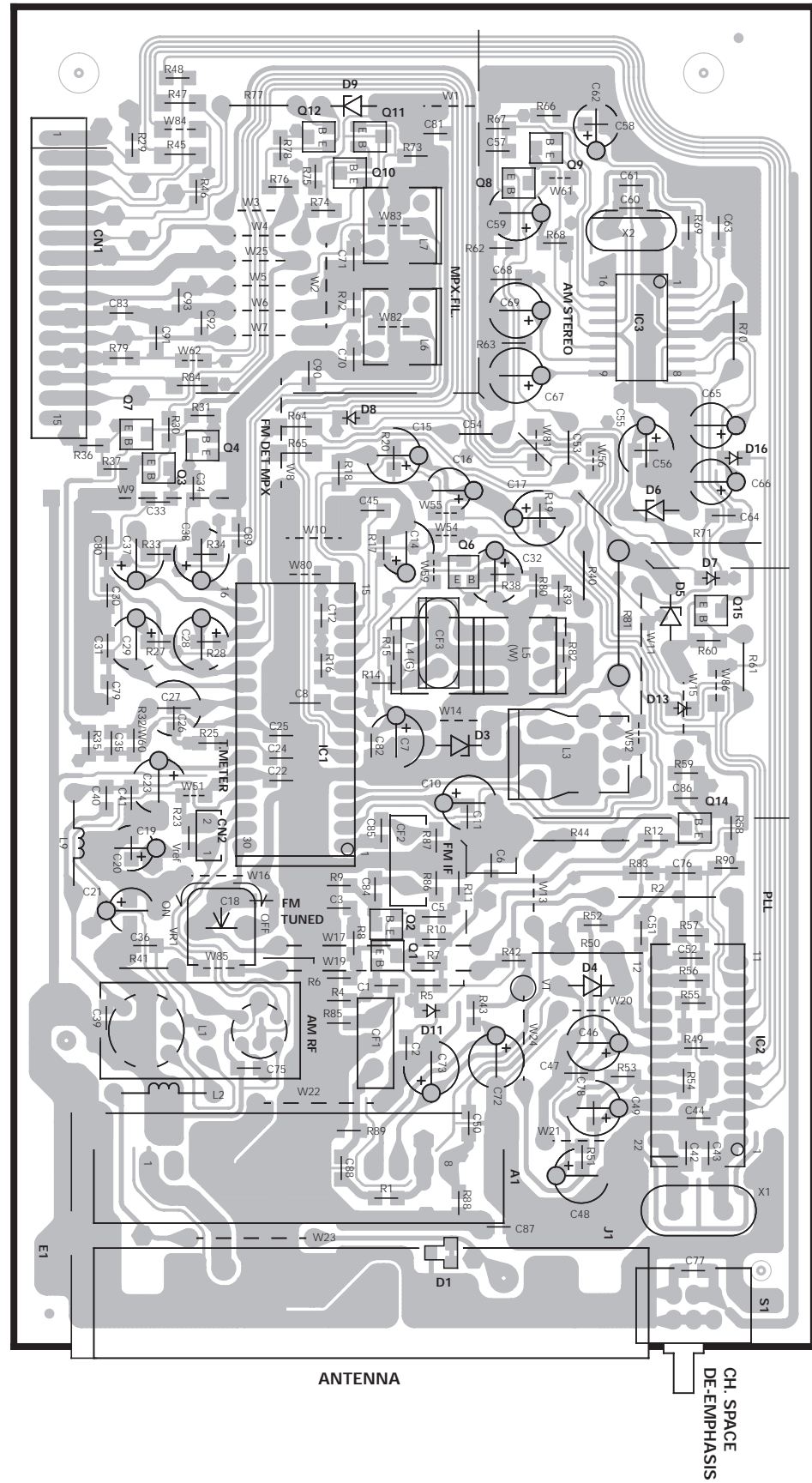

X09 H/9

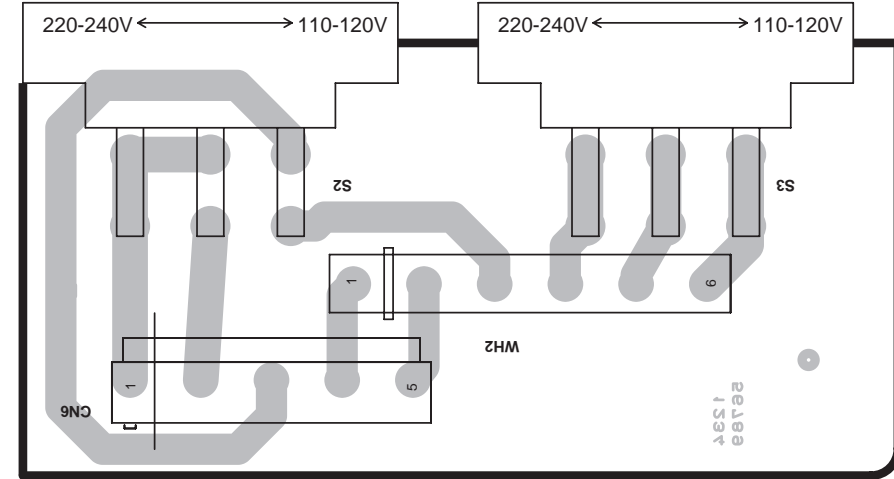

X09 D/9

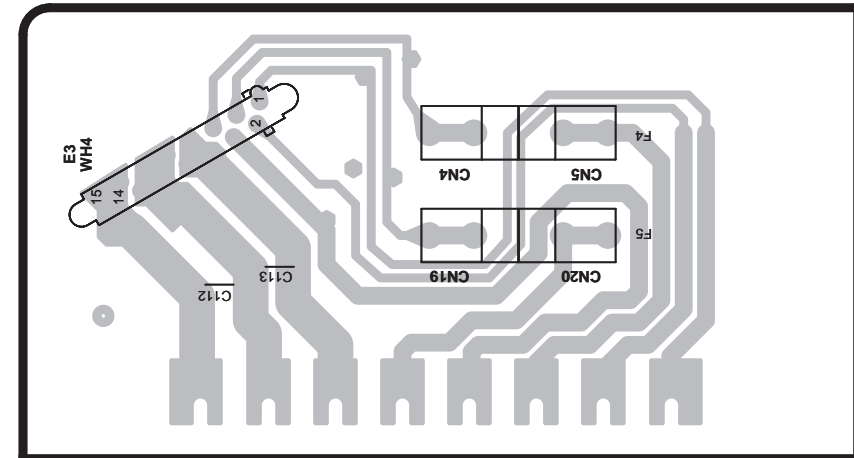

X09 E/9

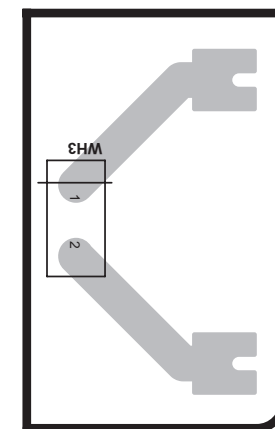

Refer to the schematic diagram for the value of resistors and capacitors.

PC BOARD (Component side view) AUDIO UNIT

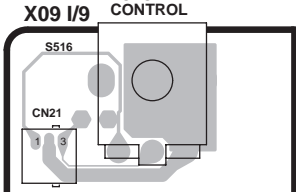
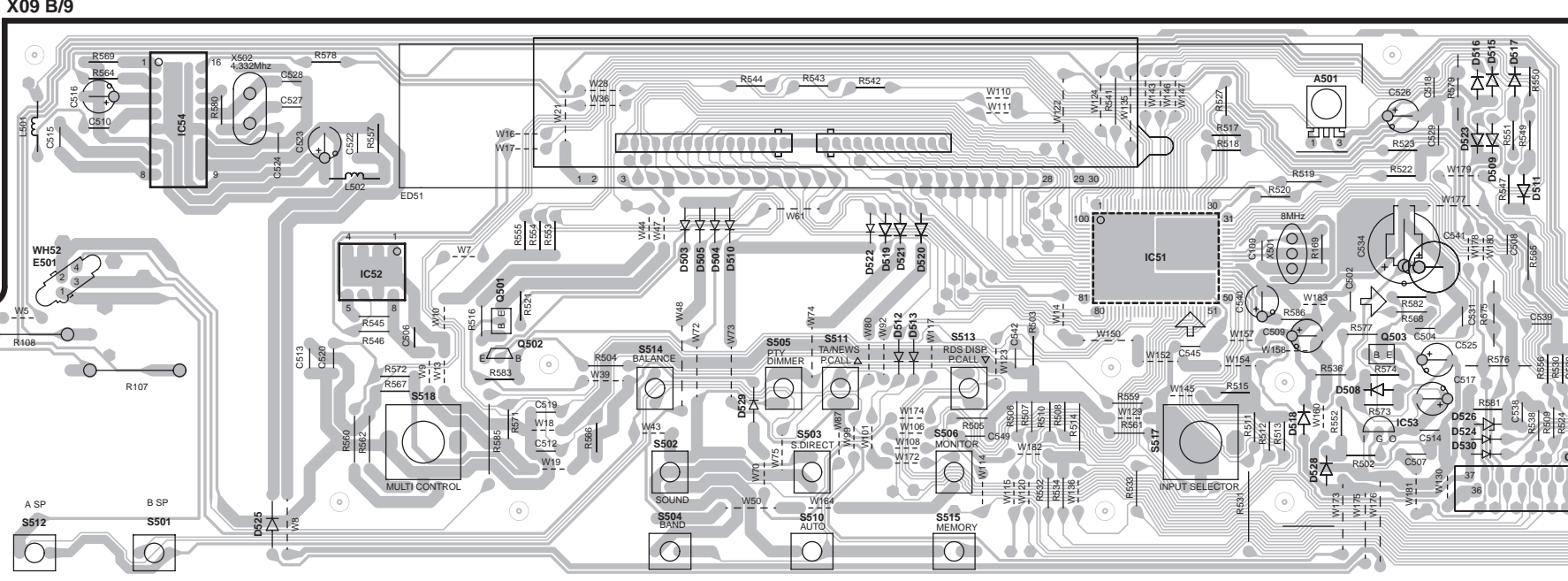
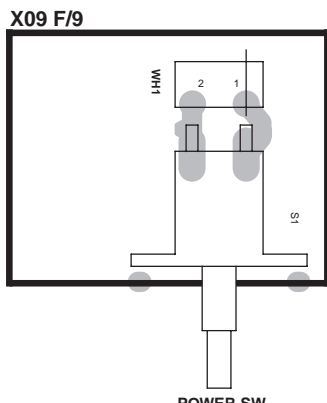
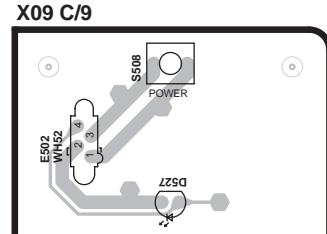
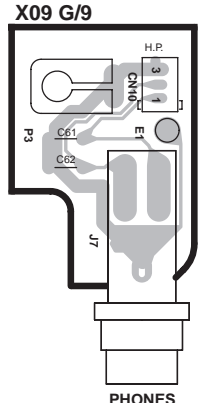
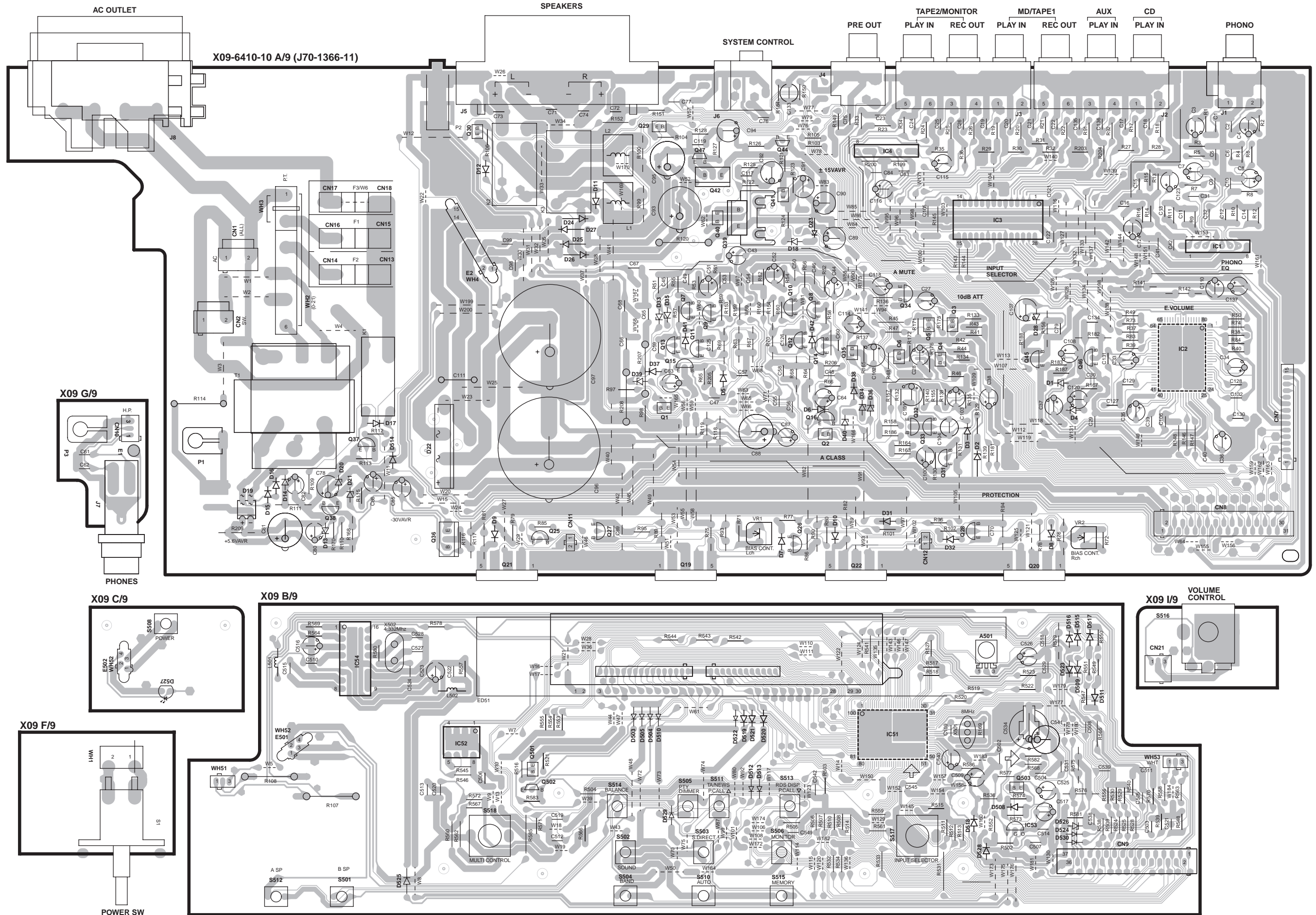

Refer to the schematic diagram for the value of resistors and capacitors.

TUNER UNIT (X05-498X-XX)

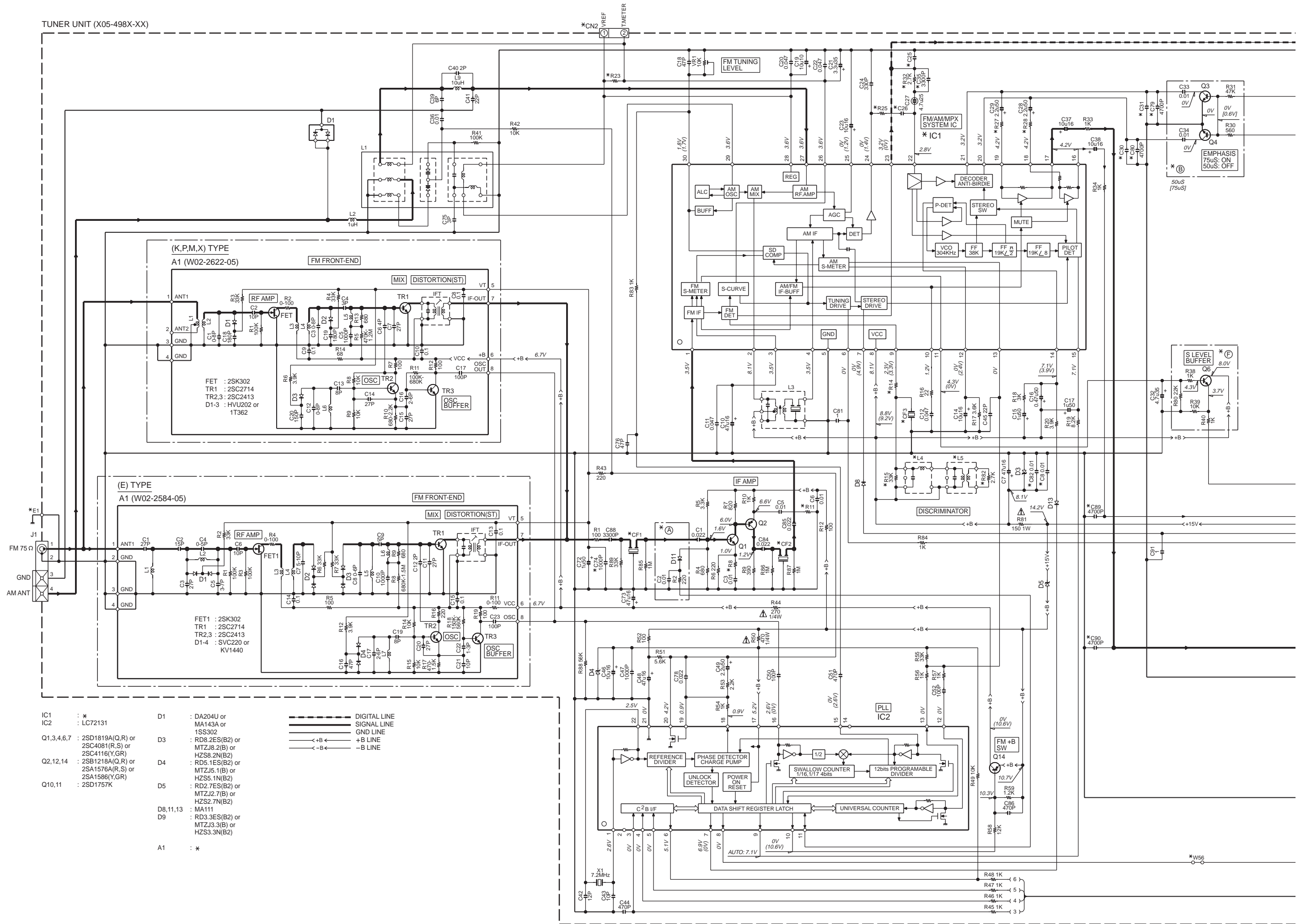

- | | | |
|---|---|--------------|
| IC1 : * | D1 : DA204U or MA143A or 1SS302 | DIGITAL LINE |
| IC2 : LC72131 | D3 : RD8.2ES(B2) or MTZJ8.2(B) or HZS8.2N(B2) | SIGNAL LINE |
| Q1,3,4,6,7 : 2SD1819A(Q,R) or 2SC4081(R,S) or 2SC4116(Y,GR) | D4 : RD5.1ES(B2) or MTZJ5.1(B) or HZS5.1N(B2) | GND LINE |
| Q2,12,14 : 2SB1218A(Q,R) or 2SA1576A(R,S) or 2SA1586(Y,GR) | D5 : RD2.7ES(B2) or MTZJ2.7(B) or HZS2.7N(B2) | -B LINE |
| Q10,11 : 2SD1757K | D8,11,13 : MA111 | +B LINE |
| | D9 : RD3.3ES(B2) or MTZJ3.3(B) or HZS3.3N(B2) | -B LINE |
| | A1 : * | |

(X05-498X-XX)

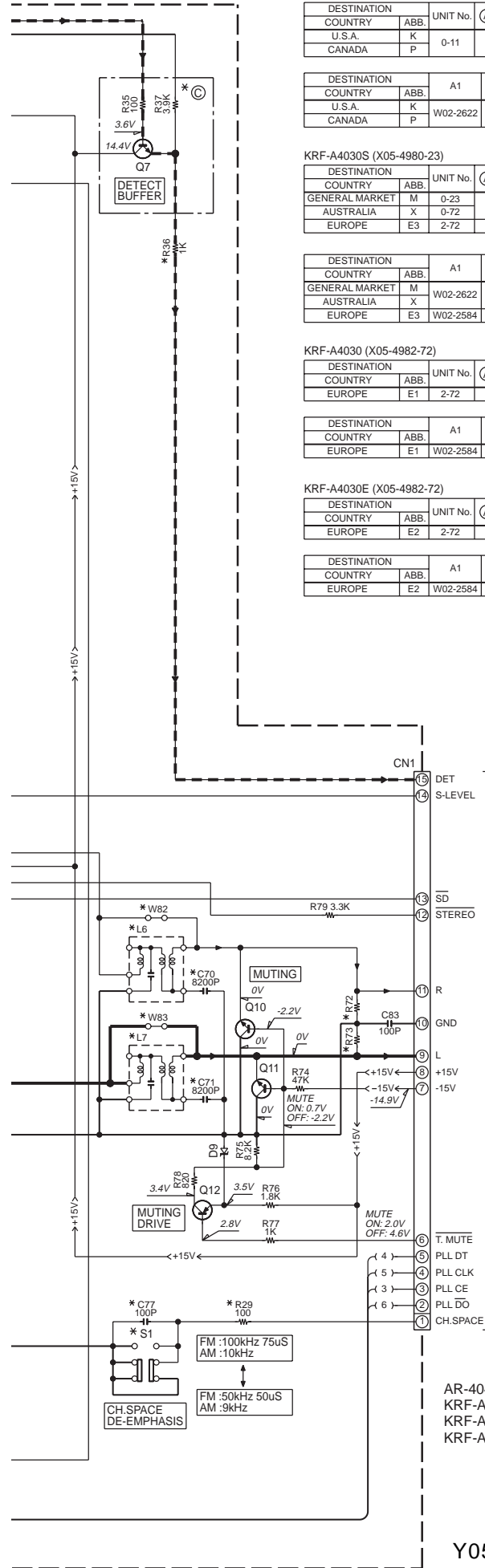

AR-404 (X05-4980-11)

DESTINATION		UNIT No.	(A)	(B)	(C)	(F)	R8, R11	R14	R15, 32, 82	R23	R25	R27, 28	R29, 36	R72, 73	C8, 70, 71, 77, 79, 80	C25	C26	C30, 31	C35, 82, 74, 89, 90	
COUNTRY	ABB.																			
U.S.A.	K	0-11																		
CANADA	P						33	100	YES	4.7K	22K	6.2K	NO	15K	NO	470P	0.022	0.033		YES

DESTINATION		UNIT No.	A1	CF1,2	CF3	IC1	L4,5	L6,7	CN2	W56	W82, 83	S1	E1
COUNTRY	ABB.												
U.S.A.	K	W02-2622		L72-0596 (MS2)		NO	LA1837	YES	NO	YES	NO	NO	F10-1129
CANADA	P												

KRF-A4030S (X05-4980-23)

DESTINATION		UNIT No.	(A)	(C)	(F)	(B)	R8	R11	R14	R15, 36, 82	R23	R25	R27, 28	R29	R32	R72, 73	C8, 35, 89, 90	C25	C26	C30, 31	C70, 71, 79, 80, 82	C74	C77	
COUNTRY	ABB.																							
GENERAL MARKET	M	0-23			NO	YES	33	33	270	NO	3.3K	18K	7.5K	YES	YES	8.2K	YES	470P	0.022	0.022		NO	NO	YES
AUSTRALIA	X	0-72												NO										
EUROPE	E3	2-72			YES		10	22	100	YES	15K	27K	4.3K	NO	W60	3.9K	NO	180P	0.018			YES	NO	NO

DESTINATION		UNIT No.	A1	CF1,2	CF3	IC1	L4,5	L6,7	CN2	W56	W82, 83	S1	E1
COUNTRY	ABB.												
GENERAL MARKET	M	W02-2622		L72-0531 (MA5)		YES	LA1838	NO	NO	YES	YES	YES	F10-1129
AUSTRALIA	X												
EUROPE	E3	W02-2584		L72-0536 (MS3)		NO	LA1837	YES	YES	NO	NO	NO	F10-1128

KRF-A4030 (X05-4982-72)

DESTINATION		UNIT No.	(A)	(C)	(F)	(B)	R8	R11	R14	R15, 82	R23	R25	R27, 28	R29	R32	R36	R72, 73	C8, 35, 74, 77, 89, 90	C25	C26	C30, 31	C70, 71, 79, 80, 82	
COUNTRY	ABB.																						
EUROPE	E1	2-72			YES	NO	10	22	100	YES	15K	27K	4.3K	NO	W60	YES	3.9K	NO	180P	0.018	0.022		YES

DESTINATION		UNIT No.	A1	CF1,2	CF3	IC1	L4,5	L6,7	CN2	W56	W82, 83	S1	E1
COUNTRY	ABB.												
EUROPE	E1	W02-2584		L72-0536 (MS3)		NO	LA1837	YES	YES	NO	NO	NO	F10-1128

KRF-A4030E (X05-4982-72)

DESTINATION		UNIT No.	(A)	(C)	(F)	(B)	R8	R11	R14	R15, 82	R23	R25	R27, 28	R29	R32	R36	R72, 73	C8, 35, 74, 77, 89, 90	C25	C26	C30, 31	C70, 71, 79, 80, 82	
COUNTRY	ABB.																						
EUROPE	E2	2-72			YES	NO	10	22	100	YES	15K	27K	4.3K	NO	W60	YES	3.9K	NO	180P	0.018	0.022		YES

DESTINATION		UNIT No.	A1	CF1,2	CF3	IC1	L4,5	L6,7	CN2	W56	W82, 83	S1	E1
COUNTRY	ABB.												
EUROPE	E2	W02-2584		L72-0536 (MS3)		NO	LA1837	YES	YES	NO	NO	NO	F10-1128

CAUTION: For continued safety, replace safety critical components only with manufacturer's recommended parts (refer to parts list). Δ indicates safety critical components. For continued protection against risk of fire, replace only with same type and rating fuse(s). To reduce the risk of electric shock, leakage-current or resistance measurements shall be carried out (exposed parts are acceptably insulated from the supply circuit) before the appliance is returned to the customer.

The DC voltage is an actual reading measured with a high impedance vohmmeter as the AM/FM signal generator is specified to the conditions as shown in the list below. The measurement value may vary depending on the measuring instruments used or on the product. The value shown in () is actual reading measured in the AM mode.

MODE	CARRIER	MODULATION		ANT INPUT
		FREQUENCY	DEVIATION	
FM	98MHz	1kHz	STEREO 67.5kHz 7.5kHz(Pilot)	60dB
AM	1000(999)kHz	400Hz	MONO 30% MOD	60dB

AR-404(K,P) (1/3)
 KRF-A4020S(M,X,E) (1/3)
 KRF-A4030(E) (1/3)
 KRF-A4030E(E2) (1/3)

AUDIO UNIT
(X09-641X-XX)
(A/9)

X05-
CN1
1/3
A

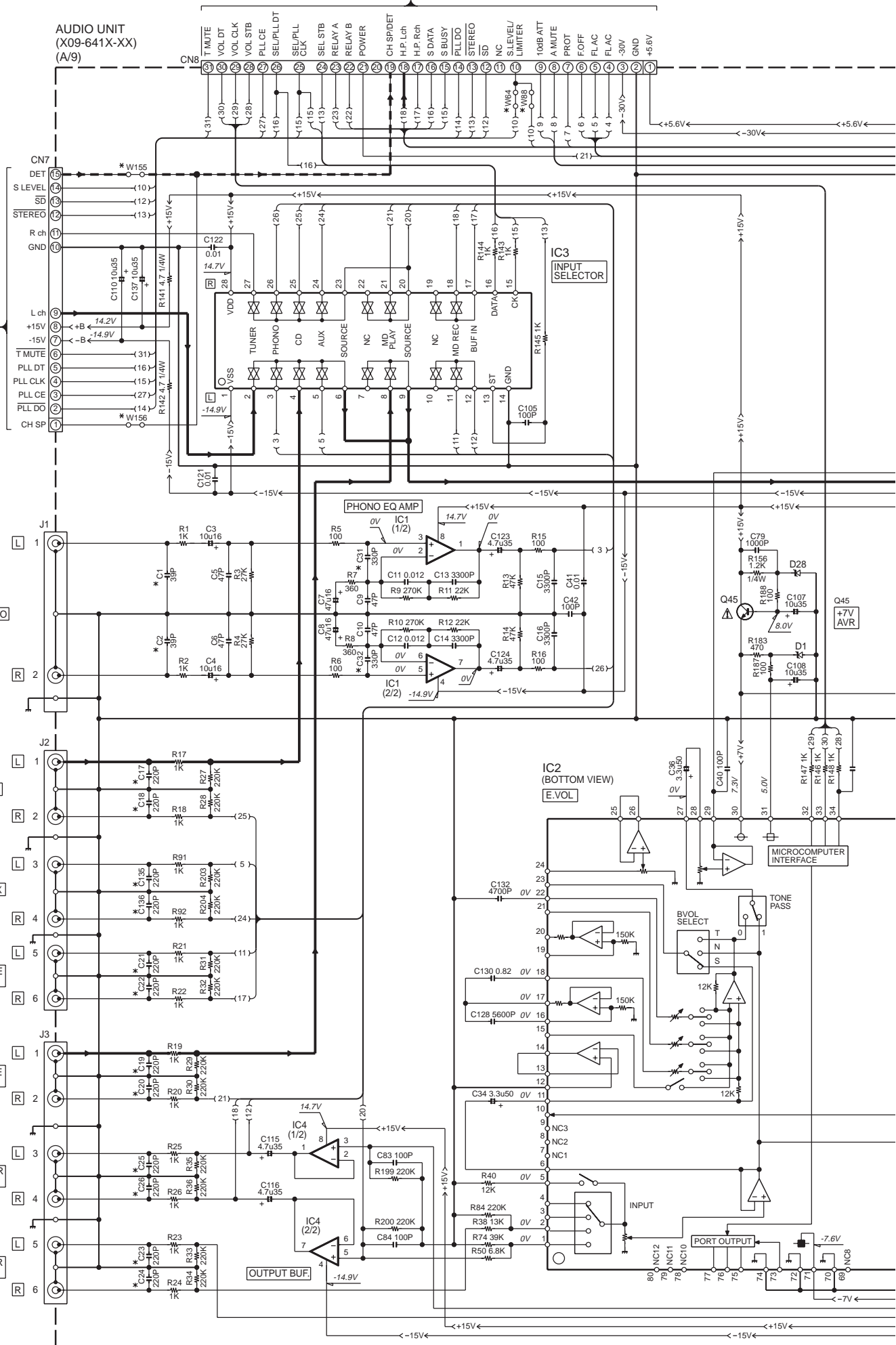

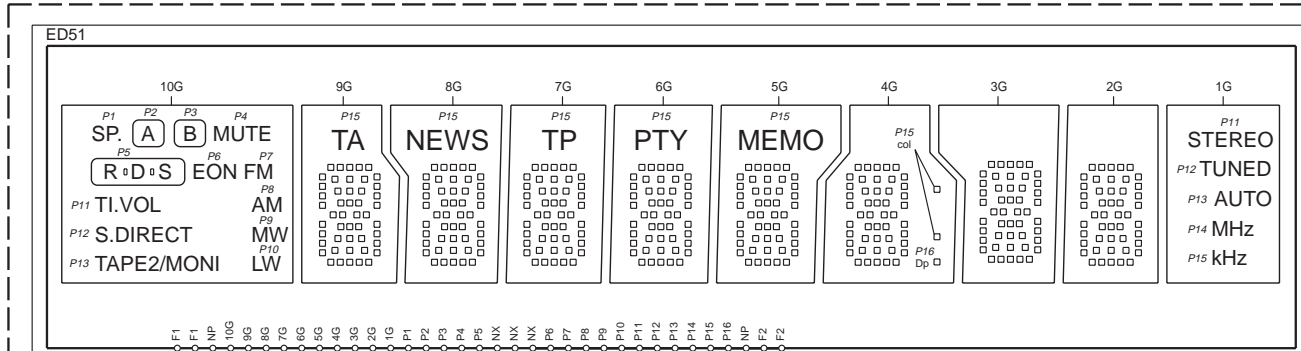

AR-404 (X09-6410-10)

DESTINATION	UNIT No.	R503, 556	R504, 509, 583	C503, 508, 534, 542, 549	C521	C529	C541	W110, 111, 114, 115	S505	S511	S513	D503-505, 504, 507, 510, 525	Q502	IC51	
U.S.A.	K	0-10	NO	YES	NO	100P	150P	YES	YES	DIMMER	PCALL	PCALL	NO	NO	CXP82832-162Q
CANADA	P														

KRF-A4030E (X09-6412-71)

DESTINATION	UNIT No.	R503, 504, 556, 583	R509	C503, 508, 534, 542, 549	C521	C529	C541	W110, 111, 114, 115	S505	S511	S513	D503, 504, 507, 510, 525	Q502	IC51			
EUROPE	E2	2-71	YES	NO	YES	YES	220P	47P	NO	NO	PTY	TA/NEWS	(RDS) DISPLAY	NO	YES	NO	CXP82840-163Q

KRF-A4030 (X09-6412-71)

DESTINATION	UNIT No.	R503, 504, 556, 583	R509	C503, 508, 534, 542, 549	C521	C529	C541	W110, 111, 114, 115	S505	S511	S513	D503, 504, 507, 510, 525	Q502	IC51			
EUROPE	E1	2-71	YES	NO	YES	YES	220P	47P	NO	NO	PTY	TA/NEWS	(RDS) DISPLAY	NO	YES	NO	CXP82840-163Q

KRF-A4020-S (X09-641X-XX)

DESTINATION	UNIT No.	R503, 556	R504, 583	R509	C503, 549	C508	C521	C529	C534	C541	C542	W110, 111, 114, 115	S505	S511	S513	D503, 504, 507, 510, 525	D504	D505, 525	D507	D510	Q502	IC51		
GENERAL MARKET	M	0-21	NO	YES	YES	NO	NO	YES	100P	100P		NO	NO	YES	DIMMER	PCALL	PCALL	YES	NO	NO	NO	YES	NO	CXP82832-162Q
AUSTRALIA	X	0-71										YES	NO	YES										
EUROPE	E3	2-71	YES	NO	NO	YES	YES	NO	220P	47P		YES	NO	PTY	TA/NEWS	(RDS) DISPLAY	NO	NO	YES	NO	YES	NO	NO	CXP82840-163Q

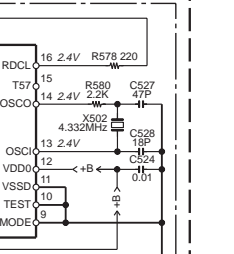
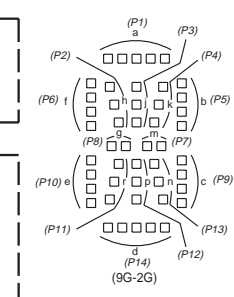
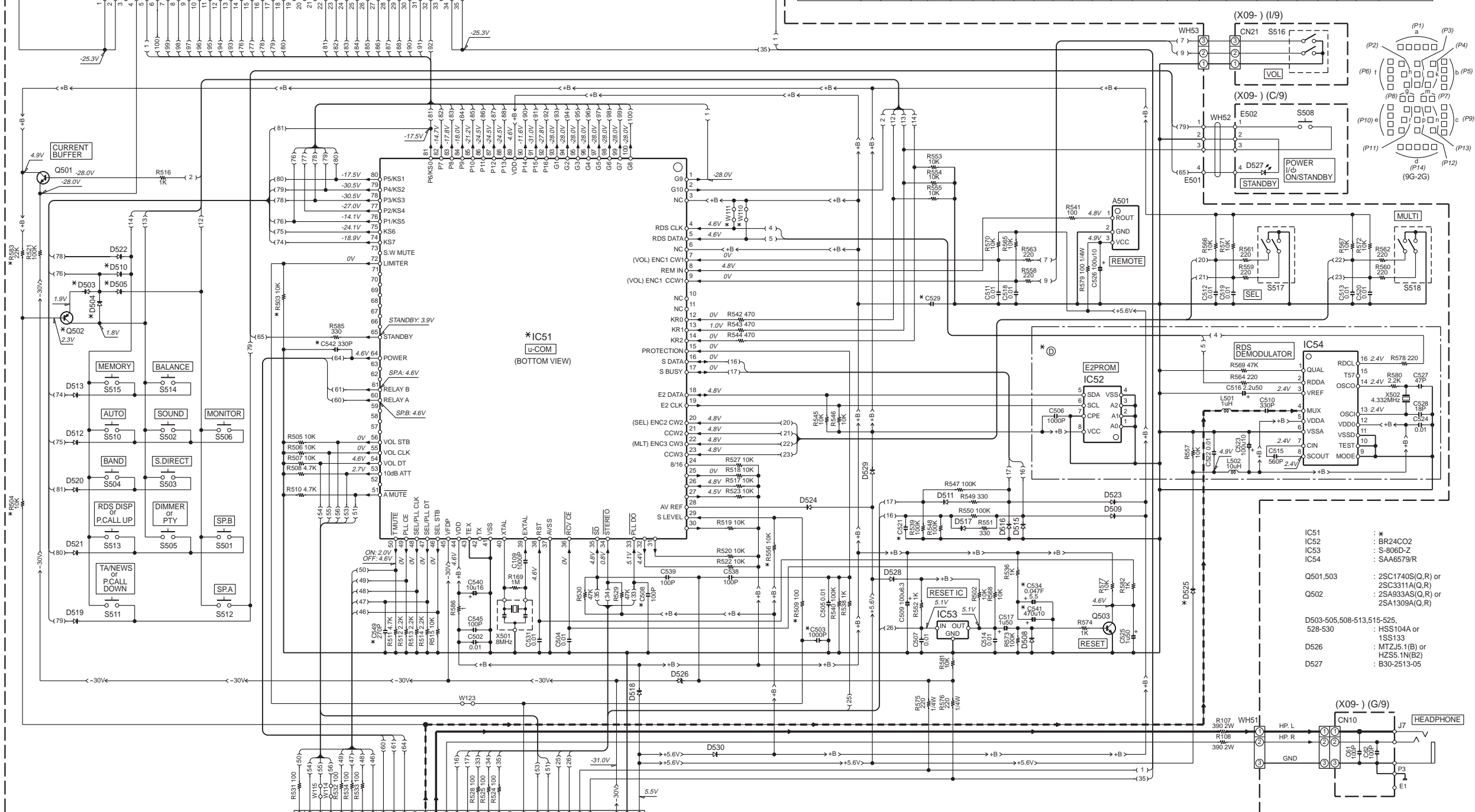
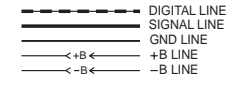

- IC51 : *
- IC52 : BR24CO2
- IC53 : S-806D-Z
- IC54 : SAA6579/R
- Q501,503 : 2SC1740S(Q,R) or 2SC3311A(Q,R)
- Q502 : 2SA933AS(Q,R) or 2SA1309A(Q,R)
- D503-505,508-513,515-525, 528-530 : HSS104A or 1SS133
- D526 : MTZJ5.1(B) or HZS5.1N(B2)
- D527 : B30-2513-05

AR-404(K,P) (3/3)
 KRF-A4030(M,X,E) (3/3)
 KRF-A4030E(E2) (3/3)
 KRF-A4030E-S(E) (3/3)

The DC voltage is an actual reading measured with a high impedance type voltmeter with no signal input. The measurement value may vary depending on the measuring instruments used or on the product.

CAUTION: For continued safety, replace safety critical components only with manufacturer's recommended parts (refer to parts list). Δ indicates safety critical components. For continued protection against risk of fire, replace only with same type and rating fuse(s). To reduce the risk of electric shock, leakage-current or resistance measurements shall be carried out (exposed parts are acceptably insulated from the supply circuit) before the appliance is returned to the customer.

EXPLODED VIEW (UNIT)

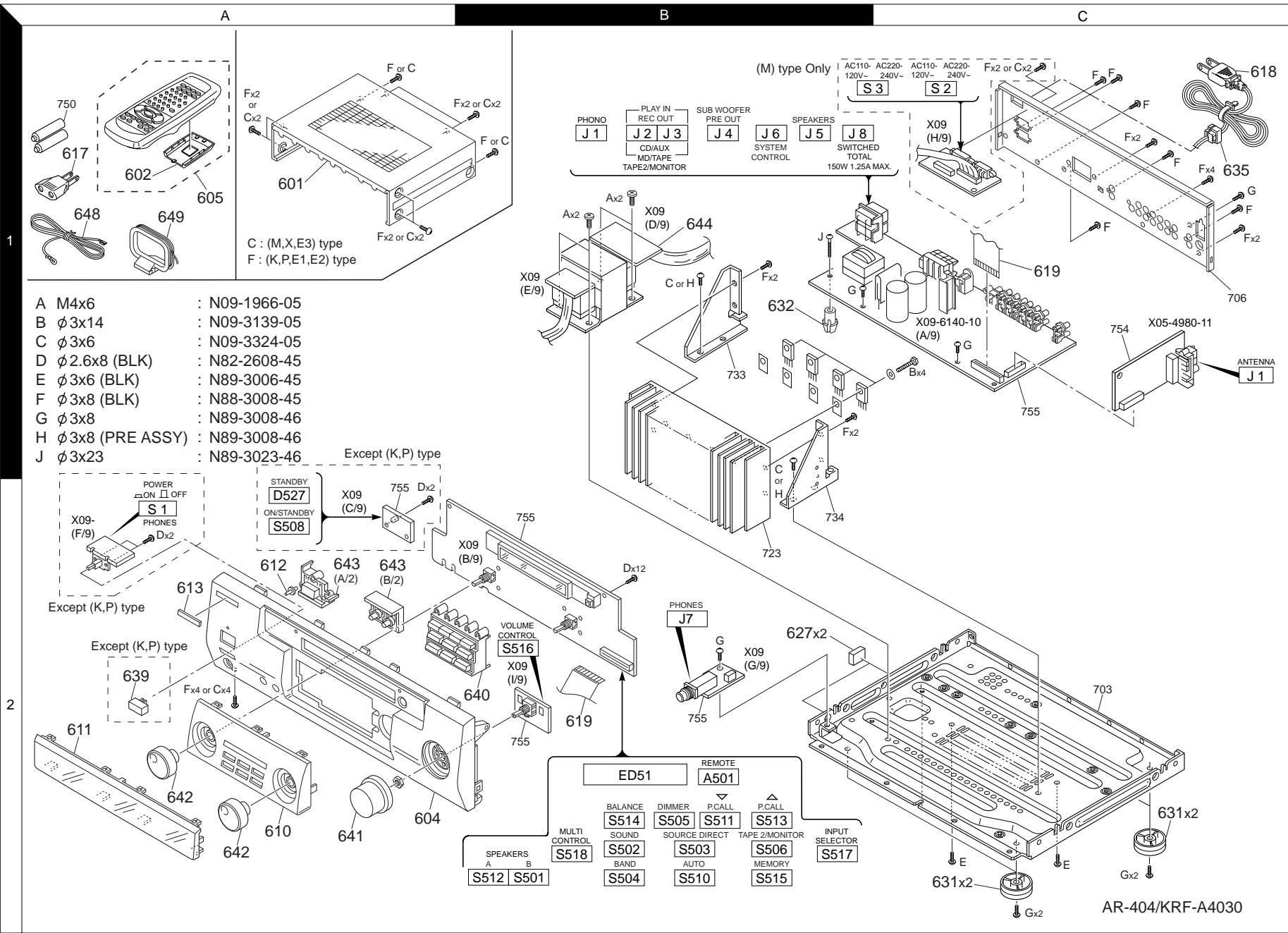

- A M4x6 : N09-1966-05
- B ϕ 3x14 : N09-3139-05
- C ϕ 3x6 : N09-3324-05
- D ϕ 2.6x8 (BLK) : N82-2608-45
- E ϕ 3x6 (BLK) : N89-3006-45
- F ϕ 3x8 (BLK) : N88-3008-45
- G ϕ 3x8 : N89-3008-46
- H ϕ 3x8 (PRE ASSY) : N89-3008-46
- J ϕ 3x23 : N89-3023-46

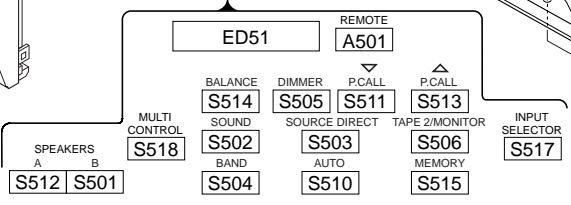
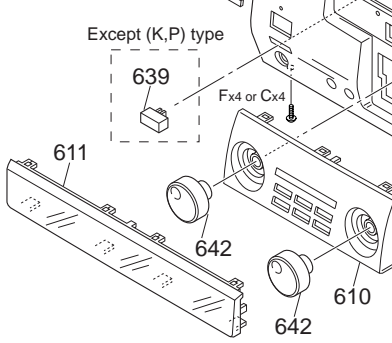
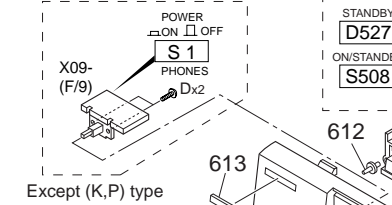

AR-404/KRF-A4030

20

1

2

Parts with exploded numbers larger than 700 are not supplied.

* New Parts

Parts without **Parts No.** are not supplied.
Les articles non mentionnés dans le **Parts No.** ne sont pas fournis.
Teile ohne **Parts No.** werden nicht geliefert.

Ref. No	Add-ress	New Parts	Parts No.	Description	Desti-nation	Re-marks
AR-404/KRF-A4030/A4030E/A4030-S						
601	1A	*	A01-3733-01	METALLIC CABINET	E2	
601	1A	*	A01-3733-01	METALLIC CABINET	KPE1	
601	1A	*	A01-3734-01	METALLIC CABINET	MXE3	
602	1A		A09-1123-08	BATTERY COVER		
604	2A	*	A60-1762-01	PANEL	KP	
604	2A	*	A60-1763-01	PANEL	E1E2	
604	2A	*	A60-1764-01	PANEL	MXE3	
605	1A		A70-1266-05	REMOTE CONTROL ASSY(RC-R0709)	KPM	
605	1A		A70-1266-05	REMOTE CONTROL ASSY(RC-R0709)	X	
605	1A		A70-1267-05	REMOTE CONTROL ASSY(RC-R0708)	E1E2E3	
610	2A	*	B07-2479-02	ESCUTCHEON	KP	
610	2A	*	B07-2480-02	ESCUTCHEON	E3	
610	2A	*	B07-2504-02	ESCUTCHEON	MX	
610	2A	*	B07-2506-02	ESCUTCHEON	E1E2	
611	2A	*	B10-3576-02	FRONT GLASS	KP	
611	2A	*	B10-3577-02	FRONT GLASS	MX	
611	2A	*	B10-3578-12	FRONT GLASS	E1E2E3	
612	2A	*	B12-0385-04	INDICATOR		
613	2A	*	B43-0314-04	KENWOOD BADGE		
613	2A	*	B46-0096-53	WARRANTY CARD	X	
			B46-0310-03	WARRANTY CARD	E1E2E3	
			B46-0328-03	WARRANTY CARD	K	
			B46-0346-00	QUESTIONAIRE CARD	K	
			B46-0347-03	WARRANTY CARD	P	
			B58-0964-13	CAUTION CARD (UL)	K	
			B58-0965-13	CAUTION CARD (T_XtypePL)	X	
			B58-0966-13	CAUTION CARD (ELMtypePL)	ME1E3	
		*	B58-0967-03	CAUTION CARD (PtypePL)	P	
		*	B58-1607-03	CAUTION CARD	E2	
		*	B60-4556-00	INSTRUCTION MANUAL (EN)	KPM	
		*	B60-4556-00	INSTRUCTION MANUAL (EN)	X	
		*	B60-4557-00	INSTRUCTION MANUAL (EN)	E2	
		*	B60-4558-00	INSTRUCTION MANUAL (FR)	P	
		*	B60-4559-00	INSTRUCTION MANUAL (EN/TC)	M	
		*	B60-4560-00	INSTRUCTION MANUAL (FR/NE)	E1E3	
		*	B60-4561-00	INSTRUCTION MANUAL (IT/ES)	E1E3	
		*	B60-4562-00	INSTRUCTION MANUAL (GE)	E1E3	
		*	B60-4563-00	INSTRUCTION MANUAL (RU//PL)	E2	
		*	B60-4564-00	INSTRUCTION MANUAL (HU/CZ)	E2	
Δ 617	1A		E03-0115-05	AC PLUG ADAPTER	M	
Δ 618	1C		E30-2717-05	AC POWER CORD	X	
Δ 618	1C	*	E30-2941-05	AC POWER CORD	KP	
Δ 618	1C	*	E30-2942-05	AC POWER CORD	E3	
Δ 618	1C	*	E30-2942-05	AC POWER CORD	ME1E2	
619	1C,2B		E35-1772-05	FLAT CABLE		
627	2B		G11-2416-04	CUSHION		
		*	H10-7628-02	POLYSTYRENE FOAMED FIXTURE		
		*	H10-7629-02	POLYSTYRENE FOAMED FIXTURE		
		*	H25-0232-04	PROTECTION BAG (235X350X0.03)		
		*	H25-0391-04	PROTECTION BAG		
		*	H50-3616-04	ITEM CARTON CASE	KP	

L: Scandinavia K: USA P: Canada R: Mexico C: China I: Malaysia
Y: PX(Far East,Hawaii) T: England E: Europe G: Germany V: China(Shanghai)
Y: AAFES(Europe) X: Australia Q: Russia H: Korea M: Other Areas Δ indicates safety critical components.

* New Parts

Parts without **Parts No.** are not supplied.
Les articles non mentionnés dans le **Parts No.** ne sont pas fournis.
Teile ohne **Parts No.** werden nicht geliefert.

Ref. No	Add-ress	New Parts	Parts No.	Description	Desti-nation	Re-marks
-		*	H50-3617-04	ITEM CARTON CASE	E1	
-		*	H50-3618-04	ITEM CARTON CASE	M	
-		*	H50-3619-04	ITEM CARTON CASE	XE3	
-		*	H50-3650-04	ITEM CARTON CASE	E2	
631	2C	*	J02-1464-03	FOOT		
632	1B		J19-3752-14	UNIT HOLDER		
Δ 635	1C		J42-0083-05	POWER CORD BUSHING		
			J61-0307-05	WIRE BAND		
639	2A	*	K27-2384-04	KNOB (BUTTON)	E1E2	
639	2A	*	K27-2385-04	KNOB (BUTTON)	MXE3	
640	2B	*	K29-7675-12	KNOB	E2	
640	2B	*	K29-7675-12	KNOB	KPE1	
640	2B	*	K29-7676-12	KNOB	MXE3	
641	2A	*	K29-7678-04	KNOB (VOLUME)	E2	
641	2A	*	K29-7678-04	KNOB (VOLUME)	KPE1	
641	2A	*	K29-7679-04	KNOB (VOLUME)	MXE3	
642	2A	*	K29-7681-14	KNOB (MULTI/INPUT)	E2	
642	2A	*	K29-7681-14	KNOB (MULTI/INPUT)	KPE1	
642	2A	*	K29-7682-14	KNOB (MULTI/INPUT)	MXE3	
643	2A	*	K29-7687-03	KNOB (SPEAKER/POWER)	E2	
643	2A	*	K29-7687-03	KNOB (SPEAKER/POWER)	KPE1	
643	2A	*	K29-7688-03	KNOB (SPEAKER/POWER)	MXE3	
Δ 644	1B		L07-2638-05	POWER TRANSFORMER	E1E2E3	
Δ 644	1B		L07-2639-05	POWER TRANSFORMER	M	
Δ 644	1B		L07-2691-05	POWER TRANSFORMER	X	
Δ 644	1B	*	L07-2801-05	POWER TRANSFORMER	KP	
648	1A		T90-0836-05	LEAD WIRE ANTENNA		
649	1A	*	T90-0852-05	LOOP ANTENNA		
TUNER UNIT (X05-498X-XX)						
C1			CK73FB1H223K	CHIP C	0.022UF	K
C2			CK73FB1H103K	CHIP C	0.010UF	K
C3			CK73FB1H103K	CHIP C	0.010UF	K
C5 ,6			CK73FB1H103K	CHIP C	0.010UF	K
C7			CE04LW1C470M	ELECTRO	47UF	16WV
C8			CK73EB1H103K	CHIP C	0.010UF	K
C10			CE04LW1C470M	ELECTRO	47UF	16WV
C11 ,12			CK73FB1H473K	CHIP C	0.047UF	K
C14			CE04LW1C100M	ELECTRO	10UF	16WV
C15			CE04LW1H010M	ELECTRO	1.0UF	50WV
C16			C90-3251-05	ELECTRO	0.47UF	50WV
C17			CE04LW1H010M	ELECTRO	1.0UF	50WV
C18			CC73FCH1H470J	CHIP C	47PF	J
C19			C90-3217-05	ELECTRO	10UF	10WV
C20			CK73FB1H473K	CHIP C	0.047UF	K
C21			C90-3241-05	ELECTRO	3.3UF	35WV
C22			CK73FB1H473K	CHIP C	0.047UF	K
C23			CE04LW1C100M	ELECTRO	10UF	16WV
C24			CK73FB1H331K	CHIP C	330PF	K
C25			CC73FCH1H181J	CHIP C	180PF	J
C25			CC73FCH1H471J	CHIP C	470PF	J
C26			CK73FB1H183K	CHIP C	0.018UF	K
C26			CK73FB1H223K	CHIP C	0.022UF	K
C27			CE04HW1E4R7M	NP-ELEC	4.7UF	25WV
C28 ,29			CE04LW1H2R2M	ELECTRO	2.2UF	50WV

L: Scandinavia K: USA P: Canada R: Mexico C: China I: Malaysia
Y: PX(Far East,Hawaii) T: England E: Europe G: Germany V: China(Shanghai)
Y: AAFES(Europe) X: Australia Q: Russia H: Korea M: Other Areas Δ indicates safety critical components.

PARTS LIST

AR-404/KRF-A4030/A4030E/A4030-S

* New Parts

Parts without **Parts No.** are not supplied.
Les articles non mentionnés dans le **Parts No.** ne sont pas fournis.
Teile ohne **Parts No.** werden nicht geliefert.

③

Ref. No	Add-ress	New Parts	Parts No.	Description	Desti-nation	Re-marks
C30 ,31			CK73FB1H223K	CHIP C 0.022UF	K	E2E3
C30 ,31			CK73FB1H223K	CHIP C 0.022UF	K	MXE1
C30 ,31			CK73FB1H333K	CHIP C 0.033UF	K	KP
C32			CE04LW1V4R7M	ELECTRO 4.7UF	35WV	
C33 ,34			CK73FB1H103K	CHIP C 0.010UF	K	M
C35			CK73FB1H332K	CHIP C 3300PF	K	KPM
C35			CK73FB1H332K	CHIP C 3300PF	K	X
C36			CK73FB1H103K	CHIP C 0.010UF	K	
C37 ,38			CE04LW1C100M	ELECTRO 10UF	16WV	
C39			CC73FCH1H060D	CHIP C 6.0PF	D	
C40			CC73FCH1H020C	CHIP C 2.0PF	C	
C41			CC73FCH1H220J	CHIP C 22PF	J	
C42			CC73FCH1H120J	CHIP C 12PF	J	
C43			CC73FCH1H100D	CHIP C 10PF	D	
C44			CK73FB1H471K	CHIP C 470PF	K	
C45			CC73FCH1H220J	CHIP C 22PF	J	
C46			CE04LW1C100M	ELECTRO 10UF	16WV	
C47			CK73FB1H102K	CHIP C 1000PF	K	
C48			CE04LW1C470M	ELECTRO 47UF	16WV	
C49			CE04LW1H2R2M	ELECTRO 2.2UF	50WV	
C50			CC73FSL1H101J	CHIP C 100PF	J	
C51			CK73FB1H471K	CHIP C 470PF	K	
C52			CC73FSL1H101J	CHIP C 100PF	J	
C70 ,71			CK73FB1H822K	CHIP C 8200PF	K	E1E2E3
C72			CE04LW1H010M	ELECTRO 1.0UF	50WV	
C73			CE04LW1C470M	ELECTRO 47UF	16WV	
C74			CK73FB1H102K	CHIP C 1000PF	K	KP
C75			CC73FCH1H030C	CHIP C 3.0PF	C	
C76			CC73FCH1H470J	CHIP C 47PF	J	
C77			CC73FSL1H101J	CHIP C 100PF	J	M
C78			CK73FB1H223K	CHIP C 0.022UF	K	
C79 ,80			CK73FB1H472K	CHIP C 4700PF	K	E1E2E3
C81			CK73FF1C105Z	CHIP C 1.0UF	Z	
C82			CK73FB1H103K	CHIP C 0.010UF	K	E2E3
C82			CK73FB1H103K	CHIP C 0.010UF	K	KPE1
C83			CC73FSL1H101J	CHIP C 100PF	J	
C84 ,85			CK73FB1H223K	CHIP C 0.022UF	K	
C86			CK73FB1H471K	CHIP C 470PF	K	
C88			CK73FB1H332K	CHIP C 3300PF	K	
C89 ,90			CK73FB1H472K	CHIP C 4700PF	K	KPMX
C91			CK73FF1C105Z	CHIP C 1.0UF	Z	
CN1			E40-9831-05	SOCKET FOR PIN ASSY		
CN2			E40-4871-05	PIN ASSY		E2E3
CN2			E40-4871-05	PIN ASSY		KPE1
J1			E20-0321-05	LOCK TERMINAL BOARD(2P,F)		
J1			E70-0052-05	LOCK TERMINAL BOARD		
E1			F10-1128-14	SHIELDING PLATE		E1E2E3
E1			F10-1129-14	SHIELDING PLATE		KPM
E1			F10-1129-14	SHIELDING PLATE		X
CF1 ,2			L72-0531-05	CERAMIC FILTER		MX
CF1 ,2			L72-0536-05	CERAMIC FILTER		E1E2E3
CF1 ,2			L72-0596-05	CERAMIC FILTER		KP
CF3			L72-0607-05	CERAMIC FILTER		MX
L1			L39-1384-05	COMBINATION COIL		

L : Scandinavia K : USA P : Canada R : Mexico C : China I : Malaysia

Y : PX(Far East,Hawaii) T : England E : Europe G : Germany V : China(Shanghai)

Y : AAFES(Europe) X : Australia Q : Russia H : Korea M : Other Areas Δ indicates safety critical components .

* New Parts

Parts without **Parts No.** are not supplied.
Les articles non mentionnés dans le **Parts No.** ne sont pas fournis.
Teile ohne **Parts No.** werden nicht geliefert.

④

Ref. No	Add-ress	New Parts	Parts No.	Description	Desti-nation	Re-marks
L2			L40-1091-17	SMALL FIXED INDUCTOR(1UH)		
L3			L30-0911-05	AM IFT		
L4			L30-0950-05	FM IFT		E2E3
L4			L30-0950-05	FM IFT		KPE1
L5			L30-0951-05	FM IFT		E2E3
L5			L30-0951-05	FM IFT		
L6 ,7			L79-1239-05	LC FILTER		KPE1
L9			L40-1001-17	SMALL FIXED INDUCTOR(10UH,K)		E1E2E3
X1			L77-2232-05	CRYSTAL RESONATOR		
R1			RK73FB2A101J	CHIP R 100	J 1/10W	
R4			RK73FB2A681J	CHIP R 680	J 1/10W	
R5			RK73FB2A332J	CHIP R 3.3K	J 1/10W	
R6			RK73FB2A221J	CHIP R 220	J 1/10W	
R7			RK73FB2A821J	CHIP R 820	J 1/10W	
R8			RK73FB2A100J	CHIP R 10	J 1/10W	E1E2E3
R8			RK73FB2A330J	CHIP R 33	J 1/10W	KPMX
R9			RK73FB2A391J	CHIP R 390	J 1/10W	
R10			RK73FB2A102J	CHIP R 1.0K	J 1/10W	
R11			RK73FB2A220J	CHIP R 22	J 1/10W	E1E2E3
R11			RK73FB2A330J	CHIP R 33	J 1/10W	KPMX
R12			RK73FB2A101J	CHIP R 100	J 1/10W	
R14			RK73FB2A101J	CHIP R 100	J 1/10W	E2E3
R14			RK73FB2A101J	CHIP R 100	J 1/10W	KPE1
R14			RK73FB2A271J	CHIP R 270	J 1/10W	MX
R15			RK73FB2A333J	CHIP R 33K	J 1/10W	E2E3
R15			RK73FB2A333J	CHIP R 33K	J 1/10W	KPE1
R16			RK73FB2A220J	CHIP R 22	J 1/10W	
R17			RK73FB2A362J	CHIP R 3.6K	J 1/10W	
R18			RK73FB2A302J	CHIP R 3.0K	J 1/10W	
R19			RK73FB2A822J	CHIP R 8.2K	J 1/10W	
R20			RK73FB2A392J	CHIP R 3.9K	J 1/10W	
R23			RK73FB2A153J	CHIP R 15K	J 1/10W	E1E2E3
R23			RK73FB2A332J	CHIP R 3.3K	J 1/10W	MX
R23			RK73FB2A472J	CHIP R 4.7K	J 1/10W	KP
R25			RK73FB2A183J	CHIP R 18K	J 1/10W	MX
R25			RK73FB2A223J	CHIP R 22K	J 1/10W	KP
R25			RK73FB2A273J	CHIP R 27K	J 1/10W	E1E2E3
R27 ,28			RK73FB2A432J	CHIP R 4.3K	J 1/10W	E1E2E3
R27 ,28			RK73FB2A622J	CHIP R 6.2K	J 1/10W	KP
R27 ,28			RK73FB2A752J	CHIP R 7.5K	J 1/10W	MX
R29			RK73FB2A101J	CHIP R 100	J 1/10W	M
R30			RK73FB2A561J	CHIP R 560	J 1/10W	M
R31			RK73FB2A473J	CHIP R 47K	J 1/10W	M
R32			RK73FB2A272J	CHIP R 2.7K	J 1/10W	KPM
R32			RK73FB2A272J	CHIP R 2.7K	J 1/10W	X
R33 ,34			RK73FB2A102J	CHIP R 1.0K	J 1/10W	
R35			RK73FB2A101J	CHIP R 100	J 1/10W	E1E2E3
R36			RK73FB2A102J	CHIP R 1.0K	J 1/10W	E1E2E3
R37			RK73FB2A392J	CHIP R 3.9K	J 1/10W	E1E2E3
R38			RK73FB2A102J	CHIP R 1.0K	J 1/10W	E1E2E3
R39			RK73FB2A103J	CHIP R 10K	J 1/10W	E1E2E3
R42			RK73FB2A103J	CHIP R 10K	J 1/10W	
R43			RK73FB2A221J	CHIP R 220	J 1/10W	
Δ R44			RD14NB2E271J	RD 270	J 1/4W	

L : Scandinavia K : USA P : Canada R : Mexico C : China I : Malaysia

Y : PX(Far East,Hawaii) T : England E : Europe G : Germany V : China(Shanghai)

Y : AAFES(Europe) X : Australia Q : Russia H : Korea M : Other Areas Δ indicates safety critical components .

PARTS LIST

AR-404/KRF-A4030/A4030E/A4030-S

* New Parts

Parts without **Parts No.** are not supplied.
 Les articles non mentionnés dans le **Parts No.** ne sont pas fournis.
 Teile ohne **Parts No.** werden nicht geliefert.

5

Ref. No	Add-ress	New Parts	Parts No.	Description	Desti-nation	Re-marks
R45			RK73EB2B102J	CHIP R 1.0K J 1/8W		
R46			RK73FB2A102J	CHIP R 1.0K J 1/10W		
R47			RK73EB2B102J	CHIP R 1.0K J 1/8W		
R48			RK73FB2A102J	CHIP R 1.0K J 1/10W		
R49			RK73FB2A103J	CHIP R 10K J 1/10W		
Δ R50			RD14NB2E471J	RD 470 J 1/4W		
R51			RK73FB2A562J	CHIP R 5.6K J 1/10W		
R52			RK73FB2A101J	CHIP R 100 J 1/10W		
R53			RK73FB2A222J	CHIP R 2.2K J 1/10W		
R54			RK73FB2A102J	CHIP R 1.0K J 1/10W		
R55			RK73FB2A333J	CHIP R 33K J 1/10W		
R56 .57			RK73FB2A102J	CHIP R 1.0K J 1/10W		
R58			RK73FB2A123J	CHIP R 12K J 1/10W		
R59			RK73FB2A122J	CHIP R 1.2K J 1/10W		
R72 .73			RK73FB2A153J	CHIP R 15K J 1/10W	KP	
R72 .73			RK73FB2A392J	CHIP R 3.9K J 1/10W	E1E2E3	
R72 .73			RK73FB2A822J	CHIP R 8.2K J 1/10W	MX	
R74			RK73FB2A473J	CHIP R 47K J 1/10W		
R75			RK73FB2A822J	CHIP R 8.2K J 1/10W		
R76			RK73FB2A182J	CHIP R 1.8K J 1/10W		
R78			RK73FB2A821J	CHIP R 820 J 1/10W		
R79			RK73FB2A332J	CHIP R 3.3K J 1/10W		
R80			RK73FB2A223J	CHIP R 22K J 1/10W	E1E2E3	
Δ R81			RS14KB3A151J	FL-PROOF RS 150 J 1W		
R82			RK73FB2A272J	CHIP R 2.7K J 1/10W	E2E3	
R82			RK73FB2A272J	CHIP R 2.7K J 1/10W	KPE1	
R83			RK73FB2A102J	CHIP R 1.0K J 1/10W		
R84			RK73EB2B102J	CHIP R 1.0K J 1/8W		
R85 -87			RK73FB2A105J	CHIP R 1.0M J 1/10W		
R88			RK73FB2A563J	CHIP R 56K J 1/10W		
R89			RK73FB2A333J	CHIP R 33K J 1/10W		
VR1			R32-0037-05	SEMI FIXED VARIABLE RESISTOR		
W51 .52			R92-0670-05	CHIP R 0 OHM		
W54 -56			R92-0670-05	CHIP R 0 OHM	M	
W54 .55			R92-0670-05	CHIP R 0 OHM	E1E2E3	
W54 .55			R92-0670-05	CHIP R 0 OHM	KPX	
W59			R92-0670-05	CHIP R 0 OHM	KPM	
W59 .60			R92-0670-05	CHIP R 0 OHM	X	
W62			R92-0670-05	CHIP R 0 OHM	E1E2E3	
W80			R92-0679-05	CHIP R 0 OHM		
W82 -85			R92-0679-05	CHIP R 0 OHM	KPM	
W82 -85			R92-0679-05	CHIP R 0 OHM	X	
W84 .85			R92-0679-05	CHIP R 0 OHM	E1E2E3	
D1			S62-0034-05	SLIDE SWITCH	M	
D1			DA204U	DIODE		
D1			MA143A	DIODE		
D3			1SS302	DIODE		
D3			HZS8.2N(B2)	ZENER DIODE		
D3			MTZJ8.2(B)	ZENER DIODE		
D4			HZS5.1N(B2)	ZENER DIODE		
D4			MTZJ5.1(B)	ZENER DIODE		
D5			HZS2.7N(B2)	ZENER DIODE		
D5			MTZJ2.7(B)	ZENER DIODE		

L : Scandinavia K : USA P : Canada R : Mexico C : China I : Malaysia
 Y : PX(Far East,Hawaii) T : England E : Europe G : Germany V : China(Shanghai)
 Y : AAFES(Europe) X : Australia Q : Russia H : Korea M : Other Areas Δ indicates safety critical components.

* New Parts

Parts without **Parts No.** are not supplied.
 Les articles non mentionnés dans le **Parts No.** ne sont pas fournis.
 Teile ohne **Parts No.** werden nicht geliefert.

6

Ref. No	Add-ress	New Parts	Parts No.	Description	Desti-nation	Re-marks
D8			MA111	DIODE		
D9			HZS3.3N(B2)	ZENER DIODE		
D9			MTZJ3.3(B)	ZENER DIODE		
D11			MA111	DIODE	E1E2E3	
D13			MA111	DIODE		
IC1			LA1837	ANALOGUE IC	E2E3	
IC1			LA1837	ANALOGUE IC	KPE1	
IC1			LA1838	ANALOGUE IC	MX	
IC2			LC72131	MOS-IC		
Q1			2SC4081(R,S)	TRANSISTOR		
Q1			2SD1819A(Q,R)	TRANSISTOR		
Q2			2SA1576A(R,S)	TRANSISTOR		
Q2			2SB1218A(Q,R)	TRANSISTOR		
Q3 .4			2SC4081(R,S)	TRANSISTOR	M	
Q3 .4			2SD1819A(Q,R)	TRANSISTOR	M	
Q6 .7			2SC4081(R,S)	TRANSISTOR	E1E2E3	
Q6 .7			2SD1819A(Q,R)	TRANSISTOR	E1E2E3	
Q10 .11			2SD1757K	TRANSISTOR		
Q12			2SA1576A(R,S)	TRANSISTOR		
Q12			2SB1218A(Q,R)	TRANSISTOR		
Q14			2SA1576A(R,S)	TRANSISTOR		
Q14			2SB1218A(Q,R)	TRANSISTOR		
A1			W02-2584-05	FM FRONT-END ASSY	E1E2E3	
A1			W02-2622-05	FM FRONT-END ASSY	KPM	
A1			W02-2622-05	FM FRONT-END ASSY	X	
AUDIO UNIT (X09-641X-XX)						
D527			B30-2513-05	LED(RED)		
C1 .2			CC45FSL1H390J	CERAMIC	39PF	J
C3 .4			CE04LW1C100M	ELECTRO	10UF	16WV
C5 .6			CC45FSL1H470J	CERAMIC	47PF	J
C7 .8			CE04LW1C470M	ELECTRO	47UF	16WV
C9 .10			CC45FSL1H470J	CERAMIC	47PF	J
C11 .12			CQ93FMG1H123J	MYLAR	0.012UF	J
C13 -16			CQ93FMG1H332J	MYLAR	3300PF	J
C17 -26			CC45FSL1H221J	CERAMIC	220PF	J
C27 .28			CE04KW1H2R2M	ELECTRO	2.2UF	50WV
C27 .28			CE04KW1H2R2M	ELECTRO	2.2UF	50WV
C27 .28			CE04KW1V4R7M	ELECTRO	4.7UF	35WV
C29			CK45FF1H103Z	CERAMIC	0.010UF	Z
C30			CC45FSL1H101J	CERAMIC	100PF	J
C30			CC45FSL1H101J	CERAMIC	100PF	J
C30			CQ93FMG1H103J	MYLAR	0.010UF	J
C31 .32			CC45FSL1H331J	CERAMIC	330PF	J
C33 -36			CE04LW1H3R3M	ELECTRO	3.3UF	50WV
C37 .38			CE04LW1C220M	ELECTRO	2.2UF	16WV
C37 .38			CE04LW1V4R7M	ELECTRO	4.7UF	35WV
C37 .38			CE04LW1V4R7M	ELECTRO	4.7UF	35WV
C39 .40			CC45FSL1H101J	CERAMIC	100PF	J
C41			CK45FF1H103Z	CERAMIC	0.010UF	Z
C42			CC45FSL1H101J	CERAMIC	100PF	J
C43 .44			CE04KW1H2R2M	ELECTRO	2.2UF	50WV
C45 .46			CK45FB1H681K	CERAMIC	680PF	K
C47 .48			CK45FF1H103Z	CERAMIC	0.010UF	Z

L : Scandinavia K : USA P : Canada R : Mexico C : China I : Malaysia
 Y : PX(Far East,Hawaii) T : England E : Europe G : Germany V : China(Shanghai)
 Y : AAFES(Europe) X : Australia Q : Russia H : Korea M : Other Areas Δ indicates safety critical components.

PARTS LIST

AR-404/KRF-A4030/A4030E/A4030-S

* New Parts

Parts without **Parts No.** are not supplied.
 Les articles non mentionnés dans le **Parts No.** ne sont pas fournis.
 Teile ohne **Parts No.** werden nicht geliefert.

⑦

Ref. No	Add-ress	New Parts	Parts No.	Description		Desti-nation	Re-marks
C49 ,50			CC45FSL1H101J	CERAMIC	100PF	J	
C51 ,52			CE04KW1A101M	ELECTRO	100UF	10WV	
C53 ,54			CC45FSL1H020C	CERAMIC	2.0PF	C	
C55 -58			CC45FSL1H101J	CERAMIC	100PF	J	
C59 ,60			CC45FSL2H470J	CERAMIC	47PF	J	
C61 ,62			CC45FSL1H101J	CERAMIC	100PF	J	
C63 ,64			CE04LW1H010M	ELECTRO	1.0UF	50WV	
C65 ,66			CQ93FMG1H104J	MYLAR	0.10UF	J	
C67 ,68			CQ93FMG1H224J	MYLAR	0.22UF	J	E2E3
C67 ,68			CQ93FMG1H224J	MYLAR	0.22UF	J	MXE1
C69 ,70			CK45FF1H103Z	CERAMIC	0.010UF	Z	
C71 -74			CK45FF1H472Z	CERAMIC	4700PF	Z	E1E2E3
C75			CK45FB1H102K	CERAMIC	1000PF	K	
C76 ,77			CC45FSL1H221J	CERAMIC	220PF	J	
C78			CE04LW1C101M	ELECTRO	100UF	16WV	
C79			CK45FB1H102K	CERAMIC	1000PF	K	
C80			CE04LW1V100M	ELECTRO	10UF	35WV	
C81			CE04LW1V331M	ELECTRO	330UF	35WV	
C82			CE04LW1V4R7M	ELECTRO	4.7UF	35WV	
C83 ,84			CC45FSL1H101J	CERAMIC	100PF	J	
C85 ,86			CE04LW1V100M	ELECTRO	10UF	35WV	
C87			CE04LW2A100M	ELECTRO	10UF	100WV	
C88			CE04LW2A470M	ELECTRO	47UF	100WV	
C89 ,90			CE04LW1E101M	ELECTRO	100UF	25WV	
C91			CE04LW1C101M	ELECTRO	100UF	16WV	
C92			CE04LW1V470M	ELECTRO	47UF	35WV	
C93			CE04LW1V102M	ELECTRO	1000UF	35WV	
C94			CE04LW1V470M	ELECTRO	47UF	35WV	
C95			CE04LW1V471M	ELECTRO	470UF	35WV	
C96 ,97			C90-3832-05	ELECTRO	4700UF	75WV	KPM
C96 ,97			C90-3832-05	ELECTRO	4700UF	75WV	X
C96 ,97			C90-3833-05	ELECTRO	4700UF	63WV	E1E2E3
C98 ,99			CK45FF1H103Z	CERAMIC	0.010UF	Z	
C100			CE04LW1V4R7M	ELECTRO	4.7UF	35WV	
C101			CE04LW1A221M	ELECTRO	220UF	10WV	
C102			CE04LW1C101M	ELECTRO	100UF	16WV	
C103			CE04LW1H010M	ELECTRO	1.0UF	50WV	
C104			CE04HW1E220M	NP-ELEC	22UF	25WV	
C105 ,106			CC45FSL1H101J	CERAMIC	100PF	J	
C107 ,108			CE04LW1V100M	ELECTRO	10UF	35WV	
C109			CK45FB1H102K	CERAMIC	1000PF	K	
C110			CE04LW1V100M	ELECTRO	10UF	35WV	
C111			C91-1480-05	MP	0.22UF	250WV	
C112 ,113			CK45FF1H103Z	CERAMIC	0.010UF	Z	
C114			CE04LW1A470M	ELECTRO	47UF	10WV	
C115 ,116			CE04LW1V4R7M	ELECTRO	4.7UF	35WV	
C117			CK45FB1H102K	CERAMIC	1000PF	K	
C118			CE04LW1C220M	ELECTRO	22UF	16WV	
C119			CK45FB1H102K	CERAMIC	1000PF	K	
C120			CE04LW1V100M	ELECTRO	10UF	35WV	
C121 ,122			CK45FF1H103Z	CERAMIC	0.010UF	Z	
C123 ,124			CE04LW1V4R7M	ELECTRO	4.7UF	35WV	
C125 ,126			CC45FSL2H101J	CERAMIC	100PF	J	KPM
C125 ,126			CC45FSL2H101J	CERAMIC	100PF	J	X
C127 ,128			CQ93FMG1H562J	MYLAR	5600PF	J	

L : Scandinavia K : USA P : Canada R : Mexico C : China I : Malaysia
 Y : PX(Far East,Hawaii) T : England E : Europe G : Germany V : China(Shanghai)
 Y : AAFES(Europe) X : Australia Q : Russia H : Korea M : Other Areas Δ indicates safety critical components .

* New Parts

Parts without **Parts No.** are not supplied.
 Les articles non mentionnés dans le **Parts No.** ne sont pas fournis.
 Teile ohne **Parts No.** werden nicht geliefert.

⑧

Ref. No	Add-ress	New Parts	Parts No.	Description		Desti-nation	Re-marks
C129 ,130		*	C91-1584-05	MF-C	0.82UF	J	
C131 ,132			CQ93FMG1H472J	MYLAR	4700PF	J	
C133			CE04HW1HR47M	NP-ELEC	0.47UF	50WV	
C134			CK45FB1H102K	CERAMIC	1000PF	K	
C135 ,136			CC45FSL1H221J	CERAMIC	220PF	J	E1E2E3
C137			CE04LW1V100M	ELECTRO	10UF	35WV	
C502			CK45FF1H103Z	CERAMIC	0.010UF	Z	
C503			CK45FB1H102K	CERAMIC	1000PF	K	E1E2E3
C504 ,505			CK45FF1H103Z	CERAMIC	0.010UF	Z	
C506			CK45FB1H102K	CERAMIC	1000PF	K	E1E2E3
C507			CK45FF1H103Z	CERAMIC	0.010UF	Z	
C508			CC45FSL1H101J	CERAMIC	100PF	J	E3
C508			CC45FSL1H101J	CERAMIC	100PF	J	XE1E2
C509		*	CE04RW0J101M	ELECTRO	100UF	6.3WV	
C510			CC45FSL1H331J	CERAMIC	330PF	J	E1E2E3
C511-514			CK45FF1H103Z	CERAMIC	0.010UF	Z	
C515			CK45FB1H561K	CERAMIC	560PF	K	E1E2E3
C516			CE04LW1H2R2M	ELECTRO	2.2UF	50WV	E1E2E3
C517			CE04LW1H010M	ELECTRO	1.0UF	50WV	
C518-520			CK45FF1H103Z	CERAMIC	0.010UF	Z	
C521			CC45FSL1H101J	CERAMIC	100PF	J	KPMX
C521			CC45FSL1H221J	CERAMIC	220PF	J	E1E2E3
C522			CK45FF1H103Z	CERAMIC	0.010UF	Z	E1E2E3
C523			CE04LW1A101M	ELECTRO	100UF	10WV	E1E2E3
C524			CK45FF1H103Z	CERAMIC	0.010UF	Z	E1E2E3
C525			CE04LW1H010M	ELECTRO	1.0UF	50WV	
C526			CE04LW1A101M	ELECTRO	100UF	10WV	
C527			CC45FCH1H470J	CERAMIC	47PF	J	E1E2E3
C528			CC45FCH1H180J	CERAMIC	18PF	J	E1E2E3
C529			CC45FSL1H101J	CERAMIC	100PF	J	M
C529			CC45FSL1H151J	CERAMIC	150PF	J	KP
C529			CC45FSL1H470J	CERAMIC	47PF	J	E3
C529			CC45FSL1H470J	CERAMIC	47PF	J	XE1E2
C531			CK45FF1H103Z	CERAMIC	0.010UF	Z	
C534			C90-1827-05	ELECTRO	0.047F	5.5WV	E2E3
C534			C90-1827-05	ELECTRO	0.047F	5.5WV	MXE1
C538 ,539			CC45FSL1H101J	CERAMIC	100PF	J	
C540			CE04RW1C100M	ELECTRO	10UF	16WV	
C541			CE04LW1A471M	ELECTRO	470UF	10WV	KP
C542			CC45FSL1H331J	CERAMIC	330PF	J	E3
C542			CC45FSL1H331J	CERAMIC	330PF	J	ME1E2
C545			CC45FSL1H101J	CERAMIC	100PF	J	
C549			CC45FSL1H271J	CERAMIC	270PF	J	E1E2E3
CN1			E40-4245-05	PIN ASSY			
CN2			E40-4245-05	PIN ASSY			E2E3
CN2			E40-4245-05	PIN ASSY			MXE1
CN6			E40-4281-05	PIN ASSY			M
CN7			E40-9848-05	PIN ASSY			
CN8 ,9			E40-8319-05	FLAT CABLE CONNECTOR			
CN10			E40-3247-05	PIN ASSY			
CN11 ,12			E40-4871-05	PIN ASSY			
CN21			E40-3261-05	PIN ASSY			
J1			E63-0068-15	PIN JACK			
J2 ,3			E63-0047-15	PIN JACK			

L : Scandinavia K : USA P : Canada R : Mexico C : China I : Malaysia
 Y : PX(Far East,Hawaii) T : England E : Europe G : Germany V : China(Shanghai)
 Y : AAFES(Europe) X : Australia Q : Russia H : Korea M : Other Areas Δ indicates safety critical components .

* New Parts

Parts without **Parts No.** are not supplied.

Les articles non mentionnés dans le **Parts No.** ne sont pas fournis.

Teile ohne **Parts No.** werden nicht geliefert.

9

Ref. No	Add-ress	New Parts	Parts No.	Description	Desti-nation	Re-marks
J4			E63-0116-05	PIN JACK		
J4			E63-0164-05	PIN JACK		
J5			E70-0047-05	LOCK TERMINAL BOARD		
J6			E11-0293-05	MINIATURE PHONE JACK(2P V)		
J7			E11-0127-05	PHONE JACK (3P)		
△ J8			E03-0148-05	AC OUTLET	KP	
△ J8			E03-0149-05	AC OUTLET	E3	
△ J8			E03-0149-05	AC OUTLET	ME1E2	
△ J8			E03-0325-05	AC OUTLET	X	
△ F1			F05-2525-05	FUSE (SEMKO) (250V T2.5AL)	E3M	
△ F1			F05-2525-05	FUSE (SEMKO) (250V T2.5AL)	XE1E2	
△ F1			F50-0076-05	FUSE(5X20)	KP	
△ F2			F05-2525-05	FUSE (SEMKO) (250V T2.5AL)	M	
△ F3			F05-2525-05	FUSE (SEMKO) (250V T2.5AL)	E1E2E3	
△ F4 ,5			F05-6313-05	FUSE (SEMKO) (250V T630MAL)	E2E3	
△ F4 ,5			F05-6313-05	FUSE (SEMKO) (250V T630MAL)	MXE1	
△ F4 ,5			F50-0066-05	FUSE(5X20)	KP	
-			J19-5928-13	HOLDER		
CN4 ,5			J13-0075-05	FUSE CLIP		
CN13-14			J13-0075-05	FUSE CLIP	M	
CN15,16			J13-0075-05	FUSE CLIP		
CN17,18			J13-0075-05	FUSE CLIP	E1E2E3	
CN19,20			J13-0075-05	FUSE CLIP		
E1			J11-0808-05	WIRE CLAMPER		
L1 ,2			L39-0085-05	PHASE COMPENSATION COIL	E1E2E3	
L501			L40-1091-17	SMALL FIXED INDUCTOR(1UH)	E1E2E3	
L502			L40-1001-17	SMALL FIXED INDUCTOR(10UH,K)	E1E2E3	
△ T1			L07-2575-05	POWER TRANSFORMER	E3	
△ T1			L07-2874-05	POWER TRANSFORMER	KP	
△ T1			L07-2875-05	POWER TRANSFORMER	XE1E2	
△ T1			L07-2876-05	POWER TRANSFORMER	M	
X501			L78-0290-05	RESONATOR (8MHZ)		
X502			L77-2002-05	CRYSTAL RESONATOR(4.332MHZ)	E1E2E3	
R63 ,64			RD14NB2E221J	RD 220 J 1/4W		
R67 ,68			RD14NB2E221J	RD 220 J 1/4W		
R69 ,70			RD14NB2E121J	RD 120 J 1/4W		
R75 ,76			RD14NB2E470J	RD 47 J 1/4W		
R81 ,82			RD14NB2E470J	RD 47 J 1/4W		
R89 ,90			RD14NB2E392J	RD 3.9K J 1/4W		
R93 ,94			RD14NB2E392J	RD 3.9K J 1/4W		
R99 ,100			RD14NB2E100J	RD 10 J 1/4W	E1E2E3	
R107 ,108			RS14KB3D391J	FL-PROOF RS 390 J 2W		
R111			RD14NB2E222J	RD 2.2K J 1/4W		
△ R114			R92-1844-05	CARBON 3.3M J 1/2W	KP	
△ R117			RD14NB2E4R7J	RD 4.7 J 1/4W		
△ R118,119			RD14NB2E101J	RD 100 J 1/4W		
△ R120			RS14KB3D221J	FL-PROOF RS 220 J 2W		
△ R141,142			RD14NB2E4R7J	RD 4.7 J 1/4W		
△ R156			RD14NB2E122J	RD 1.2K J 1/4W		
R168			RD14NB2E1R0J	RD 1 J 1/4W		
R182			RD14NB2E122J	RD 1.2K J 1/4W		
R207,208			RS14KB3D100J	FL-PROOF RS 10 J 2W		
R209			RD14NB2E561J	RD 560 J 1/4W	E1E2E3	

L : Scandinavia K : USA P : Canada R : Mexico C : China I : Malaysia
 Y : PX(Far East,Hawaii) T : England E : Europe G : Germany V : China(Shanghai)
 Y : AAFES(Europe) X : Australia Q : Russia H : Korea M : Other Areas △ indicates safety critical components .

* New Parts

Parts without **Parts No.** are not supplied.

Les articles non mentionnés dans le **Parts No.** ne sont pas fournis.

Teile ohne **Parts No.** werden nicht geliefert.

10

Ref. No	Add-ress	New Parts	Parts No.	Description	Desti-nation	Re-marks
R209			RD14NB2E561J	RD 560 J 1/4W	KPX	
R575,576			RD14NB2E221J	RD 220 J 1/4W		
R579			RD14NB2E101J	RD 100 J 1/4W		
VR1 ,2			R32-0030-05	SEMI FIXED VARIABLE RESISTOR		
△ K1			S76-0089-05	MAGNETIC RELAY		
△ K2 ,3			S76-0045-15	MAGNETIC RELAY		
△ S1			S68-0107-05	PUSH SWITCH	E2E3	
△ S1			S68-0107-05	PUSH SWITCH	MXE1	
△ S2 ,3			S62-0001-05	SLIDE SWITCH	M	
S501-506			S70-0031-05	TACT SWITCH		
S508			S70-0031-05	TACT SWITCH		
S510-515			S70-0031-05	TACT SWITCH		
S516			T99-0602-05	ROTARY ENCODER		
S517,518		*	T99-0630-05	ROTARY ENCODER		
D1			HZS5.1N(B2)	ZENER DIODE		
D1			MTZJ5.1(B)	ZENER DIODE		
D2			HZS4.7N(B2)	ZENER DIODE		
D2			MTZJ4.7(B)	ZENER DIODE		
D3			HSS104A	DIODE		
D3			1SS133	DIODE		
D4			HZS8.2N(B2)	ZENER DIODE		
D4			MTZJ8.2(B)	ZENER DIODE		
D5 ,6			HSS104A	DIODE		
D5 ,6			1SS133	DIODE		
D7 ,8			1SS244	DIODE		
D9 ,12			HSS104A	DIODE		
D9 ,12			1SS133	DIODE		
D13			HZS6.2N(B2)	ZENER DIODE		
D13			MTZJ6.2(B)	ZENER DIODE		
△ D14			HZS2.7N(B2)	ZENER DIODE		
△ D14			MTZJ2.7(B)	ZENER DIODE		
△ D15 -17			HSS104A	DIODE		
△ D15 -17			1SS133	DIODE		
D18			HZS5.6N(B2)	ZENER DIODE		
D18			MTZJ5.6(B)	ZENER DIODE		
△ D19			S1ZB20(4101)	DIODE		
D20 ,21			HZS16N(B2)	ZENER DIODE		
D20 ,21			MTZJ16(B)	ZENER DIODE		
△ D22			D4SBL20UF03	DIODE		
D23			HZS5.6N(B2)	ZENER DIODE		
D23			MTZJ5.6(B)	ZENER DIODE		
△ D24 -27			S5688B	DIODE		
△ D24 -27			1SR139-400	DIODE		
D28			HZS8.2N(B2)	ZENER DIODE		
D28			MTZJ8.2(B)	ZENER DIODE		
D31 ,32			HSS104A	DIODE		
D31 ,32			1SS133	DIODE		
D33 ,34			HZS13N(B2)	ZENER DIODE	KPMX	
D33 ,34			HZS15N(B2)	ZENER DIODE	E1E2E3	
D33 ,34			MTZJ13(B)	ZENER DIODE	KPMX	
D33 ,34			MTZJ15(B)	ZENER DIODE	E1E2E3	
D35 ,36			HZS18N(B2)	ZENER DIODE	KPMX	
D35 ,36			HZS20N(B2)	ZENER DIODE	E1E2E3	
D35 ,36			MTZJ18(B)	ZENER DIODE	KPMX	

L : Scandinavia K : USA P : Canada R : Mexico C : China I : Malaysia
 Y : PX(Far East,Hawaii) T : England E : Europe G : Germany V : China(Shanghai)
 Y : AAFES(Europe) X : Australia Q : Russia H : Korea M : Other Areas △ indicates safety critical components .

PARTS LIST

AR-404/KRF-A4030/A4030E/A4030-S

SPECIFICATIONS

For U.S.A. and Canada**[AUDIO section]**

Rated power output during STEREO operation

100 watts per channel minimum RMS, both channels driven, at 8 Ω from 40 Hz to 20 kHz with no more than 0.5 % total harmonic distortion. (FTC)
--

Total harmonic distortion 0.02 % (1 kHz, 50 W, 8 Ω)
 Signal to noise ratio (IHF'66)
 PHONO (MM) 75 dB
 CD 92 dB
 Input sensitivity / impedance
 PHONO (MM) 2.5 mV / 27 k Ω
 CD 200 mV / 47 k Ω
 Output level / impedance
 TAPE REC 200 mV / 2.2 k Ω
 PRE OUT (SUBWOOFER) 2 V / 2.2 k Ω
 Tone control
 BASS ± 9 dB (at 100 Hz)
 TREBLE ± 9 dB (at 10 kHz)

[FM tuner section]

Tuning frequency range 87.5 MHz ~ 108.0 MHz
 Usable sensitivity (MONO) 1.6 μ V (75 Ω)/15.2 dBf
 (75 kHz DEV., SINAD 30 dB)

50dB quieting sensitivity
 STEREO 31.6 μ V (75 Ω)/ 41.2 dBf
 Total harmonic distortion (1 kHz)
 MONO 0.6 % (65 dBf input)
 STEREO 0.7 % (65 dBf input)
 Signal to noise ratio (1 kHz, 75 kHz DEV.)
 MONO 75 dB (65 dBf input)
 STEREO 68 dB (65 dBf input)
 Stereo separation (1 kHz) 38 dB
 Selectivity (± 400 kHz) 65 dB
 Frequency response ... (30 Hz ~ 15kHz), +0.5 dB ~ -3.0 dB

[AM tuner section]

Tuning frequency range 530 kHz ~ 1,700 kHz
 Usable sensitivity (30% mod., S/N 20 dB)
 16 μ V / (600 μ V/m)
 Signal to noise ratio (30% mod. 1 mV input) 50 dB

[GENEAL]

Power consumption 2.8 A
 AC outlet
 SWITCHED 2 (total 150 W, 1.25 A max.)
 Dimensions W:440 mm (17-5/16")
 H:144 mm (5-11/16")
 D:389 mm (15-5/16")
 Weight (Net) 8.0 kg (17.6 lb)

For other countries**[AUDIO section]**

Effective power output during STEREO operation

1kHz, 10% T.H.D., at 8 Ω 140 W + 140 W

100 watts per channel minimum RMS, both channels driven, at 8 Ω from 40 Hz to 20 kHz with no more than 0.5 % total harmonic distortion.(FTC)

Total harmonic distortion 0.02 % (1 kHz, 50W, 8 Ω)
 Signal to noise ratio (IHF'66)
 PHONO (MM) 75 dB
 CD 92 dB
 Input sensitivity / impedance
 PHONO (MM) 2.5 mV / 27 k Ω
 CD 200 mV / 47 k Ω
 Output level / impedance
 TAPE REC 200 mV / 2.2 k Ω
 PRE OUT (SUBWOOFER) 2 V / 2.2 k Ω
 Tone control
 BASS ± 9 dB (at 100 Hz)
 TREBLE ± 9 dB (at 10 kHz)

[FM tuner section]

Tuning frequency range 87.5 MHz ~ 108.0 MHz
 Usable sensitivity (MONO 1.6 μ V (75 Ω)/ 15.2 dBf
 (75 kHz DEV., SINAD 30 dB)

50dB quieting sensitivity
 STEREO 31.6 μ V (75 Ω)/ 41.2 dBf
 Total harmonic distortion (1 kHz)
 MONO 0.6 % (65 dBf input)
 STEREO 0.7 % (65 dBf input)
 Signal to noise ratio (1 kHz, 75 kHz DEV.)
 MONO 75 dB (65 dBf input)
 STEREO 68 dB (65 dBf input)
 Stereo separation (1 kHz) 38 dB
 Selectivity (± 400 kHz) 65 dB
 Frequency response (30 Hz~15kHz), +0.5 dB ~ -3.0 dB

[AM tuner section]

Tuning frequency range
 9 kHz step 531 kHz ~ 1,602 kHz
 10 kHz step (except Australia) ... 530 kHz ~ 1,610 kHz
 Usable sensitivity (30% mod., S/N 20 dB)
 16 μ V / (600 μ V/m)
 Signal to noise ratio (30% mod. 1 mV input) 50 dB

[GENEAL]

Power consumption 280 W
 AC outlet
 SWITCHED (for Australia) 1 (total 150 W max.)
 SWITCHED (except Australia) ... 2 (total 150 W max.)
 Dimensions W:440 mm (17-5/16")
 H:144 mm (5-11/16")
 D:389 mm (15-5/16")
 Weight (Net) 8.0 kg (17.6 lb)

Notes:

1. KENWOOD follows a policy of continuous advancements in development. For this reason specifications may be changed without notice.
2. The full performance may not be exhibited in an extremely cold location (under a water-freezing temperature).

AR-404/KRF-A4030/A4030E/A4030-S

Note:

Component and circuit are subject to modification to insure best operation under differing local conditions. This manual is based on Europe (E) standard, and provides information on regional circuit modification through use of alternate schematic diagrams, and information on regional component variations through use of parts list.

KENWOOD CORPORATION

14-6, Dogenzaka 1-chome, Shibuya-ku, Tokyo, 150-8501 Japan

KENWOOD SERVICE CORPORATION

P.O. BOX 22745, 2201 East Dominguez St., Long Beach, CA 90801-5745, U.S.A.

KENWOOD ELECTRONICS CANADA INC.

6070 Kestrel Road, Mississauga, Ontario, Canada L5T 1S8

KENWOOD ELECTRONICS LATIN AMERICA S.A.

P.O. BOX 55-2791, Piso 6 plaza Chase, Cl. 47 y Aquilino de la Guardia Panama, Republic de Panama

KENWOOD ELECTRONICS BRASIL LTDA.

Av. Moema, 170-17, Andar-Cobertura "B", Ed. Maximum Service Center, 04077-020 Moema, São Paulo-SP-Brasil

KENWOOD ELECTRONICS U.K. LIMITED

KENWOOD House, Dwight Road, Watford, Herts., WD1 8EB., United Kingdom

KENWOOD ELECTRONICS BELGUM N.V.

Meachelsesteenweg 418, B-1930 Zaventem, Belgium

KENWOOD ELECTRONICS DEUTSCHLAND GMBH

Rembrücker Str. 15, 63150 Heusenstamm, Germany

KENWOOD ELECTRONICS FRANCE S.A.

13 Boulevard Ney, 75018 Paris, France

KENWOOD ELECTRONICS ITALIA S.p.A.

Via G. Sirtori, 7/9 20129, Milano, Italy

KENWOOD IBÉRICA S.A.

Bolivia, 239-08020 Barcelona, Spain

KENWOOD ELECTRONICS AUSTRALIA PTY. LTD.

(A.C.N. 001 499 074)

16 Giffnock Avenue, North Ryde, N.S.W. 2113, Australia

KENWOOD ELECTRONICS (HONG KONG) LTD.

Unit 3712-3724, Level 37, Tower 1, Metroplaza, 223 Hing Fong Road, Kwai Fong N.T., Hong Kong

KENWOOD ELECTRONICS GULF FZE

P.O. Box 61318, Jebel Ali, Dubai, U.A.E.

KENWOOD ELECTRONICS SINGAPORE PTE LTD.

No. 1 Genting Lane #02-02, KENWOOD Building, Singapore, 349544

KENWOOD ELECTRONICS (MALAYSIA) SDN BHD.

#4.01 Level 4, Wisma Academy Lot 4A, Jalan 19/1 46300 Petaling Jaya Selangor Darul Ehsan Malaysia

KENWOOD ELECTRONICS (THAILAND) CO., LTD.

2019 New Pechburi Road, Bangkapi, Huaykwang, Bangkok, 10320 Thailand