

(X09-363X-XX) (A/3)

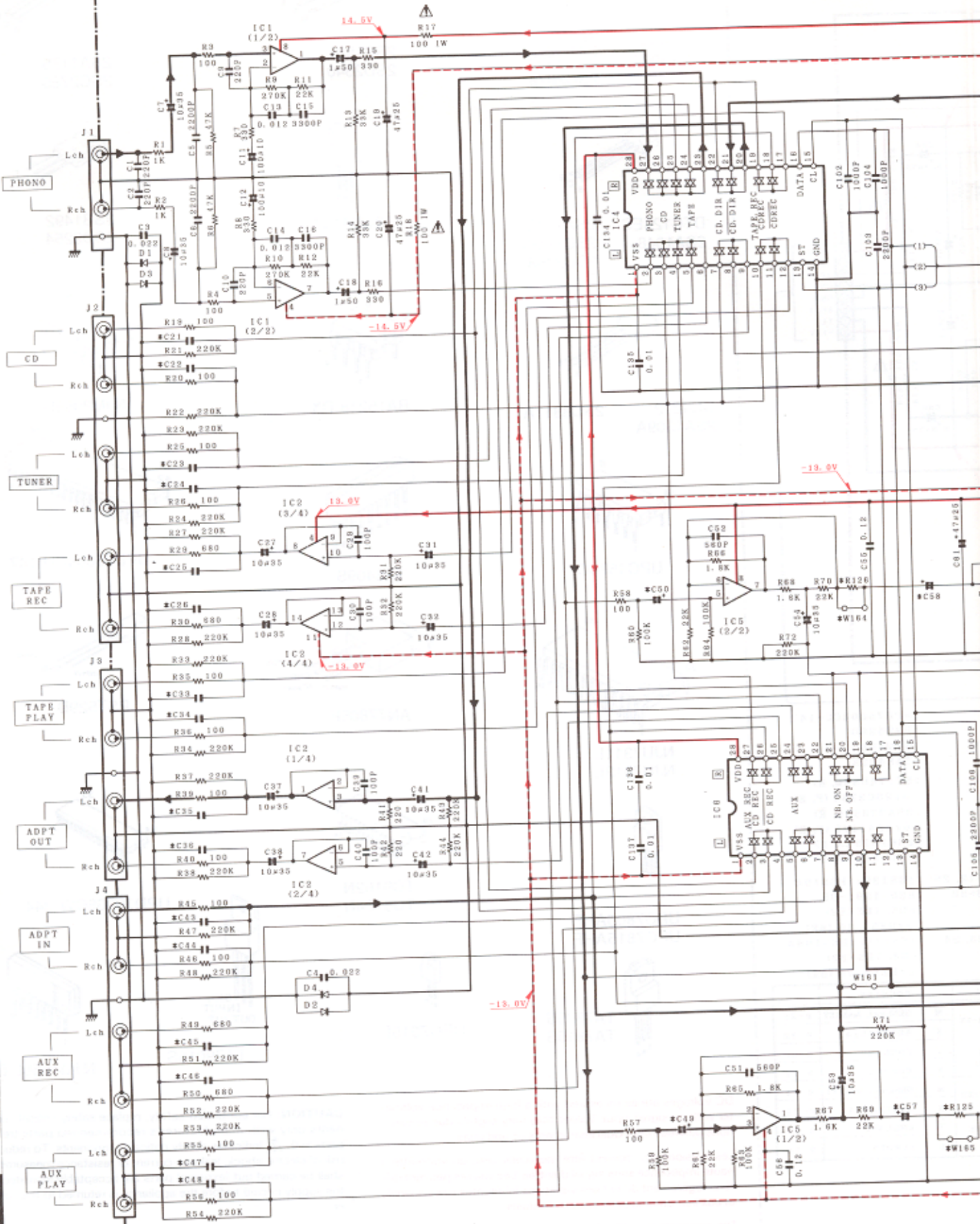

Kenwood
A-8177

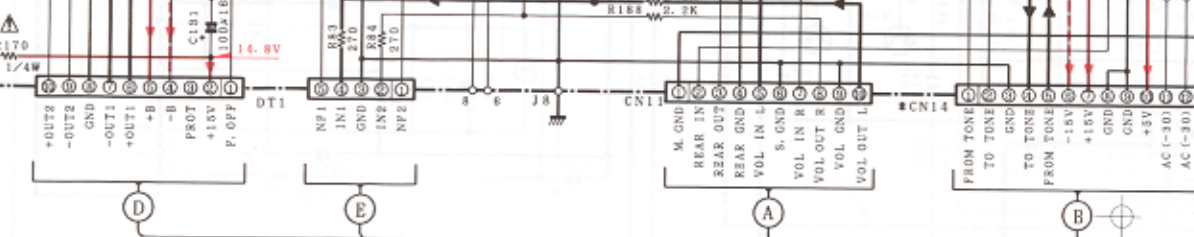

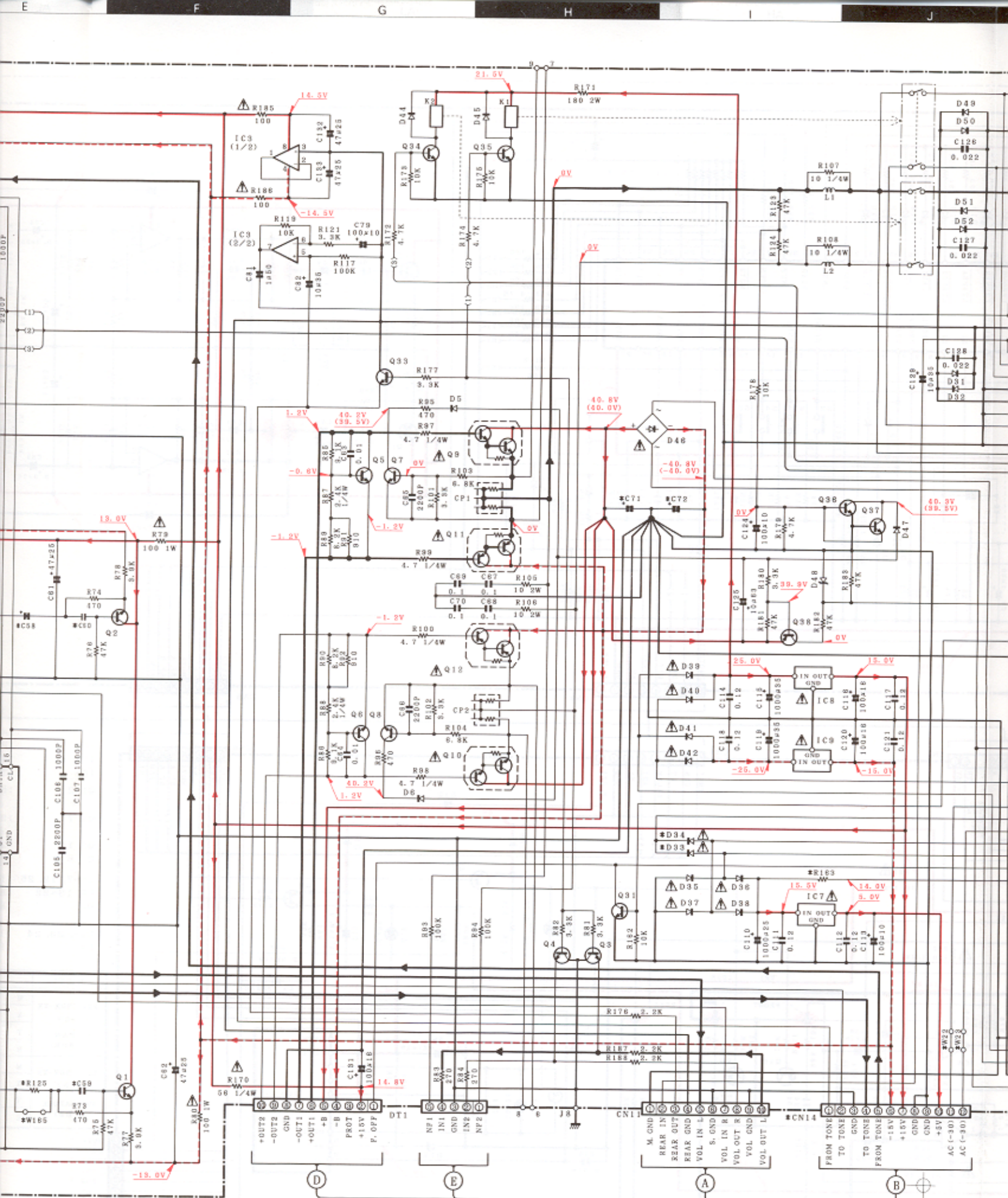

DT1 X85-12XX-XX

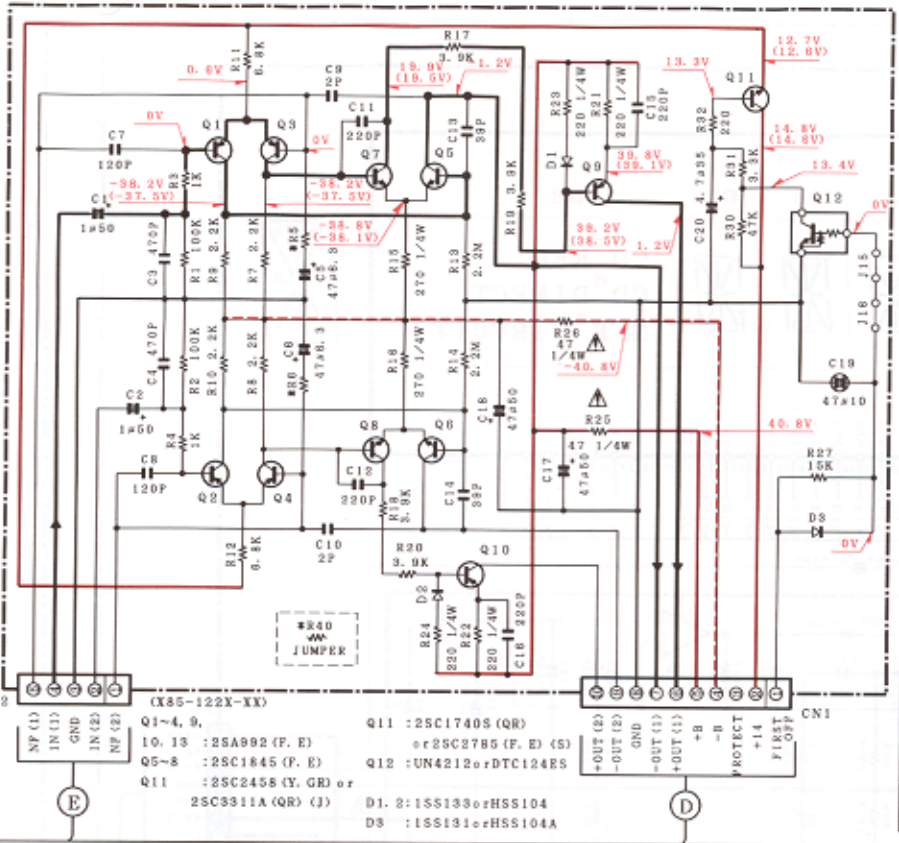
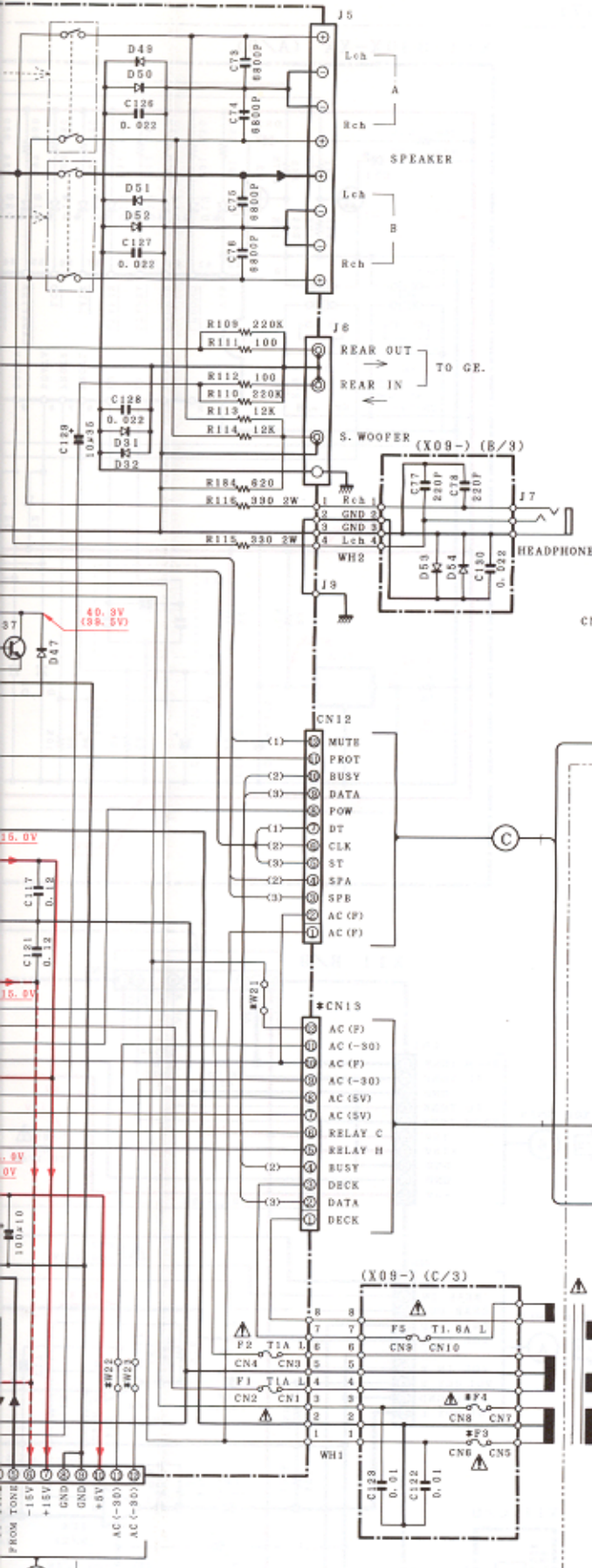

(M TYPE ONLY)

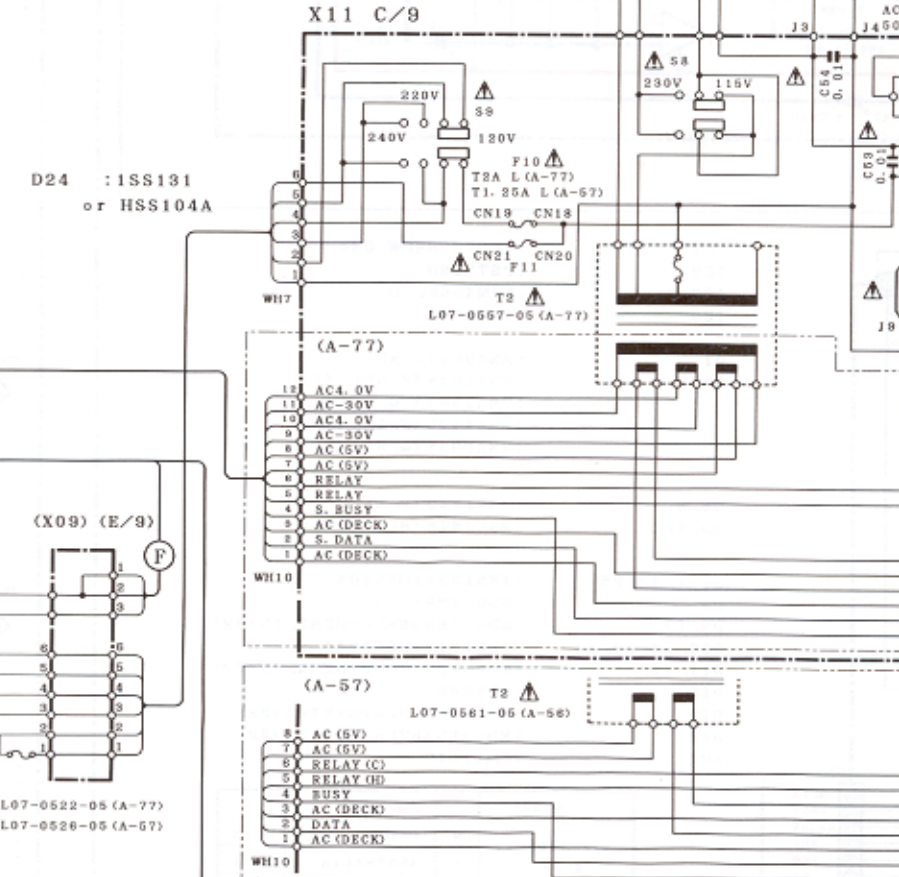

(X85-12XX-XX)
 MO...
 A-7 JAPA...
 MAD...
 A-7 SINGAP...
 MAD...
 A-5...

DX or BA15218-DX	Q1, 2, 7, 8	: 2SC1845 (F, E)	D1~6, 31, 32	
or NJM2058D	Q3, 4, 33	: 2SC2878 (A, B)	44, 45,	
or TC9164N	Q5, 6	: 2SC4137 (V, W)	47, 48~54	: 1SS133 or HSS104
or TC9162N	Q9, 10	: 2SD2254 (A-77)	D35~42	: S5688B or
or TA7805S or		2SD2340 (A-57)		1SR199-100
or TA7805S or	Q11, 12	: 2SB1492 (A-77)	D46	: RBV-602LFA or
or PC7815AHF		2SB1531 (A-57)		D55BA20F03
	Q31, 34~37	: 2SC2003 (L, K)	D48	: RD4.7ES (B2) or
	Q98	: 2SA938S (Q, R) or		HZS4.7N (B2)
		2SA1175 (F, E)		

ENTRY	CN13	CN14	D33, 34	C21~26, 33~36, 43~44	C49, 50	C57, 58	C59, 60	C71, 72	R125	R128	R163	F3, 4	W21~23	
L MARKET LIA	0-23	12P	12P	NO	0.047μ	4.7μ35	0.1μ	6800μ63	W165	W164				
D	2-72	12P	12P		220P	10μ35	1μ	0.33μ	6800μ63	4.7K	4.7K			
L MARKET LIA	0-21	12P	12P	NO	0.047μ	4.7μ35	0.1μ	6800μ63	W165	W164	47 2W	T4A L	YES	
D	2-70	12P	12P		220P	10μ35	1μ	0.33μ	6800μ63	4.7K	4.7K			
L MARKET LIA	0-22	8P	10P	NO	0.1μ	4.7μ35	0.1μ	5600μ	2.2K	2.2K				
D	2-71	8P	10P		220P	10μ35	1μ	0.33μ	5600μ	2.0K	2.0K			
L MARKET LIA	0-24	8P	10P	YES	NO	0.1μ	4.7μ35	0.1μ	5600μ	2.2K	2.2K	82 2W	T2.5A L	NO
D	2-73	8P	10P		220P	10μ35	1μ	0.33μ	5600μ	2.0K	2.0K			

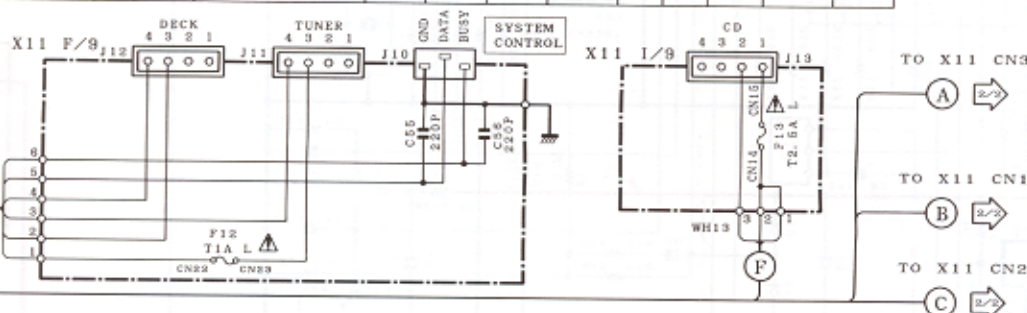

(E, T, X TYPE ONLY)

X11 D/9

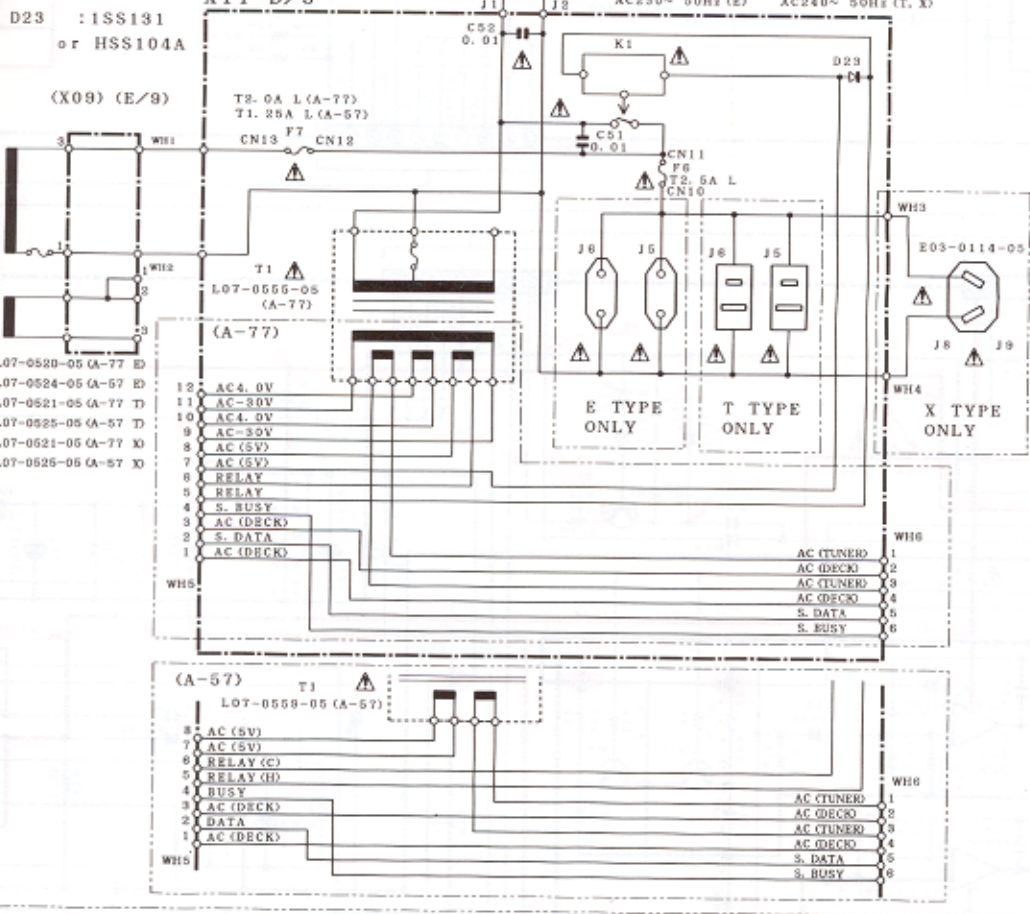

DC voltages are as measured with a high impedance voltmeter with no signal input. Values may vary slightly due to variations between individual instruments or/and units.

Les tensions c.c. doivent être mesurées avec un voltmètre haute impédance sans signal d'entrée. Les valeurs peuvent différer légèrement du fait des variations inhérentes aux appareils et aux instruments de mesure individuels.

Die angegebenen Gleichspannungswerte wurden mit einer hochohmigen Spannungsmesser ohne Eingangssignal gemessen. Dabei schwanken die Meßwerte aufgrund von Unterschieden zwischen einzelnen Instrumenten oder Geräten um U. geringfügig.

CAUTION: For continued safety, replace safety critical components only with manufacturer's recommended parts (refer parts list). ⚠ Indicates safety critical components. To reduce risk of electric shock, leakage-current or resistance measurement shall be carried out (exposed parts are acceptably insulated from the supply circuit) before the appliance is returned to the customer.

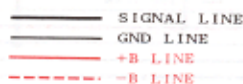

X11-33XX-XX (A/9)

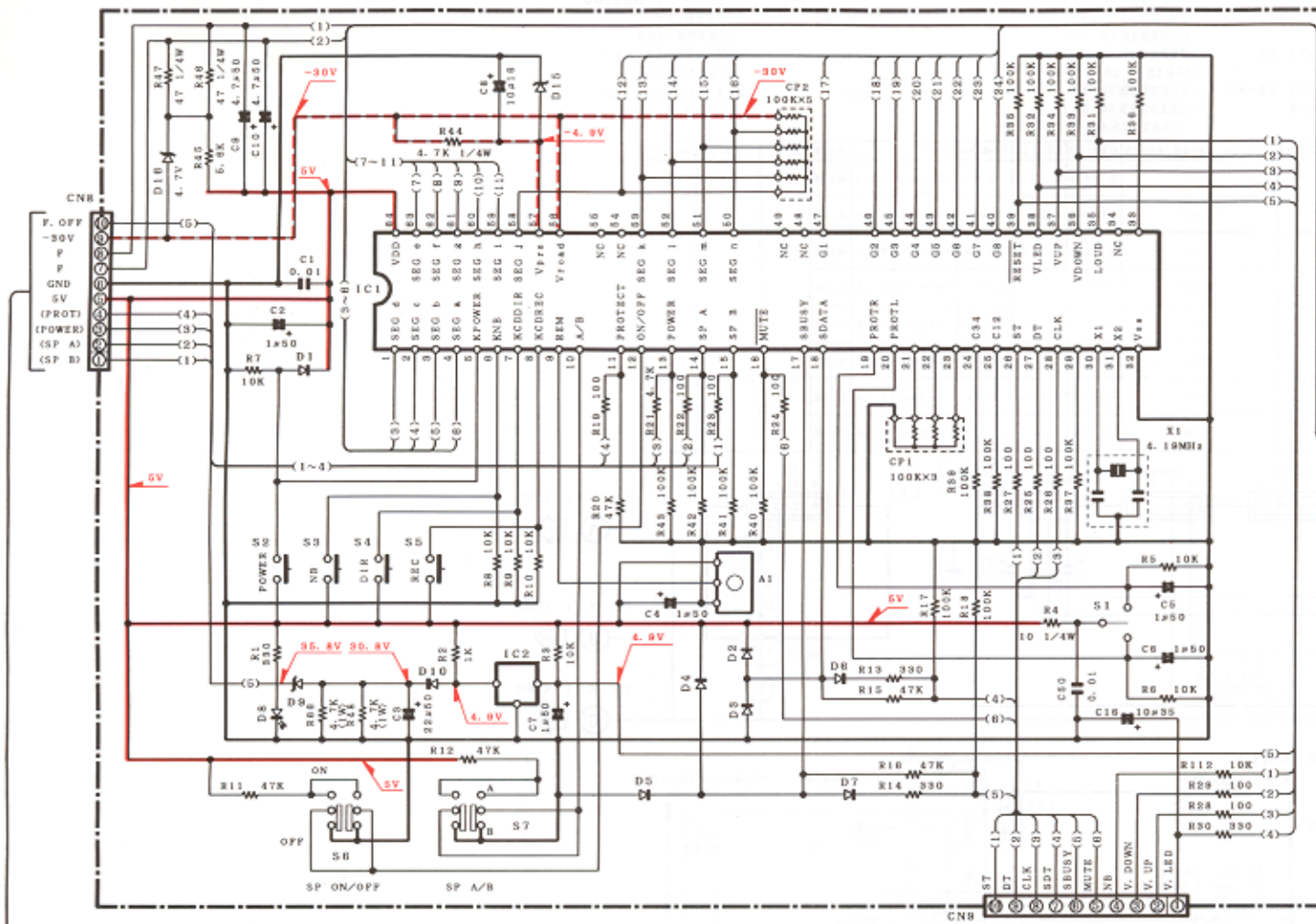

X11 B/9

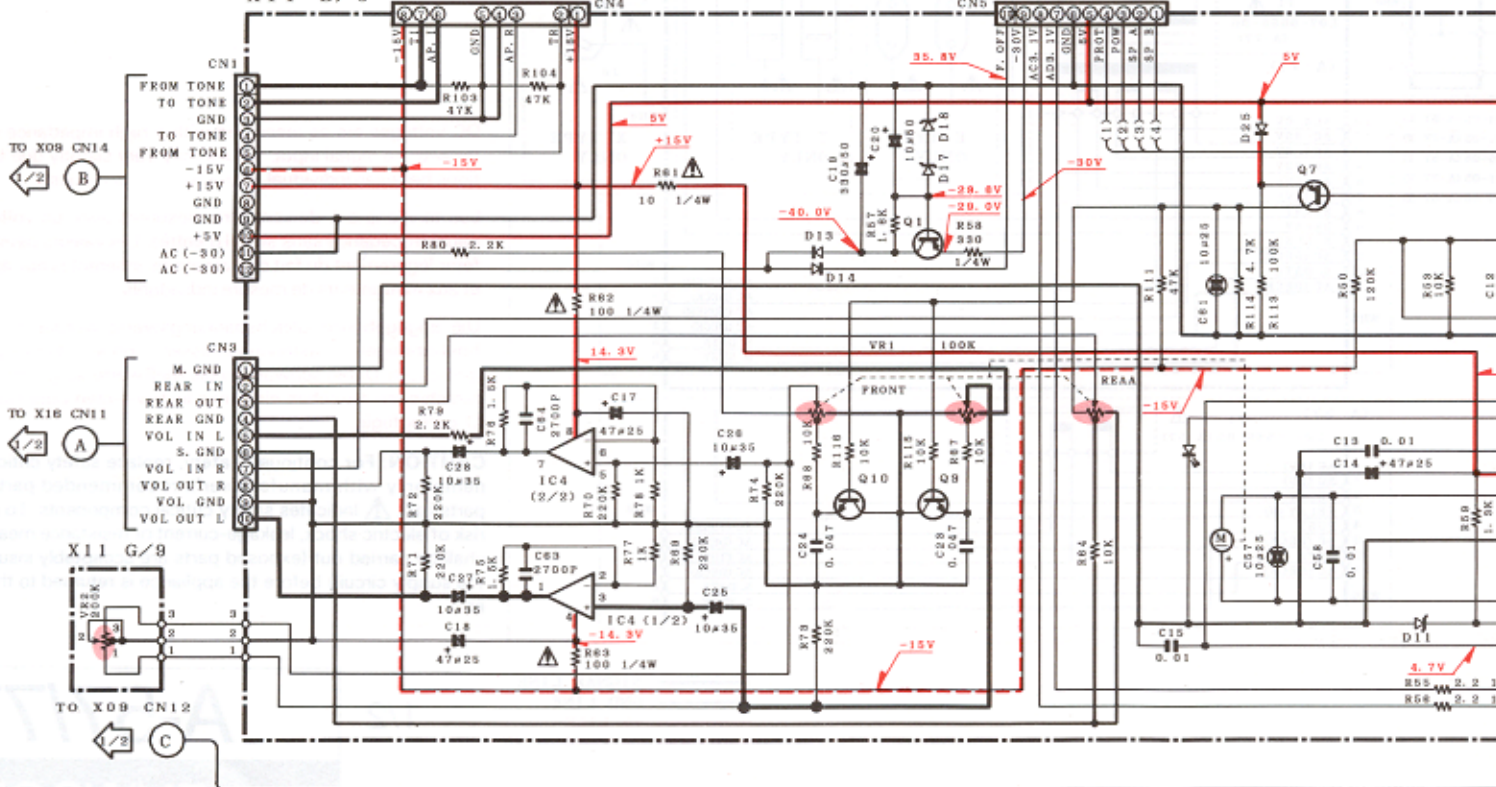

X11 G/9

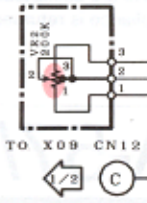

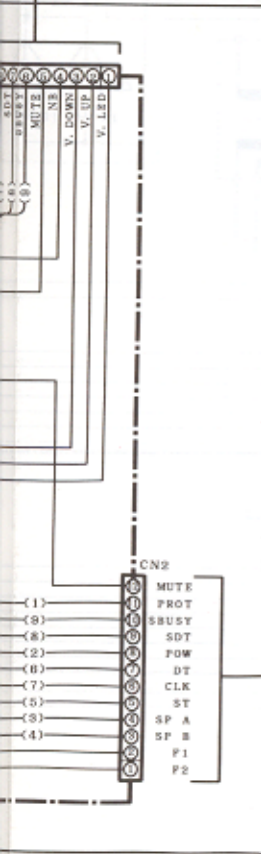
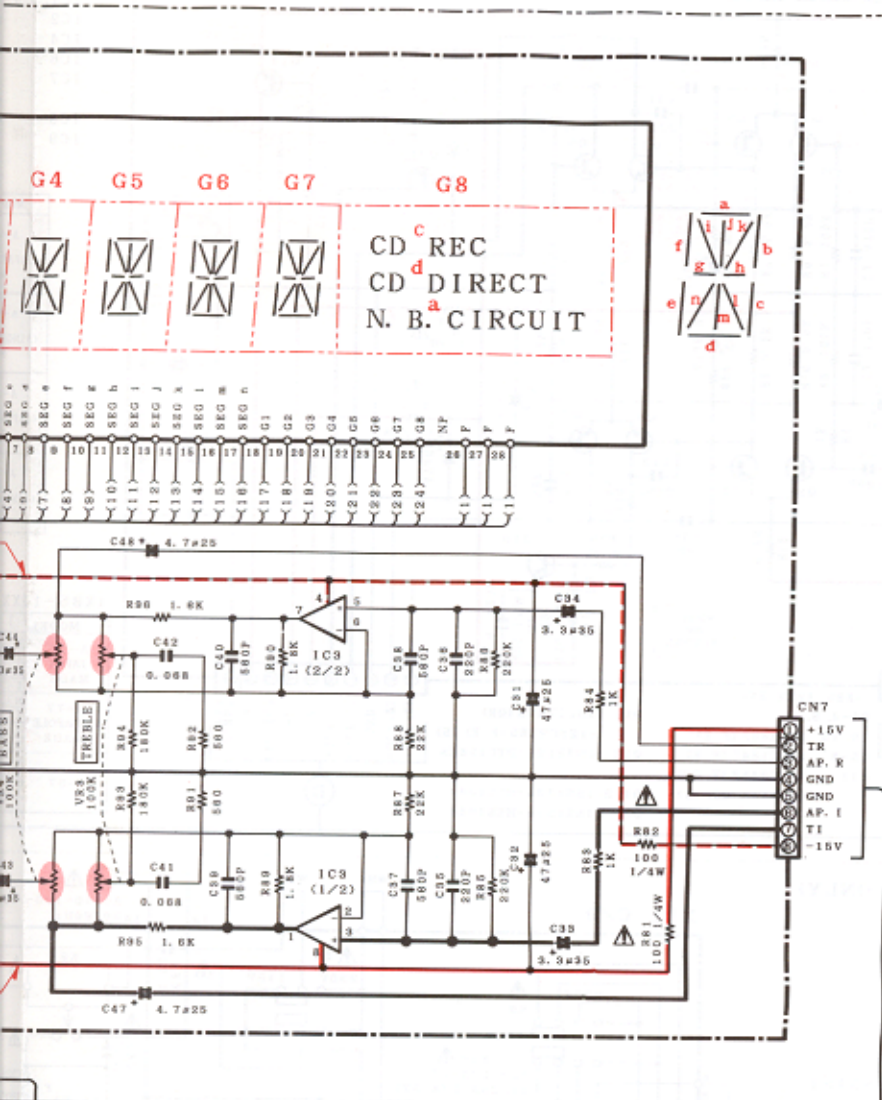

- IC1 : #PD75288CW-044
- IC2 : PST529D
- IC3, 4 : NJM4565L-D
- IC5 : TA8409S

- Q1, 7 : 2SA954 (L, K)
- Q3, 7 : 2SA1048 (Y, GR) (J)
- : 2SA1309A (Q, R) (J)
- : 2SA1175 (F, E) (S)
- : 2SA933S (Q, R) (S)

- Q5, 6 : 2SC1845 (F, E)
- Q9, 10 : 2SC2878 (B)

- D1~7, 12, 25 : ISS133 or HSS104
- D8 : B30-1291-05
- D9, 15 : RD5.1ES (B2) or HZS5.1N (B2)
- D10, 14, 23, 24 : ISS131 or HSS104A
- D11, 16 : RD4.7ES (B2) or HZS4.7N (B2)
- D13 : S5688B
- D17 : RD16ES (B2) or HZS16N (B2)
- D18 : RD13ES (B2) or HZS13N (B2)
- ED1 : CM1154C

MODEL	COUNTRY	
X11-332X-XX A-77 (JAPAN MADE)	M	GENERAL MARKET 0-21
	X	AUSTRALIA 0-71
	T	ENGLAND 0-51
X11-334X-XX A-77 (SINGAPORE MADE)	E	EUROPE 2-70
	M	GENERAL MARKET 0-21
	X	AUSTRALIA 0-71
	T	ENGLAND 0-51
	E	EUROPE 2-70

(A-57)

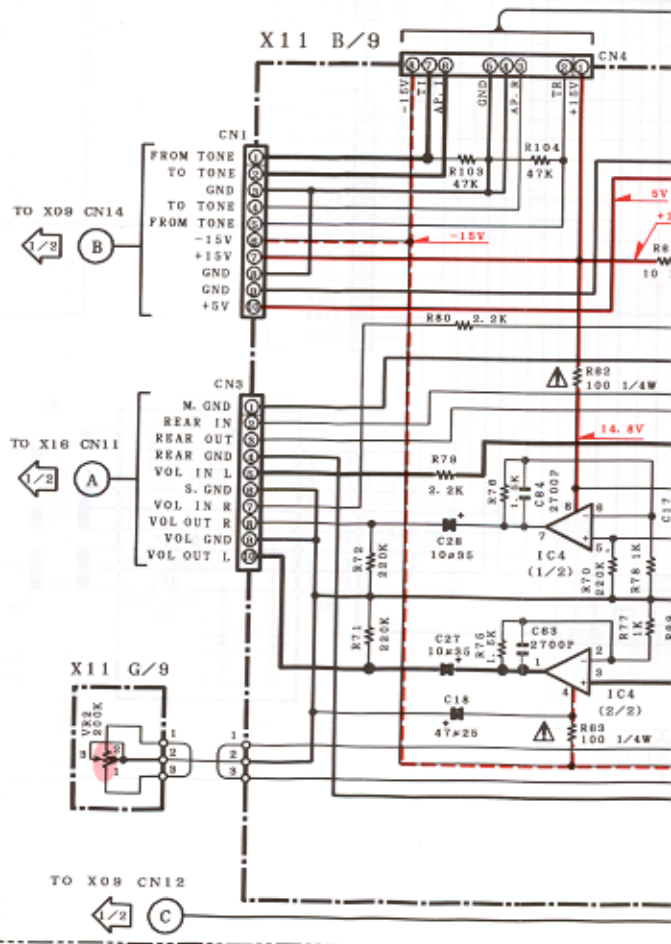
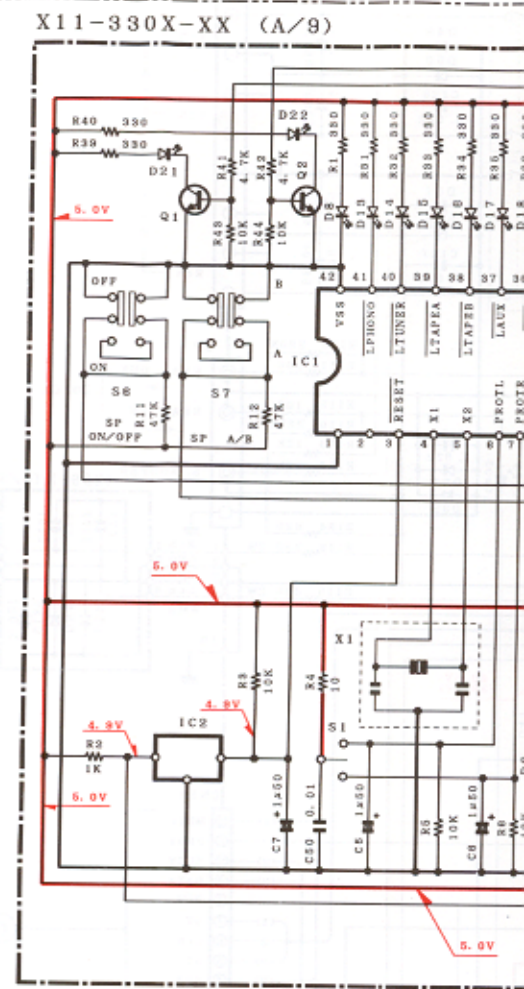

(A-57)

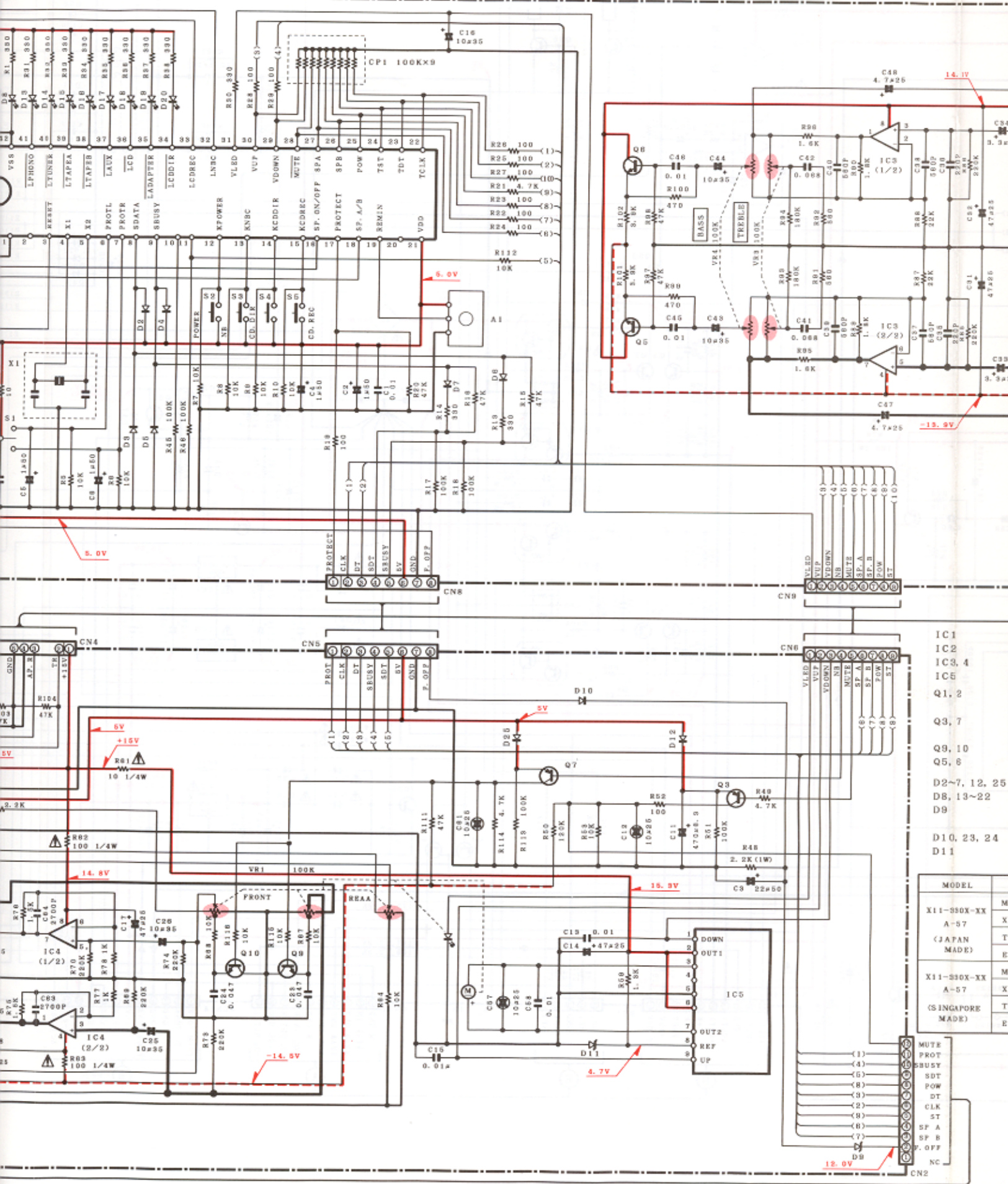

- IC 1
- IC 2
- IC 3, 4
- IC 5
- Q1, 2
- Q3, 7
- Q9, 10
- Q5, 6
- D2-7, 12, 25
- D8, 13-22
- D9
- D10, 23, 24
- D11

MODEL	
X11-330X-XX	M
A-57	X
(JAPAN MADE)	T
	E
X11-330X-XX	M
A-57	X
(SINGAPORE MADE)	T
	E



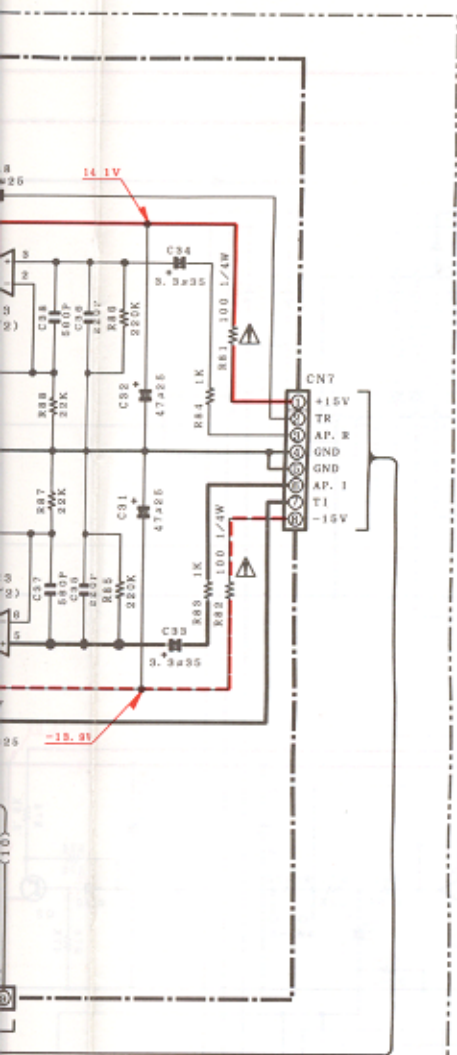

- IC1 : #PD75004CU-147
- IC2 : PST529D
- IC3, 4 : NJM4565L-D
- IC5 : TA8409S
- Q1, 2 : SC1740S (Q, R)
or 2SC2785 (F, E)
- Q3, 7 : 2SA933S (Q, R)
or 2SA1175 (F, E)
- Q9, 10 : 2SC2878 (A, B)
- Q5, 6 : 2SC1845 (F, E)
- D2-7, 12, 25 : ISS133 or HSS104
- D8, 13-22 : B30-1291-05
- D9 : RD5.1ES (B2)
or HZS5.1N (B2)
- D10, 23, 24 : ISS131 or HSS104A
- D11 : RD4.7ES (B2)
or HZS4.7N (B2)

MODEL	COUNTRY	
X11-330X-XX A-57 (JAPAN MADE)	M	GENERAL MARKET 0-22
	X	AUSTRALIA 0-72
	T	ENGLAND 0-52
	E	EUROPE 2-71
X11-330X-XX A-57 (SINGAPORE MADE)	M	GENERAL MARKET 0-21
	X	AUSTRALIA 0-71
	T	ENGLAND 0-51
	E	EUROPE 2-70

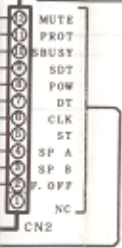

2SA954
2SA992

2SC1845
2SC2003
2SC2878

2SB1531
2SD2340

2SA1175
2SC2785

DTC124ES
2SA1048

2SA933S
2SC1740C
2SC2458

2SC4137

2SB1492
2SD2254

UN4212
2SA1309A

2SC3311A

BA15218-DX

NJM2058D

UPC4574C

TA8409S

UPD75004CU-147

AN77805F

PST529D

NJU7311L
NJU7313L

TC9162N
TC9164N

UPD75268CW-044

UPC7805AHF
UPC7815AHF

TA7805S
TA7815S

UPC7915F

TA79015S

NJM4565L-D

DC voltages are as measured with a high impedance voltmeter with no signal input. Values may vary slightly due to variations between individual instruments or/and units.

Les tensions c.c. doivent être mesurées avec un voltmètre à haute impédance sans signal d'entrée. Les valeurs peuvent différer légèrement du fait des variations inhérentes aux appareils et aux instruments de mesure individuels.

Die angegebenen Gleichspannungswerte wurden mit einem hochohmigen Spannungsmesser ohne Eingangssignal gemessen. Dabei schwanken die Meßwerte aufgrund von Unterschieden zwischen einzelnen Instrumenten oder Geräten u. U. geringfügig.



CAUTION: For continued safety, replace safety critical components only with manufacturer's recommended parts (refer to parts list). Indicates safety critical components. To reduce the risk of electric shock, leakage-current or resistance measurements shall be carried out (exposed parts are acceptably insulated from the supply circuit) before the appliance is returned to the customer.

A-57/77

KENWOOD

A-57/77

EXPLODED VIEW (UNIT)

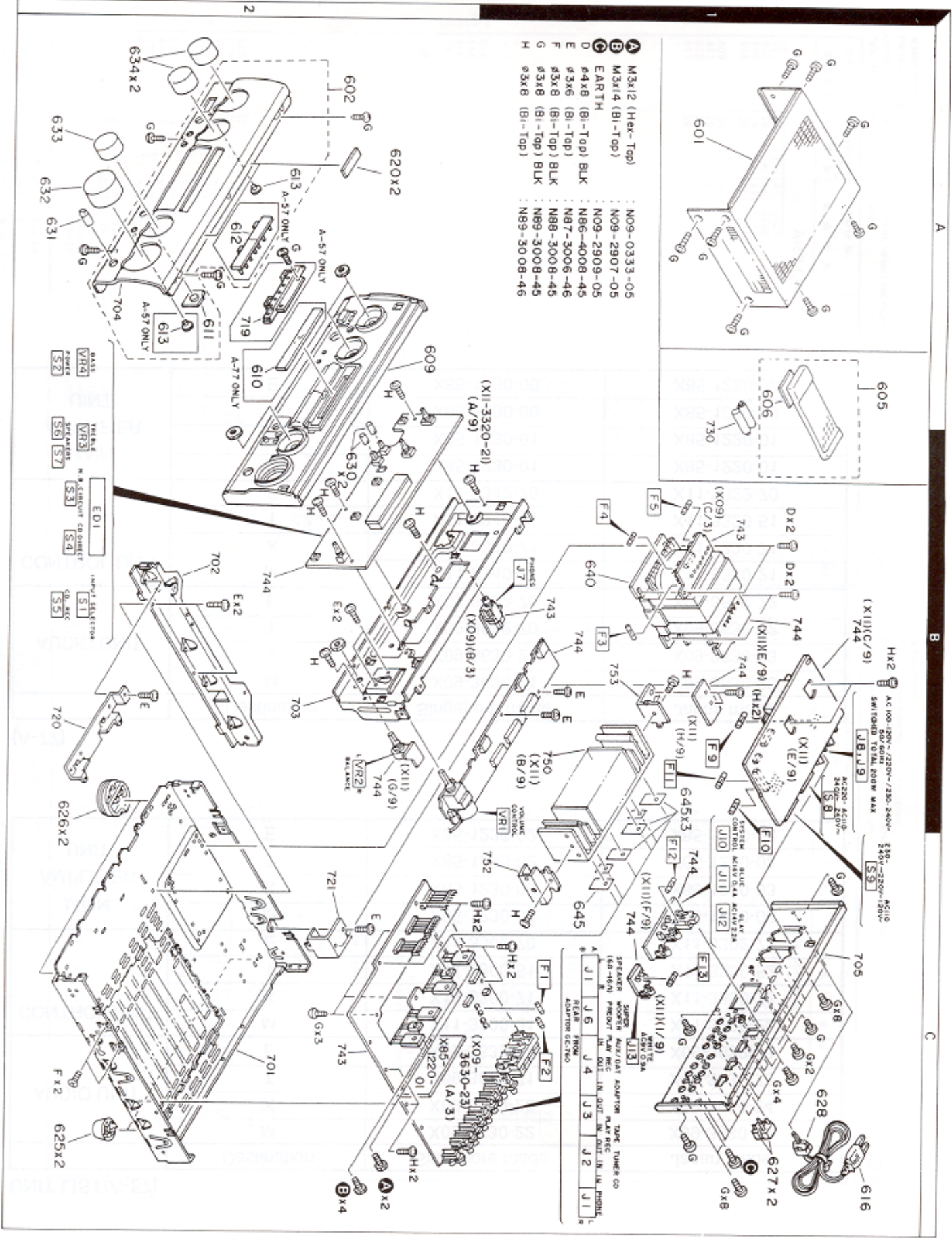

- A M3x12 (Hex-Top) : N09-0333-05
- B M3x14 (Bl-Top) : N09-2907-05
- C EARTH : N09-2909-05
- D #4x8 (Bl-Top) BLK : N86-4008-45
- E #3x6 (Bl-Top) : N87-3006-46
- F #3x8 (Bl-Top) BLK : N88-3008-45
- G #3x8 (Bl-Top) BLK : N89-3008-45
- H #3x8 (Bl-Top) : N89-3008-46

Parts with the exploded numbers larger than 700 are not supplied. 25

* New Parts
Parts without Parts No. are not supplied.
Les articles non mentionnés dans le Parts No. ne sont pas fournis.
Teil ohne Parts No. werden nicht geliefert.

NO.1

A-57 (JAPAN MADE)

Ref. No.	Address	Part No.	Description	Desti- nation	Re- marks
参照番号	位置	部品番号	部品名/規格	仕 向	備考
601	1A	A01-2948-01	METALLIC CABINET		
602	2A	A40-0488-02	PANEL ASSY		
605	1A	X94-1001-41	REMOTE CONTROL ASSY UNIT		
606	1B	A09-0115-13	BATTERY COVER		
609	2A	B01-0487-11	PANEL ESCUTCHEON		
611	2A	B12-0201-04	INDICATOR		
612	2A	B12-0202-04	INDICATOR		
613	2A	B19-1520-04	LIGHTING BOARD		
		B46-0096-33	WARRANTY CARD		
		B46-0310-03	WARRANTY CARD		
		B52-0528-00	CONNECTING DIAGRAM		
		B52-0529-00	CONNECTING DIAGRAM		
		B60-1302-00	INSTRUCTION MANUAL (ENGLISH)		
		B60-1303-00	INSTRUCTION MANUAL (FRENCH)		
		B60-1304-00	INSTRUCTION MANUAL (GERMAN)		
		B60-1305-00	INSTRUCTION MANUAL (DUTCH)		
		B60-1306-00	INSTRUCTION MANUAL (ITALIAN)		
		B60-1307-00	INSTRUCTION MANUAL (SPANISH)		
		B60-1308-00	INSTRUCTION MANUAL (ENGLISH)		
		B60-1309-00	INSTRUCTION MANUAL (SPANISH)		
		B60-1310-00	INSTRUCTION MANUAL (CHINESE)		
616	1C	E30-2277-15	AC POWER CORD		
616	1C	E30-2715-05	AC POWER CORD		
616	1C	E30-2719-05	AC POWER CORD		
616	1B	E03-0141-05	AC OUTLET		
620	2A	011-0155-14	SGRT TAPE (40X9X2)		
		H50-0774-04	ITEM CARTON CASE		
		H50-0775-04	ITEM CARTON CASE		
		H10-5603-02	POLYSTYRENE FOAMED FIXTURE L		
		H10-5604-02	POLYSTYRENE FOAMED FIXTURE R		
		H10-5605-02	POLYSTYRENE FOAMED FIXTURE L		
		H10-5606-02	POLYSTYRENE FOAMED FIXTURE R		
		H13-0110-04	CARTON BOARD		
		H25-0232-04	PROTECTION BAG (235X350X0.03)		
		H25-0304-04	PROTECTION BAG		
		H25-0651-04	PROTECTION BAG (0232 PRINTED)		
		H25-0654-04	PROTECTION BAG (0304 PRINTED)		
625	2C	J02-0364-15	FOOT		
626	2C	J02-1040-05	FOOT		
627	2C	J12-0091-05	FRONT PIN		
628	1C	J42-0083-05	POWER CORD BUSHING		
630	2B	K27-2081-14	KNOB SPEAKER SW/GRF. A/B		
631	2A	K29-2507-04	KNOB BALANCE		
632	2A	K29-4403-04	KNOB VOLUME CONTROL		
633	2A	K29-4404-04	KNOB INPUT SELECTOR		
634	2A	K29-4405-04	KNOB BASS/TREBLE		
640	1B	L07-0794-05	POWER TRANSFORMER		
640	1B	L07-0795-05	POWER TRANSFORMER		
640	1B	L07-0796-05	POWER TRANSFORMER		
640	1B	L07-0797-05	POWER TRANSFORMER		
640	1B	L07-0798-05	POWER TRANSFORMER		

* New Parts
Parts without Parts No. are not supplied.
Les articles non mentionnés dans le Parts No. ne sont pas fournis.
Teil ohne Parts No. werden nicht geliefert.

NO.2

A-57 (SINGAPORE MADE)

Ref. No.	Address	Part No.	Description	Desti- nation	Re- marks
参照番号	位置	部品番号	部品名/規格	仕 向	備考
601	1A	A01-2948-01	METALLIC CABINET		
602	2A	A40-0488-02	PANEL ASSY		
605	1B	X94-1011-41	REMOTE CONTROL ASSY UNIT		
606	1B	A09-0126-03	BATTERY COVER		
609	2A	B01-0487-11	PANEL ESCUTCHEON		
611	2A	B12-0201-04	INDICATOR		
612	2A	B12-0202-04	INDICATOR		
613	2A	B15-1520-04	LIGHTING BOARD		
		B46-0096-33	WARRANTY CARD		
		B46-0310-03	WARRANTY CARD		
		B52-0528-00	CONNECTING DIAGRAM		
		B52-0529-00	CONNECTING DIAGRAM		
		B60-1302-00	INSTRUCTION MANUAL (ENGLISH)		
		B60-1303-00	INSTRUCTION MANUAL (FRENCH)		
		B60-1304-00	INSTRUCTION MANUAL (GERMAN)		
		B60-1305-00	INSTRUCTION MANUAL (DUTCH)		
		B60-1306-00	INSTRUCTION MANUAL (ITALIAN)		
		B60-1307-00	INSTRUCTION MANUAL (SPANISH)		
		B60-1308-00	INSTRUCTION MANUAL (ENGLISH)		
		B60-1309-00	INSTRUCTION MANUAL (SPANISH)		
		B60-1310-00	INSTRUCTION MANUAL (CHINESE)		
616	1C	E30-2277-15	AC POWER CORD		
616	1C	E30-2715-05	AC POWER CORD		
616	1C	E30-2719-05	AC POWER CORD		
616	1B	E03-0141-05	AC OUTLET		
620	2A	011-0155-14	SGRT TAPE (40X9X2)		
		H50-0780-04	ITEM CARTON CASE		
		H50-0781-04	ITEM CARTON CASE		
		H50-0782-04	ITEM CARTON CASE		
		H50-0783-04	ITEM CARTON CASE		
		H10-5624-02	POLYSTYRENE FOAMED FIXTURE R		
		H10-5627-02	POLYSTYRENE FOAMED FIXTURE L		
		H10-5628-02	POLYSTYRENE FOAMED FIXTURE R		
		H13-0111-14	CARTON BOARD		
		H25-0232-04	PROTECTION BAG (235X350X0.03)		
		H25-0304-04	PROTECTION BAG (0232 PRINTED)		
		H25-0651-04	PROTECTION BAG (0304 PRINTED)		
625	2C	J02-0364-15	FOOT		
626	2C	J02-1040-05	FOOT		
627	2C	J12-0091-05	FRONT PIN		
628	1C	J42-0083-05	POWER CORD BUSHING		

PARTS LIST

A-57/77

M New Parts
 Parts without Parts No. are not supplied.
 Les articles non mentionnés dans le Parts No. ne sont pas fournis.
 Teile ohne Parts No. werden nicht geliefert.

NO.3

Ref. No.	Address	Part No.	Description	Desti- nation	Per- mits
参照番号	位置	部品番号	部品名 / 規格	仕 向	特 許
630	2A	K23-2081-14	KN08 SPEAKER ON/OFF A/B	E	
631	2A	K23-2501-04	KN08 BALANCE	T	
632	2A	K23-4401-04	KN08 VOLUME CONTROL	M	
633	2A	K23-4402-04	KN08 INPUT SELECTOR	X	
634	2A	K29-4403-04	KN08 BASS, TREBLE	ETX	
640	1B	L07-0524-15	POWER TRANSFORMER	E	
640	1B	L07-0525-15	POWER TRANSFORMER	T	
640	1B	L07-0526-15	POWER TRANSFORMER	M	
640	1B	L07-0648-05	POWER TRANSFORMER	X	
640	1B	L07-0553-05	POWER TRANSFORMER	ETX	
T2	1C	L07-0561-05	POWER TRANSFORMER	M	
C	1C	N09-2903-05	TAPTITE SCREW	E	
D	2B	N86-4009-45	BINDING HEAD TAPTITE SCREW	T	
E	1B, 2B	N87-3004-46	BRAZIER HEAD TAPTITE SCREW	M	
F	1B, 1C	N88-3008-45	FLAT HEAD TAPTITE SCREW	X	
G	1A, 1C	N89-3008-45	BINDING HEAD TAPTITE SCREW	ETX	
H	1B, 2B	N89-3008-46	BINDING HEAD TAPTITE SCREW	M	

A-77 (JAPAN MADE)

M New Parts
 Parts without Parts No. are not supplied.
 Les articles non mentionnés dans le Parts No. ne sont pas fournis.
 Teile ohne Parts No. werden nicht geliefert.

NO.4

Ref. No.	Address	Part No.	Description	Desti- nation	Per- mits
参照番号	位置	部品番号	部品名 / 規格	仕 向	特 許
-	-	H25-0651-04	PROTECTION BAG (0233 PRINTED)	T	
625	2C	H25-0656-04	PROTECTION BAG (0304 PRINTED)	E	
626	2C	J02-0366-15	FOOT	M	
627	2C	J02-1040-05	REAR	X	
628	1C	J12-0091-05	PIN	T	
629	1C	J42-0093-05	POWER CONO BUSHING	ETX	
630	2B	K27-2081-14	KN08 SPEAKER ON/OFF A/B	E	
631	2A	K29-2507-04	KN08 BALANCE	T	
632	2A	K29-4403-04	KN08 VOLUME CONTROL	M	
633	2A	K29-4404-04	KN08 INPUT SELECTOR	X	
634	2A	K29-4405-04	KN08 BASS, TREBLE	ETX	
640	1B	L07-0520-15	POWER TRANSFORMER	E	
640	1B	L07-0521-15	POWER TRANSFORMER	T	
640	1B	L07-0522-15	POWER TRANSFORMER	M	
640	1B	L07-0647-05	POWER TRANSFORMER	X	
T1	1B	L07-0555-05	POWER TRANSFORMER	ETX	
T2	1B, 2B	L07-0557-05	POWER TRANSFORMER	M	

A-77 (SINGAPORE MADE)

PARTS LIST

USA/Canada
 Y/N/P/E (For East, Hawaii)
 Y/A/E/F/S (Europe)

KUSA
 T/England
 X/Australia
 P/Canada
 E/Europe
 M/Other Areas

△ indicates safety critical components.

USA/Canada
 Y/N/P/E (For East, Hawaii)
 Y/A/E/F/S (Europe)

KUSA
 T/England
 X/Australia
 P/Canada
 E/Europe
 M/Other Areas

△ indicates safety critical components.

PARTS LIST

NO.12

* New Parts
Parts without Parts No. are not supplied.
Les articles non mentionnés dans le Parts No. ne sont pas fournis.
Teile ohne Parts No. werden nicht geliefert.

Ref. No. 参照番号	Address 位置	Parts No. 部品番号	Description 部品名 / 規格	Desti- nation 仕向	Re- marks 備考
J9		E03-0108-05	AC GUTLET	M	
J10		E08-0312-05	RECTANGULAR RECEPTACLE SYNCHRO		
J11		E08-0414-05	RECTANGULAR RECEPTACLE TUNER		
J12		E08-0411-05	RECTANGULAR RECEPTACLE DECK		
J13		E08-0415-05	RECTANGULAR RECEPTACLE CD		
F6		F05-2525-05	FUSE (SEMKO) (250V T2.5A)	ETX	
F7		F05-2021-05	FUSE (SEMKO) (250V T2.1A)	ETX	
F8		F05-2525-05	FUSE (SEMKO) (250V T2.5A)	M	
F9		F05-2525-05	FUSE (SEMKO) (250V T2.5A)	M	
F10		F06-2021-05	FUSE (SEMKO) (250V T2.1A)		
F12		F06-1022-05	FUSE (SEMKO) (250V T2.1A)		
F13		F05-2525-05	FUSE (SEMKO) (250V T2.5A)		
		J11-0098-05	WIRE CLAMPER		
		J11-0098-05	WIRE CLAMPER		
		J13-0075-05	FUSE CLIP	ETX	
		J13-0075-05	FUSE CLIP	M	
		J13-0075-05	FUSE CLIP	ETX	
		CN10-15			
		CN14-23			
		CN22,23			
X1		L78-0267-05	RESONATOR 4.194MHZ		S
CP1		R90-0850-05	MULTI-COMP 100KX3 J 1/4W		
CP2		R90-0855-05	MULTI-COMP 100KX5 J 1/4W		
R44		R014N82E472J	RD 4.7K J 1/4W		
R46		R014N82E470J	RD 4.7K J 1/4W		
R48		RS14K83A472J	FL-PR00F RS 4.7K J 1W		
R55		R014N82E262J	RD 2.2 J 1/4W		
R58		R014N82E33J	RD 330 J 1/4W		
R61		R014N82E100J	RD 10 J 1/4W		
R62		R014N82E101J	RD 100 J 1/4W		
R66		RS14K83A472J	FL-PR00F RS 4.7K J 1W		
R81		R014N82E101J	RD 100 J 1/4W		
VR1		R29-5072-15	VARIABLE RESISTOR(100K) VOLUME		
VR2		R01-5086-05	POTENTIOMETER(200K) BALANCE		
VR3		R10-5058-05	POTENTIOMETER(100K)BASS,TREBLE		
K1		S76-0002-05	MAGNETIC RELAY	ETX	
K2		S76-0002-05	MAGNETIC RELAY	M	
S2		S40-1064-05	PUSH SWITCH POWER, NR DIR, REC		
S6		S40-2366-05	PUSH SWITCH SP, NR, 20PFA, V/B		
S8		S62-0001-05	SLIDE SWITCH VOLTAGE SELECTOR	M	
S9		S31-2322-05	SLIDE SWITCH VOLTAGE SELECTOR	M	
S1		T99-0509-05	SPEED DETECTOR INPUT SELECTOR		
D1		HSS104	DIODE		
D1		ISS133	DIODE		
D9		HZ55-1N(B2)	ZENER DIODE		
D9		R05-1B5(B2)	ZENER DIODE		
D10		HSS104A	DIODE		
D10		ISS131	DIODE		
D11		HZ54-7N(B2)	ZENER DIODE		
D11		RD4-7ES(B2)	ZENER DIODE		
D12		HSS104	DIODE		
D12		ISS133	DIODE		
D13		S5688B	DIODE		
D14		HSS104A	DIODE		
D14		ISS131	DIODE		
D15		HZ55-1N(B2)	ZENER DIODE		

L:Scandinavia
Y:Far East, Hawaii
Y:AFES(Europe)

K:USA
T:England
X:Australia

P:Canada
E:Europe
M:Other Areas

J: JAPAN MADE
S: SINGAPORE MADE
5: A-57
7: A-77

△ indicates safety critical components.

NO.11

* New Parts
Parts without Parts No. are not supplied.
Les articles non mentionnés dans le Parts No. ne sont pas fournis.
Teile ohne Parts No. werden nicht geliefert.

Ref. No. 参照番号	Address 位置	Parts No. 部品番号	Description 部品名 / 規格	Desti- nation 仕向	Re- marks 備考
G7		25A1309A(G,R)	TRANSISTOR	J	
G7		25A2335(G,R)	TRANSISTOR	S	
G9		25C4878(A,B)	TRANSISTOR		
A1		W02-1046-05	ELECTRIC CIRCUIT MODULE		
CONTROL UNIT (X11-332X-XX):A-77					
		B30-1291-05	LED(LN21CPS)(X)(V)(1A44)		
C1		C91-0769-05	0.01UF K		
C2		C90-3253-05	1UF 50WV		
C3		CE04KH220M	22UF 50WV	J	
C3		CE04LH220M	22UF 50WV	S	
C4		CE04KH1010M	1.0UF 50WV		
C4		CE04LH1010M	1.0UF 50WV		
C8		C90-3225-05	ELECTR0 1.0UF 50WV	S	
C9		CE04KH1H47M	ELECTR0 10UF 16WV	J	
C9		CE04LH1H47M	ELECTR0 4.7UF 50WV	S	
C10		C90-3225-05	ELECTR0 4.7UF 50WV		
C11		CE04KH0471M	ELECTR0 470UF 6.3WV	J	
C11		CE04LH0471M	ELECTR0 470UF 6.3WV	S	
C12		CE04KH1E100M	NP-ELEC 10UF 25WV		
C13		CK45FF1H032	CERAMIC 0.010UF 2		
C14		CE04KH1E470M	ELECTR0 47UF 25WV	J	
C14		CE04LH1E470M	ELECTR0 47UF 25WV	S	
C15		CK45FF1H032	CERAMIC 0.010UF 2		
C16		CE04KH1V100M	ELECTR0 10UF 35WV	S	
C16		CE04LH1V100M	ELECTR0 10UF 35WV	S	
C17		CE04KH1E470M	ELECTR0 47UF 25WV	J	
C17		CE04LH1E470M	ELECTR0 47UF 25WV	S	
C19		CE04KH1E470M	ELECTR0 47UF 25WV	J	
C19		CE04LH1E470M	ELECTR0 47UF 25WV	S	
C20		CE04KH1H100M	ELECTR0 10UF 50WV	J	
C20		CE04LH1H100M	ELECTR0 10UF 50WV	S	
C23		CF92FV1H473J	MF 0.047UF J		
C25		CE04KH1V100M	ELECTR0 10UF 35WV	J	
C25		CE04LH1V100M	ELECTR0 10UF 35WV	S	
C31		CE04KH1E470M	ELECTR0 47UF 25WV	J	
C31		CE04LH1E470M	ELECTR0 47UF 25WV	S	
C33		C90-3241-05	ELECTR0 3.3UF 35WV		
C35		CC45FL1H221J	CERAMIC 220PF J		
C37		CK45FF1H032	CERAMIC 560PF K		
C41		CF92EV1H083J	MF 0.088UF J		
C43		C90-3244-05	ELECTR0 10UF 35WV		
C45		CE92FV1H103J	MF 0.010UF J		
C47		C90-3232-05	ELECTR0 4.7UF 25WV		
C50		CK45FF1H032	CERAMIC 0.010UF 2		
C51		C91-1439-05	FILM 0.01UF 250VAC	ETX	
C53		C91-1439-05	FILM 0.01UF 250VAC	M	
C55		CC45FL1H221J	CERAMIC 220PF J		
C57		CE04KH1E100M	NP-ELEC 10UF 25WV		
C58		CK45FF1H032	CERAMIC 0.010UF 2		
C61		CE04KH1E100M	NP-ELEC 10UF 25WV		
C63		CF92FV1H272J	MF 2700PF J		
J5		E03-0108-05	AC OUTLET	E	
J5		E03-0109-05	AC OUTLET	T	

L:Scandinavia
Y:Far East, Hawaii
Y:AFES(Europe)

K:USA
T:England
X:Australia

P:Canada
E:Europe
M:Other Areas

J: JAPAN MADE
S: SINGAPORE MADE
5: A-57
7: A-77

△ indicates safety critical components.

PARTS LIST

NO.14

* New Parts
Parts without Parts No. are not supplied.
Les articles non mentionnés dans le Parts No. ne sont pas fournis.
Teile ohne Parts No. werden nicht geliefert.

Ref. No. 参照番号	Address 位置	Parts No. 部品番号	Description 部品名 / 規格	Desti- nation 仕	Re- marks 備考
D1 .2		1SS133	DIODE		
D3		HSS1044	DIODE		
D3		1SS131	DIODE		
Q1 -4		2SA992(F,E)	TRANSISTOR		
Q5 -8		2SC1845(F,E)	TRANSISTOR		
Q9 .10		2SA992(F,E)	TRANSISTOR		
Q11		2SC1740S(Q,R)	TRANSISTOR		
Q11		2SC2459(Y,GR)	TRANSISTOR		
Q11		2SC2785(F,E)	TRANSISTOR		
Q11		2SC3311A(Q,R)	TRANSISTOR		
Q12		DTC124ES	DIGITAL TRANSISTOR		S
Q12		UN4212	TRANSISTOR		J S

L:Scandinavia
Y/P(Far East, Hawaii)
Y:AAFESE(Europe)

K:USA
T:England
X:Australia

F:Canada
E:Europe
M:Other Areas

J: JAPAN MADE
S: SINGAPORE MADE
5: A-57
7: A-77

△ indicates safety critical components.

NO.13

* New Parts
Parts without Parts No. are not supplied.
Les articles non mentionnés dans le Parts No. ne sont pas fournis.
Teile ohne Parts No. werden nicht geliefert.

Ref. No. 参照番号	Address 位置	Parts No. 部品番号	Description 部品名 / 規格	Desti- nation 仕	Re- marks 備考
D15		R05.1E5(B2)	ZENER DIODE		
D16		R25.7N(B2)	ZENER DIODE		
D16		R04.7E5(B2)	ZENER DIODE		
D17		R25.16N(B2)	ZENER DIODE		
D17		R01.6E5(B2)	ZENER DIODE		
D18		R25.13N(B2)	ZENER DIODE		
D18		R01.3E5(B2)	ZENER DIODE		
D23		HSS1044	DIODE		
D23		1SS131	DIODE		
D23		1SS133	DIODE		
D24		HSS1044	DIODE		
D24		1SS131	DIODE		
D24		HSS104	DIODE		
D25		1SS133	DIODE		
D25		CM1154C	INDICATOR TUBE		
BD1		UP0752460W-044	IC(4BIT MICROPROCESSOR)		
IC1		PST529D	IC(SYSTEM RESET)		
IC2		NJM4545L-0	IC(IMP. AMP. X2)		
IC3 .4		T8A09S	IC(MOTOR CONTROL)		
IC5		2SA957(L,K)	TRANSISTOR		
Q1		2SA1048(Y,GR)	TRANSISTOR		J
Q3		2SA1175(F,E)	TRANSISTOR		S
Q3		2SA1309A(Q,R)	TRANSISTOR		J
Q3		2SA935(Q,R)	TRANSISTOR		S
Q5 .6		2SC1845(F,E)	TRANSISTOR		
Q7		2SA1048(Y,GR)	TRANSISTOR		J
Q7		2SA1175(F,E)	TRANSISTOR		S
Q7		2SA1309A(Q,R)	TRANSISTOR		J
Q9		2SA935(Q,R)	TRANSISTOR		S
Q9		2SC2878(A,B)	TRANSISTOR		S
Q9 .10		W02-1046-05	ELECTRIC CIRCUIT MODULE		
A1			MAIN AMPLIFIER UNIT (X85-122X-XX)		
C1		CE04K1H010M	ELECTRO 1.0UF 50WV		J S
C1		CE04L1H010M	ELECTRO 1.0UF 50WV		
C3 .4		CK45F1H471K	CERAMIC 470PF K		
C5 .6		C90-1844-05	ELECTRO 470UF 6.3WV		
C7 .8		CC45FSL1H121J	CERAMIC 120PF J		
C9		CC45FSL1H020C	CERAMIC 2.0PF C		
C11 .12		CC45FSL1H221J	CERAMIC 220PF J		
C13 .14		CC45FSL1H390J	CERAMIC 39PF J		
C15 .16		CC45FSL1H221J	CERAMIC 220PF J		
C17 .18		CE04K1H470M	ELECTRO 47UF 50WV		J
C17 .18		CE04L1H470M	ELECTRO 47UF 50WV		S
C19		CE04M1V477M	NP-ELECC 4.7UF 35WV		J
C20		CE04L1V477M	ELECTRO 4.7UF 35WV		S
R5 .6		RN14BK2C22151F	RN 2.15K F 1/6W		
R5 .6		RN14BK2C2371F	RN 2.37K F 1/6W		ET
R5 .6		RN14BK2C2611F	RN 2.61K F 1/6W		ET
R5 .6		RN14BK2C2871F	RN 2.87K F 1/6W		ET
R15 .16		R0146B28271J	FL-PR00E R0 270 J 1/4W		FX
R21 -24		R0146B28211J	FL-PR00E R0 220 J 1/4W		
R25 .26		R0146B28470J	FL-PR00E R0 47 J 1/4W		
D1 .2		HSS104	DIODE		

L:Scandinavia
Y/P(Far East, Hawaii)
Y:AAFESE(Europe)

K:USA
T:England
X:Australia

F:Canada
E:Europe
M:Other Areas

J: JAPAN MADE
S: SINGAPORE MADE
5: A-57
7: A-77

△ indicates safety critical components.