

2

3

4

5

6

7

A-8177
 KENWOOD



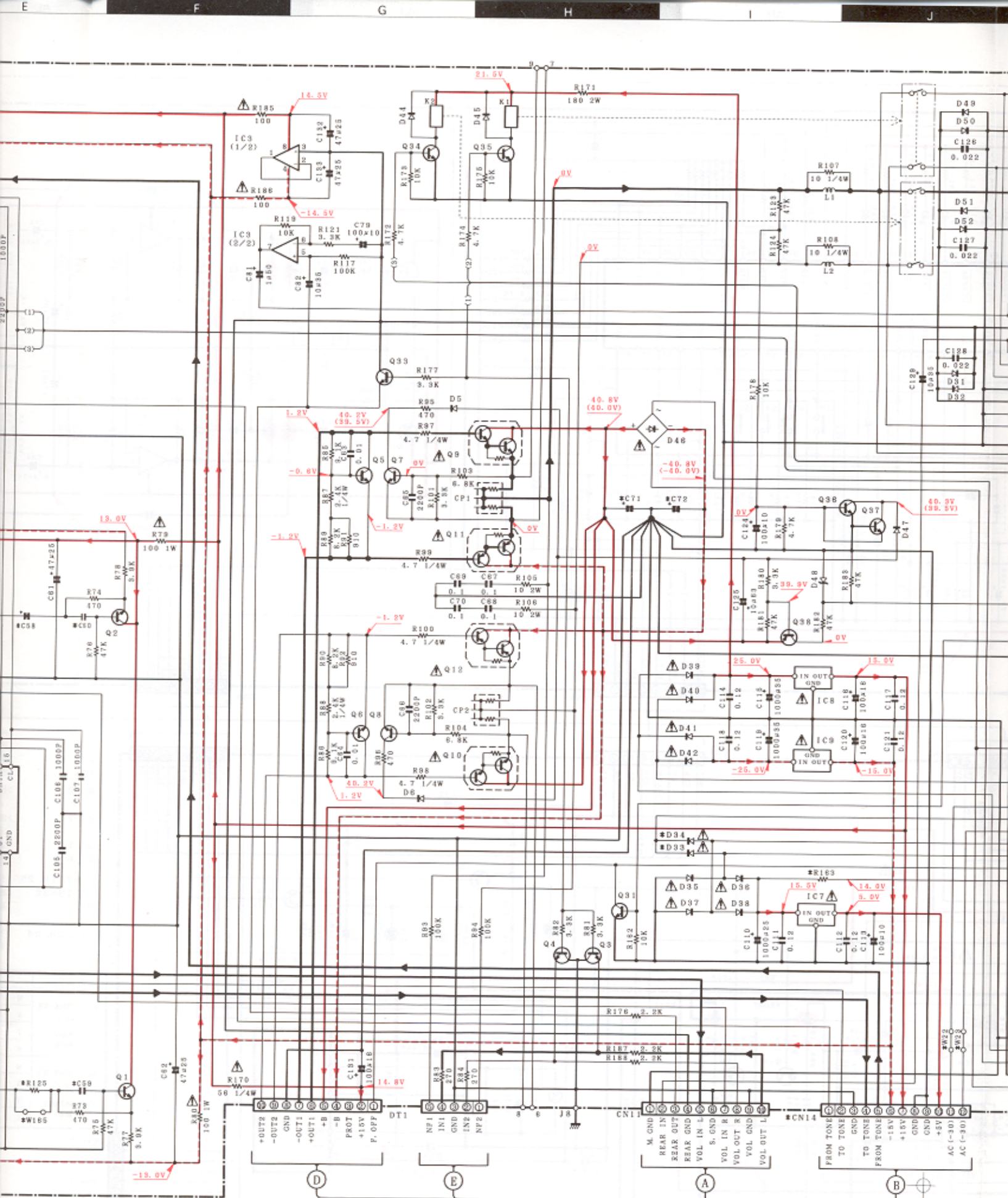

DT1 X85-12XX-XX

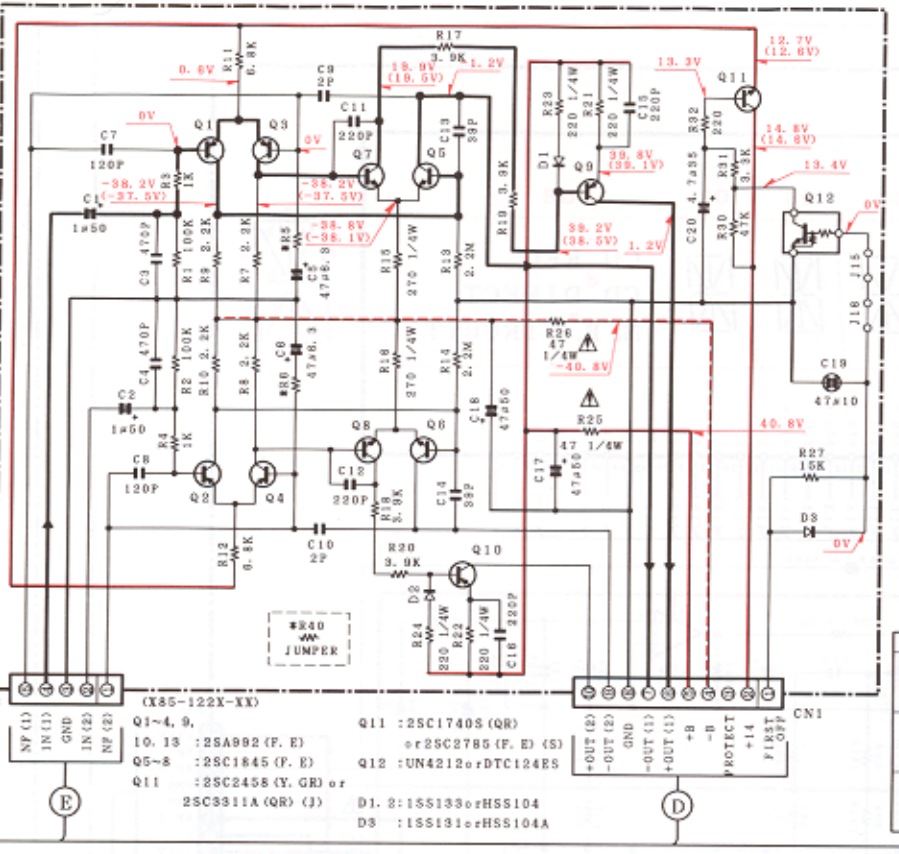
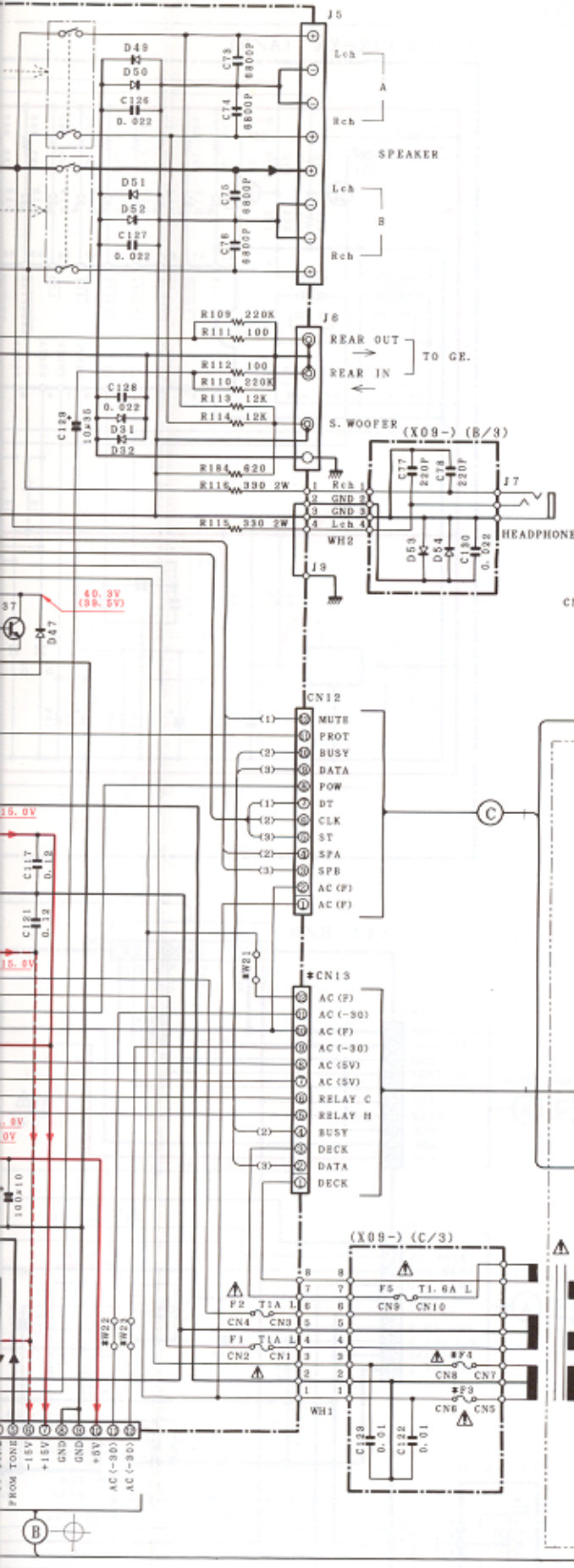

(M TYPE ONLY)

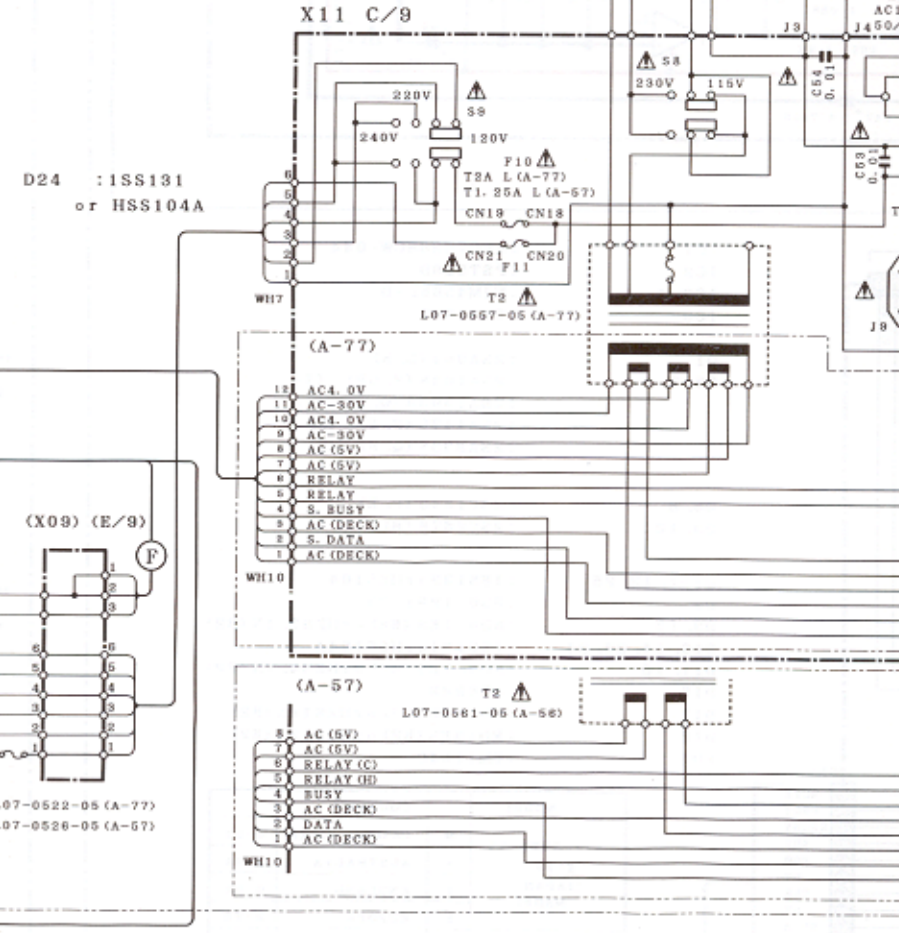

(X85)
 MO
 A-7
 JAP
 MAD
 A-7
 SINGA
 MAD
 A-5

DX or BA15218-DX	Q1, 2, 7, 8	: 2SC1845 (F, E)	D1~6, 31, 32	
or NJM2058D	Q3, 4, 33	: 2SC2878 (A, B)	44, 45,	
or TC9164N	Q5, 6	: 2SC4137 (V, W)	47, 48~54	: 1SS133 or HSS104
or TC9162N	Q9, 10	: 2SD2254 (A-77)	D35~42	: S5688B or
or TA7805S or		2SD2340 (A-57)		1SR199-100
or TA7805S or	Q11, 12	: 2SB1492 (A-77)	D46	: RBV-602LFA or
or PC7815AHF		2SB1531 (A-57)		D55BA20F03
	Q31, 34~37	: 2SC2003 (L, K)	D48	: RD4.7ES (B2) or
	Q98	: 2SA938S (Q, R) or		HZS4.7N (B2)
		2SA1175 (F, E)		

ENTRY	CN13	CN14	D33, 34	C21~26, 33~36, 43~44	C49, 50	C57, 58	C59, 60	C71, 72	R125	R128	R163	F3, 4	W21~23	
L MARKET LIA	0-23	12P	12P	NO	0.047μ	4.7μ35	0.1μ	6800μ63	W165	W164				
D	2-72	12P	12P		220P	10μ35	1μ	0.33μ	6800μ63	4.7K	4.7K			
L MARKET LIA	0-21	12P	12P	NO	0.047μ	4.7μ35	0.1μ	6800μ63	W165	W164	47 2W	T4A L	YES	
D	2-70	12P	12P		220P	10μ35	1μ	0.33μ	6800μ63	4.7K	4.7K			
L MARKET LIA	0-22	8P	10P	NO	0.1μ	4.7μ35	0.1μ	5600μ	2.2K	2.2K				
D	2-71	8P	10P		220P	10μ35	1μ	0.33μ	5600μ	2.0K	2.0K			
L MARKET LIA	0-24	8P	10P	YES	NO	0.1μ	4.7μ35	0.1μ	5600μ	2.2K	2.2K	82 2W	T2.5A L	NO
D	2-73	8P	10P		220P	10μ35	1μ	0.33μ	5600μ	2.0K	2.0K			

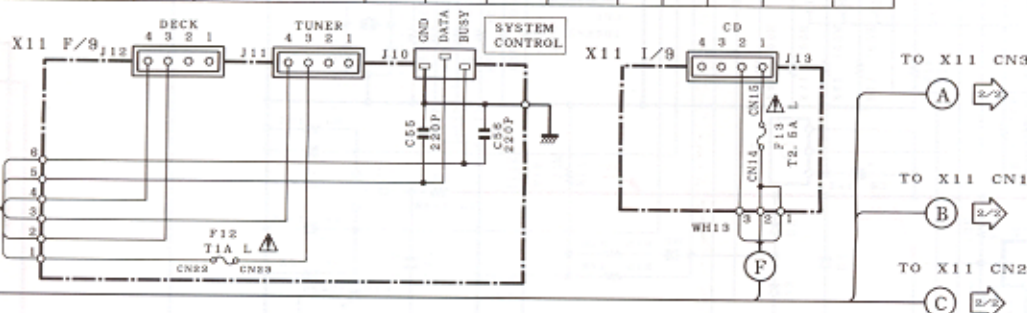

(E, T, X TYPE ONLY)

X11 D/9

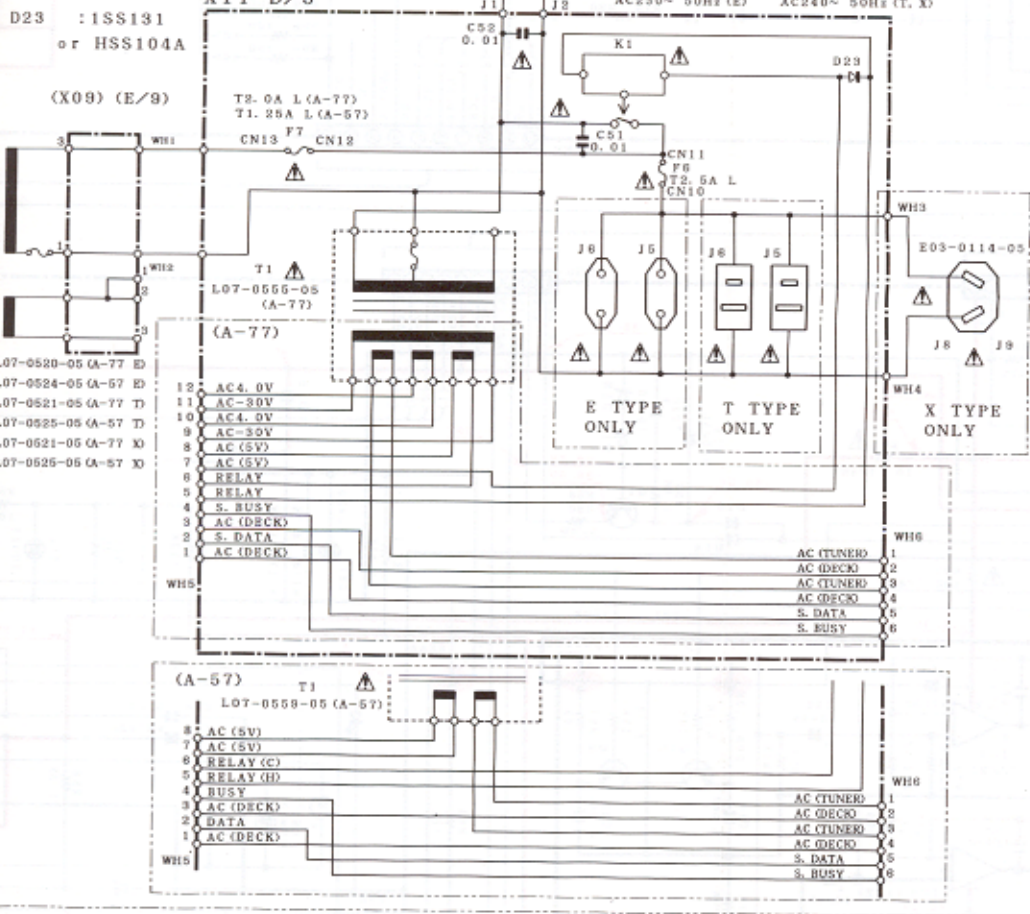

DC voltages are as measured with a high impedance voltmeter with no signal input. Values may vary slightly due to variations between individual instruments or/and units.

Les tensions c.c. doivent être mesurées avec un voltmètre haute impédance sans signal d'entrée. Les valeurs peuvent différer légèrement du fait des variations inhérentes aux appareils et aux instruments de mesure individuels.

Die angegebenen Gleichspannungswerte wurden mit einer hochohmigen Spannungsmesser ohne Eingangssignal gemessen. Dabei schwanken die Meßwerte aufgrund von Unterschieden zwischen einzelnen Instrumenten oder Geräten um U. geringfügig.

CAUTION: For continued safety, replace safety critical components only with manufacturer's recommended parts (refer parts list). ⚠ Indicates safety critical components. To reduce risk of electric shock, leakage-current or resistance measurement shall be carried out (exposed parts are acceptably insulated from the supply circuit) before the appliance is returned to the customer.

— SIGNAL LINE
— GND LINE
— +B LINE
- - - -B LINE

1/2

A-57/77

Y08-4972-70

KENWOOD

X11-33XX-XX (A/9)

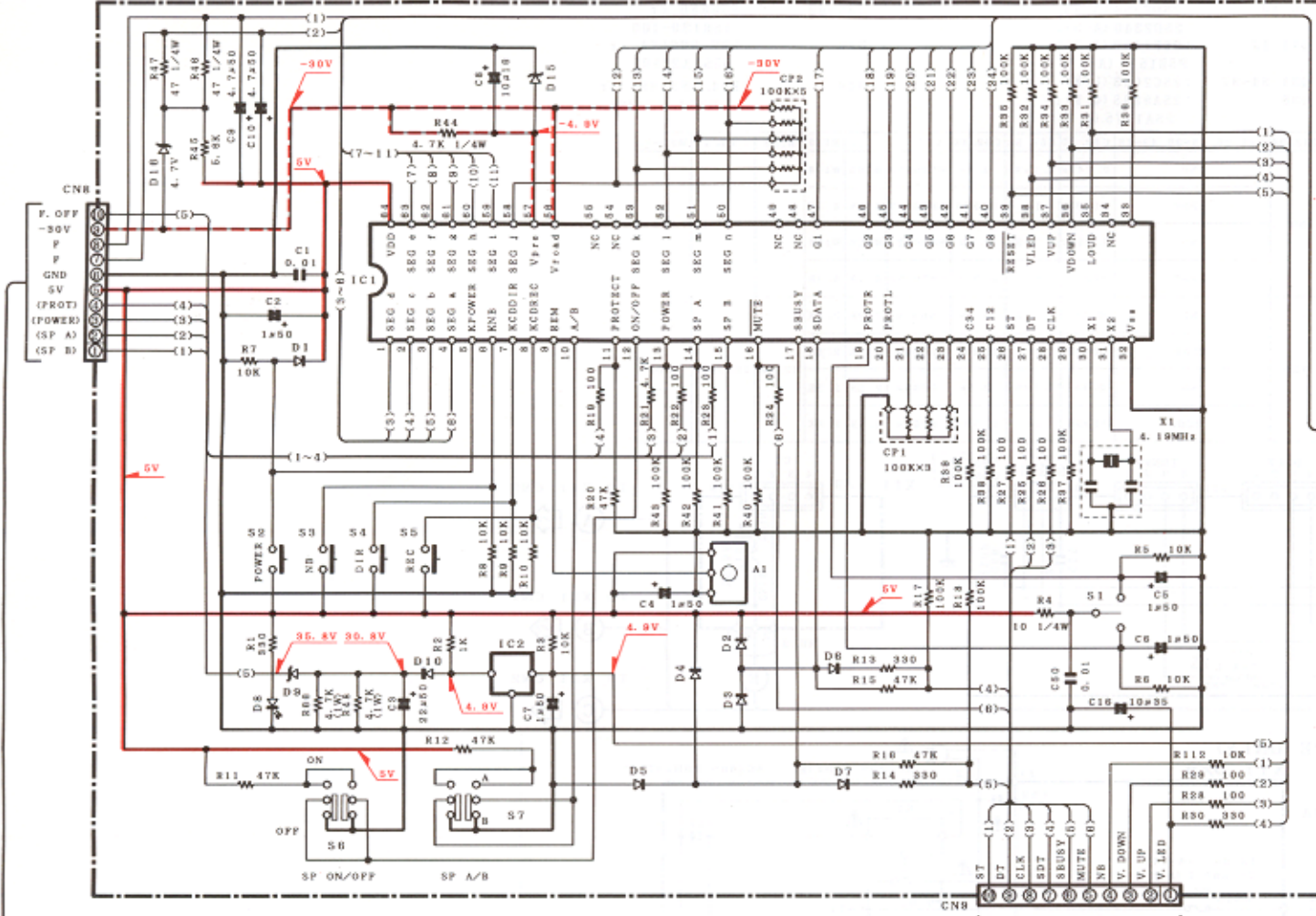

X11 B/9

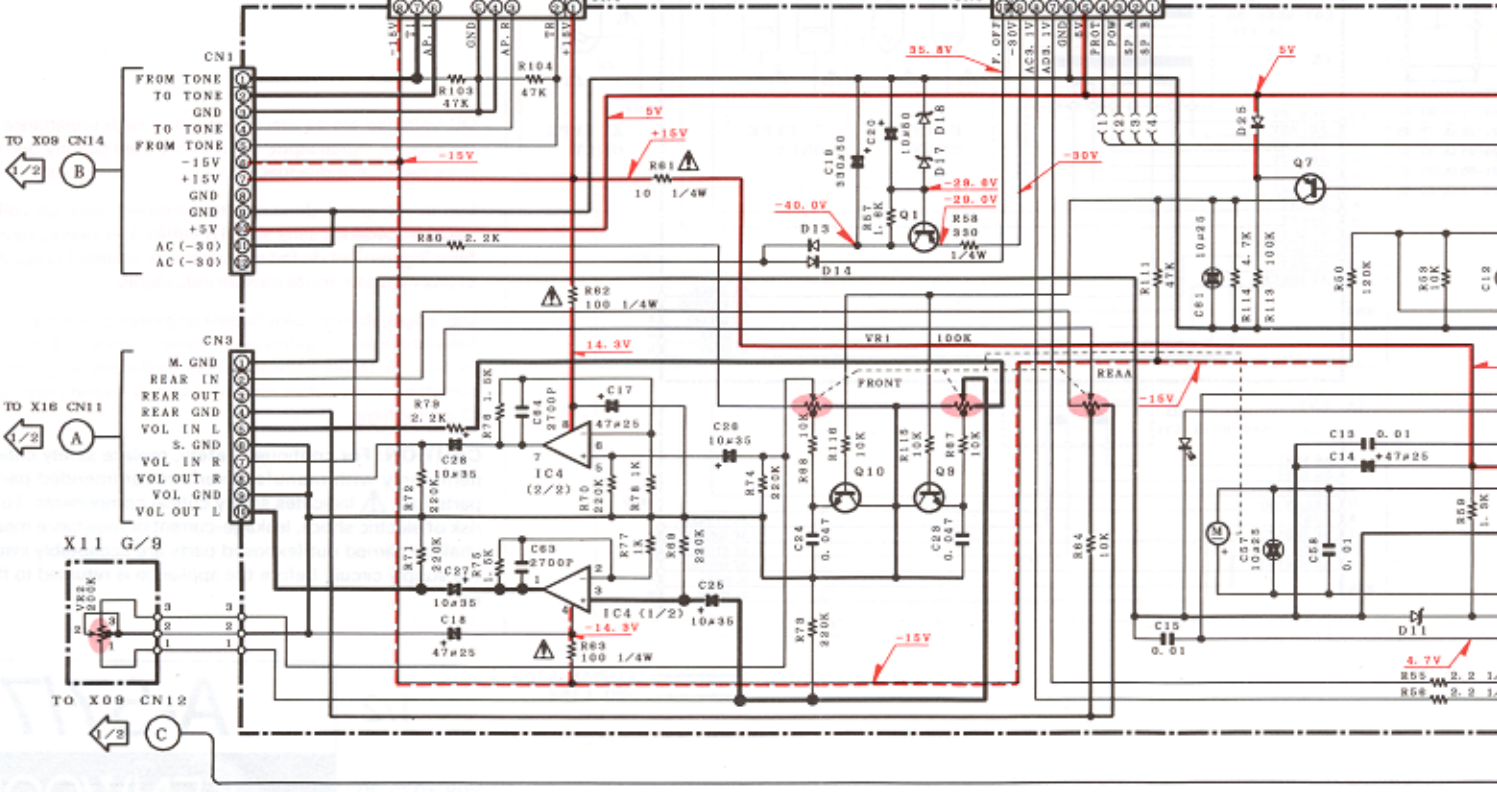

X11 G/9



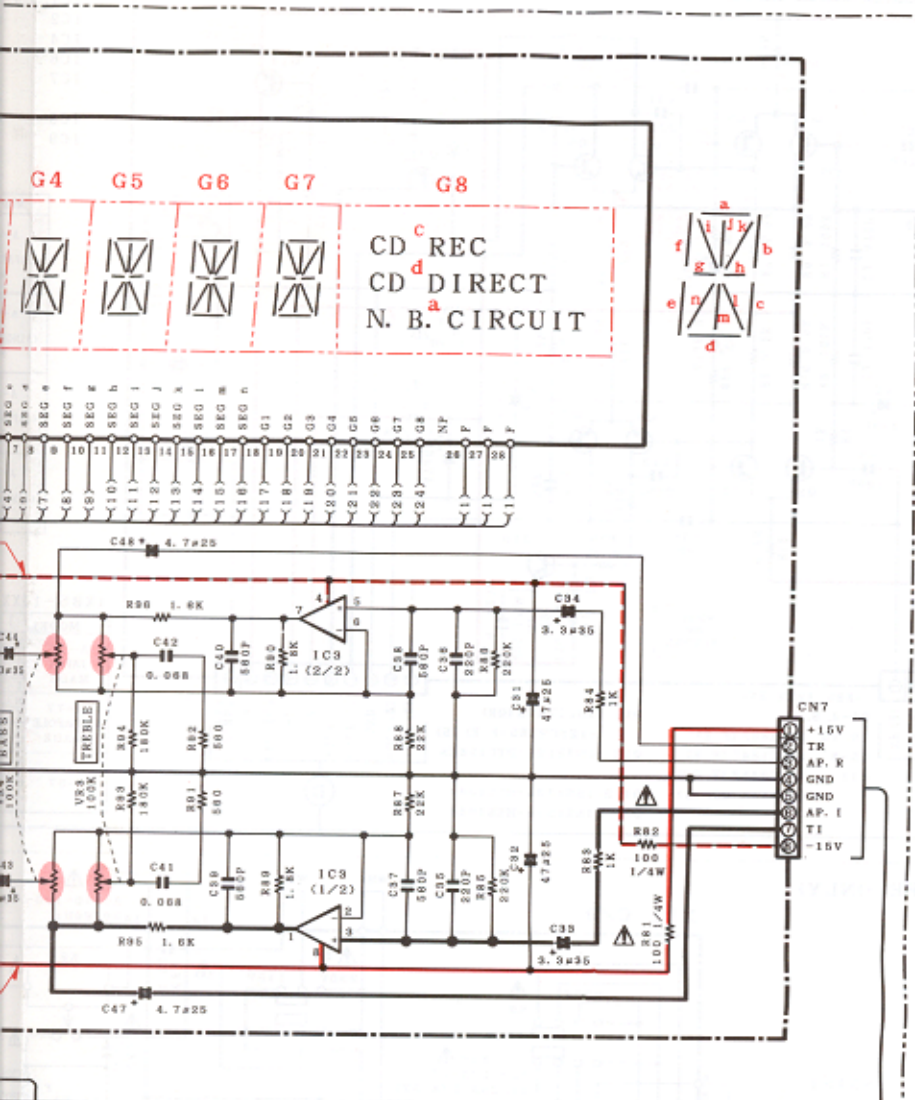

- IC1 : #PD75288CW-044
- IC2 : PST529D
- IC3, 4 : NJM4565L-D
- IC5 : TA8409S

- Q1 : 2SA954 (L, K)
- Q3, 7 : 2SA1048 (Y, GR) (J)
- : 2SA1309A (Q, R) (J)
- : 2SA1175 (F, E) (S)
- : 2SA933S (Q, R) (S)

- Q5, 6 : 2SC1845 (F, E)
- Q9, 10 : 2SC2878 (B)

- D1~7, 12, 25 : ISS133 or HSS104
- D8 : B30-1291-05
- D9, 15 : RD5.1ES (B2) or HZS5.1N (B2)
- D10, 14, 23, 24 : ISS131 or HSS104A
- D11, 16 : RD4.7ES (B2) or HZS4.7N (B2)
- D13 : S5688B
- D17 : RD16ES (B2) or HZS16N (B2)
- D18 : RD13ES (B2) or HZS13N (B2)
- ED1 : CM1154C

MODEL	COUNTRY	
X11-332X-XX A-77 (JAPAN MADE)	M	GENERAL MARKET 0-21
	X	AUSTRALIA 0-71
	T	ENGLAND 0-51
X11-334X-XX A-77 (SINGAPORE MADE)	E	EUROPE 2-70
	M	GENERAL MARKET 0-21
	X	AUSTRALIA 0-71
	T	ENGLAND 0-51
	E	EUROPE 2-70

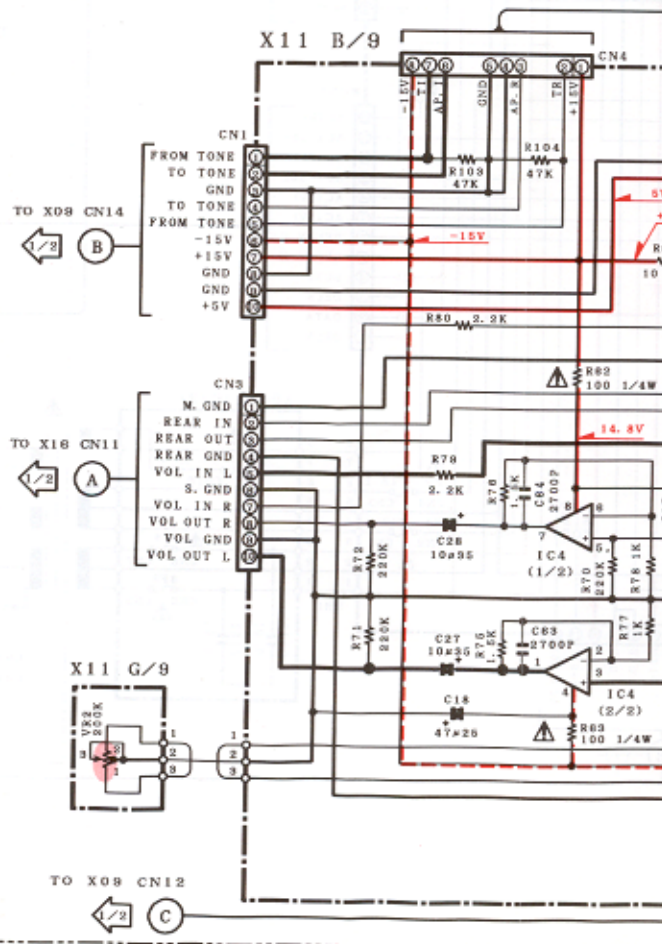
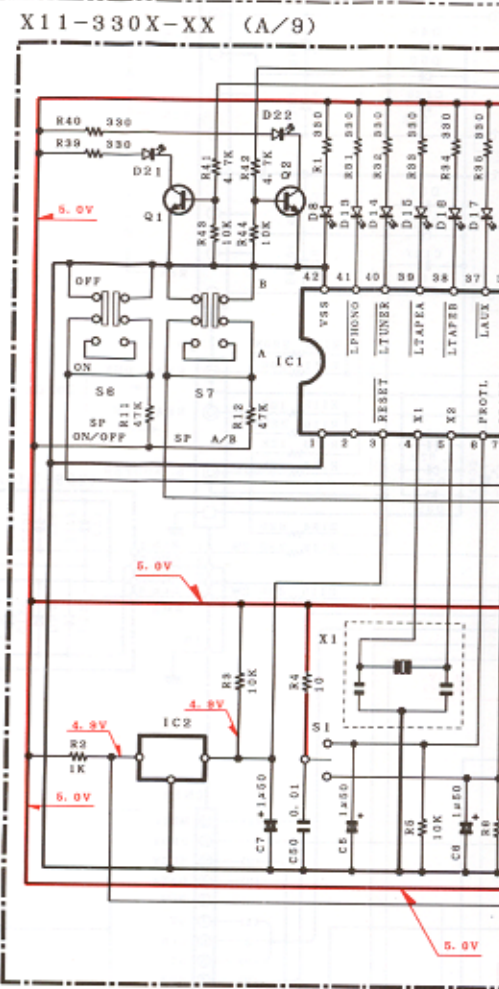
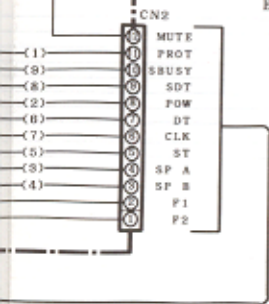

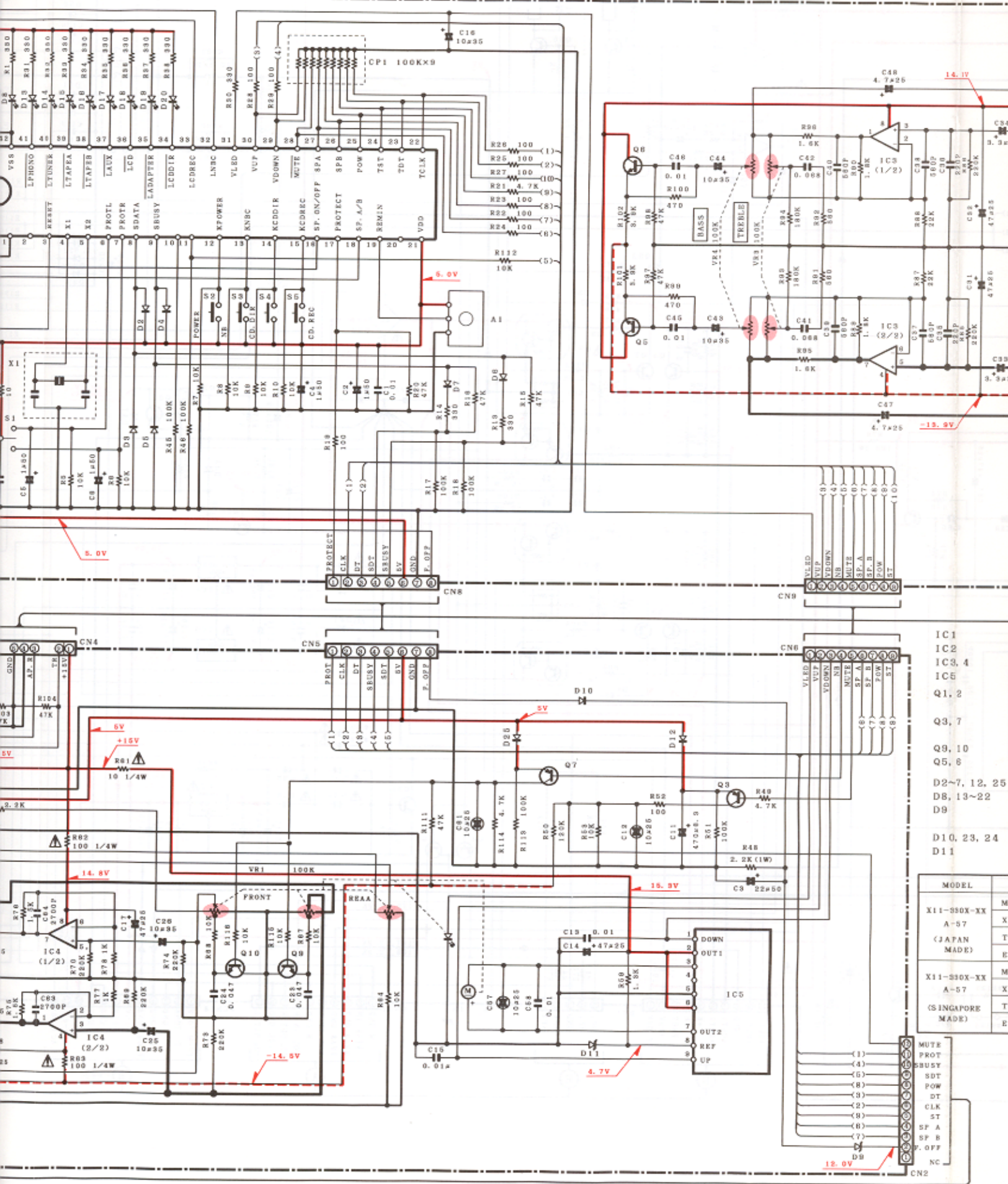

- IC 1
- IC 2
- IC 3, 4
- IC 5
- Q1, 2
- Q3, 7
- Q9, 10
- Q5, 6
- D2-7, 12, 25
- DB, 13-22
- D9
- D10, 23, 24
- D11

MODEL	
X11-330X-XX	M
A-57	X
(JAPAN MADE)	T
	E
X11-330X-XX	M
A-57	X
(SINGAPORE MADE)	T
	E



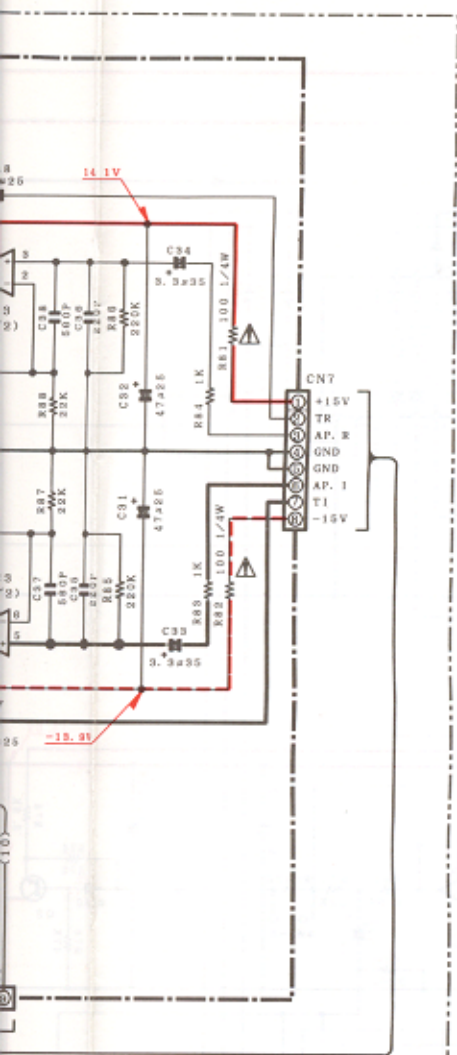

- IC1 : #PD75004CU-147
- IC2 : PST529D
- IC3, 4 : NJM4565L-D
- IC5 : TA8409S
- Q1, 2 : SC1740S (Q, R)
or 2SC2785 (F, E)
- Q3, 7 : 2SA933S (Q, R)
or 2SA1175 (F, E)
- Q9, 10 : 2SC2878 (A, B)
- Q5, 6 : 2SC1845 (F, E)
- D2~7, 12, 25 : ISS133 or HSS104
- D8, 13~22 : B30-1291-05
- D9 : RD5.1ES (B2)
or HZS5.1N (B2)
- D10, 23, 24 : ISS131 or HSS104A
- D11 : RD4.7ES (B2)
or HZS4.7N (B2)

MODEL	COUNTRY	
X11-330X-XX A-57 (JAPAN MADE)	M	GENERAL MARKET 0-22
	X	AUSTRALIA 0-72
	T	ENGLAND 0-52
	E	EUROPE 2-71
X11-330X-XX A-57 (SINGAPORE MADE)	M	GENERAL MARKET 0-21
	X	AUSTRALIA 0-71
	T	ENGLAND 0-51
	E	EUROPE 2-70

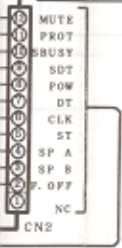

2SA954
2SA992

2SC1845
2SC2003
2SC2878

2SB1531
2SD2340

2SA1175
2SC2785

DTC124ES
2SA1048

2SA933S
2SC1740C
2SC2458

2SC4137

2SB1492
2SD2254

UN4212
2SA1309A

2SC3311A

BA15218-DX

NJM2058D

UPC4574C

TA8409S

UPD75004CU-147

AN77805F

PST529D

NJU7311L
NJU7313L

TC9162N
TC9164N

UPD75268CW-044

UPC7805AHF
UPC7815AHF

TA7805S
TA7815S

UPC7915F

TA79015S

NJM4565L-D

DC voltages are as measured with a high impedance voltmeter with no signal input. Values may vary slightly due to variations between individual instruments or/and units.

Les tensions c.c. doivent être mesurées avec un voltmètre à haute impédance sans signal d'entrée. Les valeurs peuvent différer légèrement du fait des variations inhérentes aux appareils et aux instruments de mesure individuels.

Die angegebenen Gleichspannungswerte wurden mit einem hochohmigen Spannungsmesser ohne Eingangssignal gemessen. Dabei schwanken die Meßwerte aufgrund von Unterschieden zwischen einzelnen Instrumenten oder Geräten u. U. geringfügig.



CAUTION: For continued safety, replace safety critical components only with manufacturer's recommended parts (refer to parts list). Indicates safety critical components. To reduce the risk of electric shock, leakage-current or resistance measurements shall be carried out (exposed parts are acceptably insulated from the supply circuit) before the appliance is returned to the customer.

A-57/77

KENWOOD

A-57/77

EXPLODED VIEW (UNIT)

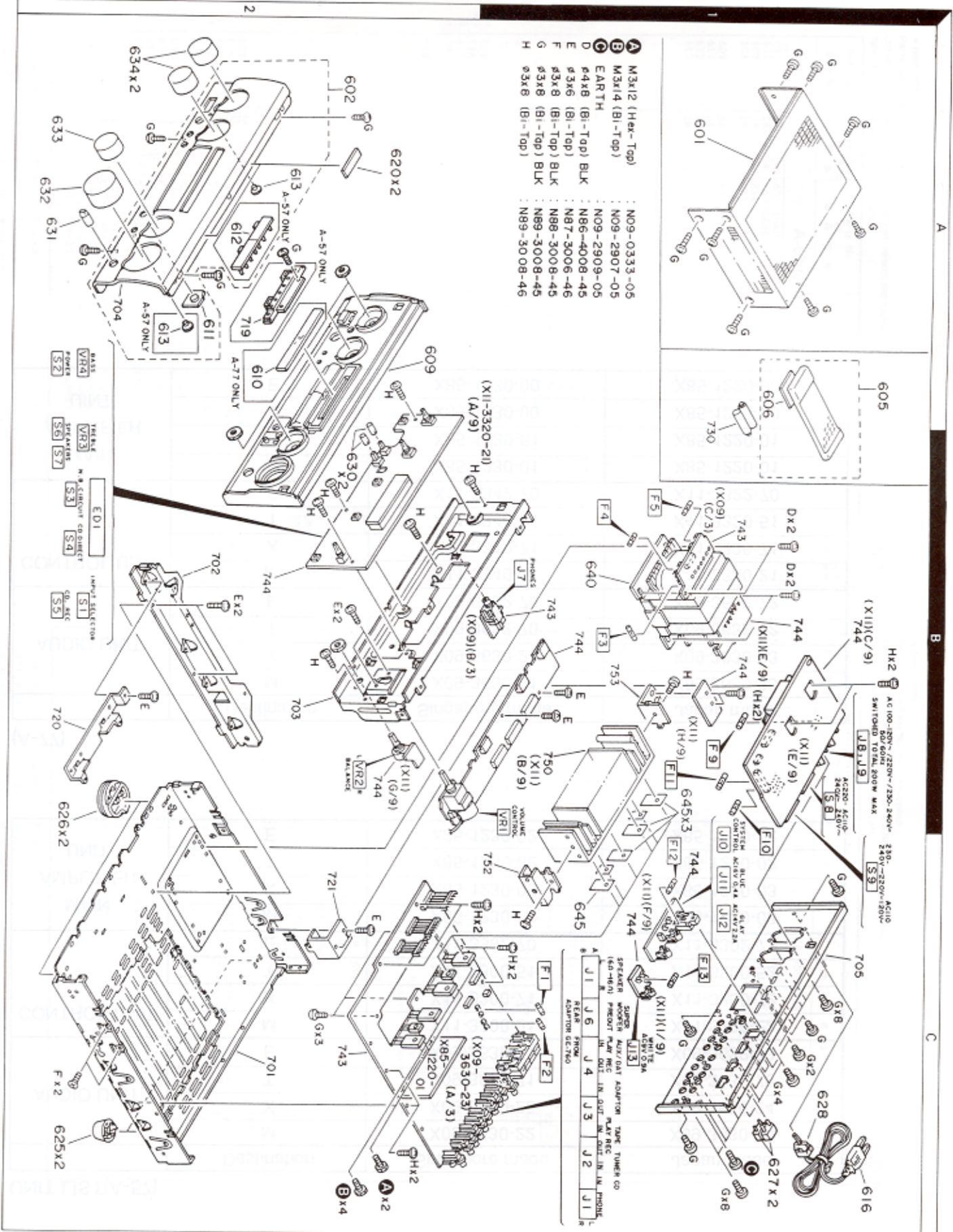

- A M3x12 (Hex-Top) : N09-0333-05
- B M3x14 (Bl-Top) : N09-2907-05
- C EARTH : N09-2909-05
- D #4x8 (Bl-Top) BLK : N86-4008-45
- E #3x6 (Bl-Top) : N87-3006-46
- F #3x8 (Bl-Top) BLK : N88-3008-45
- G #3x8 (Bl-Top) BLK : N89-3008-45
- H #3x8 (Bl-Top) : N89-3008-46

Parts with the exploded numbers larger than 700 are not supplied. 25

* New Parts
Parts without Parts No. are not supplied.
Les articles non mentionnés dans le Parts No. ne sont pas fournis.
Teile ohne Parts No. werden nicht geliefert.

NO.1

A-57 (JAPAN MADE)

Ref. No.	Address	Part No.	Description	Desti- nation	Re- marks
参照番号	位置	部品番号	部品名/規格	仕 向	備考
601	1A	A01-2948-01	METALLIC CABINET		
602	2A	A40-0488-02	PANEL ASSY		
605	1A	X94-1001-41	REMOTE CONTROL ASSY UNIT		
606	1B	A09-0115-13	BATTERY COVER		
609	2A	B01-0487-11	PANEL ESCUTCHEON		
611	2A	B12-0201-04	INDICATOR		
612	2A	B12-0202-04	INDICATOR		
613	2A	B15-1520-04	LIGHTING BOARD		
		B46-0096-33	WARRANTY CARD		
		B46-0310-03	WARRANTY CARD		
		B52-0528-00	CONNECTING DIAGRAM		
		B52-0529-00	CONNECTING DIAGRAM		
		B60-1302-00	INSTRUCTION MANUAL (ENGLISH)		
		B60-1303-00	INSTRUCTION MANUAL (FRENCH)		
		B60-1304-00	INSTRUCTION MANUAL (GERMAN)		
		B60-1305-00	INSTRUCTION MANUAL (DUTCH)		
		B60-1306-00	INSTRUCTION MANUAL (ITALIAN)		
		B60-1307-00	INSTRUCTION MANUAL (SPANISH)		
		B60-1308-00	INSTRUCTION MANUAL (ENGLISH)		
		B60-1309-00	INSTRUCTION MANUAL (SPANISH)		
		B60-1310-00	INSTRUCTION MANUAL (CHINESE)		
616	1C	E30-2277-15	AC POWER CORD		
616	1C	E30-2715-05	AC POWER CORD		
616	1C	E30-2719-05	AC POWER CORD		
616	1B	E03-0141-05	AC OUTLET		
620	2A	011-0155-14	SGRT TAPE (40X9X2)		
		H50-0774-04	ITEM CARTON CASE		
		H50-0775-04	ITEM CARTON CASE		
		H10-5603-02	POLYSTYRENE FOAMED FIXTURE L		
		H10-5604-02	POLYSTYRENE FOAMED FIXTURE R		
		H10-5605-02	POLYSTYRENE FOAMED FIXTURE L		
		H10-5606-02	POLYSTYRENE FOAMED FIXTURE R		
		H13-0110-04	CARTON BOARD		
		H25-0232-04	PROTECTION BAG (235X350X0.03)		
		H25-0304-04	PROTECTION BAG		
		H25-0651-04	PROTECTION BAG (0232 PRINTED)		
		H25-0654-04	PROTECTION BAG (0304 PRINTED)		
625	2C	J02-0364-15	FOOT		
626	2C	J02-1040-05	FOOT		
627	2C	J12-0091-05	FRONT PIN		
628	1C	J42-0083-05	POWER CORD BUSHING		
630	2B	K27-2081-14	KNOB SPEAKER SW/GRF. A/B		
631	2A	K29-2507-04	KNOB BALANCE		
632	2A	K29-4403-04	KNOB VOLUME CONTROL		
633	2A	K29-4404-04	KNOB INPUT SELECTOR		
634	2A	K29-4405-04	KNOB BASS/TREBLE		
640	1B	L07-0794-05	POWER TRANSFORMER		
640	1B	L07-0795-05	POWER TRANSFORMER		
640	1B	L07-0796-05	POWER TRANSFORMER		
640	1B	L07-0797-05	POWER TRANSFORMER		
640	1B	L07-0798-05	POWER TRANSFORMER		

* New Parts
Parts without Parts No. are not supplied.
Les articles non mentionnés dans le Parts No. ne sont pas fournis.
Teile ohne Parts No. werden nicht geliefert.

NO.2

A-57 (SINGAPORE MADE)

Ref. No.	Address	Part No.	Description	Desti- nation	Re- marks
参照番号	位置	部品番号	部品名/規格	仕 向	備考
601	1A	A01-2948-01	METALLIC CABINET		
602	2A	A40-0488-02	PANEL ASSY		
605	1B	X94-1011-41	REMOTE CONTROL ASSY UNIT		
606	1B	A09-0126-03	BATTERY COVER		
609	2A	B01-0487-11	PANEL ESCUTCHEON		
611	2A	B12-0201-04	INDICATOR		
612	2A	B12-0202-04	INDICATOR		
613	2A	B15-1520-04	LIGHTING BOARD		
		B46-0096-33	WARRANTY CARD		
		B46-0310-03	WARRANTY CARD		
		B52-0528-00	CONNECTING DIAGRAM		
		B52-0529-00	CONNECTING DIAGRAM		
		B60-1302-00	INSTRUCTION MANUAL (ENGLISH)		
		B60-1303-00	INSTRUCTION MANUAL (FRENCH)		
		B60-1304-00	INSTRUCTION MANUAL (GERMAN)		
		B60-1305-00	INSTRUCTION MANUAL (DUTCH)		
		B60-1306-00	INSTRUCTION MANUAL (ITALIAN)		
		B60-1307-00	INSTRUCTION MANUAL (SPANISH)		
		B60-1308-00	INSTRUCTION MANUAL (ENGLISH)		
		B60-1309-00	INSTRUCTION MANUAL (SPANISH)		
		B60-1310-00	INSTRUCTION MANUAL (CHINESE)		
616	1C	E30-2277-15	AC POWER CORD		
616	1C	E30-2715-05	AC POWER CORD		
616	1C	E30-2719-05	AC POWER CORD		
616	1B	E03-0141-05	AC OUTLET		
620	2A	011-0155-14	SGRT TAPE (40X9X2)		
		H50-0780-04	ITEM CARTON CASE		
		H50-0781-04	ITEM CARTON CASE		
		H50-0782-04	ITEM CARTON CASE		
		H50-0783-04	ITEM CARTON CASE		
		H10-5624-02	POLYSTYRENE FOAMED FIXTURE R		
		H10-5627-02	POLYSTYRENE FOAMED FIXTURE L		
		H10-5628-02	POLYSTYRENE FOAMED FIXTURE R		
		H13-0111-14	CARTON BOARD		
		H25-0232-04	PROTECTION BAG (235X350X0.03)		
		H25-0304-04	PROTECTION BAG (0232 PRINTED)		
		H25-0651-04	PROTECTION BAG (0304 PRINTED)		
		H25-0654-04	PROTECTION BAG (0304 PRINTED)		
625	2C	J02-0364-15	FOOT		
626	2C	J02-1040-05	FOOT		
627	2C	J12-0091-05	FRONT PIN		
628	1C	J42-0083-05	POWER CORD BUSHING		

PARTS LIST

A-57/77

M New Parts
 Parts without Parts No. are not supplied.
 Les articles non mentionnés dans le Parts No. ne sont pas fournis.
 Teile ohne Parts No. werden nicht geliefert.

NO.3

Ref. No.	Address	Part No.	Description	Desti- nation	Re- marks
参照番号	位置	部品番号	部品名 / 規格	仕 向	備 考
630	2A	K23-2081-14	KN8 SPEAKER ON/OFF A/B	E	
631	2A	K23-2501-04	KN8 BALANCE	T	
632	2A	K23-4401-04	KN8 VOLUME CONTROL	M	
633	2A	K23-4402-04	KN8 INPUT SELECTOR	X	
634	2A	K29-4403-04	KN8 BASS, TREBLE	ETX	
640	1B	L07-0524-15	POWER TRANSFORMER	M	
640	1B	L07-0525-15	POWER TRANSFORMER	T	
640	1B	L07-0523-15	POWER TRANSFORMER	M	
640	1B	L07-0648-05	POWER TRANSFORMER	X	
640	1B	L07-0553-05	POWER TRANSFORMER	ETX	
640	1B	L07-0561-05	POWER TRANSFORMER	M	
640	1C	N09-2903-05	TAPITTE SCREW	E	
640	2B	N88-4008-45	BINDING HEAD TAPITTE SCREW	T	
640	1B, 2B	N87-3004-46	BRAZIER HEAD TAPITTE SCREW	M	
640	1B, 1C	N88-3008-45	FLAT HEAD TAPITTE SCREW	X	
640	1A, 1C	N89-3008-45	BINDING HEAD TAPITTE SCREW	ETX	
640	1B, 2B	N89-3008-46	BINDING HEAD TAPITTE SCREW	M	
A-77 (JAPAN MADE)					
601	1A	A01-2948-01	METALLIC CABINET	E	
602	2A	A60-0488-02	PANEL ASSY	ET	
605	1A	X94-1001-41	REMOTE CONTROL ASSY UNIT	MX	
606	1A	A09-0115-13	BATTERY COVER	E	
609	2A	B01-0486-11	PANEL ESCUTCHEON	E	
610	2A	B10-1922-03	FRONT GLASS	ET	
611	2A	B12-0201-04	INDICATOR	MX	
613	2A	B19-1520-04	LIGHTING BOARD	ET	
		B46-0096-33	WARRANTY CARD	X	
		B46-0310-03	WARRANTY CARD	ET	
		B52-0528-00	CONNECTING DIAGRAM	ET	
		B52-0529-00	CONNECTING DIAGRAM	MX	
		B60-1302-00	INSTRUCTION MANUAL (ENGLISH)	E	
		B60-1303-00	INSTRUCTION MANUAL (FRENCH)	E	
		B60-1304-00	INSTRUCTION MANUAL (GERMAN)	E	
		B60-1305-00	INSTRUCTION MANUAL (DUTCH)	E	
		B60-1306-00	INSTRUCTION MANUAL (ITALIAN)	E	
		B60-1307-00	INSTRUCTION MANUAL (SPANISH)	E	
		B60-1309-00	INSTRUCTION MANUAL (SPANISH)	M	
		B60-1310-00	INSTRUCTION MANUAL (ENGLISH)	M	
616	1C	E30-2277-15	AC POWER CORD	EM	
616	1C	E30-2715-05	AC POWER CORD	X	
616	1C	E30-2719-05	AC POWER CORD	T	
616	1B	E03-0141-05	AC OUTLET	X	
620	2A	Q11-0155-14	SOFT TAPE (40X9X2)	EMX	
		H50-0772-04	ITEM CARTON CASE	EMX	
		H50-0773-04	ITEM CARTON CASE	T	
		H10-5603-02	POLYSTYRENE FOAMED FIXTURE L	EMX	
		H10-5604-02	POLYSTYRENE FOAMED FIXTURE R	EMX	
		H10-5605-02	POLYSTYRENE FOAMED FIXTURE L	T	
		H10-5606-02	POLYSTYRENE FOAMED FIXTURE R	T	
		H13-0110-04	CARTON BOARD	X	
		H25-0232-04	PROTECTION BAG (235X350X0.03)	EMX	
		H25-0304-04	PROTECTION BAG	EMX	

USA
 Canada
 Europe
 Other Areas

△ indicates safety critical components.

M New Parts
 Parts without Parts No. are not supplied.
 Les articles non mentionnés dans le Parts No. ne sont pas fournis.
 Teile ohne Parts No. werden nicht geliefert.

NO.4

Ref. No.	Address	Part No.	Description	Desti- nation	Re- marks
参照番号	位置	部品番号	部品名 / 規格	仕 向	備 考
		H25-0651-04	PROTECTION BAG (233 PRINTED)	T	
		H25-0656-04	PROTECTION BAG (304 PRINTED)	E	
625	2C	J02-0366-15	FOOT	E	
626	2C	J02-1040-05	REAR	ET	
627	2C	J12-0091-05	FRONT	ET	
628	1C	J42-0093-05	POWER CORD BUSHING	ETX	
630	2B	K27-2081-14	KN8 SPEAKER ON/OFF A/B	E	
631	2A	K29-2507-04	KN8 BALANCE	T	
632	2A	K29-4403-04	KN8 VOLUME CONTROL	M	
633	2A	K29-4404-04	KN8 INPUT SELECTOR	X	
634	2A	K29-4405-04	KN8 BASS, TREBLE	ETX	
640	1B	L07-0520-15	POWER TRANSFORMER	E	
640	1B	L07-0521-15	POWER TRANSFORMER	T	
640	1B	L07-0522-15	POWER TRANSFORMER	M	
640	1B	L07-0647-05	POWER TRANSFORMER	X	
640	1B	L07-0555-05	POWER TRANSFORMER	ETX	
640	1B, 2B	L07-0557-05	POWER TRANSFORMER	M	
640	1C	N09-2906-05	TAPITTE SCREW	E	
640	2B	N86-4008-45	BINDING HEAD TAPITTE SCREW	T	
640	1B, 2B	N87-3008-46	BRAZIER HEAD TAPITTE SCREW	M	
640	1B, 1C	N88-3008-45	FLAT HEAD TAPITTE SCREW	X	
640	1A, 1C	N89-3008-45	BINDING HEAD TAPITTE SCREW	ETX	
640	1B, 2B	N89-3008-46	BINDING HEAD TAPITTE SCREW	M	
A-77 (SINGAPORE MADE)					
601	1A	A01-2948-01	METALLIC CABINET	E	
602	2A	A60-0488-02	PANEL ASSY	ET	
605	1A	X94-1011-41	REMOTE CONTROL ASSY UNIT	MX	
606	1B	A09-0124-03	BATTERY COVER	E	
609	2A	B01-0486-11	PANEL ESCUTCHEON	E	
610	2A	B10-1922-03	FRONT GLASS	ET	
611	2A	B12-0201-04	INDICATOR	MX	
613	2A	B19-1520-04	LIGHTING BOARD	ET	
		B46-0096-33	WARRANTY CARD	X	
		B46-0310-03	WARRANTY CARD	ET	
		B52-0528-00	CONNECTING DIAGRAM	ET	
		B52-0529-00	CONNECTING DIAGRAM	MX	
		B60-1302-00	INSTRUCTION MANUAL (ENGLISH)	E	
		B60-1303-00	INSTRUCTION MANUAL (FRENCH)	E	
		B60-1304-00	INSTRUCTION MANUAL (GERMAN)	E	
		B60-1305-00	INSTRUCTION MANUAL (DUTCH)	E	
		B60-1306-00	INSTRUCTION MANUAL (ITALIAN)	E	
		B60-1307-00	INSTRUCTION MANUAL (SPANISH)	E	
		B60-1308-00	INSTRUCTION MANUAL (SPANISH)	MX	
		B60-1309-00	INSTRUCTION MANUAL (ENGLISH)	M	
		B60-1310-00	INSTRUCTION MANUAL (CHINESE)	M	
616	1C	E30-2277-15	AC POWER CORD	EM	
616	1C	E30-2715-05	AC POWER CORD	X	
616	1C	E30-2719-05	AC POWER CORD	T	
616	1B	E03-0141-05	AC OUTLET	X	
620	2A	Q11-0155-14	SOFT TAPE (40X9X2)	EMX	
		H50-0776-04	ITEM CARTON CASE	E	

USA
 Canada
 Europe
 Other Areas

△ indicates safety critical components.

PARTS LIST

A-57177

Parts without Parts No. are not supplied.
Les articles non mentionnés dans le Parts No. ne sont pas fournis.
Teile ohne Parts No. werden nicht geliefert.

NO.5

Ref. No. 参照番号	Address 位置	New 新	Parts No. 部品番号	Description 部品名/規格	Desti- nation 向番	Re- marks 備考
625	2C		H50-0777-04	ITEM CARTON CASE	T	
626	2C		H50-0778-04	ITEM CARTON CASE	X	
627	1C		H50-0779-04	ITEM CARTON CASE	X	
628	1C		H10-5625-02	POLYSTYRENE FOAMED FIXTURE L	EMX	
			H10-5626-02	POLYSTYRENE FOAMED FIXTURE R	EMX	
			H10-5627-02	POLYSTYRENE FOAMED FIXTURE L	T	
			H10-5628-02	POLYSTYRENE FOAMED FIXTURE R	T	
			H13-0111-14	CARTON BOARD (235X350X0.03)	EMX	
			H25-0232-04	PROTECTION BAG	EMX	
			H25-0304-04	PROTECTION BAG	EMX	
			H25-0651-04	PROTECTION BAG (0232 PRINTED)	T	
			H25-0656-04	PROTECTION BAG (0304 PRINTED)	T	
629	2C		102-0346-15	FOOT REAR		
630	1C		112-0091-05	FOOT FRONT		
631	1C		142-0093-05	POWER CORO BUSHING PIN		
632	2A		K27-2081-14	KNB SPEAKER GN/0PG.A/B	E	
633	2A		K29-2397-04	KNB BALANCE CONTROL	T	
634	2A		K29-4403-04	KNB VOLUME SELECTOR	X	
635	2A		K29-4404-04	KNB INPUT SELECTOR	X	
636	2A		K29-4405-04	KNB BASS, TREBLE	X	
640	1B		L07-0520-15	POWER TRANSFORMER	E	
641	1B		L07-0521-15	POWER TRANSFORMER	T	
642	1B		L07-0522-15	POWER TRANSFORMER	X	
643	1B		L07-0647-05	POWER TRANSFORMER	X	
644	1B		L07-0555-05	POWER TRANSFORMER	ETX	
72			L07-0557-05	POWER TRANSFORMER	M	
			N09-2909-05	TAPITTE SCREW		
			N85-4008-45	BINDING HEAD TAPITTE SCREW		
			N87-3006-44	RAZOR HEAD TAPITTE SCREW		
			N88-3008-45	FLAT HEAD TAPITTE SCREW		
			N89-3008-45	BINDING HEAD TAPITTE SCREW		
			N89-3008-45	BINDING HEAD TAPITTE SCREW		
			N89-3008-45	BINDING HEAD TAPITTE SCREW		
			N89-3008-46	BINDING HEAD TAPITTE SCREW		
AUDIO UNIT (X09-363X-XX)						
C1.2			CC45FSLH221J	CERAMIC	220PF	J
C3.4			CK45FB1H222J	CERAMIC	0.022UF	Z
C5.6			CK45FB1H222K	CERAMIC	2200PF	K
C7.8			CE04LM1V100M	ELECTRO	10UF	35WV
C9.10			CC45FSL1H221J	CERAMIC	220PF	J
C11.12			CE04KM1A101M	ELECTRO	100UF	10WV
C13.14			CE04LM1A101M	ELECTRO	100UF	10WV
C15.16			CE92PV1H232J	MF	0.012UF	J
			CE92V1H332J	MF	3300PF	J
C17.18			CE04KM1H010M	ELECTRO	1.0UF	50WV
C19.20			CE04LM1H010M	ELECTRO	1.0UF	50WV
C21.22			CE04KM1E470M	ELECTRO	47UF	25WV
			CE04LM1E470M	ELECTRO	47UF	25WV
			CE04KM1E470M	ELECTRO	47UF	25WV
			CE04KM1E470M	ELECTRO	47UF	25WV
C27.28			CE04KM1V100M	ELECTRO	100UF	35WV
C29.30			CE04LM1V100M	ELECTRO	100UF	35WV
			CC45FSL1H101J	CERAMIC	100PF	J
C31.32			CE04KM1V100M	ELECTRO	100UF	35WV

LSandara KUSA PCanada
YP/g/r East Hawaii TERland EEurope
YAAE/F/E(G/rop) XAustralia MOther Area

J : JAPAN MADE
S : SINGAPORE MADE

5 : A-57
7 : A-77

△ indicates safety critical components.

Parts without Parts No. are not supplied.
Les articles non mentionnés dans le Parts No. ne sont pas fournis.
Teile ohne Parts No. werden nicht geliefert.

NO.6

Ref. No. 参照番号	Address 位置	New 新	Parts No. 部品番号	Description 部品名/規格	Desti- nation 向番	Re- marks 備考
C31.32			CE04LM1V100M	ELECTRO	100UF	35WV
C33.34			CE04LM1H010M	ELECTRO	220PF	K
C35.36			CC45FSLH221J	CERAMIC	220PF	J
C37.38			CE04KM1V100M	ELECTRO	10UF	35WV
			CE04LM1V100M	ELECTRO	10UF	35WV
			CC45FSL1H101J	CERAMIC	100PF	J
C39.40			CE04KM1V100M	ELECTRO	10UF	35WV
C41.42			CE04LM1V100M	ELECTRO	10UF	35WV
C43.44			CE04LM1V100M	ELECTRO	10UF	35WV
C45.46			CC45FSLH221J	CERAMIC	220PF	J
C47.48			CE04KM1H010M	ELECTRO	0.1UF	50WV
C49.50			CE04KM1V100M	ELECTRO	10UF	35WV
C51.52			CE04LM1H010M	ELECTRO	0.1UF	50WV
C53.54			CE04KM1V100M	ELECTRO	10UF	35WV
C55.56			CE04LM1V100M	ELECTRO	0.12UF	J
C57.58			CE04KM1V100M	ELECTRO	1.0UF	35WV
C59.60			CE04KM1V487M	ELECTRO	4.7UF	35WV
C61.62			CE04LM1H010M	ELECTRO	1.0UF	50WV
C63.64			CE04LM1V487M	ELECTRO	4.7UF	35WV
C65.66			CK45FB1H1032	CERAMIC	0.010UF	Z
C67.68			CK45FB1H222K	CERAMIC	2200PF	K
C71.72			CE92PV1H104J	MF	0.10UF	J
C73.74			CE92PV1H104J	MF	6800UF	55WV
C75.76			CE92PV1H682J	MF	6800PF	J
C77.78			CC45FSL1H221J	CERAMIC	220PF	J
C79			CE04KM1A101M	ELECTRO	100UF	10WV
C81			CE04LM1A101M	ELECTRO	100UF	10WV
C83			CE04KM1H010M	ELECTRO	1.0UF	50WV
C85			CE04LM1H010M	ELECTRO	1.0UF	50WV
C87			CE04KM1V100M	ELECTRO	1.0UF	35WV
C89			CE04LM1V100M	ELECTRO	10UF	35WV
C91			CK45FB1H102K	CERAMIC	1000PF	K
C93			CK45FB1H222K	CERAMIC	2200PF	K
C95			CK45FB1H102K	CERAMIC	1000PF	K
C97			CK45FB1H102K	CERAMIC	1000PF	K
C99			CK45FB1H222K	CERAMIC	2200PF	K
C101			CK45FB1H102K	CERAMIC	1000PF	K
C103			CK45FB1H102K	CERAMIC	1000PF	K
C105			CK45FB1H222K	CERAMIC	2200PF	K
C106.107			CK45FB1H102K	CERAMIC	1000PF	K
C109			CE04KM1E102M	ELECTRO	25WV	
C111			CE04LM1E102M	ELECTRO	25WV	
C113			CE04KM1V102M	ELECTRO	0.12UF	J
C115			CE04LM1V102M	ELECTRO	0.12UF	J
C117			CE04KM1A101M	ELECTRO	100UF	10WV
C119			CE04LM1A101M	ELECTRO	100UF	10WV
C121			CE04KM1H124J	MF	0.12UF	J
C123			CE04KM1V102M	ELECTRO	1000UF	35WV
C125			CE04LM1V102M	ELECTRO	1000UF	35WV
C127			CE04KM1C101M	ELECTRO	1000UF	16WV

LSandara KUSA PCanada
YP/g/r East Hawaii TERland EEurope
YAAE/F/E(G/rop) XAustralia MOther Area

J : JAPAN MADE
S : SINGAPORE MADE

5 : A-57
7 : A-77

△ indicates safety critical components.

PARTS LIST

A-57/77

PARTS LIST

NO.12

* New Parts
Parts without Parts No. are not supplied.
Les articles non mentionnés dans le Parts No. ne sont pas fournis.
Teile ohne Parts No. werden nicht geliefert.

Table with columns: Ref. No., Address, Parts No., Description, Destination. Includes parts like AC GUTLET, FUSE, WIRE CLAMPER, RESONATOR, etc.

J: JAPAN MADE
S: SINGAPORE MADE
5: A-57
7: A-77
Indicates safety critical components.

NO.11

* New Parts
Parts without Parts No. are not supplied.
Les articles non mentionnés dans le Parts No. ne sont pas fournis.
Teile ohne Parts No. werden nicht geliefert.

Table with columns: Ref. No., Address, Parts No., Description, Destination. Includes parts like TRANSISTOR, ELECTRIC CIRCUIT MODULE, CONTROL UNIT, etc.

J: JAPAN MADE
S: SINGAPORE MADE
5: A-57
7: A-77
Indicates safety critical components.

PARTS LIST

NO.14

Ref. No. 参照番号	Address 位置	Parts No. 部品番号	Description 部品名 / 規格	Desti- nation 仕	Re- marks 備考
D1 .2		1SS133	DIODE		
D3		HSS1044	DIODE		
D3		1SS131	DIODE		
Q1 -4		2SA992(F,E)	TRANSISTOR		
Q5 -8		2SC1845(F,E)	TRANSISTOR		
Q9 .10		2SA992(F,E)	TRANSISTOR		
Q11		2SC1740S(Q,R)	TRANSISTOR		
Q11		2SC2459(Y,GR)	TRANSISTOR		
Q11		2SC2785(F,E)	TRANSISTOR		
Q11		2SC3311A(Q,R)	TRANSISTOR		
Q12		DTC124ES	DIGITAL TRANSISTOR		S
Q12		UN4212	TRANSISTOR		J S J

J : JAPAN MADE
S : SINGAPORE MADE
5 : A-57
7 : A-77

L:Scandinavia K:USA P:Canada
Y:Y(Far East, Hawaii) T:England E:Europe
Y:AA(FE)(Europe) X:Australia M:Other Areas

△ indicates safety critical components.

NO.13

Ref. No. 参照番号	Address 位置	Parts No. 部品番号	Description 部品名 / 規格	Desti- nation 仕	Re- marks 備考
D15		R05.1E5(B2)	ZENER DIODE		
D16		R25.7N(B2)	ZENER DIODE		
D16		R04.7E5(B2)	ZENER DIODE		
D17		R25.16N(B2)	ZENER DIODE		
D17		R01.6E5(B2)	ZENER DIODE		
D18		R25.13N(B2)	ZENER DIODE		
D18		R01.3E5(B2)	ZENER DIODE		
D23		HSS1044	DIODE		ETX
D23		1SS131	DIODE		ETX
D24		HSS1044	DIODE		M
D24		1SS131	DIODE		M
D25		1SS133	DIODE		
BD1		CM1154C	INDICATOR TUBE		
IC1		UP0752460W-044	IC(4BIT MICROPROCESSOR)		
IC2		PST529D	IC(SYSTEM RESET)		
IC3 .4		NJM4545L-0	IC(60 AMP X2)		
IC5		T8A09S	IC(MOTOR CONTROL)		
Q1		2SA952(L,K)	TRANSISTOR		J
Q1		2SA1048(Y,GR)	TRANSISTOR		
Q3		2SA1175(F,E)	TRANSISTOR		S
Q3		2SA1309A(Q,R)	TRANSISTOR		J
Q3		2SA935(Q,R)	TRANSISTOR		S
Q5 .6		2SC1845(F,E)	TRANSISTOR		
Q7		2SA1048(Y,GR)	TRANSISTOR		J
Q7		2SA1175(F,E)	TRANSISTOR		S
Q7		2SA1309A(Q,R)	TRANSISTOR		J
Q9		2SA935(Q,R)	TRANSISTOR		S
Q9		2SC2878(A,B)	TRANSISTOR		S
A1		W02-1046-05	ELECTRIC CIRCUIT MODULE		
MAIN AMPLIFIER UNIT (X85-122X-XX)					
C1 .2		CE04K1H010M	ELECTRO 1.0UF 50WV		J S
C1 .4		CE04L1H010M	ELECTRO 1.0UF 50WV		
C3 .4		CK45F1H471K	CERAMIC 470PF K		
C5 .6		C90-1844-05	ELECTRIC 470UF 6.3WV		
C7 .8		CC45FSL1H121J	CERAMIC 120PF J		
C9		CC45FSL1H020C	CERAMIC 2.0PF C		
C11 .12		CC45FSL1H221J	CERAMIC 220PF J		
C13 .14		CC45FSL1H390J	CERAMIC 39PF J		
C15 .16		CC45FSL1H221J	CERAMIC 220PF J		
C17 .18		CE04K1H470M	ELECTRO 47UF 50WV		J
C17 .18		CE04L1H470M	ELECTRO 47UF 50WV		S
C19		CE04HM1A470M	NP-ELECC 47UF 10WV		
C20		CE04K1V477M	ELECTRO 4.7UF 35WV		J S
C20		CE04L1V477M	ELECTRO 4.7UF 35WV		
R5 .6		RN14BK2C22151F	RN 2.15K F 1/6W		ET
R5 .6		RN14BK2C2371F	RN 2.37K F 1/6W		MX
R5 .6		RN14BK2C2611F	RN 2.61K F 1/6W		ET
R5 .6		RN14BK2C2871F	RN 2.87K F 1/6W		HX
R15 .16		R0146B28271J	FL-PR00E R0 270 J 1/4W		
R21 -24		R0146B28211J	FL-PR00E R0 220 J 1/4W		
R25 .26		R0146B28470J	FL-PR00E R0 47 J 1/4W		
D1 .2		HSS1044	DIODE		

J : JAPAN MADE
S : SINGAPORE MADE
5 : A-57
7 : A-77

L:Scandinavia K:USA P:Canada
Y:Y(Far East, Hawaii) T:England E:Europe
Y:AA(FE)(Europe) X:Australia M:Other Areas

△ indicates safety critical components.

* New Parts
Parts without Parts No. are not supplied.
Les articles non mentionnés dans le Parts No. ne sont pas fournis.
Teile ohne Parts No. werden nicht geliefert.

* New Parts
Parts without Parts No. are not supplied.
Les articles non mentionnés dans le Parts No. ne sont pas fournis.
Teile ohne Parts No. werden nicht geliefert.