

TUNER/GRAPHIC EQUALIZER
C-H5/H51/H5W/H6/H61/H6W/H7
SERVICE MANUAL
(XD-6000/8000/9580 SERIES)

KENWOOD

© 1997-4/B51-5297-00 (K/K) 2341

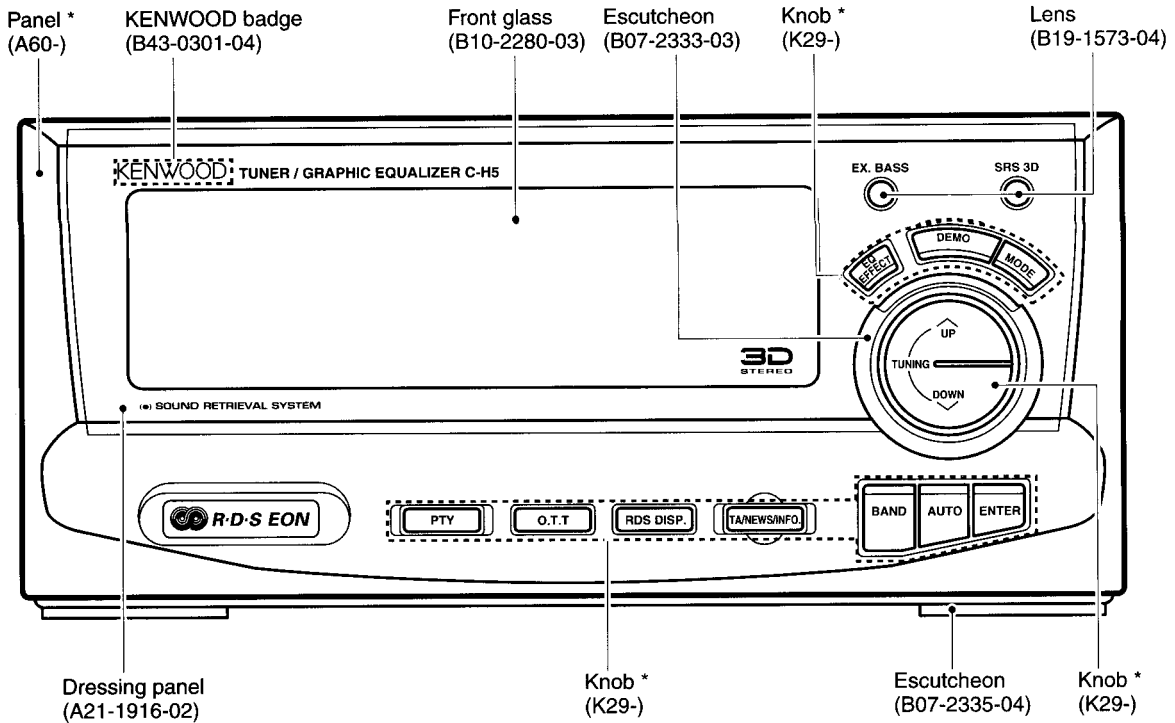

Metallic cabinet (A01-3434-01)

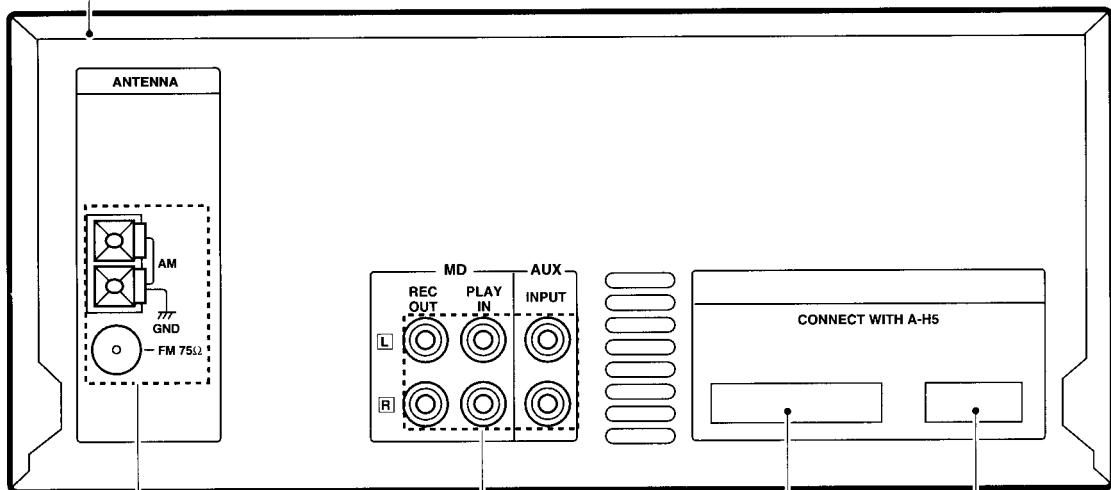

Lock terminal board * (E70-)

Phono jack (E63-0047-15)

Rectangular receptacle (E58-0006-05)

Rectangular receptacle (E58-0016-05)

PRECAUTIONS FOR REPAIR

C-H5-H7 do not have a power supply transformer. Use A-H5 or PS-94UA power supply to supply power.

Illustration is C-H5.

* Refer to parts list on page 33.



C-H5/H51/H5W/H6/H61/H6W/H7





CONTENTS / ACCESSORIES

Contents

CONTENTS / ACCESSORIES.....	2	SCHEMATIC DIAGRAM.....	15
CONTROLS	3	EXPLODED VIEW	32
CIRCUIT DESCRIPTION	6	PARTS LIST	33
ADJUSTMENT	10	SPECIFICATIONS	Back cover
PC BOARD	11		

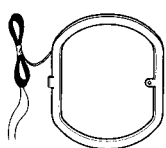
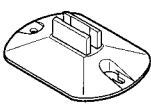
Note : On serial test mode, refer to **KR-7080/8080 (B51-5162-00)** Service manual.

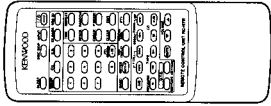
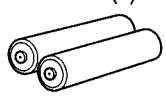
Accessories

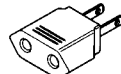
AM loop antenna assy (1) (T90-0820-05) 	Loop antenna stand(1) 	Parallel cord (E30-2738-05) 	Remote control unit (1) * (A70-)  Battery cover : (A09-0380-08)
Batteries (R6/AA) (2) (-) 	Speaker cord (2) (E30-5156-08) 	FM indoor antenna (1) (T90-0801-05): KMYI (T90-0809-05): TEQ 	AC plug adaptor (1) (Except for the Europe. U.K. and Australia) (E03-0115-05)  For the unit with a European AC plug in areas other than Europe.

* Refer to parts list.

System configuration

SYSTEM	TUNER / EQUALIZER	AMPLIFIER	CASSETTE DECK	CD PLAYER	SPEAKER	MD RECORDER
XD-6060	C-H51	A-H5	X-H5	DP-H5	LS-H6	-
XD-6500	C-H5	A-H5	X-H5	DP-MH5	LS-H5	-
XD-6560	C-H51	A-H5	X-H5	DP-MH5	LS-H6	-
XD-8000	C-H6	A-H5	X-H5	DP-H5	LS-H6	-
XD-8550	C-H6	A-H5	X-H5	DP-MH5	LS-H6	-
XD-8560	C-H61	A-H5	X-H5	DP-MH5	LS-H6	-
XD-6000/W	C-H5/W	A-H5	X-H5	DP-H5	LS-H5	-
XD-6050/W	C-H5/W	A-H5	X-H5	DP-H5	LS-H5	-
XD-6550/W	C-H5/W	A-H5	X-H5	DP-MH5	LS-H5	-
XD-8050/W	C-H6/W	A-H5	X-H5	DP-H5	LS-H6	-
XD-8500/W	C-H6	A-H5	X-H5	DP-MH5	LS-H6	-
XD-9580MD	C-H7	A-H5	-	DP-MH5	LS-H6	DM-H5

PCB ASS'Y vs MODEL NAME

PCB NAME	TYPE	MODEL NAME
X04-1313-81	Q	C-H5W/H6W
X05-4650-52	T	C-H5/H6/H7
X05-4652-71	E	C-/H5/H6/H7
X05-4653-82	Q	C-/H5W/H6W
X05-4660-12	K	C-H7
X05-4660-21	Y/M/I	C-H51/H61/H7
X11-3700-21	K/M	C-H7
X11-3700-22	Y/M/I	C-H61
X11-3700-23	Y/M/I	C-H51

PCB NAME	TYPE	MODEL NAME
X11-3700-51	T	C-H7
X11-3700-52	T	C-H6
X11-3700-53	T	C-H5
X11-3702-71	E	C-H7
X11-3702-72	E	C-H6
X11-3702-73	E	C-H5
X11-3703-81	Q	C-H6W
X11-3703-82	Q	C-H5W

C-H5/H51/H5W/H6/H61/H6W/H7

CONTROLS

Tuner/Equalizer Unit (C-H5)

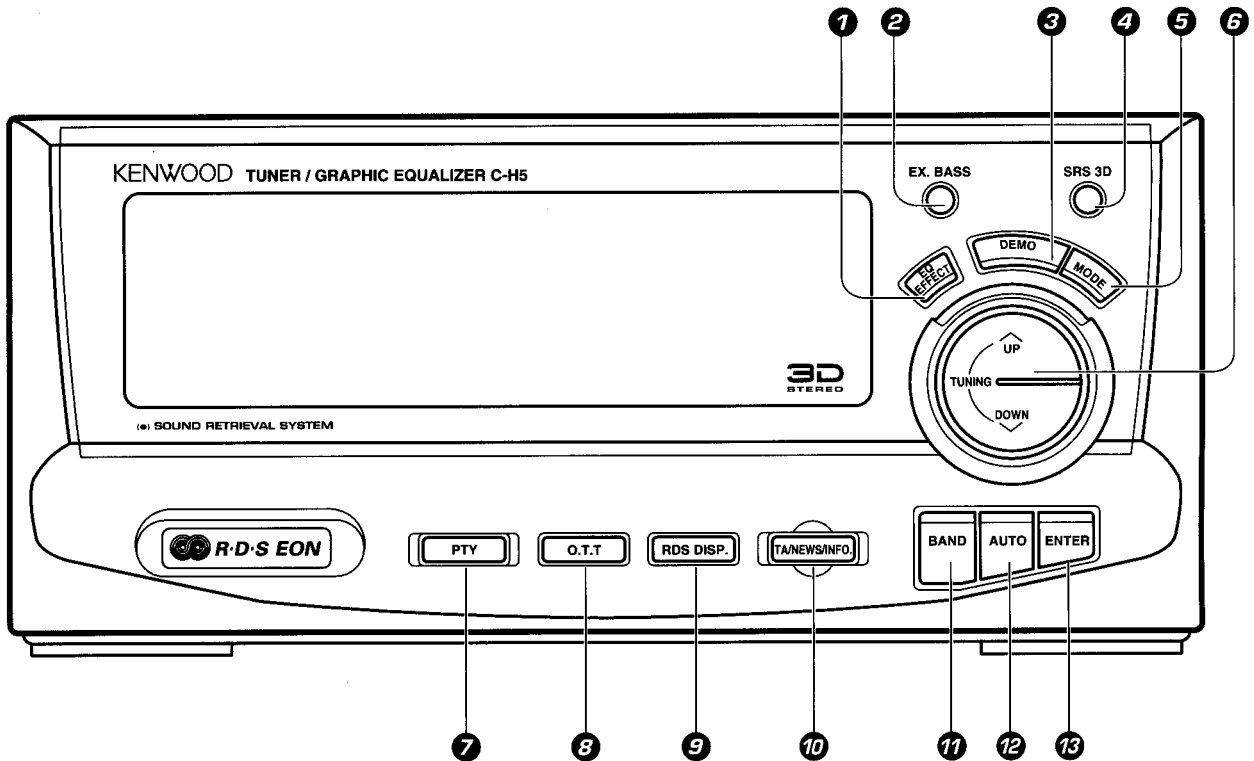

1 EQ. EFFECT Key

The equalizer defect is switched ON/OFF and the type of equalizer effect is selected.

2 EX. BASS (Extra bass) key/Indicator

When power is ON: Press to enhance.
When power is STANDBY: Used in the timer setting operation.

3 DISPLAY/DEMO key

when power is ON: Switches the displayed information. Switches the demonstration on and off.

When power is STANDBY: Switches the demonstration on and off.

4 SRS 3D key/Indicator

When power is ON: Switches the SRS 3D play on and off.

When power is STANDBY: Used in the timer setting operation.

5 MODE key

Press to switch the function of the **TUNING UP/DOWN** keys. The function which can be selected are variable depending on the condition of the system at each moment.

6 TUNING UP/DOWN key

These keys are usually used to select the broadcast station to be selected. When required, the functions of these keys can be switched with the MODE key.

7 PTY key

8 O.T.T key

Press when setting the O.T.T timer function.

9 RDS DISP. key

10 TA/NEWS/INFO. key

When power is STANDBY: Switches the auto power-save mode on and off.

11 BAND key

Press to switch the receiving band.

12 AUTO key

When power is ON: Switches the tuning mode.

When power is STANDBY: Used in the clock adjustment.

13 ENTER key

Used for time setting, timer setting, etc.

* Please refer to **A-H5** service manual on Remote control.

C-H5/H51/H5W/H6/H61/H6W/H7

CONTROLS

Display (C-H5)

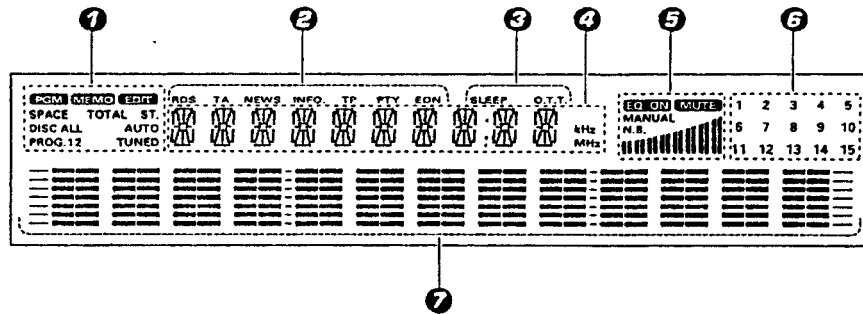

1 Tuner and applied operation indicators

This section contains the indicators of the tuner operations as well as applied CD operation.

2 RDS-related indicators

3 Timer-related display

4 Character information display

5 Volume/tone-Timer-related display

This includes the graphic display of the current volume size and the indicators which light up when the equalizer is controlled.

6 Music calendar display

The indicators in this section show the number of tracks recorded on a CD. Each track number indicators turns off when the playback of the track has completed.

7 Graphic equalizer display

The displayed equalizer pattern varies according to the musci played. The equalizer pattern display format can be changed as required.

Display (C-H6)

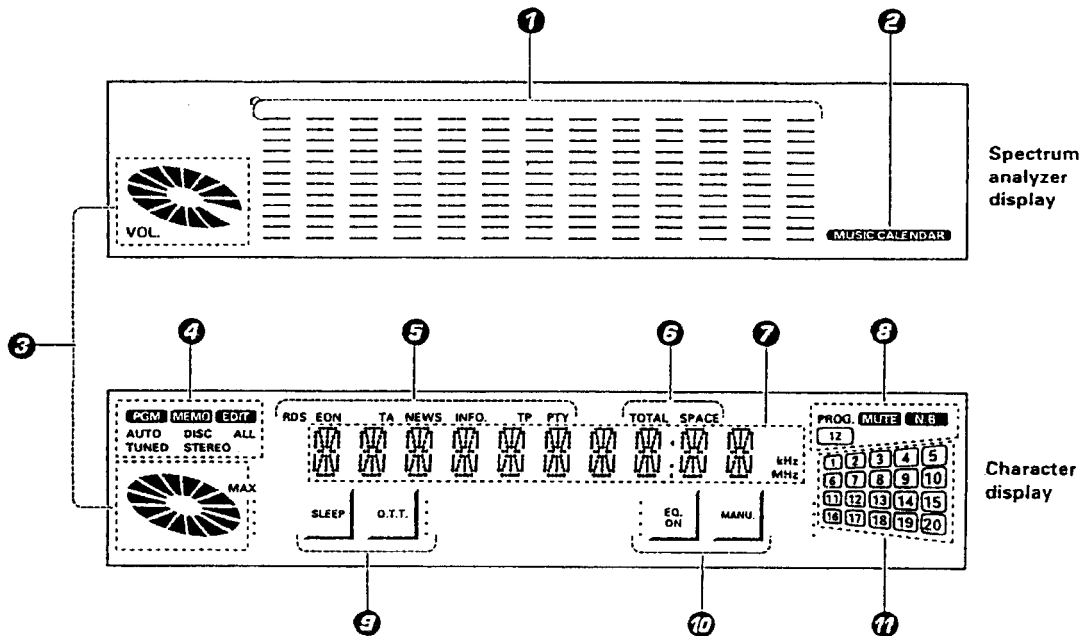

1 Equalizer indicator

This section shows the equalizer pattern in use. The equalizer pattern display format can be switched.

2 MUSIC CALENDAR indicator

3 Volume indicator

The display varies as the **VOLUME CONTROL** of the amplifier unit (A-H5) is operated. Usually, this section shows the current volume setting.

4 Tuner and applied operation indicators

This section contains the indicators of the tuner operations as well as applied CD operation.

5 RDS-related indicators

6 CD-related indicators

These indicator light during recording and playback of CD.

7 Character information indicators

8 Timer reservation program No./MUTE/N.B. indicators

9 Timer-related indicators

10 Equalizer operation indicators

11 Music calendar indicators

The indicators in this section show the number of tracks recorded on a CD. Each track number indicators turns off when the playback of the track has completed.

C-H5/H51/H5W/H6/H61/H6W/H7

CIRCUIT DESCRIPTION

1. INITIAL STATE

AMP SECTION

POWER ON/STANDBY : OFF
 # SELECTOR : TUNER
 • PROTECTION : OFF
 # MAIN VOLUME : 7
 # L/R BALANCE : CENTER
 • N.B. CIRCUIT : OFF
 # SRS 3D EFFECT LEVEL : 0
 # SRS S3 : OFF
 • SOURCE DIRECT : OFF
 • EXTRA BASS : ON
 • MUTE : OFF
 # INPUT LEVEL : -4dB(DISPLAY -2)
 • MD SYSTEM REC LEVEL : 0dB(NO DISPLAY)

TUNER SECTION

• BAND : FM
 # PRESENT BAND

• FREQUENCY(FM) : 87.5MHz
 • FREQUENCY(AM) : 531kHz
 # PRESENT FREQUENCY
 # AUTO/MONO : AUTO
 • P.CH : —ch
 • TIME : AM12:00
 # PROG. TIMER(1 AND 2) : WORKING MODE OFF
 : ON=AM12:00
 : OFF=AM12:00
 : MODE=PLAY
 : SOURCE TUNER 01CH
 # PROG.EXECUTION : OFF
 • SLEEP TIMER : OFF
 # O.T.T. : OFF(AM:7:00)

EQUALIZER SECTION

• EQUALIZER : OFF
 # MANUAL CURVE : FLAT
 # : backup item

1-1. Initializing

The system is initialized when the power is turning on while pressing the <ENTER> key.

2. DESTINATION LIST OF TUNER

Destination	Band	Frequency Range	Channel space	IF	PLL Frequency	Diode SW			
						DSW3	DSW2	DSW1	DSW0
J1 (90.0)	FM	76.0MHz ~ 90.0MHz	100kHz	-10.7MHz	25kHz	0	0	1	0
	AM	531kHz ~ 1602kHz	9kHz	+450kHz	9kHz				
K2 (1610)	FM	87.5MHz ~ 108.0MHz	100kHz	+10.7MHz	25kHz	0	0	0	1
	AM	530kHz ~ 1610kHz	10kHz	+450kHz	10kHz				
E1	FM	87.5MHz ~ 108.0MHz	50kHz	+10.7MHz	25kHz	0	0	1	1
	AM	531kHz ~ 1602kHz	9kHz	+450kHz	9kHz				
E3 (RDS)	FM	87.5MHz ~ 108.0MHz	50kHz	+10.7MHz	25kHz	0	1	0	1
	AM	531kHz ~ 1602kHz	9kHz	+450kHz	9kHz				
E4 (LW) (RDS)	FM	87.5MHz ~ 108.0MHz	50kHz	+10.7MHz	25kHz				
	MW	531kHz ~ 1602kHz	9kHz	+450kHz	9kHz	0	1	1	0
	LW	153kHz ~ 279kHz	9kHz	+450kHz	9kHz				
Q (RDS)	FML	65.0MHz ~ 74.0MHz	10kHz	+10.7MHz	5kHz				
	FMH	87.5MHz ~ 108.0MHz	50kHz	+10.7MHz	5kHz	0	1	1	1
	MW	531kHz ~ 1602kHz	9kHz	+450kHz	9kHz				
	LW	153kHz ~ 279kHz	9kHz	+450kHz	9kHz				
M	K2/E1 change only setting "DSW1" (DSW1 = 0 : K2, 1 : E1)					0	0	X	1

※ Diode SW(DSWx) :
 0 = no diode (static mode, LOW)
 1 = diode (static mode, HIGH)
 X = Transistor SW (0=OFF/1=ON)

C-H5/H51/H5W/H6/H61/H6W/H7

CIRCUIT DESCRIPTION

3. TUNER Preset channel initial data table

Refer to next page.

4. TEST MODE

4-1 Test mode using the unit key

4-1-1 Setting Test Mode

Turn on the power while pressing <TUNING DOWN> key.

4-1-2 Canceling Test Mode

By turning off the power, the system is initialized and the test mode is canceled.

4-2-1 Contents of Test Mode

1) Automatic Power On

- The power on state is entered whenever the power is turned on while pressing the <TUNING DOWN>key. All function are then initialized.
- Sub clock oscillation check function is performed before the test mode. If the check result is OK, the system enters the test mode. The system will stop to work if oscillation NG and period NG with displaying error code5 and 6.

2) Display All Lighting Mode

- In the test mode, all the letters in display are lighted.
- After that, the all lighting mode is canceled when any key is pressed. The normal display obtained. Selector chooses TUNER mode.

3) Special Function

- In the test mode, rec level and input level are set to max.
- In the test mode, remote control is available.

4) Special Function in Tuner Mode

- Mode key: P.CALL DOWN works
- EQ. EFFECT key: P.CALL UP works.

5) Special Function except TUNER Mode

- BAND key: Selects the source direct on/off cyclically every time this key is pressed.
- MODE key: Selects the main volume, balance, eq.manual, srs 3D level*, rec level and input level cyclically in the order below every time this key is press.



* SRS 3D off=skip SRS level

- TUNING UP/DOWN key: item selected by MODE key sets to the minimum or maximum an 1 step. However EQ. MANUAL not available.
- AUTO/MONO key: item selected by MODE key is change cyclically in order as follows every time this key is pressed.

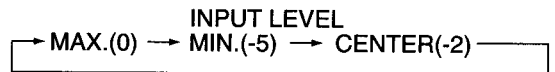
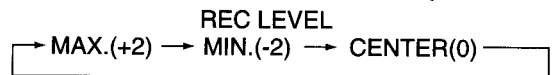
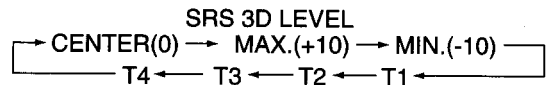
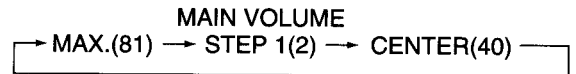
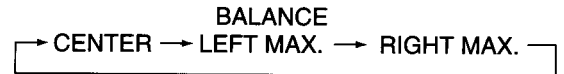

- SLEEP/CHRA key: Set rec level after CCRS. If the key is pressed again, normal function is works.
- EX.BASS key: Selects front or rear display cyclically in the order below every time this key is pressed.



Etc

- O.T.T. key : Selects the mute on/off cyclically every time this key is pressed.

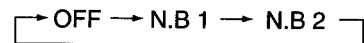

- ENTER key: Mute on/off

- DISPLAY key: Selects the selector cyclically in the order as follows every time this key is pressed.



C-H5/H51/H5W/H6/H61/H6W/H7

CIRCUIT DESCRIPTION

TUNER Preset channel memory

MR	Frequency									
	K1 (1700)		K2 (1610)		E (NO LW)		E (LW)		Q (NO LW)	
1	FM	87.5MHz	FM	87.5MHz	FM	87.5MHz	FM	87.5MHz	FM	87.5MHz
2	FM	97.5MHz	FM	97.5MHz	FM	97.5MHz	FM	97.5MHz	FM	97.5MHz
3	FM	108.0MHz	FM	108.0MHz	FM	108.0MHz	FM	108.0MHz	FM	108.0MHz
4	AM	630kHz	AM	630kHz	AM	630kHz	AM	630kHz	AM	630kHz
5	AM	1000kHz	AM	1000kHz	AM	999kHz	AM	999kHz	AM	999kHz
6	AM	1440kHz	AM	1440kHz	AM	1440kHz	AM	1440kHz	AM	1440kHz
7	FM	87.5MHz	FM	87.5MHz	FM	87.5MHz	LW	162kHz	FML	74.0MHz
8	FM	87.5MHz	FM	87.5MHz	FM	87.5MHz	LW	216kHz	FML	65.0MHz
9	FM	87.5MHz	FM	87.5MHz	FM	87.5MHz	LW	270kHz	FML	69.0MHz
10	FM	89.1MHz	FM	89.1MHz	FM	89.1MHz	FM	89.1MHz	FM	89.1MHz
11	FM	88.0MHz	FM	88.0MHz	FM	88.0MHz	FM	88.0MHz	FM	88.0MHz
12	FM	90.0MHz	FM	90.0MHz	FM	90.0MHz	FM	90.0MHz	FM	90.0MHz
13	FM	98.0MHz	FM	98.0MHz	FM	98.0MHz	FM	98.0MHz	FM	98.0MHz
14	FM	98.5MHz	FM	98.5MHz	FM	98.5MHz	FM	98.5MHz	FM	98.5MHz
15	FM	106.0MHz	FM	106.0MHz	FM	106.0MHz	FM	106.0MHz	FM	106.0MHz
16	AM	530kHz	AM	530kHz	AM	531kHz	AM	531kHz	AM	531kHz
17	AM	990kHz	AM	990kHz	AM	990kHz	AM	990kHz	AM	990kHz
18	AM	1700kHz	AM	1610kHz	AM	1602kHz	AM	1602kHz	AM	1602kHz
19	FM	87.5MHz	FM	87.5MHz	FM	87.5MHz	LW	153kHz	FM	87.5MHz
20	FM	87.5MHz	FM	87.5MHz	FM	87.5MHz	LW	279kHz	FM	87.5MHz
21	FM	96.3MHz	FM	96.3MHz	FM	96.3MHz	FM	96.3MHz	FM	96.3MHz
22	FM	107MHz	FM	107MHz	FM	107MHz	FM	107MHz	FM	107MHz
23	AM	900kHz	AM	900kHz	AM	900kHz	AM	900kHz	AM	900kHz
24	AM	1350kHz	AM	1350kHz	AM	1350kHz	AM	1350kHz	AM	1350kHz
25	FM	87.5MHz	FM	87.5MHz	FM	87.5MHz	LW	225kHz	FM	87.5MHz
26	FM	87.5MHz	FM	87.5MHz	FM	87.5MHz	FM	87.5MHz	FM	87.5MHz
27	FM	87.5MHz	FM	87.5MHz	FM	87.5MHz	FM	87.5MHz	FM	87.5MHz
28	FM	87.5MHz	FM	87.5MHz	FM	87.5MHz	FM	87.5MHz	FM	87.5MHz
29	FM	87.5MHz	FM	87.5MHz	FM	87.5MHz	FM	87.5MHz	FM	87.5MHz
30	FM	87.5MHz	FM	87.5MHz	FM	87.5MHz	FM	87.5MHz	FM	87.5MHz
31	FM	87.5MHz	FM	87.5MHz	FM	87.5MHz	FM	87.5MHz	FM	87.5MHz
⋮	⋮	⋮	⋮	⋮	⋮	⋮	⋮	⋮	⋮	⋮
40	FM	87.5MHz	FM	87.5MHz	FM	87.5MHz	FM	87.5MHz	FM	87.5MHz

C-H5/H51/H5W/H6/H61/H6W/H7

CIRCUIT DESCRIPTION

5. Microprocessor : M38198MCA-801FP

5-1. Microprocessor periphery block diagram

KEY MATRIX (PORT No.)

	KS0(94)	KR1(93)	KR2(92)	KR3(90)
KR0(44)	EQ. EFFECT	TUNING DOWN	HIT MASTER	RDS DISPLAY
KR0(43)	TUNING UP	ENTER	O.T.T.	—————
KR0(42)	DISPLAY/DEMO	AUTO/MONO	SLEEP	SRS 3D
KR0(41)	MODE	BAND	MUTE	EXTRA BASS

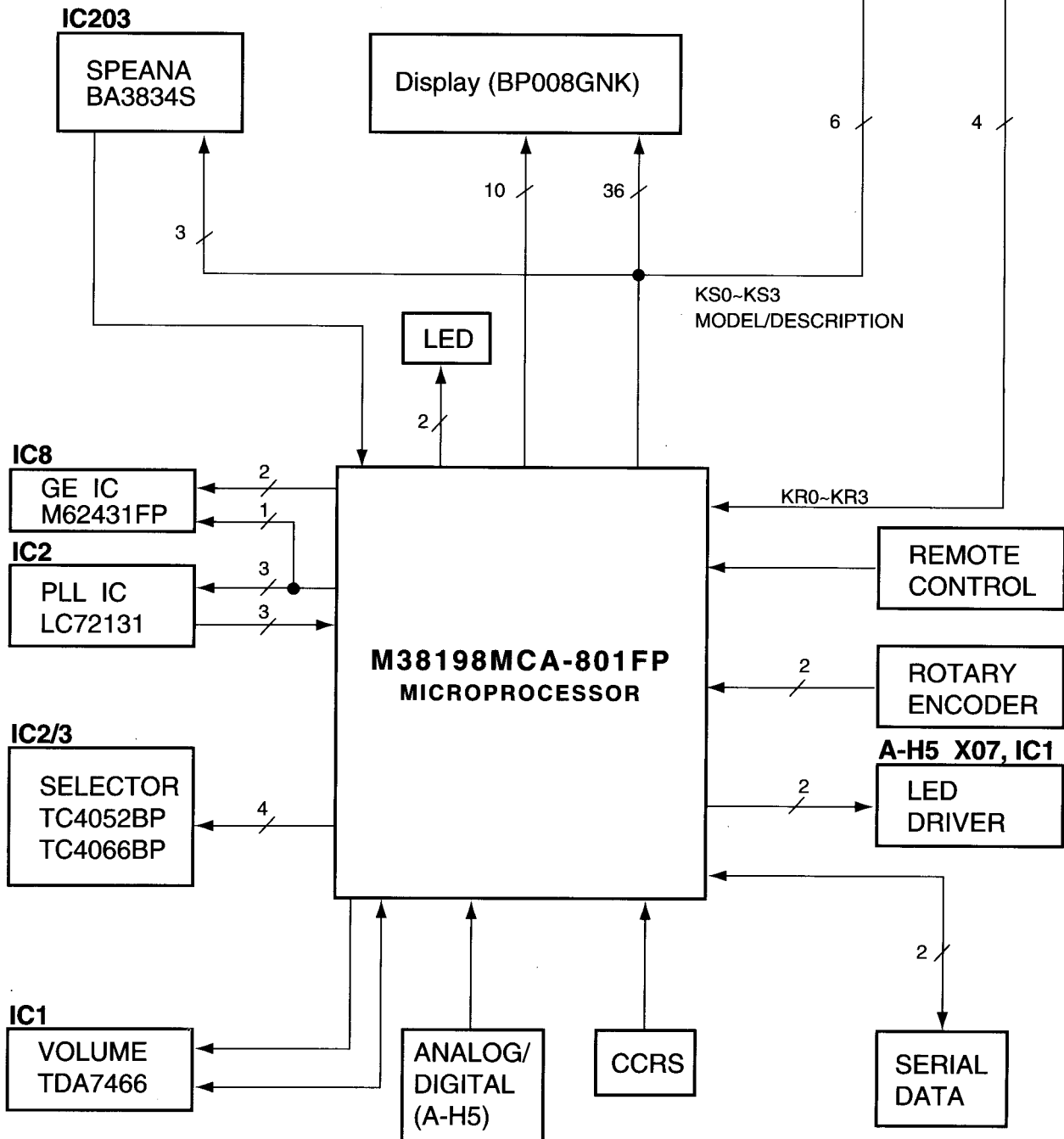

C-H5/H51/H5W/H6/H61/H6W/H7

CIRCUIT DESCRIPTION

5-2. Pin description

Pin No.	Pin Name	I/O	Description
1	EX.BASS LED	O	Led control for EXTRA BASS, H=ON
2	SRS 3D LED	O	Led control for SRS 3D, H=ON
3	SPEANA	I	Input port of spectrum analyzer data
4	GE ID CLK	O	Clock control of GE IC(C-H6/7 only)
5	GE ID St	O	Strobe control of GE IC(C-H6/7 only)
6	/PLL DO	I	Input port of IF count
7	/CE	O	Chip enable of PLL IC
8	CLK	O	Clock control of PLL IC
9	DT	O	Data control of PLL IC
10	/STEREO	O	Input port of tuner mode(stereo/mono)
11	/SD	O	Input port of tuner reception
12	S-LEVEL	I	Input port of RDS signal level (A/D input),(T,E,Q type only)
12	ECHO LEVEL	O	Level selector of echo IC, L:level-1,H:level-2(M,I,Y type only)
13	RDS-DATA	I	Input port of RDS data(E,T,Q type only)
13	ECHO /ON-OFF	O	On-off selector of echo IC, L:on, H:OFF(M,I,Y type only)
14	CCRS	I	Input port of CCRS level
15	SELF CHECK	I	Detection port of short test
16	AMP A/D	I	Key input port of amp section(A-H5)
17~20	SEL-1~4	O	Control port of selector IC
21	/PILOT	O	Selector port of PILOT-POLA, L:PILOT(Q type only)
22	/MUTE	O	Control port of mute
23	/P.CON	O	Control port of power
24	E-CLK	O	Clock control port of LED driver IC
25	IC2-SDATA	I/O	Data control port of electronics volume IC
26	IC2-SCLK	O	Clock control port of electronics volume IC
27	SBUSY	I/O	Control port of serial busy signal
28	SDATA	I/O	Control port of serial data signal
29	CCW	I	Input port of rotary encoder counter clockwise signal
30	RDS-SLK	I	Clock input port of RDS IC(E,T,Q type)
31	E-DT	O	Data control of LED driver IC
32	REM	I	Input port of remote control
33	CW	I	Input port of rotary encoder clockwise signal
34	/CE	I	Chip enable
35	/RESET	I	Input port of reset signal
36	XCIN	I	Input port of clock generator for watch
37	XCOU	O	Output port of clock generator for watch
38	XIN	I	Input port of clock generator for main circuit
39	XOUT	O	Output port of clock generator for main circuit
40	Vss	-	GND
41~44	KR3~0	I	Key return input port
45~54	DIGIT0~9	O	Digit output
55~60	DIGIT10~15	O	No use
61~87	SEGMENT0~26	O	Segment output
88	SEGMENT27	O	Tuner destination selector
89	SEGMENT 28	O	Model selector
90	SEGMENT29	O	Key scan output3
91	Vcc	-	Power supply
92~94	SEGMENT30~32	O	Key scan output2~0
95~97	SEGMENT33~35	O	Selector output port of spean IC
98	Vee	I	-30V power supply
99	Avss	I	Converter gnd of A/D and D/A
100	VREF	I	Standard voltage of A/D and D/A converter

C-H5/H51/H5W/H6/H61/H6W/H7

ADJUSTMENT

FM SECTION INPUT SELECTOR : FM MODE

X05-4650

NO.	ITEM	INPUT SETTINGS	OUTPUT SETTINGS	TUNER SETTINGS	ALIGNMENT POINTS	ALIGN FOR	FIG.
1	DISCRIMINATOR	(A) 98 MHz, 60dB μ (ANT INPUT) 1 kHz, ± 40 kHz DEV : E/T/Q TYPE 1 kHz, ± 75 kHz DEV (OTHER TYPE)	Connect a DC voltmeter between pin 1 and pin2 of CN2.	MONO 98.0 MHz	L31	0V	(a)
					L32 (EXCEPT K/P)	Minimum distortion.	
2	DISTORTION (STEREO)	(A) 98 MHz, 60dB μ (ANT INPUT) 1 kHz, ± 40 kHz DEV : E/T/Q TYPE 1 kHz, ± 67.5 kHz DEV PILOT ± 7.5 kHz DEV OTHER TYPE	(B)	AUTO 98.0 MHz	T 1 (A1)	Minimum distortion.	(a)

X05-4660

NO.	ITEM	INPUT SETTINGS	OUTPUT SETTINGS	TUNER SETTINGS	ALIGNMENT POINTS	ALIGN FOR	FIG.
1	DISTORTION (STEREO)	(A) 98 MHz, 60dB μ (ANT INPUT) 1 kHz, ± 67.5 kHz DEV PILOT: ± 7.5 kHz DEV	(B)	AUTO 98.0 MHz	T1 (A1)	Minimum distortion.	

POLAR UNIT

X04-1313-xx Q TYPE (65MHz~74MHz BAND)

NO.	ITEM	INPUT SETTINGS	OUTPUT SETTINGS	TUNER SETTINGS	ALIGNMENT POINTS	ALIGN FOR	FIG.
1	VCO	(C) 69 MHz, 60 dB μ (ANT INPUT) 1 kHz, 0 kHz DEV SUB, 0 kHz DEV	Connect a frequency counter to VCO monitor (CN2).	AUTO 69 MHz	VR 2	Adjust it the frequency counter reads 31.25 kHz ± 100 kHz.	
2	SEPARATION	(C) 69 MHz, 60 dB μ (ANT INPUT) 1 kHz, 40 kHz DEV SUB, 10 kHz DEV Select : L or R	Connect a oscilloscope to TUNER OUT(CN6).	AUTO 69 MHz	TC 1	Minimum crosstalk.	
3	SEPARATION	(C) SAME AS ABOVE	Connect a oscilloscope to TUNER OUT(CN6).	AUTO 69 MHz	VR 1	Minimum crosstalk.	

INSTRUMENT CONNECTION

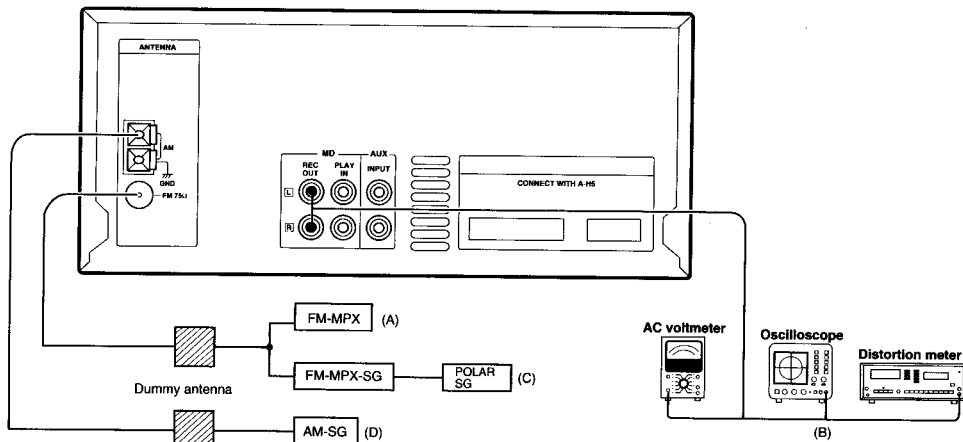

ANTENNA

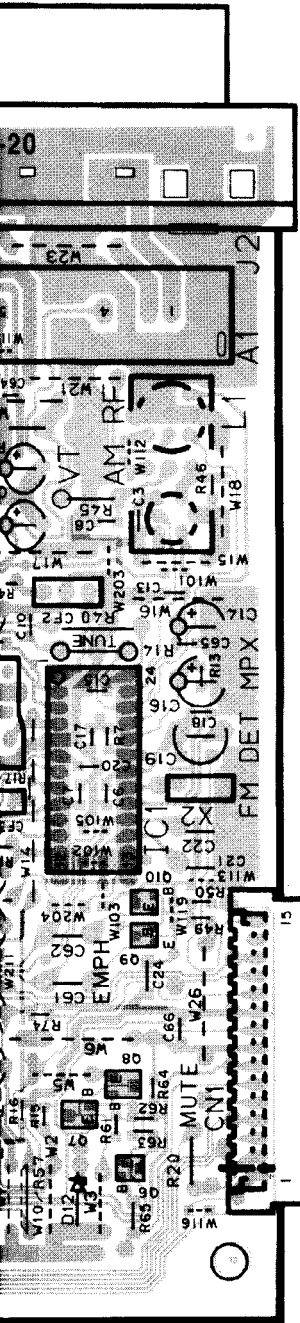

ANTENNA

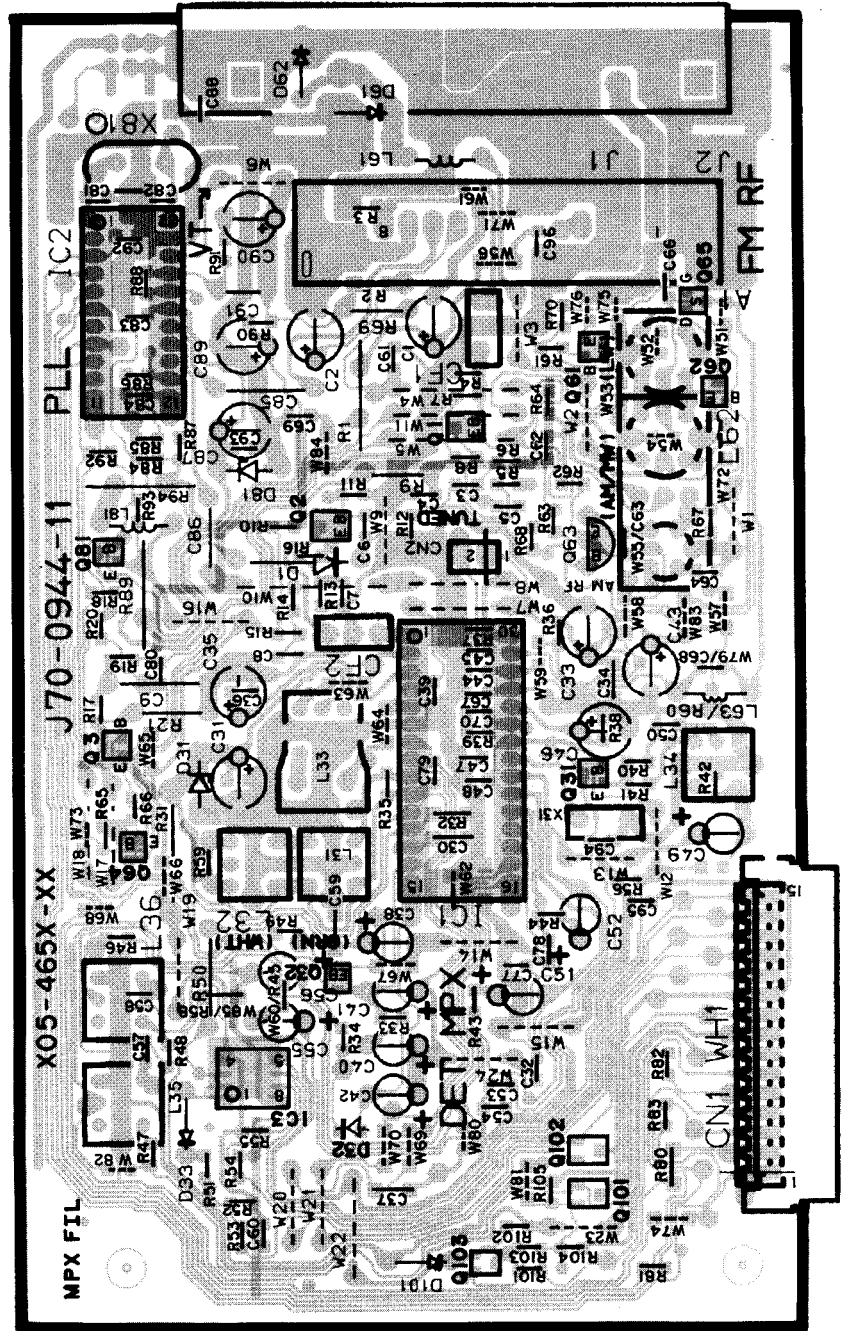

RD(Component side view)

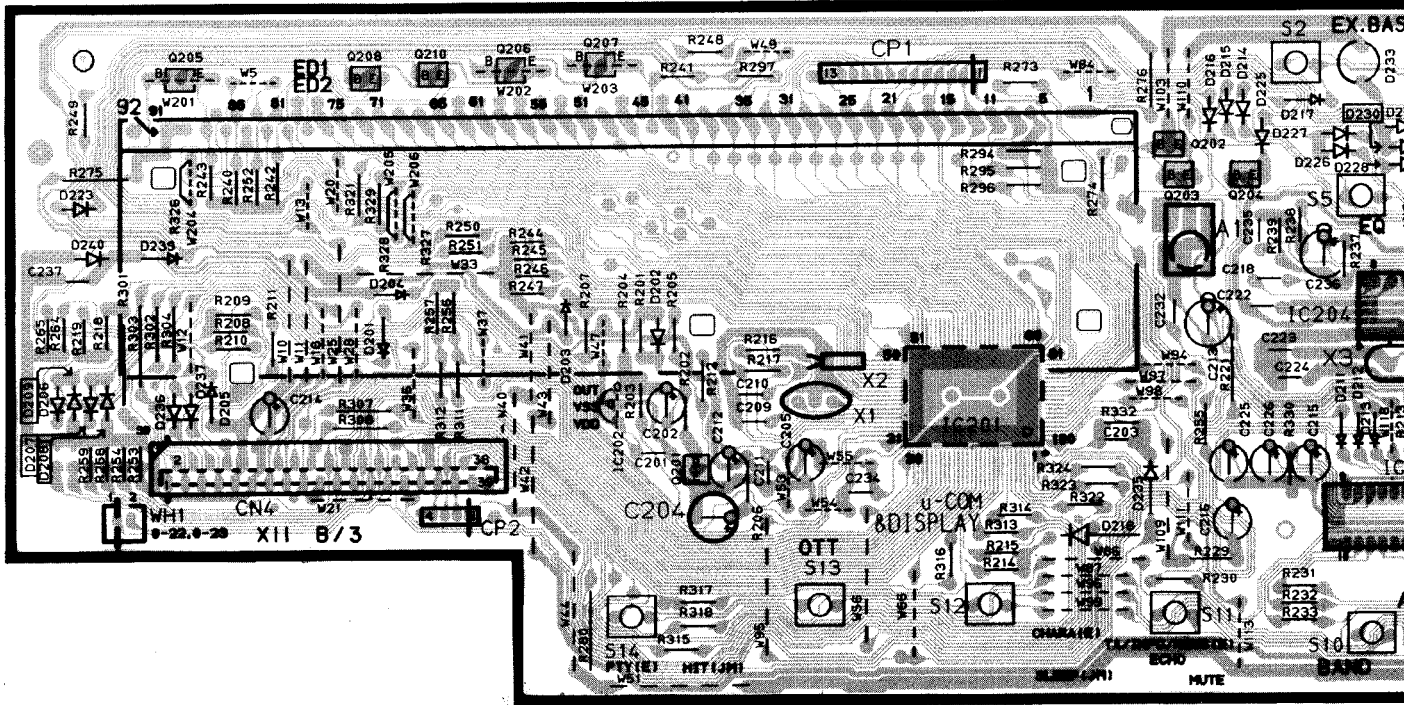
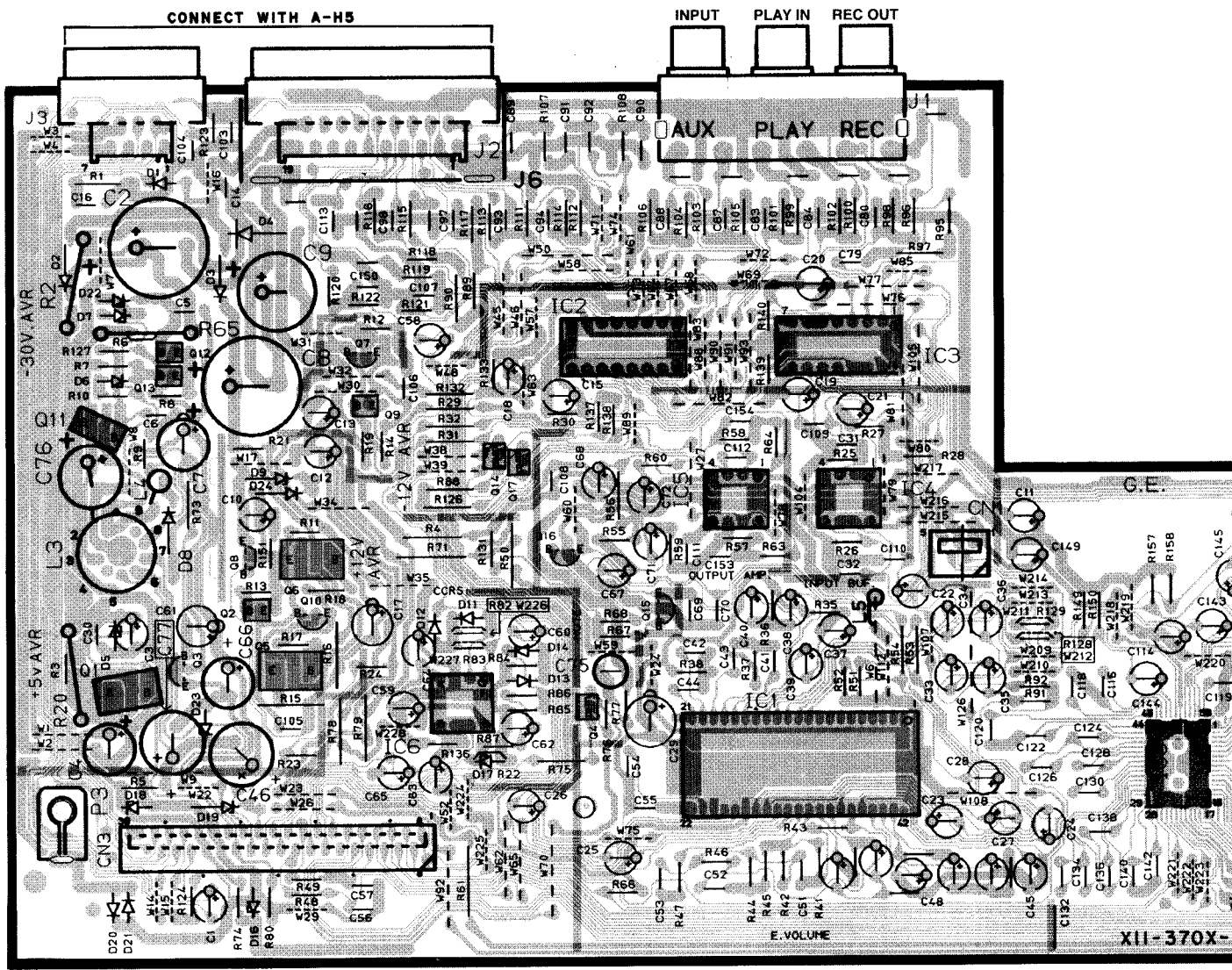

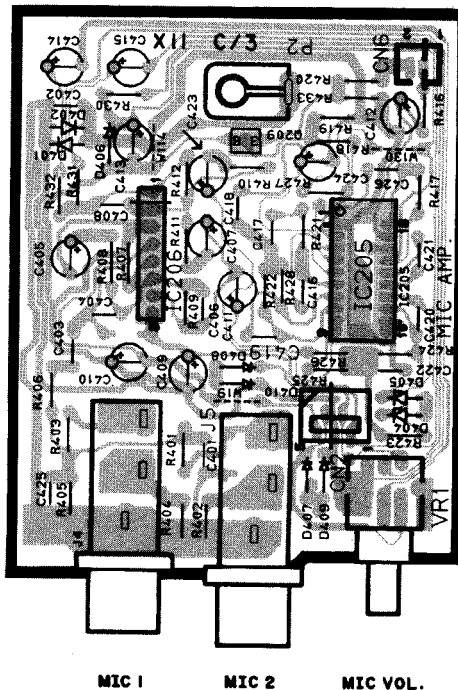
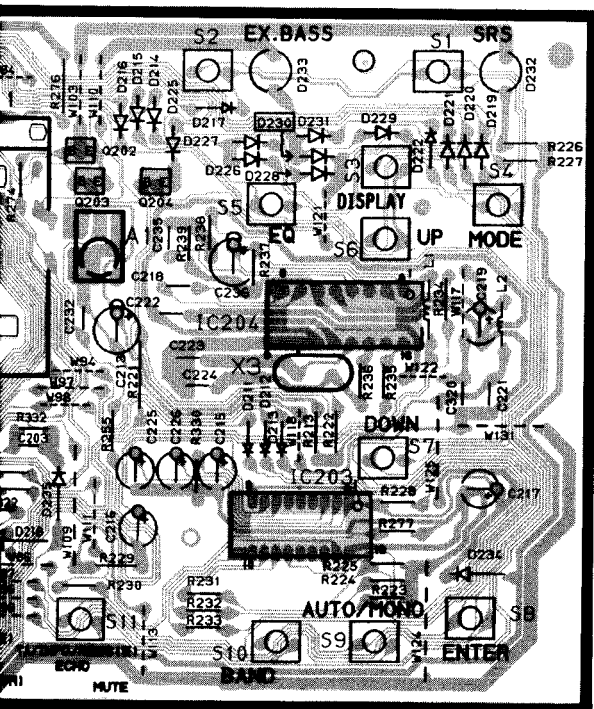
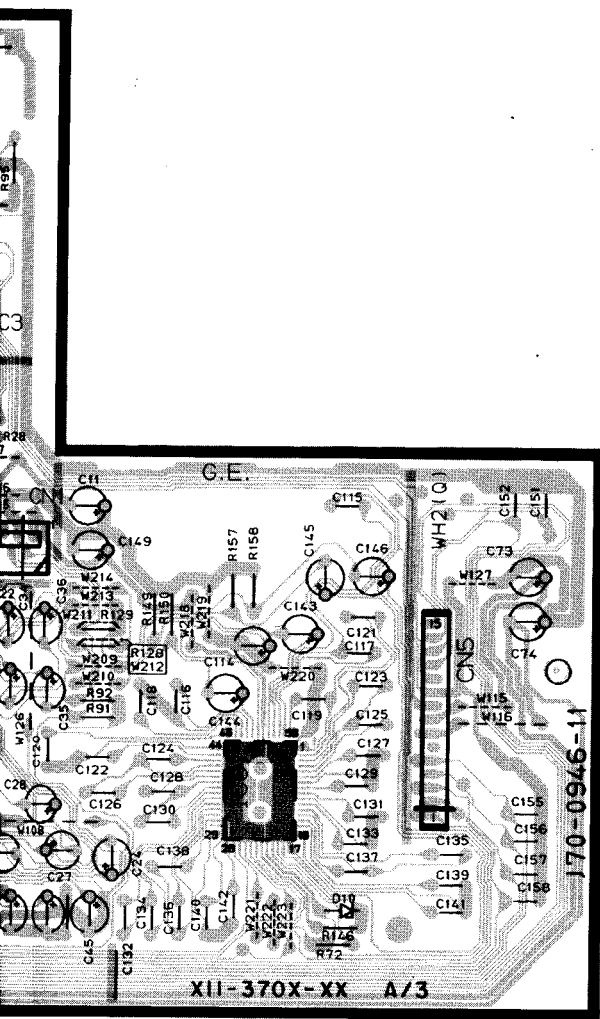

(X05-466X-XX) M,I,Y,K TYPE

The DC voltage is an actual reading measured with a high impedance type voltmeter as the AM/FM signal generator is specified to the conditions as shown in the list below. The measurement value may vary depending on the measuring instruments used or on the product. The value shown in () is actual reading measured in the AM mode.

MODE	CARRIER	MODULATION		ANT INPUT
		FREQUENCY	DEVIATION	
FM	98MHz	1kHz	STEREO 67.5kHz 7.5kHz(Pilot)	60dB
AM	1000(999)kHz	400Hz	MONO 30% MOD	60dB

FM 300
GND
AM ANT

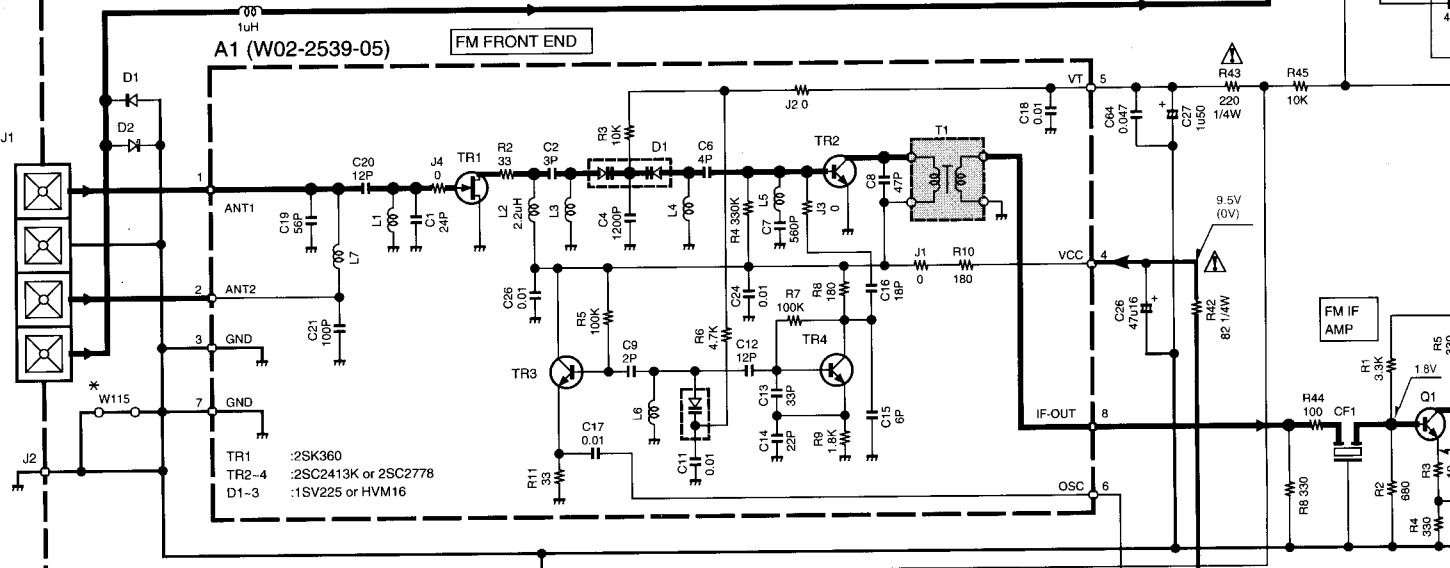

- TR1 :2SK360
- TR2-4 :2SC2413K or 2SC2778
- D1-3 :1SV225 or HVM16

BAND	FREQ	VT
FM	LF	2.1V
	HF	7.2V
AM	LF	1.2V
	HF	4.8V

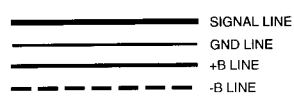

- IC1 : LA1832
- IC2 : LC72131
- IC4 : NJM4565M
- Q1 : 2SC2714(R,O)
- Q3 : 2SB1218A(Q,R) or 2SA1576A(R,S)
- Q5,9,10 : 2SD1819A(Q,R) or 2SC4081(R,S)
- D1,2,8 : 1SS133 or HSS104
- D3,4 : MTZJ5.1(B) or UZ-5.1BSB
- D10 : MA111

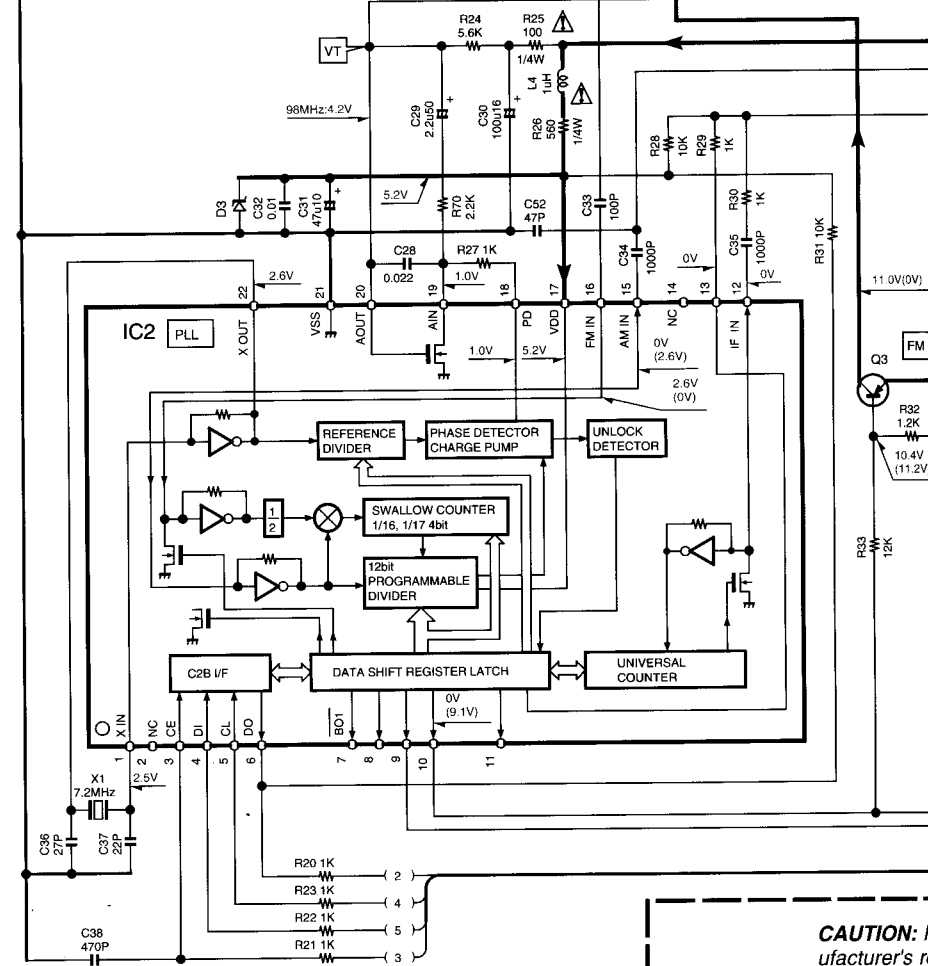

CAUTION: For components. For and rating fus tance measur from the supp

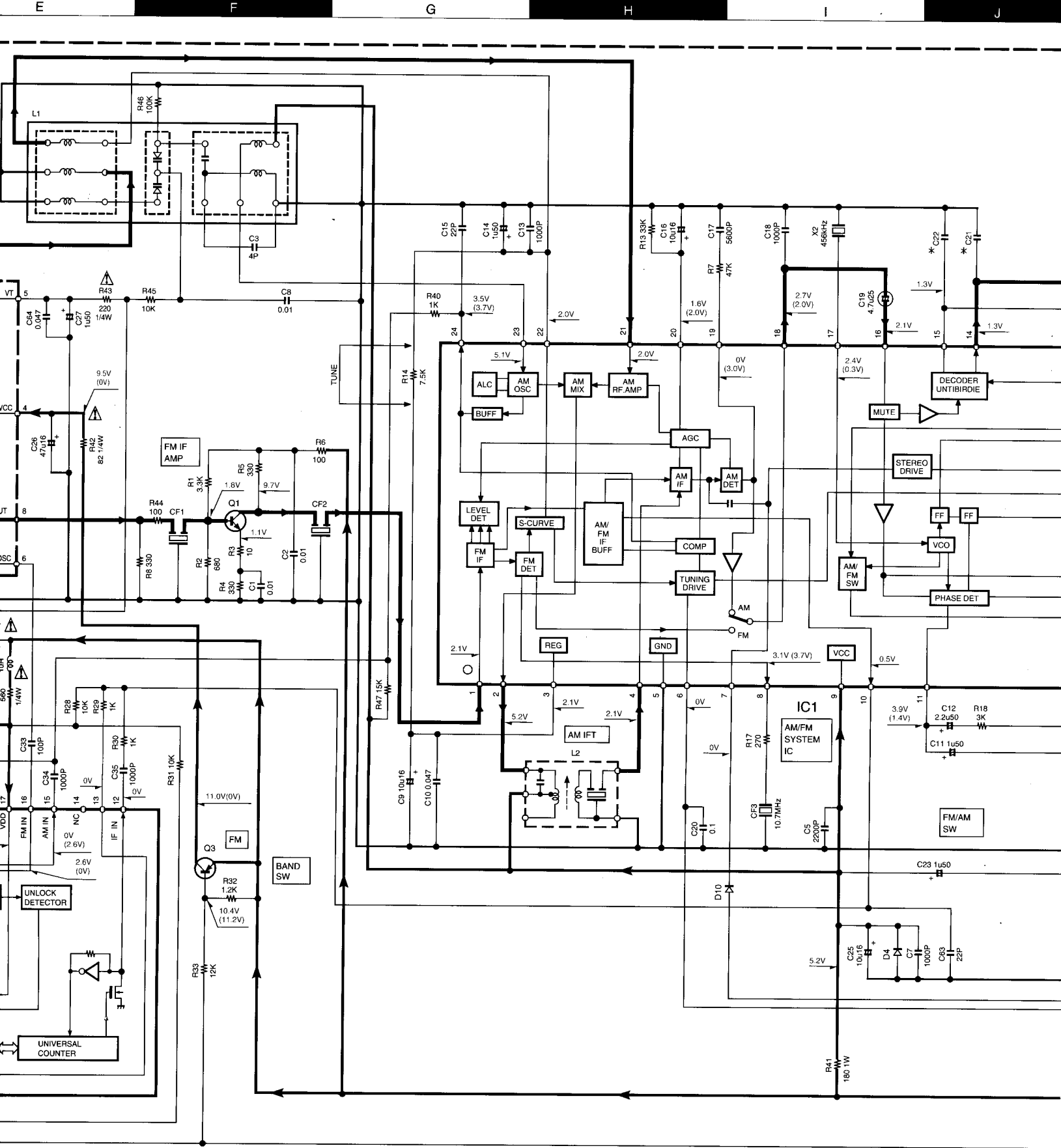

CAUTION: For continued safety, replace safety critical components only with manufacturer's recommended parts (refer to parts list). Δ indicates safety critical components. For continued protection against risk of fire, replace only with same type and rating fuse(s). To reduce the risk of electric shock, leakage-current or resistance measurements shall be carried out (exposed parts are acceptably insulated from the supply circuit) before the appliance is returned to the customer.

C-H7 (X05-466X-XX)

DESTINATION	UNIT No.	(A)	C21.	W115	
COUNTRY	ABB.		22		
U.S.A.	K	0-12	NO	0.016	NO
GENERAL MARKET	M	0-21	YES	0.011	YES

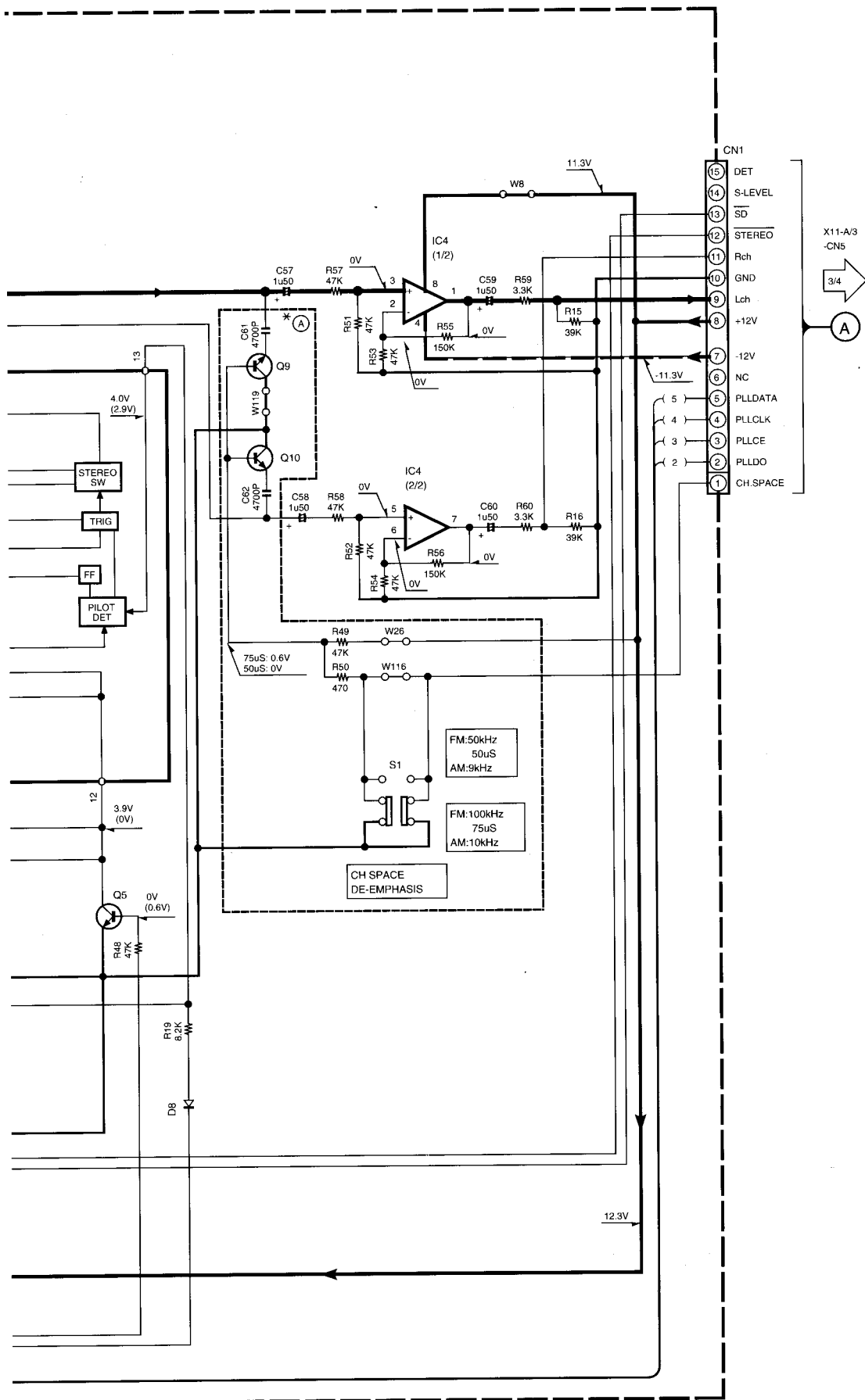

C-H61/H51 (X05-466X-XX)

C-H7/H61/H51(M) (1/4)

DESTINATION		UNIT No.	A	C21, 22	W115
COUNTRY	ABB				
PX	Y	0-21	YES	0.011	YES
GENERAL MARKET	M				
MALAYSIA	I				

C-H5/H51/H5W/H6/H61/H6W/H7

Y08-5602-70

KENWOOD

(X05-465X-XX) : T,E,Q TYPE

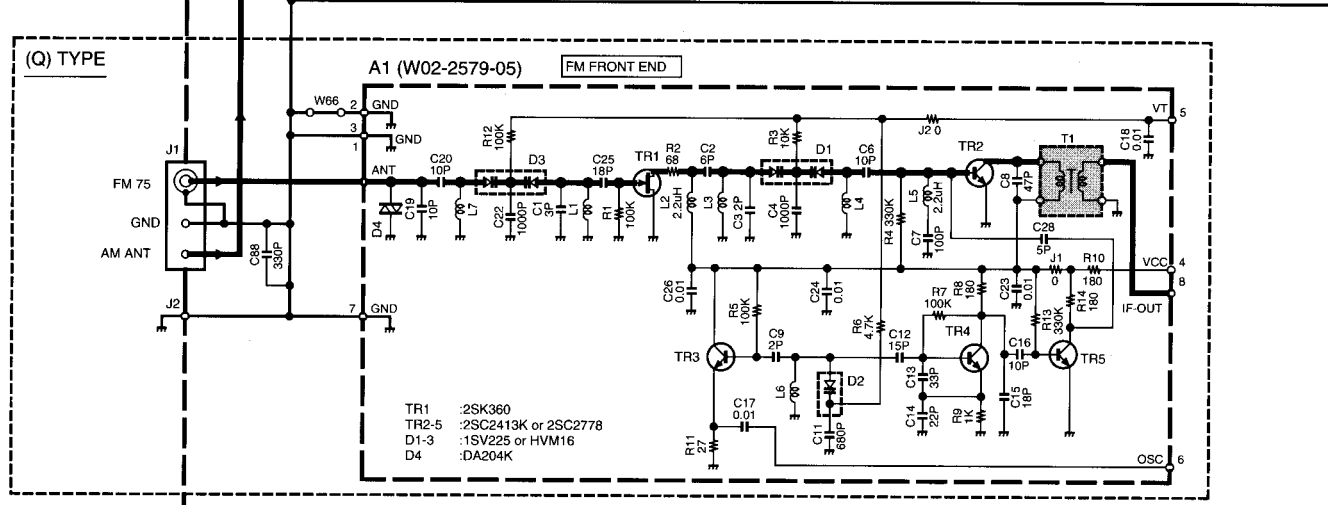
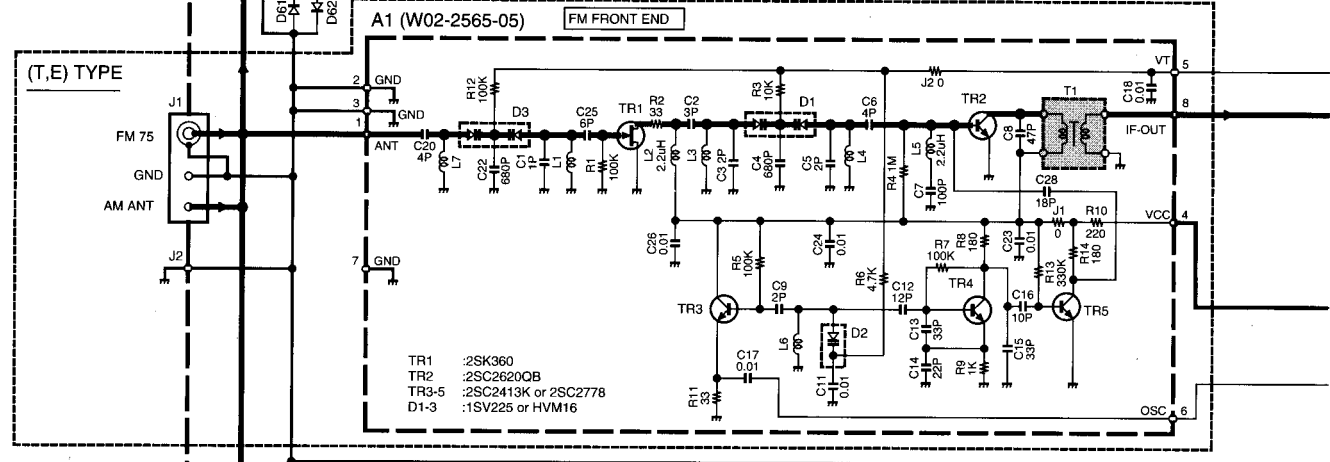
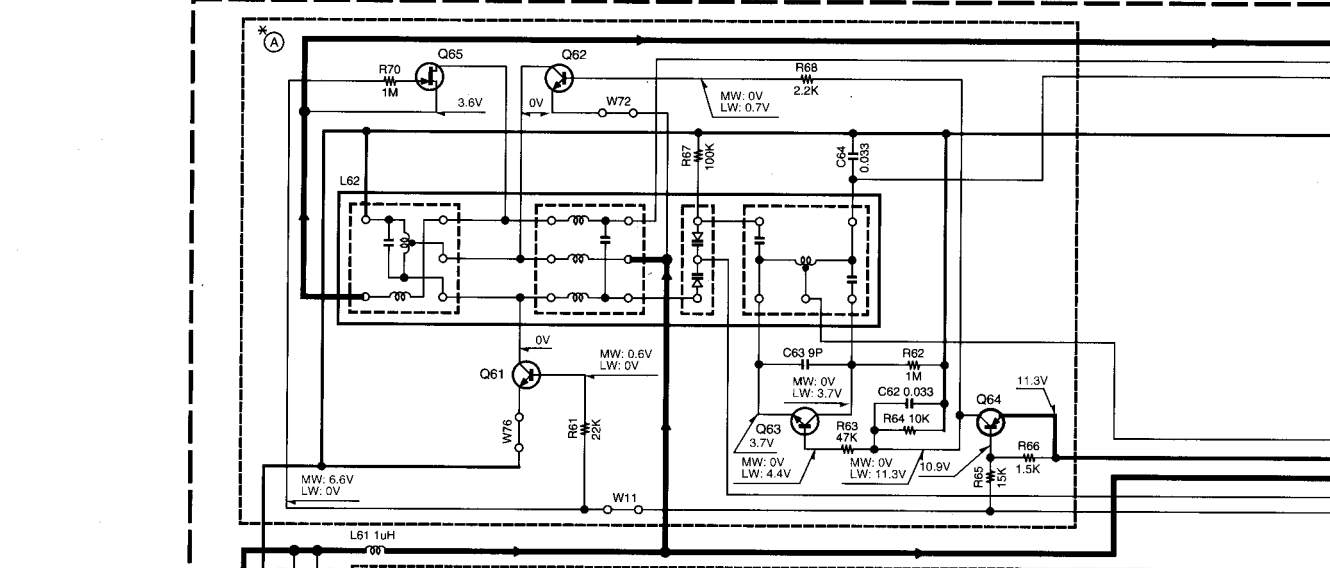

- IC1 : LA1836
- IC2 : LC72131
- IC3 : NJM2904M
- Q1,2 : 2SC2714(R,O)
- Q3,81,64 : 2SA1576A(R,S) or 2SB1218A(Q,R)
- Q31,32,61,62 : 2SC4081(R,S) or 2SD1819A(Q,R)
- Q63 : 2SC2878(B)
- Q65 : 2SK302(Y,GR)
- D1,33,61,62 : 1SS133 or HSS104
- D31 : MTZJ8.2(B) or UZ-8.2BSS
- D32 : MA1111
- D81 : MTZJ5.1(B) or UZ-5.1BSS

VT VOLTAGE

BAND	FREQ	VT
FM	LF	2.3V (0.8V)
	HF	7.7V
AM	LF	1.2V
(MW)	HF	4.6V

() Q TYPE

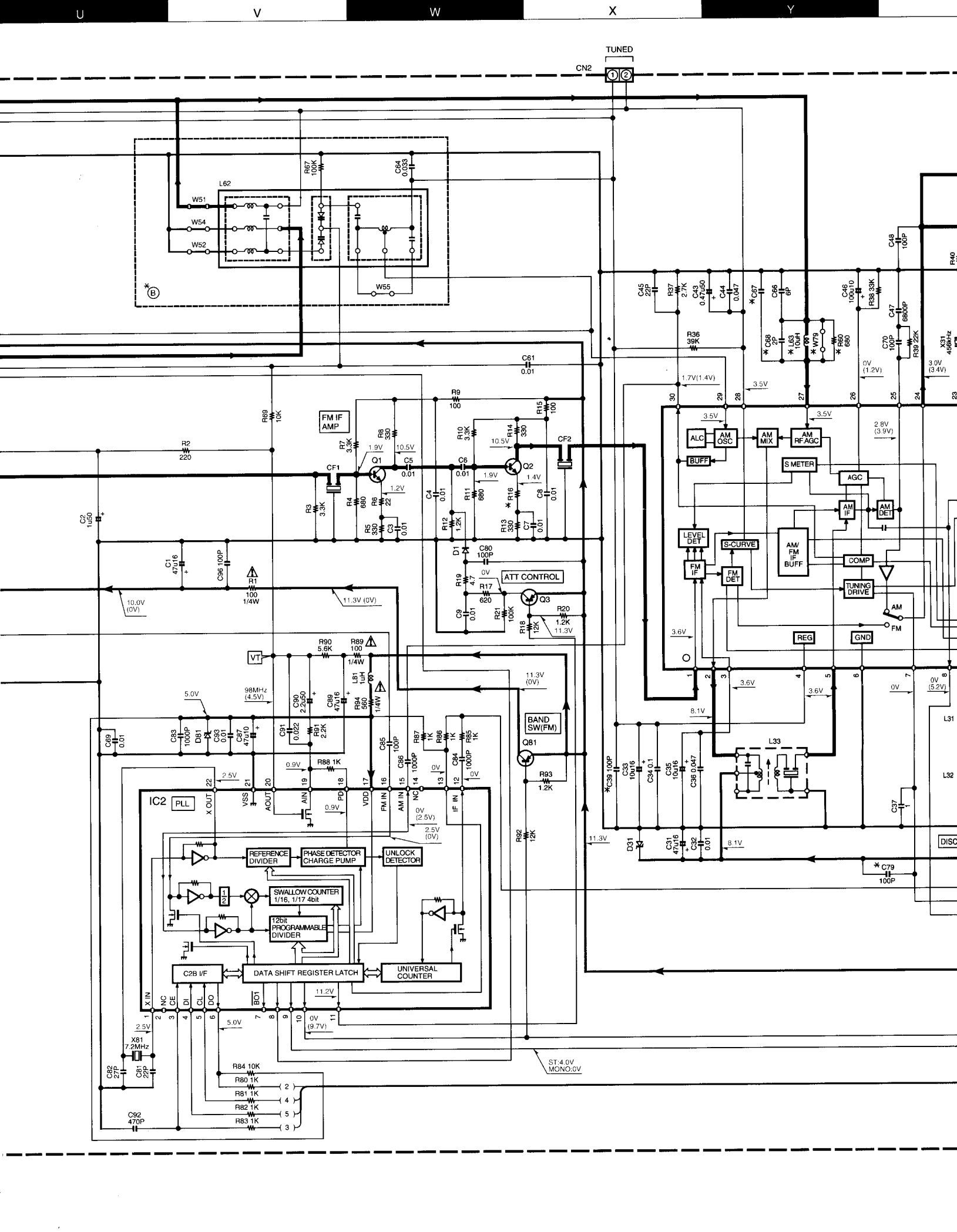

TUNED

CN2

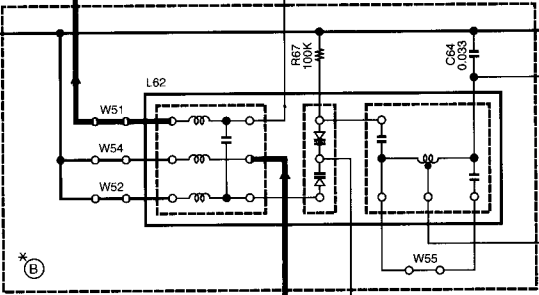

(B)

FM IF AMP

ATT CONTROL

IC2 PLL

BAND SW(FM)

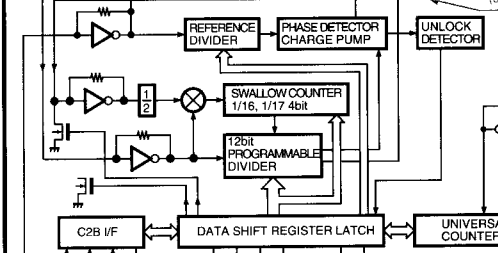

ST-4.0V MONO.0V

DISC

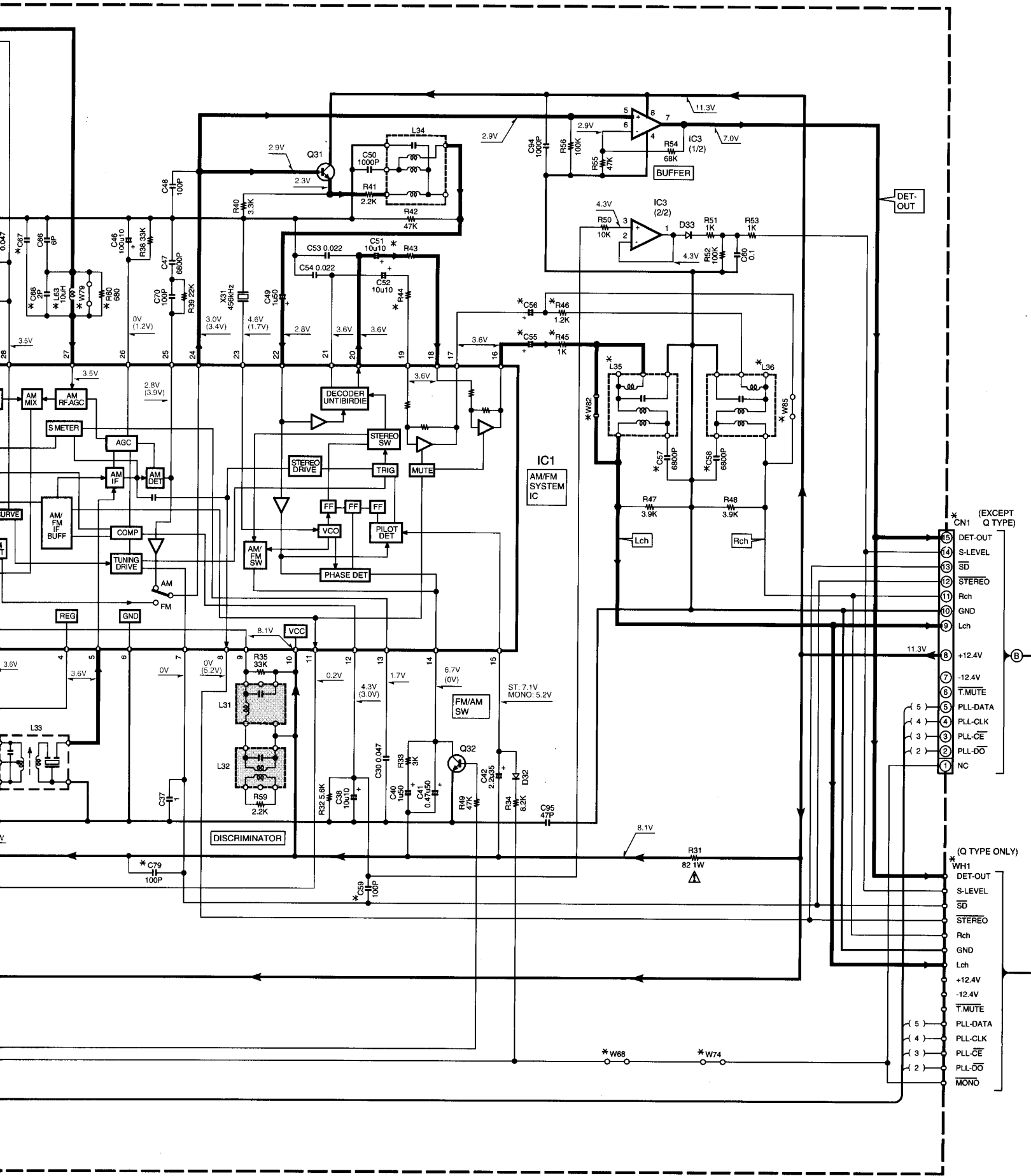

- * CN1 (EXCEPT Q TYPE)
- 15 DET-OUT
- 14 S-LEVEL
- 13 SD
- 12 STEREO
- 11 Rch
- 10 GND
- 9 Lch
- 8 +12.4V
- 7 -12.4V
- 6 T.MUTE
- 5 PLL-DATA
- 4 PLL-CLK
- 3 PLL-CE
- 2 PLL-DO
- 1 NC

- * (Q TYPE ONLY)
- WH1 DET-OUT
- S-LEVEL
- SD
- STEREO
- Rch
- GND
- Lch
- +12.4V
- 12.4V
- T.MUTE
- PLL-DATA
- PLL-CLK
- PLL-CE
- PLL-DO
- MONO

**POLAR UNIT
(X04-1313-81) (Q)TYPE ONLY**

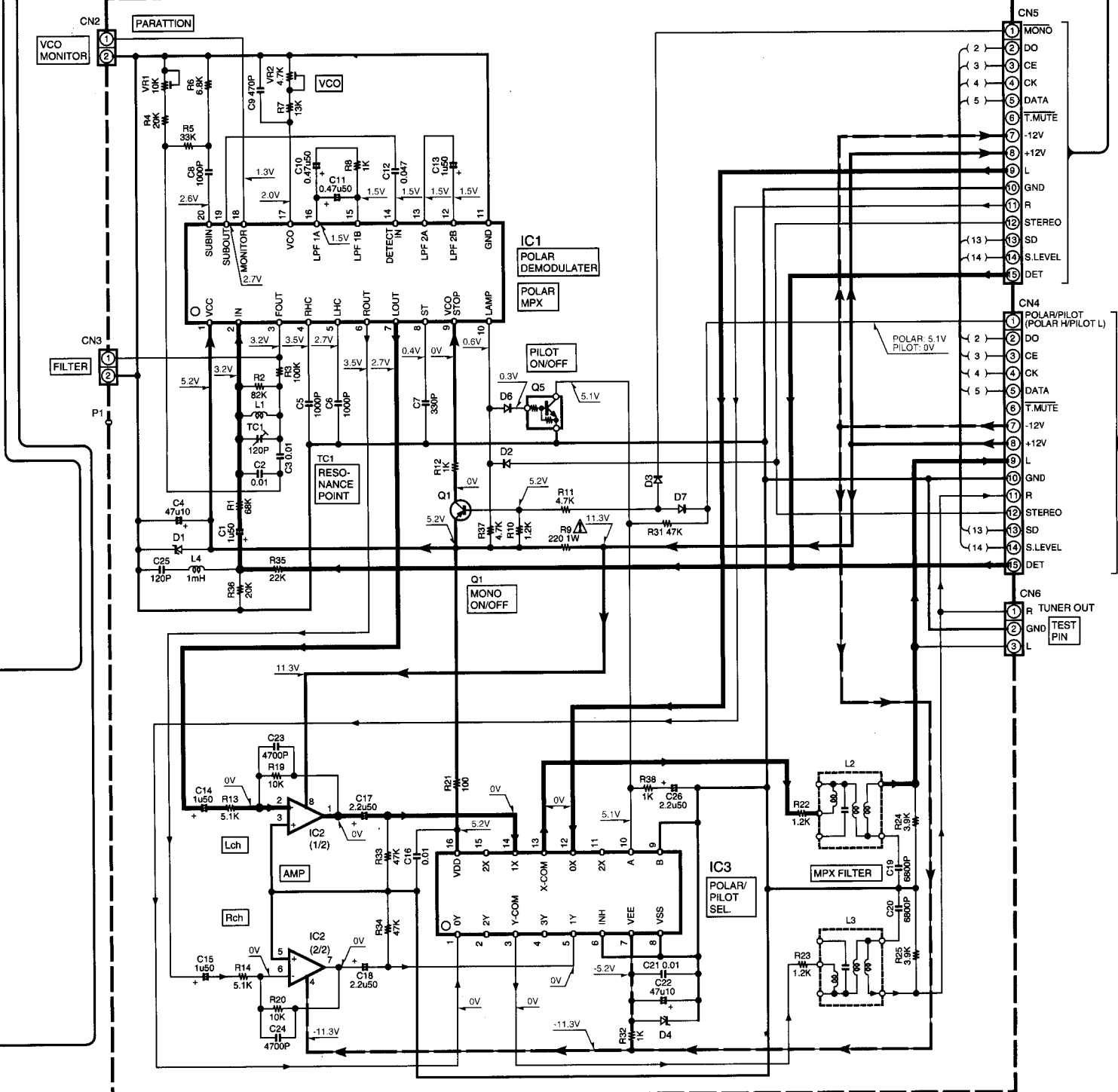

- (X04-)
 IC1 : IR3R42
 IC2 : NJM4565D
 IC3 : TC4052BP
- Q1 : 2SA933AS(Q,R) or 2SA1175(F,E)
 Q5 : DTC124ESA or UN4212
- D1,4 : MTZJ5.1(B) or UZ-5.1BSB
 D2,3,6,7 : 1SS133 or HSS104
 D5 : MTZJ3.3(B) or UZ-3.3BSB

C-H7/H6/H5 (X05-465X-XX)

DESTINATION	UNIT No.	(A)	(B)	C39	C55	C57	C67	C68	C79	R16	R43	R45	R60	W68,74, 79,82,85	CN1	WH1	L35	L63	J2	
U.K.	T	0-82	YES	NO	NO	2.2u35	YES	33P	NO	NO	33	3.3K	YES	NO	NO	NO	NO	NO	NO	F10-1053
EUROPE	E	2-71	NO	YES	NO	NO	NO	22P	YES	NO	47	2.4K	W60	NO	YES	NO	NO	NO	NO	F10-1068

C-H6/W/H5W (X05-465X-XX)

DESTINATION	UNIT No.	(A)	(B)	C39	C55	C57	C67	C68	C79	R16	R43	R45	R46	W68,74, 79,82,85	CN1	WH1	L35	L63	J2	
RUSSIA	Q	3-82	YES	NO	YES	3.3u25	NO	22P	NO	YES	47	2.4K	W60	NO	YES	NO	NO	NO	NO	F10-1068

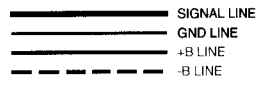

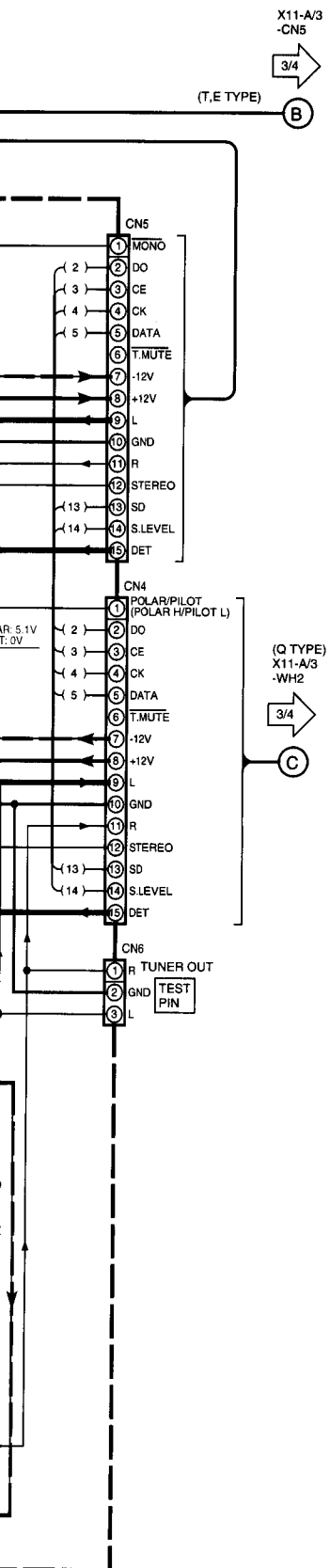

2SA1534A2
SA954
2SC1845
2SC2878
2SC3940A

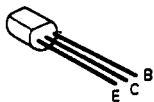

2SA11752
SC2785

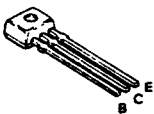

DTC124ESA2
SC1740S

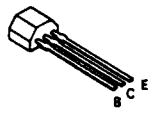

2SB1218A
2SC2714
2SC4081
2SD1819A



2SD2061



UN4212
UN4219

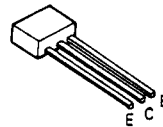

2SD2012



2SB1168



NJM4565D

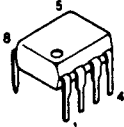

BA15218-DX

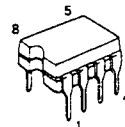

BU4066BCTC
4066BP

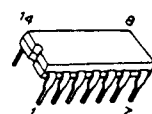

TC4052BP

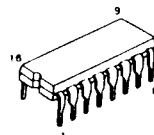

SAA6579

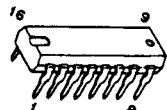

NJM4580D-D

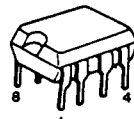

TDA7466

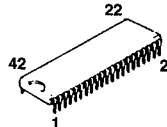

NJM2904M
NJM4565M

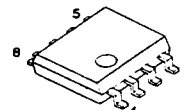

2SK302



LA1836

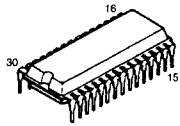

LC72131

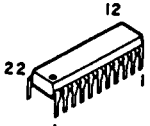

NJM4565L-D

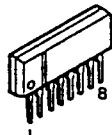

LA1832



M62431FP

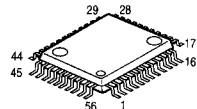

BA3834S
BU9253AS

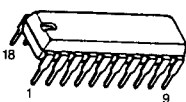

CAUTION: For continued safety, replace safety critical components only with manufacturer's recommended parts (refer to parts list). Δ indicates safety critical components. For continued protection against risk of fire, replace only with same type and rating fuse(s). To reduce the risk of electric shock, leakage-current or resistance measurements shall be carried out (exposed parts are acceptably insulated from the supply circuit) before the appliance is returned to the customer.

The DC voltage is an actual reading measured with a high impedance type voltmeter as the AM/FM signal generator is specified to the conditions as shown in the list below. The measurement value may vary depending on the measuring instruments used or on the product. The value shown in () is actual reading measured in the AM mode.

MODE	CARRIER	MODULATION		ANT INPUT
		FREQUENCY	DEVIATION	
FM	98MHz	1kHz	STEREO 67.5kHz 7.5kHz(Pilot)	60dB
AM	1000(999)kHz	400Hz	MONO 30% MOD	60dB

J2
10-1053
SIGNAL LINE
GND LINE
+B LINE
-B LINE

J2
10-1088
C-H5/H5W/H6H6W/H7(E) (2/4)

C-H5/H51/H5W/H6/H61/H6W/H7

Y08-5602-70

KENWOOD

- (M,Y,K) TYPE X05-CN1
1/4
A
- (T,E) TYPE X05-CN1
2/4
B
- (Q) TYPE X04-CN4
2/4
C

(X11-370X-XX) (A/3)

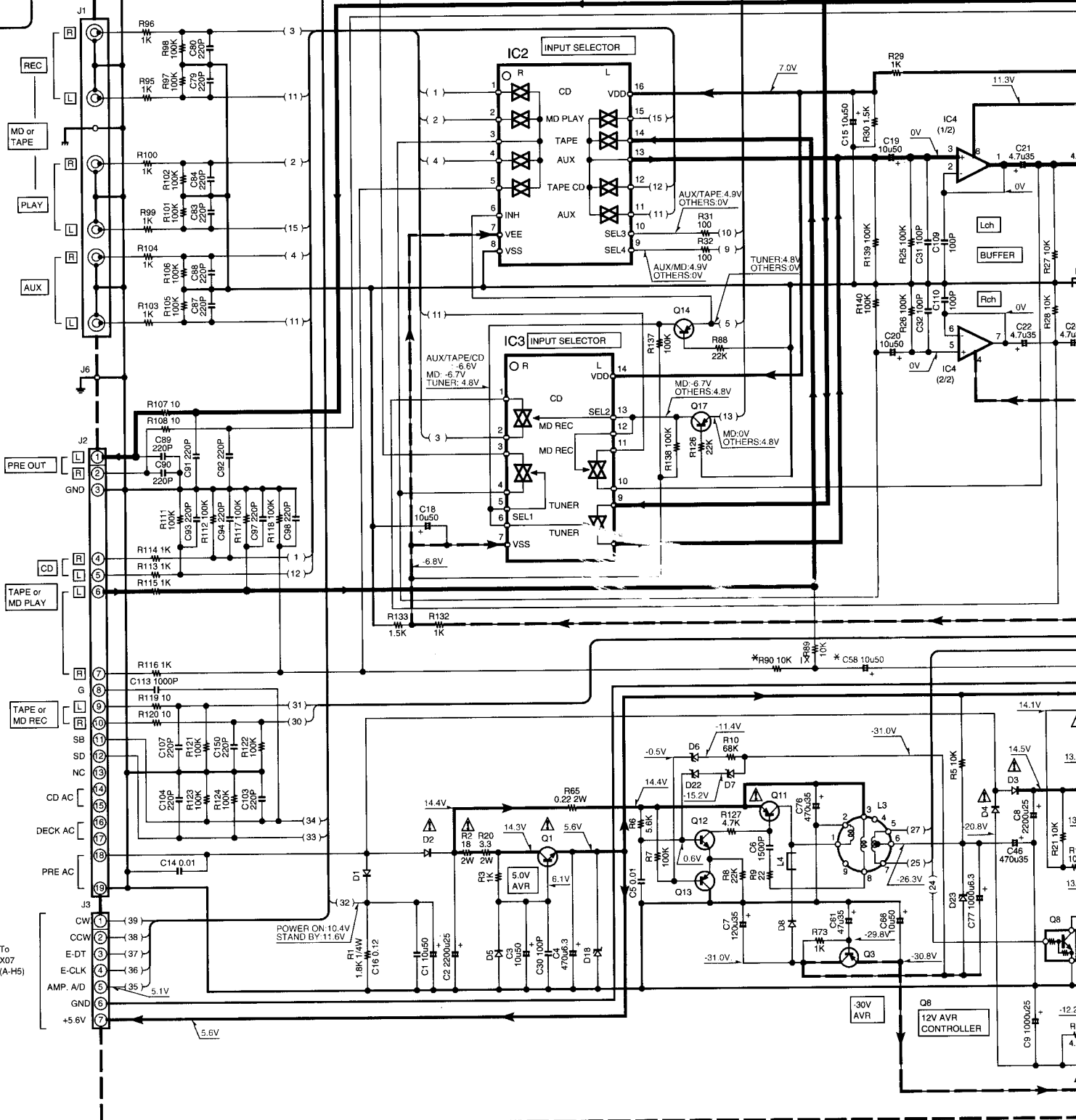

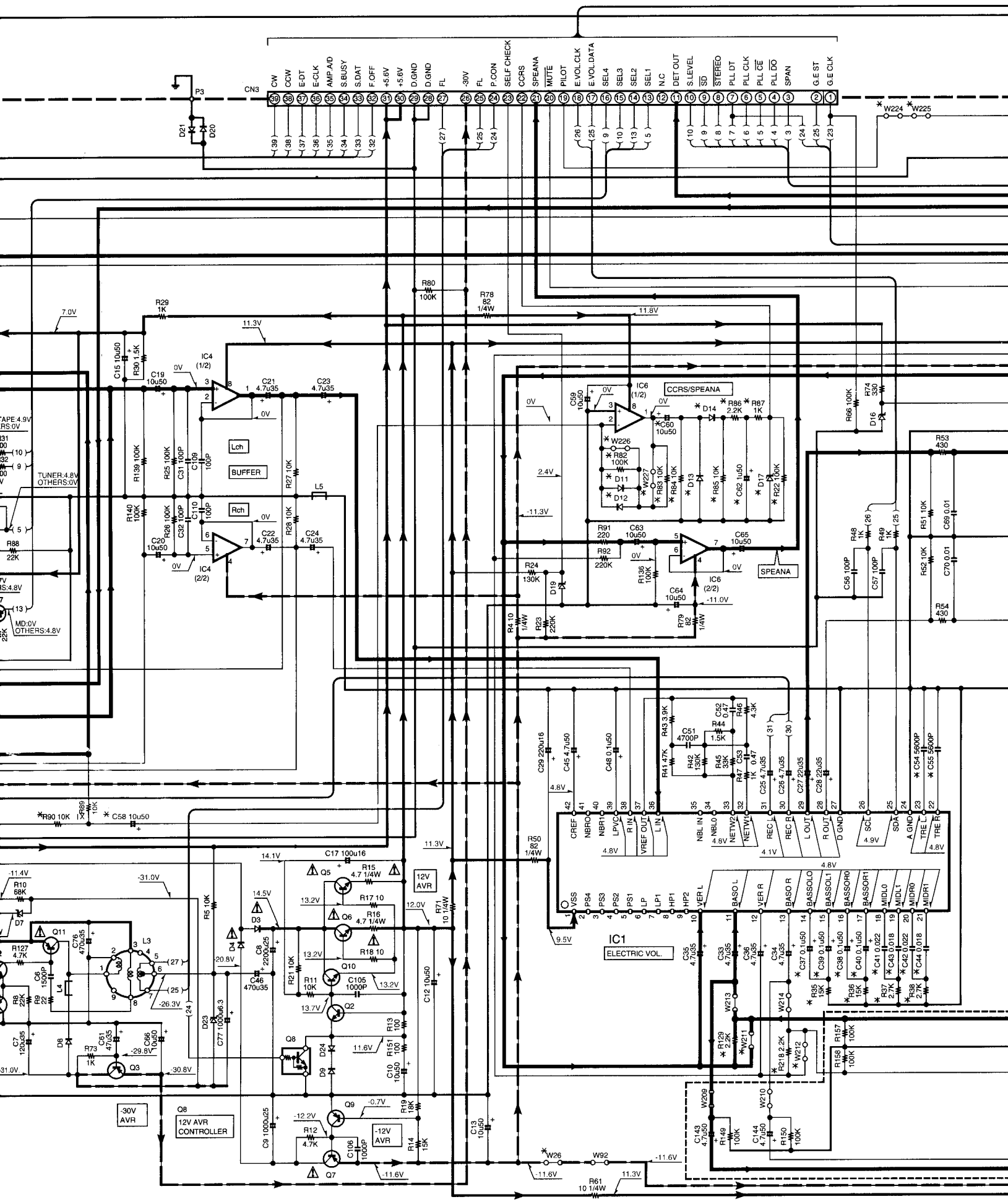

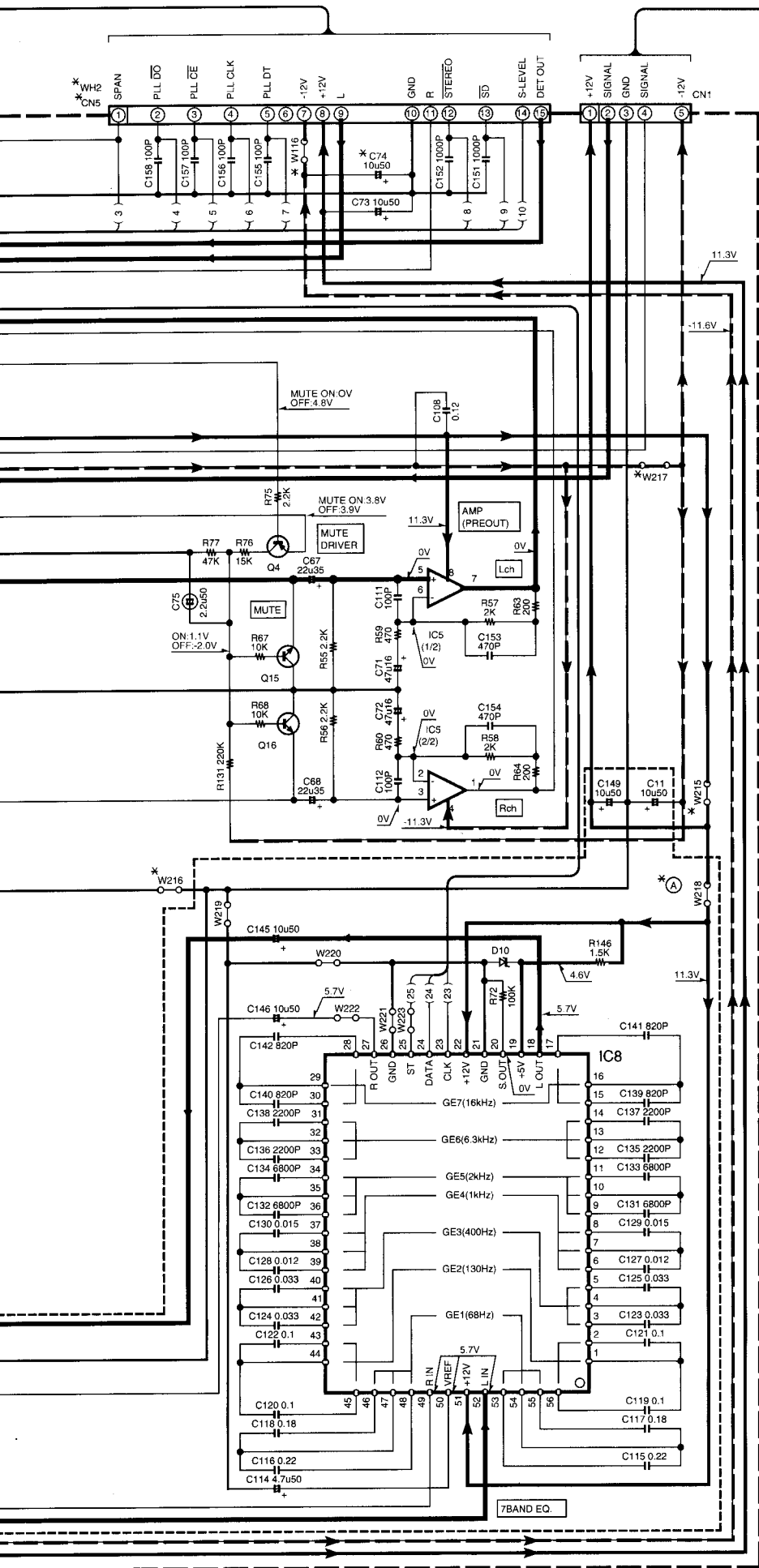

(X11-) (C/3)

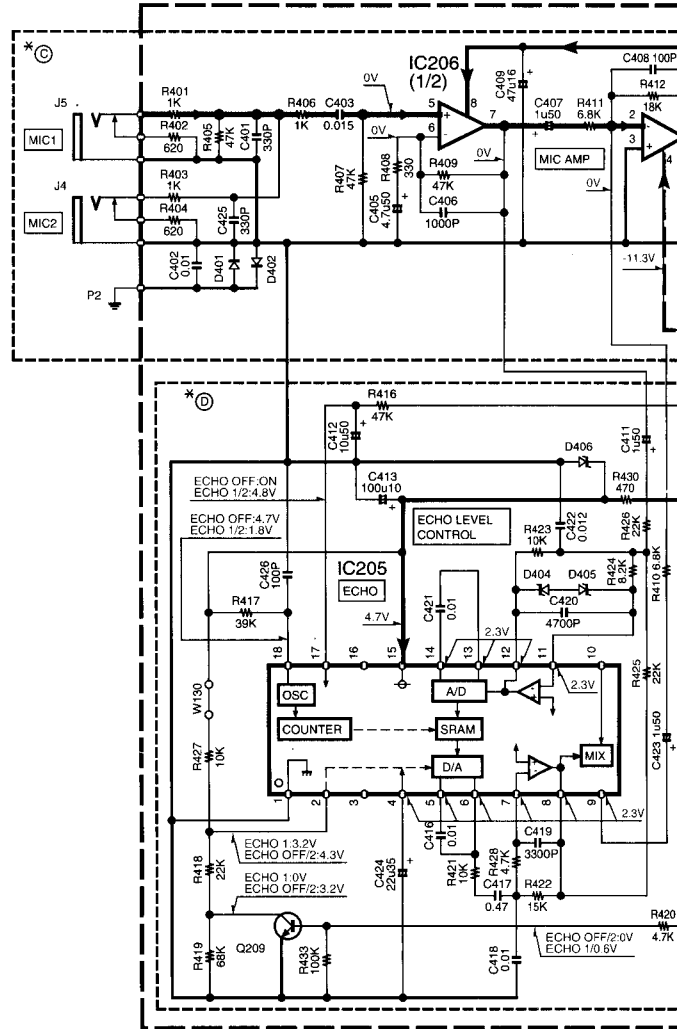

- IC1 : TDA7466
- IC2 : BU4052BC or TC4052BP
- IC3 : BU4066BC or TC4066BP
- IC4,5 : NJM4580D-D
- IC6 : BA15218-DX
- IC8 : M62431FP
- IC205 : BU9253AS
- IC206 : NJM4565L-D
- Q1 : 2SD2012 or 2SD2061
- Q2,12 : 2SC1740S(Q,R) or 2SC2785(F,E)
- Q3 : 2SA954(L,K)
- Q4,9,13,14,17 : 2SA933AS(Q,R) or 2SA1175(F,E) or 2SA1048(Y,GR) or 2SA1309(Q,R)
- Q5,6 : 2SD2525 or 2SD2137(P)
- Q7 : 2SA1534A(R,S)
- Q8 : DTC113ZSA or UN4219
- Q10 : 2SC3940A(R,S)
- Q11 : 2SB1168(S,T)
- Q15,16 : 2SC1845(F,E)
- D1,11-14,20,21,24,401,402 : 1SS131 or HSS104A
- D2-4 : S5888B or 1SR139-400
- D5,18 : MTZJ6.2(B) or UZ-6.2BSB
- D6,9 : MTZJ11(B) or UZ-11BSB
- D7,22 : MTZJ16(B) or UZ-16BSB
- D8 : D1N120U
- D10,17,19,23,406 : MTZJ4.7(B) or UZ-4.7BSB
- D16,407-410 : MTZJ3.9(B) or UZ-3.9BSB
- D404,405 : MTZJ2.0(B) or UZ-2.0BSB

CH-7 (X11-370X-XX)

DESTINATION	COUNTRY	ABB	UNIT NO.	(A)	(C)	(D)	W21
EUROPE	E	2-71	0-51	YES	NO	NO	
U.K.							
GENERAL MARKET	M	K	0-21	YES	NO	NO	
U.S.A.							

C-H6 (X11-370X-XX)

DESTINATION	COUNTRY	ABB	UNIT NO.	(A)	(C)	(D)	W26, 214,
EUROPE	E	2-71	0-51	YES	NO	NO	
U.K.	T	0-52					

C-H6W (X11-370X-XX)

DESTINATION	COUNTRY	ABB	UNIT NO.	(A)	(C)	(D)	W26, 214,
PX			0-22	YES	NO	NO	
RUSSIA	R	3-81					
MALAYSIA	I						

C-H61 (X11-370X-XX)

DESTINATION	COUNTRY	ABB	UNIT NO.	(A)	(C)	(D)	W26, 214,
PX			0-22	YES	NO	NO	
RUSSIA	R	3-82					

C-H5 (X11-370X-XX)

DESTINATION	COUNTRY	ABB	UNIT NO.	(A)	(C)	(D)	W26, 214,
EUROPE	E	2-73	0-53	YES	NO	NO	
U.K.	T	0-53					

C-H5W (X11-370X-XX)

DESTINATION	COUNTRY	ABB	UNIT NO.	(A)	(C)	(D)	211-2
PX			0-23	NO	YES	NO	
RUSSIA	R	3-82					

C-H51 (X11-370X-XX)

DESTINATION	COUNTRY	ABB	UNIT NO.	(A)	(C)	(D)	W26,
PX			0-23	NO	YES	NO	
MALAYSIA	I						

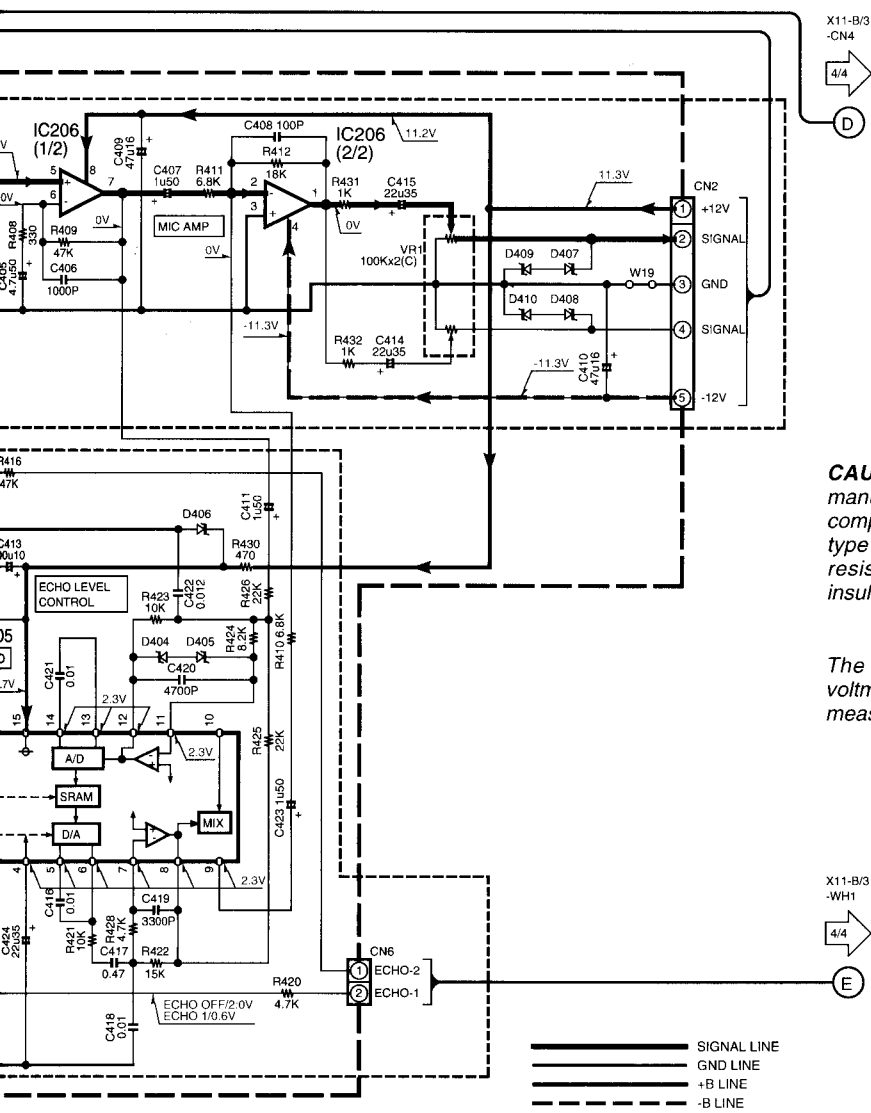

CAUTION: For continued safety, replace safety critical components only with manufacturer's recommended parts (refer to parts list). ⚠ indicates safety critical components. For continued protection against risk of fire, replace only with same type and rating fuse(s). To reduce the risk of electric shock, leakage-current or resistance measurements shall be carried out (exposed parts are acceptably insulated from the supply circuit) before the appliance is returned to the customer.

The DC voltage is an actual reading measured with a high impedance type voltmeter with no signal input. The measurement value may vary depending on the measuring instruments used or on the product.

CH-7 (X11-370X-XX)

DESTINATION	COUNTRY	ABB	UNIT NO.	(A)	(C)	(D)	W26,116,213,214,224,225	W211,212	W215-217,226,227	WH2	CN5	R22	R35-38,62,82-87,89,90	R128,129	C1	C37-44,54,55,58,60,62,74	D11-14,17
EUROPE	E		2-71		NO	NO	NO	YES						NO	4.7u35	NO	NO
U.K.	T		0-51						YES								
GENERAL MARKET	M		0-21	YES				NO						YES			
U.S.A.	K				YES												

C-H6 (X11-370X-XX)

DESTINATION	COUNTRY	ABB	UNIT NO.	(A)	(C)	(D)	W26,116,213,214,224,225	W211,212,215-217	W226,227	WH2	CN5	R22,35-38,62,128,129	R82-87,89,90	C1	C37-44,54,55,74	C58,60,62,74	D11-14,17
EUROPE	E		2-72	YES	NO	NO	NO	YES	YES	NO	YES	NO	YES	10u50	NO	YES	YES
U.K.	T		0-52						NO								

C-H6W (X11-370X-XX)

DESTINATION	COUNTRY	ABB	UNIT NO.	(A)	(C)	(D)	W26,116,211,212,214,224,225	W213,214,215-217	WH2	CN5	R22,35-38,128,129	R62,82-87,89,90	C1	C37-44,54,55	C58,60,62,74	D11-14,17
RUSSIA	O		3-81	YES	NO	NO	YES	NO	YES	NO	NO	YES	10u50	NO	YES	YES

C-H81 (X11-370X-XX)

DESTINATION	COUNTRY	ABB	UNIT NO.	(A)	(C)	(D)	W26,116,211,214,224,227	W215-217	WH2	CN5	R22,35-38,62	R82-87,89,90,128,129	C1	C37-44,54,55,74	C58,60,62	D11-14,17
PX	Y															
GENERAL MARKET	M		0-22	YES		NO	YES	NO	YES	NO	YES	YES	10u50	NO	YES	YES
MALAYSIA	I															

C-H5 (X11-370X-XX)

DESTINATION	COUNTRY	ABB	UNIT NO.	(A)	(C)	(D)	W26,116,215-217,224,227	W211-214	WH2	CN5	R22,62,128,129	R35-38,82-87,89,90	C1	C37-44,54,55,58,60,62	C74	D11-14,17
EUROPE	E		2-73	NO	NO	NO	NO	YES	NO	YES	NO	YES	4.7u35	YES	NO	YES
U.K.	T		0-53													

C-H5W (X11-370X-XX)

DESTINATION	COUNTRY	ABB	UNIT NO.	(A)	(C)	(D)	W26,116,211,214,224,225	W215-217,226,227	WH2	CN5	R22,128,129	R35-38,62,82-87,89,90	C1	C37-44,54,55,58,60,62,74	D11-14,17
RUSSIA	O		3-82	NO	NO	NO	YES	NO	YES	NO	NO	YES	4.7u35	YES	YES

C-H51 (X11-370X-XX)

DESTINATION	COUNTRY	ABB	UNIT NO.	(A)	(C)	(D)	W26,116,211,212,224,227	W213-217	WH2	CN5	R22,62	R35-38,82-87,89,90,128,129	C1	C37-44,54,55,58,60,62	C74	D11-14,17
GENERAL MARKET	M		0-23	NO	YES	NO	NO	YES	NO	YES	NO	YES	4.7u35	YES	NO	YES
MALAYSIA	I															

C-H5/H5W/H51/H6/H6W/H61/H7(M) (3/4)

C-H5/H51/H5W/H6/H61/H6W/H7

Y08-5602-70

KENWOOD

C-H7 (11-370X-XX)

DESTINATION	COUNTRY	ABB	UNIT No.	Ⓢ	WH	W201-206	R221-222	R241-243, 326-328	Q5-7, 205-207	Q204	Q209	D225, 226, 227	D226, 227	D228	D229	D230	D231	ED1	ED2	S11	S12	S14
EUROPE	E	T	2-71	YES	NO	NO	NO	YES	YES	NO	NO	NO	NO	YES	YES	YES	NO	YES	NO	TA/IN/NEWS	RDS DISP.	PTY
U.K.	T	T	0-51	NO	NO	NO	NO	NO	NO	NO	NO	NO	NO	NO	NO	NO	NO	NO	NO	MUTE	SLEEP	HITMASTER
GENERAL MARKET U.S.A.	M	K	0-21	NO	NO	NO	YES	YES	YES	YES	YES	YES	YES	NO	NO	NO	YES	NO	NO	NO	NO	NO

C-H6 (11-370X-XX)

DESTINATION	COUNTRY	ABB	UNIT No.	Ⓢ	WH	W201-206	R221-222	R241-243, 326-328	Q5-7, 205-207	Q204	D225, 226, 228	D227, 229	D230	D231	ED1	ED2	S11	S12	S14		
EUROPE	E	T	2-72	YES	NO	NO	NO	YES	YES	NO	NO	YES	YES	NO	YES	NO	TA/IN/NEWS	RDS DISP.	PTY		
U.K.	T	T	0-52	NO	NO	NO	NO	NO	NO	NO	NO	NO	NO	NO	NO	NO	NO	NO	NO	NO	NO

C-H6W (11-370X-XX)

DESTINATION	COUNTRY	ABB	UNIT No.	Ⓢ	WH	W201-206	R221-222	R241-243, 326-328	Q5-7, 205-207	Q204	D225, 226, 228	D227, 229-231	ED1	ED2	S11	S12	S14
RUSSIA	Q		3-81	YES	NO	NO	NO	YES	YES	NO	NO	YES	YES	NO	TA/IN/NEWS	RDS DISP.	PTY

C-H61 (11-370X-XX)

DESTINATION	COUNTRY	ABB	UNIT No.	Ⓢ	WH	W201-206	R221-222	R241-243, 326-328	Q5-7, 204-207, 209	Q209	D225, 227, 231	D226, 228, 229, 230	ED1	ED2	S11	S12	S14
PX GENERAL MARKET MALAYSIA	Y	M	0-22	NO	YES	NO	YES	YES	YES	YES	NO	NO	YES	NO	ECHO	SLEEP	HITMASTER

C-H5 (11-370X-XX)

DESTINATION	COUNTRY	ABB	UNIT No.	Ⓢ	WH	W201-206	R221-222	R241-243, 326-328	Q5-7, 204-207, 209	D225, 227, 228	D226, 229	D230	D231	ED1	ED2	S11	S12	S14
EUROPE	E	T	2-73	YES	NO	YES	NO	NO	NO	NO	YES	NO	YES	NO	YES	TA/IN/NEWS	RDS DISP.	PTY
U.K.	T	T	0-53	NO	NO	NO	NO	NO	NO	NO	NO	NO	NO	NO	NO	NO	NO	NO

C-H5W (11-370X-XX)

DESTINATION	COUNTRY	ABB	UNIT No.	Ⓢ	WH	W201-206	R221-222	R241-243, 326-328	Q5-7, 204-207, 209	D225, 227, 228	D226, 229-231	ED1	ED2	S11	S12	S14
RUSSIA	Q		3-82	YES	NO	YES	NO	NO	NO	NO	YES	NO	YES	TA/IN/NEWS	RDS DISP.	PTY

C-H51 (11-370X-XX)

DESTINATION	COUNTRY	ABB	UNIT No.	Ⓢ	WH	W201-206	R221-222	R241-243, 326-328	Q5-7, 204-207	Q209	D225, 226, 231	D227-230	ED1	ED2	S11	S12	S14
PX GENERAL MARKET MALAYSIA	Y	M	0-23	NO	YES	YES	YES	NO	NO	YES	YES	NO	NO	NO	ECHO	SLEEP	HITMASTER

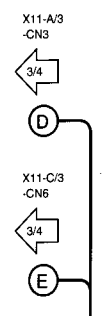
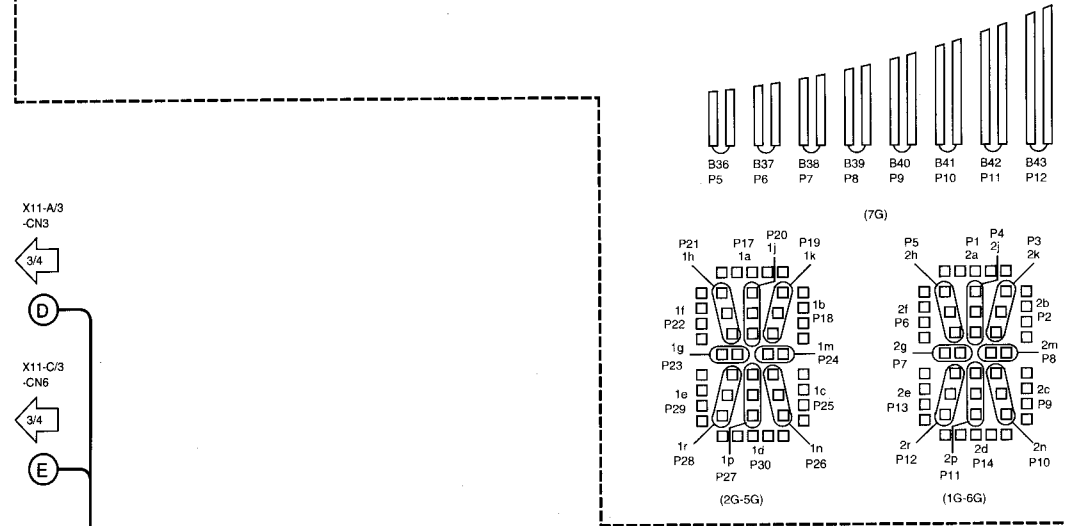
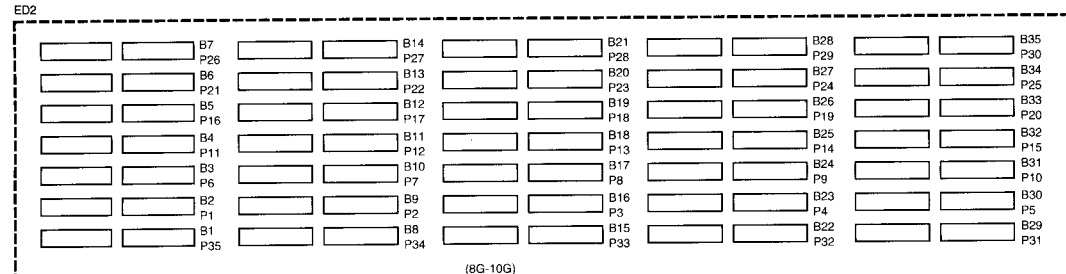
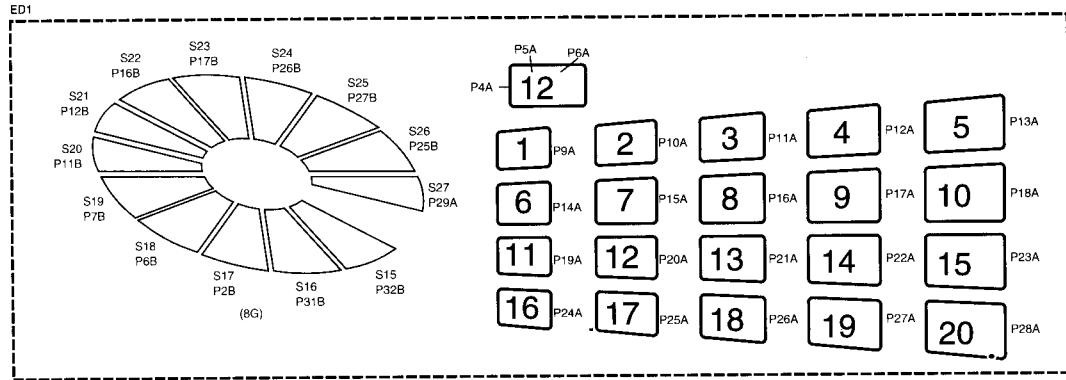

(X11-370X-XX) (B/3)

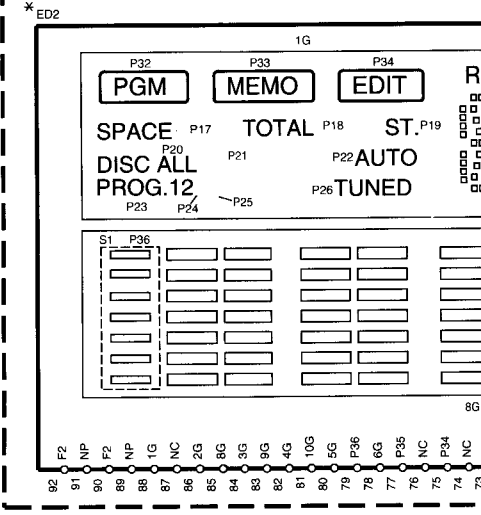
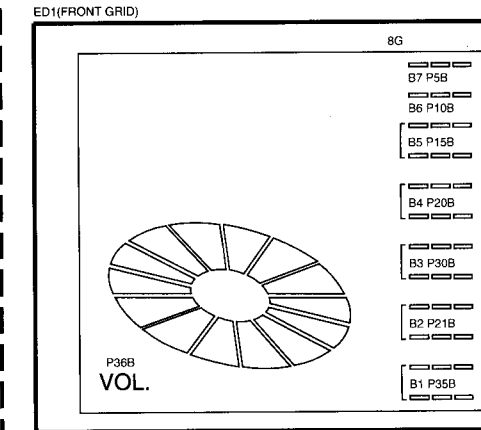
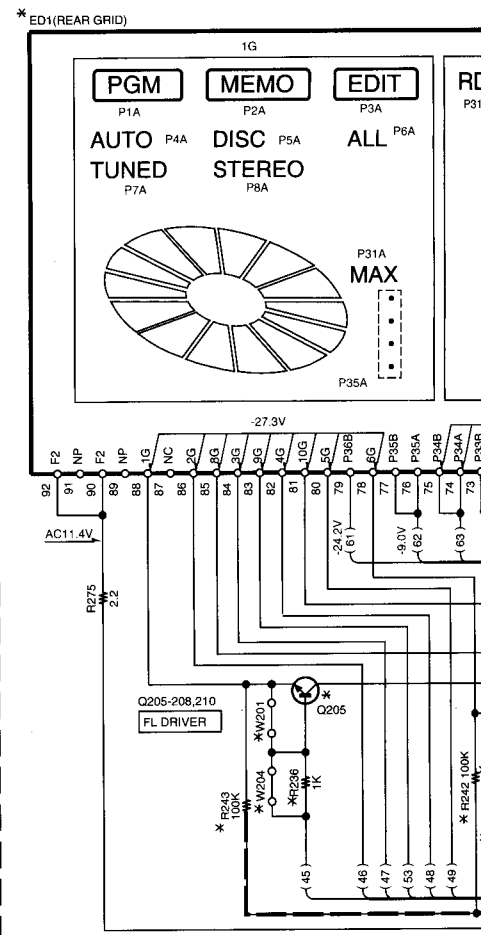

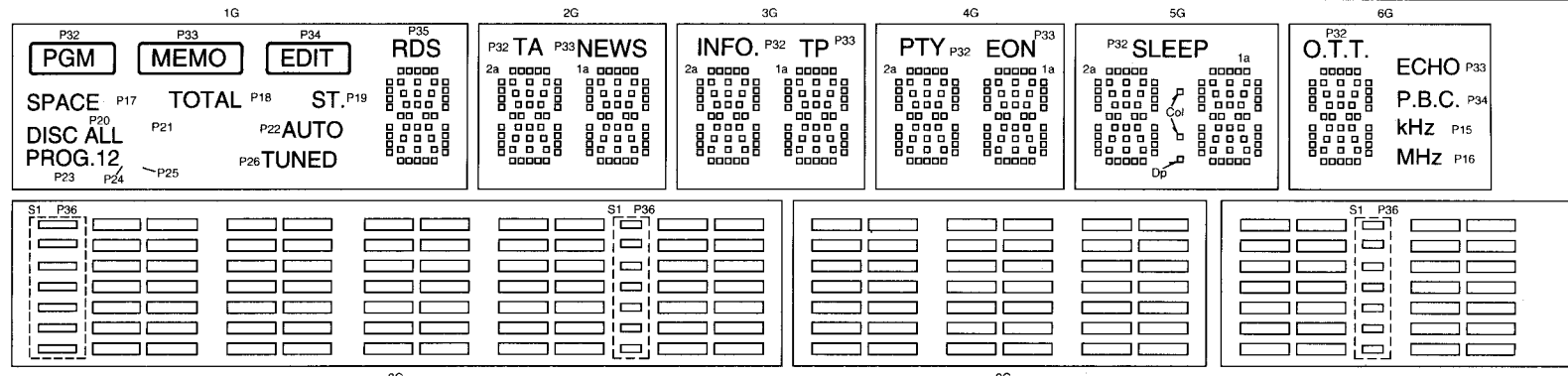
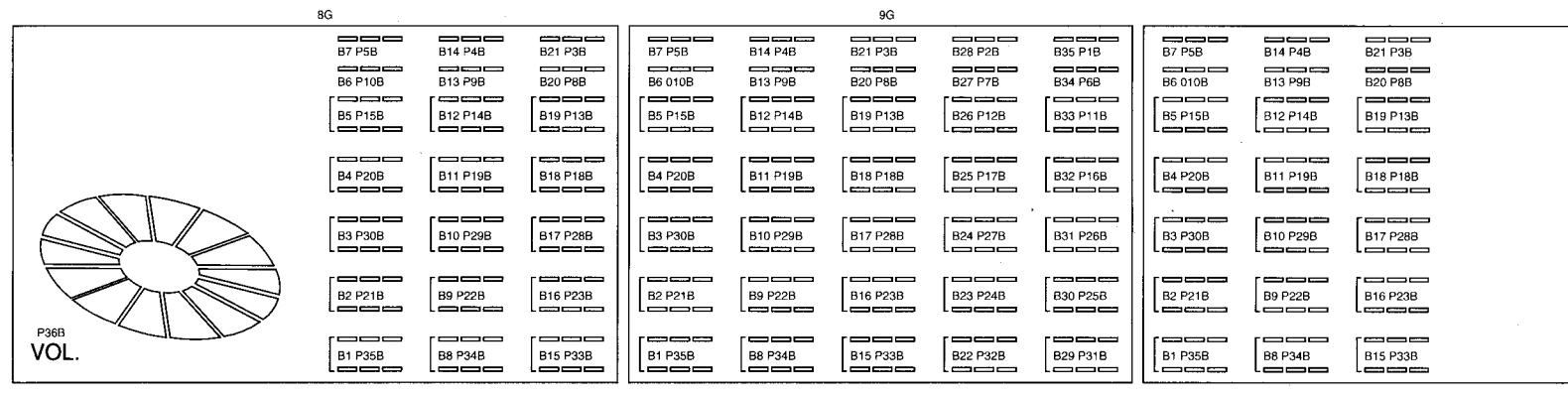
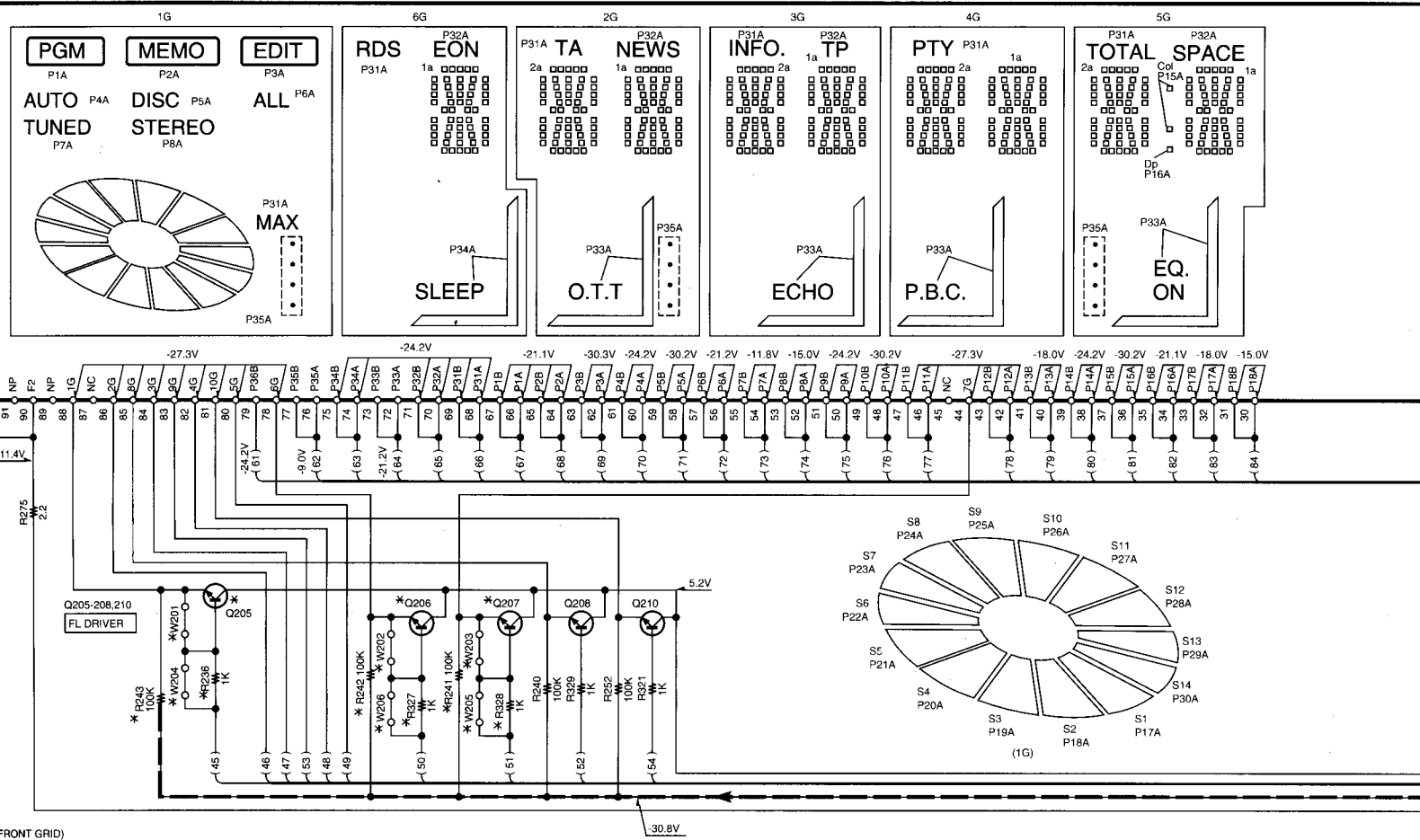

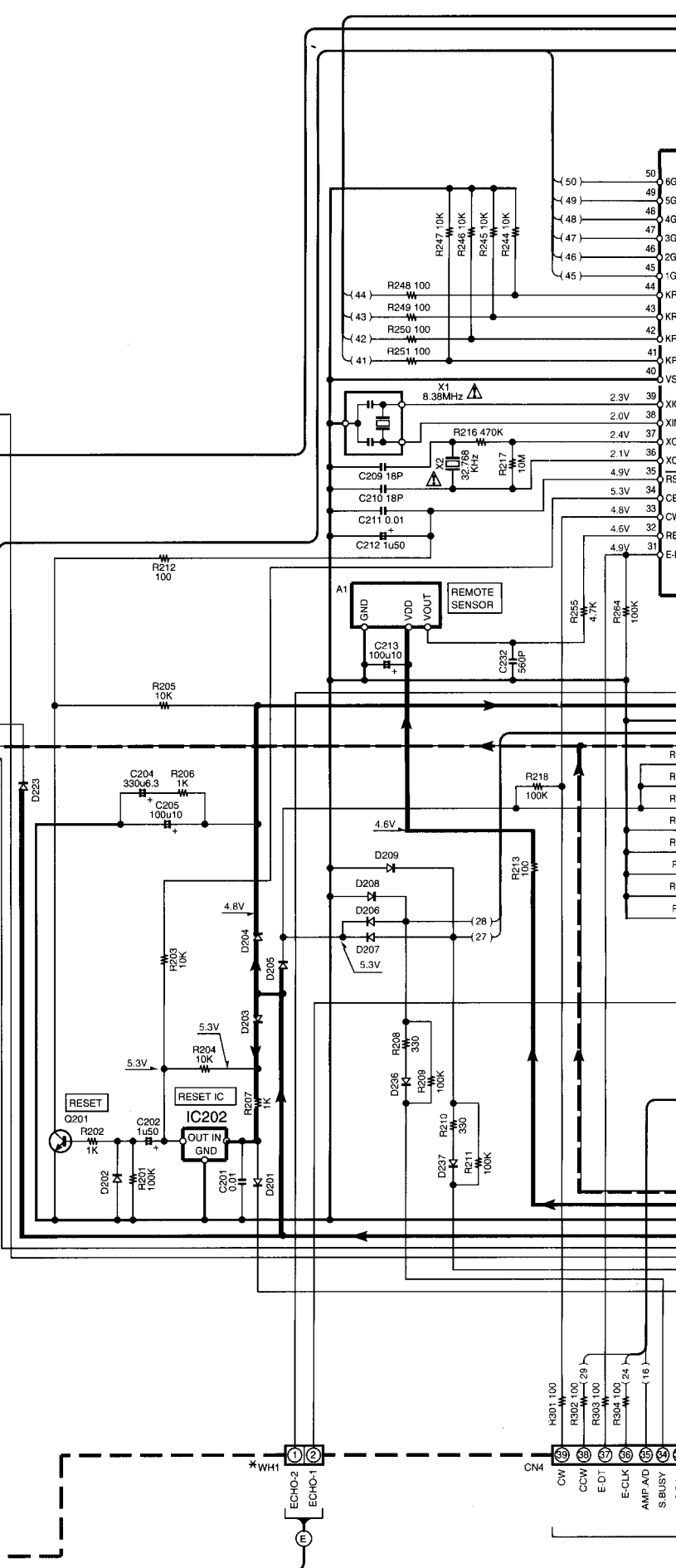
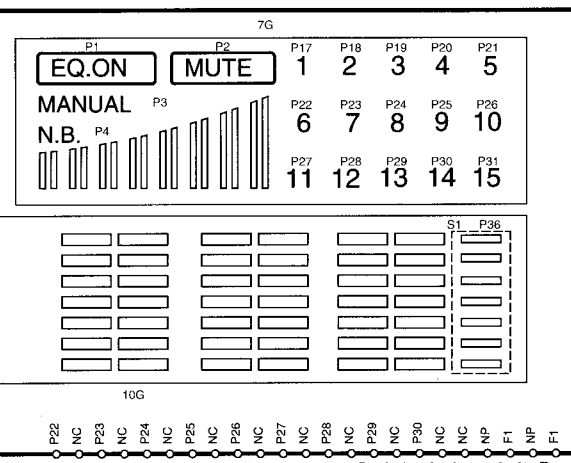
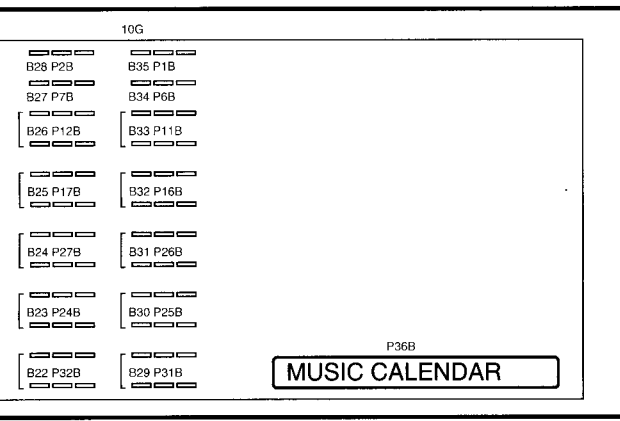
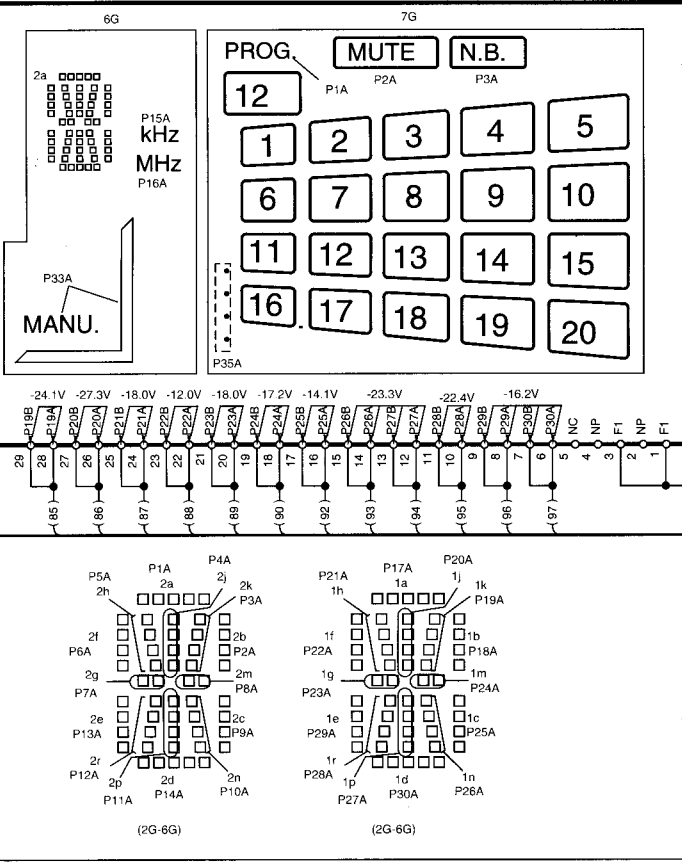

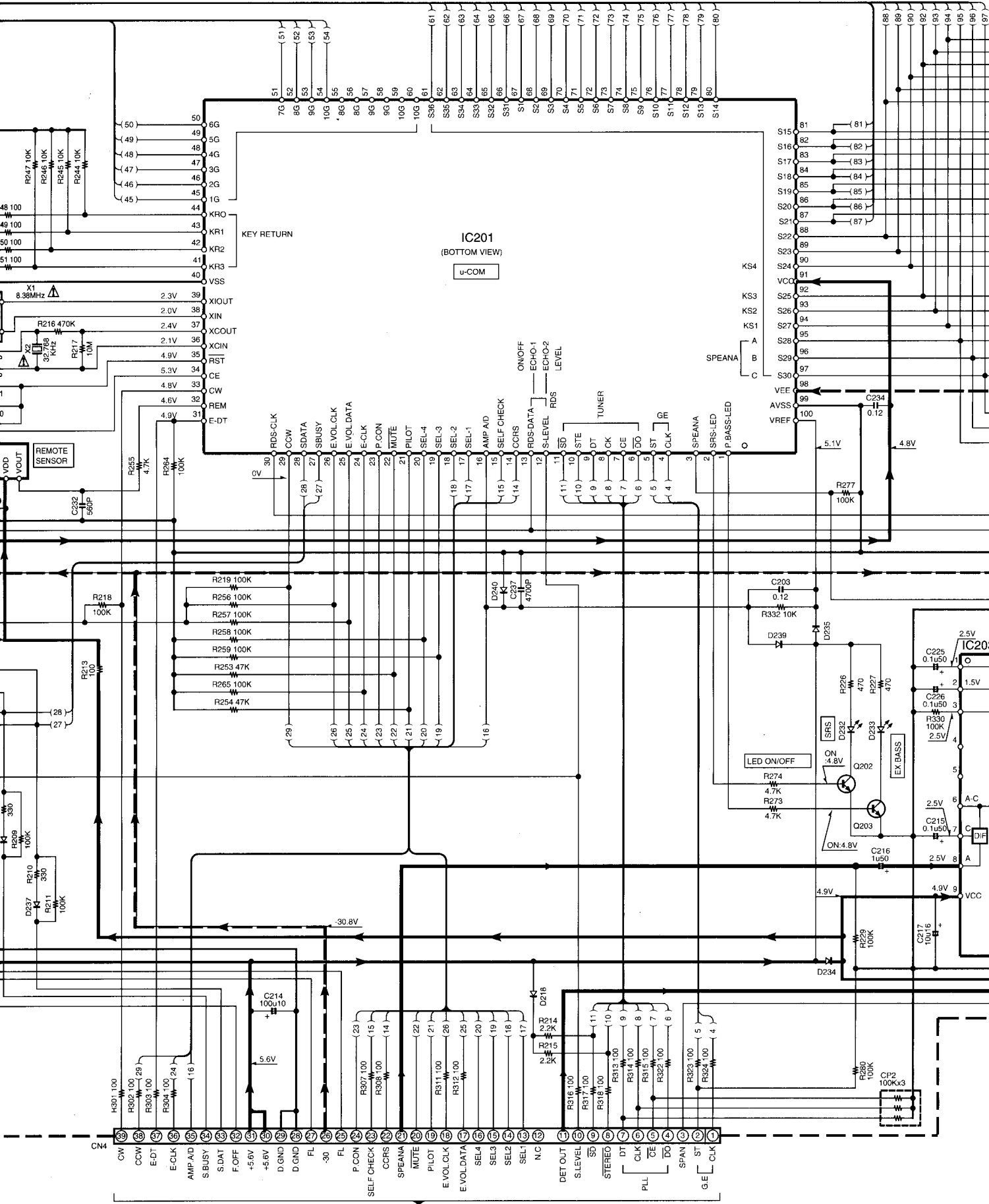

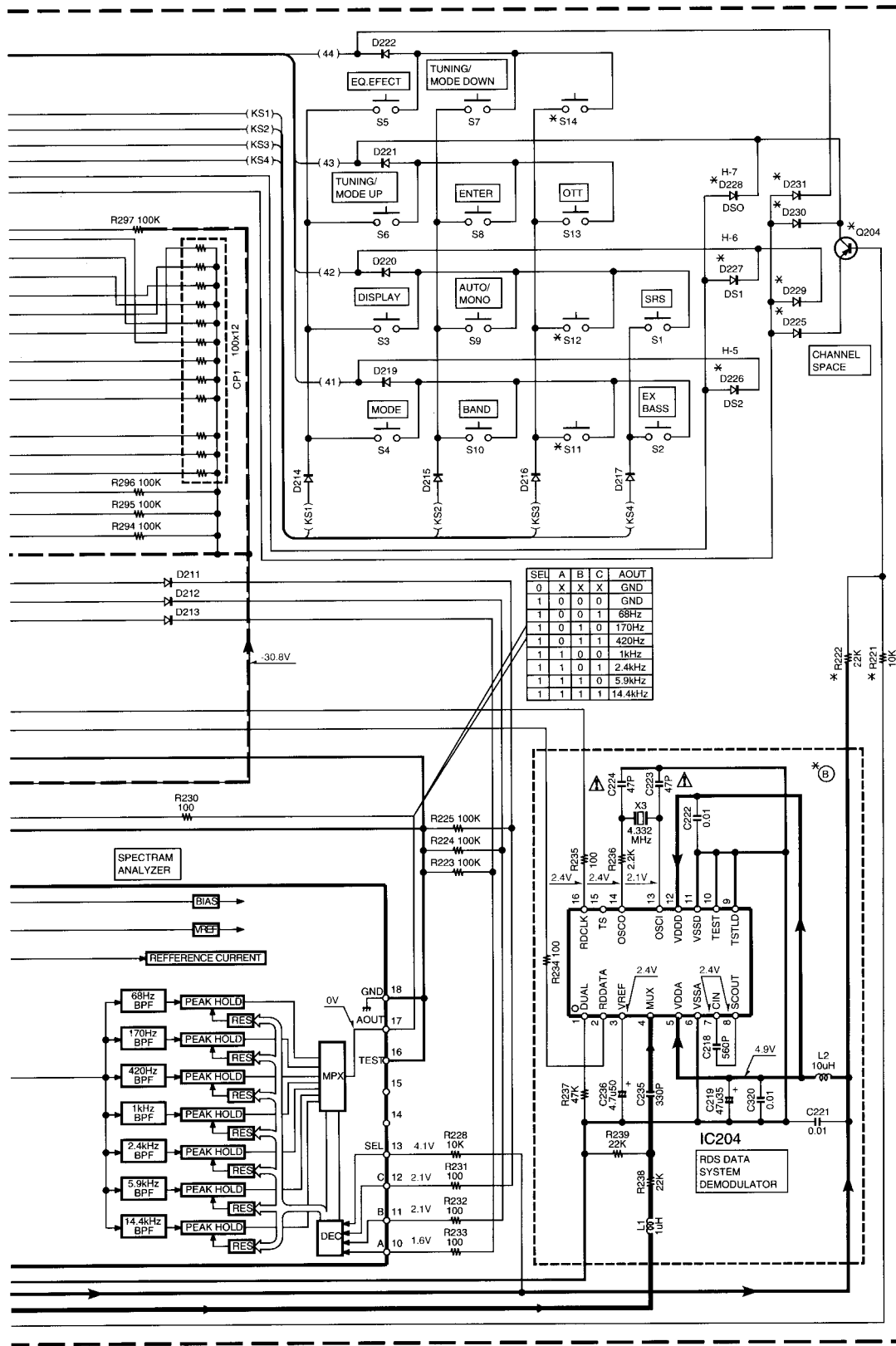

CAUTION: For continued safety, replace safety critical components only with manufacturer's recommended parts (refer to parts list). Δ indicates safety critical components. For continued protection against risk of fire, replace only with same type and rating fuse(s). To reduce the risk of electric shock, leakage-current or resistance measurements shall be carried out (exposed parts are acceptably insulated from the supply circuit) before the appliance is returned to the customer.

The DC voltage is an actual reading measured with a high impedance type voltmeter with no signal input. The measurement value may vary depending on the measuring instruments used or on the product.

SEL	A	B	C	AOUT
0	X	X	X	GND
1	0	0	0	GND
1	0	0	1	68Hz
1	0	1	0	170Hz
1	0	1	1	420Hz
1	1	0	0	1kHz
1	1	0	1	2.4kHz
1	1	1	0	5.9kHz
1	1	1	1	14.4kHz

- IC201 : M38198MCA803FP
- IC202 : S-806D-Z
- IC203 : BA3834S
- IC204 : SAA6579
- Q201-203,205-210 : 2SC1740S(Q,R) or 2SC2785(F,E)
- Q204 : 2SA933AS(Q,R) or 2SA1175(F,E)
- D201-209,211-223,225-231,234-237,239,240 : 1SS131 or HSS104A
- D232,233 : B30-2494-05

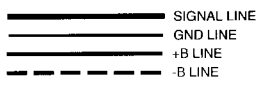

C-H5/H5W/H51/H6/W6W/H61/H7(M) (4/4)

Y08-5602-70

C-H5/H51/H5W/H6/H61/H6W/H

KENWOOD

- A ø 2.6x8 : N82-2608-46
- B ø 3x8 (BLK) : N89-3008-45
- C ø 3x6 : N89-3006-46
- D ø 3x18 : N89-3018-46
- E ø 3x5 (BLK) : N09-0395-05

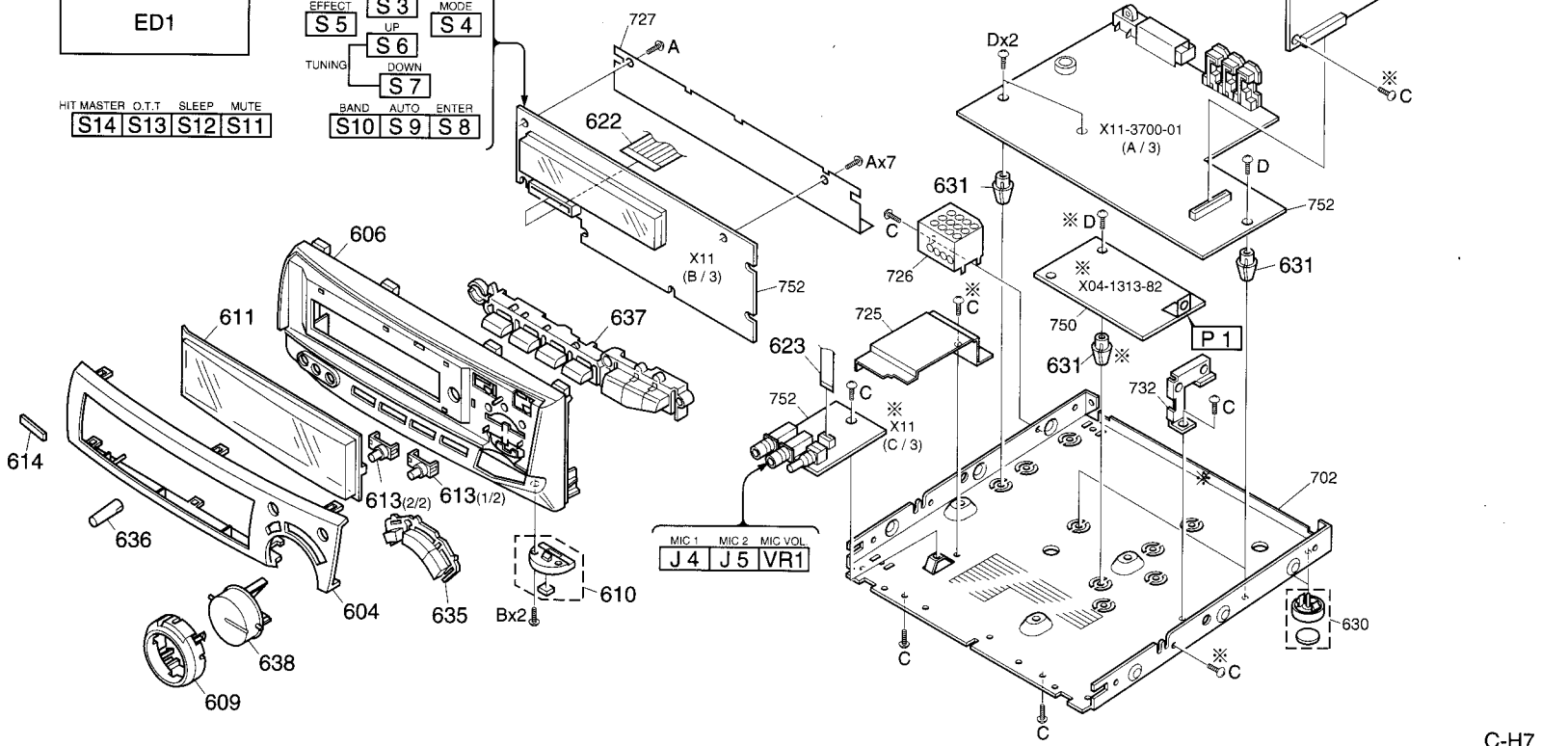
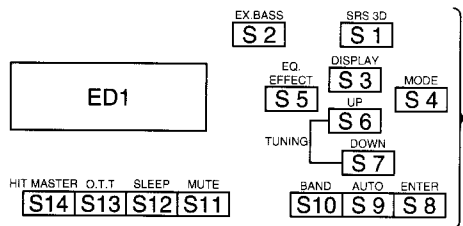
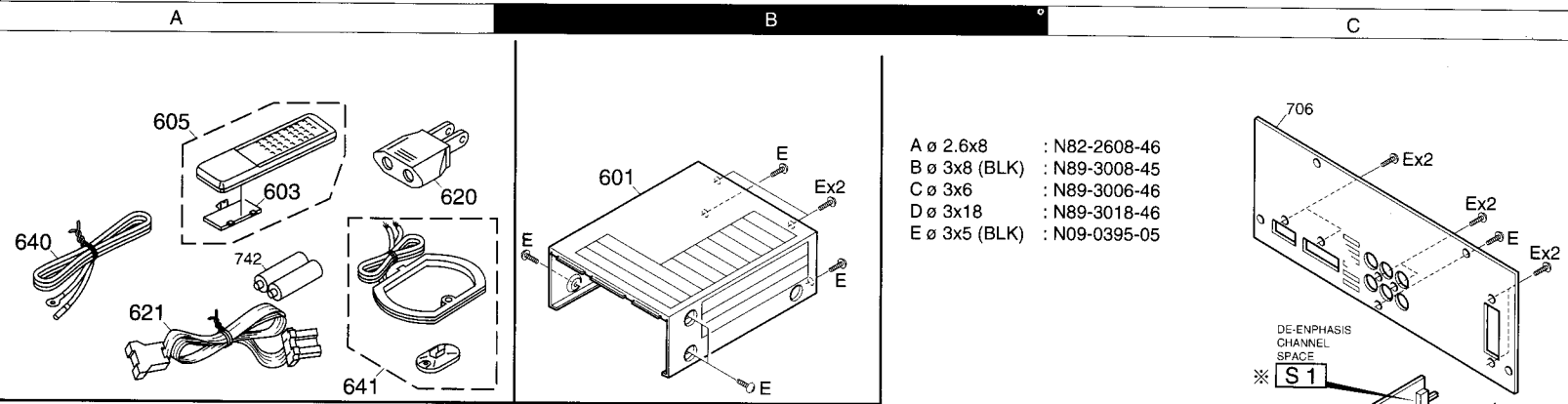

C-H7

* New Parts
 Parts without **Parts No.** are not supplied.
 Les articles non mentionnés dans le **Parts No.** ne sont pas fournis.
 Teile ohne **Parts No.** werden nicht geliefert.

1

Ref. No	Add-ress	New Parts	Parts No.	Description	Desti-nation	Re-marks
C-H7						
601	1B	*	A01-3434-01	METALLIC CABINET		
603	1A	*	A09-0380-08	BATTERY COVER		
604	2A	*	A21-1916-02	DRESSING PANEL		
605	1A	*	A70-1110-05	REMOTE CONTROLLER ASSY	KM	
605	1A		A70-1121-05	REMOTE CONTROLLER ASSY	TE	
606	2A	*	A60-1009-01	PANEL	KM	
606	2A		A60-1010-11	PANEL	TE	
609	2A	*	B07-2333-03	ESCUTCHEON		
610	2B	*	B07-2335-04	ESCUTCHEON		
611	2A	*	B10-2280-03	FRONT GLASS		
612	1A	*	B19-1529-05	OPTICAL FIBER		
613	2A	*	B19-1573-04	LENS		
614	2A		B43-0301-04	KENWOOD BADGE		
-	-		B46-0197-00	QUESTIONNAIRE CARD	K	
-	-		B46-0310-03	WARRANTY CARD	TE	
-	-		B46-0319-00	QUESTIONNAIRE CARD	T	
-	-		B46-0328-03	WARRANTY CARD	K	
-	-		B58-0964-13	CAUTION CARD (UL)	K	
-	-		B58-0965-13	CAUTION CARD (PL)	T	
-	-		B58-0966-13	CAUTION CARD (PL)	ME	
-	-	*	B60-2898-00	INSTRUCTION MANUAL(ENG)	KM	
-	-	*	B60-2899-00	INSTRUCTION MANUAL(ENG)	T	
-	-	*	B60-2900-00	INSTRUCTION MANUAL(FRE)	E	
-	-	*	B60-2901-00	INSTRUCTION MANUAL(GER)	E	
-	-	*	B60-2902-00	INSTRUCTION MANUAL(NET)	E	
-	-	*	B60-2903-00	INSTRUCTION MANUAL(ITL)	E	
-	-	*	B60-2904-00	INSTRUCTION MANUAL(SPA)	E	
-	-	*	B60-3114-00	INSTRUCTION MANUAL(TWN)	M	
-	-	*	B60-3121-00	INSTRUCTION MANUAL(SPA)	M	
△ 620	1A		E03-0115-05	AC PLUG ADAPTER	M	
621	1A		E30-2738-05	CORD WITH CONNECTOR		
622	1B		E35-1126-05	FLAT CABLE		
623	2B	*	E35-1762-05	FLAT CABLE	KM	
-	-	*	H10-7246-02	POLYSTYRENE FOAMED FIXTURE		
-	-	*	H10-7247-02	POLYSTYRENE FOAMED FIXTURE		
-	-		H13-0086-04	CARTON BOARD		
-	-		H25-0632-24	PROTECTION BAG	KME	
-	-		H25-0644-04	PROTECTION BAG	T	
-	-		H25-0681-04	PROTECTION BAG		
-	-	*	H50-2149-04	ITEM CARTON CASE	TE	
-	-	*	H50-2150-04	ITEM CARTON CASE	M	
-	-	*	H50-2438-04	ITEM CARTON CASE	K	
630	2C		J02-0366-15	FOOT		
631	2C		J19-3751-04	UNIT HOLDER		
635	2A	*	K29-6490-02	KNOB (3 KEY)		
636	2A	*	K29-6491-04	KNOB (MIC)	KM	
637	2B	*	K29-6603-02	KNOB (7 KEY)	KM	
637	2B	*	K29-6645-02	KNOB (7 KEY)	TE	
638	2A	*	K29-6608-03	KNOB (UP/DOWN)		
640	1A		T90-0801-05	LEAD WIRE ANTENNA	KM	
640	1A		T90-0809-05	LEAD WIRE ANTENNA	TE	

L : Scandinavia K : USA P : Canada R : Mexico 5 : C-H5 series
 Y : PX(Far East, Hawaii) T : Europe E : Europe G : Germany 6 : C-H6 series
 Y : AAFES(Europe) X : Australia M : Other Areas Q : Russia 7 : C-H7
 △ indicates safety critical components.

* New Parts
 Parts without **Parts No.** are not supplied.
 Les articles non mentionnés dans le **Parts No.** ne sont pas fournis.
 Teile ohne **Parts No.** werden nicht geliefert.

2

Ref. No	Add-ress	New Parts	Parts No.	Description	Desti-nation	Re-marks
641	1A		T90-0820-05	LOOP ANTENNA		
C-H5/H6						
601	1B	*	A01-3427-01	METALLIC CABINET (BLK)	EQT	
601	1B	*	A01-3434-01	METALLIC CABINET (SLV)	EQTM	YI
603	1A	*	A09-0380-08	BATTERY COVER		
604	2A	*	A21-1917-02	DRESSING PANEL (SLV)	5	EQT
604	2A	*	A21-1918-02	DRESSING PANEL (BLK)	5	EQT
604	2A	*	A21-1919-02	DRESSING PANEL (SLV)	5	YMI
604	2A	*	A21-1936-12	DRESSING PANEL (BLK)	6	EQT
604	2A	*	A21-1937-12	DRESSING PANEL (SLV)	6	YMI
604	2A	*	A21-1951-12	DRESSING PANEL (SLV)	6	EQT
605	1A	*	A70-1104-05	REMOTE CONTROLLER ASSY5		EQT
605	1A		A70-1104-05	REMOTE CONTROLLER ASSY6		ET
605	1A		A70-1105-05	REMOTE CONTROLLER ASSY5		YMI
605	1A		A70-1105-05	REMOTE CONTROLLER ASSY6		YMI
606	2A		A60-1009-01	PANEL (SLV)		YMI
606	2A	*	A60-1010-11	PANEL (SLV)		EQT
606	2A	*	A60-1111-11	PANEL (BLK)		EQT
609	2A	*	B07-2333-03	ESCUTCHEON (SLV)		EQYMTI
609	2A	*	B07-2334-03	ESCUTCHEON (BLK)		EQT
610	2B	*	B07-2335-04	ESCUTCHEON		
611	2A	*	B10-2280-03	FRONT GLASS		
613	2A	*	B19-1573-04	LENS		
614	2A		B43-0301-04	KENWOOD BADGE		
-	-		B46-0310-03	QUESTIONNAIRE CARD		EQT
-	-		B46-0319-00	QUESTIONNAIRE CARD		T
-	-		B46-0328-03	WARRANTY CARD		Y
-	-		B58-0964-13	CAUTION CARD (UL)		Y
-	-		B58-0965-13	CAUTION CARD (PL)		TT
-	-		B58-0966-13	CAUTION CARD (PL)		EM
-	-		B58-0966-13	CAUTION CARD (PL)		I
-	-		B58-1526-03	CAUTION CARD		Q
-	-		B59-1104-00	SERVICE DIRECTORY		Y
-	-	*	B60-2905-00	INSTRUCTION MANUAL (TWN)		MI
-	-	*	B60-2906-00	INSTRUCTION MANUAL (RUN)		Q
-	-	*	B60-2907-00	INSTRUCTION MANUAL (PLN)		Q
-	-	*	B60-3115-00	INSTRUCTION MANUAL (ENG)		YMI
-	-	*	B60-3116-00	INSTRUCTION MANUAL (ENG)		T
-	-	*	B60-3117-00	INSTRUCTION MANUAL (FRE)		E
-	-	*	B60-3118-00	INSTRUCTION MANUAL (GER)		E
-	-	*	B60-3119-00	INSTRUCTION MANUAL (NET)		E
-	-	*	B60-3120-00	INSTRUCTION MANUAL (SPA)		M
-	-	*	B60-3241-00	INSTRUCTION MANUAL (ITL)		E
-	-	*	B60-3242-00	INSTRUCTION MANUAL (SPA)		E
△ 620	1A		E03-0115-05	AC PLUG ADAPTER		MI
621	1A		E30-2738-05	CORD WITH CONNECTOR		
622	1B		E35-1126-05	FLAT CABLE		
623	2B	*	E35-1762-05	FLAT CABLE		YMI
-	-		H10-7246-02	POLYSTYRENE FOAMED FIXTURE		
-	-		H10-7247-02	POLYSTYRENE FOAMED FIXTURE		
-	-		H13-0086-04	CARTON BOARD		
-	-		H25-0632-24	PROTECTION BAG		EQYMTI
-	-		H25-0644-04	PROTECTION BAG		T

L : Scandinavia K : USA P : Canada R : Mexico 5 : C-H5 series
 Y : PX(Far East, Hawaii) T : Europe E : Europe G : Germany 6 : C-H6 series
 Y : AAFES(Europe) X : Australia M : Other Areas Q : Russia 7 : C-H7
 △ indicates safety critical components.

C-H5/H51/H5W/H6/H61/H6W/H7
PARTS LIST

* New Parts
Parts without **Parts No.** are not supplied.
Les articles non mentionnés dans le **Parts No.** ne sont pas fournis.
Teile ohne **Parts No.** werden nicht geliefert.

③

Ref. No	Add- ress	New Parts	Parts No.	Description	Desti- nation	Re- marks
-		*	H25-0681-04	PROTECTION BAG		
-		*	H50-2152-04	ITEM CARTON CASE (SLV)	5	ET
-		*	H50-2153-04	ITEM CARTON CASE (SLV)	5	MI
-		*	H50-2255-04	ITEM CARTON CASE (SLV)	6	ET
-		*	H50-2256-04	ITEM CARTON CASE (SLV)	6	MI
-		*	H50-2257-04	ITEM CARTON CASE (SLV)	6	Y
-		*	H50-2313-04	ITEM CARTON CASE (SLV)	5	Q
-		*	H50-2315-04	ITEM CARTON CASE (SLV)	5	Y
-		*	H50-2317-04	ITEM CARTON CASE (SLV)	6	Q
-		*	H50-2348-04	ITEM CARTON CASE (BLK)	5	ET
-		*	H50-2349-04	ITEM CARTON CASE (BLK)	5	Q
-		*	H50-2350-04	ITEM CARTON CASE (BLK)	6	ET
-		*	H50-2412-04	ITEM CARTON CASE (BLK)	6	Q
630	2C		J02-0366-15	FOOT		
631	2C		J19-3751-04	UNIT HOLDER		
635	2A		K29-6490-02	KNOB (3 KEY) (SLV)	6	EQYMTI
635	2A	*	K29-6607-02	KNOB (3 KEY) (BLK)	6	EQT
635	2A	*	K29-6646-02	KNOB (3 KEY) (SLV)	5	EQYMTI
635	2A	*	K29-6647-02	KNOB (3 KEY) (BLK)	5	EQT
636	2A		K29-6491-04	KNOB (MIC) (SLV)		YMI
637	2B		K29-6603-02	KNOB (7 KEY) (SLV)		YMI
637	2B	*	K29-6623-02	KNOB (7 KEY) (BLK)		EQT
637	2B	*	K29-6645-02	KNOB (7 KEY) (SLV)		EQT
638	2A		K29-6608-03	KNOB (UP/DOWN) (SLV)		EQYMTI
638	2A	*	K29-6609-03	KNOB (UP/DOWN) (BLK)		EQT
640	1A		T90-0801-05	LEAD WIRE ANTENNA		YMI
640	1A		T90-0809-05	LEAD WIRE ANTENNA		EQT
641	1A		T90-0820-05	LOOP ANTENNA		
MPX (X04-1313-82) Q type only						
C1	.3		CE04LW1H010M	ELECTRO	1.0UF	50WV
C2	.3	*	C91-1566-05	PF-C	0.01UF	G
C4			CE04LW1A470M	ELECTRO	47UF	10WV
C5	.6		CQ93FMG1H102J	MYLAR	1000PF	J
C7			CC45FSL1H331J	CERAMIC	330PF	J
C8			CK45FB1H102K	CERAMIC	1000PF	K
C9			CC93FCH1H471J	CERAMIC	470PF	J
C10	.11		CE04LW1HR47M	ELECTRO	0.47UF	50WV
C12			CK45FF1H473Z	CERAMIC	0.047UF	Z
C13	-15		CE04LW1H010M	ELECTRO	1.0UF	50WV
C16			CK45FF1H103Z	CERAMIC	0.010UF	Z
C17	.18		CE04LW1H2R2M	ELECTRO	2.2UF	50WV
C19	.20		CQ93FMG1H682J	MYLAR	6800PF	J
C21			CK45FF1H103Z	CERAMIC	0.010UF	Z
C22			CE04LW1A470M	ELECTRO	47UF	10WV
C23	.24		CQ93FMG1H472J	MYLAR	4700PF	J
C25			CC45FSL1H121J	CERAMIC	120PF	J
C26			CE04LW1H2R2M	ELECTRO	2.2UF	50WV
TC1		*	C05-0463-05	CERAMIC	TRIMMER	CAPACITOR(120P
CN2	.3		E40-4871-05	PIN ASSY		
CN4		*	E40-4372-05	PIN ASSY		
CN5		*	E40-3259-05	PIN ASSY		
CN6		*	E40-4872-05	PIN ASSY		
L1		*	L39-1350-05	PEAKING COIL		

L : Scandinavia K : USA P : Canada R : Mexico 5 : C-H5 series
Y : FX(Far East, Hawaii) T : Europe E : Europe G : Germany 6 : C-H6 series
Y : AAFES(Europe) X : Australia M : Other Areas Q : Russia 7 : C-H7

△ indicates safety critical components.

* New Parts
Parts without **Parts No.** are not supplied.
Les articles non mentionnés dans le **Parts No.** ne sont pas fournis.
Teile ohne **Parts No.** werden nicht geliefert.

④

Ref. No	Add- ress	New Parts	Parts No.	Description	Desti- nation	Re- marks
L2	.3		L79-1236-05	LC FILTER		
L4			L40-1021-14	SMALL FIXED INDUCTOR(1.0MH,K)		
Δ R9			RS14KB3A221J	FL-PROOF RS 220	J	1W
VR1			R12-3685-05	TRIMMING POT.(10K)		
VR2			R12-1619-05	TRIMMING POT.(4.7K)		
D1			MTZJ5.1(B)	ZENER DIODE		
D1			UZ-5.1BSB	ZENER DIODE		
D2	.3		HSS104	DIODE		
D2	.3		1SS133	DIODE		
D4			MTZJ5.1(B)	ZENER DIODE		
D4			UZ-5.1BSB	ZENER DIODE		
D6	.7		HSS104	DIODE		
D6	.7		1SS133	DIODE		
IC1		*	IR3R42	ANALOGUE IC		
IC2			NJM4565D	ANALOGUE IC		
IC3			TC4052BP	IC(4CH MPX/DE-MPX)		
Q1			2SA1175(F,E)	TRANSISTOR		
Q1			2SA933AS(Q,R)	TRANSISTOR		
Q5			DTC124ESA	DIGITAL TRANSISTOR		
Q5			UN4212	DIGITAL TRANSISTOR		
TUNER (X05-4652-71) TEQ type						
C1			CE04LW1C470M	ELECTRO	47UF	16WV
C2			CE04LW1H010M	ELECTRO	1.0UF	50WV
C3	-8		CK73FB1H103K	CHIP C	0.010UF	K
C9			C91-0769-05	CERAMIC	0.010UF	K
C30			CK73EB1E473K	CHIP C	0.047UF	K
C31			CE04LW1C470M	ELECTRO	47UF	16WV
C32			CK73FB1H103K	CHIP C	0.010UF	K
C33			CE04LW1C100M	ELECTRO	10UF	16WV
C34			CK73EB1E104K	CHIP C	0.10UF	K
C35			CE04LW1C100M	ELECTRO	10UF	16WV
C36			CK73FB1E473K	CHIP C	0.047UF	K
C37			CK73EF1E105Z	CHIP C	1.0UF	Z
C38			C90-3217-05	ELECTRO	10UF	10WV
C39			CC73FSL1H101J	CHIP C	100PF	J
C40			C90-3253-05	ELECTRO	1.0UF	50WV
C41			C90-3251-05	ELECTRO	0.47UF	50WV
C42			C90-3240-05	ELECTRO	2.2UF	35WV
C43			CE04LW1HR47M	ELECTRO	0.47UF	50WV
C44			CK73FB1E473K	CHIP C	0.047UF	K
C45			CC73FCH1H220J	CHIP C	22PF	J
C46			CE04LW1A101M	ELECTRO	100UF	10WV
C47			CK73FB1H682K	CHIP C	6800PF	K
C48			CC73FSL1H101J	CHIP C	100PF	J
C49			C90-3253-05	ELECTRO	1.0UF	50WV
C50			CK73FB1H102K	CHIP C	1000PF	K
C51	.52		C90-3217-05	ELECTRO	10UF	10WV
C53	.54		CK73FB1H223K	CHIP C	0.022UF	K
C55	.56		C90-3231-05	ELECTRO	3.3UF	25WV
C55	.56		C90-3240-05	ELECTRO	2.2UF	35WV
C57	.58		CK73FB1H682K	CHIP C	6800PF	K
C59			CC73ESL1H101J	CHIP C	100PF	J
C60			CK73FB1E104K	CHIP C	0.10UF	K
C61			CK73FB1H103K	CHIP C	0.010UF	K

L : Scandinavia K : USA P : Canada R : Mexico 5 : C-H5 series
Y : FX(Far East, Hawaii) T : Europe E : Europe G : Germany 6 : C-H6 series
Y : AAFES(Europe) X : Australia M : Other Areas Q : Russia 7 : C-H7

△ indicates safety critical components.

C-H5/H51/H5W/H6/H61/H6W/H7

PARTS LIST

* New Parts
Parts without **Parts No.** are not supplied.
Les articles non mentionnés dans le **Parts No.** ne sont pas fournis.
Teile ohne **Parts No.** werden nicht geliefert.

7

Ref. No	Add-ress	New Parts	Parts No.	Description	Desti-nation	Re-marks
W51 -55			R92-0670-05	CHIP R	0 OHM	E
W53			R92-0670-05	CHIP R	0 OHM	QT
W56 -58			R92-0679-05	CHIP R	0 OHM	
W59			R92-0670-05	CHIP R	0 OHM	ET
W59 -61			R92-0670-05	CHIP R	0 OHM	Q
W61			R92-0670-05	CHIP R	0 OHM	ET
W62 -67			R92-0679-05	CHIP R	0 OHM	
W68			R92-0670-05	CHIP R	0 OHM	Q
W69 -71			R92-0679-05	CHIP R	0 OHM	E
W69 -72			R92-0679-05	CHIP R	0 OHM	QT
W73			R92-0670-05	CHIP R	0 OHM	
W74			R92-0679-05	CHIP R	0 OHM	Q
W75			R92-0670-05	CHIP R	0 OHM	E
W75 ,76			R92-0670-05	CHIP R	0 OHM	QT
W79 ,80			R92-0670-05	CHIP R	0 OHM	Q
W80			R92-0670-05	CHIP R	0 OHM	ET
W82			R92-0670-05	CHIP R	0 OHM	Q
W83 -85			R92-0679-05	CHIP R	0 OHM	
W83 ,84			R92-0679-05	CHIP R	0 OHM	ET
D1			HSS104	DIODE		
D1			1SS133	DIODE		
D31			MTZJ8.2(B)	ZENER DIODE		
D31			UZ-8.2BSB	ZENER DIODE		
D32			MA111	DIODE		
D33			HSS104	DIODE		
D33			1SS133	DIODE		
D61 ,62			HSS104	DIODE		
D61 ,62			1SS133	DIODE		
D81			MTZJ5.1(B)	ZENER DIODE		
D81			UZ-5.1BSB	ZENER DIODE		
IC1			LA1836	ANALOGUE IC		
IC2			LC72131	MOS-IC		
IC3			NJM2904M	IC(OP AMP X2)		
Q1 ,2			2SC2714(R,O)	TRANSISTOR		
Q3			2SA1576A(R,S)	TRANSISTOR		
Q3			2SB1218A(Q,R)	TRANSISTOR		
Q31 ,32			2SC4081(R,S)	TRANSISTOR		
Q31 ,32			2SD1819A(Q,R)	TRANSISTOR		
Q61 ,62			2SC4081(R,S)	TRANSISTOR		QT
Q61 ,62			2SD1819A(Q,R)	TRANSISTOR		QT
Q63			2SC2878(B)	TRANSISTOR		QT
Q64			2SA1576A(R,S)	TRANSISTOR		QT
Q64			2SB1218A(Q,R)	TRANSISTOR		QT
Q65			2SK302(Y,GR)	FET		QT
Q81			2SA1576A(R,S)	TRANSISTOR		
Q81			2SB1218A(Q,R)	TRANSISTOR		
A1			W02-2565-05	FM FRONT-END ASSY	ET	
A1			W02-2579-05	FM FRONT-END ASSY	Q	
TUNER (X05-4660-12) KYMI type						
C1 ,2			CK73FB1H103K	CHIP C	0.010UF	K
C3			CC73FCH1H040C	CHIP C	4.0PF	C
C5			CK73FB1H222K	CHIP C	2200PF	K
C7			CK73FB1H102K	CHIP C	1000PF	K
C8			CK73FB1H103K	CHIP C	0.010UF	K

L : Scandinavia K : USA P : Canada R : Mexico 5 : C-H5 series
Y : PX(Far East, Hawaii) T : Europe E : Europe G : Germany 6 : C-H6 series
Y : AAFES(Europe) X : Australia M : Other Areas Q : Russia 7 : C-H7

△ indicates safety critical components.

* New Parts
Parts without **Parts No.** are not supplied.
Les articles non mentionnés dans le **Parts No.** ne sont pas fournis.
Teile ohne **Parts No.** werden nicht geliefert.

8

Ref. No	Add-ress	New Parts	Parts No.	Description	Desti-nation	Re-marks
C9			CE04LW1C100M	ELECTRO	10UF	16WV
C10			CK73FB1H473K	CHIP C	0.047UF	K
C11			CE04LW1H010M	ELECTRO	1.0UF	50WV
C12			CE04LW1H2R2M	ELECTRO	2.2UF	50WV
C13			CK73FB1H102K	CHIP C	1000PF	K
C14			CE04LW1H010M	ELECTRO	1.0UF	50WV
C15			CC73FCH1H220J	CHIP C	22PF	J
C16			CE04LW1C100M	ELECTRO	10UF	16WV
C17			CK73FB1H562K	CHIP C	5600PF	K
C18			CK73FB1H102K	CHIP C	1000PF	K
C19			CE04HW1E4R7M	NP-ELEC	4.7UF	25WV
C20			CK73FB1E104K	CHIP C	0.10UF	K
C21 ,22			CQ93FMG1H113J	MYLAR	0.011UF	J
C21 ,22			CQ93FMG1H1163J	MYLAR	0.016UF	J
C23			CE04LW1H010M	ELECTRO	1.0UF	50WV
C25			CE04LW1C100M	ELECTRO	10UF	16WV
C26			CE04LW1C470M	ELECTRO	47UF	16WV
C27			CE04LW1H010M	ELECTRO	1.0UF	50WV
C28			CQ93FMG1H223J	MYLAR	0.022UF	J
C29			CE04LW1H2R2M	ELECTRO	2.2UF	50WV
C30			CE04LW1C101M	ELECTRO	100UF	16WV
C31			CE04LW1A470M	ELECTRO	47UF	10WV
C32			CK73FB1H103K	CHIP C	0.010UF	K
C33			CC73FSL1H101J	CHIP C	100PF	J
C34 ,35			CK73FB1H102K	CHIP C	1000PF	K
C36			CC73FCH1H270J	CHIP C	27PF	J
C37			CC73FCH1H220J	CHIP C	22PF	J
C38			CK73FB1H471K	CHIP C	470PF	K
C52			CC73FCH1H470J	CHIP C	47PF	J
C57 -60			CE04LW1H010M	ELECTRO	1.0UF	50WV
C61 ,62			CQ93FMG1H472J	MYLAR	4700PF	J
C63			CC73FCH1H220J	CHIP C	22PF	J
C64			CK73FB1H473K	CHIP C	0.047UF	K
CN1			E40-9831-05	SOCKET FOR PIN ASSY		
J1			E20-0476-05	LOCK TERMINAL BOARD(4P)		
J1			E70-0051-05	LOCK TERMINAL BOARD		
J2			F10-0945-04	SHIELDING PLATE		
CF1 ,2			L72-0531-05	CERAMIC FILTER		
CF3			L72-0593-05	CERAMIC FILTER		
L1			L39-1348-05	COMBINATION COIL		
L2			L30-0911-05	AM IFT		
L3 ,4			L40-1091-17	SMALL FIXED INDUCTOR(1UH)		
X1			L77-1122-05	CRYSTAL RESONATOR(7.2MHZ)		
X2			L78-0637-05	RESONATOR (456KHZ)		
R1			RK73FB2A332J	CHIP R	3.3K	J 1/10W
R2			RK73FB2A681J	CHIP R	680	J 1/10W
R3			RK73FB2A100J	CHIP R	10	J 1/10W
R4 ,5			RK73FB2A331J	CHIP R	330	J 1/10W
R6			RK73FB2A101J	CHIP R	100	J 1/10W
R7			RK73FB2A473J	CHIP R	47K	J 1/10W
R8			RK73FB2A331J	CHIP R	330	J 1/10W
R13			RK73FB2A333J	CHIP R	33K	J 1/10W
R15 ,16			RK73FB2A393J	CHIP R	39K	J 1/10W

L : Scandinavia K : USA P : Canada R : Mexico 5 : C-H5 series
Y : PX(Far East, Hawaii) T : Europe E : Europe G : Germany 6 : C-H6 series
Y : AAFES(Europe) X : Australia M : Other Areas Q : Russia 7 : C-H7

△ indicates safety critical components.

PARTS LIST

C-H5/H51/H5W/H6/H61/H6W/H7

* New Parts
Parts without **Parts No.** are not supplied.
Les articles non mentionnés dans le **Parts No.** ne sont pas fournis.
Teile ohne **Parts No.** werden nicht geliefert.

9

* New Parts
Parts without **Parts No.** are not supplied.
Les articles non mentionnés dans le **Parts No.** ne sont pas fournis.
Teile ohne **Parts No.** werden nicht geliefert.

10

Ref. No	Add-ress	New Parts	Parts No.	Description	Desti-nation	Re-marks
R17			RK73FB2A271J	CHIP R 270 J 1/10W		
R18			RK73FB2A302J	CHIP R 3.0K J 1/10W		
R19			RK73FB2A822J	CHIP R 8.2K J 1/10W		
R21 -23			RK73FB2A102J	CHIP R 1.0K J 1/10W		
R24			RK73FB2A562J	CHIP R 5.6K J 1/10W		
Δ R25			RD14NB2E101J	RD 100 J 1/4W		
Δ R26			RD14NB2E561J	RD 560 J 1/4W		
R27			RK73FB2A102J	CHIP R 1.0K J 1/10W		
R28			RK73FB2A103J	CHIP R 10K J 1/10W		
R29 .30			RK73FB2A102J	CHIP R 1.0K J 1/10W		
R31			RK73FB2A103J	CHIP R 10K J 1/10W		
R32			RK73FB2A122J	CHIP R 1.2K J 1/10W		
R33			RK73FB2A123J	CHIP R 12K J 1/10W		
R41			RS14KB3A181J	FL-PROOF RS 180 J 1W		
R42			RD14NB2E820J	RD 82 J 1/4W		
Δ R43			RD14NB2E221J	RD 220 J 1/4W		
R44			RK73FB2A101J	CHIP R 100 J 1/10W		
R46			RK73FB2A104J	CHIP R 100K J 1/10W		
R47			RK73FB2A153J	CHIP R 15K J 1/10W		
R48			RK73FB2A473J	CHIP R 47K J 1/10W		
R49			RK73FB2A473J	CHIP R 47K J 1/10W	YMI	
R50			RK73FB2A471J	CHIP R 470 J 1/10W	YMI	
R51 -54			RK73FB2A473J	CHIP R 47K J 1/10W		
R55 .56			RK73FB2A154J	CHIP R 150K J 1/10W		
R59 .60			RK73FB2A332J	CHIP R 3.3K J 1/10W		
W101-106			R92-0670-05	CHIP R 0 OHM		
W108-114			R92-0670-05	CHIP R 0 OHM		
W115			R92-0670-05	CHIP R 0 OHM	YMI	
W117, 118			R92-0670-05	CHIP R 0 OHM		
W119			R92-0670-05	CHIP R 0 OHM	YMI	
W203-208			R92-0679-05	CHIP R 0 OHM		
W210,211			R92-0679-05	CHIP R 0 OHM		
S1			S62-0034-05	SLIDE SWITCH	YMI	
D1 .2			HSS104	DIODE		
D1 .2			1SS133	DIODE		
D3 .4			MTZJ5.1(B)	ZENER DIODE		
D3 .4			UZ-5.1BSB	ZENER DIODE		
D8			HSS104	DIODE		
D8			1SS133	DIODE		
D10			MA111	DIODE		
IC1			LA1832	ANALOGUE IC		
IC2			LC72131	MOS-IC		
IC4			NJM4565M	IC(OP AMP X2)		
Q1			2SC2714(R,O)	TRANSISTOR		
Q3			2SA1576A(R,S)	TRANSISTOR		
Q3			2SB1218A(Q,R)	TRANSISTOR		
Q5			2SC4081(R,S)	TRANSISTOR		
Q5			2SD1819A(Q,R)	TRANSISTOR		
Q9 .10			2SC4081(R,S)	TRANSISTOR	YMI	
Q9 .10			2SD1819A(Q,R)	TRANSISTOR	YMI	
A1			W02-2539-05	FM FRONT-END ASSY		

Ref. No	Add-ress	New Parts	Parts No.	Description	Desti-nation	Re-marks
CONTROL (X11-3700-00)						
D232,233			B30-2494-05	LED(GRN)		
C1			CE04KW1H100M	ELECTRO 10UF 50WV		
C2			CE04KW1E222M	ELECTRO 2200UF 25WV		
C3			CE04KW1H100M	ELECTRO 10UF 50WV		
C4			C90-3264-05	ELECTRO 470UF 6.3WV		
C5			CK45FF1H103ZMU	CERAMIC 0.010UF Z		
C6			CK45FB1H152KMU	CERAMIC 1500PF K		
C7			C90-3730-05	ELECTRO 120UF 35WV		
C8			CE04KW1E222M	ELECTRO 2200UF 25WV		
C9			CE04KW1E102M	ELECTRO 1000UF 25WV		
C10			CE04KW1H100M	ELECTRO 10UF 50WV		
C11	67		CE04KW1H100M	ELECTRO 10UF 50WV		
C12,13			CE04KW1H100M	ELECTRO 10UF 50WV		
C14			CQ93FMG1H103J	MYLAR 0.010UF J		
C15			CE04KW1H100M	ELECTRO 10UF 50WV		
C16			CF92FV1H124J	MF-C 0.12UF J		
C17			CE04KW1C101M	ELECTRO 100UF 16WV		
C18-20			CE04KW1H100M	ELECTRO 10UF 50WV		
C21-26			CE04KW1V4R7M	ELECTRO 4.7UF 35WV		
C27,28			CE04KW1V220M	ELECTRO 22UF 35WV		
C29			CE04KW1C221M	ELECTRO 220UF 16WV		
C30-32			CC45FSL1H101JM	CERAMIC 100PF J		
C33-36			CE04KW1V4R7M	ELECTRO 4.7UF 35WV		
C37-40	5		CE04KW1H0R1M	ELECTRO 0.1UF 50WV		
C41,42	5		CQ93FMG1H223J	MYLAR 0.022UF J		
C43,44	5		CQ93FMG1H183J	MYLAR 0.018UF J		
C45			CE04KW1H4R7M	ELECTRO 4.7UF 50WV		
C46			CE04KW1V471M	ELECTRO 470UF 35WV		
C48			CE04KW1H0R1M	ELECTRO 0.1UF 50WV		
C51			CQ93FMG1H472J	MYLAR 4700PF J		
C52,53			CF92FV1H474J	MF-C 0.47UF J		
C54,55	5		CQ93FMG1H562J	MYLAR 5600PF J		
C56,57			CC45FSL1H101JM	CERAMIC 100PF J		
C58	56		CE04KW1H100M	ELECTRO 10UF 50WV		
C59			CE04KW1H100M	ELECTRO 10UF 50WV		
C60	56		CE04KW1H100M	ELECTRO 10UF 50WV		
C61			CE04KW1V470M	ELECTRO 47UF 35WV		
C62	56		CE04KW1H010M	ELECTRO 1.0UF 50WV		
C63-66			CE04KW1H100M	ELECTRO 10UF 50WV		
C67,68			CE04KW1V220M	ELECTRO 22UF 35WV		
C69,70			CQ93FMG1H103J	MYLAR 0.010UF J		
C71,72			CE04KW1C470M	ELECTRO 47UF 16WV		
C73			CE04KW1H100M	ELECTRO 10UF 50WV		
C74			CE04KW1H100M	ELECTRO 10UF 50WV		
C75			CE04HW1H2R2M	NP-ELEC 2.2UF 50WV		KMYIQ
C76			C90-3307-05	ELECTRO 470UF 35WV		
C77			C90-3265-05	ELECTRO 1000UF 6.3WV		
C79,80			CC45FSL1H221JM	CERAMIC 220PF J		
C83,84			CC45FSL1H221JM	CERAMIC 220PF J		
C87,94			CC45FSL1H221JM	CERAMIC 220PF J		
C97,98			CC45FSL1H221JM	CERAMIC 220PF J		
C103,104			CC45FSL1H221JM	CERAMIC 220PF J		

PARTS LIST

C-H5/H51/H5W/H6/H61/H6W/H7

L : Scandinavia K : USA P : Canada R : Mexico 5 : C-H5 series
Y : PX(Far East, Hawaii) T : Europe E : Europe G : Germany 6 : C-H6 series
Y : AAFES(Europe) X : Australia M : Other Areas Q : Russia 7 : C-H7

Δ indicates safety critical components.

L : Scandinavia K : USA P : Canada R : Mexico 5 : C-H5 series
Y : PX(Far East, Hawaii) T : Europe E : Europe G : Germany 6 : C-H6 series
Y : AAFES(Europe) X : Australia M : Other Areas Q : Russia 7 : C-H7

Δ indicates safety critical components.

* New Parts
Parts without **Parts No.** are not supplied.
Les articles non mentionnes dans le **Parts No.** ne sont pas fournis.
Teile ohne **Parts No.** werden nicht geliefert.

11

Table with columns: Ref. No, Add-ress, New Parts, Parts No., Description, Desti-nation, Re-marks. Contains 118 rows of parts data.

* New Parts
Parts without **Parts No.** are not supplied.
Les articles non mentionnes dans le **Parts No.** ne sont pas fournis.
Teile ohne **Parts No.** werden nicht geliefert.

12

Table with columns: Ref. No, Add-ress, New Parts, Parts No., Description, Desti-nation, Re-marks. Contains 118 rows of parts data.

C-H5/H51/H5W/H6/H61/H6W/H7 PARTS LIST

L: Scandinavia K: USA P: Canada R: Mexico 5: C-H5 series
Y: PX(Far East, Hawaii) T: Europe E: Europe G: Germany 6: C-H6 series
Y: AAFES(Europe) X: Australia M: Other Areas Q: Russia 7: C-H7

Δ indicates safety critical components.

L: Scandinavia K: USA P: Canada R: Mexico 5: C-H5 series
Y: PX(Far East, Hawaii) T: Europe E: Europe G: Germany 6: C-H6 series
Y: AAFES(Europe) X: Australia M: Other Areas Q: Russia 7: C-H7

Δ indicates safety critical components.

* New Parts
 Parts without **Parts No.** are not supplied.
 Les articles non mentionnés dans le **Parts No.** ne sont pas fournis.
 Teile ohne **Parts No.** werden nicht geliefert.

13

Ref. No	Add-ress	New Parts	Parts No.	Description	Desti-nation	Re-marks
R83 -85	56		RD14BB2C103J	RD 10K J 1/6W		
R86	56		RD14BB2C222J	RD 2.2K J 1/6W		
R87	56		RD14BB2C102J	RD 1.0K J 1/6W		
R89 .90	56		RD14BB2C103J	RD 10K J 1/6W		
R146	67		RD14BB2C152J	RD 1.5K J 1/6W		
R149.150	67		RD14BB2C104J	RD 100K J 1/6W		
R157.158	67		RD14BB2C104J	RD 100K J 1/6W		
R217			R92-1855-05	RD 10M J 1/6W		
R241-243	67		RD14BB2C104J	RD 100K J 1/6W		
R326-328	67		RD14BB2C102J	RD 1.0K J 1/6W		
R332			RN14BK2C1002F	RN 10.0K F 1/6W		
R410	56		RD14BB2C682J	RD 6.8K J 1/6W	YMI	
R416	56		RD14BB2C473J	RD 47K J 1/6W	YMI	
R417	56		RD14BB2C393J	RD 39K J 1/6W	YMI	
R418	56		RD14BB2C223J	RD 22K J 1/6W	YMI	
R419	56		RD14BB2C683J	RD 68K J 1/6W	YMI	
R420	56		RD14BB2C472J	RD 4.7K J 1/6W	YMI	
R421	56		RD14BB2C103J	RD 10K J 1/6W	YMI	
R422	56		RD14BB2C153J	RD 15K J 1/6W	YMI	
R423	56		RD14BB2C103J	RD 10K J 1/6W	YMI	
R424	56		RD14BB2C822J	RD 8.2K J 1/6W	YMI	
R425.426	56		RD14BB2C223J	RD 22K J 1/6W	YMI	
R427	56		RD14BB2C103J	RD 10K J 1/6W	YMI	
R430	56		RD14BB2C471J	RD 470 J 1/6W	YMI	
R433	56		RD14BB2C104J	RD 100K J 1/6W	YMI	
VR1			R31-0065-05	VARIABLE RESISTOR		
S1 -14			S70-0031-05	TACT SWITCH		
D1			HSS104A	DIODE		
D1			1SS131	DIODE		
D2 -4			S5688B	DIODE		
D2 -4			1SR139-400	DIODE		
D5			MTZJ6.2(B)	ZENER DIODE		
D5			UZ-6.2BSB	ZENER DIODE		
D6			MTZJ11(B)	ZENER DIODE		
D6			UZ-11BSB	ZENER DIODE		
D7			MTZJ16(B)	ZENER DIODE		
D7			UZ-16BSB	ZENER DIODE		
D8			D1NL20U	DIODE		
D9			MTZJ11(B)	ZENER DIODE		
D9			UZ-11BSB	ZENER DIODE		
D10	67		MTZJ4.7(B)	ZENER DIODE		
D10	67		UZ-4.7BSB	ZENER DIODE		
D11 -14	56		HSS104A	DIODE		
D11 -14	56		1SS131	DIODE		
D16			MTZJ3.9(B)	ZENER DIODE		
D16			UZ-3.9BSB	ZENER DIODE		
D17	56		MTZJ4.7(B)	ZENER DIODE		
D17	56		UZ-4.7BSB	ZENER DIODE		
D18			MTZJ6.2(B)	ZENER DIODE		
D18			UZ-6.2BSB	ZENER DIODE		
D19			MTZJ4.7(B)	ZENER DIODE		
D19			UZ-4.7BSB	ZENER DIODE		
D20 .21			HSS104A	DIODE		

L : Scandinavia K : USA P : Canada R : Mexico 5 : C-H5 series
 Y : PX(Far East, Hawaii) T : Europe E : Europe G : Germany 6 : C-H6 series
 Y : AAFES(Europe) X : Australia M : Other Areas Q : Russia 7 : C-H7

Δ indicates safety critical components.

* New Parts
 Parts without **Parts No.** are not supplied.
 Les articles non mentionnés dans le **Parts No.** ne sont pas fournis.
 Teile ohne **Parts No.** werden nicht geliefert.

14

Ref. No	Add-ress	New Parts	Parts No.	Description	Desti-nation	Re-marks
D20 .21			1SS131	DIODE		
D22			MTZJ16(B)	ZENER DIODE		
D22			UZ-16BSB	ZENER DIODE		
D23			MTZJ4.7(B)	ZENER DIODE		
D23			UZ-4.7BSB	ZENER DIODE		
D24			HSS104A	DIODE		
D24			1SS131	DIODE		
D201-209			HSS104A	DIODE		
D201-209			1SS131	DIODE		
D211-223			HSS104A	DIODE		
D211-223			1SS131	DIODE		
D225			HSS104A	DIODE		YMI
D225			1SS131	DIODE		YMI
D226	5		HSS104A	DIODE		
D226	5		1SS131	DIODE		
D227	6		HSS104A	DIODE		
D227	6		1SS131	DIODE		
D228	7		HSS104A	DIODE		KM
D228	7		1SS131	DIODE		KM
D229	7		HSS104A	DIODE		TEQ
D229	7		1SS131	DIODE		TEQ
D230			HSS104A	DIODE		TQ
D230			1SS131	DIODE		TQ
D231			HSS104A	DIODE		KMYIEQ
D231			1SS131	DIODE		KMYIEQ
D234-237			HSS104A	DIODE		
D234-237			1SS131	DIODE		
D239,240			HSS104A	DIODE		
D239,240			1SS131	DIODE		
D401,402			HSS104A	DIODE		
D401,402			1SS131	DIODE		
D404,405			MTZJ2.0(B)	ZENER DIODE		
D404,405			UZ-2.0BSB	ZENER DIODE		
D406			MTZJ4.7(B)	ZENER DIODE		
D406			UZ-4.7BSB	ZENER DIODE		
D407-410			MTZJ3.9(B)	ZENER DIODE		
D407-410			UZ-3.9BSB	ZENER DIODE		
ED2			BJ510GK	INDICATOR TUBE		
IC1			TDA7466	ANALOGUE IC		
IC2			BU4052BC	MOS-IC		
IC2			TC4052BP	IC(4CH MPX/DE-MPX)		
IC3			BU4066BC	ANALOGUE IC		
IC3			TC4066BP	IC(ANALOG/ DIGITAL SW)		
IC4 .5			NJM4580D-D	IC(OP AMP X2)		
IC6			BA15218-DX	IC(OP AMP X2)		
IC8			M62431FP	ANALOGUE IC		
IC201	6		M38198MCA803FP	MI-COM IC		
IC202			S-806D-Z	ANALOGUE IC		
IC203			BA3834S	ANALOGUE IC		
IC204			SAA6579	ANALOGUE IC		EQT
IC205	56		BU9253AS	MOS-IC		YMI
IC206			NJM4565L-D	ANALOGUE IC		YMI
Q1			2SD2012	TRANSISTOR		
Q1			2SD2061	TRANSISTOR		
Q2			2SC1740S(Q,R)	TRANSISTOR		

L : Scandinavia K : USA P : Canada R : Mexico 5 : C-H5 series
 Y : PX(Far East, Hawaii) T : Europe E : Europe G : Germany 6 : C-H6 series
 Y : AAFES(Europe) X : Australia M : Other Areas Q : Russia 7 : C-H7

Δ indicates safety critical components.

PARTS LIST

C-H5/H51/H5W/H6/H61/H6W/H7

C-H5/H51/H5W/H6/H61/H6W/H7

PARTS LIST

15

* New Parts
Parts without **Parts No.** are not supplied.
Les articles non mentionnés dans le **Parts No.** ne sont pas fournis.
Teile ohne **Parts No.** werden nicht geliefert.

Ref. No	Add-ress	New Parts	Parts No.	Description	Desti-nation	Re-marks
Q2			2SC2785(FE)	TRANSISTOR		
Q3			2SA954(L,K)	TRANSISTOR		
Q4			2SA1175(FE)	TRANSISTOR		
Q5			2SA933AS(Q,R)	TRANSISTOR		
Q6			2SD2137(P)	TRANSISTOR		
Q7			2SD2525	TRANSISTOR		
Q8			2SA1534A(R,S)	DIGITAL TRANSISTOR		
Q9			DTC113ZSA	DIGITAL TRANSISTOR		
Q10			UN4219	TRANSISTOR		
Q11			2SA1175(FE)	TRANSISTOR		
Q12			2SA933AS(Q,R)	TRANSISTOR		
Q13			2SC3940A(R,S)	TRANSISTOR		
Q14			2SB1168(S,T)	TRANSISTOR		
Q15			2SC1740S(Q,R)	TRANSISTOR		
Q16			2SC2785(FE)	TRANSISTOR		
Q17			2SA1175(FE)	TRANSISTOR		
Q201-203			2SA933AS(Q,R)	TRANSISTOR		
Q204			2SC3940A(R,S)	TRANSISTOR		
Q205-207		67	2SA1175(FE)	TRANSISTOR	YMI	
Q208			2SC1740S(Q,R)	TRANSISTOR	YMI	
Q209		67	2SC2785(FE)	TRANSISTOR		
Q210			2SC1740S(Q,R)	TRANSISTOR		
Q211			2SC2785(FE)	TRANSISTOR		
A1			W02-2561-05	ELECTRIC CIRCUIT MODULE		

L : Scandinavia
Y : PX(Far East, Hawaii)
Y : AAFES(Europe)

K : USA
T : Europe
X : Australia

P : Canada
E : Europe
M : Other Areas

R : Mexico
G : Germany
Q : Russia

5 : C-H5 series
6 : C-H6 series
7 : C-H7

Δ indicates safety critical components.

SPECIFICATIONS

[FM Tuner section]

Tuning frequency range87.5 MHz ~ 108MHz
Sensitivity (DIN at 75 Ω)
MONO.....1.8μV / 16.2 dBf

[MW (AM) Tuner section]

Tuning frequency range531 kHz ~ 1,602 kHz

[LW Tuner section]

Tuning frequency range153 kHz ~ 279 kHz

[Amplifier section]

Signal to noise ratio
Line (AUX).....90 dB (1HF'A)

Input sensitivity / Impedance

Line (AUX, MD)

.....200 mV / 47 kΩ (SOURCE DIRECT ON)

Output level / Impedance

SUPER WOOFER PRE OUT

.....2.0 V / 2.2 kΩ (SOURCE DIRECT ON)

TAPE or MD REC200 mV / 2.2 kΩ

[General]

Dimension.....W : 270 mm

H : 119 mm

D : 322 mm

Weight (net)2.1 kg



1. KENWOOD follows a policy of continuous advancements in development. For this reason specifications may be changed without notice.
2. Sufficient performance may not be exhibited at extremely cold locations (where water freezes).

Note:

Component and circuit are subject to modification to insure best operation under differing local conditions. This manual is based on Europe (E) standard, and provides information on regional circuit modification through use of alternate schematic diagrams, and information on regional component variations through use of parts list.

KENWOOD CORPORATION

14-6,Dogenzaka 1-chome, Shibuya-ku, Tokyo, 150 Japan

KENWOOD SERVICE CORPORATION

P.O BOX 22745, 2201 East Dominguez St., Long Beach, CA 90801-5745, U.S.A.