

DPC-781/782/981

SERVICE MANUAL

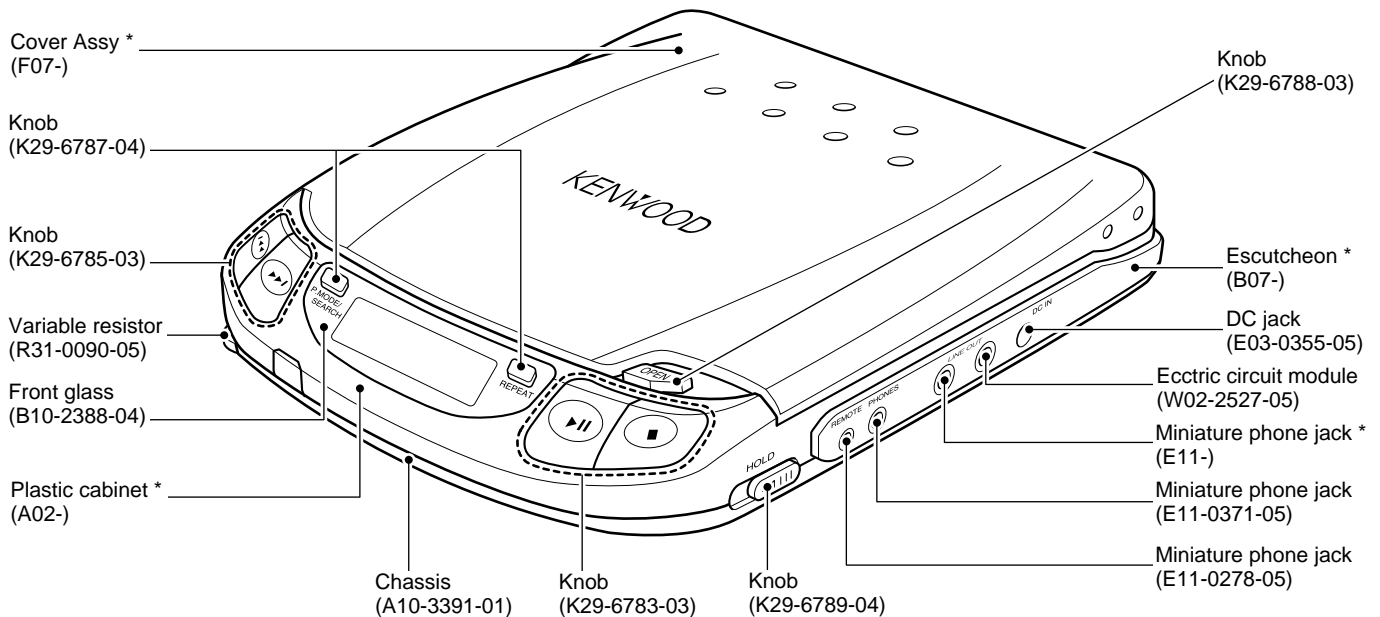

* Refer to parts list on page 15.

SPECIFICATIONS

Format

System.....Compact disc digital audio system
 Laser.....Semiconductor laser

Audio

Frequency response.....20 Hz ~ 20 kHz, ±3 dB
 Headphone output (16 Ω, 1 kHz).....10 mW + 10 mW
 (Headphone output level / impedance.....max. 450 mV / 2.2 Ω)

[For CHINA and Duty Free Shop in JAPAN]

Digital output optical.....-21 dBm ~ -15 dBm (wave lenght 660nm)

[For other countries]

LINE output level / impedance.....550 mV / 702 Ω

Power supply

External DC supply.....DC 4.5 ~ 6 V
 Rechargeable batteries.....DC 2.4 V
 Commercially - available alkaline batteries.....DC 3 V

Battery life (continuous playback) Repeat playback stops after 16 times.

(Figures inside parentheses are the values when D.A.S.C. is ON.)

Commercially-available alkaline batteries (LR6 / AA) x 4.....Approx. 40 (34) hours
 Commercially-available alkaline batteries (LR6 / AA) x 2.....Approx. 18.5 (17) hours
 Rechargeable batteries (NB - 130) x 2.....Approx. 9.0 (8.0) hours
 With 2 commercially-available alkaline batteries and rechargeable batteries.....Approx. 27.5 (25) hours

Dimensions (W x H x D).....133.6 mm x 26.5 mm x 151.8 mm

Weight (net).....270 g (9.5 oz.)



1. KENWOOD follows a policy of continuous advancements in development. For this reason specifications may be changed without notice.
2. Sufficient performance may not be exhibited at extremely cold locations (where water freezes.).

In compliance with Federal Regulations, following are reproductions of labels on, or inside the product relating to laser product safety.

KENWOOD-Crop. certifies this equipment conforms to DHHS Regulations No. 21 DFR 1040. 10, Chapter 1, Subchapter J.

DANGER : Laser radiation when open and interlock defeated. AVOID DIRECT EXPOSURE TO BEAM

DPC-781/782/981

CONTENTS/ACCESSORIES

CONTENTS

SPECIFICATIONS	Top cover	SCHMATIC DIAGRAM	7
CONTENTS/ACCESSORIES	2	EXPLODED VIEW	13
ADJUSTMENT	3	PARTS LIST	15
PC BOARD	5		

Accessories

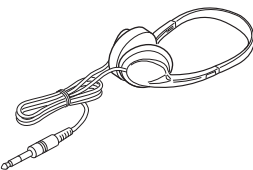
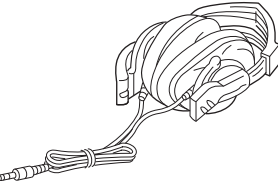
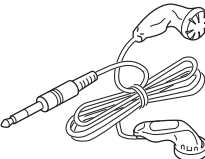
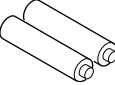
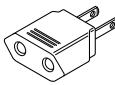
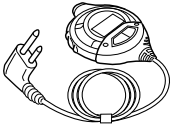
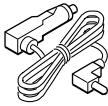
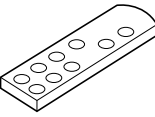
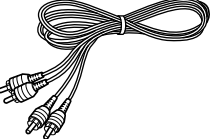
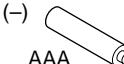
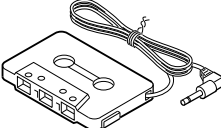
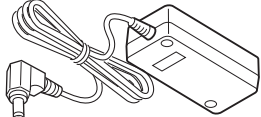
<p>Stereo headphone (1) (W01-0924-05) DPC-782</p> 	<p>Stereo headphone (1) (W01-0946-05) DPC-981 M type (W01-0947-05) DPC-981 K,P type (W01-0954-05) DPC-981 T,E type</p> 	<p>Stereo headphone (1) (W01-0923-05) DPC-981 M type DPC-781 M type DPC-782 X type</p> 	
<p>Rechargeable battery (2) option : NB -130 (W09-1237-05)</p> 	<p>AC plug adaptor (1) (E03-0115-05) M type</p> 	<p>Remote control (1) (A70-1171-05) DPC-981 M type DPC-781 M type (A70-1190-05) DPC-782 X type</p> 	<p>Car battery adaptor (1) (W01-0921-05) DPC-782</p> 
<p>Remote controller assy (1) (A70-1037-05) DPC-782 DPC-981 K,P type</p> 	<p>Audio cord (E30-2782-05) DPC981 T,E type</p> 	<p>Battery (1) DPC-981 AAA</p> 	<p>Cassette adaptor (1) (W01-0922-05) DPC-782</p> 
<p>AC adaptor (1) (W08-0658-05) E type (W08-0659-05) T type (W08-0660-05) X type (W08-0667-05) M type (W09-1251-05) K, P type</p> 			

DPC-781/782/981

ADJUSTMENT

1. Test Mode

1-1 Setting the test mode

This model can be set to the test mode by shorting the test-land of the X32 board.

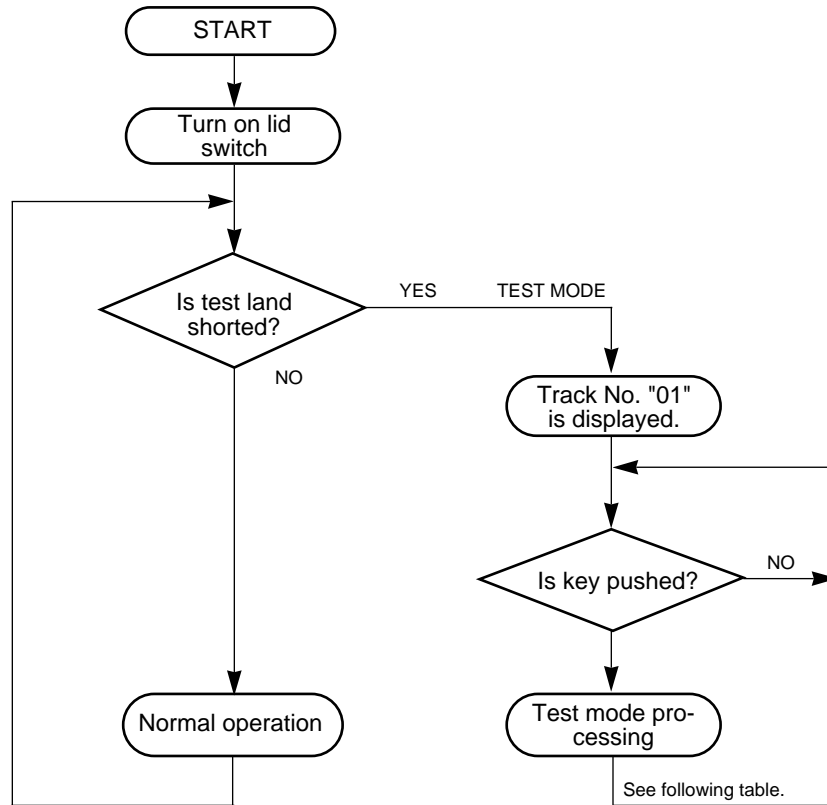

1-2 Key and functions avild in test mode

No.	Mode	Key Name	Function	TRACK No. display
1	05	PLAY/PAUSE (▶/)	1. Focus servo.....ON 2. Tracking servo.....ON 3. Feed servoON Absolute time at position of limit SW is displayed in time area, then play is started.	05 After 1, 2 and 3 are finished, track No. played currently and its play time are indicated.
2	03	UP (▶▶)	1. Focus servo.....ON 2. Tracking servo.....OFF 3. Feed servoOFF	03
3	01	STOP (■)	1. Focus servo.....OFF 2. Tracking servo.....OFF 3. Feed servoOFF ❖ Test mode can be can celled while pressing the STOP (■) Key in 01 mode.	01
4	While pressing the P. MODE/SEARCH Key, turn the AC ON		All LCD is turned ON for 2 seconds. ↓ All LCD is turned OFF for 2 seconds. ↓ Returned to normal mode.	—

DPC-781/782/981

ADJUSTMENT

No.	ITEM	INPUT SETTING	OUTPUT SETTING	PLAYER SETTING	ALIGNMENT POINT	ALIGN FOR	FIG.
1	LASER POWER	-	Apply the sensor section of optical power meter on the pickup lens.	Short the test land. Confirm that the display is "03". Press FF Key and confirm that the display is 03.	-	On the power from 0.08 to 0.15 mW, when the diffraction grating is correctly aligned with the RF level of 1.0 Vp-p or more.	-
2	FOCUS ERROR	Test disc KTD-03	Connect an oscilloscope as follows. CH1:RF (Check-land RF) CH2:T1 (Check-land TE1)	Press the PLAY key . Confirm that the display is "05".	FE BALANCE VR3	Optimum eye pattern	-
3	TRACKING ERROR	Test disc KTD-03	Connect an oscilloscope as follows. CH1:RF (Check-land RF) CH2:T1 (Check-land TE1)	Press the FF key. Confirm that the display is "05".	TE BALANCE VR5	Symmetry between upper and lower	-
4	FOCUS GAIN	Test disc KTD-03 Apply signal of 1.0kHz, 0.05Vrms between Check-land F1 and F2.	Connect a LPF between Check-land F1 and F2 to which connect an oscilloscope or AC voltmeters.	Press the PLAY key . Confirm that the display is "05".	FOCUS GAIN VR4	Two VTVMs should read the same value.	(d)
5	TRACKING GAIN	Test disc KTD-03 Apply signal of 1.0kHz, 0.05Vrms between Check-land T1 and T2.	Connect a LPF between Check-land T1 and T2 to which connect an oscilloscope or AC voltmeters.	Press the PLAY key . Confirm that the display is "05".	TRACKING GAIN VR6	Two VTVMs should read the same value.	(e)

Note: Test DISC KTD-03, TCD-783 or equivalent

LPF : Around 47kΩ + 390 pF or so.

Step 1~5 are in Test Mode.

(d) Focus Gain

Two VTVMs should read the same value.

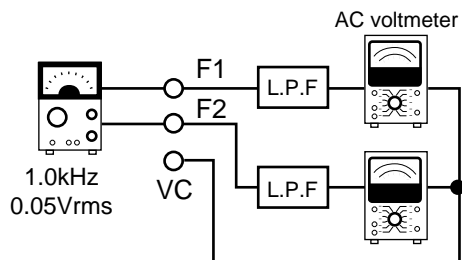

(e) Tracking Gain

Two VTVMs should read the same value.

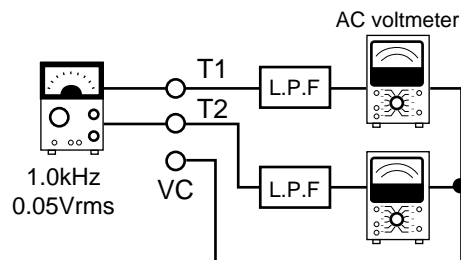

PC BOARD(Component side view)

1
2
3
4
5
6
7

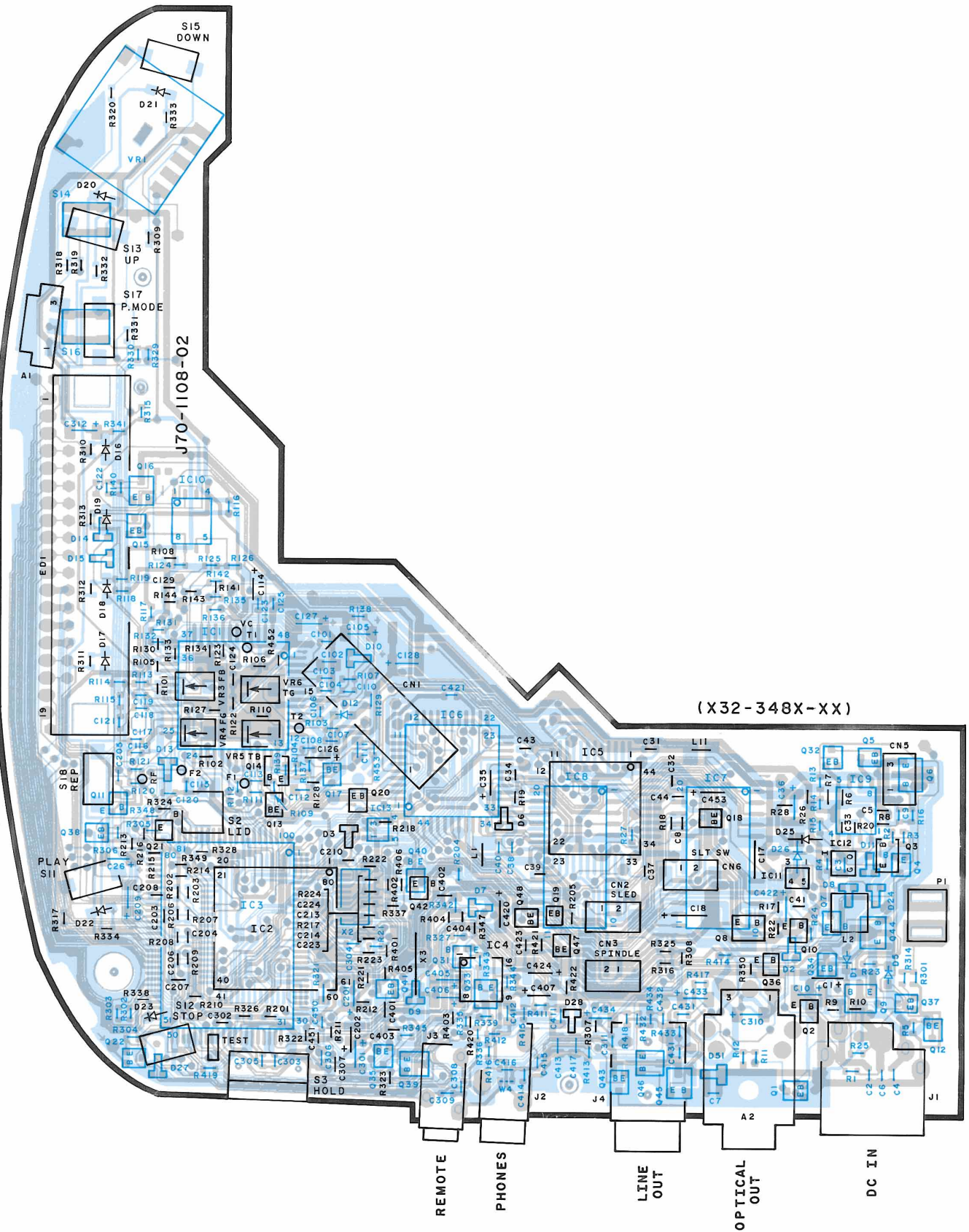

Refer to the schematic diagram for the value of resistors and capacitors.

PC BOARD(Foil side view)

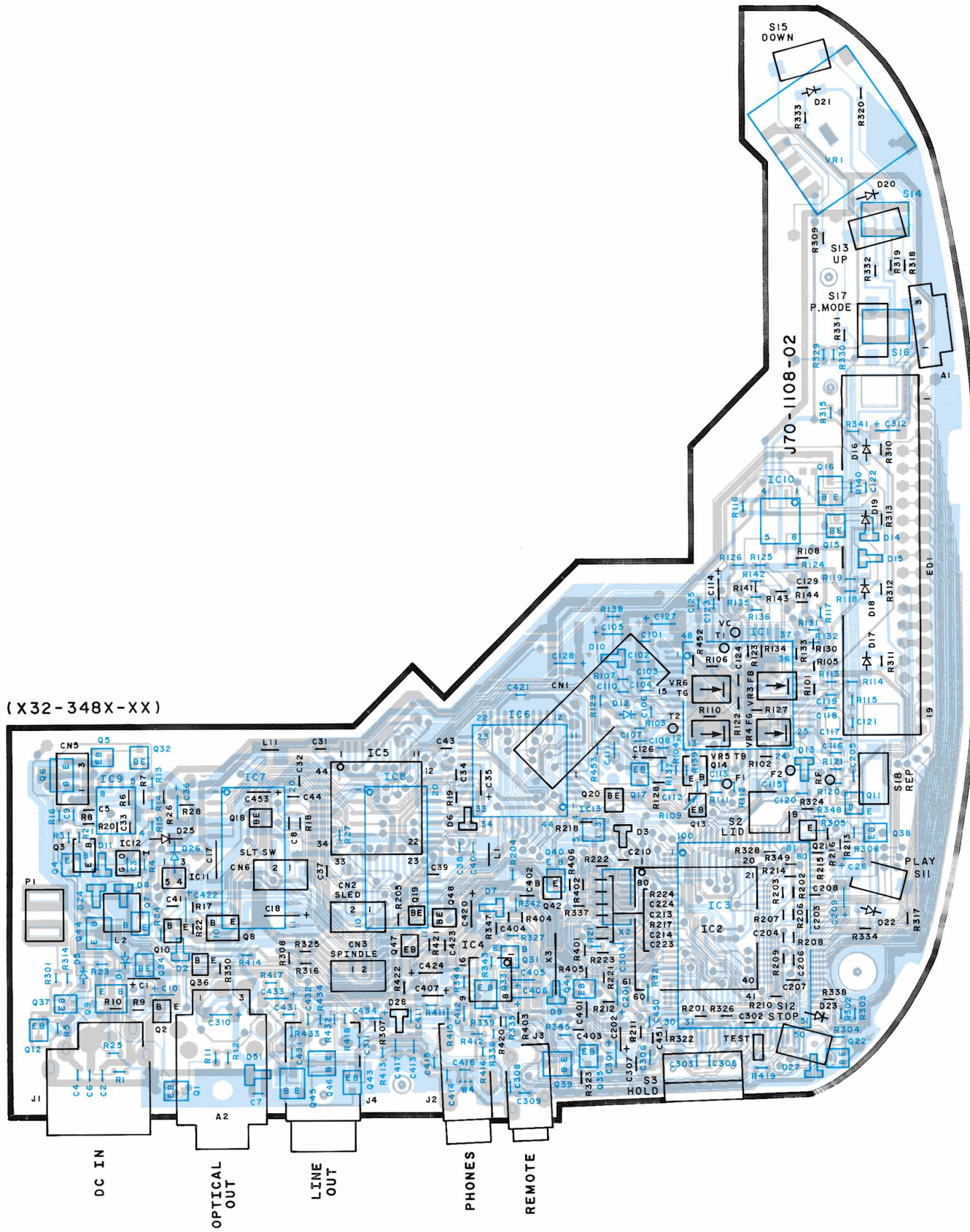

(X32-348X-XX)

Refer to the schematic diagram for the value of resistors and capacitors.

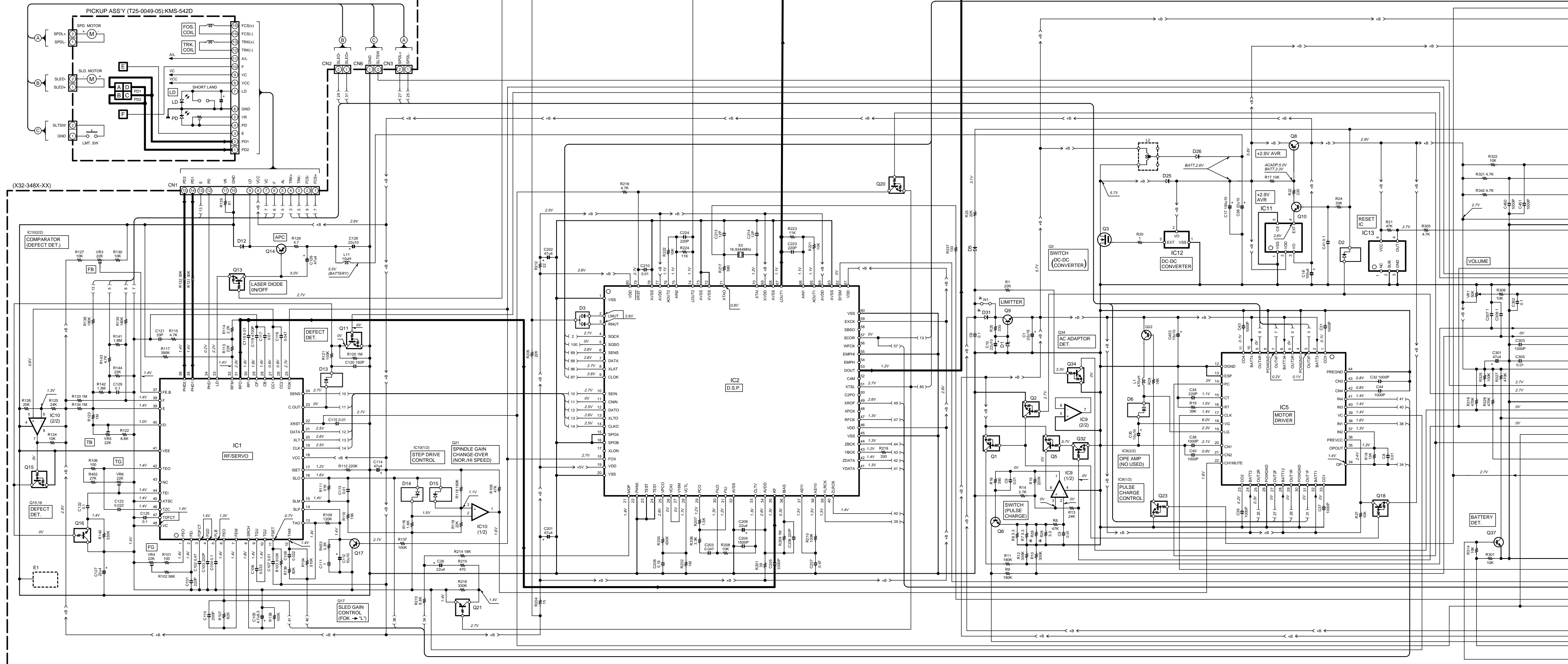

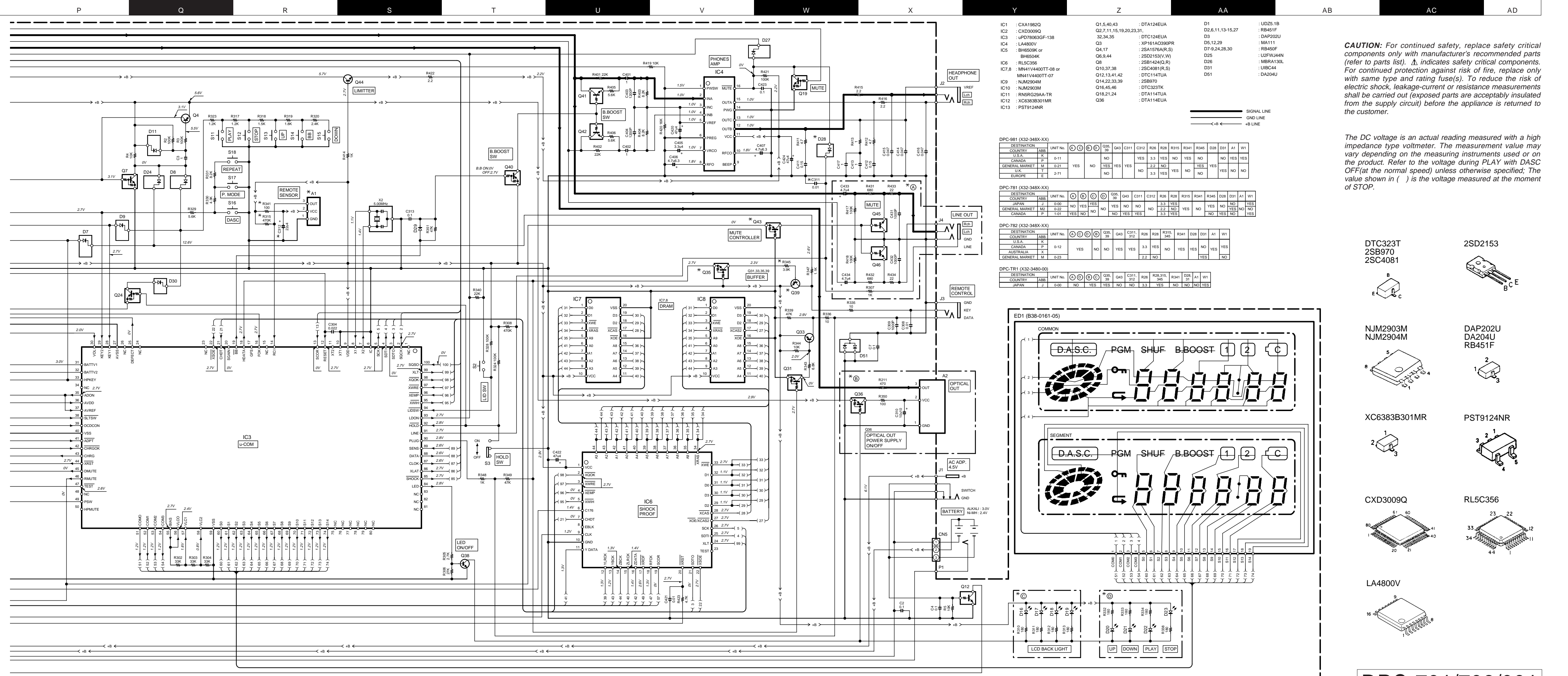

IC1 : CX1982Q	Q15,40,43	:DTA124EUA	D1	:UD25.1B
IC2 : CXD3009Q	Q2,7,11,15,19,20,23,31,	32,34,35	D2,6,11,13-15,27	:RB451F
IC3 : uPD78063GF-138	Q3	:DTC124EUA	D3	:DAP202U
IC4 : LA4800V	Q4,17	:XP161A0390PR	D5,12,29	:MA111
IC5 : BH6509K or	Q6,9,44	:25A1576A(R,S)	D7-9,24,28,30	:RB450F
BH6504K	Q8	:25B1424Q(R)	D25	:U2FWJ44N
IC6 : RL5C356	Q10,37,38	:25C4081(R,S)	D26	:MBRA130L
IC7,8 : MN41V4400TT-08 or	Q12,13,41,42	:DTC114TUA	D31	:UIBC44
MN41V4400TT-07	Q14,22,33,39	:25B970	D51	:DA204U
IC9 : NJM2904M	Q16,45,46	:DTC323TK		
IC10 : NJM2903M	Q18,21,24	:DTA114TUA		
IC11 : RN5RG29AA-TR	Q36	:DTA114EUA		
IC12 : XC6383B301MR				
IC13 : PST9124NR				

DPC-981 (X32-348X-XX)

DESTINATION	UNIT No.	(A)	(B)	(C)	(D)	(E)	Q35, 39	Q43	C311	C312	R26	R28	R315	R341	R345	D28	D31	A1	W1
U.S.A.	K						NO	NO	YES	YES	3.3	YES	NO	YES	NO	NO	NO	YES	YES
CANADA	F	0-11					NO	NO	YES	NO	2.2	NO	NO	NO	NO	NO	NO	NO	NO
GENERAL MARKET	M	0-21					NO	NO	YES	NO	3.3	NO	NO	NO	NO	NO	NO	NO	NO
J.A.K.	T						NO	NO	YES	NO	2.2	NO	NO	NO	NO	NO	NO	NO	NO
EUROPE	E	2-71					NO	NO	YES	NO	3.3	YES	NO	NO	NO	NO	NO	NO	NO

DPC-781 (X32-348X-XX)

DESTINATION	UNIT No.	(A)	(B)	(C)	(D)	(E)	Q35, 39	Q43	C311	C312	R26	R28	R315	R341	R345	D28	D31	A1	W1
JAPAN	J	0-00					NO	NO	YES	NO	NO	NO	NO	NO	NO	NO	NO	NO	NO
CANADA	F	0-22					NO	NO	YES	NO	2.2	NO	NO	NO	NO	NO	NO	NO	NO
GENERAL MARKET	M	0-21					NO	NO	YES	NO	3.3	NO	NO	NO	NO	NO	NO	NO	NO
CANADA	F	1-01					YES	NO	NO	NO	2.2	NO	NO	NO	NO	NO	NO	NO	NO

DPC-782 (X32-348X-XX)

DESTINATION	UNIT No.	(A)	(B)	(C)	(D)	(E)	Q35, 39	Q43	C311	C312	R26	R28	R315	R341	R345	D28	D31	A1	W1
U.S.A.	K						NO	NO	YES	YES	3.3	YES	NO	YES	NO	NO	NO	NO	NO
CANADA	F	0-12					NO	NO	NO	NO	2.2	NO	NO	NO	NO	NO	NO	NO	NO
AUSTRALIA	X						YES	NO	NO	NO	3.3	NO	NO	YES	NO	NO	NO	NO	NO
GENERAL MARKET	M	0-23					NO	NO	NO	NO	2.2	NO	NO	NO	NO	NO	NO	NO	NO

DPC-TR1 (X32-3480-00)

DESTINATION	UNIT No.	(A)	(B)	(C)	(D)	(E)	Q35, 39	Q43	C311	C312	R26	R28	R315	R341	R345	D28	D31	A1	W1
JAPAN	J	0-00					NO	NO	YES	NO	NO	NO	NO	NO	NO	NO	NO	NO	NO

CAUTION: For continued safety, replace safety critical components only with manufacturer's recommended parts (refer to parts list). Δ indicates safety critical components. For continued protection against risk of fire, replace only with same type and rating fuse(s). To reduce the risk of electric shock, leakage-current or resistance measurements shall be carried out (exposed parts are acceptably insulated from the supply circuit) before the appliance is returned to the customer.

The DC voltage is an actual reading measured with a high impedance type voltmeter. The measurement value may vary depending on the measuring instruments used or on the product. Refer to the voltage during PLAY with DASC OFF (at the normal speed) unless otherwise specified; The value shown in () is the voltage measured at the moment of STOP.

- DTC323T
- 2SD2153
- 2SB970
-
- 2SC4081
-
- NJM2903M
- DAP202U
- NJM2904M
- DA204U
-
- XC6383B301MR
- PST9124NR
-
-
- CXD3009Q
- RL5C356
-
- LA4800V
-

DPC-781/782/981

Y22-7460-11

DPC-781/782/981

EXPLODED VIEW (MECHANISM)

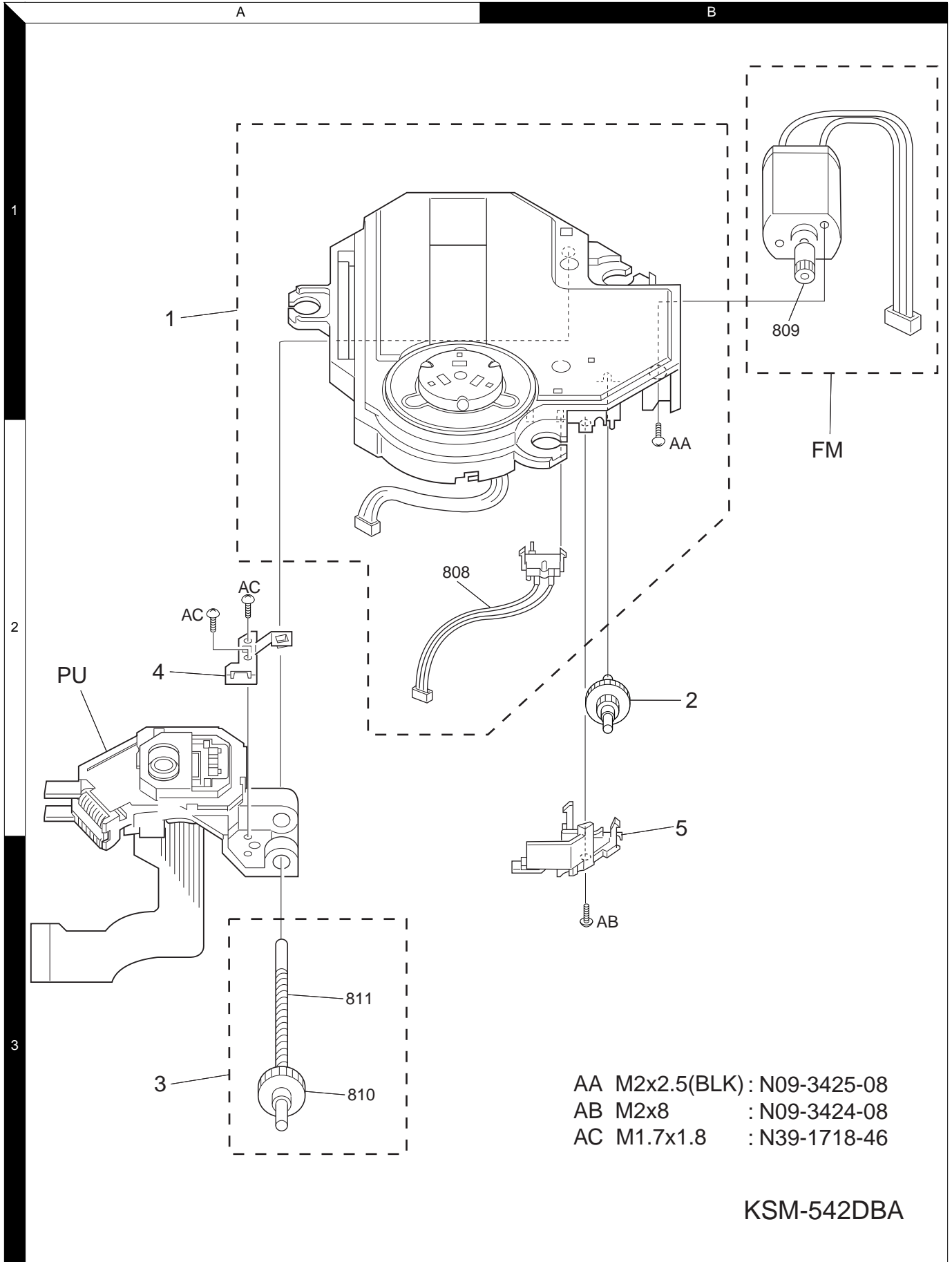

Parts with exploded view numbers larger than 700 are not supplied.

DPC-781/782/981

EXPLODED VIEW (UNIT)

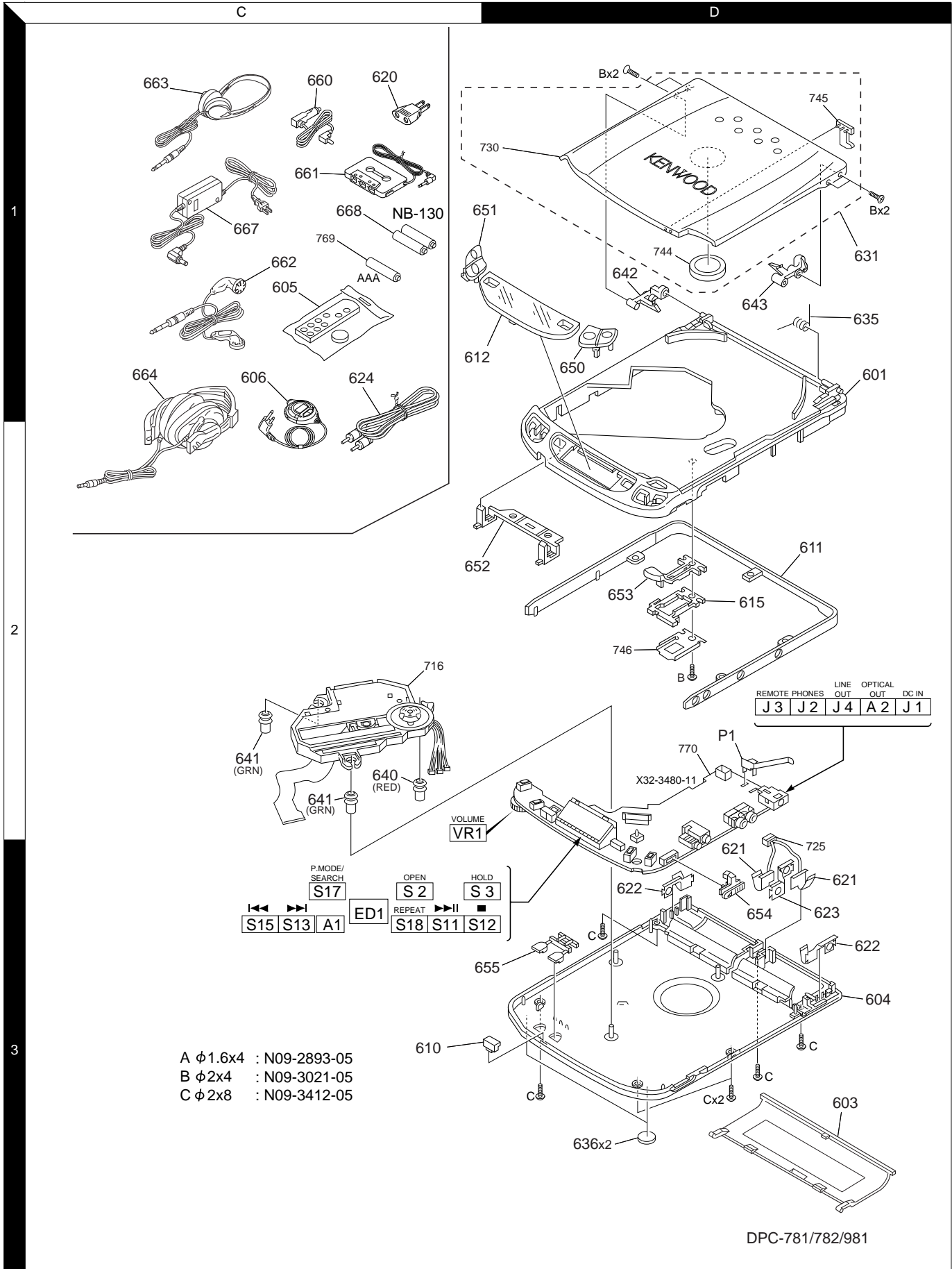

* New Parts
 Parts without **Parts No.** are not supplied.
 Les articles non mentionnés dans le **Parts No.** ne sont pas fournis.
 Teile ohne **Parts No.** werden nicht geliefert.

1

Ref. No	Add-ress	New Parts	Parts No.	Description	Desti-nation	Re-marks
DPC-781/782/981						
601	1D	*	A02-1367-01	PLASTIC CABINET	M9T9E9	
601	1D	*	A02-1367-01	PLASTIC CABINET	P1M1	
601	1D	*	A02-1369-01	PLASTIC CABINET	K2M2P2	
601	1D	*	A02-1369-01	PLASTIC CABINET	K9P9X2	
603	3D	*	A09-0382-03	BATTERY COVER		
604	3D	*	A10-3391-01	CHASSIS		
605	1C	*	A70-1037-05	REMOTE CONTROLLER ASSY	K2M2P2	
605	1C	*	A70-1037-05	REMOTE CONTROLLER ASSY	K9P9X2	
606	1C	*	A70-1171-05	REMOTE CONTROLLER ASSY	M9M1	
606	1C	*	A70-1190-05	REMOTE CONTROLLER ASSY	X2	
610	3C	*	B03-3812-04	DRESSING PLATE	K2M2P2	
610	3C	*	B03-3812-04	DRESSING PLATE	K9P9X2	
611	2D	*	B07-2382-02	ESCUTCHEON	M1	
611	2D	*	B07-2383-02	ESCUTCHEON	K9P9M9	
611	2D	*	B07-2383-02	ESCUTCHEON	P2	
611	2D	*	B07-2383-02	ESCUTCHEON	T9E9P1	
611	2D	*	B07-2383-02	ESCUTCHEON	X2K2M2	
612	1C	*	B10-2388-04	FRONT GLASS		
-	-	-	B46-0100-40	WARRANTY CARD	T9E9X2	
-	-	-	B46-0197-00	QUESTIONNAIRE CARD	K9K2	
-	-	-	B46-0328-03	WARRANTY CARD	K9K2	
-	-	-	B46-0336-03	WARRANTY CARD	P9P1P2	
-	-	-	B60-3105-00	INSTRUCTION MANUAL	P2	
-	-	-	B60-3105-00	INSTRUCTION MANUAL	X2K2M2	
-	-	*	B60-3427-00	INSTRUCTION MANUAL(FRENCH)	K2P2	
-	-	*	B60-3427-00	INSTRUCTION MANUAL(FRENCH)	K9P9P1	
-	-	*	B60-3428-00	INSTRUCTION MANUAL	M2X2	
-	-	*	B60-3428-00	INSTRUCTION MANUAL	M9T9M1	
-	-	*	B60-3429-00	INSTRUCTION MANUAL(FRENCH)	P2	
-	-	*	B60-3429-00	INSTRUCTION MANUAL(FRENCH)	P9E9P1	
-	-	*	B60-3430-00	INSTRUCTION MANUAL(GERMAN)	E9	
-	-	*	B60-3431-00	INSTRUCTION MANUAL(DUTCH)	E9	
-	-	*	B60-3432-00	INSTRUCTION MANUAL(ITALIAN)	E9	
-	-	*	B60-3433-00	INSTRUCTION MANUAL(SPANISH)	M9E9M2	
-	-	*	B60-3434-00	INSTRUCTION MANUAL(TAIWANESE)	M9M1M2	
-	-	*	B60-3595-00	INSTRUCTION MANUAL	K9P9M9	
-	-	*	B60-3595-00	INSTRUCTION MANUAL	T9	
-	-	*	B60-3596-00	INSTRUCTION MANUAL	E9	
615	2D	*	D10-3758-04	LEVER		
620	1C	*	E03-0115-05	AC PLUG ADAPTER	M9M1M2	
621	3D	*	E23-1702-04	TERMINAL		
622	3D	*	E23-1732-04	TERMINAL		
623	3D	*	E23-1750-04	TERMINAL		
624	1C	*	E30-2782-05	AUDIO CORD	T9E9	
631	1D	*	F07-1633-03	COVER ASSY	T9E9	
631	1D	*	F07-1634-03	COVER ASSY	P1M1	
631	1D	*	F07-1635-02	COVER ASSY	P2	
631	1D	*	F07-1635-02	COVER ASSY	X2K2M2	
631	1D	*	F07-1633-03	COVER ASSY	K9P9M9	
635	1D	*	G01-4023-04	TORSION COIL SPRING		
636	3D	*	G13-0552-04	CUSHION		

L : Scandinavia K : USA P : Canada R : Mexico
 Y : PX(Far East, Hawaii) T : Europe E : Europe G : Germany
 Y : AAFES(Europe) X : Australia M : Other Areas

△ indicates safety critical components.

* New Parts
 Parts without **Parts No.** are not supplied.
 Les articles non mentionnés dans le **Parts No.** ne sont pas fournis.
 Teile ohne **Parts No.** werden nicht geliefert.

2

Ref. No	Add-ress	New Parts	Parts No.	Description	Desti-nation	Re-marks
-	-	*	H25-0336-04	PROTECTION BAG		
-	-	*	H25-1588-04	PROTECTION BAG		
-	-	*	H50-2682-03	ITEM CARTON CASE	K2P2	
-	-	*	H50-2683-03	ITEM CARTON CASE	M2	
-	-	*	H50-2684-03	ITEM CARTON CASE	X2	
-	-	*	H50-2686-03	ITEM CARTON CASE	K9P9	
-	-	*	H50-2687-03	ITEM CARTON CASE	T9E9	
-	-	*	H50-2689-03	ITEM CARTON CASE	P1	
-	-	*	H50-2690-03	ITEM CARTON CASE	M1	
-	-	*	H50-2743-03	ITEM CARTON CASE	M9	
640	2C	*	J02-1161-05	INSULATOR		
641	2C	*	J02-1199-05	INSULATOR		
642	1D	*	J19-5853-04	HOLDER		
643	1D	*	J19-5854-04	HOLDER		
650	1D	*	K29-6783-03	KNOB		
651	1C	*	K29-6785-03	KNOB		
652	2C	*	K29-6787-04	KNOB		
653	2D	*	K29-6788-03	KNOB		
654	3D	*	K29-6789-04	KNOB		
655	3C	*	K29-6790-04	KNOB		
660	1C	*	W01-0921-05	ADAPTER	P2	
660	1C	*	W01-0921-05	ADAPTER	X2K2M2	
661	1C	*	W01-0922-05	ADAPTER	P2	
661	1C	*	W01-0922-05	ADAPTER	X2K2M2	
662	1C	*	W01-0923-05	STEREO HEADPHONE(INNER)	M9M1X2	
663	1C	*	W01-0924-05	STEREO HEADPHONE	M2	
663	1C	*	W01-0924-05	STEREO HEADPHONE	P1K2P2	
664	1C	*	W01-0946-05	STEREO HEADPHONE	M9	
664	1C	*	W01-0947-05	STEREO HEADPHONE	K9P9	
664	1C	*	W01-0954-05	STEREO HEADPHONE	T9E9	
△ 667	1C	*	W08-0658-05	AC ADAPTER	E9	
△ 667	1C	*	W08-0659-05	AC ADAPTER	T9	
△ 667	1C	*	W08-0660-05	AC ADAPTER	X2	
△ 667	1C	*	W08-0667-05	AC ADAPTER	M9M1M2	
△ 667	1C	*	W09-1251-05	AC ADAPTOR	K2P2	
△ 667	1C	*	W09-1251-05	AC ADAPTOR	K9P9P1	
668	1C	*	W09-1237-05	BATTERY	NB -130	
CONTROL(X32-3480-11)						
-	-	*	B11-0358-04	OPTICAL DIFFUSER	K2M2P2	
-	-	*	B11-0358-04	OPTICAL DIFFUSER	K9P9M9	
-	-	*	B11-0358-04	OPTICAL DIFFUSER	T9E9X2	
D16 -19	-	*	B30-2473-05	LED	K9P9M9	
D16 -19	-	*	B30-2473-05	LED	T9E9	
D16 -23	-	*	B30-2473-05	LED	P2	
D16 -23	-	*	B30-2473-05	LED	X2K2M2	
ED1	-	*	B38-0161-05	LIQUID CRYSTAL		
C1	-	*	C92-0038-05	CHIP-ELE	22UF	16WV
C2	-	*	CK73GB1C104K	CHIP C	0.10UF	K
C3	-	*	CK73FF1C105Z	CHIP C	1.0UF	Z
C4	-	*	CK73GB1C104K	CHIP C	0.10UF	K
C5	-	*	CK73GB1H103K	CHIP C	0.010UF	K
C6 ,7	-	*	CK73GB1C104K	CHIP C	0.10UF	K
C8 ,9	-	*	CK73GB1H103K	CHIP C	0.010UF	K

L : Scandinavia K : USA P : Canada R : Mexico
 Y : PX(Far East, Hawaii) T : Europe E : Europe G : Germany
 Y : AAFES(Europe) X : Australia M : Other Areas

△ indicates safety critical components.

PARTS LIST

DPC-781/782/981

* New Parts

Parts without **Parts No.** are not supplied.Les articles non mentionnés dans le **Parts No.** ne sont pas fournis.Teile ohne **Parts No.** werden nicht geliefert.

③

Ref. No	Add-ress	New Parts	Parts No.	Description	Desti-nation	Re-marks
C10			C92-0633-05	CHIP-TAN 22UF 10WV		
C17			C92-0158-05	TANTALUM CAPACITOR		
C18			C92-0157-05	CHIP TAN 100UF M		
C26			C92-0623-05	CHIP TAN 22UF 4WV		
C31, 32			CK73GB1H102K	CHIP C 1000PF K		
C34			CK73GB1H221K	CHIP C 220PF K		
C35			C92-0628-05	CHIP-TAN 10UF 10WV		
C36			C92-0633-05	CHIP-TAN 22UF 10WV		
C37 -40			CK73GB1H102K	CHIP C 1000PF K		
C41			CK73GB1C104K	CHIP C 0.10UF K		
C43, 44			CK73GB1H102K	CHIP C 1000PF K		
C101			CK73GB1H221K	CHIP C 220PF K		
C102			CK73FF1C474Z	CHIP C 0.47UF Z		
C103			CK73GB1H221K	CHIP C 220PF K		
C104			CK73GB1C104K	CHIP C 0.10UF K		
C105			C92-0507-05	CHIP-TAN 4.7UF 6.3WV		
C106			CK73GB1C333K	CHIP C 0.033UF K		
C107			CK73GB1H103K	CHIP C 0.010UF K		
C108			CK73GB1E223K	CHIP C 0.022UF K		
C110			CK73GB1H221K	CHIP C 220PF K		
C111			CK73FF1C105Z	CHIP C 1.0UF Z		
C112			C92-0628-05	CHIP-TAN 10UF 10WV		
C113			CK73GB1H103K	CHIP C 0.010UF K		
C114			C92-0619-05	CHIP TAN 47UF 4WV		
C115			CK73GB1H103K	CHIP C 0.010UF K		
C116			CK73GB1C473K	CHIP C 0.047UF K		
C117			CK73GB1H103K	CHIP C 0.010UF K		
C118			CK73GB1H472K	CHIP C 4700PF K		
C119			CK73GB1H103K	CHIP C 0.010UF K		
C120			CC73GCH1H151J	CHIP C 150PF J		
C121			CC73GCH1H330J	CHIP C 33PF J		
C122			CK73GB1C104K	CHIP C 0.10UF K		
C123			CK73GB1E223K	CHIP C 0.022UF K		
C125			CK73GB1C104K	CHIP C 0.10UF K		
C126			C92-0619-05	CHIP TAN 47UF 4WV		
C127			C92-0623-05	CHIP TAN 22UF 4WV		
C128			C92-0633-05	CHIP-TAN 22UF 10WV		
C129			CK73GB1C104K	CHIP C 0.10UF K		
C201, 202			C92-0619-05	CHIP TAN 47UF 4WV		
C203			CK73GB1C473K	CHIP C 0.047UF K		
C204			CK73GB1H152K	CHIP C 1500PF K		
C205			CK73GB1H332K	CHIP C 3300PF K		
C206			CK73GB1H221K	CHIP C 220PF K		
C207			CK73FF1C474Z	CHIP C 0.47UF Z		
C208			CK73FF1E154Z	CHIP C 0.15UF Z		
C209			C92-0623-05	CHIP TAN 22UF 4WV		
C210			CK73GB1H103K	CHIP C 0.010UF K		
C213, 214			CC73GCH1H120J	CHIP C 12PF J		
C223, 224			CK73GB1H221K	CHIP C 220PF K		
C301			C92-0619-05	CHIP TAN 47UF 4WV		
C302			CK73GB1C104K	CHIP C 0.10UF K		
C303			CK73GB1H102K	CHIP C 1000PF K		
C304			CK73GB1E223K	CHIP C 0.022UF K		
C305			CK73GB1H103K	CHIP C 0.010UF K		
C306, 307			CK73FF1C105Z	CHIP C 1.0UF Z		

L : Scandinavia

Y : PX(Far East, Hawaii)

Y : AAFES(Europe)

K : USA

T : Europe

X : Australia

P : Canada

E : Europe

M : Other Areas

R : Mexico

G : Germany

⚠ indicates safety critical components.

* New Parts

Parts without **Parts No.** are not supplied.Les articles non mentionnés dans le **Parts No.** ne sont pas fournis.Teile ohne **Parts No.** werden nicht geliefert.

④

Ref. No	Add-ress	New Parts	Parts No.	Description	Desti-nation	Re-marks
C308			CK73GB1H103K	CHIP C 0.010UF K		
C309			CK73GB1H102K	CHIP C 1000PF K		
C310			C92-0628-05	CHIP-TAN 10UF 10WV		
C311			CK73GB1H103K	CHIP C 0.010UF K	M1	K9P9M9
C311			CK73GB1H103K	CHIP C 0.010UF K		P2
C311			CK73GB1H103K	CHIP C 0.010UF K		T9E9P1
C311			CK73GB1H103K	CHIP C 0.010UF K		X2K2M2
C312			C92-0623-05	CHIP TAN 22UF 4WV		K2M2P2
C312			C92-0623-05	CHIP TAN 22UF 4WV		K9P9X2
C313			CK73GB1C104K	CHIP C 0.10UF K		
C401, 402			CK73FF1C105Z	CHIP C 1.0UF Z		
C403, 404			CK73GB1H122K	CHIP C 1200PF K		
C405			C92-0006-05	CHIP-TAN 3.3UF 4WV		
C406, 407			C92-0507-05	CHIP-TAN 4.7UF 6.3WV		
C411, 412			CK73FF1E154Z	CHIP C 0.15UF Z		
C413			CK73FF1C105Z	CHIP C 1.0UF Z		
C414-416			CK73GB1C473K	CHIP C 0.047UF K		
C417			CK73FF1C105Z	CHIP C 1.0UF Z		
C420			C92-0619-05	CHIP TAN 47UF 4WV		
C421			CK73GB1H103K	CHIP C 0.010UF K		
C422			C92-0619-05	CHIP TAN 47UF 4WV		
C423			CK73GB1C104K	CHIP C 0.10UF K		
C424			C92-0619-05	CHIP TAN 47UF 4WV		
C431, 432			CK73GB1H102K	CHIP C 1000PF K	K9P9M9	
C431, 432			CK73GB1H102K	CHIP C 1000PF K		P2
C431, 432			CK73GB1H102K	CHIP C 1000PF K		T9E9P1
C433, 434			C92-0507-05	CHIP-TAN 4.7UF 6.3WV		X2K2M2
C433, 434			C92-0507-05	CHIP-TAN 4.7UF 6.3WV		K9P9M9
C433, 434			C92-0507-05	CHIP-TAN 4.7UF 6.3WV		P2
C433, 434			C92-0507-05	CHIP-TAN 4.7UF 6.3WV		T9E9P1
C433, 434			C92-0507-05	CHIP-TAN 4.7UF 6.3WV		X2K2M2
C450, 451			CK73GB1H102K	CHIP C 1000PF K		
C453			C92-0628-05	CHIP-TAN 10UF 10WV		
CN1			E40-9941-05	FLAT CABLE CONNECTOR		
CN2			E40-8170-05	PIN ASSY		
CN3			E40-5538-05	PIN ASSY		
CN5			E40-4971-05	PIN ASSY		
CN6			E40-5621-05	PIN ASSY		
J1		*	E03-0355-05	DC JACK		
J2			E11-0371-05	MINIATURE PHONE JACK(3P GREEN)		
J3			E11-0278-05	MINIATURE PHONE JACK(3P 2.5)		
J4			E11-0244-15	MINIATURE PHONE JACK(4P)	K9P9M9	
J4			E11-0244-15	MINIATURE PHONE JACK(4P)		P2
J4			E11-0244-15	MINIATURE PHONE JACK(4P)		T9E9P1
J4			E11-0244-15	MINIATURE PHONE JACK(4P)		X2K2M2
P1	2D	*	E23-1749-04	TERMINAL		
-			J19-5856-04	HOLDER		
L1		*	L33-0566-05	SMALL FIXED INDUCTOR		
L2			L33-0563-15	CHOKE COIL		
L11			L40-1001-39	SMALL FIXED INDUCTOR(10UH,K)		
X2			L78-0661-05	RESONATOR (5.00M)		
X3			L77-2178-05	CRYSTAL RESONATOR(16.9344		
R1			RK73GB1J223J	CHIP R 22K J 1/16W		

L : Scandinavia

Y : PX(Far East, Hawaii)

Y : AAFES(Europe)

K : USA

T : Europe

X : Australia

P : Canada

E : Europe

M : Other Areas

R : Mexico

G : Germany

⚠ indicates safety critical components.

* New Parts
 Parts without **Parts No.** are not supplied.
 Les articles non mentionnés dans le **Parts No.** ne sont pas fournis.
 Teile ohne **Parts No.** werden nicht geliefert.

5

Ref. No	Add-ress	New Parts	Parts No.	Description	Desti-nation	Re-marks
R2 ,3			RK73GB1J104J	CHIP R 100K	J	1/16W
R4 ,5			RK73GB1J103J	CHIP R 10K	J	1/16W
R6 ,7			RK73FB2A3R3J	CHIP R 3.3	J	1/10W
R8			RK73GB1J473J	CHIP R 47K	J	1/16W
R9			RK73GB1J184J	CHIP R 180K	J	1/16W
R10			RK73GB1J304J	CHIP R 300K	J	1/16W
R11			RK73GB1J184J	CHIP R 180K	J	1/16W
R12			RK73GB1J304J	CHIP R 300K	J	1/16W
R13			RK73GB1J243J	CHIP R 24K	J	1/16W
R14			RK73GB1J272J	CHIP R 2.7K	J	1/16W
R15			RK73GB1J224J	CHIP R 220K	J	1/16W
R16			RK73GB1J391J	CHIP R 390	J	1/16W
R17			RK73GB1J103J	CHIP R 10K	J	1/16W
R18			RK73GB1J133J	CHIP R 13K	J	1/16W
R19			RK73GB1J393J	CHIP R 39K	J	1/16W
R20			RK73GB1J1R0J	CHIP R 1	J	1/16W
R21			RK73GB1J473J	CHIP R 47K	J	1/16W
R22			RK73GB1J221J	CHIP R 220	J	1/16W
R23			RK73GB1J223J	CHIP R 22K	J	1/16W
R24			RK73GB1J333J	CHIP R 33K	J	1/16W
R25			RK73GB1J331J	CHIP R 330	J	1/16W
R26			RK73FB2A3R3J	CHIP R 3.3	J	1/10W
R27			RK73GB1J103J	CHIP R 10K	J	1/16W
R28			RK73FB2A3R3J	CHIP R 3.3	J	1/10W
R29			RK73GB1J163J	CHIP R 16K	J	1/16W
R101			RK73GB1J101J	CHIP R 100	J	1/16W
R102			RK73GB1J563J	CHIP R 56K	J	1/16W
R103,104			RK73GB1J514J	CHIP R 510K	J	1/16W
R106			RK73GB1J101J	CHIP R 100	J	1/16W
R107			RK73GB1J823J	CHIP R 82K	J	1/16W
R108			RK73GB1J473J	CHIP R 47K	J	1/16W
R109			RK73GB1J124J	CHIP R 120K	J	1/16W
R110			RK73GB1J153J	CHIP R 15K	J	1/16W
R111			RK73GB1J513J	CHIP R 51K	J	1/16W
R112			RK73GB1J224J	CHIP R 220K	J	1/16W
R113			RK73GB1J223J	CHIP R 22K	J	1/16W
R114			RK73GB1J222J	CHIP R 2.2K	J	1/16W
R115			RK73GB1J472J	CHIP R 4.7K	J	1/16W
R116			RK73GB1J162J	CHIP R 1.6K	J	1/16W
R117			RK73GB1J394J	CHIP R 390K	J	1/16W
R118			RK73GB1J184J	CHIP R 180K	J	1/16W
R119			RK73GB1J223J	CHIP R 22K	J	1/16W
R120			RK73GB1J105J	CHIP R 1.0M	J	1/16W
R121			RK73GB1J104J	CHIP R 100K	J	1/16W
R122			RK73GB1J682J	CHIP R 6.8K	J	1/16W
R123			RK73GB1J105J	CHIP R 1.0M	J	1/16W
R124			RK73GB1J103J	CHIP R 10K	J	1/16W
R125			RK73GB1J243J	CHIP R 24K	J	1/16W
R126			RK73GB1J203J	CHIP R 20K	J	1/16W
R127			RK73GB1J103J	CHIP R 10K	J	1/16W
R128			RK73GB1J4R7J	CHIP R 4.7	J	1/16W
R129			RK73GB1J910J	CHIP R 91	J	1/16W
R130			RK73GB1J103J	CHIP R 10K	J	1/16W
R131,132			RK73GB1J303J	CHIP R 30K	J	1/16W
R133,134			RK73GB1J105J	CHIP R 1.0M	J	1/16W

L : Scandinavia K : USA P : Canada R : Mexico
 Y : PX(Far East, Hawaii) T : Europe E : Europe G : Germany
 Y : AAFES(Europe) X : Australia M : Other Areas

△ indicates safety critical components.

* New Parts
 Parts without **Parts No.** are not supplied.
 Les articles non mentionnés dans le **Parts No.** ne sont pas fournis.
 Teile ohne **Parts No.** werden nicht geliefert.

5

Ref. No	Add-ress	New Parts	Parts No.	Description	Desti-nation	Re-marks
R135,136			RK73GB1J184J	CHIP R 180K	J	1/16W
R137,138			RK73GB1J104J	CHIP R 100K	J	1/16W
R139			RK73GB1J823J	CHIP R 82K	J	1/16W
R140			RK73GB1J334J	CHIP R 330K	J	1/16W
R141			RK73GB1J185K	CHIP R 1.8M	K	1/16W
R142			RK73GB1J135K	CHIP R 1.3M	K	1/16W
R143			RK73GB1J472J	CHIP R 4.7K	J	1/16W
R144			RK73GB1J223J	CHIP R 22K	J	1/16W
R201			RK73GB1J390J	CHIP R 39	J	1/16W
R202			RK73GB1J105J	CHIP R 1.0M	J	1/16W
R203			RK73GB1J434J	CHIP R 430K	J	1/16W
R204			RK73GB1J150J	CHIP R 15	J	1/16W
R205			RK73GB1J223J	CHIP R 22K	J	1/16W
R206			RK73GB1J332J	CHIP R 3.3K	J	1/16W
R207			RK73GB1J152J	CHIP R 1.5K	J	1/16W
R208			RK73GB1J103J	CHIP R 10K	J	1/16W
R209			RK73GB1J105J	CHIP R 1.0M	J	1/16W
R210			RK73GB1J104J	CHIP R 100K	J	1/16W
R211			RK73GB1J471J	CHIP R 470	J	1/16W
R212			RK73GB1J220J	CHIP R 22	J	1/16W
R213			RK73GB1J682J	CHIP R 6.8K	J	1/16W
R214			RK73GB1J183J	CHIP R 18K	J	1/16W
R215			RK73GB1J471J	CHIP R 470	J	1/16W
R216			RK73GB1J334J	CHIP R 330K	J	1/16W
R217			RK73GB1J561J	CHIP R 560	J	1/16W
R218			RK73GB1J472J	CHIP R 4.7K	J	1/16W
R219			RK73GB1J331J	CHIP R 330	J	1/16W
R221,222			RK73GB1J103J	CHIP R 10K	J	1/16W
R223,224			RK73GB1J113J	CHIP R 11K	J	1/16W
R301			RK73GB1J103J	CHIP R 10K	J	1/16W
R302-304			RK73GB1J333J	CHIP R 33K	J	1/16W
R305			RK73GB1J272J	CHIP R 2.7K	J	1/16W
R306			RK73GB1J273J	CHIP R 27K	J	1/16W
R307			RK73GB1J102J	CHIP R 1.0K	J	1/16W
R307			RK73GB1J102J	CHIP R 1.0K	J	1/16W
R307			RK73GB1J102J	CHIP R 1.0K	J	1/16W
R307			RK73GB1J102J	CHIP R 1.0K	J	1/16W
R308			RK73GB1J474J	CHIP R 470K	J	1/16W
R309			RK73GB1J103J	CHIP R 10K	J	1/16W
R310-313			RK73GB1J181J	CHIP R 180	J	1/16W
R310-313			RK73GB1J181J	CHIP R 180	J	1/16W
R310-313			RK73GB1J181J	CHIP R 180	J	1/16W
R314			RK73GB1J103J	CHIP R 10K	J	1/16W
R315,316			RK73GB1J474J	CHIP R 470K	J	1/16W
R315,316			RK73GB1J474J	CHIP R 470K	J	1/16W
R316			RK73GB1J474J	CHIP R 470K	J	1/16W
R316			RK73GB1J474J	CHIP R 470K	J	1/16W
R317			RK73GB1J222J	CHIP R 1.2K	J	1/16W
R318			RK73GB1J152J	CHIP R 1.5K	J	1/16W
R319			RK73GB1J182J	CHIP R 1.8K	J	1/16W
R320			RK73GB1J242J	CHIP R 2.4K	J	1/16W
R321			R92-1762-05	CHIP R 4.7K	F	1/10W
R322			RK73GB1J103J	CHIP R 10K	J	1/16W
R323			RK73GB1J122J	CHIP R 1.2K	J	1/16W
R324,325			RK73GB1J104J	CHIP R 100K	J	1/16W

L : Scandinavia K : USA P : Canada R : Mexico
 Y : PX(Far East, Hawaii) T : Europe E : Europe G : Germany
 Y : AAFES(Europe) X : Australia M : Other Areas

△ indicates safety critical components.

PARTS LIST

DPC-781/782/981

* New Parts
Parts without **Parts No.** are not supplied.
Les articles non mentionnés dans le **Parts No.** ne sont pas fournis.
Teile ohne **Parts No.** werden nicht geliefert.

7

Ref. No	Add-ress	New Parts	Parts No.	Description	Desti-nation	Re-marks
R326,327			RK73GB1J474J	CHIP R 470K J 1/16W		
R328			RK73GB1J104J	CHIP R 100K J 1/16W		
R329			RK73GB1J562J	CHIP R 5.6K J 1/16W		
R330			RK73GB1J432J	CHIP R 4.3K J 1/16W		
R331			RK73GB1J822J	CHIP R 8.2K J 1/16W		
R332-334			RK73GB1J181J	CHIP R 180 J 1/16W	P2	
R332-334			RK73GB1J181J	CHIP R 180 J 1/16W	X2K2M2	
R335,336			RK73GB1J100J	CHIP R 10 J 1/16W		
R337			RK73GB1J131J	CHIP R 130 J 1/16W		
R338			RK73GB1J181J	CHIP R 180 J 1/16W	P2	
R338			RK73GB1J181J	CHIP R 180 J 1/16W	X2K2M2	
R339			RK73GB1J473J	CHIP R 47K J 1/16W		
R340			RK73GB1J223J	CHIP R 22K J 1/16W		
R341			RK73GB1J101J	CHIP R 100 J 1/16W	K2M2P2	
R341			RK73GB1J101J	CHIP R 100 J 1/16W	K9P9X2	
R342			R92-1762-05	CHIP R 4.7K F 1/10W		
R343			RK73GB1J682J	CHIP R 6.8K J 1/16W		
R344			RK73GB1J103J	CHIP R 10K J 1/16W		
R345			RK73GB1J392J	CHIP R 3.9K J 1/16W	M9M1	
R347			RK73GB1J112J	CHIP R 1.1K J 1/16W		
R348			RK73GB1J102J	CHIP R 1.0K J 1/16W		
R349			RK73GB1J472J	CHIP R 4.7K J 1/16W		
R350			RK73GB1J101J	CHIP R 100 J 1/16W	M1	
R351			RK73GB1J473J	CHIP R 47K J 1/16W		
R401,402			RK73GB1J223J	CHIP R 22K J 1/16W		
R403,404			RK73GB1J822J	CHIP R 8.2K J 1/16W		
R405,406			RK73GB1J562J	CHIP R 5.6K J 1/16W		
R411,412			RK73GB1J4R7J	CHIP R 4.7 J 1/16W		
R413			RK73GB1J1R0J	CHIP R 1 J 1/16W		
R414			RK73GB1J102J	CHIP R 1.0K J 1/16W		
R415,416			RK73GB1J2R2J	CHIP R 2.2 J 1/16W		
R417,418			RK73GB1J104J	CHIP R 100K J 1/16W	K9P9M9	
R417,418			RK73GB1J104J	CHIP R 100K J 1/16W	P2	
R417,418			RK73GB1J104J	CHIP R 100K J 1/16W	T9E9P1	
R417,418			RK73GB1J104J	CHIP R 100K J 1/16W	X2K2M2	
R419			RK73GB1J103J	CHIP R 10K J 1/16W		
R420			RK73GB1J163J	CHIP R 16K J 1/16W		
R421			RK73GB1J104J	CHIP R 100K J 1/16W		
R422			RK73GB1J2R2J	CHIP R 2.2 J 1/16W		
R423			RK73GB1J472J	CHIP R 4.7K J 1/16W		
R431,432			RK73GB1J681J	CHIP R 680 J 1/16W	K9P9M9	
R431,432			RK73GB1J681J	CHIP R 680 J 1/16W	P2	
R431,432			RK73GB1J681J	CHIP R 680 J 1/16W	T9E9P1	
R431,432			RK73GB1J681J	CHIP R 680 J 1/16W	X2K2M2	
R433,434			RK73GB1J220J	CHIP R 22 J 1/16W	K9P9M9	
R433,434			RK73GB1J220J	CHIP R 22 J 1/16W	P2	
R433,434			RK73GB1J220J	CHIP R 22 J 1/16W	T9E9P1	
R433,434			RK73GB1J220J	CHIP R 22 J 1/16W	X2K2M2	
R452			RK73GB1J273J	CHIP R 27K J 1/16W		
R453			RK73GB1J332J	CHIP R 3.3K J 1/16W		
VR1		*	R31-0090-05	VARIABLE RESISTOR		
VR3 -6			R32-0018-05	SEMI FIXED VARIABLE RESISTOR		
W1 ,2			R92-1252-05	CHIP R 0 OHM	K2P2X2	
W1 ,2			R92-1252-05	CHIP R 0 OHM	K9P9P1	
W2			R92-1252-05	CHIP R 0 OHM	M1M2	

L : Scandinavia K : USA P : Canada R : Mexico
Y : PX(Far East, Hawaii) T : Europe E : Europe G : Germany
V : AAFES(Europe) X : Australia M : Other Areas

⚠ indicates safety critical components.

* New Parts
Parts without **Parts No.** are not supplied.
Les articles non mentionnés dans le **Parts No.** ne sont pas fournis.
Teile ohne **Parts No.** werden nicht geliefert.

8

Ref. No	Add-ress	New Parts	Parts No.	Description	Desti-nation	Re-marks
W2			R92-1252-05	CHIP R 0 OHM	M9T9E9	
W4			R92-1252-05	CHIP R 0 OHM		
S2		*	S64-0033-05	LEVER SWITCH		
S3			S62-0035-05	SLIDE SWITCH		
S11 -13			S70-0815-05	TACT SWITCH		
S14		*	S70-0842-05	TACT SWITCH		
S15			S70-0815-05	TACT SWITCH		
S16		*	S70-0842-05	TACT SWITCH		
S17 ,18			S70-0815-05	TACT SWITCH		
D1			UDZ5.1B	ZENER DIODE		
D2			RB451F	DIODE		
D3			DAP202U	DIODE		
D5			MA111	DIODE		
D6			RB451F	DIODE		
D7 -9			RB450F	DIODE		
D11			RB451F	DIODE		
D12			MA111	DIODE		
D13 -15			RB451F	DIODE		
D24			RB450F	DIODE		
D25			U2FWJ44N	DIODE		
D26			MBRA130L	DIODE		
D27			RB451F	DIODE		
D28			DB280F	DIODE	K9P9M9	
D28			RB450F	DIODE	P2	
D28			RB450F	DIODE	T9E9P1	
D28			RB450F	DIODE	X2K2M2	
D29			MA111	DIODE		
D30			RB450F	DIODE		
D31			U1BC44	DIODE	M1M2	
D31			U1BC44	DIODE	M9T9E9	
D51			DA204U	DIODE		
IC1			CXA1982Q	ANALOGUE IC		
IC2			CXD3009Q	MOS-IC		
IC3			UPD78063GF-138	MI-COM IC		
IC4			LA4800V	ANALOGUE IC		
IC5			BH6504K	MOS-IC		
IC5		*	BH6509K	MOS-IC		
IC6			RL5C356	MOS-IC		
IC7 ,8			MN41V4400TT-07	MEMORY IC		
IC7 ,8			MN41V4400TT-08	MEMORY IC		
IC9			NJM2904M	IC(OP AMP X2)		
IC10			NJM2903M	IC(COMPARATOR X2)		
IC11			RN5RG29AA-TR	ANALOGUE IC		
IC12			XC6383B301MR	ANALOGUE IC		
IC13			PST9124NR	ANALOGUE IC		
Q1			DTA124EUA	DIGITAL TRANSISTOR		
Q2			DTC124EUA	DIGITAL TRANSISTOR		
Q3		*	XP161A0390PR	FET		
Q4			2SA1576A(R,S)	TRANSISTOR		
Q5			DTA124EUA	DIGITAL TRANSISTOR		
Q6			2SD2153(V,W)	TRANSISTOR		
Q7			DTC124EUA	DIGITAL TRANSISTOR		
Q8			2SB1424(Q,R)	TRANSISTOR		
Q9			2SD2153(V,W)	TRANSISTOR		

L : Scandinavia K : USA P : Canada R : Mexico
Y : PX(Far East, Hawaii) T : Europe E : Europe G : Germany
V : AAFES(Europe) X : Australia M : Other Areas

⚠ indicates safety critical components.

PARTS LIST

DPC-781/782/981

DPC-781/782/981

PARTS LIST

9

* New Parts
 Parts without **Parts No.** are not supplied.
 Les articles non mentionnes dans le **Parts No.** ne sont pas fournis.
 Teile ohne **Parts No.** werden nicht geliefert.

Ref. No	Add-ress	New Parts	Parts No.	Description	Desti-nation	Re-marks
Q10			2SC4081(R,S)	TRANSISTOR		
Q11			DTC124EUA	DIGITAL TRANSISTOR		
Q12 ,13			DTC114TUA	DIGITAL TRANSISTOR		
Q14			2SB970	TRANSISTOR		
Q15			DTC124EUA	DIGITAL TRANSISTOR		
Q16			DTC323TK	DIGITAL TRANSISTOR		
Q17			2SA1576A(R,S)	TRANSISTOR		
Q18			DTA114TUA	DIGITAL TRANSISTOR		
Q19 ,20			DTC124EUA	DIGITAL TRANSISTOR		
Q21			DTA114TUA	DIGITAL TRANSISTOR		
Q22			2SB970	TRANSISTOR		
Q23			DTC124EUA	DIGITAL TRANSISTOR		
Q24			DTA114TUA	DIGITAL TRANSISTOR		
Q31 ,32			DTC124EUA	DIGITAL TRANSISTOR		
Q33			2SB970	TRANSISTOR		
Q34			DTC124EUA	DIGITAL TRANSISTOR	E9P1X2	
Q34			DTC124EUA	DIGITAL TRANSISTOR	K2M2P2	
Q34			DTC124EUA	DIGITAL TRANSISTOR	K9P9T9	
Q34 ,35			DTC124EUA	DIGITAL TRANSISTOR	M9M1	
Q36			DTA114EUA	DIGITAL TRANSISTOR	M1	
Q37 ,38			2SC4081(R,S)	TRANSISTOR		
Q39			2SB970	TRANSISTOR	M9M1	
Q40			DTA124EUA	DIGITAL TRANSISTOR		
Q41 ,42			DTC114TUA	DIGITAL TRANSISTOR		
Q43			DTA124EUA	DIGITAL TRANSISTOR	K9P9M9	
Q43			DTA124EUA	DIGITAL TRANSISTOR	P2	
Q43			DTA124EUA	DIGITAL TRANSISTOR	T9E9P1	
Q44			2SD2153(V,W)	TRANSISTOR	X2K2M2	
Q45 ,46			DTC323TK	DIGITAL TRANSISTOR	K9P9M9	
Q45 ,46			DTC323TK	DIGITAL TRANSISTOR	P2	
Q45 ,46			DTC323TK	DIGITAL TRANSISTOR	T9E9P1	
Q45 ,46			DTC323TK	DIGITAL TRANSISTOR	X2K2M2	
A1			W02-2562-05	ELECTRIC CIRCUIT MODULE	K2M2P2	
A1			W02-2562-05	ELECTRIC CIRCUIT MODULE	K9P9X2	
A2			W02-2527-05	ELECTRIC CIRCUIT MODULE	M1	
MECHANISM(D40-1565-05)						
1	1A		A10-3415-08	CHASSIS ASSY		
2	2B		D13-1858-08	GEAR		
3	3A		D19-0311-08	GEAR ASSY(SLED SCREW)		
4	2A		G02-1650-08	FLAT SPRING		
5	3B		J19-5898-08	HOLDER		
AA			N09-3425-08	SCREW 2X2.5		
AB			N09-3424-08	TAPPING REW 2X8		
FM	2B		T42-0903-08	MOTOR ASSY		
PU	2A		T25-0072-08	OPTICAL PICKUP HEAD		

L : Scandinavia K : USA P : Canada R : Mexico
 Y : PX(Far East, Hawaii) T : Europe E : Europe G : Germany
 Y : AAFES(Europe) X : Australia M : Other Areas

⚠ indicates safety critical components.

ABBREVIATION TABLE OF PARTS LIST

ABB	MODEL	DESTINATION
E9	DPC-981	EUROPE
K2	DPC-782	USA
K9	DPC-981	USA
M1	DPC-781	GENERAL MARKET
M2	DPC-782	GENERAL MARKET
M9	DPC-981	GENERAL MARKET
P1	DPC-781	CANADA
P2	DPC-782	CANADA
P9	DPC-981	CANADA
T9	DPC-981	ENGLAND
X2	DPC-782	AUSTRALIA

DPC-781/782/981

Note:

Component and circuit are subject to modification to insure best operation under differing local conditions. This manual is based on Europe (E) standard, and provides information on regional circuit modification through use of alternate schematic diagrams, and information on regional component variations through use of parts list.

KENWOOD CORPORATION

14-6, Dogenzaka 1-chome, Shibuya-ku, Tokyo, 150 Japan

KENWOOD SERVICE CORPORATION

P.O. BOX 22745, 2201 East Dominguez St., Long Beach, CA 90801-5745, U.S.A.

KENWOOD ELECTRONICS CANADA INC.

6070 Kestrel Road, Mississauga, Ontario, Canada L5T 1S8

KENWOOD ELECTRONICS LATIN AMERICA S.A.

P.O. BOX 55-2791, Piso 6 plaza Chase, Cl. 47 y Aquilino de la Guardia Panama, Republic de Panama

KENWOOD ELECTRONICS U.K. LIMITED

KENWOOD House, Dwight Road, Watford, Herts., WD1 8EB., United Kingdom

KENWOOD ELECTRONICS BENELUX N.V.

Meachelsesteenweg 418, B-1930 Zaventem, Belgium

KENWOOD ELECTRONICS DEUTSCHLAND GMBH

Rembrücker Str. 15, 63150 Heusenstamm, Germany

KENWOOD ELECTRONICS FRANCE S.A.

13 Boulevard Ney, 75018 Paris, France

KENWOOD ELECTRONICS ITALIA S.p.A.

Via G. Sirtori, 7/9 20129, Milano, Italy

KENWOOD IBÉRICA S.A.

Bolivia, 239-08020 Barcelona, Spain

KENWOOD ELECTRONICS AUSTRALIA PTY. LTD.

(A.C.N. 001499 074)

P.O. Box 504, 8 Figtree Drive, Australia Centre, Homebush, N.S.W. 2140, Australia

KENWOOD & LEE ELECTRONICS, LTD.

Unit 3712-3724, Level 37, Tower 1, Metroplaza, 223 Hing Fong Road, Kwai Fong N.T., Hong Kong

KENWOOD ELECTRONICS GULF FZE

P.O. Box 61318, Jebel Ali, Dubai, U.A.E.

KENWOOD ELECTRONICS SINGAPORE PTE LTD.

No. 1 Genting Lane #02-02, KENWOOD Building, Singapore, 349544

KENWOOD ELECTRONICS (MALAYSIA) SDN BHD.

#4.01 Level 4, Wisma Academy Lot 4A, Jalan 19/1 46300 Petaling Jaya Selangor Darul Ehsan Malaysia