

This manual is based on old one (B51-5514-00).

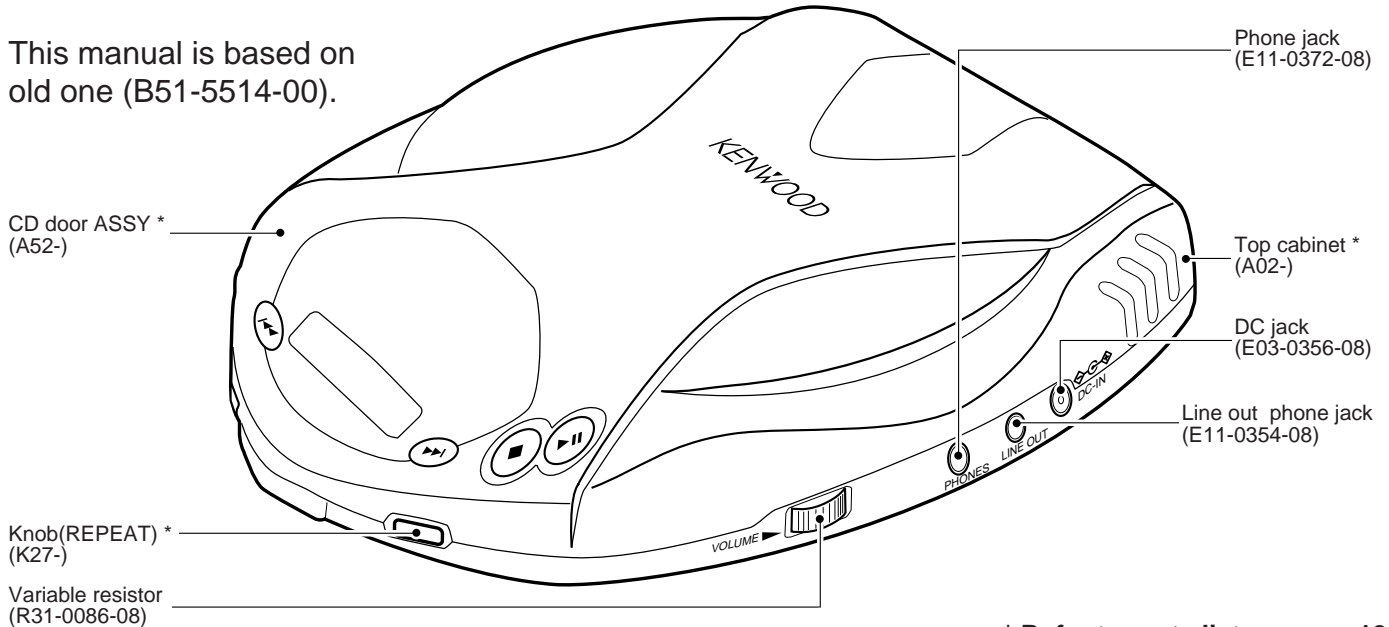

* Refer to parts list on page 12 .

SPECIFICATIONS

Format

System Compact disc digital audio system
 Laser Semiconductor laser

Audio

Frequency response 20 Hz to 20 kHz, ±3 dB
 PHONES output level (16Ω, 1 kHz) 8 mW + 8 mW
 Line output/impedance 0.55 Vrms/1 kΩ

Power supply

External DC supply 4.5V to 6 V DC
 Rechargeable batteries (NB-88) x 2 or 4 DC 2.4 V
 Commercially-available alkaline batteries (LR6/AA) x 2 or 4 DC 3 V

Battery life (continuous repeat playback)

(Figures inside parentheses show the performance when the D.A.S.C. is ON.)

Commercially-available alkaline batteries (LR6/AA) x 2 Approx. 12 (9.5) Hours
 Commercially-available alkaline batteries (LR6/AA) x 4 Approx. 25 (20) Hours
 Rechargeable batteries (NB-88) x 2 Approx. 5.5 (4.5) Hours
 Alkaline batteries (LR6/AA) x 2 and rechargeable batteries (NB-88) x 2 Approx. 18 (15) Hours

Dimensions (W x H x D) (DPC-X301)132 mm x 32.5 mm x 153 mm
 (5 - 3/16" x 1 - 1/4" x 6")
 Dimensions (W x H x D) (DPC-X507/X602)132 mm x 29.5 mm x 153 mm
 (5 - 3/16" x 1 - 3/16" x 6")

Weight (net) (DPC-X301) 272 g (9.6 oz)
 Weight (net) (DPC-X507/X602) 260 g (9.2 oz)



1. KENWOOD follows a policy of continuous advancements in development. For this reason specifications may be changed without notice.
2. The full performance may not be exhibited in an extremely cold location (under a water-freezing temperature).

In compliance with Federal Regulations, following are reproductions of labels on, or inside the product relating to laser product safety.

KENWOOD-Corp. certifies this equipment conforms to DHHS Regulations No. 21 CFR 1040. 10, Chapter 1, Subchapter J.

DANGER : Laser radiation when open and interlock defeated.
AVOID DIRECT EXPOSURE TO BEAM.



DPC-X301/X507/X602

CONTENTS / ACCESSORIES

Contents

SPECIFICATIONS	Top cover	SCHEMATIC DIAGRAM	7
CONTENTS / ACCESSORIES	2	EXPLODED VIEW	11
CIRCUIT DESCRIPTION	3	PARTS LIST	12
PC BOARD	5		

Model feature list

ABBREVIATION MODEL	3 DPC-X301						5 DPC-X507						6 DPC-X602				
	J	P	M	X	T	E	J	K	P	M	X	T	E	K	P	M	X
DASC SW(HI-OFF-ST(16M))	-	-	-	-	-	-	YES	YES	YES	YES	YES	YES	YES	YES	YES	YES	YES
LINE OUT JACK(J105)	YES	YES	YES	YES	YES	YES	YES	YES	YES	YES	YES	YES	YES	YES	YES	YES	YES
REMOCON JACK(J103)	-	-	-	-	-	-	YES	-	-	YES	YES	-	-	-	-	-	-
CAR BATTERY ADP.	-	-	-	-	-	-	-	-	-	-	-	-	-	YES	YES	YES	YES
CAR SACETTE ADP.	-	-	-	-	-	-	-	-	-	-	-	-	-	YES	YES	YES	YES
RECHARGEABLE BATTERY	-	-	-	-	NB-88	-	NB-88	-	-	NB-88	NB-88	NB-88	-	-	-	-	-
INNER HEADPHONE(SHORT)	-	-	-	-	-	-	YES	-	-	YES	YES	-	-	-	-	-	-
INNER HEADPHONE(LONG)	YES	-	YES	YES	YES	YES	-	-	-	-	-	YES	YES	-	-	YES	YES
OPEN HEADPHONE	-	YES	-	-	-	-	-	YES	YES	-	-	-	-	YES	YES	-	-
REMOCON WIRED	-	-	-	-	-	-	3-KEY	-	-	LCD	LCD	-	-	-	-	-	-
COLOR*	S	S	W	W	BL	S,BL	L,W	S	S	BL	BL	S	S,BL	S	S	S	S

* (S)=SILVER, (W)=WHITE, (L)=BULE, (BL)=BLACK

Accessories

AC adapter(1)
 (W08-0658-08) : E3,E4,E5,E7,T4,T5
 (W09-1251-05) : K5,K6,P3,P5,P6
 (W08-0675-08) : M3,M5,M6
 (W03-0679-08) : X3,X5,X6

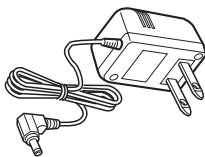

Innerphone(1)
 (W01-0925-05) : E3,E4,E5,E7,X6,
 M6,M3,X3,T4,T5
 (W01-0923-05) : X5,M5

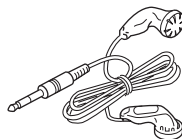

Remote control(1)
 (A70-1190-05) : X5,M5

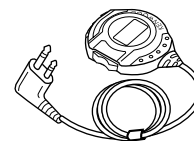

Headphone(1)
 (W01-0924-05) : K5,K6,P3,P5,P6

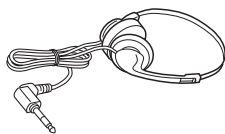

Car cassette adapter(1)
 (W01-0922-05) : K6,P6,M6,X6

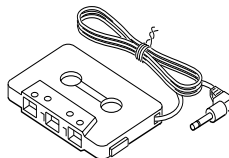

Car battery adapter(1)
 (W01-0921-05) : K6,P6,M6,X6

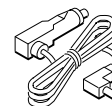

AC plug adapter(1)
 (E03-0115-05) : M3,M5,M6

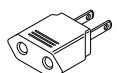

Use to adapt the plug on the power cord to the shape of the wall outlet. (Accessory only for regions where use is necessary.)

Rechargeable battery(1)
 (W09-1240-05) : M5,X5,T4,T5

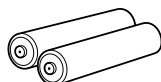

DPC-X301/X507/X602

CIRCUIT DESCRIPTION

1. Microprocessor : MN101C16ATA2

1-1 Pin description

Pin No.	Name	I/O	Description	Remarks
1-4	COM1-4	O	LCD common signal	
5	VLC3	-	GND	
6,7	VLC1,2	-	LCD driving bias control	
8	VDD	-	Power supply(+2.8V)	
9	OSC2	-	No use	
10	SMCK	I	External system clock(4.2336MHz)	
11	VSS	-	GND	
12	X1	-	GND	
13	X0	-	No use	
14,15	MMOD,VREF	-	GND	
16	KEY1	I	Key input	
17	KEY2	I	Remocon key input port	
18	RECHARGE OUT	O	Rechargeable detection port	
19	BATT	-	No use	
20	HOLD	I	Key hold on/off control	ON=H
21	DOOR	I	Door switch detection port	OPEN=H
22	DA SCST	I/O	DASC switch detection port(ST)	
23	DA SCHI	I	DASC switch detection port(HI)	
24	VREF+	-	Power supply(+2.8V)	
25	P00	-	No use	
26	SUBQ	I	Sub-Q data input signal port(to MN662746RPK1)	
27	SQCK	I	Sub-Q data read timing clock port(to MN662746RPK1)	
28	MDATA	O	Data signal port(to MN662746RPK1)	
29	P04	-	No use	
30	MCLK	O	Clock signal port(to MN662746RPK1)	
31	P06	-	No use	
32	RESET	I	System reset port	
33-37	P10-14	-	No use	
38	BLKCK	I	Sub-Q signal read require port	
39	P21	-	No use	
40	REM IN	I	Remocon data input port	
41,42	P23,24	-	No use	
43	YMCLK	O	Clock signal port to SM5903AF	
44	YMDATA	O	Audio signal port to SM5903AF	
45	YMLD	O	Latch signal port to SM5903AF	
46	YD MUTE	O	Audio signal mute control port	ON=H
47	ZSENSE	O	Sensitive signal port to SM5903AF	
48	NRESET	O	System reset port to SM5903AF	
49,50	P53,54	-	No use	
51	POWER	O	Power supply control port	
52	REM DATA	O	Remocon data output port	
53	CONT	O	DASC control output port(HI/ST)	ON=H
54	BBS	O	BBS control	ON=L
55	LMT	I	Limit switch detection port	
56	EMP	O	Battery level detection port	LOW BATT=H

DPC-X301/X507/X602

CIRCUIT DESCRIPTION

Pin No.	Name	I/O	Description	Remarks
57-59	P66,67,70	-	No use	
60	RECHARGE	I	Rechargeable battery detection port	
61	LIGHT OUT	-	No use	
62	MLD	O	Latch signal port(to MN662746RPK1)	
63	SENSE	I	Sensitive signal port	
64	FLOCK	I	Focus servo	IN=L
65	TLOCK	I	Tracking servo	IN=L
66	STAT	I	Status signal port	
67	RST	O	Reset signal port(to MN662746RPK1)	
68-71	P83-86	-	No use	
72	DIGITAL OUT	O	No use	
73	P81	I	Memory selector	NO=H,16M=L
74	P80	I	Memory selector	NO=L,16M=L
75-85	SEG15-25	-	No use	
86-100	SEG0-14	O	LCD segment signal	

1-2 Microprocessor periphery block diagram

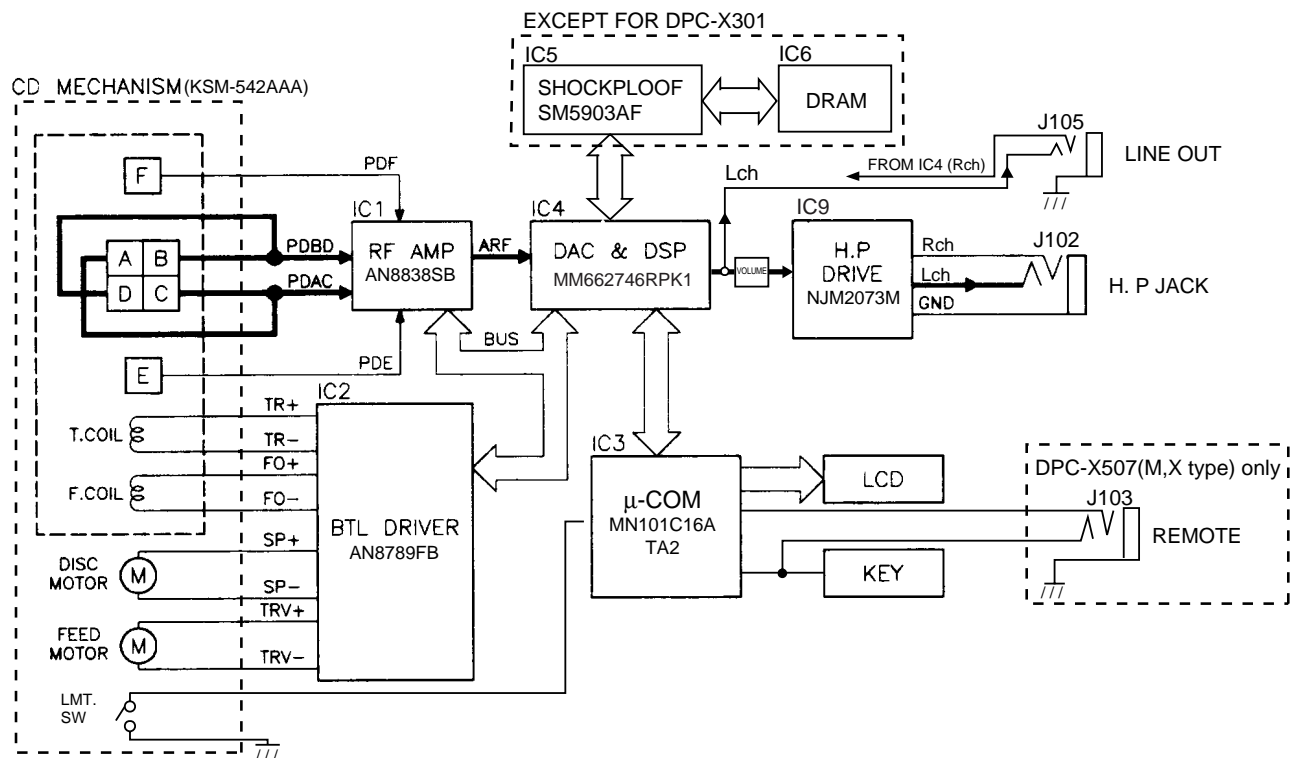

PC BOARD (Component side view)

PC BOARD (Foil side view)

1
2
3
4
5
6
7

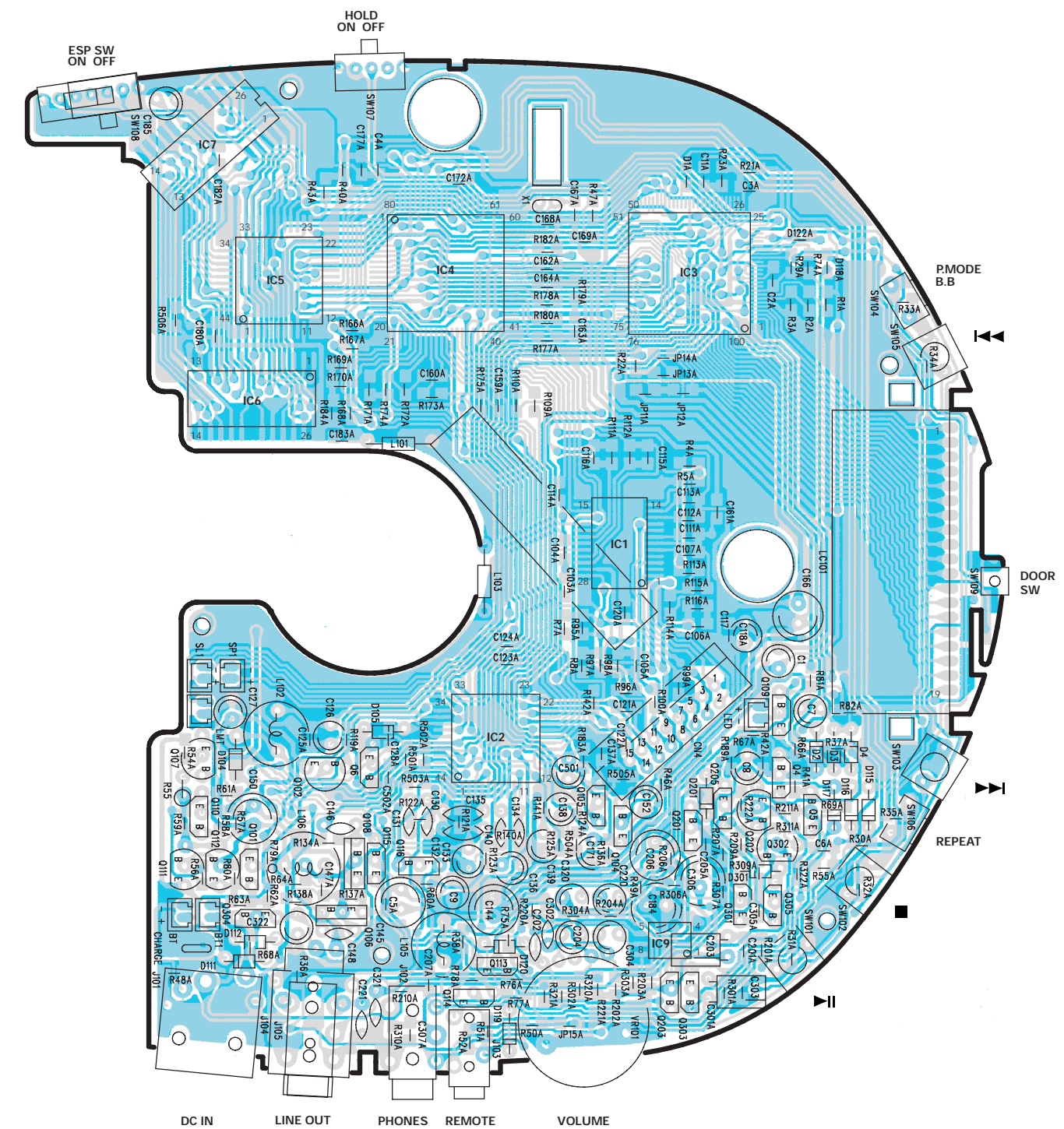
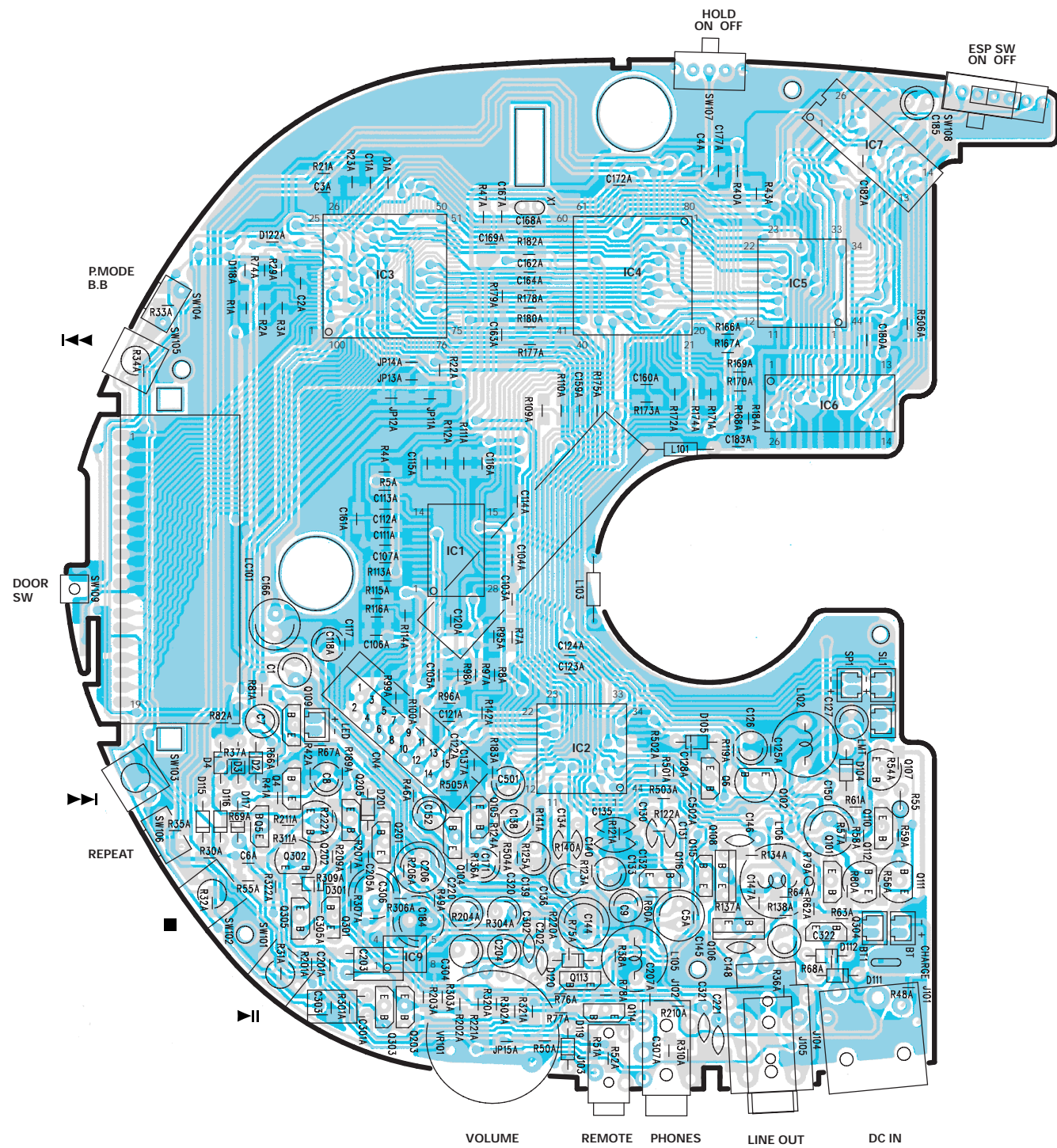

Refer to the schematic diagram for the value of resistors and capacitors.

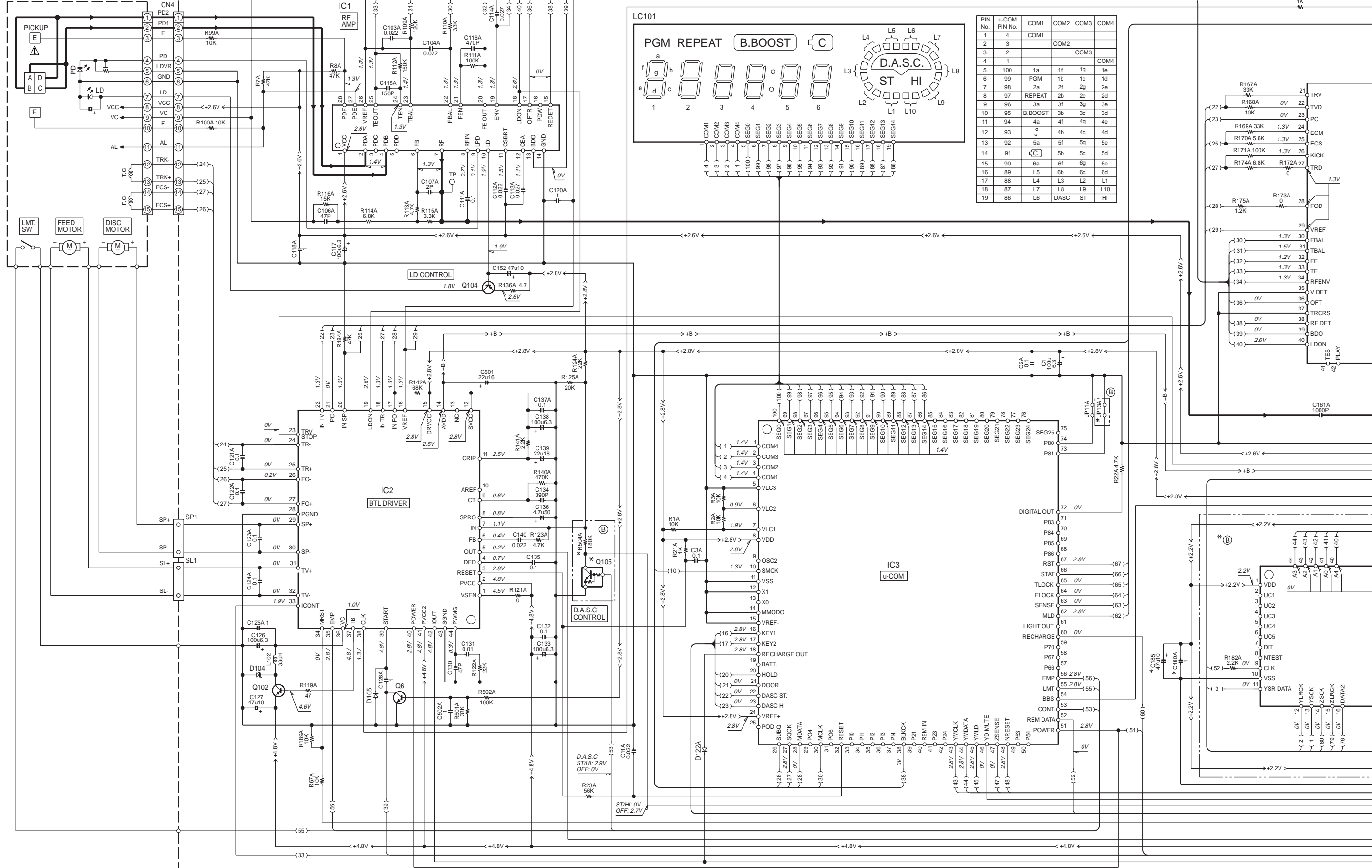

CAUTION: For continued safety, replace safety critical components only with manufacturer's recommended parts (refer to parts list). Δ indicates safety critical components. For continued protection against risk of fire, replace only with same type and rating fuse(s). To reduce the risk of electric shock, leakage-current or resistance measurements shall be carried out (exposed parts are acceptably insulated from the supply circuit) before the appliance is returned to the customer.

The DC voltage is an actual reading measured with a high impedance type voltmeter. The measurement value may vary depending on the measuring instruments used or on the product. Refer to the voltage during PLAY with DASC OFF (at the normal speed) unless otherwise specified; The value shown in () is the voltage measured at the moment of STOP.

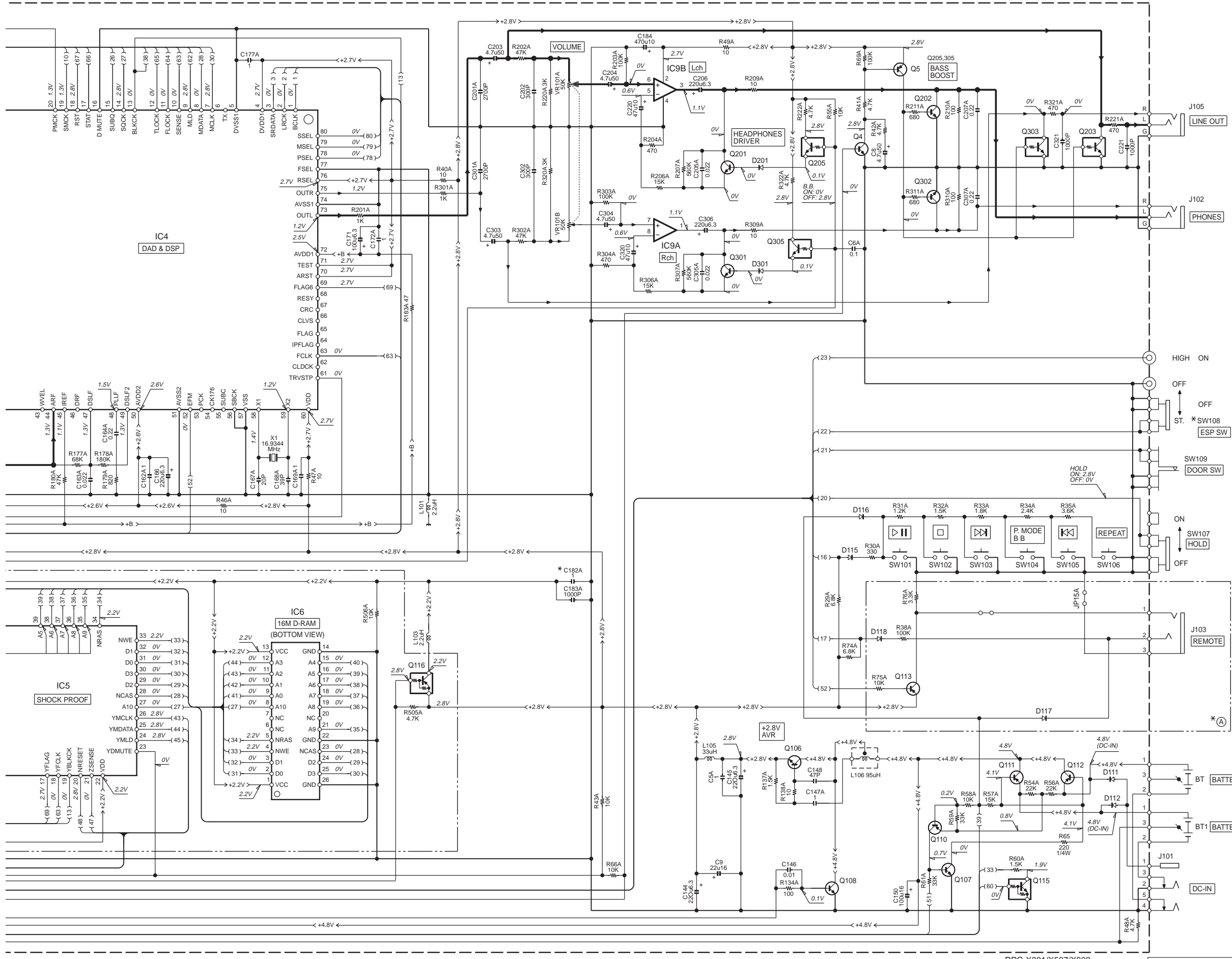

DPC-X301

DESTINATION	COUNTRY	ABB.	(A)	(B)	C180A,182A,185	SW108
CANADA	P3		NO	NO	NO	NO
EUROPE	E3		NO	NO	NO	NO

DPC-X301(BL)

DESTINATION	COUNTRY	ABB.	(A)	(B)	C180A,182A,185	SW108
U.K.	T4		NO	NO	NO	NO
EUROPE	E4		NO	NO	NO	NO

DPC-X301(W)

DESTINATION	COUNTRY	ABB.	(A)	(B)	C180A,182A,185	SW108
AUSTRALIA	X3		NO	NO	NO	NO
GENERAL MARKET	M3		NO	NO	NO	NO

DPC-X507

DESTINATION	COUNTRY	ABB.	(A)	(B)	C180A,182A,185	SW108
CANADA	P5					
U.K.	T5		NO	YES	YES	YES
EUROPE	E5		NO	YES	YES	YES
U.S.A.	K5					

DPC-X507(BL)

DESTINATION	COUNTRY	ABB.	(A)	(B)	C180A,182A,185	SW108
AUSTRALIA	X5		YES	YES	YES	YES
EUROPE	E7		NO	YES	YES	YES
GENERAL MARKET	M5		YES	YES	YES	YES

DPC-X602

DESTINATION	COUNTRY	ABB.	(A)	(B)	C180A,182A,185	SW108
AUSTRALIA	X6					
CANADA	P6		NO	YES	YES	YES
U.S.A.	K6					
GENERAL MARKET	M6		NO	YES	YES	YES

- IC1 : AN8838SB
- IC2 : AN8789FB
- IC3 : MN101C16ATA2
- IC4 : MN662746RPK1
- IC5 : SM5903AF
- IC6 : MN41V17400CTT6
- IC9 : NJM2073M

- Q4,6,201,301 : 2SC3330
- Q5,104,110,113 : 2SA1317
- Q102 : 2SB598F
- Q105,115 : 2SC4048-AC
- Q106 : 2SC4481T
- Q107,202,302 : 2SD734F
- Q108 : 2SD1805F or 2SD1805G
- Q111,112 : 2SB926T
- Q116 : 2SA1564-AC
- Q203,205,303,305 : 2SC3860

- D104 : SB10-03A3-BT
- D105,115-117,201,301 : GMB01-BT
- D111,112 : IN4001
- D118,122 : 1SS355

— SIGNAL LINE
 — GND LINE
 — +B LINE

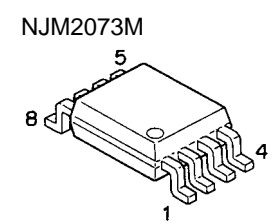

DPC-X301/X507/X602

DPC-X301/X507/X602

Y22-8080-10

KENWOOD

DPC-X301/X507/X602

EXPLODED VIEW (UNIT)

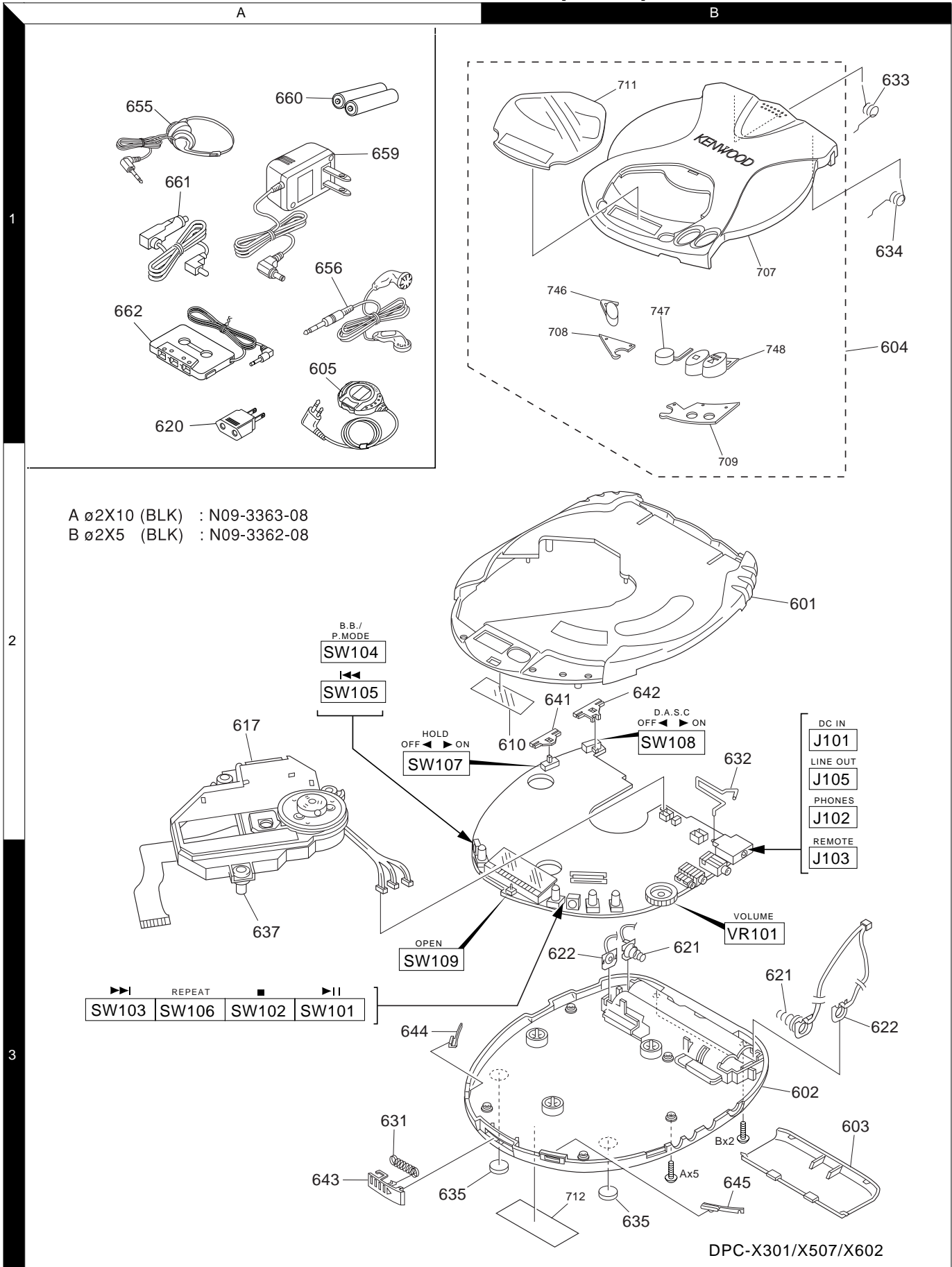

* New Parts
Parts without **Parts No.** are not supplied.
Les articles non mentionnés dans le **Parts No.** ne sont pas fournis.
Teile ohne **Parts No.** werden nicht geliefert.

①

Ref. No	Add-ress	New Parts	Parts No.	Description	Desti-nation	Re-marks
DPC-X301/X507/X602						
601	2B	*	A02-2911-08	TOP CABINET 103-03930-070	E3P3	
601	2B	*	A02-2912-08	TOP CABINET 103-03932-070	E5X6M6	
601	2B	*	A02-2912-08	TOP CABINET 103-03932-070	P5T5	
601	2B	*	A02-2912-08	TOP CABINET 103-03932-070	P6K5K6	
601	2B	*	A02-2934-08	TOP CABINET 103-03932-0903	E7X5M5	
601	2B	*	A02-2936-08	TOP CABINET 103-03930-0903	E4T4X3	
601	2B	*	A02-2936-08	TOP CABINET 103-03930-0903	M3	
602	3B	*	A02-2913-08	BOTTOM CABINET 104-03930-070	E3P3	
602	3B	*	A02-2914-08	BOTTOM CABINET 104-03931-070	E5X6M6	
602	3B	*	A02-2914-08	BOTTOM CABINET 104-03931-070	P5T5	
602	3B	*	A02-2914-08	BOTTOM CABINET 104-03931-070	P6K5K6	
602	3B	*	A02-2935-08	BOTTOM CABINET 104-03932-0903	X5M5	
602	3B	*	A02-2937-08	BOTTOM CABINET 104-03931-0903	E7	
602	3B	*	A02-2938-08	BOTTOM CABINET 104-03930-0903	E4T4X3	
602	3B	*	A02-2938-08	BOTTOM CABINET 104-03930-0903	M3	
603	3B		A09-1110-08	BATTERY DOOR 111-03930-070	E3E5X6	
603	3B		A09-1110-08	BATTERY DOOR 111-03930-070	K6P6K5	
603	3B		A09-1110-08	BATTERY DOOR 111-03930-070	M6P5T5	
603	3B		A09-1110-08	BATTERY DOOR 111-03930-070	P3	
603	3B	*	A09-1160-08	BATTERY DOOR 111-03930-0903	E4E7T4	
603	3B	*	A09-1160-08	BATTERY DOOR 111-03930-0903	M3	
603	3B	*	A09-1160-08	BATTERY DOOR 111-03930-0903	X5M5X3	
604	1B	*	A53-2141-08	CD DOOR ASSY E3P3	E3P3	
604	1B	*	A53-2143-08	CD DOOR ASSY X3M3	X3M3	
604	1B	*	A53-2144-08	CD DOOR ASSY E4T4	E4T4	
604	1B	*	A53-2145-08	CD DOOR ASSY E5K5T5	E5K5T5	
604	1B	*	A53-2145-08	CD DOOR ASSY P5	P5	
604	1B	*	A53-2148-08	CD DOOR ASSY E7X5M5	E7X5M5	
604	1B	*	A53-2149-08	CD DOOR ASSY K6P6X6	K6P6X6	
604	1B	*	A53-2149-08	CD DOOR ASSY M6	M6	
605	1A		A70-1190-05	REMOCON 182-03810-001	X5M5	
610	2B	*	B10-3454-08	INNER DISP LENS,117-03930-100		
-			B46-0100-50	WARRANTY CARD	E3E4E5	
-			B46-0100-50	WARRANTY CARD	X5X3	
-			B46-0100-50	WARRANTY CARD	X6E7T5	
-			B46-0332-03	WARRANTY CARD	K5K6	
-			B46-0347-03	WARRANTY CARD	P3P5P6	
-			B58-1519-08	HOLD CAUTION 155-00000-0266		
-			B58-1611-08	CARTON CARD 155-01830-100	E4E5E7	
-			B58-1611-08	CARTON CARD 155-01830-100	M6X5T4	
-			B58-1611-08	CARTON CARD 155-01830-100	P5T5E7	
-			B58-1611-08	CARTON CARD 155-01830-100	X3M3	
-			B60-3105-08	CAR KIT INST SHEET	M6	
-			B60-3105-08	CAR KIT INST SHEET	P6K6X6	
-		*	B60-4270-08	INST MANUAL(EN)	P5P3	
-		*	B60-4270-08	INST MANUAL(EN)	P6K5K6	
-		*	B60-4271-08	INST MANUAL(EN)	X3M3	
-		*	B60-4271-08	INST MANUAL(EN)	X5M5T4	
-		*	B60-4271-08	INST MANUAL(EN)	X6M6T5	
-		*	B60-4272-08	INST MANUAL(FR)	E4E5E7	
-		*	B60-4272-08	INST MANUAL(FR)	P3	
-		*	B60-4272-08	INST MANUAL(FR)	P5P6E3	

L : Scandinavia K : USA P : Canada R : Mexico C : China I : Malaysia
Y : PX(Far East,Hawaii) T : England E : Europe G : Germany V : China(Shanghai)
Y : AAFES(Europe) X : Australia Q : Russia H : Korea M : Other Areas Δ indicates safety critical components .

* New Parts
Parts without **Parts No.** are not supplied.
Les articles non mentionnés dans le **Parts No.** ne sont pas fournis.
Teile ohne **Parts No.** werden nicht geliefert.

②

Ref. No	Add-ress	New Parts	Parts No.	Description	Desti-nation	Re-marks
-		*	B60-4273-08	INST MANUAL(SP)	E3E4E5	
-		*	B60-4273-08	INST MANUAL(SP)	M3	
-		*	B60-4273-08	INST MANUAL(SP)	M6E7M5	
-		*	B60-4274-08	INST MANUAL(GR)	E3E4E5	
-		*	B60-4274-08	INST MANUAL(GR)	E7	
-		*	B60-4275-08	INST MANUAL(NE)	E3E4E5	
-		*	B60-4275-08	INST MANUAL(NE)	E7	
-		*	B60-4276-08	INST MANUAL(IT)	E3E4E5	
-		*	B60-4276-08	INST MANUAL(IT)	E7	
-		*	B60-4277-08	INST MANUAL(TC)	M6M5M3	
Δ 617	2A		D40-1547-08	CD MECHANISM KSM-542AAA		
Δ 620	1A		E03-0115-05	AC PLUG ADAPTER	M6M5M3	
621	3B		E23-1737-08	BATT CONTACT(-) 041-96182-002		
622	3B		E23-1758-08	BATT CONTACT(+) 041-01811-002		
631	3A		G01-4075-08	OPEN KNOB SPRNG133-03930-303		
632	2B		E23-1773-08	RECHARGE CNT SP133-03935-106		
633	1B	*	G01-4098-08	CD DOOR SP(L)BLK,162-03932-308		
634	1B	*	G01-4076-08	CD DOOR SP(R)BLK,162-03931-308		
635	3A,3B		G13-0562-08	RUBBER FOOT 136-10010-070		
-		*	H20-0608-08	BLISTER,FRONT 156-03011-000	K5K6	
-		*	H20-0608-08	BLISTER,FRONT 156-03011-000	P3P5P6	
-		*	H20-0609-08	BLISTER,BOTTOM 156-06022-000	K6P6	
-		*	H20-0613-08	BLISTER,BOTTOM 156-03012-000	K5P5P3	
-		*	H25-1603-08	EPE FOAM BAG 150-07009-203		
-		*	H50-3340-08	ITEM CARTON CASE	E3	
-		*	H50-3341-08	ITEM CARTON CASE	M3	
-		*	H50-3342-08	ITEM CARTON CASE	X3	
-		*	H50-3343-08	CHAMSHHELL CARD(DPC-X507)	K5P5	
-		*	H50-3344-08	ITEM CARTON CASE	T5	
-		*	H50-3347-08	CHAMSHHELL CARD(DPC-X602)	K6P6	
-		*	H50-3348-08	ITEM CARTON CASE	M6	
-		*	H50-3349-08	ITEM CARTON CASE	X6	
-		*	H50-3350-08	CHAMSHHELL CARD(DPC-X301)	P3	
-		*	H50-3351-08	ITEM CARTON CASE,151-23014-000	T4	
-		*	H50-3352-08	ITEM CARTON CASE	M5	
-		*	H50-3353-08	ITEM CARTON CASE	X5	
-		*	H50-3354-08	ITEM CARTON CASE	E7	
-		*	H50-3355-08	ITEM CARTON CASE	E4	
-		*	H50-3413-08	ITEM CARTON CASE	E5	
637	3A		J02-1185-08	CD RUBBER CUSHIO,161-05847-001		
641	2B		K27-2320-08	KNOB SIDE A 127-03936-170		
642	2B		K27-2321-08	KNOB SIDE B 127-03936-270	P5T5M5	
642	2B		K27-2321-08	KNOB SIDE B 127-03936-270	P6K5K6	
642	2B		K27-2321-08	KNOB SIDE B 127-03936-270	X5	
642	2B		K27-2321-08	KNOB SIDE B 127-03936-270	X6M6E7	
643	3A		K27-2322-08	KNOB DOOR OPEN 127-03937-070		
644	3A		K27-2326-08	KNOB CD BUTT D 128-03932-470	E3E5	
644	3A		K27-2326-08	KNOB CD BUTT D 128-03932-470	K6P6K5	
644	3A		K27-2336-08	KNOB CD BUTT D 128-03932-470	P5T5	
644	3A		K27-2336-08	KNOB CD BUTT D 128-03932-470	X6M6P3	
644	3A		K27-2382-08	KNOB CD BUTT D 128-03932-477	E4X5T4	
644	3A		K27-2382-08	KNOB CD BUTT D 128-03932-477	E7M5X3	
644	3A		K27-2382-08	KNOB CD BUTT D 128-03932-477	M3	

L : Scandinavia K : USA P : Canada R : Mexico C : China I : Malaysia
Y : PX(Far East,Hawaii) T : England E : Europe G : Germany V : China(Shanghai)
Y : AAFES(Europe) X : Australia Q : Russia H : Korea M : Other Areas Δ indicates safety critical components .

* New Parts
Parts without **Parts No.** are not supplied.
Les articles non mentionnés dans le **Parts No.** ne sont pas fournis.
Teile ohne **Parts No.** werden nicht geliefert.

3

Ref. No	Address	New Parts	Parts No.	Description	Destination	Remarks
645	3B		K27-2327-08	KNOB CD BUTT E 128-03932-570	E3E5	
645	3B		K27-2327-08	KNOB CD BUTT E 128-03932-570	K6P6K5	
645	3B		K27-2327-08	KNOB CD BUTT E 128-03932-570	P5T5	
645	3B		K27-2327-08	KNOB CD BUTT E 128-03932-570	X6M6P3	
645	3B		K27-2383-08	KNOB CD BUTT E 128-03932-577	E4M5T4	
645	3B		K27-2383-08	KNOB CD BUTT E 128-03932-577	E7X5X3	
645	3B		K27-2383-08	KNOB CD BUTT E 128-03932-577	M3	
A			N09-3363-08	SCREW 2X10 BLACK144-62010-112		
B			N09-3362-08	SCREW 2X5 BLACK144-52005-112		
655	1A		W01-0924-05	HEADHPNE	P5P3	
655	1A		W01-0924-05	HEADHPNE	P6K5K6	
656	1A		W01-0923-05	INNER H/P(SHRT) 053-21519-101	X5M5	
656	1A		W01-0925-05	INNER H/P(LONG) 053-21519-301	E3E4E5	
656	1A		W01-0925-05	INNER H/P(LONG) 053-21519-301	E7X6M6	
656	1A		W01-0925-05	INNER H/P(LONG) 053-21519-301	M3	
656	1A		W01-0925-05	INNER H/P(LONG) 053-21519-301	T5T4X3	
659	1A		W08-0658-08	AC-DC ADAPTOR 059-96184-202	E3E4E5	
659	1A		W08-0658-08	AC-DC ADAPTOR 059-96184-202	E7	
659	1A		W08-0658-08	AC-DC ADAPTOR 059-96184-302	T5T4	
659	1A		W08-0675-08	AC-DC ADAPTOR 059-01814-602	M6M5M3	
659	1A		W08-0679-08	AC-DC ADAPTOR 059-96184-404	X5M5X3	
659	1A		W09-1251-05	AC-DC ADAPTOR	K5K6	
659	1A		W09-1251-05	AC-DC ADAPTOR	P3P5P6	
660	1A		W09-1240-05	RECHAGEABE BATT998-00000-016	T5X5M5	
661	1A		W01-0921-05	CAR BATTERY ADAPTER	M6	
661	1A		W01-0921-05	CAR BATTERY ADAPTER	P6K6X6	
662	1A		W01-0922-05	CAR CASSETTE ADAPTER(CAC-3)	M6	
662	1A		W01-0922-05	CAR CASSETTE ADAPTER(CAC-3)	P6K6X6	
ELECTRONICS PARTS						
LC101			B38-0171-08	LCD DISPLAY 049-72671-001		
C1			CE04CW0J101M	ELECTRO 100UF 6.3WV		
C2A_3A			CK73FB1E104K	CHIP C 0.10UF K		
C5A			CK73FB1H105Z	CHIP C 1.0UF Z		
C6A			CK73FB1E104K	CHIP C 0.10UF K		
C8			CE04CW1H4R7M	ELECTRO 4.7UF 50WV		
C9			CE04CW1C220M	ELECTRO 22UF 16WV		
C11A			CK73FB1E223K	CHIP C 0.022UF K		
C103A,104A			CK73FB1E223K	CHIP C 0.022UF K		
C106A			CC73FSL1H470J	CHIP C 47PF J		
C107A			CC73FSL1H020C	CHIP C 2.0PF C		
C111A			CK73FB1E104K	CHIP C 0.10UF K		
C112A			CK73FB1E223K	CHIP C 0.022UF K		
C113A,114A			CK73FB1E273K	CHIP C 0.027UF K		
C115A			CC73FSL1H151J	CHIP C 150PF J		
C116A			CK73FB1H471K	CHIP C 470PF K		
C117			CE04CW0J101M	ELECTRO 100UF 6.3WV		
C118A			CK73FB1H105Z	CHIP C 1.0UF Z		
C120A			CK73FB1H105Z	CHIP C 1.0UF Z		
C121A-124A			CK73FB1E104K	CHIP C 0.10UF K		
C125A			CK73FB1H105Z	CHIP C 1.0UF Z		
C126			CE04CW0J101M	ELECTRO 100UF 6.3WV		
C127			CE04CW1A470M	ELECTRO 47UF 10WV		
C128A			CK73FB1H105Z	CHIP C 1.0UF Z		

L : Scandinavia K : USA P : Canada R : Mexico C : China I : Malaysia
Y : PX(Far East,Hawaii) T : England E : Europe G : Germany V : China(Shanghai)
Y : AAFES(Europe) X : Australia Q : Russia H : Korea M : Other Areas Δ indicates safety critical components.

* New Parts
Parts without **Parts No.** are not supplied.
Les articles non mentionnés dans le **Parts No.** ne sont pas fournis.
Teile ohne **Parts No.** werden nicht geliefert.

4

Ref. No	Address	New Parts	Parts No.	Description	Destination	Remarks
C130			CC45FSL1H470J	CERAMIC 47PF J		
C131			CK45FB1H103Z	CERAMIC 0.010UF Z		
C132			CK45FB1C104K	CERAMIC 0.10UF K		
C133			CE04CW0J101M	ELECTRO 100UF 6.3WV		
C134			CC45FSL1H391J	CERAMIC 390PF J		
C135			CK45FB1C104K	CERAMIC 0.10UF K		
C136			CE04CW1H4R7M	ELECTRO 4.7UF 50WV		
C137A			CK73FB1E104K	CHIP C 0.10UF K		
C138			CE04CW0J101M	ELECTRO 100UF 6.3WV		
C139			CE04CW1C220M	ELECTRO 22UF 16WV		
C140			CK45FB1H223Z	CERAMIC 0.022UF Z		
C144,145			CE04CW0J221M	ELECTRO 220UF 6.3WV		
C146			CK45FB1H103Z	CERAMIC 0.010UF Z		
C147A			CK73FB1H105Z	CHIP C 1.0UF Z		
C148			CC45FSL1H470J	CERAMIC 47PF J		
C150			CE04CW1C101M	ELECTRO 100UF 16WV		
C152			CE04CW1A470M	ELECTRO 47UF 10WV		
C161A			CK73FB1H102K	CHIP C 1000PF K		
C162A			CK73FB1H105Z	CHIP C 1.0UF Z		
C163A			CK73FB1E223K	CHIP C 0.022UF K		
C164A			CK73FB1H224Z	CHIP C 0.22UF Z		
C166A			CE04CW0J221M	ELECTRO 220UF 6.3WV		
C167A			CC73FSL1H200J	CHIP C 20PF J		
C168A			CC73FSL1H390J	CHIP C 39PF J		
C169A			CK73FB1H105Z	CHIP C 1.0UF Z		
C171			CE04CW0J101M	ELECTRO 100UF 6.3WV		
C172A			CK73FB1H105Z	CHIP C 1.0UF Z		
C177A			CK73FB1H105Z	CHIP C 1.0UF Z		
C180A			CK73FB1H105Z	CHIP C 1.0UF Z		
C182A			CK73FB1H105Z	CHIP C 1.0UF Z	56	
C183A			CK73FB1H102K	CHIP C 1000PF K		
C184			CE04CW1A471M	ELECTRO 470UF 10WV		
C185			CE04CW1A470M	ELECTRO 47UF 10WV	56	
C201A			CK73FB1H272K	CHIP C 2700PF K		
C202			CK45FB1H301J	CERAMIC 300PF J		
C203,204			CE04CW1H4R7M	ELECTRO 4.7UF 50WV		
C205A			CK73FB1E223K	CHIP C 0.022UF K		
C206			CE04CW0J221M	ELECTRO 220UF 6.3WV		
C207A			CK73FB1H224Z	CHIP C 0.22UF Z		
C220			CE04CW1A470M	ELECTRO 47UF 10WV		
C221			CK45FB1H102K	CERAMIC 1000PF K		
C301A			CK73FB1H272K	CHIP C 2700PF K		
C302			CK45FB1H301J	CERAMIC 300PF J		
C303,304			CE04CW1H4R7M	ELECTRO 4.7UF 50WV		
C305A			CK73FB1E223K	CHIP C 0.022UF K		
C306			CE04CW0J221M	ELECTRO 220UF 6.3WV		
C307A			CK73FB1H224Z	CHIP C 0.22UF Z		
C320			CE04CW1A470M	ELECTRO 47UF 10WV		
C321			CK45FB1H102K	CERAMIC 1000PF K		
C501			CE04CW1C220M	ELECTRO 22UF 16WV		
C502A			CK73FB1H105Z	CHIP C 1.0UF Z		
BT1			E35-1994-08	2P J.WIRE(ORANGE/BLUE)		
CN4			E60-0005-08	FILM CNNCTR,15P,025-50015-101		
J101	2B		E03-0356-08	DC JACK 021-34505-100		

L : Scandinavia K : USA P : Canada R : Mexico C : China I : Malaysia
Y : PX(Far East,Hawaii) T : England E : Europe G : Germany V : China(Shanghai)
Y : AAFES(Europe) X : Australia Q : Russia H : Korea M : Other Areas Δ indicates safety critical components.

PARTS LIST

DPC-X301/X507/X602

* New Parts
 Parts without **Parts No.** are not supplied.
 Les articles non mentionnés dans le **Parts No.** ne sont pas fournis.
 Teile ohne **Parts No.** werden nicht geliefert.

5

Ref. No	Add-ress	New Parts	Parts No.	Description	Desti-nation	Re-marks
J102	2B		E11-0372-08	PHONE JACK 021-23605-103	M5X5	
J103	2B		E11-0355-08	PHONE JACK 021-22603-101		
J105	2B		E11-0354-08	LINE OUT(PHONE) 021-23605-102		
L101			L33-0587-08	CHOKO COIL 2.2,015-00022-007		
L102			L33-0564-08	CHOKO COIL 33, 015-00330-001		
L103			L33-0587-08	CHOKO COIL		
L105			L33-0564-08	CHOKO COIL		
L106			L33-0565-08	CHOKO COIL 95 015-00950-001		
X1			L77-2240-08	CRYSTAL RESONAT052-16934-003		
JP11A			RK73FB2A000J	CHIP R 0.0 J 1/10W	56 M5X5	
JP13A			RK73FB2A000J	CHIP R 0.0 J 1/10W		
JP15A			RK73FB2A000J	CHIP R 0.0 J 1/10W		
R1A -3A			RK73FB2A103J	CHIP R 10K J 1/10W		
R7A ,8A			RK73FB2A473J	CHIP R 47K J 1/10W		
R21A			RK73FB2A102J	CHIP R 1.0K J 1/10W		
R22A			RK73FB2A472J	CHIP R 4.7K J 1/10W		
R23A			RK73FB2A563J	CHIP R 56K J 1/10W		
R29A			RK73FB2A682J	CHIP R 6.8K J 1/10W		
R30A			RK73FB2A331J	CHIP R 330 J 1/10W		
R31A			RK73FB2A122J	CHIP R 1.2K J 1/10W		
R32A			RK73FB2A152J	CHIP R 1.5K J 1/10W		
R33A			RK73FB2A182J	CHIP R 1.8K J 1/10W		
R34A			RK73FB2A242J	CHIP R 2.4K J 1/10W		
R35A			RK73FB2A362J	CHIP R 3.6K J 1/10W		
R38A			RK73FB2A101J	CHIP R 100 J 1/10W	M5X5	
R40A			RK73FB2A100J	CHIP R 10 J 1/10W		
R41A,42A			RK73FB2A472J	CHIP R 4.7K J 1/10W		
R43A			RK73FB2A103J	CHIP R 10K J 1/10W		
R46A,47A			RK73FB2A100J	CHIP R 10 J 1/10W		
R48A			RK73FB2A472J	CHIP R 4.7K J 1/10W		
R49A			RK73FB2A100J	CHIP R 10 J 1/10W		
R54A			RK73FB2A223J	CHIP R 22K J 1/10W		
R55A			RK73FB2A103J	CHIP R 10K J 1/10W		
R56A			RK73FB2A223J	CHIP R 22K J 1/10W		
R57A			RK73FB2A153J	CHIP R 15K J 1/10W		
R58A			RK73FB2A103J	CHIP R 10K J 1/10W		
R59A			RK73FB2A333J	CHIP R 33K J 1/10W		
R60A			RK73FB2A152J	CHIP R 1.5K J 1/10W		
R61A			RK73FB2A333J	CHIP R 33K J 1/10W		
R66A,67A			RK73FB2A103J	CHIP R 10K J 1/10W	M5X5 M5X5	
R69A			RK73FB2A104J	CHIP R 100K J 1/10W		
R74A			RK73FB2A682J	CHIP R 6.8K J 1/10W		
R75A			RK73FB2A103J	CHIP R 10K J 1/10W		
R76A			RK73FB2A333J	CHIP R 3.3K J 1/10W		
R99A,100A			RK73FB2A103J	CHIP R 10K J 1/10W		
R109A			RK73FB2A124J	CHIP R 120K J 1/10W		
R110A			RK73FB2A333J	CHIP R 33K J 1/10W		
R111A			RK73FB2A104J	CHIP R 100K J 1/10W		
R112A			RK73FB2A154J	CHIP R 150K J 1/10W		
R113A			RK73FB2A472J	CHIP R 4.7K J 1/10W		
R114A			RK73FB2A682J	CHIP R 6.8K J 1/10W		
R115A			RK73FB2A332J	CHIP R 3.3K J 1/10W		
R116A			RK73FB2A153J	CHIP R 15K J 1/10W		
R119A			RK73FB2A470J	CHIP R 47 J 1/10W		

L : Scandinavia K : USA P : Canada R : Mexico C : China I : Malaysia
 Y : PX(Far East,Hawaii) T : England E : Europe G : Germany V : China(Shanghai)
 Y : AAFES(Europe) X : Australia Q : Russia H : Korea M : Other Areas Δ indicates safety critical components .

PARTS LIST

* New Parts
 Parts without **Parts No.** are not supplied.
 Les articles non mentionnés dans le **Parts No.** ne sont pas fournis.
 Teile ohne **Parts No.** werden nicht geliefert.

6

Ref. No	Add-ress	New Parts	Parts No.	Description	Desti-nation	Re-marks
R121A			RK73FB2A000J	CHIP R 0.0 J 1/10W		
R122A			RK73FB2A223J	CHIP R 22K J 1/10W		
R123A			RK73FB2A472J	CHIP R 4.7K J 1/10W		
R124A			RK73FB2A223J	CHIP R 22K J 1/10W		
R125A			RK73FB2A203J	CHIP R 20K J 1/10W		
R134A			RK73FB2A101J	CHIP R 100 J 1/10W		
R136A			RK73FB2A4R7J	CHIP R 4.7 J 1/10W		
R137A			RK73FB2A152J	CHIP R 1.5K J 1/10W		
R138A			RK73FB2A100J	CHIP R 10 J 1/10W		
R140A			RK73FB2A474J	CHIP R 470K J 1/10W		
R141A			RK73FB2A222J	CHIP R 2.2K J 1/10W		
R142A			RK73FB2A683J	CHIP R 68K J 1/10W		
R166A			RK73FB2A102J	CHIP R 1.0K J 1/10W		
R167A			RK73FB2A333J	CHIP R 33K J 1/10W		
R168A			RK73FB2A103J	CHIP R 10K J 1/10W		
R169A			RK73FB2A333J	CHIP R 33K J 1/10W		
R170A			RK73FB2A562J	CHIP R 5.6K J 1/10W		
R171A			RK73FB2A104J	CHIP R 100K J 1/10W		
R172A,173A			RK73FB2A000J	CHIP R 0.0 J 1/10W		
R174A			RK73FB2A682J	CHIP R 6.8K J 1/10W		
R175A			RK73FB2A122J	CHIP R 1.2K J 1/10W		
R177A			RK73FB2A683J	CHIP R 68K J 1/10W		
R178A			RK73FB2A184J	CHIP R 180K J 1/10W		
R179A			RK73FB2A821J	CHIP R 820 J 1/10W		
R180A			RK73FB2A473J	CHIP R 47K J 1/10W		
R182A			RK73FB2A222J	CHIP R 2.2K J 1/10W	56	
R183A			RK73FB2A470J	CHIP R 47 J 1/10W		
R184A			RK73FB2A473J	CHIP R 47K J 1/10W		
R189A			RK73FB2A103J	CHIP R 10K J 1/10W		
R201A			RK73FB2A102J	CHIP R 1.0K J 1/10W		
R202A			RK73FB2A473J	CHIP R 47K J 1/10W		
R203A			RK73FB2A104J	CHIP R 100K J 1/10W		
R204A			RK73FB2A471J	CHIP R 470 J 1/10W		
R206A			RK73FB2A153J	CHIP R 15K J 1/10W		
R207A			RK73FB2A564J	CHIP R 560K J 1/10W		
R209A			RK73FB2A100J	CHIP R 10 J 1/10W		
R210A			RK73FB2A101J	CHIP R 100 J 1/10W		
R211A			RK73FB2A681J	CHIP R 680 J 1/10W		
R220A			RK73FB2A302J	CHIP R 3.0K J 1/10W		
R221A			RK73FB2A471J	CHIP R 470 J 1/10W		
R222A			RK73FB2A472J	CHIP R 4.7K J 1/10W		
R301A			RK73FB2A102J	CHIP R 1.0K J 1/10W		
R302A			RK73FB2A473J	CHIP R 47K J 1/10W		
R303A			RK73FB2A104J	CHIP R 100K J 1/10W		
R304A			RK73FB2A471J	CHIP R 470 J 1/10W		
R306A			RK73FB2A153J	CHIP R 15K J 1/10W		
R307A			RK73FB2A564J	CHIP R 560K J 1/10W		
R309A			RK73FB2A100J	CHIP R 10 J 1/10W		
R310A			RK73FB2A101J	CHIP R 100 J 1/10W		
R311A			RK73FB2A681J	CHIP R 680 J 1/10W		
R320A			RK73FB2A302J	CHIP R 3.0K J 1/10W		
R321A			RK73FB2A471J	CHIP R 470 J 1/10W		
R322A			RK73FB2A472J	CHIP R 4.7K J 1/10W		
R501A			RK73FB2A333J	CHIP R 33K J 1/10W		
R502A			RK73FB2A104J	CHIP R 100K J 1/10W		

L : Scandinavia K : USA P : Canada R : Mexico C : China I : Malaysia
 Y : PX(Far East,Hawaii) T : England E : Europe G : Germany V : China(Shanghai)
 Y : AAFES(Europe) X : Australia Q : Russia H : Korea M : Other Areas Δ indicates safety critical components .

HOW TO READ THE PARTS LIST

Destination column has the abbreviation for sale country and model.

Alphabets mean the country. Numerals do the model.

Example: T3 shows DPC-X301 for U.K. market.

"T" does all models for England. "3" does DPC-X301.

ABBREVIATION OF MODEL AND MASS PRODUCTION'S DESTNATIONS

MODEL	CNT	Australia	Canada	China	England	Europe	Germany	Korea	Malaysia
ABB.	X	P	C	T	E	G	H	I	
DPC-X301	3	-	P3	-	-	E3	-	-	-
DPC-X301(BL)	3	-	-	-	T4	E4	-	-	-
DPC-X301(W)	3	X3	-	-	-	-	-	-	-
DPC-507	5	-	P5	-	T5	E5	-	-	-
DPC-507(BL)	5	X5	-	-	-	E7	-	-	-
DPC-X507(L)	5	-	-	-	-	-	-	-	-
DPC-X507(W)	5	-	-	-	-	-	-	-	-
DPC-X602	6	X6	P6	-	-	-	-	-	-
MODEL	CNT	Mexico	PX/AAFES	Russia	Scandinavia	Shanghai	USA	Other area	Other area(M2)
ABB.	R	Y	R	L	V	K	M	M2	
DPC-X301	3	-	-	-	-	-	-	-	-
DPC-X301(BL)	3	-	-	-	-	-	-	-	-
DPC-X301(W)	3	-	-	-	-	-	M3	-	-
DPC-507	5	-	-	-	-	-	K5	-	-
DPC-507(BL)	5	-	-	-	-	-	-	M5	-
DPC-X507(L)	5	-	-	-	-	-	-	-	-
DPC-X507(W)	5	-	-	-	-	-	-	-	-
DPC-X602	6	-	-	-	-	-	K6	M6	-

(BL): BLACK, (W): WHITE, (L): BLUE

* New Parts

Parts without Parts No. are not supplied.

Les articles non mentionnes dans le Parts No. ne sont pas fournis.

Teile ohne Parts No. werden nicht geliefert.

7

Ref. No	Add-ress	New Parts	Parts No.	Description	Desti-nation	Re-marks
R504A			RK73FB2A184J	CHIP R 180K J 1/10W	56	
R505A			RK73FB2A472J	CHIP R 4.7K J 1/10W	56	
R506A			RK73FB2A103J	CHIP R 10K J 1/10W	56	
VR101			R31-0086-08	VARIABLE RESIST 010-20503-168		
SW101-103			S70-0066-08	TACT SWITCH 020-31100-160		
SW104			S70-0062-08	TACT SWITCH 020-31100-159		
SW105			S70-0066-08	TACT SWITCH 020-31100-160		
SW106			S70-0062-08	TACT SWITCH		
SW107			S62-0081-08	SLIDE SWITCH 020-21203-147		
SW108			S62-0085-08	SLIDE SWITCH	56	
SW109			S74-0084-08	MICRO SWITCH 020-31100-054		
D104			SB10-03A3-BT	DIODE		
D105			GMB01-BT	DIODE		
D111,112			IN-4001	DIODE		
D115,116			GMB01-BT	DIODE	M5X5	
D117			GMB01-BT	DIODE		
D118A			1SS355	DIODE	M5X5	
D122A			1SS355	DIODE		
D201			GMB01-BT	DIODE		
D301			GMB01-BT	DIODE		
IC1			AN8838SB	IC(CD DIGITAL SERVO)		
IC2			AN8789FB	IC		
IC3		*	MN101C16ATA2	IC	E4E5E7	
IC3		*	MN101C16ATA2	IC	K5K6	
IC3		*	MN101C16ATA2	IC	M5M6	
IC3		*	MN101C16ATA2	IC	P6T3T4	
IC3		*	MN101C16ATA2	IC	X5X6P5	
IC3			MN101C16ATA3	IC	X3M3P3	
IC4			MN662746RPK1	IC		
IC5		*	SM5903AF	IC(SHOCK PROOF)	56	
IC6			MN41V17400CTT6	IC	56	
IC9			NJM2073M	IC(AF POWER AMP)		
Q4			2SC3330	TRANSISTOR		
Q5			2SA1317	TRANSISTOR		
Q6			2SC3330	TRANSISTOR		
Q102			2SB598F	TRANSISTOR		
Q104			2SA1317	TRANSISTOR	56	
Q105			2SC4048-AC	TRANSISTOR		
Q106			2SC4481T	TRANSISTOR		
Q107			2SD734F	TRANSISTOR		
Q108			2SD1805F	TRANSISTOR		
Q108			2SD1805G	TRANSISTOR		
Q110			2SA1317	TRANSISTOR		
Q111,112			2SB926T	TRANSISTOR	M5X5	
Q113			2SA1317	TRANSISTOR		
Q115			2SC4048-AC	TRANSISTOR		
Q116			2SA1564-AC	TRANSISTOR	56	
Q201			2SC3330	TRANSISTOR		
Q202			2SD734F	TRANSISTOR		
Q203			2SC3860	TRANSISTOR		
Q205			2SC3860	TRANSISTOR		
Q301			2SC3330	TRANSISTOR		
Q302			2SD734F	TRANSISTOR		
Q303			2SC3860	TRANSISTOR		
Q305			2SC3860	TRANSISTOR		

L : Scandinavia

K : USA

P : Canada

R : Mexico

C : China

I : Malaysia

Y : PX(Far East,Hawaii)

T : England

E : Europe

G : Germany

V : China(Shanghai)

Y : AAFES(Europe)

X : Australia

Q : Russia

H : Korea

M : Other Areas

△ indicates safety critical components.

PARTS LIST

DPC-X301/X507/X602

DPC-X301/X507/X602

Note:

Component and circuit are subject to modification to insure best operation under differing local conditions. This manual is based on Europe (E) standard, and provides information on regional circuit modification through use of alternate schematic diagrams, and information on regional component variations through use of parts list.

KENWOOD CORPORATION

14-6, Dogenzaka 1-chome, Shibuya-ku, Tokyo, 150-8501 Japan

KENWOOD SERVICE CORPORATION

P.O. BOX 22745, 2201 East Dominguez St., Long Beach, CA 90801-5745, U.S.A.

KENWOOD ELECTRONICS CANADA INC.

6070 Kestrel Road, Mississauga, Ontario, Canada L5T 1S8

KENWOOD ELECTRONICS LATIN AMERICA S.A.

P.O. BOX 55-2791, Piso 6 plaza Chase, Cl. 47 y Aquilino de la Guardia Panama, Republic de Panama

KENWOOD ELECTRONICS BRASIL LTDA.

Av. Moema, 170-17, Andar-Cobertura "B", Ed. Maximum Service Center, 04077-020 Moema, São Paulo-SP-Brasil

KENWOOD ELECTRONICS U.K. LIMITED

KENWOOD House, Dwight Road, Watford, Herts., WD1 8EB., United Kingdom

KENWOOD ELECTRONICS BELGIUM N.V.

Meachelsesteenweg 418, B-1930 Zaventem, Belgium

KENWOOD ELECTRONICS DEUTSCHLAND GMBH

Rembrücker Str. 15, 63150 Heusenstamm, Germany

KENWOOD ELECTRONICS FRANCE S.A.

13 Boulevard Ney, 75018 Paris, France

KENWOOD ELECTRONICS ITALIA S.p.A.

Via G. Sirtori, 7/9 20129, Milano, Italy

KENWOOD IBÉRICA S.A.

Bolivia, 239-08020 Barcelona, Spain

KENWOOD ELECTRONICS AUSTRALIA PTY. LTD.

(A.C.N. 001 499 074)

16 Giffnock Avenue, North Ryde, N.S.W. 2113, Australia

KENWOOD ELECTRONICS (HONG KONG) LTD.

Unit 3712-3724, Level 37, Tower 1, Metroplaza, 223 Hing Fong Road, Kwai Fong N.T., Hong Kong

KENWOOD ELECTRONICS GULF FZE

P.O.Box 61318, Jebel Ali, Dubai, U.A.E.

KENWOOD ELECTRONICS SINGAPORE PTE LTD.

No. 1 Genting Lane #02-02, KENWOOD Building, Singapore, 349544

KENWOOD ELECTRONICS (MALAYSIA) SDN BHD.

#4.01 Level 4, Wisma Academy Lot 4A, Jalan 19/1 46300 Petaling Jaya Selangor Darul Ehsan Malaysia

KENWOOD ELECTRONICS (THAILAND) CO., LTD.

2019 New Pechburi Road, Bangkapi, Huaykwang, Bangkok, 10320 Thailand